

Aerosol Science and Technology: History and Reviews

Edited by David S. Ensor

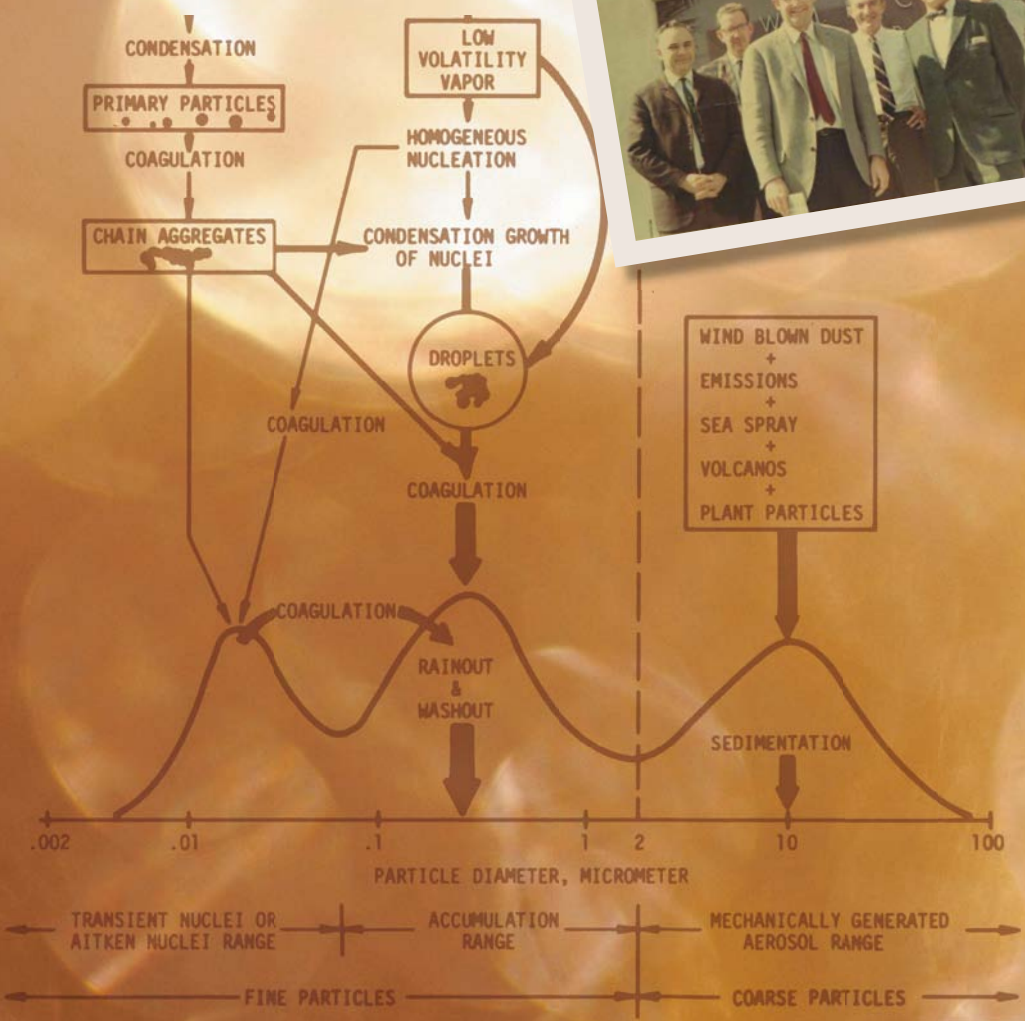

Aerosol Science and Technology: History and Reviews

Edited by David S. Ensor

RTI Press

 **RTI**
INTERNATIONAL

©2011 Research Triangle Institute. RTI International is a registered trademark and a trade name of Research Triangle Institute. The RTI logo is a registered trademark of Research Triangle Institute.



This work is distributed under the terms of a Creative Commons Attribution-NonCommercial-NoDerivatives 4.0 license (CC BY-NC-ND), a copy of which is available at <https://creativecommons.org/licenses/by-nc-nd/4.0/legalcode>.

Library of Congress Control Number: 2011936936
ISBN: 978-1-934831-01-4

<https://doi.org/10.3768/rtipress.2011.bk.0003.1109>
www.rti.org/rtipress

About the Cover

The cover depicts an important episode in aerosol history—the Pasadena experiment and ACHEX. It includes a photograph of three of the key organizers and an illustration of a major concept of atmospheric aerosol particle size distribution. The photograph is from Chapter 8, Figure 1. The front row shows Kenneth Whitby, George Hidy, Sheldon Friedlander, and Peter Mueller; the back row shows Dale Lundgren and Josef Pich. The background figure is from Chapter 9, Figure 13, illustrating the trimodal atmospheric aerosol volume size distribution. This concept has been the basis of atmospheric aerosol research and regulation since the late 1970s.

The RTI Press mission is to disseminate information about RTI research, analytic tools, and technical expertise to a national and international audience. RTI Press publications are peer-reviewed by at least two independent substantive experts and one or more Press editors.

RTI International is an independent, nonprofit research institute dedicated to improving the human condition. We combine scientific rigor and technical expertise in social and laboratory sciences, engineering, and international development to deliver solutions to the critical needs of clients worldwide.

This publication is part of the RTI Press Book series.

RTI International
3040 Cornwallis Road, PO Box 12194, Research Triangle Park, NC 27709-2194 USA
rtipress@rti.org
www.rti.org

Dedication

It is fitting to dedicate a book on history to two pioneers in the field of aerosol science who will be sorely missed.

Othmar Preining



A teacher and researcher who led the European effort in aerosol science, as summarized in a biography authored by Helmuth Horvath in Chapter 1. On the behalf of his many colleagues and friends, this book is a modest effort to preserve his memory.

Sheldon Friedlander



A leader, teacher, and researcher who led the American effort in aerosol science in a wide range of efforts, as summarized in a biography authored by George Hidy in Chapter 2. On the behalf of his many friends and colleagues in the aerosol field, this book is a small effort to preserve his memory.

Contents

Preface	vii
Acknowledgments	viii
Part I. Biographies	1
Chapter 1. Othmar Preining: An Austrian Pioneer of Modern Aerosol Research (1927–2007)	3
Helmuth Horvath	
Chapter 2. Sheldon K. Friedlander: Aerosols’ Man for All Seasons (1927–2007)	33
George M. Hidy	
Chapter 3. Uncle Sasha: Alexandr Georgievich Sutugin (1940–1988)	53
Alexey A. Lushnikov	
Chapter 4. John A. McClelland: The Scientific Work and Legacy of a Physics Pioneer (1870–1920)	71
Thomas C. O’Connor	
Part II. Research Institutions	103
Chapter 5. Exploring Inhaled Particles and Human Health at the New York University Institute of Environmental Medicine	105
Beverly S. Cohen	
Chapter 6. The Clean Air Commission of the Austrian Academy of Sciences: A Historical Sketch	123
Helmuth Horvath and Othmar Preining	
Chapter 7. Aerosol Research at the University of Minnesota Particle Technology Laboratory	143
Benjamin Y. H. Liu, Virgil A. Marple, Peter H. McMurry, Thomas H. Kuehn, and David Y. H. Pui	
Part III. The Legacy of the Pasadena Smog Experiment	241
Chapter 8. Reminiscences about Pasadena, ACHEX, and Beyond	243
George M. Hidy	
Chapter 9. Memories and Legacy of the ACHEX Mobile Semitrailer Air Pollution Laboratory	265
Gilmore J. Sem, William E. Clark, George M. Sverdrup, and Virgil A. Marple	
Chapter 10. Measurements of the Three-Dimensional Distribution and Transport of Aerosols: Precedents Set by the Three-Dimensional Pollutant Gradient Study in Cooperation with ACHEX	297
Donald L. Blumenthal	

Part IV. Military Applications and Nuclear Aerosols	315
Chapter 11. Aerosol Wars: A Short History of Defensive and Offensive Military Applications, Advances, and Challenges	317
Arthur K. Stuempfle	
Chapter 12. Chernobyl: Observations in Finland and Sweden	339
Jussi Paatero, Kaarle Hämeri, Matti Jantunen, Pertti Hari, Christer Persson, Markku Kulmala, Rolf Mattsson, Hans-Christen Hansson, and Taisto Raunemaa	
Chapter 13. The Development of FIDO (Fog Intensive Dispersal Operation)	367
Ian Colbeck	
Chapter 14. From China's Great Wall to Hollywood's Great Spy—The Story of Military Smokes and Obscurants	377
Christopher A. Noble	
Part V. Reviews	389
Chapter 15. A Brief History of Respiratory Deposition Modeling	391
Chiu-sen Wang	
Chapter 16. Atmospheric Nanoparticles: Early Metrology and Observations (1875–1980)	411
Volker A. Mohnen and George M. Hidy	
Chapter 17. History of the Flow Diffusion Chamber Development	457
Michael Anisimov	
Chapter 18. History of Manufacture of Fine Particles in High-Temperature Aerosol Reactors	475
Sotiris E. Pratsinis	
Chapter 19. History of Virtual Impactors	509
Virgil A. Marple and Bernard A. Olson	
Chapter 20. Review of Particle Size Distribution Measurements of Engine Exhaust Before 1985	529
Gilmore J. Sem, Oliver F. Bischof, and David B. Kittelson	
Chapter 21. Trends in Airborne Concentrations of Total Suspended Particles, PM₁₀, SO₂, and NO₂ in Five Chinese Cities	551
Shen Tian, Cliff I. Davidson, and H. Keith Florig	
Contributors	567

Preface

Interest in the history of aerosol science has been growing over the past two decades. The assembling of the aerosol story has been the avocation of a small number of amateur historians. Beginning in 1992, Gil Sem successfully organized sessions at the annual American Association for Aerosol Research (AAAR) meetings. Othmar Preining organized the first stand-alone symposium, which was held in Vienna, Austria, from August 31 to September 2, 1999. This successful meeting drew 75 attendees, and the proceedings, *History of Aerosol Science*, was published as a hardbound volume in 2000 (Preining & Davis, 2000).

Gil Sem organized the second symposium, which was held in Portland, Oregon, USA, on October 13 and 14, 2001. Unfortunately, international travel was being discouraged in the aftermath of the September 11 attacks, which limited the number of attendees. The second volume, *History & Reviews of Aerosol Science*, was published in 2005, with Gil Sem serving as the editor-in-chief (Sem et al., 2005).

The third symposium was held in conjunction with the International Aerosol Conference hosted by AAAR in St. Paul, Minnesota, USA, on September 8 and 9, 2006; approximately 40 researchers attended. I had the pleasure of serving as general chairman for that meeting and was supported by the AAAR home office staff and the AAAR History Working Group. This volume is the compilation of 21 chapters expanding on topics presented at the third symposium, and it covers a wide variety of topics, ranging from biographies to research reviews. During the editing process, an effort has been made to preserve the “voice” of the authors in order to provide historical context. I had the good fortune of support from my employer, RTI International, and the resources of the RTI Press in completing this volume.

David S. Ensor
Editor

References

- Preining, O., & Davis, E. J., eds. (2000). *History of Aerosol Science*. Vienna: Austrian Academy of Sciences.
- Sem, G. J., Bouland, D., Brimblecombe, P., Ensor, D. S., Gentry, J. W., Marijnissen, J. C. M., & Preining, O. (2005). *History & Reviews of Aerosol Science*. Mt. Laurel, New Jersey: American Association of Aerosol Research.

Acknowledgments

The RTI Press was launched to bring RTI International's research, analytical tools, and technical expertise to national and international attention by serving as a respected outlet for RTI studies and analysis. Aerosol science has been an active area of research at RTI since the late 1970s and is currently pursued in a number of business groups. I am grateful to the support of Dr. Kathleen Lohr, Editor-in-Chief, Dr. Diane Wagener, Deputy Editor-in-Chief, and Ms. Karen Lauterbach, Managing Editor, for their willingness to take on this project. I also thank Ms. MaryBeth Branigan, lead production editor, and the other RTI editors and staff who contributed to the production of this book. Special thanks to Dr. Victoria Franchetti Haynes, RTI president and CEO, for establishing the RTI Fellows Program that provided resources to support this book.

PART I

Biographies

Othmar Preining

An Austrian Pioneer of Modern Aerosol Research (1927–2007)

Helmuth Horvath

Othmar Preining was one of the pioneers of aerosol science in Europe. He influenced the development of aerosol research not only in Europe, but also in Japan and the United States. He was born and lived in a country that was shattered by both social unrest in the early 20th century and by World War II—times in which research money was very tight. Despite this, he managed to establish a strong aerosol research group in Vienna and to maintain contacts at the most important centers of aerosol research around the world.

Youth and School Education

Preining (Figure 1) was born on June 28, 1927, in Vienna. His father, Franz Preining, was employed by the Vienna Tramway, and the Preining family lived in Wien-Döbling. At first, they lived in the apartment of a relative. After his death, they moved in with Preining's grandmother. In 1930, the Preining family obtained their own apartment at Döblinger Gürtel 11. Preining lived very close to this location most of his life. His primary school was around the corner. Because his parents were Old Catholics, the family chose a school for Preining that offered classes in the Old Catholic religion. The school was located at Unterberggasse in the 20th district, near Augarten. Preining attended the school without any problems. Unfortunately, in 1939, he had a very severe inflammation of the throat; his tonsils were removed. This surgery caused septicemia, and



Figure 1. Othmar Preining, approximately 1985.

Photo: Courtesy of the author.

he spent 3 weeks in bed at home. Finally, Preining was transferred to the children's hospital of the Vienna general hospital, where he was one of the first patients to be treated with sulfonamides. Unfortunately, the dose was too high because doctors did not know much about this new drug in those days. As a consequence, Preining developed heart problems and had to report to the hospital twice a week.

In 1939, Preining missed 400 hours of instruction in school, but he was still a good student. His physical fitness was very poor, and in 1942, he collapsed on the way to school, was taken to the hospital by ambulance, and was diagnosed with a kidney infection with bleeding. Again, he was treated in the hospital and had to report frequently to the hospital thereafter. With so many absences from school, Preining had to repeat the 5th class (9th grade) at a school at Scheuchgasse in the 9th district of Vienna. This was 1942, and World War II was in full swing. The school was soon needed as a military hospital, and Preining was transferred to his previous school building. This building was also commandeered by the army, and Preining transferred to a school in the 3rd district.

Because of his bad health, Preining was ineligible for military service. Instead, he was taken to a village in the area of Wechsel, about 100 km southwest of Vienna. In a small hotel, he supervised young children who were evacuated from Vienna. The building was completely infested with bedbugs! At the age of 15, he was supposed to learn on his own in the morning and work with the children in the afternoon. He again suffered an infection and was sent home to Vienna. Treatment with antibiotics gave some relief, but in the fall of 1944, Preining developed general inflammation of his joints. Toward the end of the war, all men able to fight—teenagers as well as old men—were drafted into the “Volkssturm.” Preining was ordered to come to field exercises, but he could not. A military doctor came to the apartment to get him but soon realized that Preining really was unable to serve. This was fortunate because, of the 150 soldiers from the Volkssturm who were sent to Slovakia, only 3 returned.

Beginning in 1943, Vienna was bombed. People spent much of their time in basements of houses. Preining was very lucky. Of a series of bombs, the one that struck a few meters from the place where the family hid was a dud and did not explode. Fortunately, the family survived the war, but at the end of the war, society broke down and no food was available. Because they had good relations with a farmer, the Preining family had a supply of potatoes

in their cellar. Preining's uncle and aunt decided to stay with relatives in Unterretzbach, about 60 km northeast of Vienna, so the family crossed the Danube by climbing a destroyed bridge. The family, even the weakened boy, reached the destination on foot in 2 days, sleeping one night in a haystack. Their relatives were farmers and had some food reserves, so they had enough to eat. In the fall of 1945, Preining returned to Vienna and went back to school; he passed his final examinations with honors in 1946.

Preining's bad health did not allow any physical exercise; the doctors actually forbade him from participating in any kind of sport. To compensate for this, Preining developed a deep interest in mathematics and astronomy. With enthusiasm, he attended public lectures by Oswald Thomas on astronomy. As early as 1944, Preining bought an introductory book on mathematics for students of technical universities (Schrutka, 1924); later, he obtained a book on advanced spherical trigonometry. Because he was often unable to go to school because of sickness, Preining had time and energy to study his books. He completely understood the texts, and at his final examination, he impressed the committee with knowledge far beyond that of his peers. His mathematics teacher realized his gifts and strongly recommended to Preining's parents that he study mathematics.

Studies in Vienna

In 1946, Preining began studying at the University of Vienna. He started with mathematics, physics, chemistry, and astronomy. He realized that studying all of these subjects was not possible and dropped chemistry, because standing in the laboratory was too strenuous for his weakened body. For similar reasons, he also dropped astronomy. He then concentrated on mathematics and physics. He came to know physicist Felix Ehrenhaft, who impressed him very much. He attended all Ehrenhaft's lectures and the seminars that Ehrenhaft gave for the most interested students.

Ehrenhaft was a leading physicist at the University of Vienna from the beginning of the 20th century. In 1938, he escaped to the United States; he returned to Vienna in 1947 to stay until his death in 1953. Ehrenhaft started his work on the determination of the electric charge in 1907, using experiments similar to those of Robert Millikan. Unlike Millikan, who used oil droplets, Ehrenhaft used solid selenium particles, which caused additional problems. Although determining the forces on a charged particle in a

capacitor is straightforward in principle, the difficulties arise with the details. One must account for the shape factor, slip correction, Brownian motion, light pressure, motion in temperature gradients, orientation in a field and other effects, and techniques for observation of submicrometer particles. Ehrenhaft analyzed these phenomena thoroughly, and his students worked mostly on photophoresis or optical and mechanical problems of particles with diameters smaller than 1 μm . Thus, in 1950, Preining was already a specialist in what is now called “nanosize” aerosol.

Preining was accepted by Ehrenhaft as a PhD student (then the only degree available at the University of Vienna). At that time, possibilities for doing a thesis were scarce. There were usually several competitors for each place in the laboratory. Young PhD candidates had to work one semester as a “kuli” (or “coolie,” named after the hard-working Chinese railroad workers who built the transcontinental railway in North America in the 1860s). Preining started building an apparatus to determine photophoretic movement of steel particles in a magnetic field. This experimental setup included two carbon arc lamps, switchable magnetic fields, and visual observation. He bought old used telephone relays and automated the experiment as much as possible, which at that time was a considerable achievement. The apparatus was a big success; and Preining and four other students did their scientific work with this setup. For his thesis, Preining worked on magnetophotophoresis of sputtered steel particles (Preining, 1951). In July 1951, he obtained his PhD.

Postdoctoral Work in Vienna and at California Institute of Technology

Shortly before Preining submitted his doctoral thesis, the University of Vienna offered him a position. He started on January 1, 1951. Among other duties, he was responsible for the preparation and demonstration of impressive experiments in the experimental physics lectures.

In 1955, he married Ida Schneider; in 1991, they were divorced. Their son, Peter, was born in 1964. Peter graduated from the University of Mining (Montanuniversität), Leoben, Austria. He works for the Austrian oil company OMV and currently is located in Pakistan, responsible for prospecting and drilling.

For all students, graduation is a landmark, and usually young PhDs look for new ideas. Preining was a gifted experimentalist. The physics institute at the University of Vienna had a very strong connection to the electricity grid.

Preining found some leftover equipment in the basement of the institute, and when he was not preparing experiments for lectures, he conducted plasma physics experiments with a high-current-density electric arc with reduced cross-section to study very high temperatures (he reached $55,000^{\circ}$ K with an arc discharge in a rotating water annulus; Preining, 1954). The experiments were very successful, but for more systematic research, Preining needed more extensive equipment than the leftovers from previous investigations. He soon realized that this would be much too expensive in a country just recovering from a disastrous war, so he dropped the idea of plasma physics research.

It was quite natural that Preining then accepted an offer to investigate aerosols with Alexander Goetz at the California Institute of Technology (Caltech) in Pasadena (Figure 2). Goetz started his scientific career in Germany and was in Göttingen in the 1920s (for a biography of Goetz, see Pueschel, 2005). In 1927, Robert Millikan brought him to Pasadena, where Goetz became Millikan's assistant. Preining and Goetz both had knowledge in submicrometer particles, and in the 2 years (1958–1960) of his stay, Preining would do research successfully at the cutting edge of aerosol science. Preining's and Goetz's main research topic was an investigation of particles



Figure 2. Othmar Preining (left) measuring with the Goetz aerosol spectrometer (far left) in Sequoia National Park, 1958.

Photo: Courtesy of the author.

at the lower detection limit, which was then a few tenths of a micrometer. While Preining was at Caltech, the institute developed and optimized a new centrifugal aerosol spectrometer (Goetz et al., 1960). Researchers used this instrument for environmental studies involving submicrometer aerosols: particle sources, stability, photochemically produced particles, and ambient background particles, in both urban and remote areas. The particles were deposited on foils and counted by dark-field microscopy in those days, which limited particle sizing to particles larger than 50–100 nm.

Caltech was the Mecca of natural sciences, and the laboratory where Preining worked had contacts with a vast number of American and foreign research institutions. In and near Pasadena, leading scientists in both basic science and environmental research included Linus Pauling, Richard Feynman, Arie Haagen-Smit, and others. Preining enjoyed fruitful discussions with these researchers, their assistants, and their students. He gained many new ideas and stimulus for his future research. In 1960, A. T. Rossano founded the Institute of Environmental Engineering at Caltech. It was intended as a research and training center on air pollution in Los Angeles and funded by the U.S. Public Health Service. Rossano offered Preining the opportunity to lead this institute and to stay permanently in Pasadena. Preining did not accept this generous offer but instead returned to Vienna after his 2-year stay in California. He suggested Sheldon Friedlander for the position. Friedlander accepted the offer, and they formed a lifelong friendship.

“Assistent” in Vienna and Many Visits to Other Laboratories

In Vienna, Preining continued his work on ultrafine particles, obtaining the *venia docendi* in 1963. The title of the work he submitted was “Zum Problem der Eichung fraktionierender Meßgeräte für Stäube der Kongrößen zwischen 0.1 und 1 Mikron mit Hilfe von Testaerosolen” (“On the Calibration of Fractionating Sizing Instruments Using Test Aerosols of Sizes between 0.1 and 1 μm ”; Preining, 1962). He started building his own research group, and his first PhD students were Axel Berner, Helmuth Horvath, and Dieter Hochrainer. Preining’s interest in submicrometer particles brought him back to the United States many times. In 1965, he visited J. P. Lodge at the National Center for Atmospheric Research, who had one of the first Royco optical particle counters. Unfortunately, the counter did not work, so Preining investigated the particles formed during atomization and found a considerable

contribution by ultrafine particles. It took only a few weeks to detect this, but it needed almost a year of discussion with the editor of the *Journal of Colloid and Interface Science* to convince him that these ultrafine particles, although small in mass, were important. Today we know this, but then it required a lot of persistence to get the results communicated to the public.

During this visit to the United States, Professor A. T. Rossano, who then was at the University of Washington in Seattle, offered Preining the opportunity to establish an institute on environmental engineering. Preining accepted neither this offer nor an offer made by Dr. Weickmann, who established a new National Oceanic and Atmospheric Administration laboratory in Boulder, Colorado. Preining preferred to be based in Vienna and to do research and teach at the University of Vienna, educate students, and visit other laboratories and universities as frequently as possible.

Optical particle counters were an important innovation in the 1960s. Whereas size classification with the aerosol centrifuge required hours of operation counting the particles with a microscope and time-consuming data evaluation, the particle counters did the classification in real time. On the one hand, many questions remained unanswered, but on the other, new possibilities opened up with this instrument. Therefore, Preining looked for laboratories that had working particle counters. In 1966 and in 1968, he worked with Kenneth Whitby and Benjamin Y. H. Liu of the University of Minnesota Particle Technology Laboratory, who had a working particle counter that he could use to investigate ultrafine particles. In a 4-month visit to the University of Minnesota in 1968, Preining substituted for Whitby's technical thermodynamics lecture for engineers.

From 1966 to 1968, Preining also had part-time employment with the *Bundeministerium für Soziale Verwaltung* (Ministry for Social Affairs) working with the *Bundestaatlich-bakteriologisch-seriologische Untersuchungsanstalt, Abteilung für Radiologie und Lufthygiene* (Public Health Laboratories for Clinical Bacteriology and Serology, Radiology and Air Hygiene Division), an agency that was responsible, among other things, for measurements and recommendations regarding air quality. He was always very worried about a clean environment, especially air quality, and he used all occasions to support environmental activities.

Professor at the University of Vienna and Many Other Duties

On March 27, 1968, Preining was appointed associate professor, and on March 1, 1970, he was appointed full professor for experimental physics at the University of Vienna (Figure 3). He held this position until reaching the status of professor emeritus on September 30, 1995. Besides the experimental physics lecture, a 2-year, 5-hours-per-week class, he gave many special classes for interested students on subjects such as information theory, fractals, aerosols, and climate. He educated his students in basic physics, but he also urged them to search for the essential and to see the interrelations. His presentations were always up to date and very demanding. Under his guidance, about 60 students completed their master's and PhD theses, and 7 young scientists obtained habilitation (or qualification). He had high standards and expected students and coworkers to do their best. Preining's examinations were difficult, and he selected challenging topics for theses, expecting students to find solutions. Preining had a facility for solving problems, whether they were experimental, theoretical, or personal. With his immense knowledge of many fields of science, he made many helpful suggestions, always had patience, and offered encouragement.



*Figure 3.
Energetically
entering the lecture
hall of the Institute
of Experimental
Physics of the
University of
Vienna.*

Photo: Courtesy of the author.

Scientists usually do not have much love for administration. Preining was no exception, but he realized that good academic administration can be very fruitful for science and the university. He served as deputy dean (*Prädekan*, 1984–1985) and later became dean (*Dekan*, 1985–1987) of the Natural Science Faculty of the University of Vienna, and vice rector (*Prorektor*, 1987–1988) of the University of Vienna. He did these jobs with devotion. He was able to successfully solve unresolved problems. These activities were time and energy consuming, and can best be characterized by one short remark that Preining

made to me after a commission discussed a problem for the n th time: “I am feeling more like the psychiatrist of the faculty than the dean.”

As an expert in the atmospheric environment, Preining was invited to become a member of various advisory boards. In 1971, he was appointed a member of an environmental hygiene advisory committee for the Austrian Ministry for Health and Environment. He served on this board for more than 30 years and was a delegate to many government conferences. Later, he became a member of the Austrian CO₂ Commission. Preining was very active and used every occasion to convince politicians that activities to reduce CO₂ emissions were needed urgently. He was very dismayed that the CO₂ Commission was neutralized because the minister of the environment could not tolerate any more warnings from the commission regarding increased CO₂ emissions and the need for political action.

Preining’s duties at the University of Vienna included, among other things, a 2-year advanced course in physics. This course was taught by three professors, so after 2 years, there was again time for longer visits to other universities or research institutions. Despite his teaching obligations at the places he visited and the short time he had available, Preining always managed to do research in the new environment and to publish papers on new aspects of aerosol research (e.g., Preining, 1967, 1983a; Preining et al., 1967, 1976; Boscoe et al., 1973; Matteson et al., 1972, 1973, 1974). In the academic year 1971–1972, Preining was the National Science Foundation guest professor for a full year at the Georgia Institute of Technology in Atlanta, working with Clyde Orr. Preining then returned to his duties in Vienna. For one quarter in 1975, he was with the Atmospheric Sciences Department of the University of Rolla, Missouri. Part of this time he spent participating in field experiments in the Gulf of Mexico (Figure 4). He remembered this experience because it was very hot. In 1981, he spent half a year with the Atmospheric Science Department at the State University of New York at Albany. As a consequence of Preining’s visits abroad, many scientists stopped in Vienna to present seminars or to participate in joint experiments. This helped to keep the standard of aerosol research in Vienna at a high level.

In 1979, the American Chemical Society invited Preining to participate in its joint meeting with the Japanese Chemical Society in Hawaii; this invitation had considerable consequences for the development of aerosol research in Japan. Preining met Professor Koichi Iinoya, the Japanese pioneer in aerosol science. Iinoya arranged for Preining and Sheldon Friedlander to make a



Figure 4. Field measurements in the Gulf of Mexico, Padre Island, June 1975.

Photo: Courtesy of the author.

scientific visit to Japan. The time schedule was very tight. Within 2 months, Preining visited eight different universities and research institutions, gave innumerable lectures on all aspects of aerosol science, visited laboratories, and had long discussions about what could be done to promote aerosol research. Success was evident. Many groups initiated research on aerosol topics, and today, aerosol research is a well-established science in Japan. The contacts with Japanese scientists that Preining established still exist today. Japanese scientists and students continue to come to Vienna for discussion and scientific work, and their Austrian counterparts visit Japan.

Preining was not only active abroad; he also established the Vienna School of Aerosol Physics. The strength of this group is its combination of excellent experimental skills and sound theoretical foundation, as Preining showed by example. His guidance was gentle and cautious and one of the secrets of the school's success. He demanded that his coworkers spend time abroad, a condition without which no permanent position could be gained on his team, and he inspired them to excel in their respective specialties to become established scientists in their own right. Seven of his coworkers obtained their habilitation at the University of Vienna.

Preining was elected as a corresponding member of the Austrian Academy of Sciences in 1983 and as a full member in 1990. Beginning in 1969, he was a member of the Clean Air Commission of the Austrian Academy of Sciences. From 1990 to 2002, he was the chair of the Clean Air Commission

(see Chapter 6 of this volume for a historical sketch of the commission), which he guided with his expertise. During his chairmanship, the commission established and improved many air-quality criteria.

Professor Emeritus, 1995 to 2007

Preining's official retirement from the University of Vienna did not change any of his activities, except that he no longer had teaching obligations. Whereas many other academics use this time to look back on a successful life and write memoirs, Preining remained very active in many organizations, especially as a life member of the Austrian Academy of Sciences.

As chair of the Clean Air Commission, Preining concentrated on one of the most important newer aspects in aerosol research, namely the biological effects of aerosol particles. He was able to motivate a multidisciplinary group consisting of physicists, chemists, medical doctors, biologists, public health officers, hygienists, city administrators, and researchers with the Austrian Environmental Protection Agency to cooperate in the Austrian Project of Health Effects of Particulates (AUPHEP) of the Austrian Academy of Sciences (Hauck et al., 2004a).

Preining also became a member of the *Kommission für Geschichte der Naturwissenschaften, Mathematik und Medizin* (Commission for the History of Natural Sciences, Mathematics, and Medicine) in 1996 and chaired it from 1998 to 2002. Many interesting public lectures and symposia have been organized under his guidance. He organized the first Symposium on the History of Aerosol Science in Vienna (August 31–September 2, 1999; see also Preining & Davis, 2000). This conference was the start of a series on the history of aerosol science (subsequent symposia were held in Portland, Oregon, in 2001, in St. Paul, Minnesota, in 2006, and in Helsinki, Finland, in 2010).

As a representative of the Austrian Academy of Sciences at the European Council of Applied Sciences and Engineering (Euro-CASE), Preining attended many meetings and worked hard to integrate the technical sciences in the European Academies of Sciences. He gave many invited lectures at large conferences or for learned societies. His presentations were always up to date and never without surprises (see, e.g., Preining, 1998, 2000).

The serious health problems that Preining had as a young boy stayed with him all his life, but he was always able to cope with his problems. He did the most he could and usually hid his problems. In 1994, he had serious heart

surgery with three bypasses. He quickly learned to live with the new situation and usually others did not notice his condition. In January 2006, he developed severe kidney problems, resulting in several surgeries. From this time on, he had to stay within a 2-hour radius of the Vienna University Hospital in case of inflammations or other problems. This limited Preining's activities to Vienna and its vicinity, but he remained fully active. Instead of traveling to other places, Preining invited scientists for lectures and discussions in Vienna and organized minisymposia. Beginning around 2000, Preining also fought cancer. Several times he received the maximum permissible dose of X-rays. When absolutely no more irradiation with X-rays was possible, the doctors switched to chemotherapy. Preining scheduled the treatments such that they were after important meetings, lectures, or other events so he could participate with full energy. He had to spend considerable time in the hospital. To optimize his stays, he always took scientific journals with him and read them whenever possible. He reported his newest knowledge to his visitors, and it always was a challenge to discuss scientific or societal or ethical viewpoints with him. Around the middle of September 2007, Preining stumbled while emptying the wastebasket from his apartment into the garbage container in the courtyard, and he hurt his head seriously. He was immediately hospitalized, but the necessary routine treatments could not be done. He did not recover and died on September 26, 2007, in Vienna.

The Austrian Academy of Sciences and the Clean Air Commission of the Austrian Academy of Sciences

The Austrian Academy of Sciences is an independent learned society. It contributes decisively to ensure highly competitive Austrian research and advises decision makers in politics, business, and society on science-related issues, while informing the interested public about major scientific discoveries. Members support this process by making their broad range of expertise available for the academy's activities. Persons with significant scientific reputations are elected as members. This is considered an important honor. As mentioned earlier, Preining was elected as a corresponding member of the Austrian Academy of Sciences in 1983 and as a full member in 1990. He was a very active member of the academy and attended all meetings, even when he was seriously ill. He represented the academy in international organizations and chaired the Clean Air Commission and the Commission for the History of Natural Sciences, Mathematics, and Medicine.

The Austrian Academy of Sciences founded the Clean Air Commission in 1963 (see also Chapter 6, on the commission, in this volume). Its chief aim is to supply up-to-date scientific knowledge about how to achieve a clean environment. Preining joined the commission in 1969. As an independent organization, the commission was frequently asked by the federal or provincial governments for advice about air pollution or possible consequences of political decisions (e.g., location and operation of power plants). The commission elaborated air-quality criteria for various pollutants. With Preining's active participation, the air-quality criteria for SO₂ and NO_x were produced in 1975 and 1987. With Preining as deputy chair (*Stellvertreter*, 1986–1990) and chair (*Obmann*, 1990–2002), the commission published the air-quality criteria for photo-oxidants (ozone, 1989), volatile organic compounds (1996), and an update of nitrogen oxides in the atmosphere (1998). Furthermore, the commission published volumes on *Consequences of Climate Change for Austria* (1992); *The Scientific Basis for a National Plan for Environmental Protection with Respect to Climate, Air, Odor, Noise* (1993); and *Guidelines for Rating Indoor Air Quality* (2002). All these works contained up-to-date collections of scientific knowledge and recommendations on actions and limitations that were the basis for decisions made by politicians and administrators.

Preining thoroughly investigated the scientific literature for various air pollutants when elaborating air-quality criteria, and he found a need for research about the health effects of particles in the atmosphere. So he started his most ambitious project, AUPHEP. Using his well-established contacts with all agencies in Austria concerned about air pollution, and with the help of his careful diplomacy, Preining helped to start a joint project in 1998. All agencies contributed instruments, data, financing, and so forth. The main financing came from the ministry responsible for the environment. It was the aim of the project to investigate experimentally the health effects of particulate pollution. The pollution was characterized by separately sampling all size fractions of aerosols, including ultrafine particles. The samples were analyzed chemically for major inorganic components and for a large number of organic compounds. Furthermore, the essential gas components were analyzed continuously. One rural site and three city sites were selected; at each site, the sampling was performed for 1 year. This study characterized the local atmospheric aerosol at several locations using the latest technologies, while simultaneously investigating the health and lung function in cohorts

of school and kindergarten children. The large quantity of data permitted the medical group to study the effect on preschool children, as well as schoolchildren and the elderly. The project was operational from 1998 until 2003. Many publications have appeared based on the project. The final report was published in 2004 (Preining & Hauck, 2004; Hauck et al., 2004a). The outcomes of this study are surprising and will have far-reaching consequences in legislation and public thinking.

The academy requires the chair to resign when he or she reaches the age of 75, but Preining remained a very active member of the commission and organized symposia, public lectures, and other activities. He always planned a long time ahead: Günther Oberdörster gave a public lecture on “Ultrafine Nano-Particles: Wolves in Sheep’s Clothing?” on November 12, 2007, 6 weeks after Preining’s death, although Preining had planned and completely organized the lecture half a year ahead.

Preining’s Scientific Work

Preining’s scientific work had many facets. He was active in many fields of physics. Besides aerosol science, he worked and published on plasma physics (Preining, 1954), health physics (Zweymüller & Preining, 1969a, 1969b), demonstration experiments (Preining, 1957, 1958a, 1958b, 1958c, 1958d, 1963), nuclear fallout (Ernst et al., 1962a, 1962b; Sedlacek et al., 1963; Preining et al., 1963), entropy and information (Preining, 1965, 1968, 1972), gaseous pollutants (Preining et al., 1969), pollution and economics (Preining, 1974, 2003), fractals (Preining, 1980, 1988, 1990a), and science history (Preining, 1983b, 1986, 2001). He had broad interests in all fields of science and devoted much of his time to investigating the literature on subjects unrelated to aerosol science. This broad knowledge enabled him to immediately see connections to aerosol science, and this ability allowed him to advance far ahead of other researchers. He must have been very proud of this. Whenever he submitted a curriculum vitae with selected publications, he always included the papers that were forerunners.

In the first years of his scientific career, Preining worked on photophoresis. He did his investigations with great care and in full depth. Thus he became a recognized expert in this field and contributed a chapter on photophoresis in the pioneering book *Aerosol Science*, edited by C. N. Davies (Preining, 1966). With similar enthusiasm and great dedication, Preining did the demonstration experiments for physics lectures and, in many cases, developed new methods

and techniques for impressive experiments. A representative example of this is a method that Preining developed to demonstrate anomalous dispersion (Preining, 1958d).

During his 2 years at Caltech, Preining used the new Goetz aerosol spectrometer for investigations of submicrometer aerosols: particle sources, stability, photochemically produced particles, and ambient particles in both urban and remote areas (see, e.g., Goetz et al., 1961). In those days, microscopic counting was the only possible way to detect the particles, and it was very time consuming. Also, it limited the particle sizing to about >50 nm. Very early, Preining realized the importance of nanoparticles, and he always wanted to investigate particles below this limit, although many researchers at that time were not convinced about the importance of particles that small. Nanoparticles interested him his whole life and he published several papers explaining their existence, their properties, and the need to do research in this field (Preining et al., 1967; Preining & Berner, 1979; Preining, 1981, 1992c, 1998; Pui et al., 2000). Today, this is obvious, but 40 years ago, many researchers doubted it.

In Vienna, he continued research on nanoparticles, eventually leading to the development of the Size Analyzing Nucleus Counter (Wagner, 1975) and many applications (e.g., Porstendörfer et al., 1985; Liu et al., 1982, 1984; Ankilov et al., 2002a, 2002b)

At Caltech (1958–1960), a colleague recommended Leon Brillouin's (1962) book on information theory to Preining. He was very interested in this subject, gave lectures on it at the University of Vienna, and used it in his research (e.g., for his paper on the detection of spatially inhomogeneous particle clouds; Preining, 1983a). With this publication, he was decades ahead of his time. Similarly, he learned about fractals around 1980 (Mandelbrot, 1977), and he presented many lectures and wrote papers about the application of fractals in aerosol science at a time when no application was recognized (Preining, 1980, 1988, 1990a). Today, fractals are widely used in aerosol science (e.g., Herrera et al., 2008).

His participation as a delegate of the Austrian government to a CO₂ conference brought him in touch with the global warming problem. He thoroughly investigated the available literature and immediately realized the role of aerosol particles, which was then mostly overlooked. He published several papers on this subject well before other aerosol scientists were aware of it (Preining, 1991a, 1991b, 1992a, 1992b, 1993a, 1993b, 1993c, 1993d, 1995, 2000).

Preining actively guided the science of his coworkers, supplied valuable information, and suggested many improvements. Thus he earned the right to be coauthor of many papers (e.g., Berner & Preining, 1964, 1984; Abed-Navandi et al., 1976; Berner et al., 1979; Horvath et al., 1980, 1982, 1994a, 1994b; Preining & Reischl, 1982; Kasper et al., 1978).

As president of *Gesellschaft für Aerosolforschung* (GAeF, or Association for Aerosol Research; Figure 5) from 1986 to 1990, he searched all available sources to learn about Marian Smoluchowski (1872–1917), who also had been a professor at the University of Vienna and who was selected the figurehead for the annual award bestowed by GAeF. As with everything, Preining researched his subject comprehensively and with great care. We now know very much about this man, mostly unknown before Preining's work (Preining, 1986, 2001). The importance of Smoluchowski's scientific work can be estimated by a few facts put together by Preining. The number of citations of Smoluchowski's publications from the first decade of the 20th century is far larger than the number of citations to Einstein's famous papers. Preining enjoyed being in the library and digging in old literature; thus, he unearthed historic measurements of the atmospheric CO₂ concentration in 1880 (Preining, 1983b).

Preining's participation at high-level conferences either as a government representative or as a member of the Austrian Academy of Sciences directed his publications toward programmatic or policy-oriented papers. Preining tirelessly worked for a sound and clean environment. His publications represent his personal opinion, and he oriented his personal life in accordance to his opinion. His policy-oriented publications dealt with topics such as using a system analytical approach to aerosol characterization (Preining, 1984), aerosol climatology (Preining, 1990b), global ecology (Konratyev et al., 1992; Preining, 1992a, 1992b), particulate matter and health (Hauck & Preining, 1998a, 1998b), and energy policy (Preining, 2002). Despite the presence of



Figure 5. Othmar Preining as president of GAeF (*Gesellschaft für Aerosolforschung*, or Association for Aerosol Research).

Photo: Courtesy of the author.

his opinions, Preining's work was always grounded in science and was up to date; for example, shortly after his retirement from the University of Vienna, Preining published a review containing the newest results of investigations on nanoparticles (Preining, 1998).

As mentioned earlier, Preining realized very early that health effects of particulate matter merited further investigation. The capabilities for doing this existed in Austria, but the field needed a driving force, an organizer, and a coordinator. Beginning about 1995, Preining invested all of his energy and diplomatic talents in putting together scientists and equipment and raising money for AUPHEP. The project was very successful, as can be seen by the many papers for which Preining is author or coauthor (Neuberger et al., 2001, 2002, 2004; Hauck et al., 2001, 2004a, 2004b; Horak et al., 2001; Preining & Hauck, 2004; Gomiscek, 2004a, 2004b; Puxbaum et al., 2004; Berner et al., 2004).

The Vienna Aerosol Group

After Preining's return from his first visit to the United States, he had his first PhD students and built the Vienna Aerosol Group. Preining's leadership helped to develop, over time, the size analyzing condensation nucleus counter (SANC/CAMS), a high-resolution aerosol centrifuge, a diffusion battery, low-pressure cascade impactors permitting sizing down to 10 nm, and later a family of differential mobility analyzers, as well as various optical techniques for size spectrometry and atmospheric visibility studies.

Preining required his coworkers to have both experimental skills and sound theoretical abilities. He expected his group members to spend sufficient time in laboratories abroad to greatly increase their horizons of scientific knowledge and their experimental techniques. Working abroad was a mandatory (albeit unwritten) requirement for permanent positions in his department. With theoretical knowledge and experimental skills, as well as good support from the institute's machine shop, Preining's students developed excellent aerosol instruments under his gentle guidance. They were used intensively for aerosol investigations. These instruments have become well established and actually are brand names of the Vienna School of Aerosol Physics. A few examples are the Berner impactor (or Hauke impactor), developed by Axel Berner (PhD with Preining, 1964); the University of Vienna telephotometer, developed by Helmuth Horvath (PhD under Preining's guidance, 1966); the Vienna type differential mobility analyzer,

developed by Georg Reischl (PhD, 1971); the SANC/CAMS, developed by Paul Wagner (PhD, 1974); and the dual wavelength optical particle spectrometer, developed by Wladyslaw Szymanski (PhD, 1981). Preining was always very interested in the progress and success of his coworkers and supplied them with many ideas. His contacts with aerosol research institutions all over the world created many opportunities for collaboration and brought frequent visitors to Vienna, increasing everyone's knowledge.

With the accumulated knowledge and instrumentation, members of the Vienna Aerosol Group participated in international research projects such as Visibility Impairment due to Sulfur Transport and Transformation in the Atmosphere, the Southern California Air Quality Study, and EUROTRAC. Vienna was also an ideal location for workshops such as the Workshop on Ultra Fine Aerosols (held in Vienna in 1979 and 1980; see Liu et al., 1982; Porstendörfer et al., 1981), and the intercomparison workshop on particle counters (Reischl & Wagner, 2002). Members of the Vienna Aerosol Group successfully organized conferences and symposia in Vienna. With knowledge available on practically all fields of aerosol science, the Aerosol Group organized a much-esteemed summer school in 2007. Preining was able to attend the first half day. One could easily see his satisfaction with the success of his group, the seed of which he had laid around 1960.

Honors and Awards

Being so versatile, innovative, and energetic, Preining received many awards. The awards were bestowed for his scientific merits by societies such as the Austrian Academy of Sciences, the European Aerosol Assembly, and the International Aerosol Research assembly. Awards from the Austrian government honored Preining's tireless engagement with the environment and public health. In chronological order, his awards included:

- Felix Kuschenitz Award of the Austrian Academy of Sciences, April 1962;
- Österreichisches, Ehrenkreuz für Wissenschaft und Kunst I. Klasse, 1978;
- Erwin Schrödinger Award of the Austrian Academy of Sciences, 1982;
- Fuchs Memorial Award of the International Aerosol Research Assembly, 1994;
- Ehrenpreis der österreichischen Elektrizitätswirtschaft, 1995;
- Preis der Stadt Wien, 1995; and
- Junge Award of the European Aerosol Assembly, 2005.

Othmar Preining: The Person

Preining was an admirable person. As we know from the previous sections, he was an excellent scientist, ingenious organizer, and gifted diplomat. But this is only half the story: he was tops in almost every category. He educated himself in nearly every discipline. With his profound knowledge of Austrian history, he always impressed not only visitors to Vienna but also the locals. Likewise, he knew American history, Indian culture, and Asian history. He was well informed about Christianity, Buddhism, and Hinduism, and he could explain the rites of a Mass in such an excellent way that nobody noticed he was an atheist. He also had deep interest in literature; he must have read one book per week. I have the impression that he liked the scurrilous. For a while, the Austrian poet Fritz von Herzmanovsky-Orlando was his favorite. For some time, he would recite whole paragraphs from Hermanovsky-Orlando's book *Der Gaulschreck im Rosenetz*. The students in his classes always found it amusing when he read mathematical poems; his favorite was the *Ballade vom kleinen Epsilon* (the ballad of the small epsilon, which could not find the corresponding delta).

Preining was interested in cultural events of any kind. He enjoyed going to the theater and the opera, listening to concerts, and visiting museums. There were ample occasions for these events in Vienna, but this was not enough. When participating in conferences, Preining frequently went a day early to visit famous museums or to see theater performances or ballets. The conferences, 1-day symposia, or invited lectures that Preining planned, especially those dealing with the history of science, always had musical performances at the beginning and the end.

The environment was very important to Preining, and he used all his energy to fight for a clean environment. He enjoyed nature and loved to be outdoors. Although he never was in good health, he climbed mountains, skied, and went rock climbing (Figure 6). Just like everything else, he did these things with full energy, as long as his health made it possible. He was so enthusiastic about rock climbing that he convinced two of his students to learn it, and they both still enjoy it. One of Preining's specialties was climbing in caves, and he invited his two students to join him on his expeditions.

As mentioned previously, Preining was very accessible. It was easy to make contact with him and, being an excellently educated man, he was able to converse about practically any topic. He tried to help everybody, whether their problems were scientific or personal. His priorities were always

(1) helping other people; (2) benefitting the general public, science, and culture; and (3) taking care of himself. He never sought personal gain, and his actions were always guided by how others could benefit. A few examples illustrate this.

Preining's aunt (with whom he walked as a young boy to Unterretzbach after the end of the war) became very old and no longer had any close living relatives. Preining considered it his obligation to visit her regularly, even when he was very sick himself.

At times, when computing was still exotic and scientists had to use computer centers, Preining found it absolutely necessary to establish easy access to computing, so he volunteered to serve as the codirector of Vienna's inter-university computing center from 1976 to 1979. This was a time-consuming, nerve-wracking job, which definitely deteriorated his quality of life. Likewise, Preining volunteered in the information campaign on nuclear energy, which the Austrian government launched in 1976. He chaired several sessions that were attended by about 500 persons, many of whom opposed nuclear energy. He prepared himself well and, although the sessions were turbulent and generally lasted far past midnight, they never got out of control.

Preining was always open-minded about innovations. The first and, for a long time, the only facsimile machine in the physics building was purchased upon Preining's request. When computers still were considered unnecessary, he lent two of his research rooms to the "Prozessrechenanlage Physik." In this way, he made sure that the physicists got optimum online computer service. To my knowledge, he was the only professor who supplied "his" rooms for innovative technologies to benefit the public. Usually the opposite occurs.

Preining's talent for sensing future scientific need has been mentioned several times. He was one of the founding members of GAeF, which later became the nucleus or role model for associations of aerosol scientists in Europe, America, and around the world. He set the stage for the first



Figure 6. Othmar Preining demonstrating his love for the mountains and the environment.

Photo: Courtesy of the author.

European Aerosol Conference (EAC, 1987) in Lund, Sweden, which took place under his presidency (1986–1990). This conference has become a major international event for aerosol science.

Epilogue

On September 26, 2007, a few months after celebrating his 80th birthday (Figure 7), Preining died. For his burial he wished to have no speeches and no flowers; he wanted all to be very simple. Knowing him as a person, this was expected.

We can now look back on a successful scientific life. Preining remains a towering figure in aerosol science: a visionary scientist who shaped the field in many areas that were later to become the most important and a leader who inspired others around him for many decades. He was a man with great respect for society and the environment. He put benefit to the community above personal gain. He worked tirelessly; even serious illness could not stop him. He was a good friend to all of us.

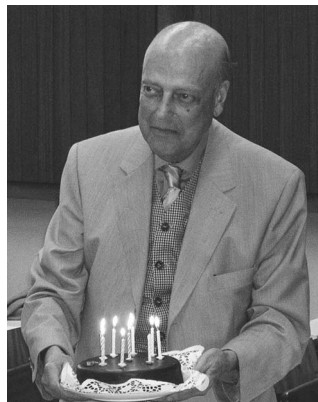

Figure 7. Othmar Preining being handed a birthday cake during the celebration of his 80th birthday.

Photo: Courtesy of the author.

References

- Abed-Navandi, M., Berner, A., & Preining, O. (1976). The cylindrical aerosol centrifuge. In B. Y. H. Liu (Ed.), *Fine particles, aerosol generation, measurement, sampling, and analysis* (pp. 447–464). New York, NY: Academic Press.
- Ankilov, A., Baklanov, A., Colhoun, M., Enderle, K.-H., Gras, J., Julanov, Y., Kaller, D., Lindner, A., Lushnikov, A. A., Mavliev, R., McGovern, F., O'Connor, T. C., Podzimek, J., Preining, O., Reischl, G. P., Rudolf, R., Sem, G. J., Szymanski, W. W., Vrtala, A. E., Wagner, P. E., Winklmayr, W., & Zagaynov, V. (2002a). Particle size dependent response of aerosol counters. *Atmospheric Research*, 62(3–4), 209–237.

- Ankilov, A., Baklanov, A., Colhoun, M., Enderle, K.-H., Gras, J., Julanov, Y., Kaller, D., Lindner, A., Lushnikov, A. A., Mavliev, R., McGovern, F., Mirme, A., O'Connor, T. C., Podzimek, J., Preining, O., Reischl, G. P., Rudolf, R., Sem, G. J., Szymanski, W. W., Tamm, E., Vrtala, A. E., Wagner, P. E., Winklmayr, W., & Zagaynov, V. (2002b). Intercomparison of number concentration measurements by various aerosol particle counters. *Atmospheric Research*, 62(3–4), 177–207.
- Berner, A., & Preining, O. (1964). Über eine neue Eichung des Casella-Kaskadenimpaktors. *Staub Reinhaltung der Luft*, 24, 292–295.
- Berner, A., & Preining, O. (1984). A low pressure cascade impactor for aerosol sampling at high temperatures. In S. Masuda (Ed.), *Proceedings of the Second International Conference on Electrostatic Precipitation, Kyoto, Japan* (pp. 990–994). Pittsburgh, PA: Air & Waste Management Association.
- Berner, A., Lürzer, C., Pohl, F., Preining, O., & Wagner, P. (1979). Size distribution of the urban aerosol in Vienna. *Science of the Total Environment*, 13(3), 245–261.
- Berner, A., Galambos, Z., Ctyroky, P., Fruhauf, P., Hitzenberger, R., Gomiscek, B., Hauck, H., Preining, O., & Puxbaum, H. (2004). On the correlation of atmospheric aerosol components of mass size distributions in the larger region of a central European city. *Atmospheric Environment*, 38(24), 3959–3970.
- Boscoe, G. F., Matteson, M. J., & Preining, O. (1973). Eigenschaften feinteiliger Kondensationsaerosole. *Staub Reinhaltung der Luft*, 33, 163–166.
- Brillouin, L. (1962). *Science and information theory* (Dover Phoenix Edition). Mineola, NY: Dover Publications.
- Ernst, F., Keck, G., Preining, O., Resch, W., Schedling, J. A., & Sedlacek, M. (1962a). Über Messungen der langlebigen Radioaktivität in den untersten Schichten der Troposphäre in der Zeit vom 1. *Mitteilungen der Österreichischen Sanitätsverwaltung*, 63, 1–16.
- Ernst, F., Preining, O., & Sedlacek, M. (1962b). Sizing of fall-out at Vienna. *Nature*, 195(4845), 986–987.
- Goetz, A., Stevenson, H. J. R., & Preining O. (1960). Design and performance of the aerosol spectrometer. *Journal of the Air Pollution Control Association*, 10, 378–383.

- Goetz, A., Preining, O., & Kalali, T. (1961). The metastability of natural and urban aerosols. *Geofisica Pura e Applicata*, 50, 67–80.
- Gomiscek, B., Hauck, H., Stopper, S., & Preining, O. (2004a). Spatial and temporal variations of PM₁, PM_{2.5}, PM₁₀ and particle number concentration during the AUPHEP project. *Atmospheric Environment*, 38, 3917–3934.
- Gomiscek, B., Frank, A., Puxbaum, H., Stopper, S., Preining, O., & Hauck, H. (2004b). Case study analysis of PM burden at an urban and a rural site during the AUPHEP project. *Atmospheric Environment*, 38, 3935–3948.
- Hauck, H., & Preining, O. (1998a). PM related health hazards—The Austrian way. *Journal of Aerosol Science*, 29(Suppl. 1), S991–S992.
- Hauck, H., & Preining, O. (1998b, June 22–26). *Ambient air quality standards for particulate matter—The Austrian approach*. Paper presented to the American Association for Aerosol Research, Cincinnati, OH.
- Hauck, H., Berner, A., Gomiscek, B., Kalina, M., Preining, O., Puxbaum, H., & Stopper, S. (2001). Results from phase 1 of AUPHEP. *Journal of Aerosol Science*, 32(Suppl. 1), S629–S630.
- Hauck, H., Berner, A., Frischer, T., Gomiscek, B., Kundi, M., Neuberger, M., Puxbaum, H., Preining, O., & AUPHEP Team. (2004a). AUPHEP—Austrian Project on Health Effects of Particulates—General overview. *Atmospheric Environment*, 38, 3905–3915.
- Hauck, H., Berner, A., Gomiscek, B., Stopper, S., Puxbaum, H., Kundi, M., & Preining, O. (2004b). On the equivalence of gravimetric PM data with TEOM and beta-attenuation measurements. *Journal of Aerosol Science*, 35(9), 1135–1149.
- Herrera, E., Trujillo, B., Vásquez, A., & Balam, R. (2008). Characterization of aerosol size using fractal theory in experimental data collected in Chihuahua City. *Geophysical Research Abstracts*, 10, EGU-2008-A-11965.
- Horak, F., Jr., Frischer, T., Studnicka, M., Gartner, C., Hauck, H., & Preining, O. (2001). The chemical composition of particulate matter has a short term effect on the lung-function of pre-school children. *European Respiratory Journal*, 18(Suppl. 33), 128s.

- Horvath, H., Presle, G., & Preining, O. (1980). Measurement of the spatial inhomogeneous distribution of particulate pollution. *Journal of Aerosol Science*, 11, 257–260.
- Horvath, H., Preining, O., & Pirich, R. (1982). Measurements of the spatial-distribution of particulate pollution with a telephotometer. *Atmospheric Environment*, 16(6), 1457–1461.
- Horvath, H., Metzger, G., Preining, O., & Poeschel, R. F. (1994a). Observation of a blue sun over New-Mexico, USA, on 19 April 1991. *Atmospheric Environment*, 28(4), 621–630.
- Horvath, H., Itoh, M., Preining, O., & Takahashi, K. (1994b). Light extinction and light absorption of the Kyoto aerosol. *Journal of Aerosol Research, Japan*, 9, 330–337.
- Kasper, G., Preining, O., & Matteson, M. J. (1978). Penetration of a multistage diffusion battery at various temperatures. *Journal of Aerosol Science*, 9, 331–338.
- Kondratyev, K., Ortner, J., & Preining, O. (1992). Priorities for global ecology now and in the next century. *Space Policy*, 8(1), 39–48.
- Liu, B. Y. H., Pui, D. Y. H., McKenzie, R. L., Agarwal, J. K., Jaenicke, R., Pohl, F. G., Preining, O., Reischl, G., Szymanski, W., & Wagner, P. E. (1982). Intercomparison of different “absolute” instruments for measurement of aerosol number concentration. *Journal of Aerosol Science*, 13, 429–450.
- Liu, B. Y. H., Pui, D. Y. H., McKenzie, R. L., Agarwal, J. K., Pohl, F. G., Preining, O., Reischl, G., Szymanski, W., & Wagner, P. E. (1984). Measurements of Kelvin equivalent size distributions of well defined aerosols with particle diameters >13 nm. *Aerosol Science and Technology*, 3, 107–115.
- Mandelbrot, B. B. (1977). *Fractals: Form, chance, and dimension*. San Francisco, CA: W. H. Freeman & Company.
- Matteson, M. J., Preining, O., & Fox, J. F. (1972). Density distribution of sodium-chloride aerosols formed by condensation. *Nature Physical Science*, 238(82), 61–63.
- Matteson, M. J., Sandlin, C. W., & Preining, O. (1973). Diffusion of aerosols at various temperatures. *Journal of Aerosol Science*, 4, 307–315.

- Matteson, M. J., Boscoe, G. F., & Preining, O. (1974). Design theory and calibration of a field type aerosol spectrometer. *Journal of Aerosol Science*, 5, 71–79.
- Neuberger, M., Horak Jun, F., Frischer, T., Kundi, M., Puxbaum, H., Studnicka, M., Hauck, H., & Preining, O. (2001). Austrian project on health effects of particulates: First results on lung function changes in children. *Newsletter: WHO Collaborating Centre for Air Quality Management and Air Pollution Control*, 28.
- Neuberger, M., Horak Jun, F., Frischer, T., Kundi, M., Puxbaum, H., Studnicka, M., Hauck, H., & Preining, O. (2002). Austrian project on health effects of particulates: First results on lung function changes in children. *Pollution Atmosphérique*, 175, 383–386.
- Neuberger, M., Schimek, M. G., Horak, F., Moshhammer, H., Kundi, M., Frischer, T., Gomisceka, B., Puxbaum, H., Hauck, & AUPHEP Team. (2004). Acute effects of particulate matter on respiratory diseases, symptoms and functions: epidemiological results of the Austrian Project on Health Effects of Particulate Matter (AUPHEP). *Atmospheric Environment*, 38(24), 3971–3981.
- Porstendörfer, J., Scheibel, H. G., Pohl, F. G., Preining, O., Reischl, G., & Wagner, P. E. (1981, September 23–25). *Investigations of heterogeneous nucleation on ultrafine monodispersed Ag and NaCl aerosol particles by means of the size analyzing nuclei counter (SANC): Results of the 1980 WUFA [Workshop on Ultra Fine Aerosols] Workshop*. Paper presented at the Aerosols in Science. Medicine and Technology—Aerosols in and from Industrial Processes: Gesellschaft für Aerosolforschung, Duisburg, Germany.
- Porstendörfer, J., Scheibel, H. G., Pohl, F. G., Preining, O., Reischl, G., & Wagner, P. E. (1985). Heterogeneous nucleation of water-vapor on monodispersed Ag and NaCl particles with diameters between 6 and 18 nm. *Aerosol Science and Technology*, 4(1), 65–79.
- Preining, O. (1951). *Untersuchungen über Magnetophotophorese an zerstäubten Silberstahl* (Unpublished doctoral dissertation). University of Vienna, Austria.
- Preining, O. (1954). Laboratoriumsmäßige Herstellung von hohen Temperaturen (bis 55.000°). *Österreichische Chemiker Zeitung*, 55, 67–72.

- Preining, O. (1957). Einige Bemerkungen zur Anordnung für die Demonstration des Zeemann Effekts der Natrium D Linien. *Praxis der Naturwissenschaften*, 6, 221–222.
- Preining, O. (1958a). Ein Versuch zur objektiven Demonstration der anomalen Dispersion von Flüssigkeiten. *Praxis der Naturwissenschaften*, 7, 127–133.
- Preining, O. (1958b). Ein $\lambda/4$ Blättchen für cm Wellen. *Praxis der Naturwissenschaften*, 7, 233–235.
- Preining, O. (1958c). Ein Wellenleiter für Oberflächenwellen von Flüssigkeiten. *Acta Physica Austriaca*, 12, 172–186.
- Preining, O. (1958d). Ein Versuch zur objektiven Demonstration der anomalen Dispersion von Flüssigkeiten. *Praxis der Naturwissenschaften*, 7, 127–133.
- Preining, O. (1962). Zum Problem der Eichung fraktionierender Meßgeräte für Stäube der Kongrößen zwischen 0.1 und 1 Mikron mit Hilfe von Testaerosolen. *Staub Reinhaltung der Luft*, 22, 456–463.
- Preining, O. (1963). Einige Demonstrationsversuche mit “verlustlosen” Hohlleitern. *Acta Physica Austriaca*, 16, 341–347.
- Preining, O. (1965). Verallgemeinerter Entropiesatz und Unschärferelation. *Acta Physica Austriaca*, 21, 99–104.
- Preining, O. (1966). Photophoresis. In C. M. Davies (Ed.), *Aerosol science* (pp. 111–135). London: Academic Press.
- Preining, O. (1967). The Stokes diameter of ellipsoidal particles. *Atmospheric Environment*, 1, 271–285.
- Preining, O. (1968). Über den Zerfall der Information. *Acta Physica Austriaca*, 27, 18–22.
- Preining, O. (1972). Information theory applied to the acquisition of size distributions. *Journal of Aerosol Science*, 3, 289–296.
- Preining, O. (1974). The cost of air pollution damage in Austria 1970. *Water, Air & Soil Pollution*, 3, 421–429.
- Preining, O. (1980). Fractals and aerosol characterization (abstract). *Journal of Aerosol Science*, 11, 257.

- Preining, O. (1981). Ultrafine aerosols sizing, description and descriptors. *Journal of the Society of Powder Technology, Japan*, 18, 524–530.
- Preining, O. (1983a). Optical single particle counters to obtain the spatial inhomogeneity of particulate clouds. *Aerosol Science and Technology*, 2, 79–90.
- Preining, O. (1983b). The 1880 measurement of the average atmospheric CO₂ concentration by Ernst Lecher. *Atmospheric Environment*, 17(8), 1595.
- Preining, O. (1984). Aerosol characterization I (state of the art review) and Aerosol characterization II, a system analytical approach for aerosols in industry. In S. Masuda (Ed.), *Proceedings of the Second International Conference on Electrostatic Precipitation, Kyoto, Japan* (pp. 623–633). Air & Waste Management Association.
- Preining, O. (1986). Marian Smoluchowski Ritter von Smolan: What kind of a man and scientist to be elected figure head of Aerosol Science. In *Aerosols: Formation and reactivity, proceedings, second international aerosol conference* (pp. 1–9). Oxford, United Kingdom: Pergamon Press.
- Preining, O. (1988). Fractals geometry—Unchained. *Austria Today*, 1(88), 54–58.
- Preining, O. (1990a). Fractals and analytical chemistry—An old and a new look. *Fresenius Journal of Analytical Chemistry*, 337, 172–175.
- Preining, O. (1990b). Editorial: Aerosol climatology. *Journal of Aerosol Science*, 21, 1.
- Preining, O. (1991a). The university and global warming. *World Resource Review*, 3, 107–126.
- Preining, O. (1991b). Aerosol and climate—An overview. *Atmospheric Environment*, 25A, 2443–2444.
- Preining, O. (1992a). Global warming: Greenhouse gases versus aerosols. *The Science of the Total Environment*, 126, 199–204.
- Preining, O. (1992b). Report: ASCEND 21, on an agenda of science for environment and development into the 21st century. *World Resource Review*, 4, 312–320.
- Preining, O. (1992c). The science of ultrafine aerosols. *Pure and Applied Chemistry*, 64, 1679–1684.

- Preining, O. (1993a). Global climate change due to aerosols. In C. N. Hewitt & W. T. Sturges (Eds.), *Global Atmospheric Chemical Change* (pp. 93–122). London United Kingdom: Elsevier Applied Science.
- Preining, O. (1993b). On the many facets of global warming. *World Resource Review*, 5, 156–170.
- Preining, O. (1993c). Aerosols and global warming. *World Resource Review*, 5, 409–413.
- Preining, O. (1993d). The challenge of global change: The climate issue. In F. A. Battif (Ed.), *The Challenge of Waste, Proceedings of the International Symposium* (pp. 5–31). Vienna.
- Preining, O. (1995). Global warming science and anti-science. *World Resource Review*, 7, 215–220.
- Preining, O. (1998). The physical nature of very, very small particles and its impact on their behaviour. *Journal of Aerosol Science*, 29, 481–495.
- Preining, O. (2000). Global warming in perspective. *World Resource Review*, 12(3), 421–427.
- Preining, O. (2001). Marian Smoluchowski, Ritter von Smolan: Weltweiter Wegbereiter der Naturwissenschaften des 20. Jahrhunderts. In F. Grucza (Ed.), *Multiethnizität und Interkulturalität, Geschichte, Erfahrungen, Berichte, Lösungen*. Warsaw, Poland: Polish Academy of Sciences.
- Preining, O. (2002). Energy policy and climate change in perspective. In M. A. Herman (Ed.), *Ecology and EcoTechnologies, Proceedings of the Review Conference on the Scientific Cooperation between Austria and Poland* (pp. 31–34). Vienna, Austria: Centrum Upowszechniana Nauki, Polskiej Akademii Nauk.
- Preining, O. (2003, November 27). *Energy & air pollution in cities—The example of Vienna*. Paper presented at the EET Workshop, Energy in Cities, La Villette, Paris.
- Preining, O., & Berner, A. (1979). *Aerosol measurements in the submicron size range* (Report No. EPA-600/2-79-105, pp. 1-93). Washington, DC: U.S. Environmental Protection Agency.
- Preining, O., & Davis, E.J. (Eds.). (2000). *History of aerosol science*. Vienna, Austria: Verlag der Österreichischen Akademie der Wissenschaften.

- Preining, O., & Hauck, H. (2004). Editorial. *Atmospheric Environment*, 38, 3903.
- Preining, O., & Reischl, G. (1982). Aerosols, description and descriptors. *Időjárás: Quarterly Journal of the Hungarian Meteorological Service*, 86, 104–109.
- Preining, O., Sedlacek, M., Ernst, F., Resch, W., & Schedling, J. A. (1963). Fallout Untersuchungen im Raum von Wien in der Zeit vom 1. Sept. 1961 bis 30. Juni 1963. *Staub Reinhaltung der Luft*, 23, 407–412.
- Preining, O., Sheesley, D., & Djordjevic, N. (1967). The size distribution of aerosol produced by air blast nebulization. *Journal of Colloid and Interface Science*, 23, 458–461.
- Preining, O., Baumann, R., & Moser, F. (1969). Ergebnisse von SO₂ Messungen mit dem “Ultragas 3” und nach der Methode West Gaeke, durchgeführt mit Hilfe eines Eichkanals. *Staub Reinhaltung der Luft*, 29(11), 443–446.
- Preining, O., Podzimek, J., & Yue, P. (1976). The magnification factor for sodium chloride Liesegang circles established with an aerosol centrifuge. *Journal of Aerosol Science*, 7, 351–358.
- Pueschel, R. F. (2005). Alexander Goetz (1897–1970). In G. J. Sem, D. Boulaud, P. Brimblecombe, D. S. Ensor, J. W. Gentry, J. C. M. Marijnissen, & O. Preining (Eds.), *Proceedings of the Second Symposium on the History of Aerosol Science* (pp. 81–111). Mt. Laurel, NJ: American Association for Aerosol Research.
- Pui, D. Y. H., Brock, J. R., Chen, D. R., Fissan, H., Frisbie, C. D., Lyman, C. E., Miller, J. C., Mulholland, G. W., Pecora, R., Preining, O., & Vo-Dinh, T. (2000). Instrumentation and measurement issues for nanometer particles: Workshop summary. *Journal of Nanoparticles Research*, 2, 103–112.
- Puxbaum, H., Gomiscek, B., Kalina, M., Bauer, H., Salam, A., Stopper, S., Preining, O., & Hauck, H. (2004). A dual site study of PM_{2.5} and PM₁₀ aerosol chemistry in the larger region of Vienna, Austria. *Atmospheric Environment*, 38(24), 3949–3958.

- Reischl, G. P., & Wagner, P. E. (2002). Special issue: Aerosol number concentration measurement—International Workshop on Intercomparison of Condensation Nuclei and Aerosol Particle Counters. Preface. *Atmospheric Research*, 62(3–4), 175–175.
- Schrutka, L. (1924). *Elemente der höheren Mathematik für Studierende der technischen und Naturwissenschaften*. Vienna, Austria: Deuticke.
- Sedlacek, M., Preining, O., & Ernst, F. (1963). Korngrößenverteilung und Häufigkeit des langlebig radioaktiven Aerosols in der bodennahen Atmosphäre. *Acta Physica Austriaca*, 16(34), 296–303.
- Wagner, P. E. (1975). The interdependence of droplet growth and concentration. II. Experimental test of droplet growth theory. *Journal of Colloid and Interface Science*, 53, 439.
- Zweymüller, E., & Preining, O. (1969a). Die unsichtbare Wasserabgabe von Neugeborenen. *Monatsschrift für Kinderheilkunde*, 117, 381–383.
- Zweymüller, E., & Preining, O. (1969b). Die Problematik der Feuchte und Wärmeverhältnisse im Inkubator. *Wiener klinische Wochenschrift*, 81, 773–776.

Sheldon K. Friedlander

Aerosols' Man for All Seasons (1927–2007)

George M. Hidy

Most people working in the field of aerosols recognize the contributions of Sheldon Friedlander, not only from the literature but as an educator and advocate of its science establishment. This chapter traces a half-century history of Friedlander's leadership as a researcher, author, mentor, teacher, and crusader for aerosol science and technology. His achievements began in the 1950s with aerosol deposition as part of his research while an assistant professor in chemical engineering at Columbia University and later a professor at the Johns Hopkins University and the California Institute of Technology. He was recognized internationally for his aerosol science while actively committing many of his academic sabbaticals to extended visits at European institutions. His mature years in teaching and research were spent at the University of California, Los Angeles, as the Parsons Professor of Chemical Engineering and as a cofounder of the American Association for Aerosol Research (AAAR). Until his death in 2007, Sheldon Friedlander remained active as a researcher and a leader in aerosol science. He is missed for his wisdom and friendship by all who knew him.

Sheldon was an advocate of an incisive approach combining theory and experiment, following examples of Irving Langmuir and other classical physical chemists. His notable and highly original works ranged from his early study of particle deposition and diffusion and the concept of self-preservation in size distributions, to the conceptualization of chemical mass balance modeling for atmospheric aerosols, and on to recent research on the formation and growth of particles, especially in the “nano” range. He made extensive contributions to the understanding of the importance of particle size distributions for characterizing aerosol dynamics and for environmental protection. He published works on the nature and significance of secondary atmospheric aerosols as a key to managing air quality. Through two editions

of his book, *Smoke, Dust, and Haze* (Friedlander, 2000), he communicated his deep, underlying understanding and approach to aerosol science to many workers and students of the science. Perhaps most important were his philosophical principles as expressed in his education and mentoring of the many students who have followed his lead and contributed greatly to the advancement of science and technology. Given Sheldon's long-standing record of achievements, it is most appropriate to recognize him among the great pioneers of an evolving 20th-century aerosol science.

Introduction

Aerosol science and technology are largely founded on experimental measurements and observations of natural phenomena; the discipline lies somewhere in between physics, chemistry, and various areas of modern engineering. Professor Sheldon Friedlander billed aerosol science as an “enabling technology” for a wide variety of practical applications, ranging from a description of atmospheric phenomena to the prolific new world of nanotechnology. As mentor, educator, researcher, and conceptual leader, he contributed to this wide range of aerosol-relevant topics.

Sheldon's career began in the post-World War II years following the maturing of the experimental work of Victor LaMer and David Sinclair at Columbia University. Later, as a graduate student, he worked closely with H. F. Johnstone in chemical engineering at the University of Illinois. His early training in continuum fluid dynamics and chemical transport phenomena was ideally suited to advancing the knowledge about aerosol dynamics, through design of experiments and interpretation of many observations and measurements in the literature. His work began in a precomputer era, so his theoretical models relied heavily on analytical approximations and fluid boundary layer theory applied to aerosol particles rather than the blunt edge of computer modeling for problem solutions. In addition, his theoretical work was essentially always derived from or tied to experimental observations for verification of his interpretations.

As a student and colleague of Sheldon, I experienced many of the elements that made him one of the greatest aerosol scientists of our day. As a mentor, he guided many students and associates through the frontiers of aerosol science with great wisdom. His mentoring was tempered with the spice of international cuisine, especially French, and a sprinkling of fine art, including

works from the Classic and Renaissance periods, found in the J. Paul Getty museums in the Los Angeles area. As an educator, he spent a lifetime in teaching at major universities across the United States and abroad. As a researcher, he contributed extensively to the knowledge about contemporary aerosol dynamics, atmospheric aerosols, and the interface between aerosols and public health or welfare, as well as the development of new concepts in particle characterization in industrial applications. His ability to synthesize, communicate, and interpret aerosol science for students is well represented in the two editions of his book *Smoke, Dust, and Haze* (Friedlander, 2000). He also is well known for his contributions to shaping, in the 1970s and later, key principles of the US air quality management practice, the founding of the American Association for Aerosol Research (AAAR), and many cooperative projects of national and international scope, including the California Aerosol Characterization Experiment (ACHEX) (Hidy, 2011). Figure 1 depicts Sheldon in his laboratory. Other photographs of Sheldon with some of his many colleagues are included elsewhere in this book.

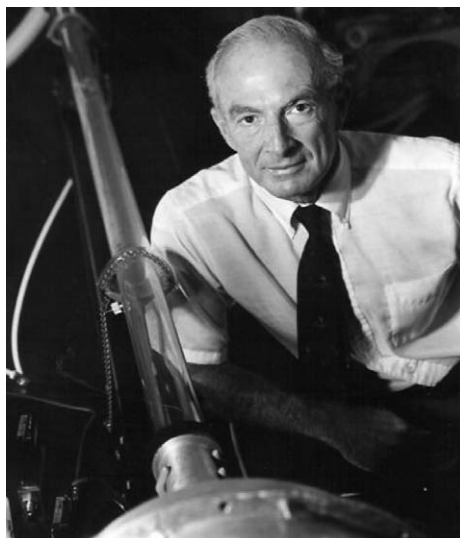

Figure 1. Sheldon Friedlander in his laboratory at the University of California, Los Angeles.

Photo: Courtesy of the Friedlander family.

As a personality, Sheldon was known to his colleagues as a true intellectual and academician. He was generally soft spoken and individualistic, with an intuition and insight akin to one of his mentors, the physical chemist Irving Langmuir. Sheldon was raised a New Yorker but spent much of his life in Southern California, with intermittent travel abroad. With his wife, Marjorie, he experienced the pleasures of family and children. As a chemical engineer

and applied scientist, he was highly intuitive in his work, with a mix of individual projects in “little” science combined with participation in larger “big” science projects. His influence in aspects of chemical engineering and aerosol science through commitments and leadership in the public domain and professional activities continue to be significant in shaping strategies for environmental protection.

Sheldon’s greatest achievements will be recognized in part from his contributions to aerosol research in the many areas in which he worked with students and colleagues. I offer examples of his achievements here, mainly focusing on his work in aerosol dynamics. This tribute reflects my biases in knowledge and interpretation of his work. I hope my choice of examples will go well beyond such biases as the history of aerosol science progresses in successive generations.

Aerosol Dynamics

Sheldon’s basic interest in continuum aerosol dynamics began during his initial work with Johnstone, when he investigated the deposition of aerosol particles on surfaces from a turbulent gas flow (Friedlander & Johnstone, 1957). Figure 2 shows these results, represented in dimensionless form. Sheldon’s work largely extended to aerosols the concept of mass transfer from turbulent media to surfaces using boundary layer theory, with an application to pipe flow. He then extended this early work to particle transport to spheres, considering convective diffusion processes (Friedlander, 1967).

Figure 2 provides an example of a comparison between theoretical results and experiments for the Brownian diffusion and inertial capture regimes, including the results of Friedlander and Johnstone. Later Friedlander contributed to the understanding of deposition in these regimes to various geometric shapes, including spherical or cylindrical collectors as an analogy to filter fibers. The theory of diffusion and inertial deposition is commonly used in collector design and collection efficiency estimates today and is referenced in textbooks across the world. Friedlander’s investigations of deposition processes for particles led to his natural interest in collision and coagulation phenomena. This interest related more broadly to formation and growth processes and his logical consideration of the general dynamic equation (GDE) for particle clouds. The formulation of the GDE basically involved a mass balance equation for particles, in the form shown in Figure 3.

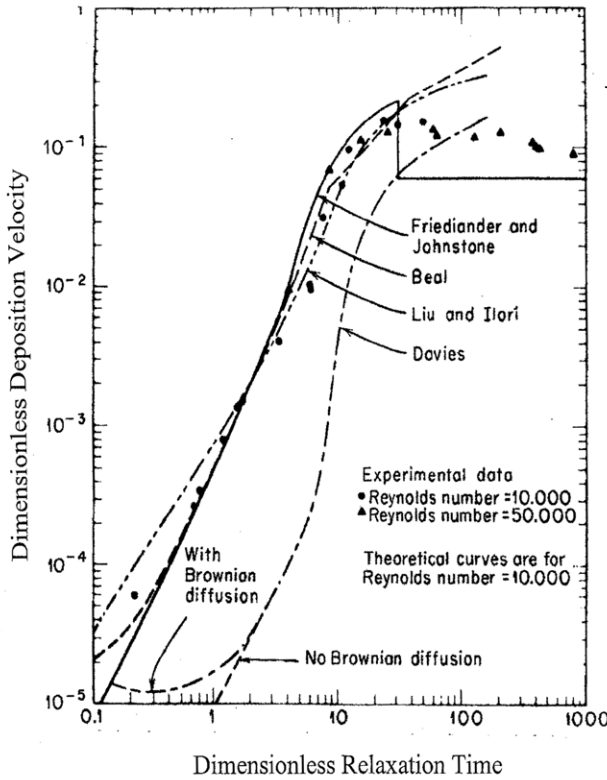

Figure 2. Turbulent deposition model from Friedlander and Johnstone (1957) in comparison with findings of other investigators. Note: The dimensionless deposition velocity is defined as the ratio of the mass transfer coefficient k and the fluid friction velocity u^* , and the dimensionless relaxation time is given by tu^{*2}/ν , where ν is the kinematic viscosity of the gas. Source: Liu and Agarwal (1974). Reprinted with permission from Elsevier.

$$\frac{dm_p}{dt} = \frac{\partial \rho_p V}{\partial t} + \rho_p \mathbf{q} \cdot \nabla V = \rho_p \int_{v_d}^{\infty} I \, dv + \rho_p (Iv)_{v_d}$$

[Growth of particles larger than a minimum of size v_d]
[Formation of new particles by nucleation]

$$+ \nabla^2 \int_0^{\infty} \rho_p D_p v n \, dv - \nabla \cdot \int_0^{\infty} \rho_p \mathbf{q}_E v \, dv.$$

[Diffusion]
[Migration by external force field]

Figure 3. General dynamic equation based on a mass balance for aerosol clouds.

Note: The terms of the equation are written on the right and include advection, diffusion, sources, and action of external forces. Losses by deposition and primary sources enter through the equation's boundary conditions. Here m_p is particle mass, ρ_p is particle density, V is particle volume, q is the aerosol velocity, I is the "current" or volume of material transferred as a result of gas-to-particle conversion, v is the volume of particles in the size range v and $v + dv$, D_p is particle diffusivity, and q_E is the velocity on the particle from external forces such as those imparted, for example, by electrical fields or by gravity.

Source: Friedlander (2000).

This equation is a complex expression involving manipulation of probability distributions—size distributions—to account for the range of size that affects the particle mass accounted for. A similar form can be written to account for total mass concentration as a function of chemical composition. Researchers have constrained their investigation of the properties of the GDE to certain limiting cases, such as growth or coagulation or loss-dominated conditions. As a major part of his work, Friedlander studied in detail the attributes of elements of this equation and used them to educate students about the formalism of particle cloud dynamics. He also made use of this framework to illustrate the foundations of the dynamics equation to its various moments (integrals), which are linked with practical measurements of cumulative distributions, including filter-based determinations of mass and chemical composition of airborne particles (Friedlander, 2000).

The classical theory of coagulation is embodied in the GDE and in one simplified form involves the application of the theory of collisions by Brownian motion. As an aside, particle diffusion by Brownian motion (and by random motion in turbulence) intrigued Friedlander, especially in deriving Einstein's diffusivity from the Langevin equation. This model provided a natural extension to Smoluchowski's theory for coagulation (Chandrasekhar, 1954) as a limiting expression of the GDE.

Applying dimensional scaling to the GDE for the case of coagulation combined with sedimentation, Friedlander (1960) found that subranges of a hypothetical number-particle size distribution could be identified, which were relevant to size distributions measured in the troposphere, as reported by Junge (1963) and later determined for urban particles sampled in Baltimore (Friedlander & Pasceri, 1965). Coagulation theory subsequently led to Friedlander's application of scaling of the size distribution in terms of total number concentration and cumulative volume such that after a period of time the size distributions become uniformly the same in dimensionless form, known as *self-similar* or *self-preserving*. Friedlander found that the evolution of the particle size distribution to develop this form for certain processes, such as coagulation of particles in Brownian motion, could describe certain cases, such as cigarette smoke. This concept is illustrated in Figure 4, where the size distribution of the coagulating particulate cloud is shown in dimensioned form but achieves self-similarity a short period after release of the smoke.

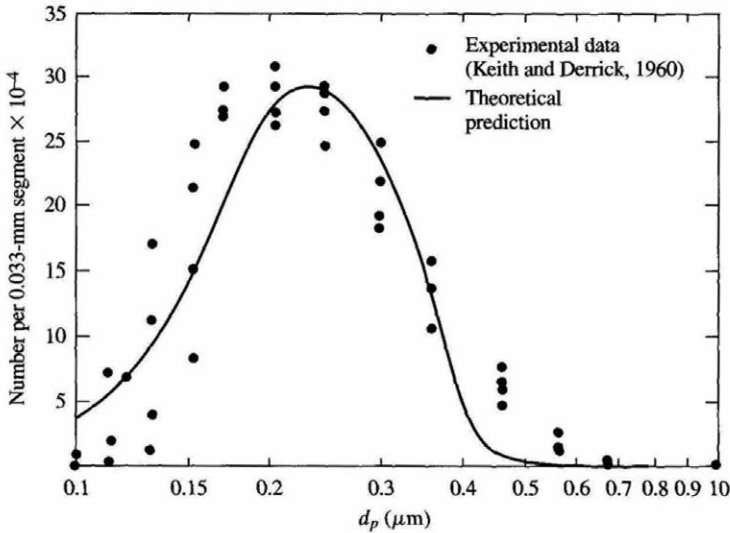

Figure 4. Comparison of experimental size distribution data for tobacco smoke with estimates based on self-preserving size spectrum theory.

Note: The volume density is 1.11×10^{-7} , and the total number concentration is $1.59 \times 10^7 \text{ cm}^{-3}$. The peak in the number distribution is estimated to be diameter (d_p) $\approx 0.2 \mu\text{m}$.

Source: Friedlander and Hidy (1969).

Investigators have obtained other forms of self-preserving distributions by combining coagulation with growth processes. For example, Pich and colleagues (1970) found that combined coagulation by Brownian motion and particle growth from vapor condensation according to Maxwell's diffusion equation for diffusion to a sphere yielded such a distribution. I followed Friedlander and Swartz's suggestions and explored a steady state form of the GDE, including coagulation, growth, and diffusion terms with application to atmospheric aerosols (Hidy, 1972). Certain constraints exist for such applications and estimated the aging time for the aerosol size distribution to become self-preserving and in steady state. Earlier, Friedlander (1960) investigated the use of scaling as applied to atmospheric aerosols. Scaling by the total number concentration and the volume density yielded a dimensionless number-size distribution of interest. Figure 5 shows an example of this distribution for several sets of data taken in various urban and rural locations and aloft. The steady state form for self-preserving distributions conceptually is consistent with that found empirically in Figure 5. The power law regime of diameter⁻⁴ is often termed the *Junge subrange* (Junge, 1963),

but the extreme region representing large particles about 10 μm diameter or greater theoretically falls off as $-19/4$ from the action of sedimentation. Another important component of the GDE concerns particle formation and growth coagulation. The power law can be shown to decline by $-5/2$ (Friedlander, 1960); this fits roughly a range of 0.01–1 μm diameter.

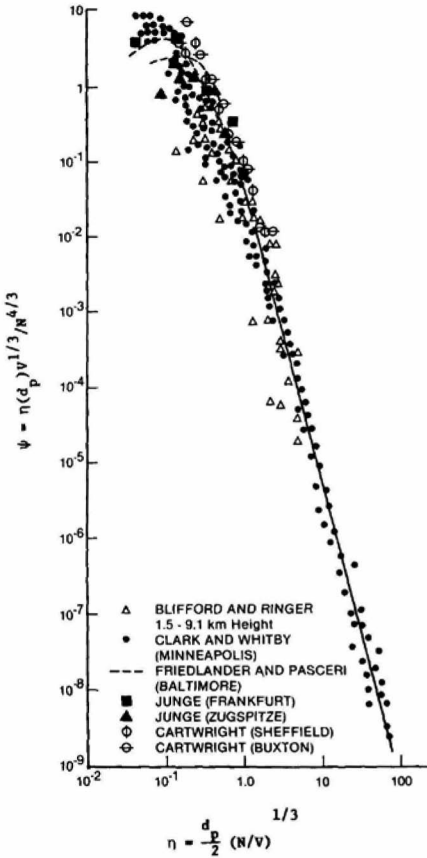

Figure 5. Dimensionless, asymptotic number-size distribution ψ for tropospheric aerosols in rural and urban conditions after Friedlander’s hypothesis.

Note: Scaling is in terms of total number of particles, N , and cumulative volume density, V . Dynamic subranges are suggested in power law form. The slope of the region above η of ~ 2 is -4 , sometimes called the Junge subrange, and the region from about 0.2 to 2 is $-5/2$ the coagulation subrange of Friedlander. Particle size distributions used from different sources are noted in Hidy (1986).

Source: Hidy (1986).

Friedlander’s exploration of theories for particle growth by vapor condensation or chemical reactions included a review of classical theory of new particle formation by nucleation as a limiting description of molecular and particle collisions. In a more practical way, he explored the application of a vapor diffusion-condensation model to aerosol growth, noting the consistency between the continuum model and the rate of volume accumulation of particles, as illustrated in Figure 6. Here the theoretical relation between

change particle volume and mean diameter fits well the experimental data, where the theoretical line drawn through the data applies to diffusional transfer-vapor condensation, corrected for the transition from a continuum model to the free molecule regime, and including the Kelvin effect for vapor-liquid equilibrium for small droplets.

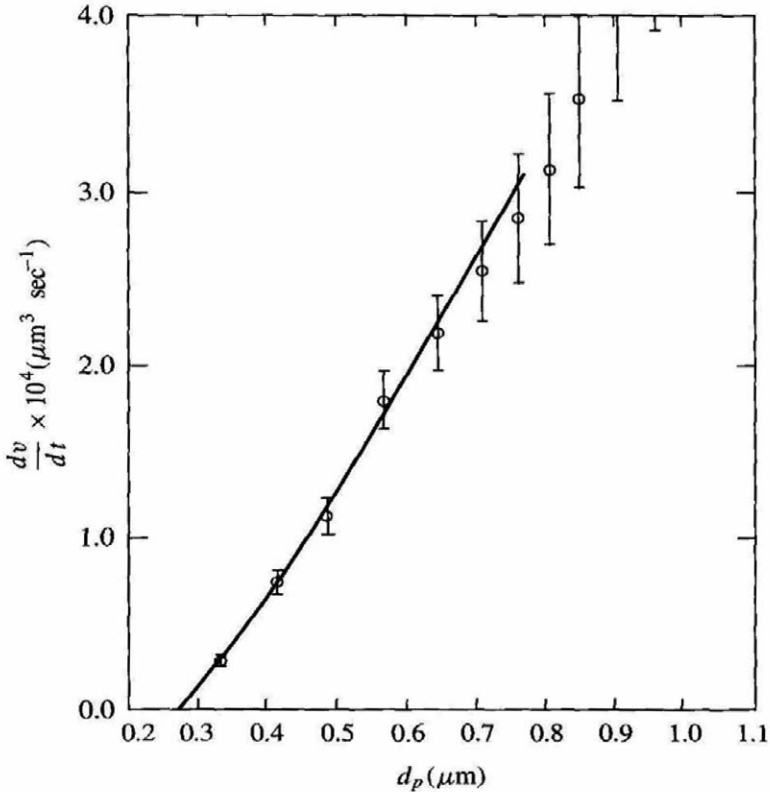

Figure 6. Growth of particles measured in a sunlight-irradiated smog chamber containing 2 ppm cyclohexene, 0.34 ppm NO, and 0.17 ppm NO₂ showing volume growth proportionality with diameter as expected from the theory of vapor diffusion and condensation on particles.

Note: The vapor diffusion model particle growth includes the Kelvin effect for droplets. The intercept of 0.27 μm is the critical droplet size.

Source: Heisler and Friedlander (1977). Reprinted with permission from Elsevier.

Atmospheric Aerosols

As noted earlier, Friedlander demonstrated a strong interest in atmospheric processes relevant to aerosols. Beyond his work on the dynamics of the particle size distribution, he contributed to knowledge of the origins and characterization of atmospheric aerosols in several ways. His interest in the formation of particle from atmospheric reactions produced observational insight into differences in mechanisms associated with sulfate production from sulfur (e.g., sulfur dioxide—SO₂) gas oxidation. Two regimes of oxidation based on collection by particle size are well illustrated in sampling in Pasadena, California, as shown in Figure 7. The first type of regime involved high relative humidity and high concentrations of sulfate and ozone.¹ Ozone represents an indicator of strong photochemical activity and the presence of high oxidant concentrations in photochemical smog, including hydrogen peroxide. High relative humidity with hygroscopic sulfate particles produces elevated liquid water content, providing a “fertile” medium for in-particle oxidation of absorbed SO₂, mainly with H₂O₂. In the second regime, of lowered relative humidity, low sulfate and oxidant concentrations evidently yields the potential for an alternate pathway of OH radical oxidation in the gas phase, and subsequent collection on particles in a broader particle size range, with maximum collection in smaller particles than the Type I case. Both mechanisms had been hypothesized, but the differentiation between the two in smog conditions was not found before this work.

The GDE also can be written in terms of mass conservation by chemical species. A simplified mass balance by chemical composition is commonly used in air pollution source-receptor modeling. Friedlander may be best known as the leading discoverer of this chemical mass balance (CMB) method for apportioning sources of aerosol particles (McMurry et al., 2004). His ideas probably originated in the early publication of Hidy and Friedlander (1970) for the case of Los Angeles. Later, Friedlander’s work culminated in a more definitive paper (Friedlander, 1973).

¹ Researchers found that sulfate was a major fraction of particle samples in the Los Angeles area prior to the early 1980s and attributed it to the photochemical oxidation of SO₂ in smog before SO₂ emissions were reduced dramatically in this urban area.

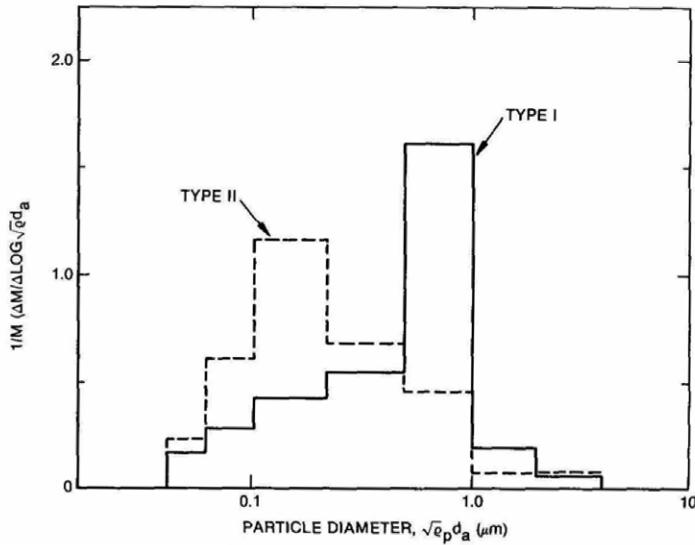

Figure 7. Identification of two urban particulate sulfur mass (M) distributions with size from composite samples of several low-pressure impactor measurements in Pasadena, California.

Note: The distributions are given in terms of aerodynamic diameter (d_a) corrected for atmospheric pressure, $\rho_p^{1/2} d_a$. Type I conditions include high relative humidity and high sulfate and ozone concentrations. Type II conditions involve lower relative humidity and low sulfate and ozone concentrations.

Source: Hering and Friedlander (1982). Reprinted with permission from Elsevier.

Sometime later, Gartrell and others (1980) used the ACHEX data, combined with emissions data, to develop not only a mass balance for several sites in Southern California but also a carbon mass balance for Los Angeles (Hidy et al., 1980). Table 1 presents the results of the carbon analysis. The carbon source distribution includes a large fraction from the motor vehicle sector, accounts for industrial and agricultural emissions, and provides a first comparative, empirical estimate of the primary carbon from urban sources and the secondary carbon from volatile organic compound (VOC) oxidation in the air. Analyses from the ACHEX and other investigations in California called attention to the importance of secondary organic carbon, notably by the late 1970s. It is interesting that the carbon content of the urban aerosol was largely disregarded by investigators, except in Los Angeles smog, until

Table 1. Carbon balance for smog aerosol particles at different sites in the California South Coast Air Basin (data in $\mu\text{g}/\text{m}^3$)

Source	Dominguez Hills (10/5/73)	West Covina (7/24/73)	Pomona (9/6/73)	Rubidoux (9/6/73)
24-hour averages				
Motor vehicle exhaust and tire dust	1.63±0.06	5.62±0.23	3.02±0.12	2.17±0.31
Aircraft ^a	0.703±0.28	2.42±0.10	1.29±0.06	7.23±0.31
Industrial ^b	0.185±0.008	1.02±0.04	0.434±0.03	0.947±0.042
Agricultural	0	0	0	3.62±0.15
Sum-primary carbon	2.52±0.10	9.06±0.37	4.74±0.21	14.0±0.6
Total carbon	10.6±0.5 ^c	24.1±1.2 ^c	16.4±8 ^c	15.1±0.8 ^c
Secondary carbon ^f	8.08±0.51	15.0±3.0	11.7±0.8	1.10±1.00
Secondary organics ^g	12.1±0.8	22.5±2.0	17.7±2	1.65±0.8
Midday (1200–1400 hours)				
Motor vehicle exhaust and tire dust	1.92±0.087	5.83±0.24	4.54±0.17	2.24±0.89
Aircraft ^a	0.82±0.03	2.51±0.10	1.95±0.07	7.45±10.28
Industrial ^b	0.44±0.02	1.64±0.07	1.15±0.06	1.34±0.12
Agricultural ^a	0	0	0	5.37±0.22
Sum-primary carbon	3.18±0.13	9.99±0.41	7.64±0.30	16.4±1.4
Total carbon	19.6±1.4 ^e	47.6±2.4 ^d	39.8±2.0 ^d	20.7±1.5 ^e
Secondary carbon ^f	16.4±1.4	37.6±2.4	32.2±2.0	4.26±1.7
Secondary organics ^g	24.0±2.1	56.4±3.6	48.3±3.0	6.39±2.55

^a Assumed to be 100% carbon.

^b Assumed to be 19% carbon.

^c Determined for the particle less than 3–5 μm diameter; determined by conversion of C to CO_2 .

^d Total carbon conversion to CO_2 .

^e Scaled from flame ionization detector response.

^f By difference between total measured carbon and estimated primary carbon.

^g Assumes a relation between organic carbon and organic material of 1.5.

Note: Based on the California Aerosol Characterization Experiment (ACHEX) study (e.g., Hidy, 2006). For comparison, estimates include 24-hour averages and midday observations. The sites proceed from nominally upwind west to east from Dominguez Hills to (downwind) Rubidoux (adjacent to Riverside). Source: Adapted from Gartrell et al. (1980).

more than a decade later, when this fraction became widely important for fine particles concentration across the United States (McMurry et al., 2004). Gartrell and colleagues (1980) also reflected Friedlander's continuing interest in growth processes by using the ACHEX data to estimate the change in the particle volume-size distribution associated with growth of particles from chemical reactions or vapor condensation. From the continuous size distributions measured in the Los Angeles area, they demonstrated the strong growth of particles in photochemical smog from chemical conversion, inferred from the CMB calculations and the size distribution data in Figure 8. These results suggested the dominance of secondary particle formation processes in urban aerosol dynamics, under the aerometric conditions of the 1970s.

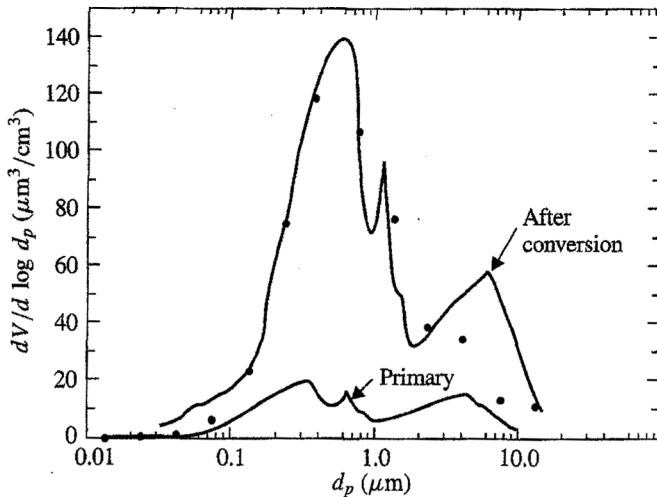

Figure 8. Volume (V)-size (diameter) distribution of primary particles estimated from material balance of Los Angeles aerosols, compared with secondary particles produced in photochemical smog during midday, October 1973.

Note: The secondary component was estimated from growth laws applied to secondary particle components (sulfate, nitrate, and carbon).

Source: Gartrell et al. (1980).

Later results reported by Turpin and Huntzicker (1995), for example, based on ambient data and emissions inventory data, showed substantially less secondary carbon formation in smog in the 1980s. For ACHEX, generally >70% secondary carbon is indicated in Table 1, whereas Turpin and Huntzicker and others reported <50% and as low as 10% secondary carbon

in Los Angeles conditions. The VOC emissions, presumed responsible for secondary particle production, may have changed composition during these two study periods, which may be a factor in the difference. The method used by Gartrell and colleagues (1980) also relied heavily on the primary particle emission inventory in the 1970s, which was probably in error, as were the data for VOC emissions. In any case, the Gartrell results strongly directed interest in the organic particle formation in smog aerosol as an important process in air pollution. This process has been studied extensively since the 1980s. Now the presence of primary and secondary organic carbon is widely recognized both in naturally occurring aerosols and in polluted air (McMurry et al., 2004).

Friedlander's interest in particulate organics took him into the area of carcinogens, represented by polycyclic aromatic hydrocarbons (PAHs) in urban air. His work with Antonio Miguel in exploring the (semivolatile) PAHs in Los Angeles led him to examine the distribution of the compounds with particle size (Venkataraman & Friedlander, 1994). These data are important for understanding the dose of PAHs that may reach the lower respiratory system in humans.

Public Health and Welfare

Although I have concentrated on the application of Friedlander's fundamental ideas to atmospheric aerosols and air pollution, his work has long been motivated by concerns for protection of human health and welfare. In addition to his work on air pollution, he investigated aspects of the deposition of particles in the human respiratory system and worked with other investigators in characterizing visibility impairment, both in the urban setting and in remote areas of the western United States. Advanced understanding of the mechanical aspects of particle deposition in the lungs as constructed from investigations of radioactive material entering the lungs provided an important link between the different modes of the ambient particle distributions and the penetration of particles sequentially into the upper and lower respiratory system. These results led to the development of a particle size-based mass concentration standard in 1987, revised in 1997 as the US National Ambient Air Quality Standard (US Environmental Protection Agency [EPA], 1996).

One of Friedlander's interesting health-related hypotheses concerned the influence of particles bearing peroxides on the human respiratory response to pollution (Friedlander & Yeh, 1998). Although this hypothesis is one of many currently of interest, it stands as a unique contribution from engineering science to the environmental medicine field.

The Ultrafine to Nanoparticle Regime

With the increasing interest in the ultrafine or the nanoparticle size range (<100 nm [0.10 μm] diameter) in the 1990s, Friedlander and his students began to investigate the properties of this extremely small material. These particle ranges have become of interest both in terms of rapidly expanding industrial applications, including the electronics industry, and in relevance to public health. In the latter case, recent studies have suggested the importance of the ambient nanoparticles for stimulating a respiratory response in humans. This hypothesis is of particular interest for combustion particles, especially those from internal combustion engines.

In any case, Friedlander began to investigate the properties of laboratory-generated nanoparticles, including refractory and crystalline materials. In addition, he explored the properties of finely divided combustion particles, identified in part as black or elemental carbon. Although these particles may be formed in the nanoparticle range during combustion or immediate entry from exhaust to the air, they can rapidly agglomerate to form chains or lumpy collections of the nanoparticles. Figure 9 shows an example of these agglomerates in comparison with apparent coalesced material. Friedlander and colleagues (1998) noted the distinction between coalesced, lumpy material composed of liquid and solid material (Figure 9a) and aggregates that form the more chain-like, loosely aggregated material (Figure 9b). The processes of agglomeration and coalescence depend on the properties of the mixed particle collections or on the surface properties of pure particles during their production. Molecular and cohesive or adhesive forces come into play, including Van der Waals forces, creating complex shapes of larger particles as they undergo change from initial formation by chemical reactions into larger particles by collision processes. This kind of research brought Friedlander from macroscopic theories of particle growth and coagulation into the world of the near-molecular processes and the application of principles from solid and liquid state physics, where a variety of potentially innovative "aerosol" engineering can be accomplished.

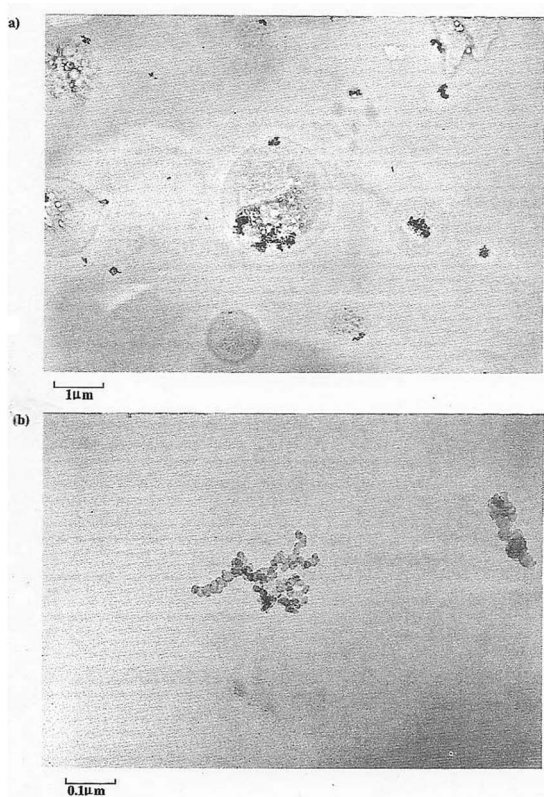

Figure 9. Electron micrographs of fine particles in the 0.1–1.0 μm diameter range, with combined solid and liquid features (a) compared with agglomerates of fine particles composed of chains of nanoparticles of ~10 nm (b).

Source: Friedlander (2000).
Reprinted with permission from
Oxford University Press.

Leadership, Mentoring, Interactions, and Teaching

Friedlander's role in mentoring and teaching represents an important part of his life in aerosol science and chemical engineering. Aside from his faculty contributions to intellectual life at Columbia's School of Engineering, the Johns Hopkins University, the California Institute of Technology, and, last but not least, the University of California, Los Angeles, he has guided or exchanged thoughts and ideas with researchers and students throughout the world of aerosols since the 1950s. Among the students who have benefited from Sheldon's wisdom are E. Avol, B. Dahneke, S. Ehrman, G. Gartrell, S. Heisler, S. Hering, G. Hidy, R. Husar, H. Jang, A. Kao, K. Keller, F. Lai, E. Macias, P. McMurry, A. Miguel, M. Miller, R. Pasceri, S. Pratsinis, P. Roberts, A. Stelson, D. Swift, C. Venkataraman, C. Wang, A. Weber, W. White, and many others. Many of these contemporaries have become well known in their own right. His connection with the health sciences is represented by the work of former students K. Keller, R. Pasceri, and D. Swift.

Among the colleagues that worked or interacted closely with Sheldon and mutually enriched their world of aerosols are D. Allen, P. Altshuller, J. Bricard, G. Cass, R. Charlson, J. Chow, W. Clark, F. Fissan, R. Flagan, N. Fuchs, A. Goetz, D. Grosjean, A. Haagen-Smit, J. Hales, G. Israel, C. Junge, M. Kerker, M. Lippmann, B. Y. H. Liu, J. Lodge, M. Madelaine, R. McClellan, P. Mueller, N. Nelson, J. Pich, W. Pierson, J. Pitts, O. Preining, D. Pui, J. Seinfeld, G. Sem, A. Serafin, K. Spurny, W. Stober, G. Sverdrup, J. Watson, K. Whitby, and W. Wilson. Just this partial list indicates well Sheldon's broad interest in challenging his colleagues and associates to address the many complexities of aerosol science and applications. These challenges have inspired the leaders and their students in aerosol science, in combination with new instruments and theories, to advance the state of knowledge farther in the last 50 years than centuries previously.

Friedlander's recognition and achievements are broadly known among his peers, including his election to the National Academy of Engineering and his many awards for scholarly excellence from the American Institute of Chemical Engineers, AAAR, and AAAR's international counterparts. Possibly best known is his public service as chairman of the Clean Air Science Advisory Committee in the 1980s and as an advisor to the National Institute of Environmental Health Sciences. Equally important was his key role in founding the AAAR and his subsequent organization of analogous international associations.

His commitment to cooperative science in aerosols was well exemplified early on with the Pasadena experiment in 1969, which provided pioneering data characterizing photochemical smog in Southern California (Hidy, 2006). This ad hoc summer campaign led to the ACHEX, in which he was a co-principal investigator. The ACHEX, sponsored by the California Air Resources Board, was one of the first, if not the first, major cooperative experiment addressing in the 1970s the characterization of natural baseline and air pollution aerosols, with focus on photochemical particle formation (Hidy et al., 1980; Hidy, 2011).

His sponsored research began in the 1950s with grants from the US Atomic Energy Commission and the National Science Foundation. Later, in the 1980s, Friedlander formed a center for environmental research at the University of California, Los Angeles, to create for EPA and other sponsors a vehicle for cooperative, multidisciplinary programs to address contemporary environmental issues in air quality, waste management, and environmental

risk assessment. His advocacy for innovation in aerosol science and technology continues today with international lectureships describing the field as the “enabling science and technology” for future applications of fine particles into the nano size range.

Conclusion

Sheldon Friedlander’s contributions to the knowledge about aerosol properties and dynamics, especially in relation to the fundamentals of particle deposition, formation, and growth processes, led more than 50 years of rapid progress in this field. The application of his work to environmental protection has led to pioneering insight into fine particles, with the goal of improving air quality. Friedlander’s continuing productivity as a researcher in engineering science showed a creativity and insight rare among his peers. In addition to his research contributions, he was an exceptional leader in his achievements as a mentor, educator, and advocate for aerosol science and technology. Until his death in 2007, his contributions and worldwide recognition among his colleagues ranked him as one of the greatest living aerosol scientists of our time.

References

- Chandrasekhar, S. (1954). Stochastic problems in physics and astronomy. In N. Wax (Ed.), *Selected papers on noise and stochastic processes* (pp. 3–91). New York, NY: Dover.
- Friedlander, S. K. (1960). Similarity considerations for the particle-size spectrum of coagulating-sedimenting aerosol. *Journal of Meteorology*, *17*, 479–483.
- Friedlander, S. K. (1967). Particle diffusion in low speed flows. *Journal of Colloid and Interface Science*, *23*, 157–164.
- Friedlander, S. K. (1973). Chemical element balances and identification of air pollution sources. *Environmental Science and Technology*, *7*, 235–240.
- Friedlander, S. K. (2000). *Smoke, dust, and haze: Fundamentals of aerosol dynamics* (2nd ed.). New York, NY: Oxford University Press.
- Friedlander, S. K., & Hidy, G. M. (1969). New concepts in aerosol size spectrum theory. In *Proceedings of the Seventh International Conference on Condensation and Ice Nuclei*. Prague: Czechoslovak Academy of Sciences.

- Friedlander, S. K., Jang, H. D., & Ryu, D. H. (1998). Elastic behavior of nanoparticle chain aggregates. *Applied Physics Letters*, 72, 173–176.
- Friedlander, S. K., & Johnstone, H. F. (1957). Deposition of suspended particles from turbulent gas streams. *Industrial and Engineering Chemistry Research*, 49, 1151–1156.
- Friedlander, S. K., & Pasceri, R. (1965). Measurement of particle size distributions of atmospheric aerosols. II. Experimental results and discussion. *Journal of the Atmospheric Sciences*, 22, 577–584.
- Friedlander, S. K., & Yeh, E. K. (1998). The submicron atmospheric aerosol as a carrier of reactive chemical species: Case of peroxides. *Applied Occupational and Environmental Hygiene*, 13, 416–420.
- Gartrell, G., Jr., Heisler, S. L., & Friedlander, S. K. (1980). Relating particulate properties to sources: The results of the California Aerosol Characterization Experiment. In G. M. Hidy (Ed.), *The character and origins of smog aerosols* (pp. 665–713). New York, NY: Wiley Interscience.
- Heisler, S. L., & Friedlander, S. K. (1977). Gas-to-particle conversion in photochemical smog: Growth laws and mechanisms for organics. *Atmospheric Environment*, 11, 158–168.
- Hering, S., & Friedlander, S. K. (1982). Origins of aerosol sulfur size distributions in the Los Angeles basin. *Atmospheric Environment*, 16, 2647–2656.
- Hidy, G. M. (1972). The dynamics of aerosols in the lower troposphere. In T. Mercer, P. Morrow, & W. Stober (Eds.), *Assessment of airborne particles: Fundamentals, applications, and implications to inhalation toxicology* (pp. 81–115). Springfield, IL: Charles C. Thomas.
- Hidy, G. M. (1986). Definition and characterization of suspended particles in ambient air. In S. T. Lee, T. Schneider, L. Grant, & P. J. Verkerk (Eds.), *Aerosols: Research, risk assessment and control strategies* (pp. 19–41). Chelsea, MI: Lewis.
- Hidy, G. M. (2011). Reminiscences about Pasadena, ACHEX, and beyond. In David S. Ensor (Ed.), *Aerosol Science and Technology: History and Reviews* (Chapter 8). Research Triangle Park, NC: RTI Press.

- Hidy, G. M., & Friedlander, S. K. (1970). The nature of Los Angeles aerosol. In H. England (Ed.), *Proceedings of the 2nd IUAAPA Clean Air Congress*. New York, NY: Academic Press.
- Hidy, G. M., Mueller, P. K., Grosjean, D., Appel, B. R., & Wesolowski, J. J. (1980). *The character and origins of smog aerosol* (pp. 1–17). New York, NY: Wiley Interscience.
- Junge, C. E. (1963). *Air chemistry and radioactivity*. New York, NY: Academic Press.
- Keith, C. H., & Derrick, J. E. (1960). Measurements of the particle size distribution and concentration of cigarette smoke by the “conifuge.” *Journal of Colloid Science*, 15, 340–347.
- Liu, B. Y. H., & Agarwal, J. K. (1974). Experimental observations of aerosol deposition in turbulent flow. *Journal of Aerosol Science*, 5, 145–148.
- McMurry, P., Shepherd, M., & Vickery, J. (Eds.). (2004). *Particulate matter science for policy makers: A NARSTO assessment*. Cambridge: Cambridge University Press.
- Pich, J., Friedlander, S. K., & Lai, F. S. (1970). The self preserving particle size distribution for coagulation in Brownian motion-III. Smoluchowski coagulation and simultaneous Maxwellian condensation. *Journal of Aerosol Science*, 1, 115–126.
- Turpin, B. J., & Huntzicker, J. J. (1995). Identification of secondary organic aerosol episodes and quantitation of primary and secondary organic aerosol concentrations during SCAQS. *Atmospheric Environment*, 29, 3527–3544.
- US Environmental Protection Agency. (1996). *Air quality criteria for particulate matter* (EPA/600/P95/001a, F, Vol. I–III). Research Triangle Park, NC: US Environmental Protection Agency, Office of Research and Development.
- Venkataraman, C., & Friedlander, S. K. (1994). Size distribution of polycyclic aromatic hydrocarbons and elemental carbon. 2. Ambient measurements and effects of atmospheric processes. *Environmental Science and Technology*, 28, 369–572.

Uncle Sasha

Alexandr Georgievich Sutugin (1940–1988)

Alexey A. Lushnikov

Introduction

Every aerosol scientist is familiar with the Fuchs-Sutugin formula and, of course, the first author, Nikolai Albertovich Fuchs. Yet, although the name of Alexandr Sutugin has appeared many times in western scientific journals, much less is known about the second author of this salient formula. This chapter is a fond memoir about this extraordinary personality and dear friend who passed away before his time at the early age of 48. To me and to his friends, he was simply Sasha or Uncle Sasha.

Sutugin was born in 1940 into a family of aviation engineers. I first met his family in about 1952, at which time his father still worked and his mother was entirely preoccupied with Sasha's two younger brothers. In 1956, he entered the Mendeleev Institute of Chemical Technology in the field of physical chemistry. He graduated in 1962 in engineering, with a specialization in isotope separation. For the remainder of his life he was affiliated with the Karpov Institute of Physical Chemistry, where he worked until his untimely passing in 1988. During his tenure, Sutugin served as the junior researcher (1962–1972), the senior researcher (1972–1974), and the head of the Laboratory of Dynamics of Aerocolloids (1974–1988). He authored more than 100 papers in peer-reviewed Soviet and international scientific journals (see the representative bibliography in the appendix to this chapter). In 1983, he received the State Award of the USSR. The portrait of Professor A.G. Sutugin is displayed in the lobby of the Karpov Institute among the most prominent scientists who worked there (see Figure 1).



Figure 1. Portrait of Professor Alexandr Georgievich Sutugin, which hangs in the lobby of Karpov Institute in Moscow.

Photo: Courtesy of the author.

Moscow: The Early Years

I first met Sasha in Moscow in 1950. At the age of 11, I had changed schools, and on the first day at my new school I noticed a very odd boy from another class. He dressed very carelessly and his hands were covered in burns from acids and soiled with ink, as ballpoint pens were strictly forbidden in our school. He seemed to always be the object of bullying from the other children, as they looked upon him with disfavor and as a black sheep.

A few years later, we attended the same class and immediately became friends, our common bond being our mutual curiosity about science. Sasha also took a special interest in chemistry. Although I was familiar with this subject within the framework of the school chemistry curriculum, I never suspected that chemical experiments could be so fascinating and exciting. I immediately joined him and we spent untold hours hovering over our test tubes.

As time passed and we grew older, our other interests developed. For instance, I remember very clearly our passion for jazz. In the 1960s, jazz was entirely forbidden in the USSR and all foreign radio stations broadcasting jazz were jammed. The Soviet jamming stations operated at longer waves because Soviet radio receivers had a short wavelength range beginning from 25 m. Fortunately, we had receivers that were able to tune to very short waves, below 25 m. We shared our impressions about jazz performances when we met at school. And we were not alone, as almost all of our friends also were jazz enthusiasts.

Overall, our coursework did not seem particularly difficult or challenging for us, and we did not spend much time studying. But closer to the end of our schooling, we began to prepare for entrance to the Institutes. Sasha decided to enter the Mendeleev Institute of Chemical Technology, in Physical Chemistry. I, in turn, decided to become a radio engineer and enter the Moscow Energy Institute.

We successfully passed our final examinations, although we were not awarded scholastic medals. Our teachers said that it would not be a problem for us to pass the Institutes' entrance examinations. Indeed, we passed on our first attempt and became students there. I entered the Moscow Engineering–Physical Institute in Theoretical and Experimental Physics. For the first time after 4 years of a very close friendship, we were separated. But soon thereafter, all of my new Institute friends also became good friends with Sasha, and we again spent much of our spare time together.

The Laboratory for Physics of Aerodispersed Systems

After completing his education, Sasha worked on radiation damage in semiconductors under the guidance of Dr. Vladimir Shokin. In 1960, Professor N. A. Fuchs invited V. Shokin to work in the Laboratory for Physics of Aerodispersed Systems (LPhAS) at the Karpov Institute of Physical Chemistry. This laboratory was in the early organizational stage, and new junior researchers were badly needed. It was not surprising that on graduating from the Mendeleev Institute in 1962 that Sasha found work here.

At about the same time, I became a member of Sector 10 in the Department of Nuclear Physics of Kurchatov Institute of Atomic Energy. Of course, aerosol science was a far cry from my interests, but I still greatly enjoyed discussing aerosol science, especially because the tiniest aerosol particles have much in common with atomic nuclei. At that time, I had no thoughts of becoming an aerosol scientist.

Not often, but still from time to time, I visited Sasha's laboratory, where I was welcomed as a dear guest. My hosts always organized a table where we sat, drank, snacked, and of course, had heated discussions about aerosol physics. I vividly remember our informal debates on the kinetics of nucleation, the Lothe-Pound correction to the formula for the nucleation rate. This was very engaging and thought provoking for me, because the problems with rotation and translation states in atomic nuclei also arise in nuclear physics. During these earlier years in the lab, Sasha's group comprised two people, E. I. Kotzev and P. Zhibankov, a junior researcher and the lab assistant, respectively (see Figure 2).



Figure 2. Sasha's group at the Laboratory for Physics of Aerodispersed Systems—Sutugin (center), E. I. Kotzev (left), and P. Zhibankov (right). Photo: Courtesy of the author.

In the summer of 1970, Sasha recommended me for a job in LPhAS, which at that time was headed by Professor N. A. Fuchs. There were many good reasons to accept this offer, and I decided to make the leap from a theorist to an experimenter.

Working Together

In March 1971, I had a couple of meetings with Professor Fuchs, and on March 29, 1971, I was accepted as a junior researcher in this famous laboratory. Since that day, I have been actively involved with aerosols.

The first thing that struck me about the laboratory was the extremely modest assortment of experimental equipment. As a nuclear physicist, I was accustomed to huge accelerators occupying whole buildings, plenty of support personnel, and heaps of auxiliary equipment. Here, I saw only simple quartz tube aerosol generators, a set of diffusion batteries for size distribution analysis of highly dispersed aerosols, and a turbulent particle size magnifier (known by the name KUST [Condensational Magnifier of Standard Mists] and invented by Professor Ya. I. Kogan). We also had access to an electron microscope located elsewhere in the building. At the time, Sasha was studying the properties of highly dispersed metallic aerosol particles, specifically investigating the kinetics of the initial stages of coagulation. I helped him as much as I could.

I remember very clearly how we decided to conduct mass spectrometry experiments together with a colleague from a neighboring laboratory. One day, we carried a couple of ampoules of $\text{Ni}(\text{CO})_4$ —nickel tetracarbonyl, an extremely toxic and highly volatile substance—to our laboratory and we put the chemical into the safe. The next morning, we discovered in horror that one of the ampoules was cracked. We evacuated all the staff, put the ampoule into a vessel filled with water, and then did not know what to do. To tell our administrators the truth would be to risk our careers, so we decided to crack the ampoule open in the Institute's yard. A huge cloud of bluish smoke enveloped the yard, but no one ever found out where it came from.

In early 1972, Sasha suggested that I construct a downward diffusion chamber for nucleation experiments. He introduced me to the details of the current state of the science in this area, and it seemed to me a very interesting and active area of research. I decided to test my abilities as an engineer and construct the apparatus.

The static diffusion chamber contains two parallel plates heated to different temperatures. Normally (the upward geometry), the lower plate is hot and covered with the working liquid. The upper plate is cold. The liquid evaporates from the lower plate and diffusion of vapor creates a supersaturation in the central zone of the chamber. The vapor begins to nucleate in this nucleation layer. Its position (the height from the lower plate) allows one to measure the critical supersaturation (the supersaturation at which the nucleation produces one particle per second in a cm^3). In the downward diffusion chamber, the hot plate forms the ceiling of the chamber. This geometry is preferable because it allows straightforward measurements of the nucleation rate.

Huge difficulties arose immediately because we decided in favor of the downward geometry. We needed to create a thermoconducting ceiling that, in addition, should be able to hold the working liquid. The ideal material for construction was copper powder. We bought approximately 100 kg of copper powder (0.3 mm in diameter) and began to look for a facility where we could sinter a giant flat disk, 500 mm in diameter and 5 mm thick. We found that nobody could fabricate such a thing, so we decided to make this disk ourselves.

We constructed a special furnace that consumed all the electricity in the building, and ordered a press-form made out of stainless steel. According to our estimates, the whole process should take about 8 hours. We were permitted to work at night in the Institute's backyard.

The first attempt yielded an absolute monster, nothing like a ceiling of a serious scientific instrument; just a puddle of copper. To this day, it is still displayed in our lab. Much to our surprise, our next attempt was successful. Then we decided to greatly modify the process. The main difficulty was how to uniformly fill our press-form with the copper powder. We accomplished this by wetting the powder with hydrazine (N_2H_4), which also prevented oxidation of the copper powder from the very beginning of the sintering process. We initially processed the disk in an inert atmosphere of helium. Then we replaced helium with much more cost-effective hydrogen, although we did not tell anybody, as everyone would understand how dangerous using hydrogen could be.

By the beginning of 1973, the diffusion chamber was ready (see Figure 3). We named it "Tetya Lyuda" (or Aunt Lyuda). The first experiments produced very interesting and promising results. We worked with isopropanol and water. The molecular diffusion supersaturated the vapors and, as expected,

a very distinct thin nucleation layer formed between heated and cooled plates. The rain of droplets from the layer settled between the plates. A photoelectric counter allowed us to count the number of droplets crossing a given area at a time. From these data, we were able to obtain the nucleation rate.

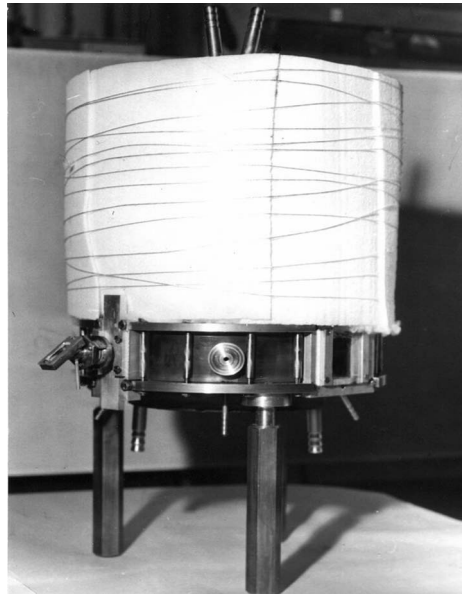

Figure 3. “Tetya Lyuda,” our static diffusion chamber.

Photo: Courtesy of the author.

Laboratory for Dynamics of Aerocolloids

Around this time, after a trifling quarrel, Fuchs decided to dismiss Sasha. I recall that it happened during the stifling hot summer of 1972, when almost no one worked in the lab. One day, Sasha, myself, and our colleague from the neighboring lab decided to play cards. At that moment, unexpectedly, Fuchs decided to visit the Institute and our office. The door was locked, Fuchs knocked once, twice, and more and more insistently. At last Sasha opened the door. Fuchs became furious and fully displayed his irritation. Unfortunately, Sasha responded in kind. The outcome was not good. Sasha moved to the neighboring laboratory, the Laboratory for Aerosols, headed by Academician I. V. Petryanov-Sokolov, who decided to save him from dismissal from the Institute.

From that moment onward, our lives changed abruptly. I began to notice that more and more often Sasha appeared in a good suit and tie, which was absolutely out of character for him. He did not share the reasons for these changes with me; and I remained, alone, with our Tetya Lyuda. Within a few months, the hidden truth became evident. Together with Petryanov-Sokolov (who was the head of our Aerosol Department) and with my chief, Prof. N. A. Fuchs, Sasha had made numerous visits to the Central Committee

of the Communist Party of the USSR and our Government. They had suggested that there should be a new emphasis on the application of aerosols for military purposes. The military application of aerosols has a long history, but now it included some very modern aspects, such as protection against strong lasers, strong radiation from nuclear explosions, and protection of military operations from modern tools of pointing.

At the end of 1973, the Central Committee of the Communist Party and the Council of Ministers issued a special decree; and in early 1974, Sasha became the head of a large organization named the Laboratory for the Dynamics of Aerocolloids. The origin of this name is apparent from the title of J. M. Hidy and J. R. Brock's book *The Dynamics of Aerocolloids*.

The new laboratory entirely consumed Sasha's time and our diffusion chamber was put aside. Although I tried to continue the experiments, my attempts to develop a theory to support these experiments were unsuccessful; I also abandoned Tetya Lyuda. One of our doctoral students worked with it for several years, but without any real success.

The Fuchs-Sutugin Formula

I came to the Karpov Institute shortly after the creation of the Fuchs-Sutugin formula. But to my great surprise, I heard almost nothing about this equation. Before entering the Karpov Institute, Sasha explained to me the basic principles of the derivation of this formula. He simply used the old Fuchs theory of condensation-evaporation in the transition regime and fitted the parameters using the numerical solution to the kinetic equation obtained by D. C. Sahni in 1966. It was a very good idea, of course. But more unexpected was the success of this formula to explain experimental data on condensation-evaporation processes. Fuchs characterized this formula as the main achievement of his life.

The formula connects the flows J_c and J_{tr} of a condensing vapor toward a cool surface (outward in the case of evaporation) in the continuum and in the transition regimes (subscripts c and tr , respectively),

$$J_{tr} = J_c \frac{1 + Kn}{1 + 1.71Kn + 1.33Kn^2} \quad (1)$$

Here, Kn is the Knudsen number equal to the ratio of the mean free path of condensing molecules in the carrier gas to the particle size.

Other Achievements

Although this formula can be seen as the pinnacle of Sasha's achievements, he also had numerous other significant achievements. For instance, he was the first to invent and use kinetic nucleation, which is very popular nowadays among specialists in atmospheric aerosols. He originated a term, "nucleation of rapid type," for this mechanism of particle formation. This mechanism included slow formation of very small embryos and their subsequent swift coagulation. He applied this concept to the formation of tiny metallic particles. This topic was very popular in our department, although nanoscience and nanotechnology did not yet exist.

In December 1976, Sasha defended his doctoral dissertation entitled "Nucleation of Rapid Type." Although he was wary of two members of his dissertation committee, academician B. V. Deryagin and Prof N. N. Tunitskii (the older generation of aerosol scientists will likely remember these names), his defense was very successful. For reasons that are not clear, both of these individuals were Sasha's personal adversaries.

Sasha had a talent for spoiling relationships with his colleagues, and especially with the higher ups. He had an absolutely intolerable character and only those who knew him very well remained his friends. He often had conflicts even with me, but these never lasted for long. The main reason for our conflict was his secret aerosol work. I tried to avoid this sort of work. I hated all the secrecy around it; but, to my surprise and dismay, Sasha seemed to relish it. He was enamored of big teams working under field conditions and military men. Although it was not easy to become a member of the Communist Party at that time, Sasha had plenty of friends among the Party members. However, he was severely limited because he never became a member of the Communist Party. In principle, he never shared the communist convictions, but his association with the Party members was undeniable. Nor did he maintain regular contact with the Party bosses; in fact, he very often offended them.

In any case, his quarrelsome character did not hinder his advancement in his military activity. He created a huge laboratory, where he was the commonly recognized leader. Evidently he accomplished a great deal, and together with a number of other scientists involved in this activity, he was given the State Award of the USSR.

In spite of being very busy with his military projects, Sasha still found time for pure science. For example, he tried to construct numerical models of the process of rapid nucleation. Because of the lack of adequate computers, this was very difficult to do in the 1970s. Nonetheless, he continued to work with a mathematician from our Institute and they published regularly. He also constructed numerical models of nonstationary nucleation in a turbulent jet, and headed an experimental group that performed the experiments with jets and with our Tetya Lyuda.

Together with his colleagues, he studied the formation of aerosol particles in spatially inhomogeneous conditions. The theory that Sasha developed was applied to the explanation of the results obtained in his laboratory experiments with turbulent jets of low volatile vapors of dibutyl phthalate and dioctyl sebacate. This theory was extremely complex and required the application of computers, which at that time were far from reliable. Still, he was successful and his results were applied by his colleagues for constructing practical devices for military purposes.

He also devoted time to the popularization of aerosol science, as there was no specialty discipline of “Aerosol Science” in the USSR. Together with academician I. V. Petryanov-Sokolov, he spent considerable effort organizing an Institute for Aerosols and introducing the discipline of “Aerosols” at the State University and Mendeleev Institute for Chemical Technology. Unfortunately, their efforts were not successful.

From the very beginning of his career as a head of the laboratory, Sasha sat in the so-called “kinobudka.” This was a side room from where it was possible to project movies in a big conference hall located behind a wall. He invited me to share this room with him, and I worked for nearly 10 years in the kinobudka with him. Only in 1984, after a quarrel (once again, he tried to press me to work on secret projects), did I decide to move out; but still our close friendship endured.

We frequently participated in the aerosol conferences organized in our country. Although they were more modest than conferences now at the international level, I recall these meetings with great pleasure. The main difference between the more sedate conferences held in the West and our conferences at that time was the sharp discussion and ruthless open criticism of the papers presented. Of course, in this respect, Sasha was a leader.

Vacations

Aside from his intense devotion to his work, Sasha was an avid fisherman. We always spent our summers together and our main hobby was skin diving and fishing with a spear gun. Although we did not have special equipment, our spear guns functioned perfectly. I can boast that I constructed them myself. And we swam in warm seas. We visited the Aral Sea (when it was still alive); both shores of the Caspian Sea; the Kara–Bogaz–Gol, the saltiest gulf in Russia; and of course the Black Sea. We especially liked to hunt for grey mullets and Sasha loved to sell our catch; not all of it, of course. Figure 4 shows Sasha and me in Betta on the beach of the Black Sea.

Sasha also loved hunting mushrooms, and we thoroughly scavenged all of the forests around Moscow. He was very successful at finding them, despite the fact that he wore rather strong glasses.



Figure 4. Sasha (right) and author (left) in Betta on the beach of the Black Sea.

Photo: Courtesy of the author.

Epilogue

Sasha, of course, dreamed of advancing his career, and he did so with considerable success. In particular, he used politics in an effort to be elected as a corresponding member of Academy of Sciences of the USSR. After two attempts he was almost elected. All of us were absolutely certain that he would

be successful on the third attempt. Unfortunately, fate intervened, and on April 29, 1988, he fell victim to a serious traffic accident.

Sadly, I remember this day very well. It was right before the celebration of the First of May. We had planned to meet at the Institute, but I had no time to visit. It was a snowy day, the weather was extremely unpleasant, and I had to rush to a train. So I missed seeing him. After the accident, he was hospitalized for 3 months, and I visited him often. He passed away on August 1, 1988, an enormous loss for all of his friends and the world of science.

Of interest is the origin of the name “Uncle.” All of our friends and colleagues called (and still call) each other “Uncle”—except for Fuchs and Petryanov. For example, I am Uncle Lesha at the Karpov Institute. We called Fuchs “Fushe-Karpov” and somebody once sent an envelope to Fuchs addressed to “Fushe-Karpov.” Petryanov was called “Th Prevoshoditel’stvo” (His Excellence) and Sasha was the “Adjutant of His Excellence,” which was the title of a popular television program at that time.

Appendix

Main Publications of A. G. Sutugin

A. G. Sutugin's significant contributions to aerosol science are indisputable, and they met with wide international recognition, especially his earlier work with his teacher, N. A. Fuchs. The main body of his scientific work includes the study of the mechanisms of formation and evolution of highly dispersed aerosols and the development of the methods of aerosol generation. He was a pioneer in the generation of nanometer aerosols. His simple aerosol generators are still used in many laboratories. Sutugin's general model of condensation in spatially nonuniform flows was successfully applied in constructing aerosol generators. He developed a new classification of processes of homogeneous nucleation and introduced the notion of rapid nucleation, where the collision kinetics limits the nucleation rate rather than the thermodynamic barrier. In 1974, he organized the Laboratory for Dynamics of Aerocolloids at Karpov Institute of Physical Chemistry (Moscow), where he and the members of his lab developed new methods for generating aerosols with given physical and chemical properties. In 1982, these collective achievements resulted in him winning the State Award of the USSR.

Sutugin authored nearly 190 articles, including one monograph and several reviews. Most of his publications appeared in Soviet scientific journals. Although some of them were translated into English, they are not easily accessible. The chronological bibliographic list presented below suggests the broad direction and scale of Sutugin's contributions to aerosol science and includes his two dissertations. I have endeavored to interpret the titles of Russian papers myself (as well as the names of the journals). (Rus) means that the respective paper is in Russian. The source list for these publications was provided to me by Dr. V. M. Minashkin, the present head of the Laboratory for Dynamics of Aerocolloids.

Bibliography

- Fuchs, N. A., & Sutugin, A. G. (1963). Generation and investigation of high dispersed aerosols. *British Journal of Applied Physics*, 14(1), 39.
- Fuchs, N. A., & Sutugin, A. G. (1963). Size distribution of droplets in nucleated dibutylphtalate mists. *Kolloidnyi Zhurnal (Rus)*, 25, 48.
- Fuchs, N. A., & Sutugin, A. G. (1964). Highly dispersed aerosols. *Kolloidnyi Zhurnal (Rus)*, 26, 110.
- Fuchs, N. A., & Sutugin, A. G. (1965). Coagulation rate of the highly dispersed aerosols. *Journal of Colloid Science*, 20, 492.
- Fuchs, N. A., & Sutugin, A. G. (1966). On the coagulation constant of highly dispersed aerosols. *Kolloidnyi Zhurnal (Rus)*, 48, 131.
- Fuchs, N. A., & Sutugin, A. G. (1966). Production and use of monodispersed aerosols. In C. N. Davies (Ed.), *Aerosol science*. London, England: Academic Press.
- Fuchs, N. A., & Sutugin, A. G. (1968). Highly dispersed aerosols. *Uspekhi Khimicheskikh Nauk (Sov Chem Uspechi) (Rus)*, 37, 1964.
- Fuchs, N. A., & Sutugin, A. G. (1968). Formation of highly dispersed aerosols at high supersaturations. *Journal of Applied Mechanics and Technical Physics (Rus)*, 3, 138.
- Sutugin, A. G., & Fuchs, N. A. (1968). Formation of condensation aerosols at high supersaturation. *Journal of Colloid and Interface Science*, 27(2), 216.
- Fuchs, N. A., & Sutugin, A. G. (1969). *Highly dispersed aerosols*. Moscow, Russia: Nauka.
- Fuchs, N. A., & Sutugin, A. G. (1969). On production of highly dispersed powders via aerosols. *Journal of Applied Chemistry (Rus)*, 42, 567.
- Fuchs, N. A., & Sutugin, A. G. (1970). Formation of highly dispersed aerosols under rapidly changing conditions. *Kolloidnyi Zhurnal (Rus)*, 32, 255.
- Fuchs, N. A., & Sutugin, A. G. (1970). Formation of condensation aerosols under rapidly changing environmental conditions. I. Theory and method of calculation. *Journal of Aerosol Science*, 1(4), 287.
- Fuchs, N. A., & Sutugin, A. G. (1971). Formation of condensation aerosols at rapidly changing environmental conditions. II. Non-coagulated highly dispersed aerosols. *Journal of Aerosol Science*, 2, 37.

- Fuchs, N. A., Sutugin, A. G., & Kotzev, E. I. (1971) Formation of condensational aerosols. Non-coagulated highly dispersed aerosols. *Kolloidnyi Zhurnal (Rus)*, 33, 583.
- Fuchs, N. A., & Sutugin, A. G. (1971). On the size dependence of the condensation coefficients. *Journal of Statistical Physics*, 1, 91.
- Fuchs, N. A., & Sutugin, A. G. (1971). Highly dispersed aerosols. In J. M. Hidy & J. R. Brock (Eds.), *Topics in current aerosol research. Part II*. New York, NY: Pergamon Press.
- Fuchs, N. A., Sutugin, A. G., & Kotsev, E. I. (1976). Engineering methods of calculation of spontaneous condensation. *Theoretical Grounds of Chemical Technology (Rus)*, 10, 406.
- Lushnikov, A. A., & Sutugin, A. G. (1976). Modern state of theory of homogeneous nucleation. *Uspekhi Khimicheskikh Nauk (Sov Chem Uspechi) (Rus)*, 45, 385.
- Sutugin, A. G. (1965). Production of monodispersed aerosols di-iso-octyl-sebacate with the particle sizes 3–30 nm. *Kolloidnyi Zhurnal (Rus)*, 47, 285.
- Sutugin, A. G. (1965). Monodispersed aerosols. *Uspekhi Khimicheskikh Nauk (Sov Chem Uspechi) (Rus)*, 34, 276.
- Sutugin, A. G. (1966). Coagulation constants of aerosols at Knudsed numbers of order unity. *Kolloidnyi Zhurnal (Rus)*, 48, 235.
- Sutugin, A. G. (1967). Studies of highly dispersed aerosols. Candidate dissertation. Defended at Karpov Institute of Physical Chemistry, Moscow, Russia.
- Sutugin, A. G. (1969). Spontaneous condensation and formation of highly dispersed aerosols. *Uspekhi Khimicheskikh Nauk (Sov Chem Uspechi) (Rus)*, 38, 166.
- Sutugin, A. G. (1969). Behavior of aerosols formed by clustering of molecules around ions. *Atmospheric Environment*, 3, 697.
- Sutugin, A. G. (1970). On discrepancies between theories and experiments on spontaneous nucleation. *Journal of Physical Chemistry (Rus)*, 44, 2396.
- Sutugin, A. G. (1970). On the theory of spontaneous formation of embryos in vapors. *Kolloidnyi Zhurnal (Rus)*, 52, 627.

- Sutugin, A. G., & Kotsev, E. I. (1970). Production of highly dispersed metal and oxide powders. *Base Metals (Rus)*, 4, 43.
- Sutugin, A. G. (1970). On the theory of spontaneous formation of embryos in vapors. *Kolloidnyi Zhurnal (Rus)*, 56, 160.
- Sutugin, A. G., & Bashkirov, A. G. (1971). On the classical nucleation theory reconsideration. *Journal of Statistical Physics*, 3, 87.
- Sutugin, A. G. (1971). Influence of non-retarded forces on coagulation of highly dispersed Aerosols. *Doklady Akademii Nauk SSSR (Sov Phys Doklady) (Rus)*, 201, 647.
- Sutugin, A. G. (1972). On the discussion of the classical theory of the embryos formation. *Journal of Physical Chemistry (Rus)*, 56, 160.
- Sutugin, A. G. (1976). Rapid condensation processes and formation of highly dispersed aerosols. Doctoral dissertation. Defended at Karpov Institute of Physical Chemistry, Moscow, Russia.
- Sutugin, A. G., Lushnikov, A. A., & Tchernyaeva, G. A. (1973). Bimodal size distribution in highly dispersed aerosols. *Kolloidnyi Zhurnal (Rus)*, 36, 923.
- Sutugin, A. G., Lushnikov, A. A., Tchernyaeva, G. A., & Petryanov, I. V. (1973). Sampling of submicron aerosols for electron microscopy. *Industrial and Sanitary Cleaning of Gases (Rus)*, 4.
- Sutugin, A. G., Lushnikov, A. A., & Chernyaeva, G. A. (1973). Bimodal size distribution in highly dispersed aerosols. *Journal of Aerosol Science*, 6, 295.
- Sutugin, A. G., & Lushnikov, A. A. (1974). On the mechanism of formation of highly dispersed aerosols from nonorganic vapors, *Kolloidnyi Zhurnal (Rus)*, 37, 306.
- Sutugin, A. G., & Lushnikov, A. A. (1974). Influence of molecular forces on coagulation of highly dispersed aerosols: Additive retarded and non-additive non-retarded interactions. *Kolloidnyi Zhurnal (Rus)*, 37, 568.
- Sutugin, A. G., & Lushnikov, A. A. (1974). On spontaneous condensation in turbulent flows. *Theoretical Grounds of Chemical Technology (Rus)*, 8, 608.
- Sutugin, A. G., Lushnikov, A. A., & Zagaynov, V. A. (1974). On possible role of contaminations in the experiments on spontaneous nucleation. *Kolloidnyi Zhurnal (Rus)*, 56, 550.

- Sutugin, A. G., & Lushnikov, A. A. (1975). On modeling the coagulation processes in highly dispersed aerosols. *Theoretical Grounds of Chemical Technology (Rus)*, 9, 210.
- Sutugin, A. G., Zagaynov, V. A., Lushnikov, A. A., & Petryanov, I. V. (1975). Sticking probability of molecular aerosol to solid surfaces *Doklady Akademii Nauk SSSR (Sov Phys Doklady) (Rus)*, 221, 267.
- Sutugin, A. G., Kotsev, E. I., & Simonov, A. J. (1975). On the nature of the dependence of the condensational efficiency on the sizes of embryos of new phase. *Kolloidnyi Zhurnal (Rus)*, 57, 312.
- Sutugin, A. G., & Grimberg, A. N. (1975). Condensation of metal vapors in cooling the turbulent jet. *Thermophysics of High Temperatures (Rus)*, 13, 787.
- Sutugin, A. G., & Grimberg, A. N. (1975). Self-preserving aerosol particle size distributions in coagulating free molecule aerosol. *Physics of Atmosphere and Ocean (Rus)*, 9, 956.
- Sutugin, A. G., & Grimberg, A. N. (1976). Condensation of the metal vapor in a free turbulent jet. *Journal of Heat and Mass Transfer*, 18, 743.
- Sutugin, A. G., Petryanov, I. V., Lushnikov, A. A., & Zagaynov, V. A. (1976). On the sticking probability of the molecular cluster to solid surfaces, *Journal of Aerosol Science*, 7, 295.
- Sutugin, A. G., & Grimberg, A. N. (1976). Quasi two-dimensional description of the condensation in a free turbulent jet. *Journal of Aerosol Science*, 7(6), 447–456.
- Sutugin, A. G., & Kotsev, E. I. (1977). Prediction of the dispersity of solid aerosol particles of condensational origin. *Engineering-Physical Journal (Rus)*, 32, 540.
- Lushnikov, A. A., Zagaynov, V. A., & Sutugin, A. G. (1977). On the boundary conditions to the diffusion equation. *Chemical Physics Letters*, 47(3), 578.
- Sutugin, A. G., & Zagaynov, V. A. (1978). Nucleation of silver vapor on molecular clusters. *Doklady Akademii Nauk SSSR (Sov Phys Doklady) (Rus)*, 238, 1377.
- Sutugin, A. G., Puchkov, A. S., & Lushnikov, A. A. (1978). Spontaneous condensation in a free turbulent jet. *Kolloidnyi Zhurnal (Rus)*, 60, 285.

- Sutugin, A. G. (1978). A new principle of classification of the processes of spontaneous condensation. *Kolloidnyi Zhurnal (Rus)*, 60, 1017.
- Sutugin, A. G., & Grimberg, A. N. (1980). Inverse relaxation of homogeneous nucleation after the depletion of supersaturation. *Kolloidnyi Zhurnal (Rus)*, 62, 1025.
- Sutugin, A. G., Khudyakov, S. V., & Puchev A. V. (1980). Frequency-contrast characteristics of weakly scattering layer. *Physics of Atmosphere and Ocean (Rus)*, 16, 759.
- Sutugin, A. G., & Tokar', Ya. I. (1980). A model of formation of the dispersed phase due to non-stationary condensation in turbulent jet. *Physics and Chemistry of Material Processing (Rus)*, 4, 103.
- Sutugin, A. G., Alexandrov, V. A., & Ivanitskii, V. V. (1980). On the mechanism of early stages of homogeneous condensation of metal vapors. *Physics and Chemistry of Material Processing (Rus)*, 3, 113.
- Sutugin, A. G., Grimberg, A. N., & Puchkov, A. S. (1981). Modeling the formation of dispersed phase in the processes of nucleation of intermediate type. *Theoretical Grounds of Chemical Technology (Rus)*, 15, 520.
- Sutugin, A. G., & Senkovenko, S. A. (1981). On the method of measurement the particle number concentration in two phase flows. *Journal of Engineering Physics (Rus)*, 40, 249.
- Sutugin, A. G., Grimberg, A. N., & Puchkov, A. S. (1981). The multistage kinetics of the transient type nucleation in a free turbulent jet. *Journal of Aerosol Science*, 12, 1025.
- Sutugin, A. G. (1982). An attempt of classification and systematization of aerosols. *Kolloidnyi Zhurnal (Rus)*, 64, 513.
- Sutugin, A. G., Aizotullin, S. K., Zaslono, I. S., & Smirnov, V. N. (1983). A study of condensation of the iron vapor in decay of $\text{Fe}(\text{CO})_3$ in shock waves. *Chemical Physics (Rus)*, 4, 851.
- Sutugin, A. G., Aleksandrov, V. A., & Ivanitskii, V. V. (1983). On micro-kinetic methods of modeling and evolution of condensational aerosols. *Kolloidnyi Zhurnal (Rus)*, 65, 737.
- Sutugin, A. G., & Tokar', Ya. I. (1983). Formation of condensational aerosols in spatially non-uniform systems. *Kolloidnyi Zhurnal (Rus)*, 65, 341.

- Sutugin, A. G., & Petryanov, I. V. (1984). On the existence of negative thermophoresis. *Kolloidnyi Zhurnal (Rus)*, 66, 160.
- Sutugin, A. G., Aleksandrov, V. A., & Ivanitskii, V. V. (1984). Modeling the particle size distribution of coagulating highly dispersed aerosols in the atmosphere. *Physics of Atmosphere and Ocean (Rus)*, 20, 1165.
- Sutugin, A. G., Aleksandrov, V. A., & Ivanitskii, V.V. (1984). Evolution of particle size distribution of coagulating products of a chemical reaction. *Kolloidnyi Zhurnal (Rus)*, 66, 627.
- Sutugin, A. G., Petryanov, I. V., Minashkin, V. M., & Chistyakova, I. V. (1984). On a mechanism of formation of chemo-condensational aerosols, *Kolloidnyi Zhurnal (Rus)*, 66, 63.
- Sutugin, A. G., & Grimberg, A. N. (1984). Nucleation in systems with changing temperature and concentration. *Journal of Colloid Interface Science*, 98, 239.
- Sutugin, A. G., Lushnikov, A. A., Simonov, A. J., & Maximenko, V. V. (1984). Scattering of electromagnetic waves by charged particles. *Radiophysics (Rus)* 27, 726.
- Sutugin, A. G., & Tokar, Ya. I. (1985). Formation of condensational aerosols in spatially non-uniform systems, *Kolloidnyi Zhurnal (Rus)*, 67, 341.
- Sutugin, A. G. (1986). Aerosol. In *The Soviet Encyclopedia, Moscow*.
- Sutugin, A. G., Lipatov, G. N., & Grinshpun, S. A. (1986). Aspiration of coarse aerosols. *Journal of Aerosol Science*, 17, 763.
- Sutugin, A. G., Lipatov, G. N., Grinshpun, S. A., & Shingarev, G. N. (1987). Aspiration of coarse aerosols in thin wall cylinder samplers. *Physics of Atmosphere and Ocean (Rus)*, 23, 320.
- Sutugin, A. G. (1987). Brownian coagulation in the systems with changing concentration of dispersed phase. *Doklady Akademii Nauk SSSR (Sov Phys Doklady) (Rus)*, 227, 133.

John A. McClelland

The Scientific Work and Legacy of a Physics Pioneer (1870–1920)

Thomas C. O'Connor

Introduction

John Alexander McClelland, FRS¹ (1870–1920) is remembered principally in the history of aerosol science for his pioneering work on the measurement of the mobility of ions in gases. As the professor of physics at University College Dublin from 1900 to 1920, McClelland also was an important figure in the development of science in Ireland, especially in experimental physics. Through the research school he established, he left a fruitful legacy of research on aerosols in Ireland that continues to the present day.

In 2005, the manuscript of an address entitled “The Scientific Work of the Late Professor M’Clelland” by John J. Nolan—who succeeded McClelland as the professor of physics in 1920—came to light and is of special interest to historians of science. (The address is reproduced in full, as a transcript, in Appendix A.) Nolan delivered this address as his inaugural lecture as president of the student Scientific Society at University College Dublin in 1920.

Although it includes a brief biography of McClelland, the address focuses primarily on McClelland’s sterling, but tragically brief, academic career. The document is historically valuable as a nontechnical summary of McClelland’s research achievements as seen through the eyes of an accomplished physicist who collaborated in much of McClelland’s work and viewed it in light of

¹ Founded in 1660, the Royal Society is the national academy of sciences of the United Kingdom. Fellows of the Royal Society (FRS) are elected to the Royal Society by their peers who consider them to have made “a substantial contribution to the improvement of natural knowledge including mathematics, engineering science and medical science.” The main criterion for election as a Fellow is scientific excellence.

the physics of the time. It also conveys Nolan's enthusiasm for his subject, his efforts to inspire students to appreciate the craft of research, and the excitement generated by the "new" physics emerging from the Cavendish Laboratory at Cambridge and elsewhere in the early 20th century. The address also provides a valuable assessment of McClelland as a teacher, as an administrator, as a leader in research, as a public servant on governmental committees and academic bodies, and as a person.

The influence of McClelland's work on the subsequent development of physics in Ireland, and on the physics of atmospheric aerosols in particular, was profound and long lasting. His scientific descendants continue to enhance the legacy of his life and work into the 21st century.

A Brief History of University Education in Ireland

Established in 1592, Trinity College of the University of Dublin continues as an independent university to the present day. In 1845, Sir Robert Peel's government in London set up the Queen's University of Ireland, with constituent colleges at Belfast, Cork, and Galway. In 1880, Queen's University of Ireland was replaced by the Royal University of Ireland, which was only an examining and degree-awarding body. It had substantial premises in Dublin at Earlsfort Terrace, with extensive laboratories that were used only for practical examinations a few times a year. The Royal University of Ireland also had Senior and Junior Fellows, selected from the academic staff of existing colleges, who could use the laboratory facilities to conduct their personal research at other times.

The three Queen's colleges and other denominational educational institutions around the country could prepare students to take the Royal University of Ireland examinations. Among the latter was University College Dublin, which had evolved from the Catholic University of Ireland established by John Henry Newman in 1854. The Irish Universities Act, 1908, abolished the Royal University of Ireland, transformed the Queen's College Belfast into the Queen's University Belfast, and established the National University of Ireland as a federal university, with constituent university colleges at Dublin, Cork, and Galway, as well as a recognized college at St. Patrick's College, Maynooth. McClelland, who studied as an undergraduate at Queen's College Galway, was closely associated with the Royal University of Ireland and taught at University College Dublin.

The Life of John A. McClelland

Born at Macosquin, near Coleraine in the north of Ireland on November 18, 1870, John Alexander McClelland was baptized on December 1. The youngest of 11 children, he was educated locally at the Coleraine Academical Institute. He entered Queen's College Galway in 1889 and had a distinguished academic career. In 1893, he was awarded a Master of Arts degree by the Royal University of Ireland, with first-class honors in mathematical physics and experimental physics, a gold medal, and a special prize of £60.

McClelland's first taste of research came in Galway with A. Anderson (1858–1936), the professor of natural philosophy there. He was awarded an 1851 Exhibition scholarship and spent time with Professor A. Schuster in Owens College Manchester before joining Professor J. J. Thomson at the Cavendish Laboratory at the end of 1895. He was able to follow E. Rutherford and J. S. Townsend in availing of the new scheme by which Cambridge University allowed graduates of other universities to pursue research within Cambridge. Among McClelland's fellow researchers at the Cavendish Laboratory were C. T. R. Wilson, who received a Nobel prize for his cloud chamber work; O. W. Richardson, who received a Nobel prize for his work on the thermionic effect; and P. Langevin and J. Zeleny, who were subsequently associated with mobility measurements in France and the United States, respectively.

In 1894, the Royal University of Ireland instituted Junior Fellowships, worth £200 per year for 4 years; and in 1895, McClelland won the award in natural philosophy in open competition. Consequently, he was able to extend his time at Cambridge, where he had more than 4 exciting and fruitful years of research before moving back to Ireland in 1900 to fill the Chair of Experimental Physics at University College Dublin.

In 1901, McClelland was appointed a Senior Fellow of the Royal University of Ireland and resumed his research on the ionization of gases and later on the properties of β -rays, making use of the university's laboratory facilities at Earlsfort Terrace. Beyond his laboratory work, he was deeply involved in debates on the dissolution of the Royal University of Ireland and the establishment of the independent federal National University of Ireland with constituent colleges at Dublin, Cork, and Galway in 1909. He also was active from 1912 onward, in the design and construction of the new University College Dublin building at Earlsfort Terrace, which included an extensive physics department with a lecture theater, laboratories, workshops, and

research rooms. Despite his large teaching load and participation on many committees, McClelland succeeded, along with his graduate students, in establishing a flourishing school of research before his premature death on April 13, 1920.²

McClelland's considerable contributions to science did not pass unnoticed, especially his pioneering work on the conduction of electricity through gases and the atmosphere as well as the scattering of β rays. In 1901, he was elected as a Senior Fellow of the Royal University of Ireland, and in 1906 the University conferred on him a DSc *honoris causa* for distinguished original research. He became a member of the Royal Irish Academy in 1905 and served as its secretary from 1906 until his death in 1920. He was elected as a Fellow of the Royal Society (FRS) in 1909. Additionally, he received an honorary Doctorate of Science from the University of Dublin in 1917; and in 1918, the Royal Dublin Society awarded him the Boyle medal, its highest honor for scientific achievement. Moreover, McClelland was a member of the Council and Science Committee of the Royal Dublin Society beginning in 1907 and he published much of his early research in Dublin in the scientific transactions and proceedings of this society. He was a member of the Senate of the old Royal University of Ireland and that of the new National University of Ireland from its inception in 1909 until his death.

In July 1915, McClelland was appointed as the representative from Ireland on the first Advisory Council of the Committee of the UK Privy Council for Scientific and Industrial Research. This was a belated response from the UK government to the need to foster scientific research, especially by industry, to make up for the many technological deficiencies exposed during World War I. The Advisory Council set up standing committees for various industries, encouraged the formation of trade associations with their own research institutes, and initiated schemes for research fellowships and the support of individual research projects. This work involved multiple journeys by McClelland to London under uncomfortable and hazardous wartime conditions, which may have taken a toll on his health. An assessment of McClelland's contribution to scientific and technical education and applied research in Ireland, and the consequences of his untimely death on its development, must be left to another study.

² A short biography of McClelland appears in *Physicists of Ireland, Passion and Precision* (O'Connor, 2003) and in *Its Part of What We Are* (Mollan, 2007).

McClelland's Scientific Work

In his address, Nolan summarized the main results of McClelland's investigations (see Appendix A). Additional details regarding McClelland's research can be garnered from the original papers referenced in Appendix B. As described in Nolan's address, McClelland's scientific work can be divided into three periods: the Cavendish Laboratory at Cambridge, the laboratories of the old Royal University of Ireland, and subsequently the laboratories at the new University College Dublin

The Cavendish Laboratory at Cambridge (1895–1900)

It is not surprising that McClelland's main field of research was the conduction of electricity through gases in general and the lower atmosphere in particular. His December 1895 arrival at the Cavendish Laboratory coincided with the discovery of X-rays. His first research assignment was to assist Professor J. J. Thomson in investigating the effect of X-rays on gases. In March 1896, the two scientists published a joint paper entitled "Leakage through Dielectrics Traversed by Roentgen Rays" (Thomson & McClelland, 1896) establishing most of the well-known features of X-ray activity in gases, such as a conductivity that did not obey Ohm's law but reached a saturation current. McClelland also used the conductivity of gases as a method for measuring X-rays and testing the absorbing power of different materials, and he demonstrated that X-rays were not homogeneous.

McClelland also began his well-known work on the ionization produced by flames, arcs, and incandescent bodies. This research is contained in three papers published between 1898 and 1902; however, the research was completed before he left Cambridge in 1900 to take up his position in Dublin. McClelland showed that the conductivity of flame gases was due to the presence of large numbers of positive and negative ions, and that the decrease in conductivity with time was due to the recombination of these ions. He devised a method for measuring the mobility of ions that became a standard for investigating ionization of any kind in gases. This is essentially an early description of what has since been called a large ion.

The Royal University of Ireland, Dublin (1901–1908)

McClelland found that the professorship of physics at University College Dublin, which was then a private institution, provided meager facilities for research. However, in 1901 he was appointed a Senior Fellow of the Royal

University of Ireland and was able to use its laboratories by working on his own. The ensuing years comprised great scientific activity for McClelland. He devoted all of his time outside of his lecturing duties to his experimental work. His first publication from Dublin on “Ionisation in Atmospheric Air” (McClelland, 1903) was significant, marking the beginning of the “Dublin School” of research on atmospheric electricity and aerosols.

He also persuaded the Royal Dublin Society to purchase some of the newly discovered radium, which he borrowed to conduct investigations of the emanation and penetrating radiation from it. His experiments succeeded in demonstrating that the emanation from radium had no electric charge. Then, examining the penetrating radiation from radium—now called γ -rays—he showed that they are akin to X-rays. He published six papers on his extensive investigations on the properties of β -rays and on secondary radiation from substances exposed to the radiation from radium. The citation for his election as a Fellow of the Royal Society in 1909 pointed out that “the line of work opened up in these papers has been taken up by many investigators” (Royal Society London, n.d.).

National University of Ireland, Dublin (1909–1920)

In December 1908, the National University of Ireland was established and the University College Dublin took over the premises and laboratories of the former Royal University of Ireland. This afforded McClelland the opportunity to take on postgraduate research students and to pursue his interest in atmospheric electricity and related topics. One of his first students was John J. Nolan. Together, they studied the electric charge on rain, which also was the topic of the last paper McClelland presented in January 1920.

With H. Kennedy, he investigated the large ions in the atmosphere. This work led to a series of investigations, in collaboration with Patrick J. Nolan (younger brother of J. J. Nolan) and other postgraduate students, into various sources of ions and whether these ions had characteristic mobilities or preferred sizes. A paper with J. J. McHenry on “Uncharged Nuclei Produced in Moist Air by Ultraviolet Light and Other Sources” was published after McClelland’s death (McClelland & McHenry, 1921). An investigation, with Rev. H. V. Gill, SJ, into “The Causes of Self-Ignition of Ether-Air Mixtures” also was published posthumously (McClelland & Gill, 1920). This latter research was undertaken with sponsorship from the Nobel Explosive

Company and may have been due to McClelland's work for the Board of Scientific and Industrial Research in London.

McClelland the Educator

Nolan's address provides some interesting insights into other aspects of McClelland's life and his views on education, which seem to have been strongly influenced by his experience at Cambridge. An important aspect of McClelland's legacy to university education in Ireland was his administrative work and contributions as a professor, serving as a member of the governing authority and of the senate of first the Royal University of Ireland and later the National University of Ireland.

In evidence to the Royal Commission on University Education in Ireland in 1901, McClelland expressed strong views about technical and scientific education in Ireland (McClelland, 1902), arguing that students should receive a general education in secondary schools and specialize earlier in their university education. He posited that 2 or at most 3 years of lectures and textbooks should qualify the honors student to begin 2 years of research for a Master's degree. For this to occur, he argued, the equipment must be amply sufficient and the staff sufficiently large. He compared Cambridge, where staff members might give three lectures per week, to colleges in Ireland, where staff often gave three lectures per day. McClelland was fortunate to have A. W. Conway, FRS, as a colleague and professor of mathematical physics to share the lecturing load.

Additionally, Nolan's address offers a unique, firsthand account of McClelland's excellence as a teacher of elementary and advanced classes. McClelland's interest in secondary education was demonstrated by his work as a governor of St. Andrew's College for boys in Dublin and his service from 1910 on the Board of Commissioners of National Education in Ireland. His interest in technical education and the use of science in support of industry led to his appointment in 1909 to the Board of Technical Instruction in the Department of Agriculture and Technical Instruction in Ireland. In 1915, he was appointed the representative from Ireland to the first Advisory Council of the Committee of the Privy Council for Scientific and Industrial Research in London, which was tasked with devising mechanisms to support industrial research.

McClelland the Man

McClelland also was a devoted family man. In 1901, he married Ina Esdale, and she and their five children survived him. He also was very popular with the students in the College and presided over many of their athletic clubs. He was always an elegant, tall, dark, and handsome figure, with a dark moustache and brown eyes. His friends, like C. T. R. Wilson in an obituary, remembered him as a quiet, strong, kindly, broad-minded man (Wilson, 1924). According to Nolan, all will remember him as “a great leader and a true and kind friend.”

On April 7, 1920, in a letter to his eldest daughter Dorothy from his sick bed at home, McClelland wrote, “I had a very nasty heart attack nearly a week ago” and “I have finally promised to take a holiday until October and try to get really well. So there is a lazy time before me.” Sadly, this was not to be, as he died 6 days later.

McClelland’s Scientific Legacy

By the time of his death, McClelland had discovered a great deal about the mobility of large and small ions in air, some of the sources of such ions, and the mechanisms influencing the charge on the earth’s surface. This line of research profoundly influenced physics research in Ireland in the 20th century. It was ably carried on by J. J. Nolan, his successor as professor of physics at University College Dublin until his death in 1952, and by his younger brother P. J. Nolan, who was an assistant in the Department of Physics in University College Dublin from 1920 and a lecturer in Physics there from 1929 until he became Professor of Geophysics in 1954. P. J. Nolan remained active for a considerable time after his official retirement from teaching in 1964. Combined, their work became known internationally as the Dublin School for Atmospheric Electricity and Aerosol Studies.

The main thrust of the work of the Nolan brothers and their students in University College Dublin in the 1920s and 1930s was on ionization equilibrium and the relationships of small and large ions in the lower atmosphere. They used an Aitken pocket nucleus counter to measure particle number concentrations. Their results were summarized by J. J. Nolan (Nolan, 1950).

An important development from this time was the diffusion box or battery method of measuring the size of aerosol particles (Nolan, J. J., & Guerrini, 1935; Nolan, J. J., et al., 1938). During World War II, the collaboration between P. J. Nolan and L. W. Pollak at University College Dublin led to

the development and calibration of the photoelectric condensation nucleus counter (Nolan, P. J., & Pollak, 1946). This was a versatile and convenient aerosol particle counter that P. J. Nolan and his research students used for a variety of studies on aerosols. Pollak's interest in the application of the counters to meteorological studies led him to devote considerable time to refining the counter and its absolute calibration. P. J. Nolan's laboratory studies of ionization equilibrium in stored aerosols showed that the fraction of particles remaining uncharged depended on their mean size (Nolan, P. J., & Kennan, 1949). This led him to apply the Boltzmann energy distribution formula to this problem (Nolan, P. J., 1955).

P. J. Nolan introduced two interesting variations on McClelland's method of measuring the mobility of ions. The usual practice involved drawing the gas with the ions at a fixed rate through a concentric cylindrical condenser of fixed dimensions and measuring how the current to the central electrode varied with the potential difference between the electrodes. The mobility of the ions can be deduced from the resultant current/voltage curve. P. J. Nolan and P. J. Kenny (1952) modified McClelland's method by keeping the potential difference constant and varying the airflow, which yielded a current/airflow curve.

Another modification of the method—which was introduced by P. J. Nolan and J. P. Deignan (1948)—when dealing with stored air and an approximately constant aerosol particle concentration was to measure with the photoelectric counter the concentration of particles emerging from the condenser or ion tube when various differences of potential were applied across the electrodes. Subtracting these concentrations from that when the potential difference was zero yields the number of particles or large ions captured by each potential difference. This is a measure of the current collected and enables what was called a nucleus/field curve to be plotted. This is more convenient to measure at low concentrations than the usual current/voltage curve.

McClelland's Academic Descendants

A part of McClelland's legacy is a tradition of aerosol research that grew into what might be termed an Irish School of Atmospheric Aerosol Science. From 1934 to 1973, the chairs of experimental physics at the National University of Ireland constituent colleges at Cork, Dublin, and Galway as well as the recognized college at Maynooth, were held by individuals who had done their initial postgraduate research in this branch of physics.

At University College Dublin, Professor J. J. Nolan was succeeded as professor of physics in 1953 by T. E. Nevin, whose M.Sc. thesis under Nolan was on “The Effect of Water Vapour on the Diffusion Coefficients and Mobilities of Ions in the Air,” although his subsequent research was on molecular spectroscopy and cosmic rays until his retirement in 1979 (Nolan, J. J., & Nevin, 1930). Other members of the physics department staff who carried on this traditional line of research from the Nolans into the 21st century were Rev. T. P. Burke, J. A. Scott, and J. P. McLaughlin.

At St Patrick’s College, Maynooth, Rev. P. J. McLaughlin from 1928 to 1957 and Rev. T. G. McGreevy from 1957 to 1982, both professors of physics, were involved in the area of atmospheric research.

At University College Cork, J. J. McHenry, who did his postgraduate work under McClelland and was for a time a lecturer at University College Galway, became professor of physics in 1934 and president of University College Cork in 1964. His successor, E. F. Fahy, professor of physics from 1964 to 1987, had done his MSc at University College Dublin with P. J. Nolan. Sean Twomey, who did his MSc under McHenry by conducting research on condensation nuclei produced by ultraviolet light (McHenry & Twomey, 1952), went on to a distinguished career in aerosol physics in Australia and the United States.

At University College Galway, C. O’Brolchain, who had done research for a MSc under P. J. Nolan at University College Dublin and a PhD under V. H. Hess in Graz, became professor of experimental physics in 1934. In 1956, he was joined by T. C. O’Connor who had done research for a MSc under P. J. Nolan in University College Dublin and subsequently worked under Professor L. W. Pollak in the Dublin Institute for Advanced Studies. With the material assistance of these two mentors, O’Connor expanded atmospheric aerosol research at University College Galway.

In 1958, taking advantage of Galway’s location on the western coast of Europe, O’Connor established a small coastal research station at Mace Head, near Carna, County Galway, for the study of aerosols and trace gases in the marine atmosphere away from sources of man-made air pollution. With the help of graduate students A. F. Roddy, S. G. Jennings, M. A. Byrne, and C. D. O’Dowd, who all subsequently joined the staff of the department of physics, the Atmospheric Research Group in Galway grew and is now recognized internationally.

The research station at Mace Head expanded to become a global baseline site for the World Meteorological Organization's Global Atmosphere Watch (GAW) program and a "super site" of the European Monitoring and Evaluation Program (EMEP). It has hosted numerous international workshops, monitoring projects, and field campaigns on ocean-atmosphere exchange processes involving trace gases and aerosol particles. June 2008 marked 50 years of research at Mace Head (O'Connor et al., 2008). In recent years, these researches have made valuable contributions to international studies of the composition of the atmosphere and global climate change.

It is gratifying to know that John A. McClelland's scientific work, which began during his undergraduate days in Queen's College Galway more than a hundred years ago, is being carried on there by his scientific descendants into the 21st century. The continued growth of University College Dublin led to the department of physics moving in the 1960s from McClelland's building in the city center to new premises in the suburbs. Fortuitously, the manuscript of Nolan's address surfaced in 2005 during the clearance of an office and a laboratory, which marked a change of emphasis in research topics there after just over a hundred years.

Acknowledgments

The assistance of Dr. Aileen Fyfe in the preparation of this paper is gratefully acknowledged, as well as the helpful advice of the referees and the RTI Press editorial staff.

References

- McClelland, J. A. (1902). Minutes of evidence before the Commission. *Report of Royal Commission on University Education in Ireland*, (London, HMSO), 102–106.
- McClelland, J. A. (1903). Ionisation in atmospheric air. *Scientific Transactions of the Royal Dublin Society*, 8, 57–64.
- McClelland, J. A., & Gill, H. V. (1920). An investigation into the causes of the self-ignition of ether-air mixtures. *Proceedings of the Royal Dublin Society*, 16, 109–119.
- McClelland, J. A., & McHenry, J. J. (1921). Uncharged nuclei produced in moist air by ultra-violet light and other sources. *Proceedings of the Royal Dublin Society*, 16, 282–303.

- McHenry, J. J., & Twomey, S. (1952). Condensation nuclei produced by ultraviolet light. *Proceedings of the Royal Irish Academy*, 55A, 52–59.
- Mollan, R. C. (2007). John Alexander McClelland. *It's part of what we are* (pp. 1381–1389) Dublin, Ireland: Royal Dublin Society.
- Nolan, J. J. (1950). The control of electrical conductivity of the lower atmosphere. *Archiv für Meteorologie, Geophysik und Bioklimatologie. A Bd*, 111, H1/2, 17–27.
- Nolan, J. J., & Guerrini, V. H. (1935). The diffusion coefficients and velocities of fall in air of atmospheric condensation nuclei. *Proceedings of the Royal Irish Academy*, A43, 5–24.
- Nolan, J. J., & Nevin, T. E. (1930). The effect of water vapour on the diffusion coefficients and mobilities of ions in air. *Proceedings of the Royal Society, London*, 127, 155–174.
- Nolan, J. J., Nolan P. J., & Gormley P. G. (1938). Diffusion and fall of atmospheric condensation nuclei. *Proceedings of the Royal Irish Academy*, A 45, 47–63.
- Nolan, P. J. (1955). The photo-electric counter and its application for measuring diffusion coefficients. *Geophysics Research Papers*, 42, 113–119. U.S.A.F. Cambridge Research Centre.
- Nolan, P. J., & Deignan, J. P. (1948). Observations on atmospheric condensation nuclei in stored air. *Proceedings of the Royal Irish Academy*, 51A, 239–249.
- Nolan, P. J., & Kennan, E. L. (1949). Condensation nuclei from hot platinum: size, coagulation coefficient and charge distribution. *Proceedings of the Royal Irish Academy*, 52A, 171–190.
- Nolan, P. J., & Kenny, P. J. (1952). A modified McClelland method for measuring ion mobilities. *Journal of Atmospheric and Terrestrial Physics*, 2, 266–271.
- Nolan, P. J., & Pollak, L. W. (1946). The calibration of a photo-electric nucleus counter. *Proceedings of the Royal Irish Academy*, 51A, 9–31.
- O'Connor, T. C. (2003). John A. McClelland 1870–1920. In M. McCartney & A. Whitaker (Eds). *Physicists of Ireland, passion and precision* (pp. 176–185). Bristol, United Kingdom: Institute of Physics.

- O'Connor, T. C., Jennings, S. G., & O'Dowd, C. D. (2008). Highlights of fifty years of atmospheric aerosol research at Mace Head. *Atmospheric Research*, *90*, 338–355.
- Royal Society London. n.d. Archive of citations for Fellowship Ref EC/1909/18. Retrieved from <http://www.royalsoc.ac.uk>
- Thomson, J. J., & McClelland, J. A. (1896). On the leakage through dielectrics traversed by Roentgen rays. *Proceedings of the Cambridge Philosophical Society*, *9*, 126–140.
- Wilson, C. T. R. (1924). John Alexander McClelland (1870–1920). Obituary notices of Fellows deceased. *Proceedings of the Royal Society, A*, *106*, v–ix.

Appendix A

Transcript of J. J. Nolan's Address on "The Scientific Work of the Late Professor M'Clelland"

Notes

Biographical Note on the Author J. J. Nolan

John James Nolan was born near Omagh in the north of Ireland in 1888. He received his early education locally and was awarded a scholarship to University College Dublin. He graduated in 1909 and joined the teaching staff of the physics department a year later. He began his research career under McClelland by investigating the electric charge on rain. He continued with independent research on the electrification of splashing water and was awarded a D.Sc. by the National University of Ireland in 1917. After the unexpected death of McClelland in 1920, Nolan succeeded him as the professor of physics in University College Dublin and continued to lead research there on aerosols and atmospheric electricity.

Nolan was elected a member of the Royal Irish Academy in 1920 and served as its Secretary from 1923 to 1949, when he became its President for 3 years. He served as Registrar of University College Dublin from 1940 until his death. He collapsed and died while lecturing in April 1952.

Note on the Scientific Society in University College Dublin

The Scientific Society in the University College Dublin was founded by Professor McClelland in 1907. He was the president of the Society from its foundation and always took a keen interest in its activities. It was a student society aimed at the undergraduate and graduate students of the science faculty in the college and sought to promote an awareness of developments in science in general. The presidential address was usually a highlight of the year's program and was attended by members of the university staff, graduates, students, and the public. It was traditionally held in the large lecture theatre of the physics department that McClelland had planned and provided as part of his legacy to the college.

Editorial Note

The original version of this address is handwritten in blue-black ink on lined foolscap paper. There are 21 pages in total, but pages 1 and 2 appear twice, in draft and in a fair copy in black ink. This transcription is of the fair copy of pages 1 and 2. The rest of the manuscript is a first draft, with some corrections and additions in the margins. The corrections have been silently incorporated in this transcription, and the marginal additions appear in {curly brackets}.

In transcribing this address, the original punctuation and spelling have been retained as much as possible, such as the use of “M’Clelland” by Nolan rather than the more usual “McClelland,” which is found in most official documents referring to him. Also the spelling “kathode” is preserved rather than the more common “cathode.” Some obvious abbreviations and slips in grammar have also been retained.

Editorial interpolations appear in [square brackets], and are used mostly to clarify references that would be familiar to the original audience but not to modern readers. References to McClelland’s research work are inserted in square brackets with R plus a number (e.g., [R1]), which refers to the list of his publications provided in Appendix B.

For words that were hard to decipher, a question mark (?) is inserted beside the most probable word.

The original address had been preserved, along with some copies of M.Sc. theses and other reports from the McClelland era, in the papers of J. J. Nolan’s brother, P. J. Nolan. It then found its way into the papers of J. A. Scott, P. J. Nolan’s successor at University College Dublin, and came to light in a clearance on Scott’s retirement. It is our intention to preserve this address in an archive on atmospheric aerosols in the James Hardiman Library at the National University of Ireland Galway.

Text of John J. Nolan’s Address

The Scientific Work of the Late Professor M’Clelland

It has seemed to me, as his successor in the chair of Experimental Physics in this College [University College Dublin, UCD], that the Presidential Address to the Scientific Society of this year, could not be other than a tribute to the scientific work of the late Professor M’Clelland. From its foundation Prof. M’Clelland was President of this Society. But he was much more than a nominal head—he was a continual support to the Society and a continual

influence in its work. He aimed at making this Society a vital and an active expression of the scientific work of the College and he strove to keep it continually in touch with the scientific work of the day. But even that was only a small part of his work on behalf of science in this College. This building in which we meet today, these laboratories and research-rooms which you have seen, are a permanent expression of the devotion which he has given to scientific research. The thousands of students whom he taught and the smaller numbers of these whose footsteps he guided on the paths of scientific investigation will hold his memory in life-long reverence.

As one of his pupils—and very unworthy of his place in this College to which I have succeeded—it is not without great diffidence that I undertake to deal with his scientific work and endeavour to pay some tribute to the additions to knowledge which were the fruit of the all-too-brief twenty-five years which he devoted to Science. I think however, that it is safe to say that appreciation of his scientific work, is perhaps the one tribute that he would have cared for.

Prof. M'Clelland was educated at the Academical Institute, Coleraine and at Queen's College, Galway. In the year 1894 he went as a research student to Owens College Manchester {Schuster?} [i.e., Professor Arthur Schuster] where he remained for a year. In the following year, he went to Cambridge, joining that remarkable group of men whom J. J. Thomson had gathered around him in the Cavendish Laboratory, and who have had so much to do with the making of modern physics.

It is well at this stage that we should try to get an idea of the state of experimental physics in the year 1895 when M'Clelland began his work, for we shall find that a survey of his work is to a large extent a survey of the modern developments of physics.

At that time the idea was held by some, that the great exploring work of physical science was over—that nature had yielded most of her great secrets that were accessible to experiment—that the work of the scientific man henceforth must lie in the accurate quantitative examination of the known phenomena, the accurate surveying of the known ground. Extraordinary short sighted as we would consider this view at the present day—still it was held and expressed by some scientific men. {Stagnation?} Yet—say in the [18]80's—there was much development of great interest and importance. To take only two cases we have the remarkable work of Sir W. Crookes and others on electrical discharges in vacuum tubes and the experimental

demonstration of electric waves by Hertz. The Crookes tube was later to be the key to unlock a great many mysteries. But as has been pointed at by Millikan the remarkable discovery of Hertz was to prove a hindrance rather than a help to the experimental physicist. For this reason. This brilliant experimental verification of the math. theory laid down many years before by Clerk Maxwell naturally turned men's minds to the ether rather than to matter. Electricity was something in the ether rather than something flowing along a wire. Now the ether is a singularly barren subject for experimental or indeed any other kind of research. How many years and how much effort did Lord Kelvin, greatest of the British physicists of his day, give in the search for a comprehensive theory of ether and matter in all their relations. Trying to picture matter as a state of the ether, he imagined atoms as vortices in the ether. Then we had elastic solid and all sorts of other ethers. Mendelieff even went so far as to attribute to it an atomic weight. Nowadays I'm afraid, the ether gets less respect from scientific men. I think one could almost tell the age of a scientific man from his attitude towards this once universally respected medium. As Eddington has pointed out recently we have ceased to endeavour to explain matter, by attributing the experimentally observed properties of matter to something which we assume to be non-matter. If (he says) physics evolves a theory of matter which explains some property it stultifies itself when it postulates that the same property exists (?----?) in the primitive basis of matter {see Eddington}

But just about the years 1894-5 a remarkable series of discoveries were made which were to prove the beginning of a grand experimental attack. The attack has not ceased nor even noticeably diminished in vigour even to the present day.

Thus in Aug. 1894 Lord Rayleigh announced the discovery of argon. In 1895 Roentgen discovered the X-rays. In 1896 Bequerel discovered the radioactivity of uranium. In 1896 Zeeman discovered the effect of a magnetic field on the nature [of] light emitted by a radiating body. In 1897-1898 J. J. Thomson discovered the electron or atom of electricity in the discharge tube, measured its velocity, its mass and its charge. Each of these discoveries may be said to have opened up a new world for investigation. Now as I have said M'Clelland went to Cambridge in 1896. He has told how going to Cambridge he read in the train an account of the discovery of X-rays. And in Cambridge he found, working under the direction of Prof. Thomson, a group of men who were to be the pioneers of the new physics. With Rutherford, Townsend,

C. T. R. Wilson, Langevin and others for the next five years he took his part in the great movement. It was an inspiring time when almost every day brought a new discovery—and each discov.[ery] of capital importance.

I will first deal therefore with this Cambridge period.

The first work undertaken by M'Clelland was the investigation of the effect of the newly discovered X-rays on gases. The results of this work were published in March 1896 [R1] and the paper is a remarkable one for in it we find practically all of the well known features of X-ray activity in gases dealt with. It was found of course that under the action of the X-rays the gas became electrically conducting. This conductivity was experimentally examined in an exhaustive way. The relative conductivity of diff.[erent] gases was tested, and of the same gas at diff.[erent] pressures, and at different temperatures. The important result was established that for this new kind of conductivity Ohm's law was not obeyed. Then again, using the conductivity of the gas as a method of measuring the X-rays experiments were carried out to locate the exact source of the radiation. In the same way the absorbing powers of different materials for X-rays was tested. The very important result was established that X-rays are not homogeneous i.e. a given thickness of material did not always absorb the same fraction of X-rays that fell on it [R2]. Now at the time, the method by which the conduction of electricity is carried on in a gas was not known. Shortly after it was shown that the current in a gas is conveyed by means of carriers or ions. These are minute bodies, of molecular size or thereabouts, carrying each a positive or negative charge of electricity. These are produced in the gas by the action of the X-rays and as was shown later by the radiation from radioactive bodies. The current is conveyed by the movement of these in the gas—the positively charged ones moving with the current and the negatively charged ones moving against it.

We see then that in his very first experiments M'Clelland was dealing with this question of gaseous ionisation to the knowledge of which he was later destined to contribute so much. And we see that, although at the time of his work the mechanism of the process was not known, still he elicited some of the cardinal features of the behaviour of ionised gases.

Now as so much of M'Clelland's work deals with ionisation I think it would be well at this stage to indicate the interest and the importance of the study of gaseous ions.

An ion is a very small particle of matter—a molecule or a small cluster of molecules, carrying an electric charge. Generally speaking each ion carries an atomic charge of electricity. By the aid of its charge we can experiment on it, set it in motion: because of its charge, we can recognise and follow and examine its motion. We can thus investigate the behaviour of matter in the minutest state of division under the simplest conditions. We are at the same time investigating the behaviour of the ultimate particles of electricity. We are not dealing with long-range phenomena; electricity or matter in the bulk, but with very intimate processes.

In the next year (1897) M'Clelland published two papers dealing with the character of the X-rays [R2] and with the Lenard and kathode rays [R3]. He extended his previous observations as to the absorption of X-rays by different substances and emphasises the non-homogeneous character of the X-rays. He showed that the non-homogeneity of the rays depended a good deal on the hardness of the tube. {Harder tubes give more non homogeneous rad.[iation]} {Lenard Rays. Explain.} In connection with the Lenard rays he showed experimentally that they were of the same nature as the kathode stream and he also investigated the fraction of the current in a discharge tube carried by the kathode rays.

In the following year he published an interesting paper dealing with the effect of electric discharges on photographic plates [R4]. And then began his well-known researches on the ionization produced by flames, arcs and incandescent metals. This work is contained in three papers published between 1898 and 1902, but was completed before he left Cambridge in 1900 [R5, R6, R7].

From a very early time it was known that flames and flame gases had conducting properties for electricity. Gilbert, Volta and Faraday all knew and made use of these properties. But while the phenomenon was well known and had been investigated by a multitude of experimenters during the nineteenth century, the nature of the action was not understood. M'Clelland's investigations cleared up the matter and gave a complete theory to account for the mechanism of this conductivity.

M'Clelland showed that the conductivity of flame gases was due to the fact that they contained large numbers of ions, that is carriers of electricity, positively and negatively charged. He investigated the way in which the ionisation decayed by the combining together of positives and negatives to form neutral groups. {conductivity decreased}. He devised a method to

measure the mobility of these ions that is to say the velocity with which they move under a unit electric field. This method is now one of the standard methods for investigating ionisation of any kind. He showed from the results of his measurements that the ions in the flame gases are larger than those produced in air or other gases by X-rays or radium, and he found that they increased in size with the lapse of time. This increase with time he suggested was due to the water vapour condensing around the ion. This is really the first discovery of what has since been called the large ion. We distinguish between the small ion, which appears to be either a single molecule or a small cluster of molecules and which is apparently a stable entity and the large ion, which is a much larger group or cluster and which comes to a condition of stability or semi-stability under the operation of some different laws, not yet clearly understood. M'Clelland examined the ionisation produced by electric arcs and found that it was of the same character as that due to flames [R6]. He then made a very detailed examination of the ionisation produced by incandescent metals {thermions} and by working at low pressures was able to demonstrate the production of fresh ions by impact of ions already formed against neutral gas molecules [R7]. The whole question of the ionisation due to hot wires is now of the greatest practical importance. The modern use of thermionic valves in wireless work and in kindred technical processes which has led to such rapid and far reaching developments; owes much to M'Clelland's pioneer investigations.

In the year 1900 M'Clelland was appointed to the Professorship of Physics in University College [Dublin]. The years that followed were for M'Clelland years of great scientific activity. All the time that was free from his lecturing duties was devoted to his experimental work which was carried on in the laboratory of the Royal University. He began by an investigation into the ionisation of atmospheric, that is the natural, ionisation always found in the atmosphere [R8]. He devised a method of measuring this ionisation and examined its variation under different conditions. He found that it tended to reach a maximum after rain fall and suggested that some part of it at least was due to radioactive matter brought down by the rain. Then he undertook an investigation into the emanation and the penetrating radiation from radium. He succeeded in showing experimentally that the emanation of radium had no electric charge [R9]. {A result of great importance from the point of view of the theory of radioactive transformation.} Then examining the penetrating radiation from radium, called the γ rays, he showed that unlike the α and the

β rays they carried no electric charge. He examined the law of their absorption by matter and suggested, what has since come to be held as the true view, that the γ radiations are akin to X-rays, that is to say that they are a wave motion like light, not a stream of charged particles like α and β - rays [R11].

The principal feature of M'Clelland's work during this period was the great investigation which he carried out on the secondary radiation from substances exposed to the radiations from radium [R12]. When the rays from radium are allowed to fall on any substance the substance itself begins to emit a radiation, of pretty much the same character, but of course less intense than that which has fallen on it [R13]. M'Clelland examined this secondary radiation from different substances and found the remarkable result that the intensity of the secondary rays was closely connected with the atomic weight of the substance and further that the manner in which the secondary radiation varied with the atomic weight depended upon the position of the substances in the periodic classification of the elements [R14]. It appeared therefore that the secondary radiation was an intimate atomic effect. This was in fact further shown by a series of experiments on compounds in which M'Clelland demonstrated that the secondary effect for a compound was the sum of the effects due to its atoms [R15]. It is usual nowadays to give the term "scattered radiation" to what M'Clelland termed "secondary radiation"; but as M'Clelland points out in one of his papers "whether the expelled particles (that is the high velocity electron stream of which the radiation consists) are original constituents of the atom, or incident particles absorbed by the atom and subsequently expelled does not really amount to any essential difference". Much work has been done on this subject by subsequent experimenters, but it cannot be said that they have added much to the results obtained by M'Clelland. In connection with this work investigations were also carried out on the mechanism of absorption of β rays by matter. A theory of this process was put forward by M'Clelland which has been the basis of further research into this difficult subject [R16, R17].

Meanwhile M'Clelland's work was winning for him wide spread recognition. In the year 1906 he became Secretary of the Royal Irish Academy and in 1909 he was elected to the Fellowship of the Royal Society. In 1908 he was nominated as member of the first Senate of the National University [of Ireland]. To the work of organising the newly established University and its Colleges he devoted much time and energy during these years. He was especially anxious as to facilities for research schools in science generally but

especially in physics. In the old buildings of the Royal University he soon had several of his students at work, and those who were with him in these days will remember the keenness of his spirit and the enthusiasm with which he infected all who were associated with him. Meanwhile the plans for the new buildings were being thought about and here again he was urgent and anxious as to provision for research. This building with its laboratories and research rooms which grew up under his hands are a record of the devotion which he gave to his work.

We come now to deal with his scientific work of this—the third period—the period since the establishment of the National University. This work as we have said, was in part carried out in the old Royal University buildings—and later in the present new building. While of a very varied character, for the most part it has some connection with ionisation and atmospheric electricity. This was partly due to the fact that in recent years the possibility of work on the radioactive substances did not exist. M'Clelland's researches on radioactivity were carried out with some 50 mg of radium bromide which the Royal Dublin Society had purchased at his suggestion in the early days when radium was cheap. This radium he had on loan for a number of years but when the R.D. Society decided to establish a radium institute, for supplying radioactive preparations to medical practitioners the Society naturally called in the radium which it had lent to M'Clelland. One is tempted to enquire whether it is likely that these 50 mg of radium have done as much for medical science in the last few years as they did for physics in the hand of M'Clelland.

A cardinal problem in atmospheric electricity is the origin and maintenance of the electric charge on the earth's surface and in this connection it is of importance to know whether rain or snow have any electric charge and if so how much and of what sign. In the year 1911 satisfactory experimental data existed only for one region and that in the tropics. For Europe the results were contradictory and confusing. The question also had a wider bearing in connection with the mechanism of condensation and the ionisation of the atmosphere. M'Clelland set out to work on this point and the results obtained here in Dublin have had considerable part in clearing up the question [R18, R19]. M'Clelland's interest in this, as in other problems of atmospheric electricity was sustained for we find that in his last paper, he deals again with the electricity of rainfall [R27]. About the same time as the research on rain, he initiated an enquiry into the nature of the larger ions and other nuclei in the atmosphere. This work had a close bearing on his

earlier work in Cambridge on flame gases. Perhaps I may be permitted to state here broadly the results of this work. It had been known for a considerable time that when condensation takes place in the atmosphere—that is when a cloud forms—the water condenses into tiny globules each forming round a nucleus. If there is no nucleus, there is no condensation. As to [the] nature of this nucleus, it was generally called “dust.” Now what Prof. M’Clelland and Dr Kennedy showed was practically this: that these nuclei are not what we ordinarily call dust [R20]. They are particles of some sort most of them electrically charged, and all uniformly of the same size. They are produced by flames and fires principally and exist in many thousands per cubic inch of the air of cities. They are much less numerous in the pure air of the country. They must not be thought of as “dust.” They are too small and too regular—they are the large ions. They play a very important part in many natural phenomena and the whole question of their origin and behaviour is of the greatest interest.

Many other kinds of ions were investigated by M’Clelland and his pupils, ions produced by the spraying and bubbling of liquids [R23, R25] and ions produced by the combustion of phosphorus [R26]. In all these processes it would seem that tiny fragments of matter are detached and acquire an electric charge in some way. The electric charge, as I pointed out already, enables us to manipulate them and to study their behaviour. Much knowledge has been gained in recent years by M’Clelland and his pupils of the behaviour of matter in these highly divided forms.

Other researches in this period deal with the photo-electric effect in leaves [R22], the conductivity of substances in thin layers [R21], the conductivity of liquid dielectrics and the ignition of ether-air mixtures [R28]. But I would like to mention especially a research carried out on frictional electricity. This the oldest in a sense the fundamental and certainly the least understood, effect in electricity had always presented enormous difficulties to the experimenter. It was difficult to obtain any experimental result which could be repeated with certainty. There was no firm ground anywhere, everything was baffling and disconcerting. To this difficult subject M’Clelland was able to make some valuable contributions [R24]. By a series of well planned experiments he succeeded in establishing certain relations between the electric charge produced by friction and the temperature, humidity and gaseous pressure of the medium. We cannot say that much is yet known about the nature of this phenomenon, but at least as the result of M’Clelland’s work certain paths

have been opened up which are bound to yield greater knowledge to future explorers.

We have now passed in review the contributions to scientific knowledge made by Prof. M'Clelland. We have dealt briefly with the fruitful work which naturally divided itself into three periods—the Cambridge period, the Royal University period and the last period which ended prematurely almost before his real work of building up a research school was properly begun. But in a review of his scientific work we should not consider him altogether as a research worker and as a leader in research; we should consider him also as a teacher. And as a teacher his gifts were very great; perhaps it was the same gift that made him great in both departments—a remarkable clarity of mind, a power of cutting away the unessential and the accidental and getting at the realities of phenomena. He was equally great as a lecturer to elementary and advanced classes. The many students who attended his elementary lectures will remember the clearness and simplicity of his exposition. It was characteristic of him that he preferred that in his elementary classes their should be no taking of notes; the understanding by the student of the thing itself was what he aimed at—not the imparting of formulae.

As a lecturer to advanced classes he was unequalled. Here his great powers of clear thinking, accurate reasoning and plain exposition were fully revealed. In the hands of some men nature is obscured by a mist of mathematical analysis: M'Clelland was always insistent on the physical realities. I do not mean that he rejected the fullest applications of mathematical reasoning—quite the contrary—but he was insistent throughout in the recognition of the physical meaning behind the mathematical symbol. He did not perplex his students by unexplained assumptions, sudden jumps of thought or a too facile treatment of real difficulties—everything was reasoned out fully, everything treated from the point of view of the explorer. He aimed at giving his students the research point of view and he liked to set them at an early stage at some original or quasi-original investigation. His point of view was that of the student, who has acquired the necessary fundamental knowledge and the necessary initiation into experimental methods, his own gain will be as great and the gain of knowledge in general will be greater if he works out something which is new rather than something merely routine.

From the consideration of M'Clelland as a teacher we are thus led back again to his aspect as a leader in research. And naturally so for the idea of research dominated all his teaching. M'Clelland was too great a teacher and

devoted too much care and energy to the teaching side of his work for there to be any risk of misunderstanding if I say that he always held teaching to be secondary to research. Indeed I think it would be still more correct to say that he made research the first interest of his life.

It is interesting to note certain points about his direction of the research work of students. He much preferred to set a student making observations and measurements at once rather than let him spend much time in conning the results of previous workers. The time for that would come later—but he wished the experimental attack and the ideas that developed in connection with it to be fresh and uninfluenced by what had gone before. Then again he strenuously steered away students from wandering off on any of the inviting side issues that invariably present themselves in any piece of work. He expected from a student hard work and patience—just as he himself would give both to the solution of any problem and while never in any way damping the enthusiasm of youthful workers—his dominant note with them as throughout his own work was caution.

At the beginning I said that the review of M'Clelland's work is in a large degree a review of the newer physics of the last 25 years. We have dealt with his work on Kathode Rays, Lenard Rays and X-rays and then with his original studies in ionisation; later his researches into the radiations of radium. In recent years he had we may say founded a school of his own for the study of ionisation. But though in addition to that main interest many other enquiries were as I have shown, carried out with great success, still in practice, many lines of experiment were inaccessible. I have already shown how the loss of the radium closed one path: in the absence of a liquid air plant and of highly trained mechanical aid other lines of investigation are practically barred. But how many men with the most elaborate equipment have done as much for science as M'Clelland did with resources in some degree circumscribed? Indeed it was not altogether a disadvantage to him to have to contrive his experiments in a simple form. He had the same fondness for simplicity as say Stokes or Lord Rayleigh and something of the same powers of wresting from some simply contrived experiment important natural truths. If therefore he was precluded from any of the more "fashionable"—if I may use the word—types of research, perhaps the gain is all the greater. On the other hand good scientific work can not be done without reasonable facilities and the best work of any worker however able would be better done and done with far less toil if suitable resources were available. If the modern world is in any degree grateful

for what science has given it or has any interest even the most utilitarian in the gaining of knowledge it should give its scientific men and indeed scholars of any sort a fairly free hand. All this is very close to the subject of my paper for M'Clelland's zeal for the encouragement of research was well known and much of the time and energy of his later years was given to work in connection with the Committee for Scientific and Industrial Research.

It is given to few men to leave so permanent a record of themselves as M'Clelland has left—not merely in the science of his day but in the scholarship of his country. To the great Irish theoretical physicists of the last century MacCullagh and Fitzgerald we may add his name as the first great experimental physicist. In the school which he created, as in the material fabric of laboratories which grew up under his inspiration he has made his place a permanency in this College and University. And in the minds of all associated with him as colleagues or as pupils he [his?] memory remains as that of a great leader and a true and kind friend.

Appendix B

Published Scientific Papers of John A. McClelland

- R1 McClelland, J. A., & Thomson, J. J. (1896). On the leakage through dielectrics traversed by Roentgen rays. *Proceedings of the Cambridge Philosophical Society*, 9, 126–140.
- R2 McClelland, J. A. (1897). Selective absorption of Roentgen rays. *Proceedings of the Royal Society of London*, 60, 146–148.
- R3 McClelland, J. A. (1897). Cathode and Lenard rays. *Proceedings of the Royal Society*, 61, 522–525.
- R4 McClelland, J. A. (1898). On the figures produced on photographic plates by electric discharges. *Proceedings of the Cambridge Philosophical Society*, 9, 522–525.
- R5 McClelland, J. A. (1898). On the conductivity of hot gases from flames. *Philosophical Magazine*, 46, 29–42.
- R6 McClelland, J. A. (1900). On the conductivity of gases from an arc and from incandescent metals. *Proceedings of the Cambridge Philosophical Society*, 10, 241–257.
- R7 McClelland, J. A. (1902). On the action of incandescent metals in producing electric conductivity in gases. *Proceedings of the Cambridge Philosophical Society*, 11, 296–305.
- R8 McClelland, J. A. (1903). Ionization in atmospheric air. *Scientific Transactions of the Royal Dublin Society*, 8, 57–64.
- R9 McClelland, J. A. (1904). On the emanation given off by radium. *Transactions of the Royal Dublin Society*, 8, 89–94; also (1904). *Philosophical Magazine*, 7, 355–362.
- R10 McClelland, J. A. (1904). The comparison of capacities: An application of radio-active substances. *Proceedings of the Royal Dublin Society*, 10, 167–177; also (1904). *Philosophical Magazine*, 7, 362–371.
- R11 McClelland, J. A. (1904). The penetrating radium rays. *Transactions of the Royal Dublin Society*, 8, 99–108; also (1904). *Philosophical Magazine*, 8, 67–77.

- R12 McClelland, J. A. (1905). On secondary radiation. *Transactions of the Royal Dublin Society*, 8, 169–182; also (1905). *Philosophical Magazine*, 9, 230–243; also (1905, February 23), *Note in Nature*, 71, 390.
- R13 McClelland, J. A. (1905). On secondary radiation (Part II) and atomic structure. *Transactions of the Royal Dublin Society*, 9, 1–8.
- R14 McClelland, J. A. (1906). The energy of secondary radiation. *Transactions of the Royal Dublin Society*, 9, 9–26.
- R15 McClelland, J. A., & Hackett, F. E. (1906). Secondary radiation from compounds. *Transactions of the Royal Dublin Society*, 9, 27–36.
- R16 McClelland, J. A., & Hackett, F. E. (1907). The absorption of β -radium rays by matter. *Transactions of the Royal Dublin Society*, 9, 37–50.
- R17 McClelland, J. A. (1908). Secondary β -Rays. *Proceedings of the Royal Society*, 80, 501–515.
- R18 McClelland, J. A., & Nolan, J. J. (1912). The electric charge on rain; Part I. *Proceedings of the Royal Irish Academy*, 29 A, 81–91; also (1912). *La Radium*, 9, 277–282.
- R19 McClelland, J. A., & Nolan, J. J. (1912). The electric charge on rain. Part II. *Proceedings of the Royal Irish Academy*, 30, 61–71; also (1912). *La Radium*, 9, 421–426.
- R20 McClelland, J. A., & Kennedy, H. (1912). The large ions in the atmosphere. *Proceedings of the Royal Irish Academy*, 30, 72–91; also (1913). *La Radium*, 10, 392–400.
- R21 McClelland, J. A., & Dowling, J. J. (1915). The electrical conductivity of powders in thin layers. *Proceedings of the Royal Irish Academy*, 32, 51–58.
- R22 McClelland, J. A., & Fitzgerald, R. (1916). Photo-electric discharge from leaves. *Proceedings of the Royal Irish Academy*, 33, 1–8.
- R23 McClelland, J. A., & Nolan, P. J. (1916). The nature of the ions produced by bubbling air through mercury. *Proceedings of the Royal Irish Academy*, 33, 24–34.
- R24 McClelland, J. A., & Power, C. J. (1918). Electrification by friction. *Proceedings of the Royal Irish Academy*, 34, 40–50.

-
- R25 McClelland, J. A., & Nolan, P. J. (1918). The ions produced by bubbling air through alcohol. *Proceedings of the Royal Irish Academy*, 34, 51–61.
- R26 McClelland, J. A., & Nolan, P. J. (1919). The nature of the ions produced by phosphorus. *Proceedings of the Royal Irish Academy*, 35, 1–12.
- R27 McClelland, J. A., & Gilmore, A. (1920). Further observations of the electric charge on rain. *Proceedings of the Royal Dublin Society*, 35, 13–29.
- R28 McClelland, J. A., & Gill, H. V. (1920). An investigation into the causes of the self-ignition of ether-air mixtures. *Proceedings of the Royal Dublin Society*, 16, 109–119.
- R29 McClelland, J. A., & McHenry, J. J. (1921). Uncharged nuclei produced in moist air by ultra-violet light and other sources. *Proceedings of the Royal Dublin Society*, 16, 282–303.

PART II

Research
Institutions

Exploring Inhaled Particles and Human Health at the New York University Institute of Environmental Medicine

Beverly S. Cohen

Introduction

The interface between particles in the air and the human respiratory system has been a subject of inquiry at New York University's Institute of Environmental Medicine (NYU-IEM) since the establishment of the department in 1954. The original program at NYU emerged in 1947 from the concept that a medical school should be concerned with the health problems of workers and the health risks posed by the environment. A primary interest was in the consequences of exposure to "dusts." NYU School of Medicine formed a Division of Industrial Medicine and an accompanying institute within the Department of Preventive Medicine, both under the direction of Dr. Anthony Lanza. The department became independent in 1954, with Dr. Norton Nelson as director of both the department and the institute. He served until 1979; during that time, the institute underwent a name change to the Institute of Environmental Medicine in 1967 to reflect the broader scope of research activities then in progress (Nelson, personal communication, n.d.). Later directors of the institute include Drs. Arthur C. Upton (1979–1992) and Max Costa (1993–present).

Researchers were initially interested in the journey that airborne particles make into the human respiratory system. They wanted to learn how likely it is that an inhaled particle will deposit in the lung, where specific particles deposit in the respiratory tract, how rapidly they are cleared, what happens to the retained particles, and how they affect their host. These initial studies of particle inhalation led to investigations of many other aspects of inhalation exposure. Aerosol research expanded to include toxicological studies in vivo and in vitro, field studies of exposure, epidemiological investigations of human response to inhaled particles, and current studies on genetic

susceptibility to components of airborne particulate matter (PM). An important goal of the research was, and is, to develop information that could lead to interventions that will prevent harm to cardiopulmonary and general health.

Particles in the Lung

NYU-IEM has a rich history of research on the deposition and fate of inhaled particles in the lung. Studies have included detailed measurement of monodisperse particle deposition in humans, animals, and airway cast models.

In a 1986 paper on the use of airborne particles to measure air flow, function, and clearance in the respiratory system, Dr. Nelson noted that in the preceding 35 years, some 140 papers had been published by “what may be regarded as two generations of investigators and their students” (Nelson et al., 1986, p. 8). In that report, which was prepared for delivery by the senior author at the First James L. Whittenberger Lecture at the Harvard School of Public Health, he reviewed the first studies of the influence of particle size in the lung at various respiratory rates and depths (Altshuler et al., 1957; Altshuler, 1959) and the first hollow airway cast studies to address the patterns and efficiencies of intrabronchial particle deposition.

To investigate where inhaled dust deposits in the lung and what happens after it deposits, volunteers inhaled monodisperse gamma-tagged radioaerosols in a prescribed breathing pattern (Nelson et al., 1986). The researchers detected retained particles with a ring of collimated scintillation detectors and a tracheobronchial region detector within a low background chamber to determine the thoracic burden of the inhaled radioaerosol. Using this method to track the time course of the deposited particles revealed short-term clearance from the tracheobronchial region and longer-term clearance attributed to the fraction deposited in the lower lungs. Clearance times, as well as fractional deposition as a function of particle size, could then be determined (Albert et al., 1969). When a single individual inhales particles of different sizes, the rapidly clearing fraction varies, providing a measure of the fraction of the inhaled particles that were deposited in the tracheobronchial region as a function of particle size (Figure 1).

Adaptation of this method to an animal model allowed demonstration of the effects of irritants such as SO₂ and cigarette smoke on lung clearance. The initial chosen animal model, surrounded by a counterweight-balanced

saddle holding the gamma-ray detectors, was large, patient, and cooperative (Figure 2). The data collected show increased clearance rates in a human volunteer and a donkey that resulted from smoking two cigarettes (Figure 3). An extensive list of additional NYU publications on regional deposition and clearance is provided in Nelson's 1986 paper and includes a substantial body of work by Drs. R. E. Albert, M. Lippmann, R. B. Schlesinger, and others.

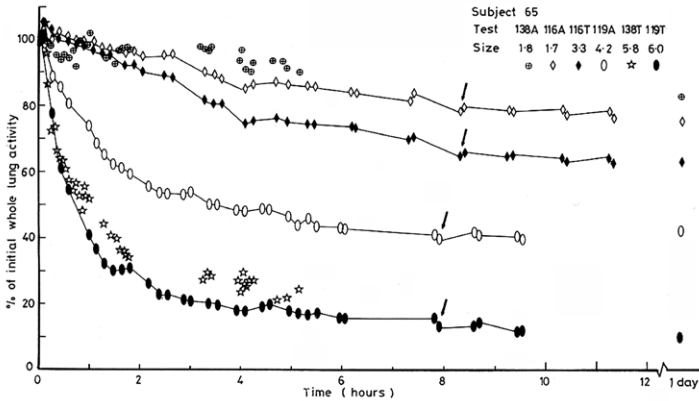

Figure 1. Retention of gamma-tagged monodisperse ferric oxide microspheres of various particle sizes (indicated in μm) for a single nonsmoking man participating in a series of inhalation tests. Fraction of inhaled particles cleared by mucociliary clearance varies systematically with particle size, but effective duration of bronchial clearance phase is relatively independent of size.

Source: Courtesy of M. L. Lippmann.

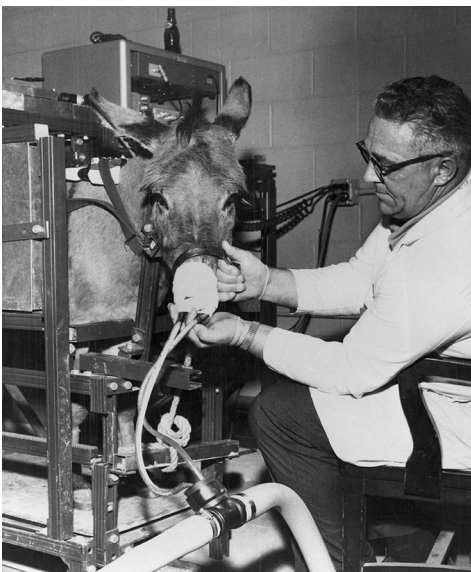

Figure 2. A donkey standing on a movable platform that permitted profile scanning of the thorax and head. The nasal catheters depicted here were used for delivering SO_2 vapor.

Source: Photo courtesy of M. L. Lippmann.

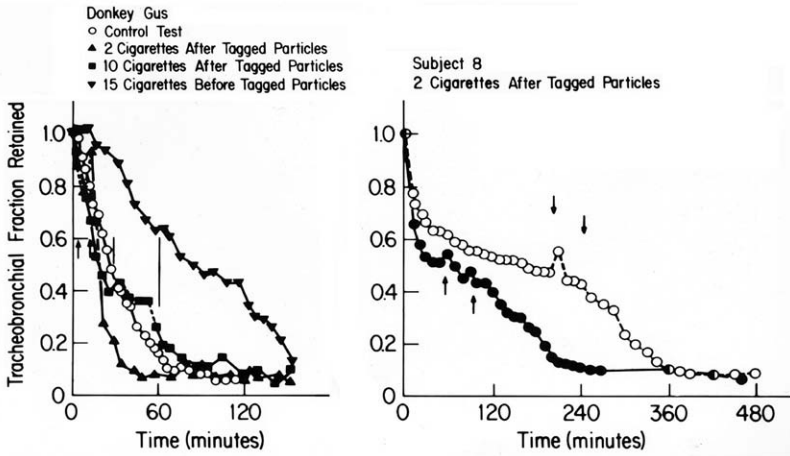

Figure 3. The inhalation of the fresh smoke from two cigarettes accelerated bronchial mucociliary clearance in both a donkey (Gus, left panel) and a human volunteer (right panel). In the donkey, the fresh smoke from 10 cigarettes produced a transient slowing of clearance, whereas the smoke from 15 cigarettes produced a prolonged slowing of clearance. The human subject curves track clearance after inhalation of particles with two different radioactive tracers (open and closed circles) inhaled separately. Time of smoking is indicated by arrows.

Source: Courtesy of M. L. Lippmann.

Approximately 160 aerosol-related publications have been added to the NYU-IEM bibliography since Nelson's original report. Many of these continued the use of monodisperse particles in hollow airway casts to provide detailed information about the deposition and distributions, along the airway paths, of coarse, fine, ultrafine, and fibrous particles.

Deposition studies in the first cast, with radioactively tagged insoluble particles, showed that areas of high deposition correspond to tumor sites in victims of primary lung carcinoma (Schlesinger & Lippmann, 1972). The cast was made from the airways of a human lung obtained at autopsy using the lost wax method. Subsequently, replicate casts were produced, and although the replication method limited the casts to airways greater than 3 mm in diameter, the replicates allowed for repeated measures of deposition for varied flow conditions, particle types, and particle sizes.

The first measurements in the replicate casts compared deposition of particles with diameters ranging from 3 to 8 μm for steady and cyclic inspiratory flow (Gurman et al., 1984). Deposition efficiency studies of fibers and their aerodynamic behavior followed (Sussman et al., 1991a), as well as measures of the deposition of ultrafine particles (Cohen et al., 1990).

Mathematical modeling of the replicate cast data for each of the parameters investigated provided insight into their deposition mechanisms and significance (e.g., Cohen & Asgharian, 1990; Sussman et al., 1991b). Using replicate casts, the enhanced deposition of ultrafine particles that results from particle charge could be demonstrated (Table 1) (Cohen et al., 1998).

Table 1. Deposition of Charged Particles on Lung Airways

Ratio of Deposition Efficiency	20 nm	125 nm
Singly charged/charge neutralized	3.4 ± 0.3	2.3 ± 0.3
Singly charged/zero charge	5.3 ± 0.35	6.2 ± 0.7
Charge neutralized/zero charge	1.6 ± 0.3	2.7 ± 0.4

Source: Adapted from Cohen et al. (1998).

More recently, in collaboration with the University of Iowa (Dr. E. Hoffmann), it has been possible to produce hollow airway cast reproductions of living human tracheobronchial airways from images obtained by computerized tomography (Figure 4).

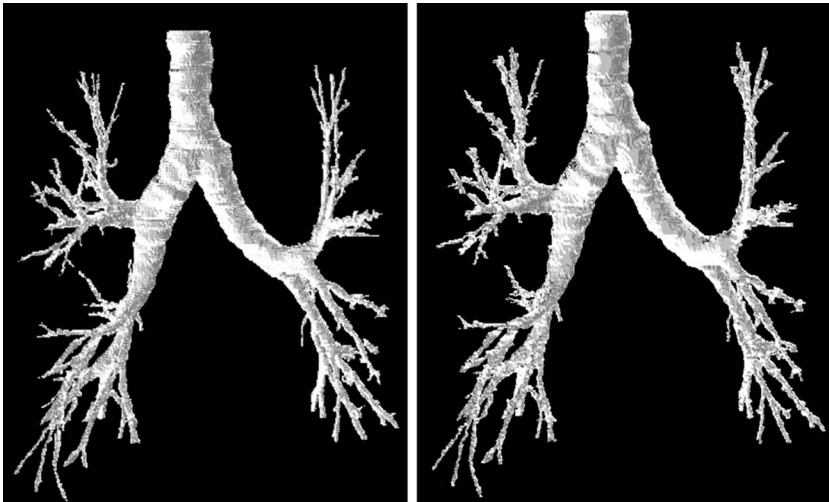

Figure 4. Computerized-tomography-based, three-dimensional images of airway lumen. In vivo human lung (left panel); stereo-lithographic derived cast (right panel).

Source: Photo courtesy of the author.

Measurement Methods

Development of Measurement Methods

The original use of nonhygroscopic monodisperse particles for deposition studies revealed that at low levels of irritant exposure an acceleration of clearance rate is observed, whereas at higher doses and longer periods of exposure, the rate decreases (Nelson et al., 1986). This finding fostered further development of aerosol particle methods to study the lung, notably by Dr. E. D. Palmes and others at NYU. Deposition efficiencies of monodisperse particles were used, for example, to probe airway dimensions. In this method, an inhaled bolus of monodisperse particles is inserted at a selected position in the inhaled air stream, then a timed breath-hold is executed, followed by a forced expiration. The deposition efficiency measured as a function of breath-hold can be extrapolated back to zero breath-hold to give an estimate of the airway dimension (Figure 5).

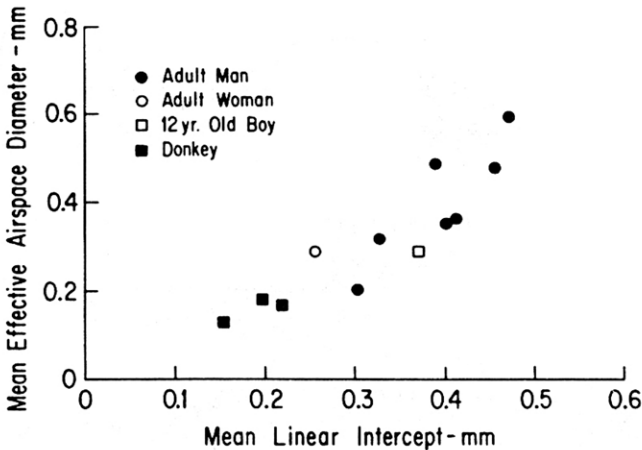

Figure 5. Comparison of the mean effective airspace diameters determined in excised lungs by using the aerosol breath-hold technique with the mean linear intercepts measured in the same lungs after inflation drying.

Source: Lippmann (1990).

Instruments

Over time, the execution of NYU-IEM research programs requiring measurement of exposure relevant to human health has led to the development of innovative samplers.

An Integrating Miniaturized Particle Size Sampler (IMP) (Figure 6) was developed for radon progeny measurement (Harley et al., 2005), to assess personal inhalation exposure at a former uranium processing facility in Fernald, Ohio. In this case, the goal was accurate assessment of exposure and dose from radon and decay products. The pilot aerosol particle size sampler (diameter = 4 cm, height = 3 cm) is fabricated from electrically conducting plastic and operates for up to 2 months, even in severe weather conditions. The sampler operates with a low flow pump ($4\text{--}6\text{ L}/\text{min}^{-1}$), and one version of the IMP has been tested for several years in all weather conditions. The present size spectrum covers from 1 nm to 10 μm . The particle size deconvolution is performed using extreme value estimation (EVE), a method developed at the University of Helsinki by Paati Pentero.

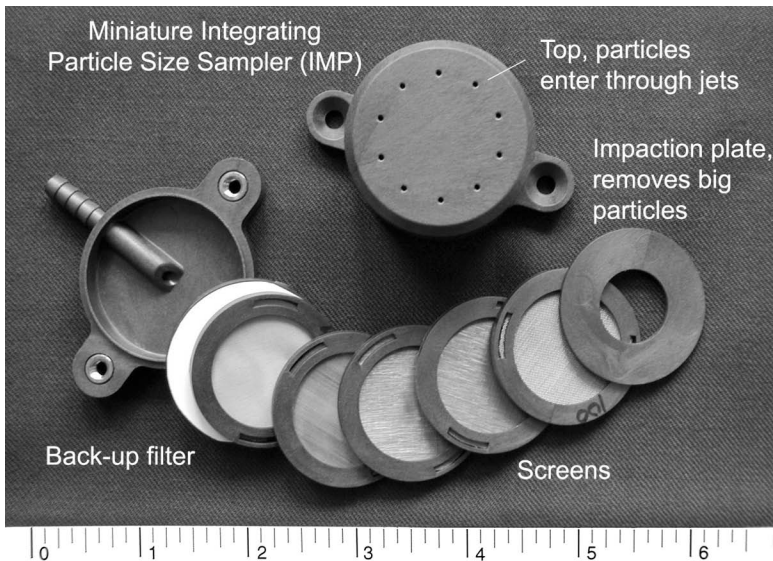

Figure 6. Integrating Miniaturized Particle Size Sampler (IMP). The sampler can have up to eight filtration stages. An impactor stage follows the inlet jets with size cutoff of about 2.5 microns. Six fine-mesh, stainless-steel screens (from 200 to 500 mesh) and an exit Millipore backup filter capture all residual particles not deposited on earlier stages.

Source: Photo courtesy of N. H. Harley.

An Integrating Diffusion Battery (Figure 7), also initially developed for radon progeny, uses porous discs and track etch detectors recessed smoothly into the walls of the diffusion tube. A flexible design version allows for varying the tube length and number of discs in the flow path.



Figure 7. Integrating Diffusion Battery showing the porous plate collectors and the inserts used to hold collectors and track etch discs for detecting alpha particles emitted from the deposited particles. The unit may be assembled with as many sections as desired.

Source: Heikkinen (1997).

Additional samplers developed include a volatile aerosol sampler (Xiong et al., 1998a), a 14-day sequential PM filter sampler that proved useful in the aftermath of the World Trade Center collapse, and a unique method using iron nanofilms for measuring the ambient concentration of ultrafine sulfuric acid droplets (Cohen et al., 2000). In the latter, distinctive ringed reaction sites are seen when sulfuric acid particles react with a 19 nm thick iron coating on 0.5 cm square silicon chips. The chips are deployed in an electrostatic precipitator or a long, flat diffusion channel in an integrating parallel plate diffusion monitor developed specifically to hold the acid detectors. The number of reaction sites is assayed with a scanning force microscope (Figure 8).

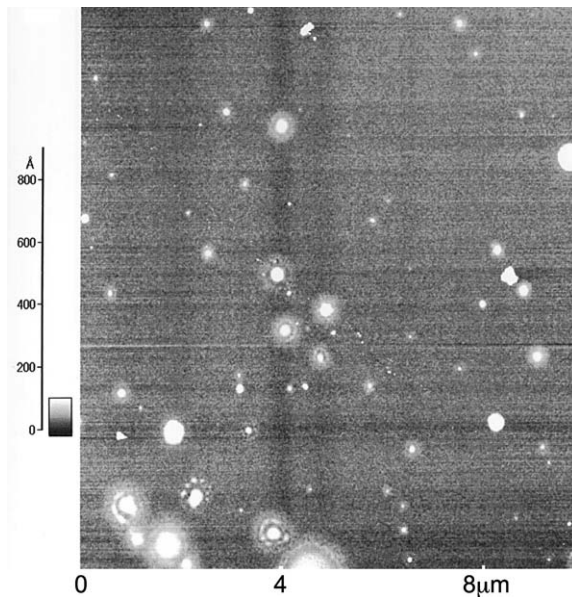

Figure 8. Atomic force microscopy scan of an iron nanofilm detector exposed outdoors in Tuxedo, New York, for 48 hours. Grey scale represents height above the surface in Ångström units (Å). Elevated spots (white) surrounded by circles represent deposited sulfuric acid particles.

Source: Reprinted with permission from Cohen et al. (2004b). [Research described in this article was conducted under contract to the Health Effects Institute (HEI), an organization jointly funded by the United States Environmental Protection Agency (EPA) (Assistance Award No. R-82811201) and the worldwide automotive industry. The content of this article does not necessarily reflect the views of HEI, or its sponsors, nor does it necessarily reflect the views and policies of the EPA or motor vehicle and engine manufacturers.]

World Trade Center

The resources of the NYU Aerosol Inhalation Laboratory permitted its personnel to respond promptly to the need for air quality measurements after the terrorist attack on the World Trade Center in 2001. They were able to obtain samples of deposited dust beginning on the evening of the disaster. The dust was separated into size fractions and analyzed for composition, including concentrations of asbestos and polycyclic aromatic hydrocarbons. The alkalinity of the dust was very high for the larger size fractions ($\text{pH} > 10$) but decreased for fine particles. The caustic nature of the coarse dust particles may explain the chronic cough seen in workers at the site and in area residents (Chen & Thurston, 2002).

To monitor the neighborhood air subsequent to the attack, an air sampling site with a variety of particle mass and size fractionating samplers was quickly established at the New York University Downtown Hospital. The site was about 1,000 m east of the World Trade Center (Chen & Thurston, 2002; Cohen et al., 2004a) (Figure 9). This site was the first one established in the area after the disaster and the closest to “ground zero.” The data (Cohen et al.,

2004a) for particle mass and number concentrations did not differ substantially from data collected in Manhattan the previous year. The dominant organic compounds found were those most common in urban environments. These data did not suggest, but cannot rule out, an unusual risk of adverse health effects from the number, or mass, of the fine ambient particles.



Figure 9. Samplers deployed at the New York University Downtown Hospital–World Trade Center sampling site from September 19, 2001, to December 20, 2001. The Lippmann 14-day filter sampler is at upper right.

MOUDI, micro-orifice uniform deposit impactor; MI, Mercer impactor; CNC, condensation nucleus counter; EAS, electrostatic aerosol sampler.

Source: Cohen et al. (2004a).

Occupational and Environmental Aerosol Research

Occupational Aerosols

Researchers at NYU interested in appropriate measurement of inhalation exposure have produced not only new measurement devices, but a number of studies dealing with biases that result from air sampling methods used to measure inhalation exposure. Early in the 1980s, they demonstrated that work clothing is a very effective scavenger of airborne-dust-containing contaminants and that resuspension of dust then becomes a contributor to the concentrations of contaminants in the breathing zone (Cohen et al., 1984). They also examined the problem of estimating solvent inhalation exposure for volatile aerosol droplets during spray application of polystyrene, such as in the manufacture of boats (Malek et al., 1986), and during automobile paint spray operations (Cohen et al., 1992). Cohen and colleagues reported that

up to 50% of the solvent is found in the droplets. Malek and colleagues also demonstrated the important effects of hood airflow disturbances caused by the presence of the worker in ventilated spray application processes.

Other recent aerosol studies at NYU-IEM have involved aerosols of metal working fluids, ZnO, endotoxin, cotton dust, cigarette smoke, cadmium oxide, and diesel exhaust. The studies aim to determine the adverse pulmonary and systemic effects of inhaled particles encountered in occupational and environmental settings. Recent years have seen the beginning of an active nanoparticle research program, including development of workplace sampling methods and the effect of coagulation on the toxicity of nanoparticles.

Ambient Particulate Matter

The ambient particle inhalation exposure program at NYU has integrated laboratory, field, and epidemiological studies. A few examples are noted here.

Laboratory Studies

A laboratory study of the hygroscopic growth of ultrafine particles with and without organic film coatings began to demonstrate the significance of the ambient organic mix in exposure to sulfuric acid. The study showed significant differences between the hygroscopic growth of pure sulfuric acid particles and those coated with a range of nanometer thick films of either lauric acid or stearic acid (Xiong et al., 1998b).

The results of an in vitro cell culture experiment that examined cellular response to exposure to a fixed mass of sulfuric acid aerosol demonstrated that response was enhanced when the mass was divided into smaller-sized particles (Chen et al., 1995). An increased adverse response, indicated by a decrease in internal cellular pH, was demonstrated when $300 \mu\text{g m}^{-3}$ of acid was subdivided onto a greater number of inert carbon core particles.

Field Studies

In one field study, researchers used a mobile laboratory designed for continuous measurements of concentrations of multiple air pollutants (Maciejczyk et al., 2004) that may have influenced the incidence of asthma in a community in the South Bronx. Another study of elementary school children with asthma employed a mobile van (Figure 10). The study found that exacerbations of symptoms and decline in lung function correlated most strongly with elemental carbon mass concentration, rather than the nonspecific fine particle mass ($\text{PM}_{2.5}$). This ongoing innovative research

indicates that traffic-related pollution may be a significant factor in the respiratory health of such underserved inner-city populations (Spira-Cohen et al., 2006).



Figure 10. New York University mobile air sampling van at Public School 154 in the Bronx, New York.

Source: Photo courtesy of NYU Institute of Environmental Medicine.

Epidemiological and Chronic Exposure Studies

In 1999, under the direction of Dr. M. Lippmann, NYU became one of six national PM Centers funded by the US Environmental Protection Agency (EPA) to determine how exposure to unspecified ambient particles resulted in increasing mortality and morbidity in the United States. Developments under this program have been far reaching and dramatic.

Epidemiological research (with Brigham Young University) determined that ambient fine particles were responsible for much of the cardiac mortality and also for the lung cancer excess seen in the US population (Figure 11) (Pope et al., 2002, 2004). This demonstration of long-term adverse health effects of ambient PM spurred both subchronic animal studies and studies of source apportionment.

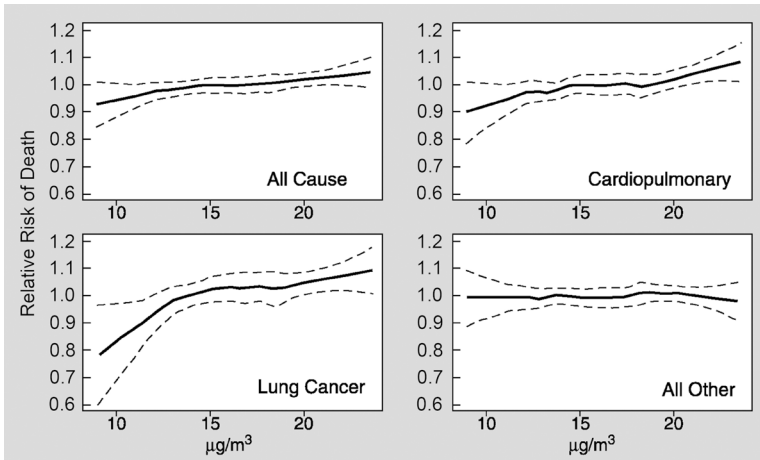

Figure 11. Mortality risks of long-term fine particulate matter exposure increases monotonically with exposure.

Source: Courtesy of George D. Thurston.

In the laboratory, mice were exposed to concentrated ambient particles (CAPs). Single exposures to CAPs were shown to increase the frequency of cardiac arrhythmias in aged male rats (Nadziejko et al., 2004). Subsequently, hyperlipidemic mice were exposed for 6 hours per day, 5 days per week, to concentrated ambient PM_{2.5} for up to 5 months. The results, assessed by examining lesions (plaque) in the aortic sinus regions, showed acute and chronic effects of fine particles on the cardiovascular system (Chen & Nadziejko, 2005).

Source Apportionment

Demonstration of the association between long-term exposure to fine particulate matter (PM_{2.5}) air pollution and increased risk of mortality, noted earlier, leaves the question of which pollution source emissions are most damaging. In 1999, EPA instituted a nationwide PM_{2.5} mass and composition Speciation Site Network that provides the PM_{2.5} characteristics needed to conduct a statistical apportionment of air pollution impacts for cities across the United States. It was also demonstrated that source apportionment methods are reliable for apportioning the health effects of PM_{2.5} (Thurston et al., 2005).

Using the 2000–2003 EPA Speciation Site Network data, Thurston and Lall (2006) conducted a factor analysis of the entire nation to apportion $PM_{2.5}$ to source categories and locations around the United States. The sources identified (and their key elements) were the metals industry (Pb, Zn); soil particles (Ca, Si); motor vehicles (OC, EC, NO_3); the steel industry (Fe, Mn); coal combustion (As, Se); oil combustion (V, Ni); salt particles (Na, Cl); and other sulfate (S). These sources represent over 80% of the US mean $PM_{2.5}$. Thurston and Lall's results indicate that applying source apportionment methods to the EPA Speciation Site Network can be a useful avenue to identify sources affecting the nation and to determine source-specific health effects, thus allowing more efficient regulation of $PM_{2.5}$.

Identification of Specific Toxic PM Components

Cardiovascular effects have recently been linked to the presence of nickel in ambient air in mice, as shown in the chronic exposure experiments carried out with CAPs, and have also been observed in people (Lippmann et al., 2006). In the mouse chronic exposure study, they established that excursions of heart rate occurred on days with elevated concentrations of nickel in the $PM_{2.5}$. They were able to use back trajectories to establish a specific source of nickel for those days. They then established support for the hypothesis in two human populations: (1) by reanalysis of the National Mortality, Morbidity, and Air Pollution Study (Figure 12) and (2) by reexamination of a report of reduced mortality in a Hong Kong intervention to reduce sulfur concentrations in fuel, which also led to reduction in ambient nickel concentrations (Lippmann et al., 2006).

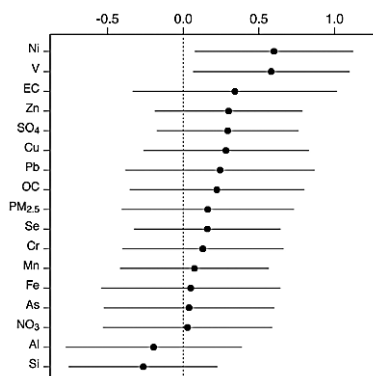

Figure 12. Differences in mortality risk coefficients per the 5th- to 95th-percentile difference in fine particulate matter (FPM) and FPM components across the National Mortality, Morbidity, and Air Pollution Study metropolitan statistical areas (MSAs) for the 60 MSAs for which FPM speciation data were available.

Source: Adapted from Lippmann et al. (2006).

Summary

More than 50 years of health-related aerosol research at NYU, beginning at the interface of airborne particles and the respiratory system, have resulted in a wealth of knowledge about the interaction of airborne particles and people. This knowledge has supported efforts to reduce the potential for harm when people are exposed to toxic airborne particles occupationally or environmentally.

Acknowledgments

This work is part of Center Programs supported by grants from the National Institute of Environmental Health Sciences (ES00260) and the US Environmental Protection Agency (827351).

References

- Altshuler, B. (1959). Calculation of regional deposition in the respiratory tract. *Bulletin of Mathematical Biophysics*, 21, 257–270.
- Altshuler, B., Yarmus, L., Palmes, E. D., & Nelson, N. (1957). Aerosol deposition in the human respiratory tract. I. Experimental procedures and total deposition. *AMA Archives of Industrial Health*, 15, 293–303.
- Chen, L. C., & Nadziejko, C. (2005). Effects of subchronic exposures to concentrated ambient particles (CAPs) in mice: V. CAPs exacerbate aortic plaque development in hyperlipidemic mice. *Inhalation Toxicology*, 17, 217–224.
- Chen, L. C., & Thurston, G. (2002). World Trade Center cough. *Lancet*, 360, 37s–38s.
- Chen, L. C., Wu, C. Y., Qu, Q. S., & Schlesinger, R. B. (1995). Number concentration and mass concentration as determinants of biological response to inhaled irritant particles. *Inhalation Toxicology*, 7, 577–588.
- Cohen, B. S., & Asgharian, B. (1990). Deposition of ultrafine particles in the upper airways: An empirical analysis. *Journal of Aerosol Science*, 21, 789–797.
- Cohen, B. S., Brosseau, L. M., Fang, C. P., Bowers, A., & Snyder, C. (1992). Measurement of air concentrations of volatile aerosols in paint spray applications. *Applied Occupational and Environmental Hygiene*, 7, 514–521.

- Cohen, B. S., Harley, N. H., & Lippmann, M. (1984). Bias in air sampling techniques used to measure inhalation exposures. *American Industrial Hygiene Association Journal*, 45, 187–192.
- Cohen, B. S., Heikkinen, M. S. A., & Hazi, Y. (2004a). Airborne fine and ultrafine particles near the World Trade Center disaster site. *Aerosol Science and Technology*, 38, 338–348.
- Cohen, B. S., Heikkinen, M. S. A., Hazi, Y., Gao, H., Peters, P., & Lippmann, M. (2004b). *Field evaluation of nanofilm detectors for measuring acidic particles in indoor and outdoor air* (Research Report No. 121). Boston, MA: Health Effects Institute.
- Cohen, B. S., Li, W., Xiong, J. Q., & Lippmann, M. (2000). Detecting H+ in ultrafine ambient aerosol using iron nano-film detectors and scanning probe microscopy. *Applied Occupational and Environmental Hygiene*, 15, 80–89.
- Cohen, B. S., Sussman, R. G., & Lippmann, M. (1990). Ultrafine particle deposition in a human tracheobronchial cast. *Aerosol Science Technology*, 12, 1082–1091.
- Cohen, B. S., Xiong, J. Q., Fang, C. P., & Li, W. (1998). Deposition of charged particles on lung airways. *Health Physics*, 74, 554–560.
- Gurman, J. L., Lippmann, M., & Schlesinger, R. B. (1984). Particle deposition in replicate casts of the human upper tracheobronchial tree under constant and cyclic inspiratory flow. I. Experimental. *Aerosol Science and Technology*, 3, 245–252.
- Harley, N. H., Chittaporn, P., Heikkinen, M. S. A., Medora, R., & Merrill, R. (2005). Airborne particle size distribution measurements at DOE Fernald. In E. Berkey & T. Zachry (Eds.), *Subsurface contamination remediation. Accomplishments of the Environmental Management Science Program* (ACS Symposium Series, No. 904, pp. 342–350). Washington, DC: Oxford University Press.
- Heikkinen, M. S. A. (1997). *A portable, integrating diffusion battery for the measurement of radon progeny size distribution in indoor air* (Doctoral thesis). Graduate School of Arts and Science, New York University, New York, NY.

- Lippmann, M. (1990). Factors governing particle deposition in lung airways. In S. Masuda & K. Takahashi (Eds.), *Aerosols—Science, industry, health and environment* (pp. 103–108). Oxford, United Kingdom: Pergamon Press.
- Lippmann, M., Ito, K., Hwang, J. S., Maciejczyk, P., & Chen, L. C. (2006). Cardiovascular effects of nickel in ambient air. *Environmental Health Perspectives*, 114, 1662–1669.
- Maciejczyk, P. B., Offenberg, J. H., Clemente, J., Blaustein, M., Thurston, G. D., & Chen, L. C. (2004). Ambient pollutant concentrations measured by a mobile laboratory in South Bronx, NY. *Atmospheric Environment*, 38, 5283–5294.
- Malek, R. F., Daisey, J. M., & Cohen, B. S. (1986). The effect of aerosol on estimates of inhalation exposure to airborne styrene. *American Industrial Hygiene Association Journal*, 47, 524–529.
- Nadziejko, C., Fang, K., Narciso, S., Zhong, M., Su, W. C., Gordon, T., . . . Chen, L. C. (2004). Effect of particulate and gaseous pollutants on spontaneous arrhythmias in aged rats. *Inhalation Toxicology*, 16, 373–380.
- Nelson, N., Altshuler, B., Palmes, E. D., Albert, R. E., Lippmann, M., & Schlesinger, R. (1986). Airborne particles, their use in the respiratory system to measure air flow, function, and clearance. *American Journal of Industrial Medicine*, 10, 7–25.
- Pope, C. A., Burnett, R. T., Thun, M. J., Calle, E. E., Krewski, D., Ito, K., & Thurston, G. D. (2002). Lung cancer, cardiopulmonary mortality, and long-term exposure to fine particulate air pollution. *Journal of the American Medical Association*, 287, 1132–1141.
- Pope, C. A., Burnett, R. T., Thurston, G. D., Thun, M. J., Calle, E. E., Krewski, D., & Godleski, J. J. (2004). Cardiovascular mortality and long-term exposure to particulate air pollution: Epidemiological evidence of general pathophysiological pathways of disease. *Circulation*, 109, 71–77.
- Schlesinger, R. B., & Lippmann, M. (1972). Particle deposition in casts of the human upper tracheobronchial tree. *American Industrial Hygiene Association Journal*, 33, 247–251.
- Spira-Cohen, A., Chen, L. C., Clemente, J., Blaustein, M., & Thurston, G. (2006). A health effects analysis of traffic-related PM pollution among children with asthma in the South Bronx, NY. *Epidemiology*, 17, S229–S229.

- Sussman, R. G., Cohen, B. S., & Lippmann, M. (1991a). Asbestos fiber deposition in a human tracheobronchial cast. I. Experimental. *Inhalation Toxicology*, 3, 145–160.
- Sussman, R. G., Cohen, B. S., & Lippmann, M. (1991b). Asbestos fiber deposition in a human tracheobronchial cast. II. Empirical model. *Inhalation Toxicology*, 3, 161–179.
- Thurston, G. D., Ito, K., Mar, T., Christensen, W. F., Eatough, D. J., Henry, R. C., . . . Hopke, P. K. (2005). Workshop on the source apportionment of particulate matter health effects: Inter-comparison of results and implications. *Environmental Health Perspectives*, 113, 1768–1774.
- Thurston, G. D., & Lall, R. (2006). A source apportionment of US fine particulate matter pollution for health effects analysis. *Epidemiology*, 17, S271.
- Xiong, J. Q., Fang, C. P., & Cohen, B. S. (1998a). A portable vapor/particle sampler. *American Industrial Hygiene Association Journal*, 59, 614–621.
- Xiong, J. Q., Zhong, M., Fang, C. P., & Lippmann, M. (1998b). Influence of organic films on the hygroscopicity of ultrafine sulfuric acid aerosol. *Environmental Science & Technology*, 32, 3536–3541.

The Clean Air Commission of the Austrian Academy of Sciences

A Historical Sketch

Helmuth Horvath and Othmar Preining

Introduction

The Clean Air Commission (*Kommission für Reinhaltung der Luft*), part of the self-organized and independent Austrian Academy of Sciences (*Österreichische Akademie der Wissenschaften*), has contributed considerably to the air quality in Austria and its surrounding countries. Although the commission has no legislative power, it has influenced Austria's laws, standards, and regulations concerning air quality. Because the Austrian Academy of Sciences is not involved in politics, it is recognized by all stakeholders as a scientific authority, and evidence produced by the Academy usually is regarded as valid and well examined.

The Austrian Academy of Sciences is very similar to other European Academies of Sciences in that it is a learned society. Presently, the Academy has 167 elected members, and it regularly holds plenary sessions where scientific work is presented and officers and new members are elected. The plenary has two sections (*Klassen*): the Section for Mathematics and the Natural Sciences (*Mathematisch-naturwissenschaftliche Klasse*) and the Section for the Humanities and the Social Sciences (*Philosophisch-historische Klasse*), both of which hold sessions prior to the meeting of the plenary. However, because the Academy represents all sciences and the fields of the two large sections are very broad (e.g., ranging from astronomy to zoology in the case of the Section for Mathematics and the Natural Sciences), neither the plenary meetings nor the section meetings are an appropriate forum for detailed discussion, work, research, or fact finding on a specific scientific subject.

To address such issues, the plenary of the Academy establishes “commissions” (*Kommissionen*) that conduct scientific work on particular subjects and report the results to the plenary. A commission can be formed

ad hoc, finishing its work over a few months before reporting and disbanding, or serve as an ongoing commission, with work conducted continuously and regularly reported to the plenary. The Clean Air Commission is an ongoing commission.

The Academy established its first commission, the Commission on Radioactivity (*Kommission über Radioaktivität*), in 1901; at the time, radioactivity was a new field of science. Ten years later, in 1911, the Academy founded its first research institute, The Institute for Radium Research (*Radiuminstitut*), which was the first institute in the world devoted exclusively to nuclear research. The institute's researchers won multiple Nobel prizes, and all known pioneers of nuclear research cooperated with and visited the institute.

The Founding of the Clean Air Commission

When Austria was freed from German occupation in May 1945 at the end of World War II, the allies divided the country into four zones of occupation and restricted traffic (persons and goods) between the zones. As a result, most of Austria's industry was destroyed. After the war, rebuilding Austria was the main task for the Austrian government. However, due to a lack of foreign currency, the government was not able to import the fossil energy necessary to support the rebuilding. To address this lack of supply, local coal mines, which were exhaustively exploited during the war, supplied the urgently needed energy to Austria's residents. During this time, very little attention was paid to the health of miners working in Austria's coal mines, and no attention was paid to the amount of emissions created by industrial polluters. As a result, industrial air pollution, especially from the mining industry, became a serious problem in Austria in the 1950s and early 1960s. In response to this issue, the Austrian government and high-ranking Ministry officers asked individual scientists, mostly members of the Academy, for advice on how to address the country's air quality problem.

At the request of Academy member Professor Ferdinand Steinhauser, the Austrian Academy of Sciences created the Clean Air Commission on December 13, 1962, as a multidisciplinary organization to address air quality issues in Austria. Academy members and non-Academy members were assigned to serve on the commission. All of the Academy members were department heads at the University of Vienna, with various areas of expertise

(i.e., F. Hayek, medicine [anatomy]; F. Steinhauser, meteorology; F. Wessely, chemistry; and G. Stetter, physics), and all had research interests in air pollution and its effects on humans. The other (non-Academy) members were specialists in environmental issues (J. Schedling, medical physics; G. Wagner, inorganic chemistry). The first chairman of the commission was Professor Georg Stetter; subsequent chairmen were Hanns Malissa, Othmar Preining, and Marianne Popp. Table 1 shows a listing of the chairmen and deputy chairmen of the commission. A listing of the members of the commission and their expertise is provided in Table A-1 Appendix A to this chapter.

Table 1. Chairmen of the Clean Air Commission

“Obmann” (chair)	“Stellvertreter” (deputy chair)	Period
Georg Stetter	NA	1963–1986
	Johann Schedling	1977–1986
Hanns Malissa	Othmar Preining	1986–1990
Othmar Preining	Manfred Haider	1990–1995
	Helger Hauck	1996–2002
Marianne Popp	Helger Hauck	2003– present

An important asset in the investigation of particulate pollution in post-war Austria was the strong background of several physicists in Vienna in the study of ultra-fine aerosols particles. These physicists were former PhD students of Felix Ehrenhaft, a leading physicist at the University of Vienna from the beginning of the 20th century until 1938, when he escaped to the United States. (Dr. Ehrenhaft returned to Vienna in 1947, where he stayed until his death in 1953.) Similar to Robert Millikan in Chicago, Ehrenhaft determined the charge of the electron, but used solid selenium particles instead of oil droplets, which caused additional problems. When illuminated for observation, the selenium particles showed photophoresis (i.e., motion in temperature gradients) and many other effects. These phenomena were analyzed thoroughly, and most of Ehrenhaft’s students became specialists in photophoresis or the optical and mechanical problems of particles below diameters of 1 micrometer. Today, this field is called nanoparticle aerosol science.

By enabling the collaboration of numerous experts from very diverse fields, the Clean Air Commission was able to bring state-of-the-art knowledge and information to the Academy and, in due course, to agencies, governments, and other authorities involved in environmental research and policy in Austria.

Early Challenges for the Clean Air Commission

The rapid increase in the number of cars and the boom of industry in Austria in the 1960s led to heavy pollution in the country, which raised the concerns of the Austrian government and environmental ministry. From the mid-1960s onward, the Clean Air Commission started systematic work to address this pollution issue, with analysis by the commission revealing unacceptably high concentrations of carbon monoxide (CO) in Austria's narrow city street canyons, as well as high concentrations of particulate matter and sulfur dioxide (SO₂). One of the commission's first successes was the closure of a narrow city street in the central part of Vienna to through traffic, which reduced the CO concentrations at this location to acceptable levels.

To keep the Academy members informed and to maintain contact with cutting-edge researchers, the commission invited internationally known scientists from environmental disciplines, especially aerosol science, to present lectures in Vienna. These lectures occurred at a rate of about two to three per year. Furthermore, the members of the commission engaged in cooperative international activities and participated in international meetings.

A brief description of the political structure in Austria is germane. Austria is a federal state, and the Austrian provinces (*Bundesländer*) have legislative power for clean air regulations. As a result, air quality regulations may be different among neighboring provinces, which can lead to political problems. In addition, the provincial governments are very critical of clean air recommendations made by the federal government and are more apt to accept the science-based recommendations made by the Austrian Academy of Sciences. Since 1968, the Clean Air Commission has organized meetings of the clean air experts of the provinces twice a year (sporadic meetings took place between 1962 and 1967). These meetings provide a forum for discussion of hot topics on air quality and an opportunity for the provinces to exchange information on air quality management experiences.

In the 1960s and 1970s, it was difficult for the commission to discuss problems of SO₂ and dust (i.e., aerosols, Total Suspended Particles [TSP]) with

decision makers due to the lack of air quality information and regulations. To investigate and solve these complex problems, the commission increased its membership and added specialists from agriculture and forestry. In 1975, the Clean Air Commission addressed the problem of high concentrations of SO₂ and provided detailed documentation and recommendations to the respective government agencies for air quality management. As a necessary restriction for the protection of human health, the commission recommended that the daily mean concentrations of SO₂ and TSP should be less than 200 µgm⁻³. To protect plants, the commission recommended much lower SO₂ concentrations (i.e., 50 µgm⁻³ during the growing season; 100 µgm⁻³ during other times of the year).

These recommendations were summarized in the 120-page booklet *Sulfur Dioxides in the Atmosphere—Air Quality Criteria SO₂* (*Schwefeldioxyde in der Atmosphäre—Luftqualitätskriterien SO₂*; Akademie der Wissenschaften, 1975). The booklet contains chapters about the effects of SO₂ and TSP concentrations on humans and the environment; information on methods of measurement; recommendations for ambient concentrations; and a literature review. The table of contents of this booklet is provided in Table B-1 of Appendix B.

The commission's recommendations for air quality criteria were a big success. Eventually, all large power plants were required to install SO₂ removal devices, sulfur was greatly reduced in heating oil, and the amount of SO₂ in the atmosphere in Austria was reduced.

The commission used a similar approach to develop the air quality criteria documents for nitrogen oxides (NO_x). In 1988, the commission published the document "Air Quality Criteria Nitrogen Oxides" (*Stickstoffoxide in der Atmosphäre Luftqualitätskriterien NO₂*; Akademie der Wissenschaften / Wissenschaftlicher Beirat für Umwelthygiene im Bundesministerium für Umwelt, Jugend und Familie, 1988) and published an update to the document in 1998, "Nitrogen Oxides in the Atmosphere: Effects on Humans, Update 1998" (*Stickstoffoxide in der Atmosphäre Wirkungen auf den Menschen Neubearbeitung 1998*; Österreichische Akademie der Wissenschaften, 1998). The commission's NO_x criteria had an immediate influence on industry. One example of this influence was the update of one of the first European power plants—the lignite coal power plant at Köflach—with de-noxification technology. This technology was critical because the plant is situated in an air shed where inversions are frequent and the number of days without wind is extremely high.

The commission used the same exacting approach to develop the ozone criteria document “Photo-oxidants in the Atmosphere: Air Quality Criteria Ozone” (*Photooxidantien in der Atmosphäre Luftqualitätskriterien Ozon*; Akademie der Wissenschaften /Wissenschaftlicher Beirat für Umwelthygiene im Bundesministerium für Umwelt, Jugend und Familie, 1989) and the document “Volatile Organic Compounds (VOCs), Air Quality Criteria VOC” (*Flüchtige Kohlenwasserstoffe in der Atmosphäre—Entstehung, Verhalten und Wirkungen, Luftqualitätskriterien VOC*; Akademie der Wissenschaften/Wissenschaftlicher Beirat für Umwelthygiene im Bundesministerium für Umwelt, Jugend und Familie, 1997). Besides addressing the rationale for reducing concentrations and providing measurement and control techniques, the VOC criteria document also addressed indoor exposure issues. The tables of contents of these criteria documents are listed in Tables B-2 to B-5 of Appendix B.

In addition to these air quality documents, the commission also investigated the possible consequences of climate change for Austria, and in 1993, completed a 490-page report on this topic, “Climate Change, Consequences for Austria” (*Bestandsaufnahme anthropogene Klimaänderungen: Mögliche Auswirkungen auf Österreich—Mögliche Maßnahmen in Österreich*, Dokumentation; Österreichische Akademie der Wissenschaften-KRL, 1992). This report included information on climate models; the effect of climate changes on Austria’s hydrology, limnology, and vegetation; and emission sources and recommended actions. The commission continued its broad focus on climate change in 1993 with the document “The Scientific Basis for a National Plan for Environmental Protection (NPEP) with Respect to Climate, Air, Odor, and Noise” (*Umweltwissenschaftliche Grundlagen und Zielsetzungen im Rahmen des Nationalen Umweltplans [NUP] für die Bereiche Klima, Luft, Geruch und Lärm*; Österreichische Akademie der Wissenschaften-KRL, 1994). A decade later, the commission produced the book *Guidelines for Rating Indoor Air Quality (Richtlinie zur Bewertung der Innenraumluft*; Arbeitskreis Innenraumluft im Bundesministerium für Land- und Forstwirtschaft, Umwelt und Wasserwirtschaft; Kommission für Reinhaltung der Luft der Österreichischen Akademie der Wissenschaften, 2003), which reported on the evaluation of air quality inside buildings. Again, English translations of the tables of contents of these documents can be found in Tables B-6, B-7, and B-8 of Appendix B, as well as on the home page of the Austrian Clean Air Commission (<http://www.oeaw.ac.at/krl/>).

The Austrian Project on the Health Effects of Particulates

After many years of studying international literature on the effects of air pollution on humans, the Clean Air Commission used its comprehensive knowledge to initiate a project on the health effects of particulate matter. Using its well-established contacts in Austrian agencies that deal with and regulate air pollution, the Austrian Project on Health Effects of Particulates (AUPHEP) was started in 1999, with the agencies contributing instruments, data, and financing to the project. The main financing for the project came from the government ministry responsible for the environment. The aim of the AUPHEP was to experimentally investigate the health effects of particulate pollution; such investigations are characterized by size-selective sampling of all size fractions of aerosols, including ultra fines. The project analyzed samples chemically for major inorganic components and for a large number of organic compounds. In addition, the project analyzed gases continuously. One rural and three city sites were studied, and the sampling was conducted at each site for 1 year. The large number of data obtained by the project permitted a medical group to study the effects of particulate pollution on pre-school and school-age children and on the elderly population. The AUPHEP was operational from 1999 until 2003 and resulted in many publications. The project's final report was published in 2004, and six papers about the project were published as a special issue of *Atmospheric Environment* (Volume 38, No. 8 [2004] pages 3905 to 3981). More details about the AUPHEP can be found on the home page of the commission (<http://www.oeaw.ac.at/krl/>).

Other Activities of the Clean Air Commission

The members of the Clean Air Commission have expertise in such a wide variety of fields that they are considered experts for all questions related to environmental policy. Members of the commission have been invited to serve on international and national boards, or as representatives of Austria at international conferences and negotiations.

Two studies on power plants should be mentioned as examples of the successful, scientifically based work of the commission. The Powerplant Moosbierbaum/Dürnrrohr near Vienna was scheduled to be located at the abandoned Moosbierbaum industrial site. Members of the commission were asked to give a scientific evaluation/expert opinion on the environmental impact of the power plant and the expected effects that the plant would have on ambient pollution levels. The commission completed its study on the

environmental impact of the power plant in 1980. As a result of the study's findings, the coal-fired power plant, which went into operation in 1987, was equipped with desulfurization and denoxification technologies.

The commission's expert opinion also was sought for a planned power station at Bildein, which is near the Hungarian border. For this power plant, lignite of inferior quality would have been brought to the power plant via a conveyor belt from Hungary, which would have resulted in a tremendous amount of pollution. The commission's report on the emissions, ambient concentrations, and environmental hygiene of the proposed plant was a critical factor in the decision not to build the plant.

Since the 1950s, members of the Clean Air Commission informally have advised high-ranking officers of the Ministries responsible for the environment (these Ministries have had different names over the years). Although the Clean Air Commission has never had any political power, it has sustainably influenced Austrian environmental politics through its strict adherence to scientifically based analyses and recommendations. Starting in 1970, members of the Commission had a seat on the advisory board for the Minister of the Environment, providing up-to-date information on topics related to air quality criteria. In a similar manner, some members of the commission were members of the Austrian CO₂ Commission.

The Clean Air Commission members have always used their expertise to provide scientifically up-to-date evaluations of the problems at hand. Being independent scientists, these recommendations sometime contradict political expediency, which can cause friction. In 1985, the Austrian Federation founded the Environment Agency Austria (*Umweltbundesamt*), which is subject to the directives of the Minister of the Environment. Currently, this new agency serves as the government agency advising the Minister, and the advisory board consisting of the independent scientists of the Clean Air Commission has been "immobilized." This experience is similar to situations experienced by advisory boards in other countries.

Conclusion

Since being founded, the Clean Air Commission has contributed to the development of Austrian environmental policy. The commission has created documents that aid governmental decisions regarding the environment, and the scientific results of commission-based analysis have been published and presented at many international meetings. The coordination of expert

scientists from very diverse fields and the effective nurturing of contacts in the Ministries and provincial governments is a time-consuming and exhausting job for the chair of the commission. Further information on the Clean Air Commission, as well as cited literature, can be found on the commission's home page at <http://www.oeaw.ac.at/krl/>.

References

- Akademie der Wissenschaften. (1975). Schwefeloxide in der Atmosphäre, Luftqualitätskriterien SO₂ [Sulfur Dioxides in the Atmosphere—Air Quality Criteria SO₂]. (MfGuU [Hrsg.]). Retrieved from <http://www.oeaw.ac.at/krl/publikation/index.htm>
- Akademie der Wissenschaften /Wissenschaftlicher Beirat für Umwelthygiene im Bundesministerium für Umwelt, Jugend und Familie. (1988). Stickstoffoxide in der Atmosphäre Luftqualitätskriterien NO₂ [Air Quality Criteria Nitrogen Oxides]. (Richtlinie 14, BMfGuU [Hrsg.]). Retrieved from <http://www.oeaw.ac.at/krl/publikation/index.htm>
- Akademie der Wissenschaften /Wissenschaftlicher Beirat für Umwelthygiene im Bundesministerium für Umwelt, Jugend und Familie. (1989). Photooxidantien in der Atmosphäre Luftqualitätskriterien Ozon [Photooxidants in the Atmosphere: Air Quality Criteria Ozone]. (Richtlinie 15, BMfUJuF [Hrsg.]) . Retrieved from <http://www.oeaw.ac.at/krl/publikation/index.htm>
- Österreichische Akademie der Wissenschaften-KRL. (1992). Bestandsaufnahme anthropogene Klima-änderungen: Mögliche Auswirkungen auf Österreich—Mögliche Maßnahmen in Österreich, Dokumentation [Climate Change, Consequences for Austria]. (BMfWF/BMfUJE, ISBN 3-85224-83-2). Retrieved from <http://www.oeaw.ac.at/krl/publikation/index.htm>
- Österreichische Akademie der Wissenschaften-KRL. (1994). Umweltwissenschaftliche Grundlagen und Zielsetzungen im Rahmen des Nationalen Umweltplans (NUP) für die Bereiche Klima, Luft, Geruch und Lärm [The Scientific Basis for a National Plan for Environmental Protection (NPEP) with Respect to Climate, Air, Odor, Noise]. (Band 17/1994). Retrieved from <http://www.oeaw.ac.at/krl/publikation/index.htm>

Akademie der Wissenschaften / Wissenschaftlicher Beirat für Umwelthygiene im Bundesministerium für Umwelt, Jugend und Familie. (1997). Flüchtige Kohlenwasserstoffe in der Atmosphäre–Entstehung, Verhalten und Wirkungen, Luftqualitätskriterien VOC [Volatile Organic Compounds (VOCs), Air Quality Criteria VOC]. (Richtlinie 16, BMfUJuF [Hrsg.]). Retrieved from <http://www.oeaw.ac.at/krl/publikation/index.htm>

Österreichische Akademie der Wissenschaften. (1998). Stickstoffoxide in der Atmosphäre, Wirkungen auf den Menschen Neubearbeitung 1998 [Nitrogen Oxides in the Atmosphere: Effects on Humans, Update 1998]. (Richtlinie 17, BMfGuU [Hrsg.]). Retrieved from <http://www.oeaw.ac.at/krl/publikation/index.htm>

Arbeitskreis Innenraumlufte im Bundesministerium für Land- und Forstwirtschaft, Umwelt und Wasserwirtschaft; Kommission für Reinhaltung der Luft der Österreichischen Akademie der Wissenschaften. (2003). Richtlinie zur Bewertung der Innenraumlufte [Guidelines for Rating Indoor Air Quality]. (ÖAW-KRL [Hrsg.]). Retrieved from <http://www.oeaw.ac.at/krl/publikation/index.htm>

Appendix A

Table A-1. Members of the Clean Air Commission

Name of Member	Field of Expertise	Membership in the Commission
Stetter, Prof. Dr., Georg	Physics	1962–1986
Hayek, Prof. Dr., Heinrich	Anatomy	1962–1968
Steinhauser, Prof. Dr., Ferdinand	Meteorology	1962–1991
Wessely, Prof. Dr., Friedrich	Organic Chemistry	1962–1966
Schedling, Prof. Dr., Johann	Medical Physics	1962–1985
Wagner, Prof. Dr., Georg	Inorganic Chemistry	1962–1976
Reuter, Prof. Dr., Heinz	Theoretical Meteorology	1963–1991
Flamm, Prof. Dr., Heinz	Medicine	1969–1977
Preining, Prof. Dr., Othmar	Physics	1969–2007
Haider, Prof. Dr. Dr., Manfred	Medicine, Psychology Environmental Hygiene	1971–2007
Kisser, Prof. Dr., Josef	Anatomy and Physiology of Plants	1971–1981
Benger, Prof. Dr. Dr., Johann	Hygiene	
Hackl, Prof. DI, Dr., Albert	Process Engineering	1980–date
Malissa, Prof. DI, Dr., Hanns	Analytical Chemistry Microchemistry	1980–date
Halbwachs, Prof. Dr., Gottfried	Botany	1980–date
Hauck, Prof. Dr., Helger	Medical Physics	1986–date
Kromp-Kolb, Prof. Dr., Helga	Meteorology	1986–date
Puxbaum, Prof. Dr., Hans	Chemistry Environmental Analysis	1986–date
Reischl, Ass. Prof. Doz. Dr., Georg	Physics	1986–1992
Nöbauer, Prof. Dr., Wilfried	Mathematics	1988–1988
Burian, Prof. Dr., Karl	Anatomy and Physiology of Plants	1988–1997
Gutmann, Prof. DI, Dr. mult., Viktor	Inorganic and General Chemistry	1988–1992

(continued)

Table A-1. Members of the Clean Air Commission (continued)

Name of Member	Field of Expertise	Membership in the Commission
Kummer, Prof. DI, Dr., Wolfgang	Physics	1988–1993
Steinhauser, Prof. Dr., Peter	Geophysics	1988–date
Bauer, Prof. Dr., Siegfried, J.	Meteorology, Geophysics	1991–date
Hantel, Prof. Dr., Michael	Physics of Geo-fluids	1991–date
Berner, Prof. Dr., Axel	Physics	1993–date
Hlawka, Prof. Dr., Edmund	Mathematics	1993–1997
Horvath, Prof. Dr., Helmuth	Physics	1993–date
Huber, Prof. Dr., Josef	Analytic Chemistry	1993–1997
Neuberger, Prof. Dr., Manfred	Medicine, Environmental Hygiene	1993–date
Steininger, Prof. Dr., Friedrich	Biostratigraphy	1993–date
Grasserbauer, Prof. DI, Dr., Manfred	Analytical Chemistry	1994–date
Pischinger, Prof. DI, Dr., Rudolf	Mechanical Engineering	1996–date
Hittmair, Prof. Dr., Otto	Theoretical Physics	1996–2003
Guttman, Prof. Dr., Giselher	Psychology	2001–date
Popp, Prof. Dr., Marianne	Plant Physiology	2001–date
Boxberger, Prof. Dr., Josef	Agricultural Engineering (Agricultural Economics)	2001–date
Kasper-Giebl, U.-Ass. Dr., Anne	Technical Chemistry	2001–date
Amann, DI, Dr., Markus	Economy, Electrical Engineering	2001–date
Smidt, Doz. Dr., Stefan	Biomolecular Food Technology	2002–date

Appendix B

Reference information, abstracts, and in most cases downloads of the following publications can be found at <http://www.oeaw.ac.at/krl/publikation/index.htm>.

Table B-1. Air Quality Criteria Sulfur Dioxide

Title	Schwefeloxide in der Atmosphäre, Luftqualitätskriterien SO ₂	121 pages, published 1975
Chapter 1	Luftverunreinigende Stoffe, Emissionen, Immissionen, Luftqualitätskriterien, wirkungsbezogene Immissions-Grenzkonzentration	Air pollutants, emissions, ambient concentrations, air quality criteria, effect-related concentrations and limits
Chapter 2	Physikalisch-chemische Eigenschaften und Reaktionen der Schwefeloxide in der Atmosphäre	Physical and chemical properties and reactions of sulfur dioxide in the atmosphere
Chapter 3	Schwefeloxide in der Atmosphäre, Herkunft und Meßmethoden; Verfahren zur Ermittlung der Staubkonzentration	Sulfur dioxide in the atmosphere, sources and measuring methods, methods to determine dust concentrations
Chapter 4	Einfluß meteorologischer Faktoren auf die Verbreitung von Schwefeldioxid	Influence of meteorological conditions on the dispersion of sulfur dioxide
Chapter 5	Konzentration von Schwefeldioxid und Staub in der Atmosphäre	Concentration of sulfur dioxide and dust in the atmosphere
Chapter 6	Wirkung der Schwefeloxide in der Atmosphäre auf Materialien	Effects of atmospheric sulfur dioxide on materials
Chapter 7	Wirkung von Schwefeloxiden in der Atmosphäre auf die Vegetation	Effects of atmospheric sulfur dioxide on vegetation
Chapter 8	Toxikologische Wirkungen auf Mensch und Tier	Toxicological effects on humans and animals
Chapter 9	Im Experiment ermittelte Kombinationswirkungen Schwefeldioxid/Staub auf Mensch und Tier	Experimentally determined combination effects of sulfur dioxide and dust on humans and animals
Chapter 10	Epidemiologische Studien über Schwefeloxide	Epidemiological studies on sulfur dioxide
Chapter 11	Normen und Vorschläge für Grenzwerte in verschiedenen Staaten und durch die Weltgesundheitsorganisation	Norms and suggestions for limiting concentrations used/proposed in different countries and proposed by the World Health Organization
Chapter 12	Zusammenfassung, Schlußfolgerungen, Empfehlungen	Summary, conclusions, recommendations

Table B-2. Air Quality Criteria Nitrogen Oxides

Title	Stickstoffoxide in der Atmosphäre Luftqualitätskriterien NO₂	359 pages, published 1988
Chapter 1	Vorbemerkung	Introduction
Chapter 2	Vorkommen von Stickstoffoxiden	Occurrence of nitrogen oxides
Chapter 3	Physikalische und chemische Eigenschaften von Stickstoffoxiden	Physical and chemical properties of nitrogen oxides
Chapter 4	Reaktionen von Stickstoffoxiden in der Atmosphäre	Reactions of nitrogen oxides in the atmosphere
Chapter 5	Meßmethoden zu Bestimmung stickstoffhaltiger Luftschadstoffe	Methods to measure air pollutants containing nitrogen
Chapter 6	Wirkungen von Stickstoffoxiden auf den Menschen	Effects of nitrogen oxides on humans
Chapter 7	Wirkungen von Stickstoffoxiden auf Tiere	Effects of nitrogen oxides on animals
Chapter 8	Wirkungen von Stickstoffoxiden auf Pflanzen	Effects of nitrogen oxides on plants
Chapter 9	Wirkungen von Stickstoffoxiden auf Materialien	Effects of nitrogen oxides on materials
Chapter 10	Übersicht über die in- und ausländische Immissionsituation von Stickstoffmonoxid und Stickstoffdioxid sowie ausgewählter Folgeprodukte	Overview of ambient concentrations of NO and NO ₂ and selected reaction products
Chapter 11	Prognostische Erfassung von Immissionsbelastungen durch Stickstoffoxide und ihre Folgeprodukte	Estimates for future ambient concentrations of NO and NO ₂ and selected reaction products
Chapter 12	Internationale Luftqualitätskriterien und Immissionsgrenzwerte	International air quality criteria and limits for ambient concentrations
Chapter 13	Empfehlungen für wirkungsbezogene Immissionsgrenzkonzentrationen	Recommendations for effect- related limits for ambient concentrations
Chapter 14	Umsetzung der wirkungsbezogenen Immissionsgrenzkonzentrationen	Realization of effect-related limits for ambient concentrations
Chapter 15	Empfehlung für Alarmwerte für Stickstoffdioxid	Recommendations for warning values of NO ₂

Table B-3. Nitrogen Oxides in the Atmosphere: Effects on Humans, Update 1998

Title	Stickstoffoxide in der Atmosphäre Wirkungen auf den Menschen Neubearbeitung 1998	75 pages, published 1998
Chapter 6	Wirkungen von Stickstoffoxiden auf den Menschen: NO ₂ , NO, HNO ₃ , Nitrate	Effects of nitrogen oxides on humans: NO ₂ , NO, HNO ₃ , nitrate
Chapter 13	Wirkungsbezogene Immissionsgrenzkonzentrationen	Effect-related limits for ambient concentrations
Chapter 13.1	Einleitung	Introduction
Chapter 13.2	Zusammenfassung der Wirkung auf Mensch und Tier	Summary of effects on humans and animals
Chapter 13.3	Zusammenfassung der Wirkung auf Pflanzen und Ökosysteme	Summary of effects on plants and ecosystems
Chapter 13.4	Zusammenfassung der Wirkung auf Matderialien	Summary of effects on materials
Chapter 13.5	Wirkungsbezogene Immissionsgrenzkonzentrationen für Stickstoffdioxid	Effect related ambient limits for nitrogen dioxide
Chapter 13.6	Begründung der wirkungsbezogenen Immissionsgrenzkonzentrationen	Rationale for effect-related ambient limits for nitrogen dioxide
Chapter 13.7	Literaturverzeichnis	References

Table B-4. Photo-oxidants in the Atmosphere: Air Quality Criteria Ozone

Title	Photooxidantien in der Atmosphäre Luftqualitätskriterien Ozon	453 pages, published 1989
Chapter 1	Vorbemerkungen	Preliminary remarks
Chapter 2	Vorkommen	Occurrence
Chapter 3	Chemisch-physikalische Eigenschaften von Ozon und anderen Photooxidantien	Chemical and physical properties of ozone and other photo oxidants
Chapter 4	Reaktionen	Reactions
Chapter 5	Meßmethoden zur Bestimmung der Immissionskonzentration von Ozon und anderen Photooxidantien	Methods to measure ambient concentrations of ozone and other photo oxidants
Chapter 6	Wirkungen auf den Menschen	Effects on humans
Chapter 7	Wirkungen auf Tiere	Effects on animals
Chapter 8	Wirkungen auf Pflanzen	Effects on plants
Chapter 9	Wirkungen auf Materialien	Effects on materials
Chapter 10	Modelle zur Simulation der Immissionsverhältnisse	Models for simulation of ambient concentrations
Chapter 11	Internationale Luftqualitätskriterien und Immissionsgrenzwerte	International air quality criteria and limits for ambient concentrations
Chapter 12	Wirkungsbezogene Immissionsgrenzkonzentrationen	Effect-related limits for ambient concentrations
Chapter 13	Sinn und Anwendung eines Immissionsgrenzwertes für Ozon	Reasons and application of limits for ambient concentrations of ozone
Chapter 14	Maßnahmen	Actions

Table B-5. Air Quality Criteria VOC

Title	Flüchtige Kohlenwasserstoffe in der Atmosphäre–Entstehung, Verhalten und Wirkungen, Luftqualitätskriterien VOC	763 pages, published 1996
Chapter 1	Einleitung	Introduction
Chapter 2	Vorkommen	Occurrence
Chapter 3	Substanzeigenschaften	Properties of VOCs
Chapter 4	Chemisches Verhalten in der Troposphäre	Chemistry of VOCs in the atmosphere
Chapter 5	Analytik flüchtiger organischer Verbindungen in der Atmosphäre	Analysis of VOCs in the atmosphere
Chapter 6	Wirkungen auf den Menschen	Effects on humans
Chapter 7	Wirkungen auf Pflanzen	Effects on plants
Chapter 8	Indoor-Problematik	The problem of indoor VOCs
Chapter 9	Klimawirkungen	Effects on climate
Chapter 10	Immissionssituation	Situation of ambient concentrations
Chapter 11	Modellberechnungen für Ausbreitung und chemische Umwandlung	Model calculations for dispersion and chemical transformation
Chapter 12	Kriterien und Standards	Criteria and standards
Chapter 13	Wirkungsbezogene Immissionsgrenzkonzentrationen für Menschen und Pflanzen und Werte zur Begrenzung des Krebsrisikos sowie Minderungsziele für indirekte Wirkungen (Ozonbildung, Treibhauseffekt)	Effect-related limitations of ambient concentrations for humans and plants. Values for limitation of the cancer risk and reduction goals for indirect effects (formation of ozone, greenhouse effect)
Chapter 14	Messstrategien für VOCs in der Atmosphäre	Strategies for measurements of VOCs on the atmosphere
Chapter 15	Maßnahmen, Empfehlungen	Actions and recommendations
Chapter 16	Glossar	Glossary

Table B-6. Climate Change, Consequences for Austria

Title	Bestandsaufnahme anthropogene Klima-änderungen: Mögliche Auswirkungen auf Österreich– Mögliche Maßnahmen in Österreich, Dokumentation	Published in 1992 as extended abstract and in 1993 as full document, 490 pages
Chapter 1	Einleitung	Introduction
Chapter 2	Klimamodelle	Climate models
Chapter 3	Klimareihen	Climate series
Chapter 4	Hydrologie	Hydrology
Chapter 5	Limnologie	Limnology
Chapter 6	Vegetation und Treibhausproblematik	Vegetation and greenhouse effect
Chapter 7	Vegetation	Vegetation
Chapter 8	Emissionen von Treibhausgasen	Emission of greenhouse gases
Chapter 9	Maßnahmen	Actions
Chapter 10	Weiterführende Literatur	References

Table B-7. The Scientific Basis for a National Plan for Environmental Protection (NPEP) with Respect to Climate, Air, Odor, Noise

Title	Umweltwissenschaftliche Grundlagen und Zielsetzungen im Rahmen des Nationalen Umweltplans (NUP) für die Bereiche Klima, Luft, Geruch und Lärm	473 pages, published 1993
Chapter 1	Vorbemerkungen	Introduction
Chapter 2	Grundsätzliche Überlegungen: Die Lage der Umwelt—Kriterien eines NUP—Wirtschaftliche Aspekte des NUP- Vorreiterrolle Österreichs— Die sachlichen Verflechtungen des NUP—Beurteilungsfragen des NUP— Maßnahmen aufgrund des NUP— Information und Bildung—Literatur	Basic consideration: The situation of the environment—criteria for a NPEP—economical aspects of NPEP-Austria as cutting edge— linkages within NPEP—assessment of NPEP—Action based on NPEP— information and education— references
Chapter 3	Klima: Das Klima allgemein—Die Erfassung der globalen Situation —Szenarien—Auswirkungen auf Österreich—Systemkritische Aspekte— Literatur	Climate: General aspects—the global situation—scenarios— implications for Austria—critical aspects—references
Chapter 4	Luft: Wirkungen von Luftschadstoffen (Grundsätzliches)—Emissionssituation in Österreich. Immissionsituation in Österreich—Gesetzliche Regelungen, Richtlinien und Normen— Zielvorstellungen und Maßnahmen— Literatur	Air: Principal effects of air pollutants—emissions in Austria—ambient concentrations in Austria—legislation, guiding principles and standards— objectives and measures— references
Chapter 5	Geruch: Problemstellung, Definition—Derzeitige Situation im Wohnbereich in Österreich— Bedeutung der Geruchswirkung für den Menschen—Gesetzliche Regelungen und Grenzwertempfehlungen— Beurteilungs- und Bewertungskriterien—Allgemeine Umweltziele und Qualitätsziele für Geruchsbelastungen und Maßnahmenvorschläge—Literatur	Odor: The problem and definitions—present situation in housing in Austria—importance of effects of odor for humans—legal regulations and recommendations of limits—criteria for review and evaluation—general environmental goals and aims with respect to quality for odor loads and suggestions for measures— references

(continued)

Table B-7. The Scientific Basis for a National Plan for Environmental Protection (NPEP) with Respect to Climate, Air, Odor, Noise *(continued)*

Title	Umweltwissenschaftliche Grundlagen und Zielsetzungen im Rahmen des Nationalen Umweltplans (NUP) für die Bereiche Klima, Luft, Geruch und Lärm	473 pages, published 1993
Chapter 6	Lärm: Einleitung und Übersicht—Bewertungs- und Beurteilungsgrößen—Die derzeitige Situation in Österreich—Auswirkungen von Schallimmissionen auf den Menschen—Gesetzliche Regelungen, Normen, Richtlinien und Richtwerte—Rahmenbedingungen für die Lärminderung, Qualitätsziele für bestimmte Auswirkungen und Umwelten—Maßnahmen zur Lärminderung—Zusammenfassung und Empfehlungen—Literatur	Noise: Introduction and overview—magnitudes for evaluation and estimation—the present situation in Austria—effects of ambient noise on humans—legislative regulations, norms, guiding principles and standards—general framework for noise reduction, quality goals for specific effects—measures for noise reduction—summary and recommendations—references

Table B-8. Guidelines for Rating Indoor Air Quality

Title	Richtlinie zur Bewertung der Innenraumluft	Published 2003
Chapter 1	1 Allgemeiner Teil	Introduction
Chapter 2	Flüchtige Organische Verbindungen—VOC, Allgemeiner Teil	VOCs: Overview
Chapter 3	Flüchtige Organische Verbindungen—VOC, Tetrachlorethen (TCE)	VOCs: Tetrachlorethen (TCE)
Chapter 4	Flüchtige Organische Verbindungen—VOC, Styrol	VOCs: Styrol
Chapter 5	Flüchtige Organische Verbindungen—VOC, Summenparameter	VOCs: Lumped parameters
Chapter 6	Flüchtige Organische Verbindungen—VOC, Toluol	VOCs: Toluene
Chapter 7	Physikalische Faktoren, Kohlenstoffdioxid als Lüftungsparameter	Physical factors, carbon dioxide, and ventilation parameters

Aerosol Research at the University of Minnesota Particle Technology Laboratory

Benjamin Y. H. Liu, Virgil A. Marple, Peter H. McMurry,
Thomas H. Kuehn, and David Y. H. Pui

History of the Particle Technology Laboratory

Research on airborne particles began in the Mechanical Engineering Department, University of Minnesota in the late 1920s, when Prof. R. C. Rowley, head of the department, established a collaborative research program on building ventilation and dust control with the American Society of Heating and Ventilating Engineers (ASHVE), which later became the American Society of Heating, Refrigerating and Air Conditioning Engineers (ASHRAE). He was joined in this research by Prof. R. C. Jordan, head of the department from 1949 to 1976, and later by others, including Kenneth T. Whitby, who was a graduate student in the department in the 1950s. Between 1929 and 1959, these scientists carried out airborne particle research related to building ventilation and dust control. They published papers with titles such as “Determination of the Quantity of Dust in Air by Impingement” (Rowley & Beal, 1929), “A Standard Air Filter Dust Test” (Rowley & Jordan, 1939), “A Comparison of the Weight, Particle Count, and Discoloration Methods of Testing Air Filters” (Rowley & Jordan, 1941), “Overloading of Viscous Air Filters During Accelerated Dust Tests” (Rowley & Jordan, 1942), and “The ASHRAE Airborne Dust Survey” (Whitby et al., 1957), among others. This research laid the foundation for the subsequent ASHRAE filter testing standards, some of which the building ventilation and worldwide filtration industries still use today.

Prof. Kenneth T. Whitby completed his doctoral studies in the department in 1954. His dissertation was entitled *Mechanics of Fine Sieving* (Whitby, 1954). He also developed a centrifuge particle size analyzer for sizing powder (Whitby, 1955), which the milling industry used to size flour particles. Flour

milling was a major industry, and flour was a major agricultural product in Minnesota. Whitby established the Particle Technology Laboratory in 1956 to focus on particle research. His initial interest was in powder research. Topics of interest in the fields of powder and particle technologies included the creation of powder particles by grinding and their subsequent processing by sieving and centrifugal separation. Such particles are generally quite large, anywhere from a few to hundreds of micrometers in diameter. At the same time, Whitby also became interested in small airborne particles due to the building ventilation and dust control program in the Department. Over time, research on small airborne particles, i.e. aerosol research, has become the main research focus of the Laboratory. This aerosol focus has not changed substantially over the years.

After completing his doctoral research in solar energy, under Prof. R. C. Jordan, Prof. Benjamin Y. H. Liu joined the Mechanical Engineering Department as a faculty member in 1960. He began collaborating with Whitby in aerosol research in 1962. He was followed by Prof. Virgil A. Marple, who joined the faculty in 1970; Prof. Peter H. McMurry, who joined in 1977; Prof. Thomas H. Kuehn, who joined in 1983; and Prof. David Y. H. Pui, who joined in 1984. Prof. David B. Kittelson joined the faculty in 1970, with a research focus in internal combustion engines. His subsequent research, however, has been mainly in the area of particulate emission from diesel engines and, because of the importance of aerosol measurement in diesel emission and control, has become closely allied with the research of the Particle Technology Laboratory. Chapter 20 of this book (“Review of Particle Size Distribution Measurements of Engine Exhaust Before 1985,” by Gilmore J. Sem, Oliver F. Bischof, and Kittelson) describes Kittelson’s diesel particulate emission and control research.

As a group, the individual faculty members collaborated with each other extensively. Each has also established his own research specialty and focus. In subsequent sections, this chapter briefly summarizes the contributions of each individual faculty member.

Kenneth T. Whitby

Whitby played an active, leadership role in the laboratory and helped to establish the research program and nurture younger faculty members as they joined the laboratory. He served as the laboratory director from 1956 to 1972, followed by Liu (1972–1995) and Pui (1995–present). He was active in the air pollution community and served on the Clean Air Scientific Advisory Committee of the U.S. Environmental Protection Agency (EPA). He was elected to the National Academy of Engineering in 1978 for his contribution to aerosol instrumentation and air-quality measurement. Whitby's untimely death in 1983 marked a great loss to the department and the laboratory.

Whitby's contribution to aerosol research included instrumentation and measurement techniques, as well as research on aerosol filtration and atmospheric aerosol characterization. He was interested in using sensor-based aerosol measuring techniques to study the changing concentration and size distribution of aerosols caused by mixing, transport, sedimentation, and/or coagulation. In 1966, he developed an electrical particle counter for measuring aerosol size distribution in the 0.01 to 1.0 μm range (Whitby & Clark, 1966). The instrument uses a sonic jet ionizer, which he had developed earlier (Whitby, 1961), as a unipolar ion source for charging particles by ion diffusion. The counter then measures aerosol size distributions by electrical mobility, using an electrometer as a charge detector. Figures 1 and 2 show, respectively, a schematic diagram and a photograph of the prototype instrument. Thermo-Systems Incorporated (TSI), later developed the instrument as a commercial product, principally through the effort of G. J. Sem and his colleagues. The instrument was marketed as a Whitby Aerosol Analyzer (WAA) and was used in both ambient and laboratory aerosol studies.

Whitby also experimented with commercially available optical particle counters (OPC) to determine their size response and the effect of particle refractive index and shape on instrument response. He developed techniques to generate chain aggregate aerosols and measured the response of the OPC to the chain aggregate particles (McFarland & Tomaidis, 1969a, 1969b). He then combined the measurement capability of the WAA in the 0.01 to 1.0 μm range



Kenneth T. Whitby

Photo: Courtesy of the authors.

with the measurement capability of the OPC in the 0.3 to 10 μm range to measure aerosols in the 0.01 to 10 μm range. With funding from the EPA and other governmental agencies, he developed several such instrument systems to measure atmospheric aerosols in cities across the country. A typical system included a WAA, one or more OPCs, one or more condensation nucleus counters (CNCs), a computer, and additional manual sampling devices; the system could be used to conduct research on the size distribution of aerosols with a time resolution and size range that older, more traditional approaches could not achieve.

The first such system, the Minnesota Aerosol Analyzing System (Whitby et al., 1972b), was used in the Los Angeles Smog Study to characterize the smog aerosol size distribution from August 19 to September 19, 1969. Figure 3 shows the average size distribution of aerosols measured during the 4-week measurement period (Whitby et al., 1972a). The figure also includes similar measurements made in Minneapolis by William E. Clark (1965) and Carl M. Peterson (1967), as well as results reported by other researchers using different

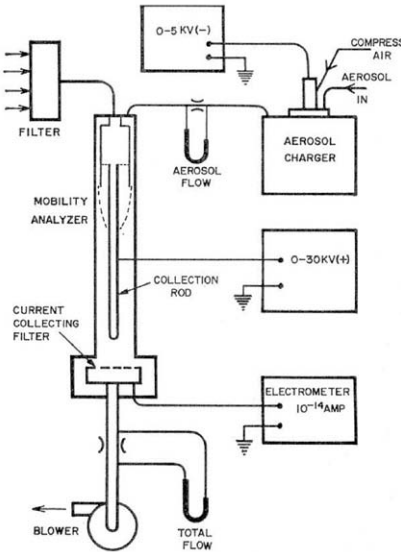

Figure 1. Schematic diagram of the electrical particle counter.

Source: Whitby & Clark (1966). Reprinted with permission from Wiley-Blackwell.

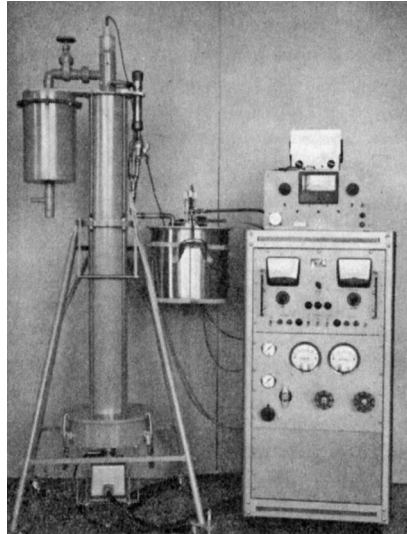

Figure 2. The electrical counter system showing the mobility analyzer, charger, and electric and flow instrumentation.

Source: Whitby & Clark (1966). Reprinted with permission from Wiley-Blackwell.

measurement techniques. Both Clark and Peterson were graduate students working in the Particle Technology Laboratory under Whitby's direction. He was generally credited for having developed the volume size distribution plot shown in Figure 3 that has helped to explain the nature and sources of atmospheric particles. Large particles with a mode in the 30 to 60 μm range—the “coarse-mode aerosol”—are thought to come from wind-blown dust, or generated by other mechanical processes, such as road dust suspended by vehicle traffic or plant debris. Fine particles with a peak diameter in the 0.1 to 1.0 μm range—the “accumulation-mode aerosol”—are thought to originate from combustion and atmospheric gas-to-particle conversion processes that have accumulated in this range through subsequent coagulation, sedimentation, removal, and other atmospheric transformation processes.

An interesting study in automotive aerosol emission occurred in 1975; the EPA and General Motors sponsored the study, using university and government laboratories as participants to take part in the measurement. This Sulfate Aerosol Dispersion Study was conducted at the General Motors proving ground in Milford, Michigan, in October 1975. In this study, 352 cars were driven around a 10 km test track, while observers made measurements at the roadside. The cars were equipped with catalytic mufflers for exhaust gas treatment, which also converted sulfur in the fuel to sulfate aerosols upon emission. The measured size distribution (Wilson et al., 1977) was found

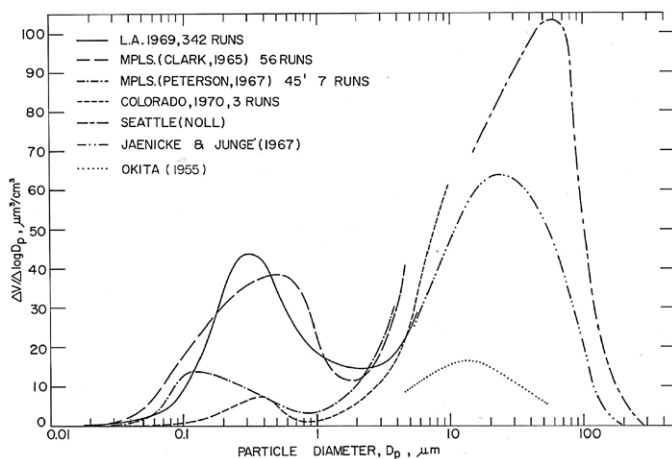

Figure 3. The bimodal size distribution of atmospheric aerosols.

Source: Whitby et al. (1972b). Reprinted with permission from Elsevier.

to be trimodal (as Figure 4 shows), having a pronounced “nuclei mode” at approximately 0.02 μm in diameter.

Whitby had a keen interest in aerosol instrumentation. Earl O. Knutson, a doctoral student working under Whitby’s direction, developed a theory on the transfer function of the differential mobility analyzer (DMA). Knutson and Whitby showed that the DMA had a triangle-shaped transfer function (Knutson & Whitby, 1975a) and was capable of resolving the mobility of uniform polystyrene latex spheres carrying discrete units of electronic charges, as shown in Figure 5 (Knutson & Whitby, 1975b). The DMA subsequently became a key measuring instrument in the aerosol field. Several people contributed to the development of the device in the Particle Technology Laboratory. Liu and Pui (1974a) worked independently to develop the DMA as an electrostatic particle size classifier to generate monodisperse aerosols for instrument calibration and experimental purposes. More information about Whitby and his work can be found in Sem and colleagues (2005).

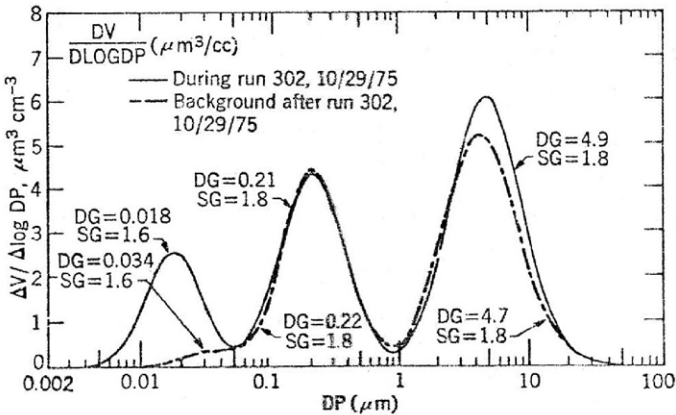

Figure 4. Trimodal aerosol size distribution measured at the General Motors Proving Ground on October 29, 1975.

Source: Wilson et al. (1977). Reproduced with permission of the Air and Waste Management Association from the *Journal of the Air Pollution Control Association* via Copyright Clearance Center, Inc.

Benjamin Y. H. Liu

Liu joined the mechanical engineering faculty after completing his doctoral studies in solar energy. In 1962, Liu began his aerosol research in collaboration with Whitby in the Particle Technology Laboratory. He became a full professor in 1969 and the director of the laboratory in 1972. He was elected to the National Academy of Engineering in 1987 for his contribution to aerosol and solar energy research. In 1995, he was named a Regents' Professor, the highest academic honor given to a faculty member at the University of Minnesota. He retired from the University in 2002 and became the president and chief executive officer of MSP Corporation, a company he cofounded with Prof. Virgil A. Marple. At MSP, he continued his aerosol research, making new inventions and creating new products for commercial applications. The company has developed new aerosol research instruments; products for testing of metered-dose inhalers, dry-powder inhalers, and other inhaled drug delivery devices; and equipment for use in semiconductor applications, including wafer surface inspection and thin film deposition by atomic layer deposition through molecular self-assembly on the surface and by conventional chemical vapor deposition processes.

Liu's interest in aerosol research covers a wide range of topics. Over an academic career of 42 years, he and his students and colleagues have published many papers on aerosol instrumentation, experimental techniques, theoretical and experimental studies in aerosol filtration, inertial turbulent deposition, and charging and neutralization of aerosol particles, among other topics. Realizing that complex aerosol problems were generally not amenable to solution by classical analytical methods, they were among the first to apply computer-based numerical methods for basic aerosol research in filtration, inertial impaction, aerosol charging by ion drift, diffusive ion transport in an external electric field, and so forth.

As a founding director and past president of the American Association for Aerosol Research and an editor-in-chief (with David Shaw of the University of New York at Buffalo and David Ensor of Research Triangle Institute) of the journal *Aerosol Science and Technology*, Liu has also contributed to the field's general scientific and professional development. He and his University of Minnesota colleagues have contributed to the expanding awareness of aerosols



Benjamin Y. H. Liu

Photo: Courtesy of the authors.

in the larger scientific and technical community by providing it with training opportunities for professionals involved in aerosol work through the short-course offering at the University of Minnesota entitled "Aerosol and Particle Measurement"; this short course has been offered annually since 1978. They have also helped to promote international cooperation in aerosol science by organizing the First International Aerosol Conference in 1984 in Minneapolis and establishing the International Aerosol Research Assembly for organizing international aerosol conferences among the collaborative aerosol societies in different countries. In 1994, the aerosol societies of the United States, Europe, and Japan awarded Liu the Fuchs Memorial Award for his research and efforts in the aerosol field. Liu was elected to the National Academy of Engineering in 1987 for his contribution to solar energy and aerosol research, and the University of Minnesota named him a Regents' Professor in 1993. He also received an honorary doctorate from the University of Kuopio in Finland.

Experimental Aerosol Science

Liu and his students and colleagues have contributed to experimental aerosol science by developing instruments and experimental techniques for calibrating optical particle counters (Whitby & Liu, 1967; Liu et al., 1974a; Willeke & Liu, 1976; Szymanski & Liu, 1986; Liu & Szymanski, 1987), diffusion batteries (Sinclair et al., 1976), and condensation nucleus counters (Liu et al., 1975; Liu & Kim, 1977). They have also developed various atomization, condensation, and fluidized-bed aerosol generators for aerosol research (Liu, 1974; Liu et al., 1966; Tomaidis et al., 1971; Liu & Lee, 1975; Marple et al., 1978; Liu & Levi, 1980). Many of these techniques have since been used or adapted by others for laboratory research in air pollution, industrial hygiene, cleanrooms, and microcontamination control. In addition, Liu and colleagues have also contributed to the development of experimental methods for measuring electric mobility (Wahi & Liu, 1971) and charge on aerosol particles (Liu et al., 1967a, 1969a; Whitby & Liu, 1968; Liu & Pui, 1974b) and have studied the light scattering and ionization smoke detectors to determine their performance (Mulholland & Liu, 1980). Other experimental contributions include research on the electrostatic effects in aerosol sampling and filtration (Liu et al., 1985a), and size distribution measurement of atmospheric (Whitby et al., 1969, 1972a, 1972b, 1975; Husar et al., 1972) and laboratory generated aerosols (Liu et al., 1969b, 1982a; Sinclair et al., 1979; Mulholland et al., 1980), aerosols in the workplace environment (Liu et al.,

1974b) and in the cleanroom (Liu et al., 1985b, 1986a). Additionally, they have contributed to the study of particle fragmentation during evaporation (Iribarne et al., 1977), methods for generating (Bartz et al., 1984) and measuring (Brockmann et al., 1982a, 1984) ultrafine aerosols, and particle dispersion by shock and expansion waves (Roth et al., 1984).

Monodisperse Aerosol Standards and Instrumentation

The development of particle size standards for aerosol research is a topic of considerable interest to Liu. He and his students have developed the vibrating orifice and mobility classification techniques for generating aerosols with a uniform and known particle size to use as size standards in instrument calibration and experimental studies. These techniques can generate a variety of aerosol materials with different physical and/or chemical properties to provide size standards from about 0.01 μm to more than 40 μm in diameter, covering nearly the entire size range of interest in aerosol studies.

The vibrating orifice technique uses a small vibrating orifice to produce a stream of uniform droplets with a piezoelectric ceramic, while maintaining a constant and steady liquid flow through the orifice, to form a jet. Figure 6 is a schematic diagram of the droplet generator that Liu, Berglund, and Agarwal (1974a) describe, and Figure 7 shows the uniform droplet stream generated by the device. Using the vibrating orifice droplet generator, Liu and colleagues developed a monodisperse aerosol generating system that includes additionally a turbulent air jet to disperse the uniform droplet stream from the droplet generator to prevent coalescence, a syringe pump to provide a

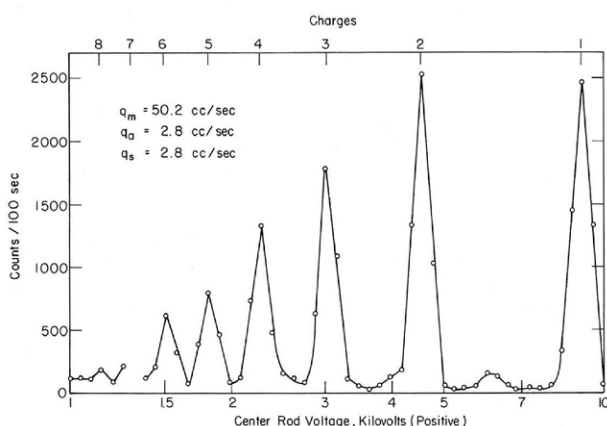

Figure 5. Mobility analyzer response to a neutralized polystyrene latex aerosol.

Source: Knutson & Whitby (1975a). Reprinted with permission from Elsevier.

controlled and known rate of liquid flow through the orifice, and a krypton-85 radioactive ionizer to neutralize the aerosol electrical charge. Uniform dioctyl phthalate (DOP) droplets of $9.5\ \mu\text{m}$ diameter and solid $3.7\ \mu\text{m}$ methylene blue particles generated by the system are shown in Figures 8 and 9.

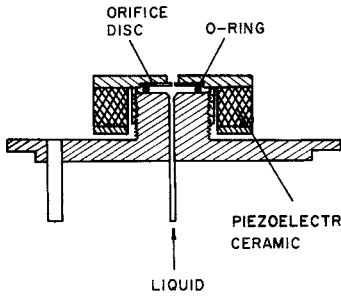

Figure 6. Monodisperse droplet generator of Berglund and Liu.

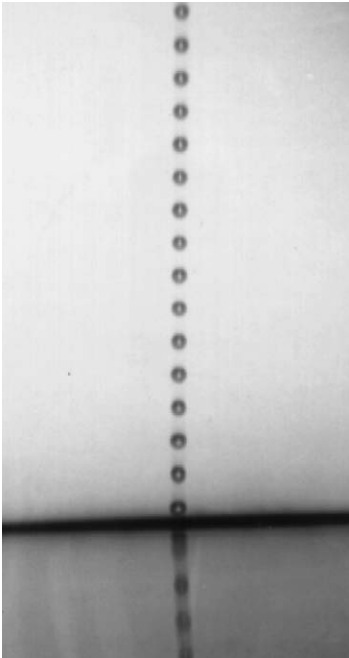

Figure 7. Uniform droplet stream produced by the Berglund-Liu droplet generator.

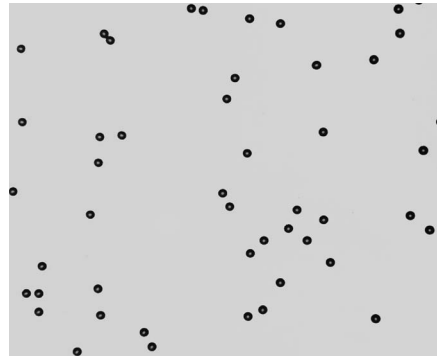

Figure 8. Monodisperse $9.5\ \mu\text{m}$ dioctyl phthalate aerosols generated by the Berglund-Liu generator.

Source: Liu et al. (1974a). Reprinted with permission from Elsevier.

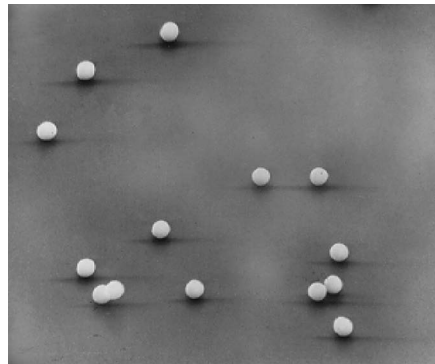

Figure 9. Monodisperse $3.7\ \mu\text{m}$ methylene blue particles generated by the Berglund-Liu generator.

The vibrating orifice device operates by the controlled disintegration of a liquid jet by an orifice, with an attached piezoelectric ceramic vibrating the orifice at a known frequency. Within its useful operating range, the device produces one single droplet per cycle of oscillation. The rate of droplet generation is thus equal to the vibrating frequency of the orifice, which is the same as the frequency of the alternating current voltage applied to the piezoelectric ceramic. As a result, the droplet volume, V_d , and its diameter, D_d , are uniquely related to the liquid flow rate, Q_l , and the vibrating frequency, f , as follows:

$$Q_l = V_d f = \frac{1}{6} \pi D_d^3 f \quad (1)$$

$$D_d = \left(\frac{6Q_l}{\pi f} \right)^{1/3} \quad (2)$$

To generate a monodisperse aerosol, a liquid solution is generally prepared by dissolving a nonvolatile material with the desired physical and/or chemical property in a volatile solvent to form a solution having a known volumetric concentration, c , of the material in the solution. When this solution is sprayed through the vibrating orifice to form monodisperse solution droplets, the solvent can be evaporated from the droplets to form a nonvolatile residue aerosol having a known particle diameter, D_p ; the particle diameter is relative to the diameter of the liquid solution droplets and the solution concentration according to the relation

$$D_p = c^{1/3} D_d = \left(\frac{6cQ_l}{\pi f} \right)^{1/3} \quad (3)$$

With this approach, the diameter of the generated particles can be calculated accurately by using the liquid flow rate, the vibrating frequency, and the volumetric solution concentration of the aerosol material in the solution, all of which can be easily measured. The accuracy of the calculated particle diameter is generally within ± 1 percent in routine use. With more careful measurement of the relevant operating parameters, an accuracy of ± 0.25 percent in particle diameter can be achieved without too great a difficulty. The tedious, time-consuming, and often less-accurate method of sizing aerosol particles by collecting them on a substrate and measuring the diameter by an optical or electron microscope can often be avoided by using the standard aerosols generated by the vibrating orifice.

The vibrating orifice technique has a lower particle limit of about 1.0 μm . For particles less than 1.0 μm in diameter, Liu and Pui (1974a) developed a mobility classification technique for generating submicron aerosols in the 0.01 to 1.0 μm range. The technique uses a compressed-air atomizer to form a polydisperse aerosol by spray drying a solution to form a polydisperse residue aerosol. A krypton-85 neutralizer then brings this aerosol to a state of charge equilibrium, and a DMA classifies its size to produce a monodisperse aerosol that carries one single elementary unit of charge. Because the operating conditions of the DMA determine the particle mobility according to the equation

$$Z_p = [q_c + \frac{1}{2} (q_a - q_s)] \frac{\ln(r_2 / r_1)}{2\pi VL} \quad (4)$$

and the mobility is related to the particle size according to Stokes's law with the slip correction

$$Z_p = \frac{eC}{3\pi\mu D_p}, \quad (5)$$

these theoretical relations can be used to calculate the particle size using the pertinent operating parameters used for aerosol generation. In equations 4 and 5, Z_p represents particle mobility; q_c , q_a , and q_s represent the clean air, polydisperse input, and monodisperse output sampled aerosol flow rates; r_1 and r_2 are the inner and outer radii and L is the classification length of the DMA; and V is the applied voltage on the high-voltage electrode in the DMA; μ is the gas viscosity, C is the particle slip correction, and e is the elementary unit of charge on the particles. Figure 10 shows the monodisperse, 0.05 μm sodium chloride (NaCl) particles generated by the mobility classification technique. For nonspherical particles, the particle diameter generated by the electrostatic classification technique is a mobility equivalent diameter (i.e., the diameter of a sphere having the same electric mobility as the nonspherical particle carrying the same elementary unit of charge).

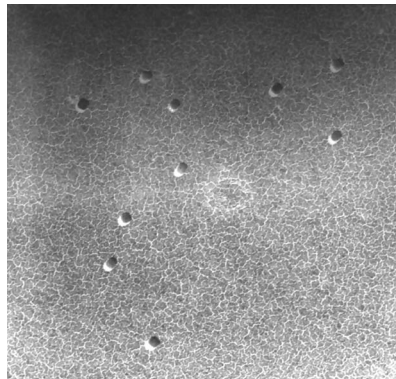

Figure 10. Monodisperse 0.05 μm sodium chloride particles generated by mobility classification.

Source: Liu & Pui (1974a). Reprinted with permission from Elsevier.

In addition, Liu and Pui have developed an electrometer-based concentration standard by collecting singly charged particles produced by the DMA into an electrometer sensor to produce a current flow. The measured current is related to the aerosol concentration, N , and the aerosol flow rate into the current detection. By measuring the electrometer current, I , and the aerosol flow, q , the aerosol concentration can be determined by the relationship

$$I = qeN, \quad (6)$$

where e is the elementary unit of charge. Figure 11 is the calibration result for a CNC (Liu & Pui, 1974a), using the electrometer current sensor as a concentration standard.

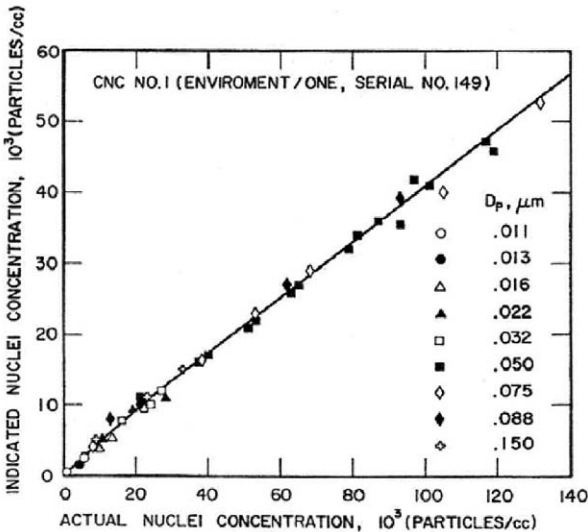

Figure 11. Calibration of the Environment/One Rich 100 condensation nucleus counter by the electrometer standard.

Source: Liu & Pui (1974a). Reprinted with permission from Elsevier.

The techniques described here have provided the basic standard for aerosol measurement for many years in many applications, including the calibration of the optical particle counters, electrical aerosol analyzers, condensation nucleus counters, and others. They have also been used extensively for aerosol research to determine the particle size–collecting characteristics of impactors and filter samplers as well as filtration devices for industrial air cleaning applications. The Berglund and Liu vibrating orifice technique has been accepted as the reference aerosol generation technique for calibrating size-selective $PM_{2.5}$ and PM_{10} samplers used in ambient air quality measurement to meet particulate air-quality standards in the United States.

Other significant instrument development effort includes the development of the pulse precipitating electrostatic aerosol sampler, a device for collecting quantitative samples of particles on a collecting substrate for electron and optical microscopy (Liu et al., 1967b; Liu & Verma, 1968) and the Electrical Aerosol Analyzer (Liu et al., 1974c, 1979; Liu & Pui, 1975; Pui & Liu, 1979), based on the unipolar charging and mobility analysis principle used in the WAA, but incorporating design improvement that resulted in the instrument being 5 times smaller and lighter than the WAA. Other contributions include the development of the aerosol mobility chromatograph, now referred to as the tandem-mobility analyzer (Liu et al., 1978), for measuring the changes in particle size caused by humidity or chemical reaction and the development of aerodynamic size measurement by the laser Doppler technique (Wilson & Liu, 1980; Liu et al., 1982b). Figure 12 shows the results of a predicted particle velocity downstream of a 1.0 mm diameter orifice with a gas flow of 12 m/s velocity showing the dependence of particle velocity on particle size and density and the underlying principle of the aerodynamic size measuring technique. Liu and colleagues also contributed to the theory of CNCs (Ahn & Liu, 1990a, 1990b; Zhang & Liu, 1991), which has helped to improve the understanding of how an important aerosol measuring technique operates.

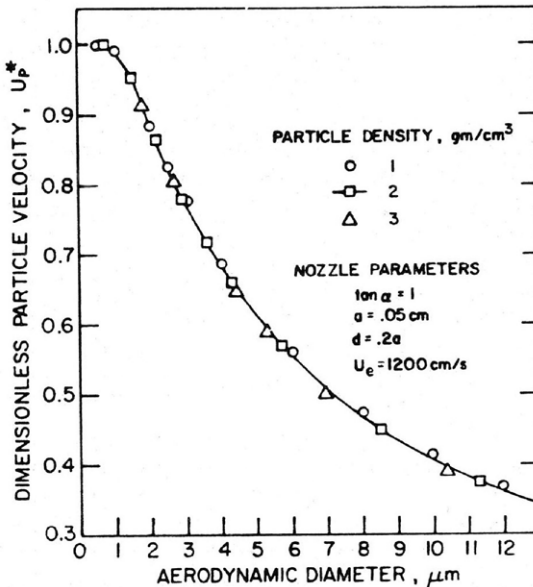

Figure 12. Calculated particle velocity as a function of aerodynamic diameter and particle density in a 1.0 mm diameter nozzle at a gas velocity of 12 m/s.

Source: Wilson & Liu (1980).
Reprinted with permission from Elsevier.

Aerosol Charging and Neutralization

The charging of aerosol particles by unipolar ions and their neutralization by a bipolar ion mixture are important topics in aerosol studies. Charging by unipolar ions occurs in the electrostatic precipitator, which is used extensively for air pollution control and in laboratory apparatus for aerosol studies. Neutralizing aerosol particle charge with a mixture of positive and negative ions produced by bipolar ion-generating sources minimizes unwanted electrostatic effects and thus is important to laboratory studies.

Liu and his students contributed to the theory of unipolar diffusion charging in the continuum regime (Liu & Pui, 1977); combined field and diffusion charging theories (Liu & Yeh, 1968; Liu & Kapadia, 1978); the theory of aerosol neutralization using radioactive sources, including krypton-85 and polonium-210 ionizers (Liu & Pui, 1974c; Liu et al., 1986b); the measurement of charge on contaminant particles generated in computer disk drives (Pui et al., 1988); the development of the high-efficiency unipolar charger (Adachi et al., 1990); and the development of aerosol charge neutralization in microelectronic cleanrooms (Liu et al., 1987a). The charging and neutralization theories that they have developed have provided the fundamental knowledge base for the charging process in general and the application of particle electrostatics to aerosol measurement and charge control in particular. The use of the radioactive krypton-85 and polonium-210 ionizers for charge neutralization has become popular as a result of their study on the operating principle of the device leading to the correct use of such devices for aerosol charge neutralization in experimental aerosol physics and science.

The combined field and diffusion charging theory that Liu and Kapadia (1978) developed is based on the numerical solution of the steady state equation for ion diffusion

$$\nabla \cdot [D\nabla N - ZN\nabla V] = 0 \quad (7)$$

in an external electrical field around a spherical particle produced by an applied electric field

$$V = \frac{ne}{r} + \left[\frac{r}{a} \left(\frac{K-1}{K+3} \right) \frac{a^2}{r^2} \right] E_0 a \cos \theta . \quad (8)$$

In equations 7 and 8, D is the diffusion coefficient of the unipolar ions, Z is the ion mobility, V is the electrical potential around the particles, n is the number of unit of charge on the particles, e is the elementary unit of charge,

K is the dielectric constant, E_0 is the applied electric field, and r and θ are the polar coordinates centered around the particle.

Figure 13 shows the theoretical prediction of the combined charging of aerosol particles by diffusive ion transport in an external applied electric field and its comparison with the experimental data. Figure 14 shows the measured ionization current in a krypton-85 aerosol charge neutralizer, which is useful for determining the ion concentration in the device to meet different aerosol charge neutralization needs.

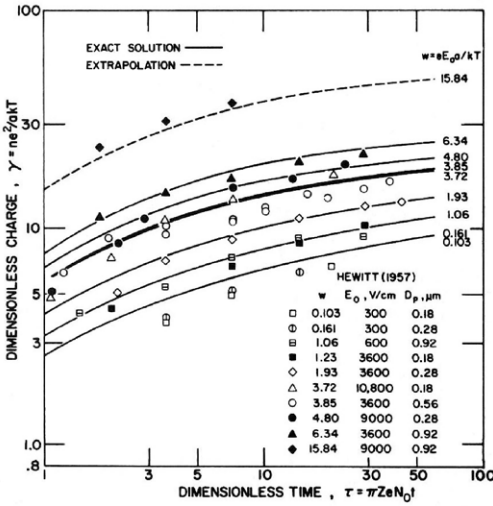

Figure 13. Comparison of the combined field and diffusion charging theory with experimental data.

Source: Liu & Kapadia (1978). Reprinted with permission from Elsevier.

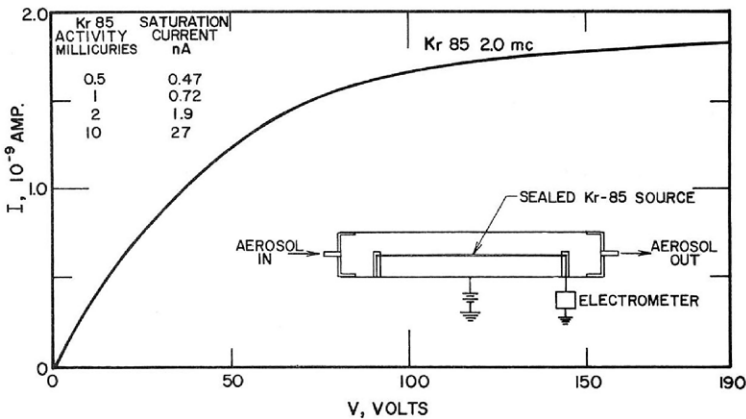

Figure 14. Measurement of ionization current and charge concentration in a krypton-85 neutralizer

Source: Liu & Kapadia (1978). Reprinted with permission from Elsevier.

Aerosol Filtration

Liu's major contributions to the aerosol field include the development of the theory of aerosol filtration using fibrous filters and taking into account the combined effect of particle collection by diffusion, interception, and inertial impaction (Yeh & Liu, 1973a, 1973b); the theory of fibrous filters based on the boundary layer approach and Kuwabara flow (Rubow & Liu, 1986; Lee & Liu, 1982a); theories of filtration in the most penetrating particle size range (Lee & Liu, 1980) and in the transition regime (Zhang & Liu, 1992); and characteristics of air filters with rectangular fibers (Fardi & Liu, 1992a, 1992b). Experimental contributions include the development of filter testing methods using monodisperse aerosols (Yeh & Liu, 1973b; Liu & Lee 1976; Lee & Liu, 1982b); experimental techniques applied to studying the performance of air-sampling filter media (Liu & Kuhlmeier, 1977; Liu et al., 1983a), high-efficiency filters used in microelectronic cleanrooms (Liu et al., 1985c), and ultra-high-efficiency membrane filters for high-purity gas filtration in semiconductor device manufacturing (Accomazzo et al., 1983; Rubow & Liu, 1984, 1985; Rubow et al., 1988); techniques for testing industrial cartridge filters (Liu et al., 1986c; McDonald et al., 1986; Barris et al., 1986); ultra-high-sensitivity filter leak detection methods (Sadjadi & Liu, 1991); and the filtration of diesel particles (Kittelson et al., 1984). Other contributions include the application of fundamental filtration theory to industrial filter design (Schaefer et al., 1986) and respirator filtration studies (Liu & Fardi, 1985; Liu & Japuntich, 1987; Fardi & Liu, 1991). The careful experimental measurement of the size-dependent single fiber efficiencies has led to the development of a universal correlation for filter performance in the diffusion and interception regimes, as well as theoretical methods for calculating the most penetrating particle size and peak aerosol penetration through filters. This work has influenced the filtration industry in its acceptance of modern filtration theory for industrial filter design. The high-sensitivity filter efficiency measurement method that Liu and his students have developed is capable of measuring filter penetration to the part-per-billion level and thus has made it possible to experimentally evaluate membrane filters used by the microelectronics industry for high-purity gas filtration. This research background in filtration allowed Liu and his colleagues in the Particle Technology Laboratory to establish the Center for Filtration Research, which carries out filtration research with funding support from participating companies in the filtration industry. The center was established in 1991 and still operates; it is currently led and directed by David Pui.

Classical aerosol filtration theory is based on the Kuwabara flow field based on the solution of the Navier-Stokes equation in the creeping flow regime. Using a staggered array model for the filter, Yeh and Liu (1973) showed that the Kuwabara flow field and the fan model filter of Stechkina and Kirsh were in substantial agreement with the numerical results. They then went on to apply the staggered array model to calculate the single fiber efficiency, taking into account the combined effect caused by particle diffusion, interception, and inertial impaction at a Reynolds number of 30, the point at which the classical flow models are no longer expected to be valid. Figures 15 and 16 show the numerical result for the flow field calculation and its comparison with the Kuwabara flow field and the fan model of Fuchs and colleagues at a Reynolds number of 0.4, as well as a similar calculation at a Reynolds number of 30, the point at which the Kuwabara and the fan models are not valid.

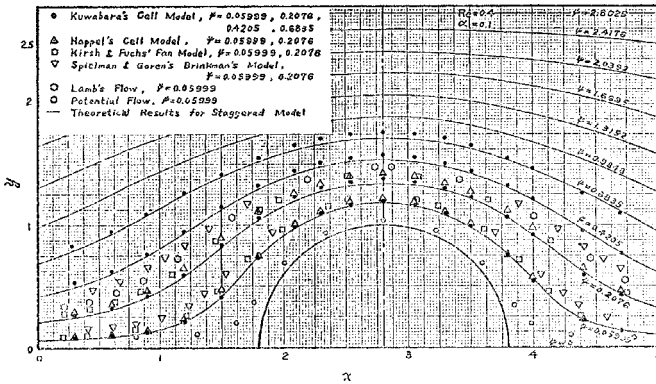

Figure 15. Numerical flow field calculation for a staggered array model at $Re = 0.2$.

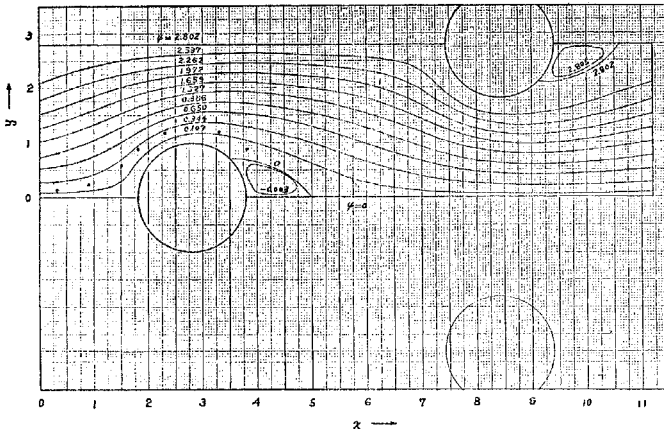

Figure 16. Numerical calculation flow field calculation for a staggered array model at $Re = 30$.

Subsequently, Lee and Liu (1982a, 1982b) used a boundary approach for filtration analysis and established the form of the dimensionless correlation between the single fiber efficiency, a dimensionless Péclet number, and the interception parameter for aerosol filtration in the interception and diffusion regimes. They then measured the single fiber efficiency using a model filter with a uniform fiber size and an aerosol filtration measuring system comprised of a monodisperse DOP aerosol generator and an electrical aerosol concentration detector. The results are then corrected in a dimensionless form as shown in Figure 17 and by the following equation:

$$\eta_s = 1.6 \left(\frac{1-c}{K}\right)^{\frac{1}{3}} Pe^{-\frac{2}{3}} + 0.6 \left(\frac{1-c}{K}\right)^{\frac{1}{3}} \frac{R^2}{1+R} \tag{9}$$

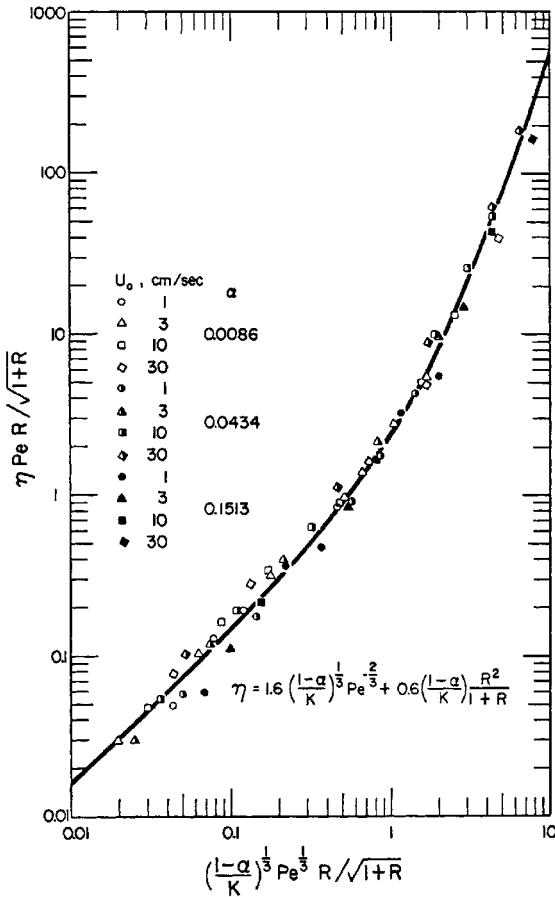

Figure 17. Correlation of single fiber efficiency with dimensionless parameters.

Source: Lee & Liu (1982a).

In Equation (9), η_s is the single fiber efficiency, Pe is the dimensionless Péclet number defined by

$$Pe = \frac{uD_f}{D}. \quad (10)$$

K is the Kuwabara hydrodynamic factor,

$$K = -\frac{1}{2} \ln c + \frac{1}{2} \frac{c^2}{1+c^2} - \frac{1}{2}, \quad (11)$$

and c is the fiber volume fraction in the filter, where u is the gas velocity through the filter, D_f is the fiber diameter, and D is the diffusion coefficient of the aerosol particles.

Inertial Impaction

Research on inertial impaction began with Virgil Marple's doctoral dissertation. As with filtration, Marple used computational methods to study the flow field and particle collection by inertial impaction. The work has led to several publications on the theory of impactors and particle collection by impaction (Marple et al., 1973, 1974; Marple & Liu, 1974, 1975). Other impactor studies examined the influence of coating thickness on particle bounce (Pak et al., 1992) and fundamental adhesion and bounce studies (Tsai et al., 1991a) and developed the micro-orifice and micro-orifice uniform-deposit impactors (Kuhlmeier et al., 1981; Marple et al., 1981) and the high-volume virtual and dichotomous samplers (Shanmugavelly et al., 1987; Marple et al., 1990). The application of computational fluid and particle mechanics methods to impactor studies has significantly improved the understanding of impactor performance and has facilitated the development of precision impactors for high-accuracy aerosol sampling in atmospheric pollution, industrial hygiene, and other fields of study. The micro-orifice and micro-orifice uniform-deposit impactors that Marple and Liu developed have made it possible to sample particles less than 100 nm using the impactor principle with a high flow rate and moderate pressure drops. Because of subsequent development by Marple, inertial impaction can now collect particles as small as 10 nm in diameter.

Inertial-Turbulent Deposition

Liu and colleagues' major contributions to inertial-turbulent deposition include the theory of aerosol deposition in turbulent pipe flow (Liu & Ileri,

1974) and the accurate measurement of turbulent deposition velocity by taking into account particle inertia and fluid turbulence in the inertial turbulent deposition regimes (Liu & Agarwal, 1974). The turbulent deposition data that Liu and colleagues collected are among the most accurate results that have been reported. The data have helped to resolve the theoretical uncertainty in the predicted deposition velocity according to the different theories. Figure 18 is a plot that shows the dimensionless deposition velocity, V_+ as a function of the dimensionless relaxation time, τ_+ of the particle based on the defined dimensionless parameters

$$\tau_+ = \frac{\tau v_*^2}{\nu} \quad (12)$$

$$V_+ = \frac{V}{v_*} \quad (13)$$

$$\tau = \frac{2pa^2C}{9\mu} \quad (14)$$

$$f = \frac{0.316}{4Re^{1/4}} \quad (15)$$

$$v_* = (f/2)^{1/2} \bar{u}. \quad (16)$$

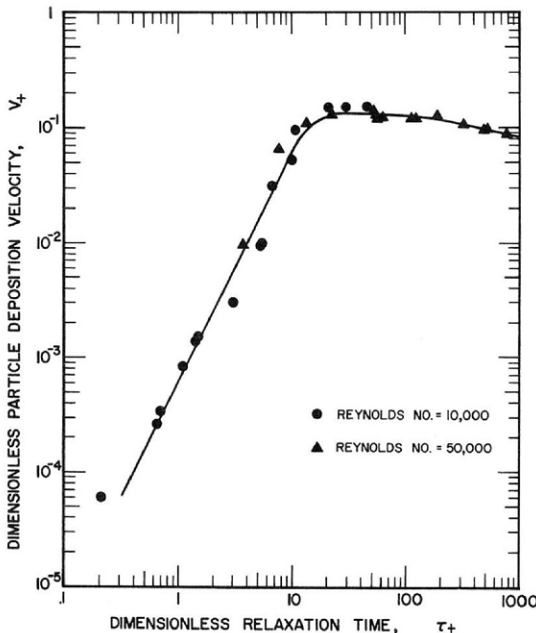

Figure 18. Dimensionless deposition velocity plotted against the dimensionless relaxation time of particles in turbulent pipe flow.

Source: Liu & Argarwal (1974).
Reprinted with permission from Elsevier.

In these equations, τ is the dimensionless relaxation time, v^* is the friction velocity, V is the deposition velocity, ρ is the gas density, a is the particle radius, C is the slip correction, μ is the gas viscosity, Re is the Reynolds number, f is the friction factor, and \bar{u} is the mean gas velocity in turbulent pipe flow.

Theory of Aerosol Sampling

Contributions in aerosol sampling include the development of the theory of aerosol sampling in calm air (Agarwal & Liu, 1980), the theory of anisokinetic sampling (Liu & Zhang, 1989; Zhang & Liu, 1989), as well as practical atmospheric aerosol sampling inlets (Liu & Pui, 1981, 1986), sampling inlets for industrial hygiene and respirator studies (Liu et al., 1983b), and a sampling inlet for flowing gas streams (Liu & Pui, 1985). The criteria for aerosol sampling in calm air has significantly improved the understanding of aerosol sampling in calm air and the conditions that must be met in designing calm-air sampling inlets. The theory of anisokinetic sampling provides the most comprehensive numerical calculation of anisokinetic sampling errors, including errors caused by particle deposition inside the sampling inlet, an aspect that previous theoretical studies have not addressed rigorously.

Aerosol Studies in Contamination Control and Semiconductor Manufacturing

Liu established a Microcontamination Control Research Consortium in the Particle Technology Laboratory to support basic and applied research on particle-related problems in semiconductor, integrated circuit device manufacturing. The consortium received financial support from 15 member companies over a period of 12 years and conducted research on various topics of interest to the semiconductor industry. With the support of the consortium, Liu and his students and or colleagues carried out research and contributed to the development of the theory of aerosol deposition on semiconductor wafers that took into account deposition by diffusion, gravitation settling (Liu & Ahn, 1987; Liu et al., 1987b), and electrostatic (Liu, 1987) and thermophoretic effects (Ye et al., 1991a); the measurement of particle deposition on semiconductor wafers (Pui et al., 1990); the application of methods of computational fluid dynamic to cleanroom airflow studies (Shanmugavelly et al., 1987; Kuehn et al., 1988); the measurement of charge and size of particles generated in thin-film computer disk drives (Pui et al., 1988; Tsai et al., 1991b, 1991c, 1991d, 1992); the development of particle generation and deposition in computer head-disk assemblies (Ananth &

Liu, 1989; Campbell et al., 1990); the development of the absolute zero particle gas (Liu & Hsieh, 1989); the development of the noncontaminating fogger by quenching steam with liquid nitrogen to form a high-density, noncontaminating fog for air flow visualization in cleanrooms (Ramsey et al., 1988; Gallo et al., 1988); performance measurement of cleanrooms (Liu et al., 1986a; Brown et al., 1989) and cleanroom filter systems (Sadjadi & Liu, 1991); and the development of theoretical and experimental studies of wafer surface scanners (Lee et al., 1992; Kwok & Liu, 1992). The research has helped to establish aerosol science as a recognized area of study in semiconductor device manufacturing and has provided graduates of the program with satisfying career opportunities in the industry. The noncontaminating fogger that they developed has been used to visual air flow in the cleanroom near the production area where products are being made to help improve manufacturing and reduce contaminant deposition on the wafer.

With the support of the consortium, Liu and his colleagues and students also conducted studies of condensation-induced residue particle generation during vacuum pump-down and in vacuum semiconductor processing equipment (Zhao et al., 1991; Liu et al., 1991, 1992; Chae et al., 1992), as well as theoretical and experimental studies of high-purity liquid filtration and filtration mechanisms (Grant & Liu, 1991; Kuehn et al., 1992) and the droplet-flattening effects of surface collection (Tsai et al., 1991a).

Other Research Contributions

Liu and colleagues have also made other basic contributions, including data inversion by simplex minimization (Helsper et al., 1982); the theory of size distribution of atmospheric aerosols (Liu & Whitby, 1968); the theory of momentum, heat, mass, and charge transfer in the transition regime (Bademosi & Liu, 1971); coagulation and diffusion loss of aerosols in turbulent pipe flow (Brockmann et al., 1982b); and particle deposition in pipe bends (Liu et al., 1988). In addition, he and his students and colleagues have also conducted research in particle measurement and control in coal gasification and fundamental studies in spray painting (Liu, 1992).

Virgil A. Marple

Virgil Marple started his research at the Particle Technology Laboratory in 1967 as a PhD candidate. His doctoral dissertation, the basis for much of his future work, was entitled *A Fundamental Study of Inertial Impactors* (Marple, 1970). At that time, he acquired a preprint of a book on computational fluid dynamics (CFD) analysis from the Imperial College in London (Gousman et al., 1969), which solved the Navier-Stokes equations with no simplifying assumptions for laminar flow. Although the book was written for CFD analysis of heat and mass transfer in recirculating flows, Marple modified the program to model the flows in inertial impactors of both rectilinear and cylindrical coordinates to enable the modeling of rectangular jet and round jet impactors. Marple then wrote a program that would trace single particle trajectories through the flow field and determine whether the particles struck the impaction plate or exited with the flow from the impaction region. Marple constructed the impaction collection efficiency curve by starting particles of different sizes at different locations across the entrance to the impactor nozzle. This was likely the first time that CFD analysis had been applied to determine flow field and particle trajectories in aerosol sampling instruments.

To determine that the CFD-generated flow fields were correct, Marple constructed a water model using a 20-gallon aquarium tank and a Plexiglas model of a rectangular nozzle impactor. Marple pumped an electrolytic solution consisting of water, sodium hydroxide, hydrochloric acid, and methyl blue pH indicator through the impactor model. The solution was titrated to be slightly acidic, and the color of the fluid was then a light orange. Cathode wires were placed at strategic points in the impactor model, and the fluid would turn a dark blue in the immediate vicinity of the cathodes. This blue fluid became dark streamlines in the light orange fluid. Marple then compared photographs of these streamlines with CFD-generated streamlines in impactors of the same configuration. The comparison found very good agreement, and Marple then used the CFD analysis of the flow fields for the fundamental study of impactors.

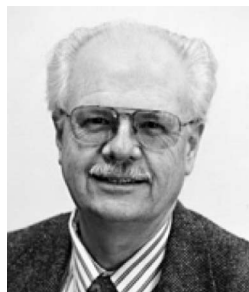

Virgil A. Marple

Source: Photo courtesy of the authors.

Constructing a “variable point impactor” that could introduce particles at various points across the inlet checked the CFD determination of the particle trajectory. A mixture of polydisperse solid methylene blue particles and solid polystyrene latex (PSL) particles were generated in a spinning disk aerosol generator and were then introduced into the impactor at precise locations across the inlet. Marple then compared the impaction points on the impaction plate for the various sized particles with the CFD results, and again, the agreement was good.

With experimental verification that the flow fields and particle trajectories from the CFD analysis were accurate, Marple and colleagues performed a fundamental study of impactors, in which they constructed particle collection efficiency curves for various Reynolds number values, jet-to-plate distances, and throat lengths for both round and rectangular jet impactors. Results from various parts of the study were published in papers (Marple et al., 1973, 1974; Marple & Liu, 1974, 1975). Marple and Rader (1985) later refined the study using ultra-Stokesian drag and a smaller grid.

The results from the study have been widely cited and have become one of the important contributions from the Particle Technology Laboratory in the 1970s as evidenced in letters from Dr. N. Fuchs to Whitby (1975) and Liu (1980). Fuchs commented to Dr. Whitby, “Of the works done lately at your laboratory I have been most impressed by that of Marple.—Please tell him about my high opinion of his classical work” (N. Fuchs, personal communication, 1975). And Fuchs stated to Dr. Liu:

Whereas there exist [sic] a substantial theory of jet impactors based chiefly on the brilliant theoretical and experimental work performed under your guidance by V. Marple, our knowledge of the “wide flow” [body] impaction on various objects is still insufficient although much work has been done on this subject. (N. Fuchs, personal communication, 1980)

Another facet of this work is that the logo for the American Association for Aerosol Research (AAAR) is a stylized version of an impactor flow field from Marple’s doctoral dissertation (Marple, 1970). Figure 19 shows the AAAR logo and a computer-generated flow field from the dissertation.

With the understanding derived from the fundamental study of impactors, many impactors were designed, built, and evaluated. Figure 20 shows many of these impactors. The impactor stage shown in the center of this figure is the same in all of these impactors; other design criteria are the cause for the

wide variety of designs. These impactors include (1) the micro-orifice uniform deposit impactor (MOUDI) that uses micro-orifice nozzles to collect particles as small as $0.056\ \mu\text{m}$ and rotation of the impaction plates to obtain a uniform deposit on the impaction plate (Marple, 1978; Marple & McCormack, 1983; Marple et al., 1991); (2) the nano-MOUDI that adds three smaller cut stages to the MOUDI (Marple & Olson, 1999); (3) the Marple, Spengler, and Turner (MST) $\text{PM}_{2.5}$ and PM_{10} indoor air sampler (Marple et al., 1987); (4) the Marple personal cascade impactor (MPCI) (Rubow et al., 1987); (5) the micro-environmental monitor (MEM), an indoor impactor/filter sampler with cut sizes of 10 or $2.5\ \mu\text{m}$ and operates at 10 l/min; (6) the respirable impactor (RI), a single-stage impactor that has either American Conference of Governmental Industrial Hygienists (ACGIH) or British Medical Research Council (BMRC) respirable cuts at flow rates of either 2 or 30 L/min (Marple, 1978; Marple & McCormack, 1983); (7) the personal dust aerosol sampler (PDAS), a 2 L/min personal sampler with a respirable cut cyclone first stage and $0.8\ \mu\text{m}$ cut impactor second stage to separate coal dust particles from diesel exhaust particles in dieselized coal mines (Marple et al., 1995b); (8) the Marple-Miller impactor (MMI), built as either a 30 or 60 L/min cascade impactor for the pharmaceutical industry (Marple et al., 1995a); (9) the next-generation pharmaceutical impactor (NGI), a cascade impactor that operates at any flow rate from 15 to 100 L/min (Marple et al., 2003a, 2003b, 2004); and (10) the personal environmental monitor (PEM), a two-stage impactor/filter sampler that operates from 2 to 10 L/min and has cut sizes of 1.0, 2.5, or $10\ \mu\text{m}$.

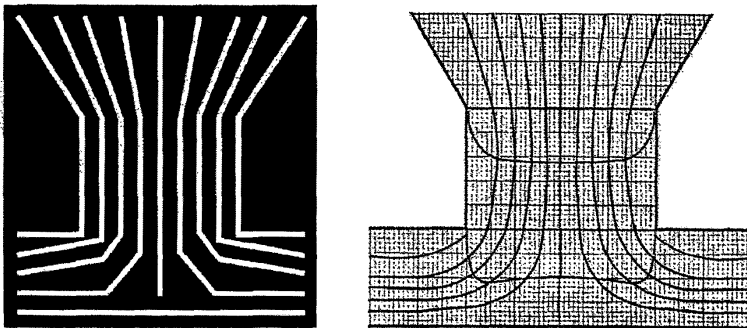

Figure 19. American Association for Aerosol Research logo (left) and flow field streamlines from Virgil Marple's (1970) dissertation *A Fundamental Study of Inertial Impactors* (right).

Source: Logo reproduced with permission from the American Association for Aerosol Research (AAAR).

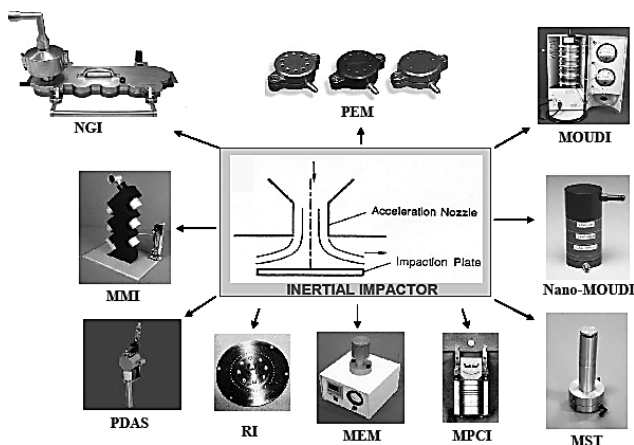

Figure 20. Various single stage impactors and cascade impactors designed from basic impactor concept.

Five of these impactors, the MOUDI, the nano-MOUDI, the MPCI, the PEM, and the NGI are widely used and deserve some explanation. The MOUDI was initially developed for EPA to conduct source apportionment studies (Marple et al., 1991). EPA requested that an impactor be developed that would spread the particles out uniformly on a 35 mm substrate so that the composition of the particles could be analyzed by X-ray fluorescence. This development was achieved by using multiple round nozzles on each stage and rotating the impaction plate relative to the nozzles. Each nozzle was located at a different distance from the center of rotation to obtain a uniform deposit. The micro-orifice feature was developed to achieve cut sizes as small as $0.056\ \mu\text{m}$ at relatively high pressure drops across the nozzles. Each stage uses 2,000 nozzles that are approximately $50\ \mu\text{m}$ in diameter each. Fang et al. (1991a) performed a study to determine how small the cluster diameter could be on a stage of multiple round nozzles before the cross-flow would lessen the sharpness of cut.

The nano-MOUDI was an extension of the MOUDI that allowed for three additional stages to obtain cut sizes as low as $0.010\ \mu\text{m}$. Relative humidity changes in the impaction region of the micro-orifice stages caused some concern, but Fang et al. (1991b) showed that the effect on this variable was small.

Our laboratory also provided instrument development work for the National Institute of Occupational Safety and Health (NIOSH), most notably the development of the Marple Personal Impactor (Rubow et al., 1987). The Particle Technology Laboratory originally developed the impactor to determine the size distribution and concentration of wood dust to which workers were exposed in machining hardwoods. The impactor used rectangular nozzles and integral nozzle and impaction plates, enabling a compact design. This impactor later found wide use in many types of personal sampling studies.

The PEMs were developed with cut sizes of 10, 2.5, and 1.0 μm for widespread personal sampling in EPA studies. They have a unique design with just three pieces that form the base, final filter, impaction plate, and nozzle plate. The standard PEM has 10 nozzles and operates at 10 L/min, or 1 L/min per nozzle. Other reduced flow rate impactors are created by simply reducing the number of nozzles. Using this technique, impactors of different flow rates can have identical flow fields and identical particle collection characteristics.

The NGI is an eight-stage impactor that Marple et al. (2003a) developed for the pharmaceutical industry to allow for easy automation. The NGI is unique because all of its impaction plates are on one plane. A quick-release locking handle enables a plate containing the nozzles of all stages to be lifted, exposing a tray with all of the impaction plates. Experimenters can remove this tray, insert another one, and close the impactor; the impactor is then ready for another run. This mechanism allows for much faster turnaround times than those for impactors in which the impaction plates are internal to a stack of nozzle plates. The impaction plates of the NGI are actually external to the impactor, allowing for easy access. The MMI also uses external impaction plates, in the form of external collection cups.

Some impactors that the Particle Technology Laboratory developed had respirable cut penetration curves. These impactors used multiple round or rectangular nozzles with different size nozzles on one stage. The number of nozzles and size of the nozzles were controlled such that the overall collection efficiency curve matched either the ACGIH or the BMRC respirable curves (Marple, 1978; Marple & McCormack, 1983).

Marple and Chien (1980) performed a study on virtual impactors that was similar to the fundamental study of inertial impactors. It was a parametric CFD study of virtual impactors similar to the one performed for plate impactors. The results from the CFD study of virtual impactors were used to

design virtual impactors with sharper cuts, lower minor flow ratios, and lower particle losses than previous virtual impactors.

The most widely used virtual impactor that the Particle Technology Laboratory developed was a 2.5 μm cut high-volume virtual impactor (HVVI) developed for EPA to separate wood smoke particulate from other fugitive dust in areas in which there was substantial wood burning in home fireplaces (Marple et al., 1990). This virtual impactor operates at 40 ft^3/min and fits inside the Andersen high-volume 10 μm sampling head. The dimensions could be kept small by using a total of 12 virtual impactors, with 6 virtual impactors on each side of a cavity. The virtual impactors are located such that the axis of the 6 pairs are lined up to allow the exit flows from the receiving tubes (minor flows) to collide in the center of the cavity, slowing the speed of the large particles and therefore not allowing them to strike the opposite wall of the cavity where they would be lost to the wall. The laboratory designed a special version of the HVVI with a cut size of 1.0 μm . This allowed a high-volume PM_{10/2.5/1.0} trichotomous sampler to be developed by using the 2.5 μm HVVI and the 1.0 μm HVVI in a cascade arrangement inside an Andersen 10 μm high-volume sampler (Marple & Olson, 1995; Lundgren et al., 1996).

Parallel with the ongoing research on impactors, from 1970 to 1983, the Particle Technology Laboratory also conducted research for the U.S. Bureau of Mines. In 1983, the laboratory became a charter member in the U.S. Bureau of Mines Mineral Technology Center for Respirable Dust, along with laboratories at Pennsylvania State University, West Virginia University, and the Massachusetts Institute of Technology. This work involved developing instruments and sampling techniques to measure the coal dust particle size distribution and concentration in order to reduce the occurrence of black lung disease (pneumoconiosis) in coal miners. Later, the work expanded to measuring the size distribution and concentration of diesel exhaust in dieselized coal mines. During this time, the laboratory developed instrument evaluation techniques and devices to evaluate these and commercially available instruments.

One of the devices to come out of this work was the fluidized bed dust generator, in which test dust was aerosolized from a fluidized bed of brass beads (Marple et al., 1978). The dust was fed into the fluidized bed from a dust supply chamber via a key-chain conveyer. The fluidizing action of the brass beads transferred the dust from the chain conveyer into the fluidized bed,

breaking up any dust agglomerates into primary particles. The particles were then separated from the large brass beads in an elutriation chamber directly above the fluidized bed. This chamber also housed a radiation source to bring the electric charge on the particles to Boltzmann equilibrium.

Another aerosol generator was the small-scale powder disperser, which was developed to aerosolize coal dust particles collected on a filter. The intended purpose was to collect coal dust particles on a filter from parts of the mine where conventional samplers could not be used and then bring the filter to the surface where the dust particles could be resuspended and sampled. The dust generator later found a use in “rafter sampling” analysis, in which dust samples that had been settling for years could be resuspended in layers to provide some idea of how the dust changed as a function of time. The widest use of this dust generator has been to aerosolize bulk powder samples for analysis.

Much of this instrument evaluation work was done in a dust chamber in the Particle Technology Laboratory. The chamber was 4 ft in diameter and 8 ft high. Dust was introduced at the top of the chamber and flowed downward in a quiescent flow over the instruments being evaluated. Baffles in the chamber distributed the particles fairly uniformly throughout the chamber. However, to ensure that all instruments were exposed to the same concentration of the aerosol, the floor of the chamber where the instruments were sitting was continually rotated (Rubow & Marple, 1982).

Because dust particles are relatively large compared with atmospheric aerosols, the laboratory found that gravitational settling could be substantial in inertial impactors. This finding resulted in the shifting and distortion of the particle collection efficiency curves normally attributed to impactors. The laboratory performed this study using CFD analysis and collection efficiency curves generated with the Froude number as a parameter (Marple et al., 1992).

The work with the mining industry included many field studies to determine the dust concentration and particle size distribution in the mines. Many of the field studies were in underground coal mines, but some work was done in gold, talc, salt, and other types of mines. There were also a few studies in open-pit coal and taconite mines.

One of the more important results for the Bureau of Mines was the discovery of how to separate coal particles from diesel exhaust particles

in mines that used diesel-powered equipment. The Particle Technology Laboratory did an extensive study of the diesel particulate size distribution in underground coal mines with the MOUDI sampler (Rubow & Marple, 1988). It was found that the coal dust particles were all larger than $0.8\ \mu\text{m}$ and the diesel exhaust particles were all less than $0.8\ \mu\text{m}$ (Rubow et al., 1990a). These discoveries led to the development of the PDAS and the virtual impactor personal aerosol sampler (VIPAS) that would separate particles at $0.8\ \mu\text{m}$, collecting the coal particles on one filter and the diesel particles on another (Marple et al., 1996). The exhaust particles from the diesel engines were small because the exhaust cooling water scrubbers removed the large exhaust particles.

In 1998 the Particle Calibration Laboratory was established for the expressed purpose of calibrating instruments. Although many instruments have been calibrated in the Particle Calibration Laboratory, the most notable was the calibration of the NGI for the pharmaceutical industry using Good Laboratory Practice procedures. This type of calibration is significant because as long as the NGI is built to this strict set of dimensions, no company in the pharmaceutical industry will have to recalibrate the instrument.

The work in the Particle Calibration Laboratory has led to the development of the multiplet reduction impactor (MRI). This impactor is attached to the exit of the vibrating orifice monodisperse aerosol generator (VOMAG) to remove all particles that have coalesced together to create particles larger than the primary particles. This allows the VOMAG-generated particles to be much more monodisperse than if the MRI were not used, providing for the high quality of particles needed to calibrate instruments accurately in the Particle Calibration Laboratory (Marple et al., 2005).

The Particle Calibration Laboratory also developed a new calibration technique for impactor evaluation and rapid check of cascade impactor cut sizes using a polydisperse challenge aerosol (Marple et al., 2005). In this technique, a polydisperse aerosol with a fluorescent dye tracer is generated and passed through the impactor. A histogram is constructed from the quantity of the aerosol deposited on each stage and the reported cut size of each stage. If the histogram does not show a smooth curve, one or more of the cut sizes of the impactor is incorrect. To find the correct cut sizes, the data are evaluated with DistFit (DisFitTM, 2004) and the various cut sizes used in DistFit are adjusted to minimize the chi-square value. When the chi-square value is minimized, the cut sizes are correct.

Peter H. McMurry

Peter McMurry joined the Particle Technology Laboratory as an assistant professor in 1977, immediately after he completed his PhD in environmental engineering sciences with a physics minor at Caltech. At Caltech, McMurry worked under the guidance of Prof. Sheldon Friedlander. His doctoral dissertation addressed the dynamic behavior of aerosols undergoing gas-to-particle conversion, including nucleation in the presence of a preexisting aerosol. His research has continued to explore new particle formation, primarily atmospheric aerosols.

In collaboration with colleagues, McMurry has also done research on characterizing properties of engine exhaust aerosols, contamination control in semiconductor processing equipment, and the synthesis of nanophase materials from nanoparticles produced in plasmas. His work has involved an integrated program of instrumentation development, theory and modeling, and experimental studies. He received the Fuchs Memorial Award in 2006, received a Guggenheim Fellowship in 2007, and became the editor-in-chief of *Aerosol Science and Technology* in 2008. He also served as the Head of the Mechanical Engineering Department from 1997 to 2007.

As with other Particle Technology Laboratory faculty, the development of new instrumentation has been a primary focus of McMurry. Significant contributions in this area include the ultrafine condensation particle counter (UCPC, commercialized as the “TSI 3025”) (Stolzenburg & McMurry, 1991), the use of working fluids other than butanol that extend the lower detection limit of condensation particle counters (CPCs) to sizes approaching 1 nm (Iida et al., 2009), the development of tandem techniques for measuring aerosol physical and chemical properties (Park et al., 2008), aerodynamic lenses (Liu et al., 1995a, 1995b; Wang et al., 2005a, 2005b; Wang & McMurry, 2006a, 2006b), and multi-angle light scattering (Sachweh et al., 1995; Dick et al., 1996, 1998, 2000a). These tools improved our ability to accurately characterize the chemical and physical properties of aerosols.

McMurry’s research on atmospheric aerosols has involved applications to visibility impairment, health effects, and global climatic effects of aerosols. Atmospheric observations have been the cornerstone of this work. McMurry’s group has carried out measurements at the North Pole on a Swedish



Peter H. McMurry

Source: Photo courtesy of the authors.

icebreaker, at the Mauna Loa observatory, above the Southern Ocean on a C130 aircraft, at the South Pole, as well as at many North American locations including Atlanta, Georgia, Los Angeles, California, St. Louis, Missouri, Mexico City, the Grand Canyon National Park, the Great Smoky Mountain National Park, and the Boulder, Colorado, area.

McMurry's early work on atmospheric aerosols focused largely on aerosol dynamics, especially for systems undergoing gas-to-particle conversion. He applied the concept of growth laws, originally introduced by Friedlander, to infer possible chemical mechanisms of particle growth by gas-to-particle conversion (McMurry et al., 1981; Wilson & McMurry, 1981; McMurry & Wilson, 1982, 1983). This work involved studying the dependence of particle growth rates on particle size. With colleagues, including Prof. J. Charles "Chuck" Wilson, McMurry showed that mass distributions of particles in dry climates tend to peak in the 0.2 to 0.3 μm range, whereas in more humid environments, average sizes range from 0.5 to 0.8 μm , as Figure 21 shows. McMurry and colleagues showed that this phenomenon occurs because the gas phase reactions, which lead to condensational growth primarily on small particles, dominate gas-to-particle conversion at low relative humidities, whereas liquid phase reactions are dominant at elevated relative humidities.

With Nagaraja Rao, McMurry carried out theoretical work on nucleation in the presence of an aerosol, results that continue to aid with interpreting atmospheric observations (McMurry, 1980, 1983; Rao & McMurry, 1989).

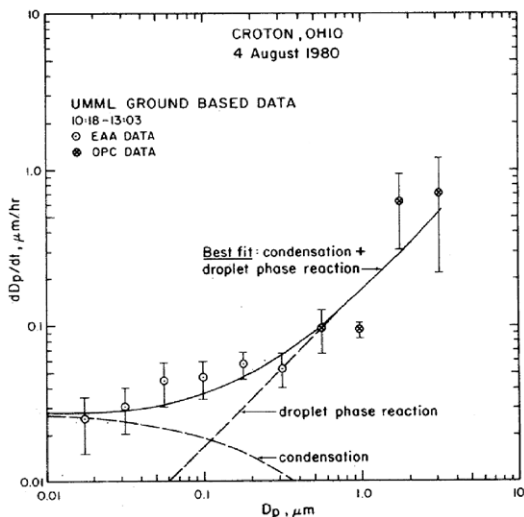

Figure 21. Contributions of condensation and droplet phase reactions to particle growth in the Columbus, Ohio, urban plume obtained using "growth law" analyses. Condensation of low vapor pressure species formed by gas phase reactions tends to dominate at low relative humidities and favors the growth of small particles. Liquid phase reactions occur at elevated relative humidities and favor the growth of larger particles.

Source: McMurry & Wilson (1982). Reprinted with permission from Elsevier.

Evan Whitby refined the modal aerosol dynamics (MAD) modeling method (Whitby & McMurry, 1997) that his father, Kenneth Whitby, had originally conceived. Several regional aerosol models incorporated this method.

Anand Gupta's doctoral research involved an experimental study of oxidation of sulfur dioxide by hydrogen peroxide in aqueous aerosol droplets (Gupta et al., 1995). His work set out to determine whether this process was responsible for the droplet reactions identified in the growth law analyses. This study was the first use of the tandem differential mobility analyzer (TDMA) method to study chemical transformations on aerosol particles.

Daniel Rader's doctoral research focused on the theoretical basis for using the TDMA as a quantitative tool for studying aerosol processes and properties (McMurry & Rader, 1986; Rader et al., 1987). Shortly after Rader graduated, McMurry and Mark Stolzenburg (1989) used the TDMA to carry out measurements of atmospheric aerosol water uptake in Los Angeles during the Southern California Air Quality Study (SCAQS). They showed that some particles of a given size grew significantly when humidified, whereas others did not, and concluded that Los Angeles aerosols are "externally mixed." Subsequent work showed that the nonhygroscopic particles consist of local primary soot emissions, whereas the hygroscopic particles are more aged, and contain significant amounts of secondary sulfates, organics, and nitrates (McMurry et al., 1996a). Modeling efforts provided some of the first direct evidence for the uptake of water by particulate organic compounds (Dick et al., 2000a). The hygroscopicity TDMA (HTDMA) is now used by many groups worldwide, as summarized in a recent review article (Swietlicki et al., 2008).

McMurry's atmospheric research in the late 1980s and early 1990s focused on visibility impairment. This work included measurements of water uptake and mixing characteristics with the TDMA, and size-resolved composition with the MOUDI impactor (Marple et al., 1991). Visibility studies were carried out in Los Angeles, at the Grand Canyon, and at the Great Smoky Mountain National Park. The work at the national parks was motivated by the "Prevention of Significant Deterioration" provision of the 1977 amendments to the Clean Air Act, which stipulated that pollution must not adversely affect visibility in so-called Class 1 areas. Xinqi Zhang carried out measurements that enabled him to create models for aerosol properties that reduced the number of assumptions needed to calculate species scattering efficiencies

(Zhang et al., 1993, 1994; McMurry et al., 1996b). Scattering efficiencies quantify the extent to which light scattering will decrease if the concentration of a species is decreased by a specified amount. Drs. Susanne Hering and Barbara Turpin were important collaborators in this work. Bill Dick's doctoral work on multi-angle light scattering (MALS) also sought to understand better the optical properties of aerosol particles. By measuring azimuthal variabilities in scattering, Dick was able to distinguish spherical from nonspherical particles (Sachweh et al., 1995; Dick et al., 1996, 1998). For the spherical particles, Dick was able to infer refractive index from measurements of the dependence of light-scattering intensities on polar angle. Dr. Bernd Sachweh was also an important contributor to the MALS work. Figure 22 is a photograph taken in the Grand Canyon during the winter of 1990, during an intensive study on the impact of the Navajo Generating Station on visibility impairment (Zhang et al., 1994).

New particle formation has been a topic of interest to McMurry ever since 1972, when Sheldon Friedlander suggested "nucleation in the presence of an aerosol" as a possible thesis topic. Although it was not known then that nucleation is an important atmospheric process, it was a conceptually interesting topic that had not been investigated. Work over the past 10 to 20 years has shown that atmospheric nucleation is indeed important (Kulmala et al., 2004). The development of instruments for detecting sub-10 nm



Figure 22. Light scattering from aerosols in the Grand Canyon, taken during the NGS Visibility Study in the winter of 1990.

Source: Photo courtesy of author.

particles enabled this discovery. A contour plot that shows a new particle formation event in Boulder, Colorado, is shown in Figure 23. Particle size is shown on the ordinate and time of day is on the abscissa. The magnitude of the particle size distribution function is shown in color. These measurements were obtained using scanning mobility particle spectrometers (SMPSs) including a nano-SMPS (3 to 40 nm), a conventional SMPS (20 to 300 nm), and an inclined grid mobility analyzer (IGMA), built by Prof. Hannes Tammet, for ion mobility distributions in the 0.5 to 6 nm mobility diameter range.

Early in the 1990s, with the encouragement of Prof. Robert Charlson, McMurry began to examine the effects of aerosols on global climate. His work in this area has focused on new particle formation, which can affect concentrations of cloud condensation nuclei and therefore the earth's albedo. The measurement of nanoparticle size distributions with the UCPC was a focus of his early work on this topic. McMurry and coworkers exploited John

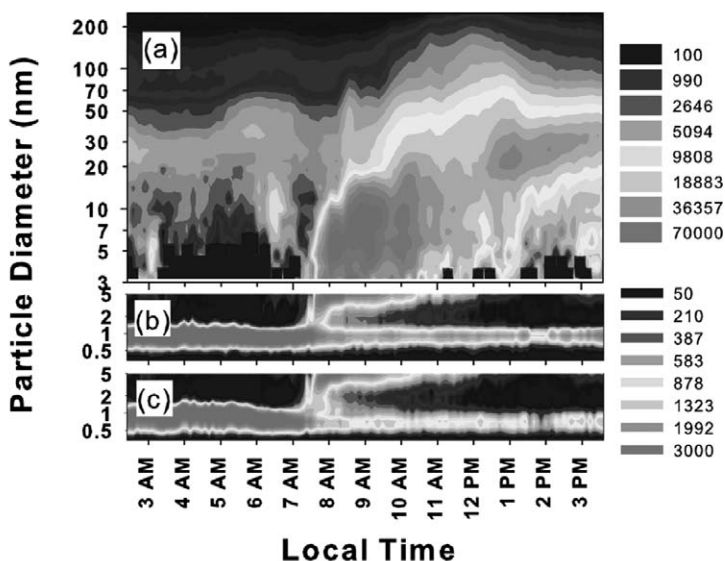

Figure 23. Contour plot of particle size distributions measured during a new particle formation event in Boulder, Colorado. Data in Figure 23a were obtained with a nano-SMPS (3–40 nm) and a conventional SMPS (20–300 nm). The distributions of positive and negative ions shown in Figure 23b and 23c were measured with Prof. Hannes Tammet's inclined grid mobility analyzer (IGMA). On this day, a new particle formation event occurred shortly after 7 a.m., and particles continued to grow until late in the afternoon.

Source: Courtesy of Kenjiro Iida.

Brockmann's observation that for particles smaller than ~ 10 nm, the final droplet size after condensation decreases with the initial particle size. This phenomenon occurs because, due to the Kelvin effect, small particles must travel further into the UCPC condenser to encounter a saturation ratio that is high enough to activate growth. Therefore, small particles have less time to grow, and they grow to a smaller final size. This observation was developed into the pulse height analysis (PHA) technique for measuring sub-10 nm size distributions (Saros et al., 1996; Weber et al., 1998a; Dick et al., 2000b). In work that is not yet published, Chongai Kuang developed the nanoparticle growth (NPG) instrument system that enables Kelvin effect sizing down to about 1.2 nm.

In 1992, McMurry joined forces with Dr. Fred Eisele of the National Center for Atmospheric Research (NCAR) to study the formation of atmospheric particles by homogeneous nucleation. Eisele and coworkers had developed a chemical ionization mass spectrometric technique for measuring sulfuric acid (H_2SO_4) vapor at mole fractions as small as 10-15 ppm and McMurry and coworkers had developed the UCPC. Theory suggested that H_2SO_4 was a likely participant in nucleation. They reasoned that parallel measurements of H_2SO_4 and freshly nucleated nanoparticles would provide new information about nucleation mechanisms. Rodney Weber's doctoral research focused on this topic. He carried out field studies with Eisele at Mauna Loa, Hawaii, Idaho Hill, Colorado, and over the Southern Ocean during ACE-I. Weber's work led to a number of important discoveries (Weber et al., 1995, 1999; Weber & McMurry, 1996; McMurry et al., 2000). Figure 24 illustrates one of these discoveries, which shows the dependence of 3 nm particle production rates on H_2SO_4 vapor concentrations for measurements carried out at Mauna Loa and in the Rocky Mountains at Idaho Hill (Weber et al., 1996). These results show that particle production rates vary as $[\text{H}_2\text{SO}_4]^p$ ($1 < p < 2$) in contrast to the binary H_2SO_4 -water nucleation theory, which predicted a much stronger dependence on H_2SO_4 . Furthermore, the results showed that particle production rates at a given H_2SO_4 vapor concentration are orders of magnitude higher than theory predicts and that biogenic sources such as penguin colonies (!) greatly enhance rates of particle production (Weber et al., 1998b).

Recent work by Chongai Kuang has shown that for all studies carried out by the McMurry-Eisele team since 1992 in locations around the globe, nucleation rates (i.e., production rates of particles in the 1 nm range) vary

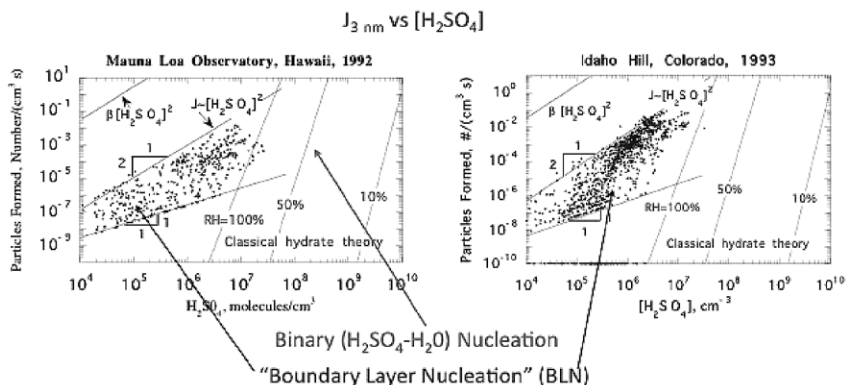

Figure 24. Dependence of particle production rates on sulfuric acid (H_2SO_4) vapor concentrations for measurements on Mauna Loa, Hawaii, and in the Rocky Mountains of Colorado. Observed rates greatly exceed nucleation rates predicted by the theory for binary nucleation of H_2SO_4 and water and have a much weaker dependence on H_2SO_4 vapor concentration.

Source: Weber et al. (1996). Reprinted with permission of the publisher (Taylor & Francis Group, www.informaworld.com).

as $[\text{H}_2\text{SO}_4]^2$ (Kuang et al., 2008). Rodney Weber also showed that growth rates of freshly nucleated particles are often 10 times faster than can be explained by H_2SO_4 vapor condensation (Weber et al., 1997), the only growth mechanism that was incorporated in atmospheric aerosol models at that time. As McMurry originally predicted in his doctoral research (McMurry & Friedlander, 1979), these high nucleation and growth rates cause new particle formation to be an important atmospheric process.

Much of McMurry's work over the past 15 years has attempted to understand the chemical processes responsible for the high rates of nucleation and particle growth observed in the atmosphere. With Hiromu Sakurai, McMurry collaborated with Fred Eisele and Jim Smith at NCAR to develop the thermal desorption chemical ionization mass spectrometer (TDCIMS) for measuring the composition of freshly nucleated particles as small as 7 nm (Voisin et al., 2003; Smith et al., 2005, 2008, 2010). Jim Smith's TDCIMS measurements in Boulder and Mexico City show that nucleated particles sometimes contain large quantities of organics and nitrates in addition to smaller amounts of sulfates. This observation helps to explain why observed growth rates are so high, but the chemical mechanisms responsible for the uptake of those species remain unresolved.

In 2005 McMurry and Fred Eisele began a major collaborative effort to bridge the gap in measurements between molecules, neutral molecular clusters and nanoparticles. This involved the efforts of Eisele and coworkers (especially Dr. Jun Zhao) to develop the cluster chemical ionization mass spectrometer (cluster CIMS) to masses up to 1,000 amu. At the same time, McMurry worked with Kenjiro Iida, Chongai Kuang, Jingkun Jiang, and Modi Chen to extend measurements of aerosol size distributions down to ~1 nm, which would overlap with cluster CIMS data. These measurements promise to elucidate the chemical mechanisms responsible for the fast rates of nucleation that have been observed in the atmosphere (Zhao et al., 2010; Jiang et al., in press).

Another focus of McMurry's work is particle characterization. Aerosol particles are often highly complex and may be irregularly shaped, contain multiple phases, and include many different compounds. McMurry has developed methods for accurately measuring certain properties of these complex particles. His first work in this area involved measurements with the TDMA (DMA-DMA). Subsequently, using the TDMA to separate particles according to size and hygroscopicity, he was able to use transmission electron microscopy (TDMA-TEM) to determine how the hygroscopic and nonhygroscopic particles differ morphologically and chemically (McMurry et al., 1996a). Dr. Kensei Ehara's development of the aerosol particle mass analyzer (APM) was also important (Ehara et al., 1996). The APM classifies particles by mass-to-charge ratio, independent of particle shape, density, and other characteristics. In his doctoral research, Kihong Park showed that by using the APM in series with other instruments (e.g., DMA-APM, TDMA-APM, DMA-APM-TEM), one can measure particle properties including "effective density," inherent material density, dynamic shape factor, and so forth. One can also determine transport properties such as diffusivity, sedimentation speed, and aerodynamic diameter. Dabrina Dutcher showed that by adding the aerosol time-of-flight mass spectrometer to this battery (TDMA-APM-ATOFMS), one can add information on vacuum aerodynamic diameter and composition. Dr. Hiromu Sakurai and Prof. David Kittelson were key collaborators in this research. These measurement methods can establish the relationships among different measures of size (geometric, aerodynamic, mobility) and provide information on differences in various properties (density, fractal dimension, volatility, dynamic shape factors, etc.) for particles of a given mobility size. In 2006 McMurry and Dr. Joachim Pagels joined forces with Prof. Renyi Zhang and Dr. Alexei Khalizov at Texas

A&M University to apply tandem DMA-DMA-APM-TEM measurements to study the effect of cloud processing on morphological and optical properties of chain agglomerate soot particles (Zhang et al., 2008). This study, which quantified the extent to which condensation and evaporation of liquids on soot agglomerates cause them to collapse into more compact forms, nicely illustrates the power of such tandem measurement methods. More recently, a collaborative effort with Prof. Sotiris Pratsinis applied the DMA-APM-TEM method to study properties of silica agglomerates produced in flames. Jacob Scheckman (2008) showed that this approach can be used to rapidly and accurately quantify properties of these agglomerates, including their fractal dimension and dynamic shape factor.

McMurry has also worked in other areas. In the late 1980s, while participating in meetings of the Semiconductor Contamination Control consortium led by Benjamin Liu, he became interested in the formation of contaminant particles in semiconductor processing chambers by gas-to-particle conversion. Although the chemistry was different, the process was analogous to the formation of secondary atmospheric aerosols. This work required the measurement of very small particles at low pressures, which led to the development of the particle beam mass spectrometer (PBMS). Dr. Paul Ziemann was instrumental in this work (Ziemann et al., 1995a, 1995b, 1996; Ziemann & McMurry, 1997, 1998; McMurry et al., 1996c). We used the PBMS to study nucleation and growth of contaminant particles in semiconductor processing equipment (Rao et al., 1998a, 1998b, 1998c; Nijhawan et al., 2000, 2003; Kim et al., 2002). Aerodynamic lenses were key to the development of the PBMS. Faculty collaborators on this work included Prof. Steve Campbell (EE), Prof. Steve Girshick, Prof. David Kittelson, and Prof. Uwe Kortshagen, and Sandeep Nijhawan and Taesung Kim wrote theses on this topic.

The development of aerodynamic lenses was an outcome of McMurry's work on semiconductor contamination control. The PBMS required that particles be focused into tightly collimated beams, and McMurry and coworkers developed aerodynamic lenses to accomplish this. These simple devices consist of a series of thin plate orifices mounted in a cylindrical tube, as illustrated in Figure 25. Aerodynamic lenses typically operate at pressures well below atmospheric to ensure that the flow is laminar, which is one reason they were suitable for sampling downstream of semiconductor processing equipment. The image at the top of Figure 25 shows gas streamlines, and the image at the bottom of Figure 25 shows particle trajectories, which are significantly affected by diffusion in this example, during flow through a

sequence of aerodynamic lenses. Particles that have Stokes numbers close to 1.0 move toward the centerline as the gas flows through the lens. By using a series of lenses, particles can be concentrated along the centerline, thereby enabling the formation of a tightly collimated beam upon expansion through the downstream nozzle. Aerodynamic lenses, which enable efficient transport of particles from atmospheric pressure into low-pressure chambers, have been key to enabling real-time analyses of particle composition by mass spectrometry in instruments such as the TSI 3800 ATOFMS and the Aerodyne family of aerosol mass spectrometers (AMS). Peng Liu carried out the first work on this topic. Xiaoliang Wang later showed how to design

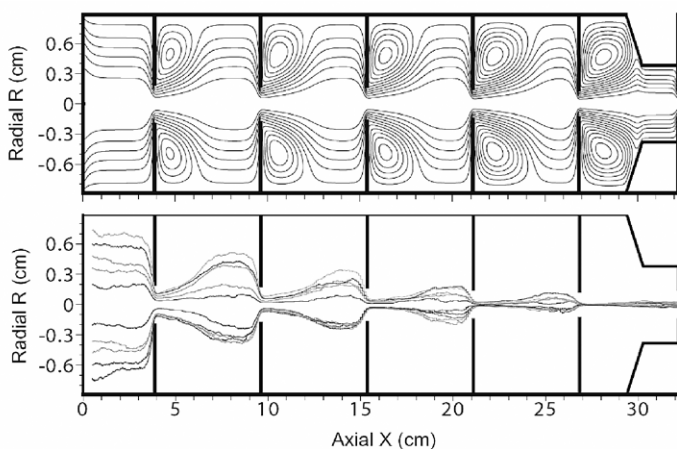

Figure 25. (Top) Gas flow streamlines and (bottom) particle trajectories in an aerodynamic lens. Note that particles with Stokes numbers close to 1.0 are inertially concentrated along the centerline. The fluctuations in the particle trajectories are due to the effects of diffusion.

Source: Courtesy of Xiaoliang Wang.

aerodynamic lenses that focus particles as small as 3 nm. Together with Peng Liu and McMurry, Prof. David Kittelson and Dr. Paul Ziemann were co-inventors of aerodynamic lenses.

McMurry has also collaborated with Prof. Girshick, Prof. Joachim Heberlein, and others on formation of nanoparticles in thermal plasmas. This work initially addressed nucleation and growth. More recently they have focused on the use of such nanoparticles to produce nanophase films with unique mechanical properties (Rao et al., 1995a, 1995b, 1998b; Girshick et al., 1990, 1993, 1996; Heberlein et al., 1997; Tymiak et al., 2001; DiFonzo et al., 2000). Key to this work is the hypersonic impaction of nanoparticles

to form dense deposits (Fernandez de la Mora et al., 1990), and the use of aerodynamic lenses to produce tightly collimated beams for producing “high-definition” deposits.

David Y. H. Pui

David Pui became director of the Particle Technology Laboratory in 1995. He received the Distinguished McKnight University Professorship at the University of Minnesota in 1999 and the L. M. Fingerson/TSI Chair in Mechanical Engineering in 2002. As of 2010, he had published more than 200 journal papers and had received 17 patents. At the 2010 International Aerosol Conference (IAC2010) in Helsinki, he received the Fuchs Memorial Award in recognition of his research on industrial applications of aerosol technology.



David Y. H. Pui

Source: Photo courtesy of the authors.

Pui's research has focused on developing instrumentation and experimental techniques for environmental research and industrial applications. He collaborated with Liu (Liu & Pui, 1974a) on the development of the mobility classification technique for producing monodisperse aerosols of known size and concentration for instrument calibrations and fundamental research. His early particle standardization work was the basis of his collaboration with George Mulholland at National Institute of Standards and Technology (NIST) in developing 60 nm and 100 nm nanoparticle Standard Reference Materials (SRMs) (Mulholland et al., 2006).

Since the early 1990s, Pui has devoted significant effort to nanoparticle/nanotechnology research. Pui and Da-Ren Chen (Chen et al., 1995a; Chen & Pui, 1997) developed the electrospray technique for producing and dispersing monodisperse nanoparticles in the size range from 2 nm to 1 μm . In 1997, he and Chen wrote an editorial and edited a special issue of *Journal of Aerosol Science* on “Nanometer Particles: A New Frontier for Multidisciplinary Research.” He organized a series of workshops and symposia on Nanoparticles, including the 1997 Department of Energy (DOE) Nano-Instrument Workshop, and the 1998–2002 National Science Foundation–European Science Foundation (NSF-ESF) Symposia (with Heinz Fissan), and the 2005 Nanoparticle and Occupational Health Symposium (with Andrew Maynard). Several books/proceedings resulting from the workshops/symposia (e.g., Friedlander & Pui, 2003; Maynard & Pui, 2007a, 2007b) have

demonstrated to young researchers that aerosol is an enabling discipline and have pointed out the roles that young researchers can play in the ongoing nanoparticle/nanotechnology revolution.

Pui has also made seminal contributions to research on the following topics: particle charging and neutralization, sampling and transports, aerosol filtration, aerosol instrumentation, and micro- and nano-contamination control in semiconductor manufacture. He has also found novel applications for electrospray in nanobiotechnology (Chen et al., 2000), for which he has received six patents. These patents formed the basis of a new start-up company, Nanocopoeia, in St. Paul, Minnesota.

Mobility Classification for Producing Particle Standards

The paper, "A Submicron Aerosol Standard and the Primary, Absolute Calibration of the Condensation Nuclei Counter," by Liu and Pui (1974a) is perhaps one of the most cited aerosol instrumentation papers (cited nearly 250 times by 2006). It described the use of the DMA (Figure 26) to classify a monodisperse aerosol with known particle size, and the use of an electrometer to measure the aerosol concentration, with a high degree of precision and accuracy. It was the first available "particle standard" that gave both the airborne particle size and concentration, down to a particle diameter of approximately 10 nm.

The availability of the particle standard attracted several aerosol pioneers to calibrate and compare their particle counters and sizers with this standard. David Sinclair brought his collimated-holes diffusion battery to Minnesota to compare the particle sizes measured by his diffusion battery with those determined by the DMA (Sinclair et al., 1976). Excellent agreement was shown between the two techniques, which was a first verification of the Einstein relationship using the aerosol technique. Jean Bricard and Michel Pourprix brought their continuous flow condensation nuclei counter for particle concentration comparison, which became the CPC that TSI commercialized. Austin Hogan and Ted Rich brought the Pollak counter for particle concentration comparison and calibration (Liu et al., 1975). The standard was also used in several workshops for instrument calibrations. The first of these workshops, the "Workshop on Ultrafine Aerosol" (WUFA), was held in Vienna and was hosted by Othmar Preining, Paul Wagner, and Wladyslaw Szymanski (Liu et al., 1982a, 1984). These studies firmly established the mobility classification technique as the most important

technique for submicron aerosol sizing and classification, down to particles as small as 10 nm and below. Sem and Sakurai have nearly completed an International Standardization Organization (ISO) standard (ISO TC24/SC4/WG12) on the differential mobility sizing of aerosol particles at the time of publication, and another ISO working group is being convened to work on

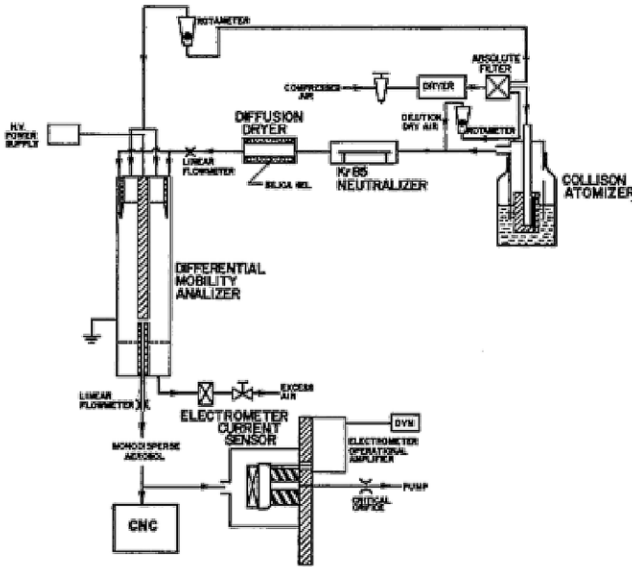

Figure 26. Schematic diagram of the monodisperse aerosol generator using the mobility classification technique.

Source: Liu & Pui (1974a). Reprinted with permission from Elsevier.

a new standard for the calibration of condensation particle counters using aerosol electrometry.

Using the mobility classification method, Pui and Mulholland collaborated in establishing the first NIST 100 nm SRM particles (Kinney et al., 1991) in 1991 (Figure 27). More recently, this technique was applied to establish the 60 nm and a second batch of the 100 nm SRM particles (Mulholland et al., 2006). As of 2008, the 60 nm SRM particle was the smallest size nanoparticle standard maintained at NIST.

Electrical Aerosol Analyzers

Liu and Pui (1975) developed the widely used electrical aerosol analyzer (TSI Model 3030 EAA). The technique used aerosol charging, mobility analysis, and electrometer detection. Whitby first established the principle in his early version of the analyzer. TSI 3030 EAA was compact and robust, and



Figure 27. National Institute of Standards and Technology (NIST) 60 nm and 100 nm Standard Reference Material (SRM) particles published in the NIST journal.

became the workhorse for measuring submicron atmospheric aerosol size distributions during the 1970s and 1980s. Some of the EAA components are still in use today (e.g., the TSI Model 3068A Aerosol Electrometer for measuring aerosol concentration).

In collaboration with Heinz Fissan, Pui and Chen (Fissan et al., 1996) compared the performance of four DMAs for nanometer aerosol measurements. Subsequently, they collaborated with TSI to develop the nano-DMA (TSI 3085) for measuring aerosol size distributions in the 3 to 100 nm particle size range (Figure 28) (Chen et al., 1997).

Using the nano-DMA, a bipolar charger and an electrometer, a fast-scan nanometer aerosol size analyzer was developed to perform rapid (2-second cycle time) particle size distribution measurement in the 3 to 100 nm size range, which jet-engine emission measurements demonstrated successfully (Han et al., 2000).

Electrical Charging and Neutralization

Pui's MS thesis and doctoral dissertation at the University of Minnesota examined electrical charging by unipolar ions and by bipolar ions (neutralization) (Pui, 1973, 1976). Charging of aerosol particles by ions or free electrons is an important phenomenon in aerosol physics with many practical applications. For submicron aerosols and nanometer aerosols, the electrical force on the charged particles is the dominant force, which can be used to manipulate the aerosol particles for the purpose of measurement,

classification, or control. Its application includes air pollution measurement and control, as well as process monitoring for materials production.

Pui performed definitive experiments on aerosol charging by unipolar ions (Liu & Pui, 1977), charge conditioning by bipolar ions (neutralization) (Liu & Pui, 1974b, 1974c), and charge conditioning by free electrons (Liu & Pui, 1977; Romay & Pui, 1992a). The studies have extended to charging under low pressure (Romay et al., 1991) and in high-purity gases (Adachi et al., 1987; Romay & Pui, 1992b). They have provided fundamental data for testing various theories on the combination coefficients of ions and particles in the

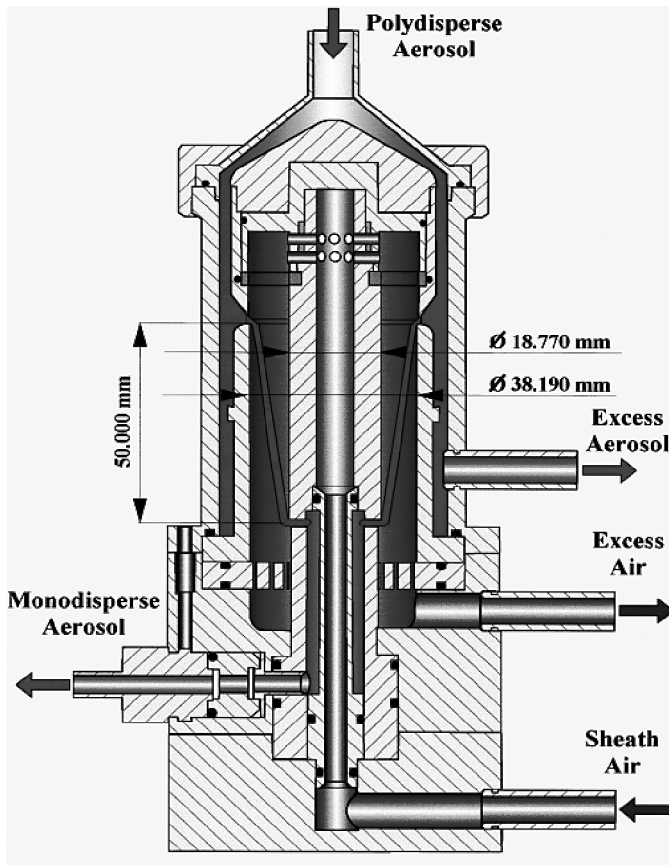

Figure 28. The nano-differential mobility analyzer (nano-DMA) designed for 3–100 nm particle size range.

transition and free molecular regimes. Several practical aerosol chargers and neutralizers have been developed, including the unipolar charger used in the electrical aerosol analyzer, the neutralizers that use the krypton-85 source (Liu & Pui, 1974c) and the polonium-210 source (Liu et al., 1986b; Adachi et al., 1990; Adachi et al., 1992a), and the unipolar and bipolar chargers using corona ionizers (Adachi et al., 1990, 1992b).

Pui's recent research on these topics includes developing a high-efficiency, high-throughput aerosol charger for the nanoparticle size range (Chen & Pui, 1998). Experiments have shown that the extrinsic charging efficiency of the charger is approximately 10 to 100 times higher than the best available charger for particles smaller than 10 nm. The charger is expected to have significant technological applications because it provides 10 to 100 times more throughput for nanoparticle classification and a 10- to 100-fold increase in detection sensitivity for size distribution measurement.

Aerosol Sampling, Transport, and Deposition

Pui and colleagues studied the basic topics of sampling, transport, and deposition in inlets and tubes, as well as deposition in bends and contractions. The fundamental results are subsequently used to study more complex topics of transport in cleanrooms and semiconductor process equipment, as well as deposition on semiconductor wafers, disk drives, and pressure reducers. A good example of the impact of his work in collaboration with Liu was the development of the PM₁₀ inlet, which was accepted by EPA and the international community as a standard inlet (Liu & Pui, 1981; Liu et al., 1983c).

Pui and colleagues performed a series of numerical and experimental studies of particle deposition in bends (Pui et al., 1987; Tsai & Pui, 1990; Sato et al., 2001) and in contractions (Ye & Pui, 1990; Chen & Pui, 1994; Sato et al., 2002), leading to practical sampling systems for atmospheric measurement (Ye et al., 1991b; Poon et al., 1994a, 1994b) and for high-purity gas measurement (Lee et al., 1995; Rubow et al., 1990b). Studies of particle deposition on semiconductor wafers have led to methods for preventing particle deposition using thermal gradients during semiconductor manufacturing (Ye et al., 1991a; Opiolka et al., 1990). Studies of particle flows in the near wake of a disc (Gomes et al., 1993, 1999), under vacuum conditions (Sato et al., 2002), and particle rebound and adhesion (Tsai et al., 1990a), have provided insight in contamination control in computer disk

drives (Tsai et al., 1991b, 1992), cleanrooms and semiconductor processing equipment (Kinney et al., 1996, 1997; Bae et al., 1997).

Aerosol Filtration and Dust Collectors

In 1991, Liu and Pui started the Center for Filtration Research (CFR) at the University of Minnesota. The center has been supported by a total of 14 filter companies as well as NIOSH. The current members of the center include 3M, Boeing, Cummins, Donaldson, DuPont, Entegris, W. L. Gore, Samsung Electronics, Shigematsu, TSI, and affiliated member NIOSH. Many fundamental and applied filtration research studies were performed under CFR. Pui and Chen studied the optimal design of pleated filters by developing a numerical model using a finite element method. A general correlation curve was obtained which reduces the filter and flow optimization parameters into a single curve for all six commercial filter media (Chen et al., 1995b, 1996). This work has subsequently been extended to ventilation filters at high flow, and to include effects of filter loading (Endo et al., 1997a, 1997b). These fundamental studies have brought filter pleating design from an empirical art to an exact science. Pui and colleagues have also performed laboratory and field measurements of industrial dust collectors (Liu et al., 1986c; Bergin et al., 1989; Fay et al., 1989), and have extended the work to include bioaerosol filtration (Kuehn et al., 1994; Kemp et al., 1995a, 1995b). Several papers from the doctoral dissertation of Liming Lo (Lo et al., 2008, 2010a, 2010b) provide the basic criteria for the design of reversed-pulsed dust collector for cleaning dust-loaded filters.

Electrospray and Its Applications

The electrospray research began with Da-Ren Chen's doctoral dissertation, which Pui advised. Two papers by Chen and Pui (Chen et al., 1995a; Chen & Pui, 1997) outlined the basic principles and scaling laws for operating the electrospray. The electrospray can be used to produce monodisperse airborne nanoparticles by spraying a solution with known concentration of solute, or by dispersing a colloidal suspension of standard spheres of PSL, quantum dots, and so forth.

Pui and Chen (U.S. Patent No. 6,399,362, 2002; U.S. Patent No. 6,764,720, 2004) introduced the dual-capillary electrospray concept that greatly enhanced the applications of the electrospray technique (Chen & Pui, 2009). For example, the start-up company Nanocopoeia was able to use the dual-

capillary technique to spray drug-encapsulated polymers on medical stents with tunable drug release profiles. Chen and Pui collaborated with Chris Wendt in pulmonary medicine (Chen et al., 2000; Chen & Pui, 1997) to demonstrate the use of electrospray for gene transfection (Figure 29).

Ongoing Research Activities

Pui's recent research has focused on the environmental, health, and safety studies of nanoparticles. He gave several keynote and plenary talks at international conferences on this topic. The risk of inhaling nanoparticles is a function of both the hazard and exposure. Pui performed research addressing the hazard and exposure assessments of nanoparticles. He collaborated with Gunter Oberdörster at the University of Rochester, New York, and with Pratim Biswas and Da-Ren Chen at Washington University in St. Louis on nanoparticle toxicology; their research was funded by the Air Force Research Laboratory (AFRL). Chen and Pui developed an electrospray system to deliver single nanoparticles for in vitro and in vivo studies conducted at Oberdörster's laboratory. By providing unagglomerated airborne nanoparticles for

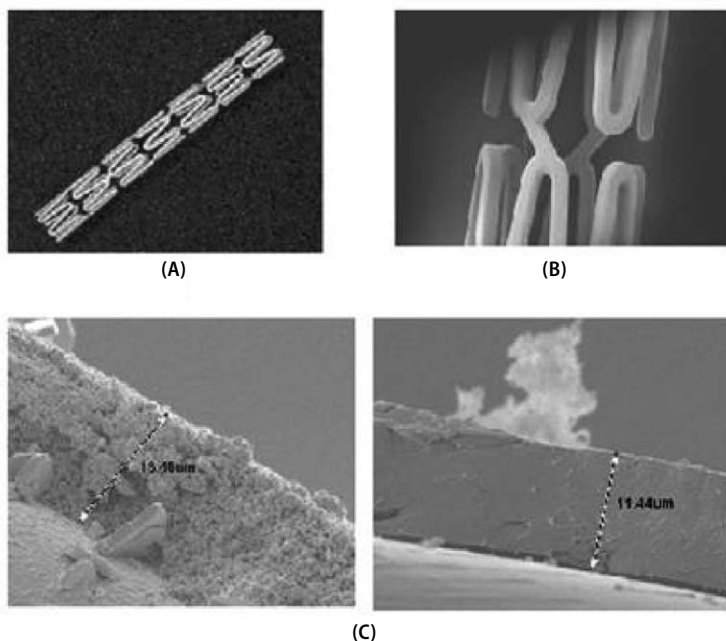

Figure 29. (A) A typical stent for the human use, (B) a coated stent prepared by electrospray technique, and (C) the morphology variation of the coated layer, prepared by electrospray technique, on the stents.

inhalation study, this research aims to assess the realistic inhalation exposure with the traditional instillation study.

To assess nanoparticle exposure, Pui collaborated with Fissan in setting up a new metric for exposure study. This research was initiated by the doctoral dissertation of Pui's student Hee-Siew Han. Using an electrical aerosol detector, they assessed using this integral aerosol monitor for measuring the surface area of atmospheric aerosol (Wilson et al., 2005). The validity of this approach was proven in a field test (Woo et al., 2001). Fissan and Pui (Fissan et al., 2007; Shin et al., 2007) found that by tuning the "ionizer voltage" of the Electrical Aerosol Detector (EAD), the signal can be related to the nanoparticle surface area deposited in different regions of the human lung. Subsequently, TSI has produced two commercial instruments—the Nanoparticle Surface Area Monitor (TSI Model 3550 NSAM) and the portable version Aerotrak (TSI Aerotrak 9000)—providing this new metric for exposure study. Ongoing research includes using the NSAM for "Experimental and Numerical Simulation of the Fate of Airborne Nanoparticles from a Leak in a Manufacturing Process to Assess Worker Exposure," a project funded by the National Science Foundation (NSF).

Pui's ongoing research activities involve using the nanoparticle tools he has developed and applying modeling methodology to perform systematic studies on nanoparticle research. Under Intel sponsorship, he collaborated with Fissan to develop protection schemes for extreme ultraviolet lithography (EUVL) systems, which are considered to be the next generation chip manufacturing technology. Photomasks, in a mask carrier or inside a vacuum scanner, need to be protected from nanoparticle contamination larger than 20 nm diameter, the minimum feature size expected from this technology. By using thermophoretic, particle drag, and gravity forces as well as the cover plate concept, Pui and colleagues developed several schemes to prevent nanoparticle deposition on EUVL systems down to 20 mTorr (Figure 30). The research has already resulted in a series of 15 journal papers (Asbach et al., 2006, 2007, 2008; Kim et al., 2006a, 2006b, 2006c; Yook et al., 2007a, 2007b, 2007c, 2008a, 2008b; Wang et al., 2008a). Some of the approaches have been implemented in mask carrier and scanner designs.

Most engineered nanoparticles are produced and dispersed in agglomerate form; however, most aerosol instruments measure equivalent diameters assuming a spherical particle. Pui and collaborators performed fundamental research on the mechanics of nanoparticle agglomerates (Shin et al., 2009a,

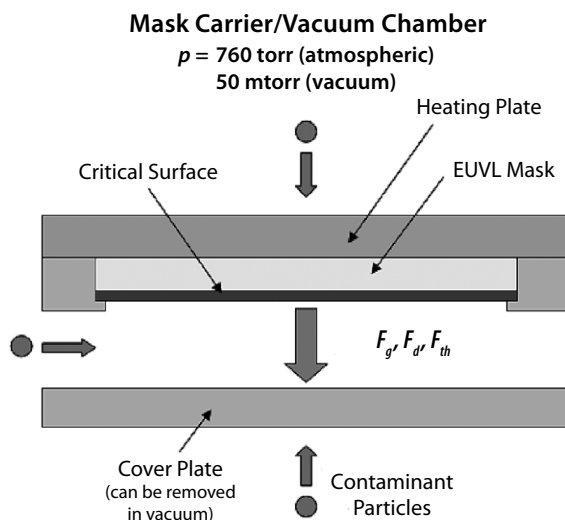

Figure 30. Use of thermophoretic, particle drag and gravity forces and the cover plate concept to prevent nanoparticle deposition on extreme ultraviolet lithography systems down to 20 mTorr.

2009b, 2009c) and the charging behavior of agglomerates (Shin et al., 2009c; Qi et al., 2009). Based on these fundamental studies, the Particle Technology Laboratory has developed and is currently field testing a real-time instrument for measuring nanoparticle agglomerates.

Nanoparticle research is also an important topic for CFR. Filters are used to collect nanoparticle products from reactors and are used in personal protection equipment to protect workers from nanoparticle exposure. Industry and government agencies are concerned with recent studies that have pointed to the potential penetration of nanoparticles through the filters due to thermal rebound. Pui and colleagues performed a systematic study of nanoparticle filtration using standard filters and filter media used in personal protection equipment (Kim et al., 2007a). Pui and colleagues compared the experimental results with models developed for nanoparticle filtration (Wang et al., 2007). The study found no thermal rebound of nanoparticles down to 3 nm diameter. Further, a cabin air filtration project found that filtration is an effective and low-cost way to protect commuters and nano-workers from nanoparticle exposures (Pui et al., 2008; Qi et al., 2008). Ongoing research projects compare the filtration efficiency between single nanoparticles and nanoparticle agglomerates (Kim et al., 2007b), load nanofiber filters with

agglomerate and dust particles, and study the improved figure of merit of nanofiber filters (Wang et al., 2008b).

One of the ultimate objectives for CFR research is to develop a comprehensive filter performance model to help member companies design novel filters with improved performance. We would like to incorporate CFR research in this model, including nanoparticle and nanofiber filters, solid and liquid coated particle loading, filter pleating design, agglomerate filtration, and electrostatic filtration. The member companies have developed and are evaluating a Web-based software. The software allows filter manufacturers to design composite filters and compare different designs using a figure of merit approach. This will enable manufacturers to optimize filter performance under different conditions and to maintain and extend filter life (Figure 31).

Other new initiatives being conducted under CFR include (1) the use of aerosol techniques to evaluate liquid-borne particle filtration, (2) the removal of volatile organic compounds (VOCs) and airborne molecular contaminants (AMCs) using modified TiO_2 nanoparticles, and (3) the filtration of bioaerosols including bacteria and viruses. Several papers are being prepared on these topics.

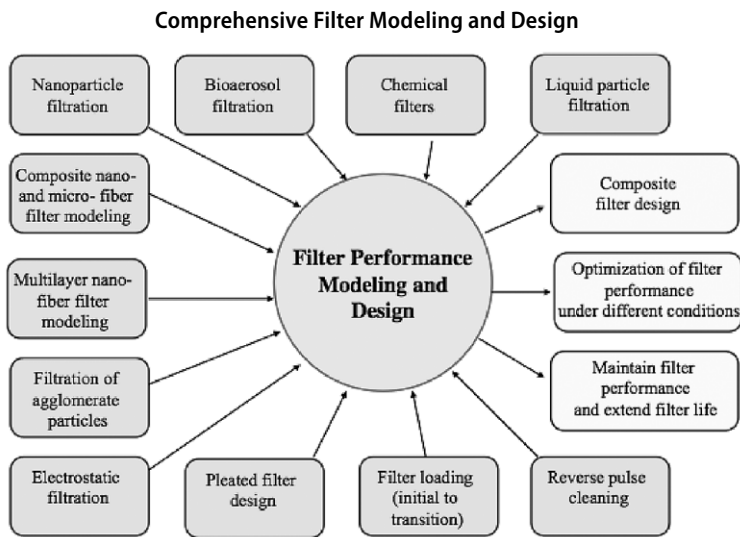

Figure 31. Filter performance modeling to design and optimize filters and to extend filter life.

Thomas H. Kuehn

Prof. Kuehn joined the Department of Mechanical Engineering in March 1983 and was assigned to the Environmental Division, at that time headed by Whitby. The position was a continuation of the teaching and research activity developed by Prof. James Threlkeld in the area of thermal environmental engineering. Both Threlkeld and Kuehn were faculty members at Iowa State University prior to joining the faculty at Minnesota. Threlkeld used his lecture notes developed while teaching at Iowa State as the basis for his pioneering textbook, *Thermal Environmental Engineering*, first published in 1962. The publisher, Prentice Hall, contracted with professors Kuehn and Ramsey to revise and update the text that was then published as the third edition in 1998 (Kuehn et al., 1998).



Thomas Kuehn

Source: Photo courtesy of the authors.

Prof. Kuehn's background was primarily in the thermal sciences (e.g., fluid mechanics, thermodynamics, and heat and mass transfer). He had developed expertise in both experimental and numerical approaches. Research topics included natural convection heat transfer in enclosures (Kuehn & Goldstein, 1976, 1980a), providing benchmark solutions to the classical problem of natural convection from a horizontal circular cylinder (Kuehn & Goldstein, 1980b); the performance of finned tube heat exchangers, including the discovery of a similarity solution for conjugate conduction-natural convection heat transfer in fins (Kuehn et al., 1983; Kwon & Kuehn, 1983; Tolpadi & Kuehn, 1984); and analysis of heat transfer in above-grade and below-grade building structures (Szydowski & Kuehn, 1981; Kuehn, 1982).

Upon joining the faculty at the University of Minnesota, Kuehn began collaborative research activities with others in the Particle Technology Laboratory. He brought his expertise with numerical solution techniques to the Navier-Stokes equations for fluid flow simulations and his experimental measurement skills to investigating indoor and outdoor environmental parameters. Kuehn mainly collaborated with Pui, who was promoted to the faculty shortly after Kuehn arrived. These collaborative efforts primarily focused on applications of technology because others in the Particle Technology Laboratory had experience developing instrumentation and test protocols. In addition to laboratory and field measurements, investigation of

applications involved many levels of numerical simulations. A brief review of selected projects and primary outcomes follows.

Cleanrooms

One of the earliest studies was co-sponsored by the Institute of Environmental Sciences (IES) and the Particulate Contamination Control Research Consortium at the University of Minnesota. In the 1980s, there was considerable discussion about and research activity to improve the performance of cleanrooms used for the manufacture of semiconductors. One design, pioneered by Ed Gallo at IBM, was a tunnel-type configuration in which clean aisles with solid floors were separated by return chases that also served as maintenance corridors. Rather than trying to maintain a clean environment in the entire space, the design focused on the areas above process tools and benches where contamination was most likely to occur. The Microelectronics Research Laboratory at the University of Minnesota had adopted and recently constructed such a design. Thus we had a unique opportunity to assess the performance of this design. Kuehn and Pui approached the IES subcommittee charged with cleanroom performance and suggested a cleanroom flow modeling exercise in which a carefully detailed two-dimensional cross section through an at-rest cleanroom would be published in the IES Journal with well-described flow and particle source boundary conditions. IES would request submissions of numerical solutions to this problem, and we would obtain the corresponding experimental data from our cleanroom, compare the numerical submissions to each other and to the data, and publish the results in the IES literature. Figure 32 illustrates the configuration and boundary conditions that were specified. Four particle source locations were specified to represent two leaks through the high-efficiency particulate air (HEPA) filters, particles generated from a robot arm above the clean bench process area, and one simulating particles shed from a human operator in the aisle.

Six submissions were received from Intel, the University of Akron, Interatom GmbH, the University of Minnesota, Ryowa Air Conditioning and Refrigeration Company Limited, and Hitachi. The results showed good agreement between all the submissions and the experimental data for the flow pattern and velocity magnitudes within the space (Pui et al., 1991; Kuehn et al., 1991). However, the particle concentrations at the specified sample locations did not agree nearly as well. The conclusion was that flow modeling

was much better developed than aerosol transport modeling, at least in the fairly large turbulent environment considered here. Much more sophisticated models were required to handle more realistic scenarios in which three-dimensional flows occurred and transients caused by moving robotic arms and human operators were found. However, this at-rest cleanroom scenario did challenge the limits of contemporary aerosol modeling and identified several challenges ahead.

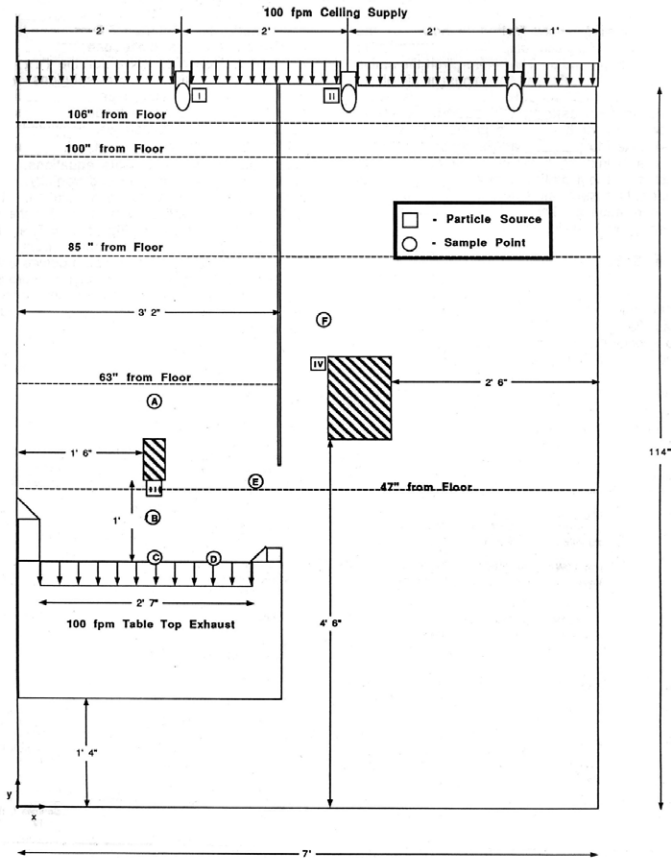

Figure 32. Specifications for the Institute of Environmental Sciences cleanroom flow modeling exercise, 1988.

Bioaerosols

One of the emerging areas in the particle and aerosol field is the interdisciplinary study of bioaerosols. No one else in the Particle Technology Laboratory had focused on this aspect of aerosol science, which has played an increasingly important role in the study of human health and disease transmission in buildings, so Kuehn expanded the traditional scope of Particle Technology Laboratory activity and began research activity in this area. Much of the early interest came from the building engineering community through ASHRAE. ASHRAE is unique in that it is a professional society that not only supports technical conferences but publishes handbooks, establishes standards that are often incorporated into building codes, and supports its own research program primarily with industry contributions. Kuehn and colleagues at the University of Minnesota have conducted much of the pioneering work on the study of bioaerosols in buildings. Because this requires an interdisciplinary approach, faculty, staff, and students outside the traditional Particle Technology Laboratory umbrella were required to collaborate. Personnel have included researchers from the School of Public Health, the Minnesota Building Research Center, the Veterinary Diagnostics Laboratory, the Department of Biosystems Engineering, the Department of Civil Engineering, and the Department of Environmental Health and Safety. Kuehn has served as the principal investigator for most of these studies. Outlines of some of the more interesting projects follow.

An early study with ASHRAE was to determine the capture efficiency of fungi and bacteria aerosols by typical heating, ventilation, and air-conditioning (HVAC) filters and whether these filters could support microbial growth. Field measurements were also obtained in one commercial building and in one residence to determine the effect of the filtration systems on the indoor levels on fungi and bacteria (Kemp et al., 1995a, 1995b).

In one portion of the study, three filters, two bag filters (glass media and polymer media), and a two-stage electronic air cleaner were challenged with outdoor air for a period of 1 year. Two-stage Andersen impactors sampled the upstream and downstream air for cultural bacteria and fungi, and an optical particle counter provided real-time total particle counts. Figure 33 shows representative results in which the filtration capture efficiency is plotted versus time for the three test filters using standard methods with agar (SMA) as the culture media. The electronic air cleaner was overloaded and did not perform well because we intentionally did not clean it as recommended by

the manufacturer. However, the two media filters performed better than expected based on the assumed size of the bioaerosol particles and the fractional efficiency curves for the filters. This was an unexpected result and indicated that perhaps the ambient particles are usually found in larger sizes than predicted by assuming single spores. No growth was measured on any of these filters although the temperature and relative humidity (RH) were often in the range to support growth (RH > 70 percent). This finding suggested that the continuous air flow may have desiccated the dust cake and served to inhibit growth and/or the variation in ambient environmental conditions was sufficient to inhibit growth. More work to better understand these issues is currently in progress.

Field tests in the commercial building showed that the cleanest air in the building was immediately downstream from the filter bank of fiberglass bag filters. Figure 34 provides the results from a Monday, Wednesday, Friday sampling sequence conducted in May. The total concentration of culturable fungi was always highest in the outdoor air but varied significantly from day to day, as Figure 34 shows. The conclusion was that in a fairly new building with a well-maintained forced-air ventilation system with good filtration, the filters make a significant difference in the building's internal bioaerosol concentrations.

A similar study was conducted in a residence that had an installed electronic air cleaner that was identical to the one used in the 100 percent outdoor air challenge tests. Figure 35 shows representative results. The outdoor day-to-day concentration of fungal aerosol varied by orders of magnitude because of local weather variations. Because the home had no provision for outdoor ventilation air, all the air sent to the filtration system was return air from within the building. Thus the concentration entering the filter was a mix of indoor levels and had no direct bearing on the outdoor concentration. Open windows defeated the performance of the air cleaner as did cleaning activities and pets. Conclusions from this portion of the study were that commercial building systems are better designed to control indoor levels of bioaerosols and aerosols in general than residences and that personal behavior in a residence can overwhelm the performance of a good filtration system.

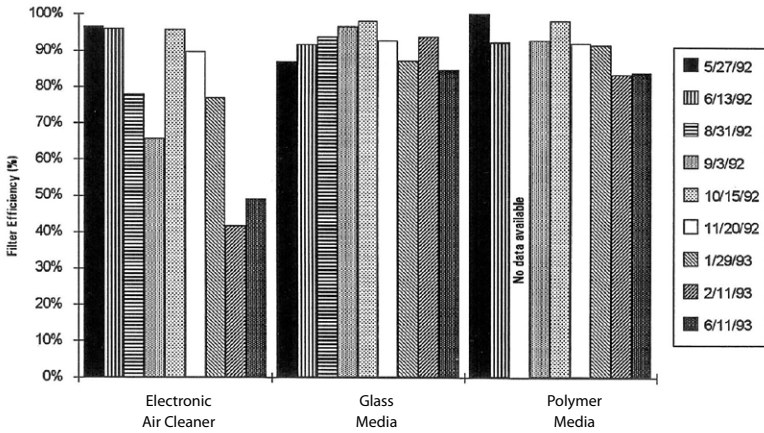

Figure 33. Filter efficiency versus time of year for ambient fungi and bacteria using standard methods agar culture media, 1993.

Source: Kemp et al. (1995a). Reprinted with permission; © American Society of Heating, Refrigerating and Air-Conditioning Engineers, Inc., www.ashrae.org.

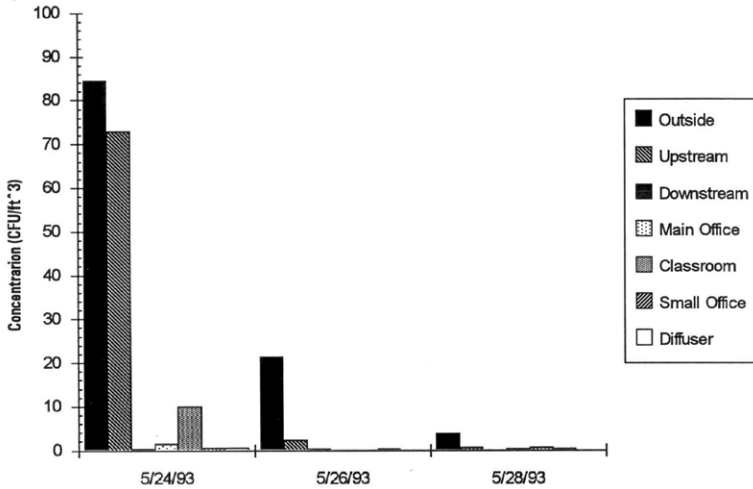

Figure 34. Culturable fungal aerosol concentrations at various locations in a classroom building for 1 week in May 1993.

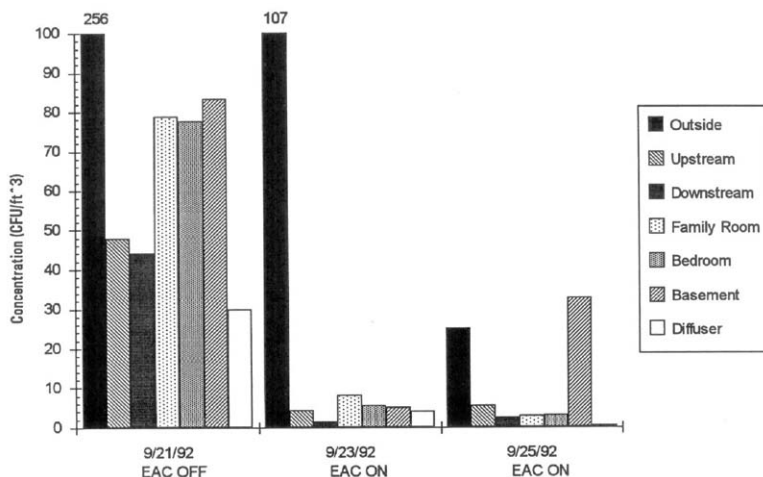

Figure 35. Culturable fungal aerosol concentrations at various locations in a residence for 1 week in September 1992.

Another study supported by ASHRAE researched the effects of construction and renovation activities on indoor air quality. Some of the results were quite surprising (Kuehn et al., 1996; Kuehn 2003). For more than 25 years, there had been a good correlation between renovation activities and hospital patient deaths documented in several countries. Further investigation revealed that the cause was the increased exposure to fungal aerosols by immune compromised patients, primarily bone marrow transplant patients. The pioneering studies conducted at the University of Minnesota Hospital and Clinic on bone marrow transplant procedures verified the assessment. The results led to the establishment of a short course (Health Care Facility Construction Management: Indoor Air Quality) that the University of Minnesota offered to train those involved with hospital construction and renovation projects to reduce the likelihood of patient infection and premature death (Figure 36). The course was offered for 10 years and resulted in hundreds of contractors, construction managers, hospital infection control practitioners, and project supervisors being trained in necessary precautions that should be taken in a health care setting. As a result of the success of this training process, the American Society of Hospital Engineers now requires certification in this area for all those who bid on health care construction projects and also conducts the certification training program on a national level.



Figure 36. Brochure from health care facility short course, 2005.

In the post-9/11 world, there is an increased concern about a bioterrorist event similar to the anthrax release in the Senate Office Building and the Brentwood Post Office facility. As bioaerosol sensors are developed to sound alarms from such a release, there is the realization that very little is known about the existing background bioaerosol population, particularly in and near buildings with a high risk for such events. We received a contract from the Department of Homeland Security to develop and demonstrate methods that can be used to document the background concentration of targeted potential threat bacteria and virus agents and their near neighbors that might cause false positive alarms. The natural background concentration of these threat agents and near neighbors is thought to be exceedingly low and thus very difficult to quantify. The approach we took was to use the existing HVAC ventilation filters in buildings as high-volume bioaerosol samplers. This would cause minimum disruption to the operation of the facility, would not be noticed by those not aware of the study, and could capture extremely small concentrations of selected bioaerosol particles over the life of the filter. We constructed a modified ASHRAE Standard 52.2 filter test facility in our laboratory, and developed methods to aerosolize, sample, and elute from a large filter several test bacteria and virus aerosols that are surrogates for various threat agents (Figure 37).

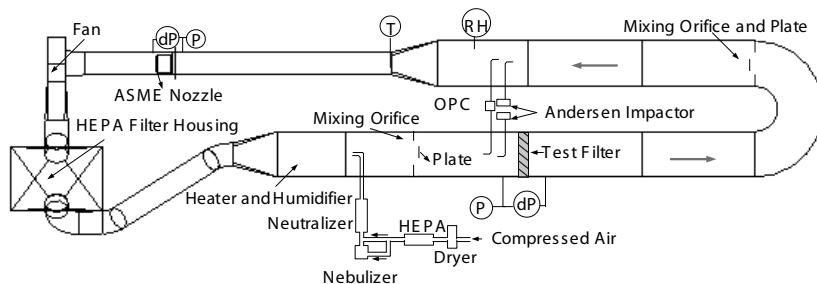

Built based on ASHRAE Standard 52.2 - 1999

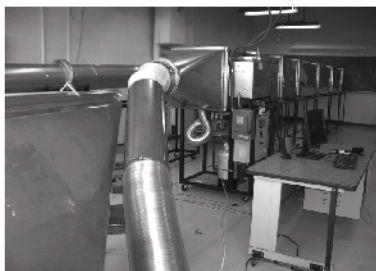
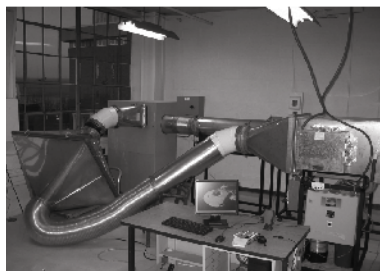

Figure 37. Bioaerosol test facility based on American Society of Heating, Refrigerating and Air-Conditioning Engineers (ASHRAE) Standard 52.2, 2004.

Notes: ASME = American Society of Mechanical Engineers; HEPA = high-efficiency particulate air; OPC = optical particle counter.

Upon satisfactorily demonstrating that the protocols would work, we conducted two field trials in large high-risk buildings located in Minneapolis and Seattle (Farnsworth et al., 2006). Results of the field trials were successful and showed that some of the threat agents and their near neighbors are indeed present in the natural background aerosol at these locations. However, their presence is also dependent on the local environmental conditions. Some of the bacteria were recovered by culture methods using an automated identification system. Targeted bacteria and viruses were also identified using polymerase chain reaction (PCR) and RT-PCR molecular identification methods. Much more effort is necessary to better quantify the biological nature of the background aerosol in various locations around the world. Our approach is a very simple, noninvasive method that holds promise for providing these data including those at extremely low concentrations that might not be observed using other methods.

Commercial Kitchens

One of the more interesting series of studies has been the work associated with commercial kitchens and restaurants. We have conducted a series of studies funded either by ASHRAE or directly by companies to better understand cooking effluents and their control from commercial kitchens. When we began our work in the mid-1990s, very little was known about emissions or the performance of grease filters. In fact, the common understanding was that grease emissions were entirely in the particle phase because EPA had classified them as condensable particulate matter. Our initial study showed that this was a misconception and that approximately one-half of the effluent entering a hood is in the vapor phase and some of it is nearly 100 percent vapor. Another misconception was that grease filters installed into kitchen hoods captured 95 percent of the effluent. There was no publicly available method to verify these claims made by the filter manufacturers. We have shown that typical grease filters have about a 20 percent capture efficiency. Over the past 15 years, we have established our laboratory as the world's preeminent laboratory for classifying cooking effluents and testing the performance of novel grease capture systems. Some of the individual studies are summarized subsequently.

The purpose of our initial study was to characterize the emissions from 10 different commercial cooking appliances and high grease-producing food products. This included 5 electric and 5 gas-fired appliances to test the hypothesis that there would be a difference based on the type of energy used. William Gerstler was the PhD student who conducted most of the tests. This study provided lunch for many of the department's graduate students as a side benefit. Unfortunately the menu was a month of hamburgers followed by a month of french fries, then pizza, and so forth. Not a particularly healthy diet. The particle results included the mass of grease effluent per unit mass of food cooked by particle size using a modified MPC1 and a MOUDI (Figure 38) (Gerstler et al., 1999; Kuehn et al., 1999). The final report from this project has become the bible of the commercial food industry (Gerstler et al., 1998) and has been reprinted by the PG&E Food Service Technology Center, San Ramon, California, for widespread distribution.

Another project was to consider the effect of exhaust velocity on the rate of grease deposition in kitchen exhaust ducts. The prevailing code, NFPA 96, required that a minimum velocity of 1,500 ft/min was required. No one knew the origin of this requirement. We built a 10 in \times 10 in horizontal duct in

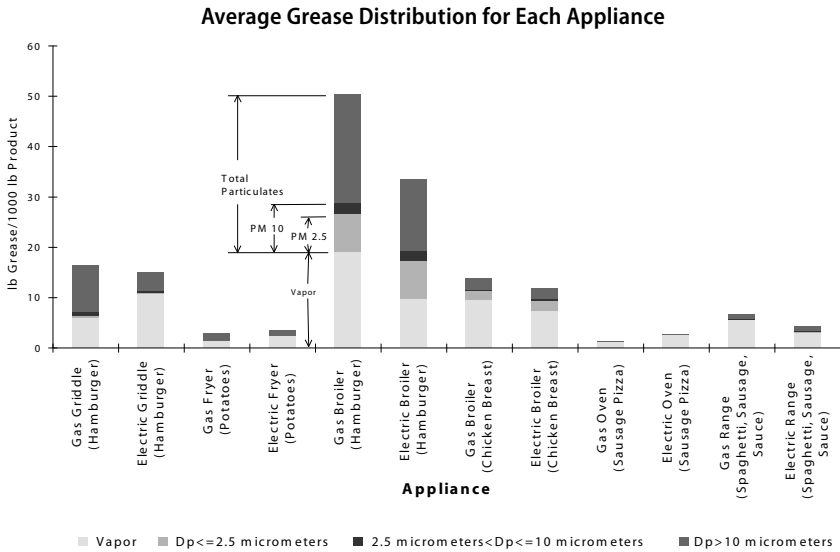

Figure 38. Grease emissions data from 10 different commercial cooking appliances and food products, 1999.

the laboratory and challenged it with uranine dye-tagged aerosol of various mean size. By swabbing the deposited material from substrates placed on the top, bottom, and sides of the duct, we were able to determine the effect of exhaust velocity on the deposition velocity versus surface orientation in a highly turbulent flow (Kuehn et al., 2001). The results were more complex than anticipated but could be explained as follows. The deposition rate was relatively high at low velocities near 500 ft/min, dropped to a minimum near 750 ft/min, and then increased as the velocity rose. With the assumption of a constant source, the high rates of deposition at the lower velocities could be explained by the increased concentration of particles within the duct. The increase at higher velocities was caused by increased turbulence in the flow. Thus a minimum in deposition velocity occurred near 750 ft/min. Thermophoretic deposition in real exhaust ducts also plays a role, as the results indicate. Based on these findings, the NFPA 96 code was changed in 2002 to allow restaurants in the United States to operate their exhaust ducts at velocities higher than 500 ft/min. This change has tremendous ramifications for the industry. Now restaurants can use variable speed fans that were previously not allowed. Between heavy cooking operations, the fans

can be slowed down to capture the small amount of effluent being generated. This reduces the fan power, the amount and energy required to heat or cool makeup air, and the rate of grease buildup in the duct so that cleaning is not required as frequently. The fire hazard from grease buildup in the duct is also reduced that may result in lower insurance rates. Vendors have been retrofitting kitchen exhaust systems with the new variable speed control technology in many restaurants and kitchens around the country.

The third major effort in the commercial kitchen arena was to establish a standard method of test for the particle capture performance of commercial kitchen grease filters. We were contracted by a consortium of companies to perform the work based on our good performance on previous projects and good reputation in the field. This included end users such as McDonalds and Burger King and several equipment suppliers such as Halton, Greenheck, and Captiveaire. Our method was based on ASHRAE Standard 52.2, a standard method of test for determining the fractional efficiency for ventilation filters. We began by using hamburger cooked on a griddle with an OPC sampling the aerosol in the exhaust duct with and without the filters present. Then we developed an artificial effluent generator by modifying a vibrating orifice generator using an Altec nozzle and replacing the syringe pump with a container of liquid maintained at constant pressure with a compressed air regulator. The medium we used was based on oleic acid with an alcohol/water mix to control the resulting mean particle size. The artificial effluent matched the hamburger effluent particle size distribution quite well although the total mass flow was about one-half that of the hamburger (Figure 39) (Kuehn et al., 2004; Schrock et al., 2006). Our test method was adopted by ASTM as a standard method of test (ASTM Standard F2519-05, 2005) that can be applied to replacement filters as well as entirely new systems such as water wash systems.

As a result of our work to better characterize cooking effluent and improve codes and standards, several equipment vendors have been developing second-generation grease capture systems that remove a majority of the grease emissions from restaurants. Federal and state agencies are using our work to better regulate particulate and vapor emissions from food service operations, most notably in California where catalytic converters are required for use over some appliances in the LA basin and similar regulations are being considered in the San Francisco Bay area.

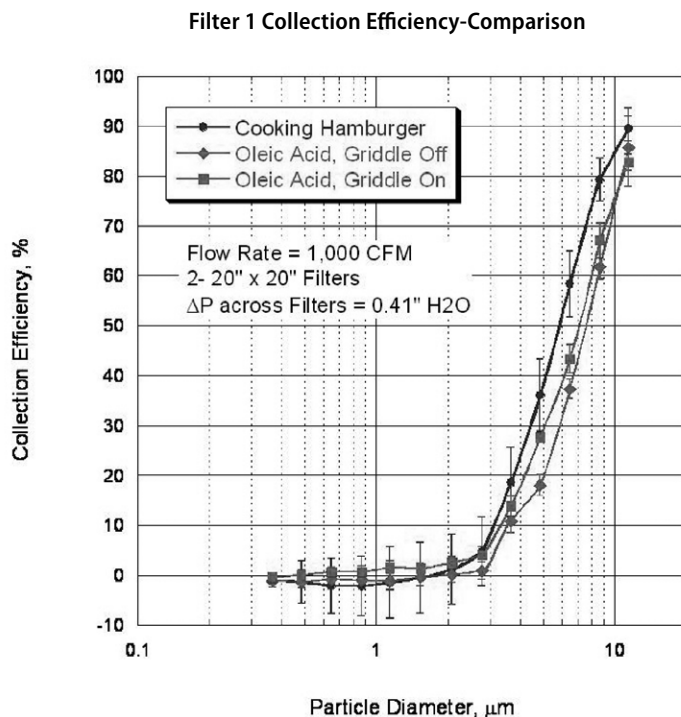

Figure 39. Fractional efficiency curves for representative commercial kitchen grease filters according to ASTM F2519-05, 2004.

References

- Accomazzo, M., Rubow, K., & Liu, B. Y. H. (1983). Ultrahigh efficiency membrane filters for semiconductor gases. *Solid State Technology*, 27, 141–146.
- Adachi, M., Okuyama, K., Kousaka, Y., Kozuru, H., & Pui, D. Y. H. (1987). Diffusion charging of ultrafine aerosol particles by positive helium, argon, and nitrogen ions. *Journal of Applied Physics*, 62, 3050–3052.
- Adachi, M., Pui, D. Y. H., & Liu, B. Y. H. (1992b). Aerosol charge by a corona ionizer. *Aerosol Science and Technology*, 18, 48–58.
- Adachi, M., Pui, D. Y. H., Romay, F. J., & Liu, B. Y. H. (Eds.). (1990). *High efficiency unipolar charger using alpha-ray radioactive source*. New York, NY: Pergamon Press.

- Adachi, M., Romay, F. J., & Pui, D. Y. H. (1992a). High efficiency unipolar aerosol charger using a radioactive alpha source. *Journal of Aerosol Science*, 23, 123–137.
- Agarwal, J. K., & Liu, B. Y. H. (1980). A criterion for accurate aerosol sampling in calm air. *American Industrial Hygiene Association Journal*, 41, 191–197.
- Ahn, K. H., & Liu, B. Y. H. (1990a). Particle activation and droplet growth processes in condensation nucleus counter, I. Theoretical background. *Journal of Aerosol Science*, 21, 249–261.
- Ahn, K. H., & Liu, B. Y. H. (1990b). Particle activation and droplet growth processes in condensation nucleus counter, II. Experimental study. *Journal of Aerosol Science*, 21, 263–275.
- Ananth, G. P., & Liu, B. Y. H. (1989). *Particle transport and deposition in computer disk drives*. 35th Annual Technical Meeting of the Institute of Environmental Sciences, Anaheim, CA.
- Asbach, C., Fissan, H., Kim, J. H., Yook, S. J., & Pui, D. Y. H. (2006). Technical note: Concepts for protection of EUVL masks from particle contamination. *Journal of Nanoparticle Research*, 8, 705–708.
- Asbach, C., Fissan, H., Kim, J. H., Yook, S.-Y., & Pui, D. Y. H. (2007). Simple theoretic approach to estimate the effect of gravity and thermophoresis on the diffusional nanoparticle contamination under low pressure conditions. *Journal of Vacuum Science and Technology*, B25, 47–53.
- Asbach, C., Stahlmecke, B., Fissan, H., Kuhlbusch, T. A., Wang, J., & Pui, D. Y. H. (2008). Analytical-statistical model to accurately estimate diffusional nanoparticle deposition on inverted surfaces at low pressure. *Applied Physics Letters*, 92, 064107.
- ASTM Standard F2519-05. (2005). Standard test method for grease particle capture efficiency of commercial kitchen filter and extractors, ASTM. doi: 10.1520/F2519-05. Retrieved from <http://www.astm.org/Standards/F2519.htm>
- Bademosi, F., & Liu, B. Y. H. (1971). *A universal law for transfer processes in Knudsen aerosols* (Unpublished doctoral dissertation). Particle Technology Laboratory, Department of Mechanical Engineering, University of Minnesota, Minneapolis, MN.

- Bae, G.-N., Kinney, P. D., Liu, B. Y. H., & Pui, D. Y. H. (1997). Investigation of aerosol spatial distribution downstream of a critical orifice at low pressure. *Aerosol Science and Technology*, 28, 474–488.
- Barris, M. A., Weik, T. M., & Liu, B. Y. H. (1986). A measurement system for high purity air filter media performance. In *32nd annual technical meeting of the Institute of Environmental Sciences* (pp. 551–555). Dallas-Ft. Worth, TX.
- Bartz, H., Fissan, H., & Liu, B. Y. H. (1984). A new aerosol generator for studies of ultrafine particles in the size range below 0.01 μm . In B. Y. H. Liu, D. Y. H. Pui, & H. Fissan (Eds.), *Aerosols: Science, technology, and industrial applications of airborne particles* (pp. 725–728). New York, NY: Elsevier Science.
- Bergin, M. H., Pui, D. Y. H., Kuehn, T. H., & Fay, W. T. (1989). Laboratory and field measurements of fractional efficiency of industrial dust collectors. *ASHRAE Transactions*, 95(2), 102–112.
- Brockmann, J. E., Liu, B. Y. H., & McMurry, P. H. (1984). A sample extraction diluter for ultrafine aerosol sampling. *Aerosol Science and Technology*, 3(4), 441–451.
- Brockmann, J. E., McMurry, P. H., & Liu, B. Y. H. (1982a). Experimental study of simultaneous coagulation and diffusional loss of free molecule aerosols in turbulent pipe flow. *Journal of Colloid and Interface Science*, 88, 522–529.
- Brockmann, J. E., McMurry, P. H., & Liu, B. Y. H. (1982b). On simultaneous coagulation and diffusional loss of free molecule aerosols in turbulent pipe flow. *Aerosol Science and Technology*, 1, 163–178.
- Brown, N. E., Liu, B. Y. H., & O'Hanlon, J. F. (1989). Performance of clean areas at Sandia National Labs exceeds goals. *Microcontamination*, 22–26.
- Campbell, S. A., Ahn, K. H., Knutson, K. L., Liu, B. Y. H., & Leighton, J. D. (1990). Steady state thermal uniformity and gas flow patterns in a rapid thermal processing chamber. *IEEE Transactions on Semiconductor Manufacturing*, 4(1), 14–20.
- Chae, S. K., Lee, H. S., & Liu, B. Y. H. (1992). Size response characteristics of a wafer surface scanner for non-ideal, real-world particles. *Journal of the IES*, 35, 45–52.

- Chen, D. R., & Pui, D. Y. H. (1994). Numerical and experimental studies of particle deposition in a tube with a conical contraction-laminar flow regime, *Journal of Aerosol Science*, 26, 563–574.
- Chen, D. R., & Pui, D. Y. H. (1997). Experimental investigation of scaling laws for electrospaying: Dielectric constant effect. *Aerosol Science and Technology*, 27, 367–380.
- Chen, D.-R., & Pui, D. Y. H. (1998). A high efficiency, high throughput unipolar charger for nanoparticles. *Journal of Nanoparticle Research*, 1, 115–116.
- Chen, D. R., & Pui, D. Y. H. (2009). Electro spray and its medical applications. In L. Gradon & J. Marijinissen (Eds.), *Nanoparticles in medicine and environment: Inhalation and health effects* (pp. 59–76). New York, NY: Springer Verlag.
- Chen, D. R., Pui, D. Y. H., & Kaufman, S. L. (1995a). Electrospaying of conducting liquids for monodisperse aerosol generation in the 4 nm to 1.8 μ m diameter range. *Journal of Aerosol Science*, 26, 963–977.
- Chen, D. R., Pui, D. Y. H., & Liu, B. Y. H. (1995b). Optimization of pleated filter designs using a finite-element numerical model. *Aerosol Science and Technology*, 23, 579–590.
- Chen, D. R., Pui, D. Y. H., & Tang, Y. M. (1996). *Filter pleating for cabin air filtration*. SAE International Congress and Exposition, Detroit, MI.
- Chen, D.-R., Pui, D. Y. H., Hummes, D., Fissan, H., Quant, F., & Sem, G. (1997). Design and evaluation of a nanometer aerosol differential mobility analyzer (Nano-DMA). *Journal of Aerosol Science*, 29, 497–509.
- Chen, D.-R., Wendt, C. H., & Pui, D. Y. H. (2000). A novel approach for introducing bio-materials into cells. *Journal of Nanoparticle Research*, 2, 133–139.
- Dick, W. D., McMurry, P. H., Weber, R. J., & Quant, F. R. (2000b). White-light detection for nanoparticle sizing with the TSI ultrafine condensation particle counter. *Journal of Nanoparticle Research*, 2, 85–90.
- Dick, W. D., Sachweh, B. A., & McMurry, P. H. (1996). Distinction of coal dust particles from liquid droplets using the DAWN-A detector. *Applied Occupational & Environmental Hygiene*, 11, 637–645.

- Dick, W. D., Saxena, P., & McMurry, P. H. (2000a). Estimation of water uptake by organic compounds in submicron aerosols measured during the Southeastern Aerosol and Visibility Study. *Journal of Geophysical Research*, *105*, 1471–1479.
- Dick, W. D., Ziemann, P. J., Huang, P.-F., & McMurry, P. H. (1998). Optical shape fraction measurements of submicrometre laboratory and atmospheric aerosols. *Measurement Science & Technology*, *9*, 183–196.
- DiFonzo, F., Gidwani, A., Fan, M., Neumann, D., Iordanoglou, D., Heberlein, J., McMurry, P. H., Girshick, S. L., Tymiak, N., Gerberich, W., & Rao, N. P. (2000). Focused nanoparticle beam deposition of patterned microstructures. *Applied Physics Letters*, *77*, 910–912.
- DisFit™ (2004). *Users Guide V. 2.0*. Forest Lake, MN: Chimera Technologies Inc.
- Ehara, K., Hagwood, C., & Coakley, K. J. (1996). Novel method to classify aerosol particles according to their mass-to-charge ratio: Aerosol particle mass analyser. *Journal of Aerosol Science*, *27*, 217–234.
- Endo, Y., Chen, D.-R., & Pui, D. Y. H. (1997a). Effects of particle polydispersity and shape factor during dust cake loading on air filters. *Powder Technology*, *98*, 241–249.
- Endo, Y., Chen, D.-R., & Pui, D. Y. H. (1997b). Bimodal aerosol loading and dust cake formation on air filters. *Filtration and Separation*, *35*, 191–195.
- Fang, C. P., Marple, V. A., & Rubow, K. L. (1991a). Influence of cross-flow on particle collection characteristics of multi-nozzle impactors. *Journal of Aerosol Science*, *22*, 403–415.
- Fang, C. P., McMurry, P. H., Marple, V. A., & Rubow, K. H. (1991b). Effect of flow-induced relative humidity changes on size cuts for sulfuric acid droplets in the microorifice uniform deposit impactor (MOUDI). *Aerosol Science and Technology*, *14*, 266–277.
- Fardi, B., & Liu, B. Y. H. (1991). Performance of disposable respirators. *Particle & Particle Systems Characterization*, *8*, 308–314.
- Fardi, B., & Liu, B. Y. H. (1992a). Flow field and pressure drop of filters with rectangular fibers. *Aerosol Science and Technology*, *17*, 36–44.
- Fardi, B., & Liu, B. Y. H. (1992b). Efficiency of fibrous filters with rectangular fibers. *Aerosol Science and Technology*, *17*, 45–58.

- Farnsworth, J. E., Goyal, S. M., Kim, S. W., Kuehn, T. H., Raynor, P. C., Ramakrishnan, M. A., . . . & Tang, W. (2006). Development of a method for bacteria and virus recovery from heating, ventilation, and air conditioning (HVAC) filters. *Journal of Environmental Monitoring*, 8, 1006–1013.
- Fay, W. T., Kuehn, T. H., Pui, D. Y. H., & Bergin, M. H. (1989). Dust collector modeling for industrial operations. *ASHRAE Transactions*, 95, 92–101.
- Fernandez de la Mora, J., Rao, N. P., & McMurry, P. H. (1990). Hypersonic impaction of ultrafine particles. *Journal of Aerosol Science*, 21, 169–187.
- Fissan, H., Hummes, D., Stratmann, F., Buscher, P., Neumann, S., Pui, D. Y. H., & Chen, D. R. (1996). Experimental comparison of four differential mobility analyzers for nanometer aerosol measurements. *Aerosol Science and Technology*, 24, 1–13.
- Fissan, H., Neumann, S., Trampe, A., Pui, D. Y. H., & Shin, W. G. (2007). Rationale and principle of an instrument measuring lung deposited nanoparticle surface area. *Journal of Nanoparticle Research*, 9, 53–59.
- Friedlander, S. K., & Pui, D. Y. H. (2003). NSF workshop report on “*Emerging Issues in Nanoparticle Science and Technology*.” Retrieved from <http://www.nano.gov/html/res/NSFAerosolParteport.pdf>
- Gallo, E. J., Ramsey, J. W., & Liu, B. Y. H. (1988). Flow visualization studies in clean rooms. In *9th international symposium on contamination control* (pp. 637–645).
- Gerstler, W., Kuehn, T., Pui, D. Y. H., & Ramsey, J. W. (1999). Measurements of the effluent from hamburger cooked on a gas underfired broiler. *ASHRAE Transactions*, 105, 303–315.
- Gerstler, W., Kuehn, T., Pui, D., Ramsey, J., Rosen, M., Carlson, R., & Petersen, S. (1998). Identification and characterization of effluents from various cooking appliances and processes as related to optimum design of kitchen ventilation systems (ASHRAE 745-RP, Phase II Final Report). Minneapolis, MN: University of Minnesota, Department of Mechanical Engineering.
- Girshick, S. L., Chiu, C. P., & McMurry, P. H. (1990). Time-dependent aerosol models and homogeneous nucleation rates. *Aerosol Science and Technology*, 13, 465–477.

- Girshick, S. L., Chiu, C.-P., Muno, R., Wu, C. Y., Yang, L., Singh, S. K., & McMurry, P. H. (1993). Thermal plasma synthesis of ultrafine iron particles. *Journal of Aerosol Science*, *24*, 367–382.
- Girshick, S. L., McMurry, P. H., Heberlein, J., Rao, N. P., & Lee, H. J. (1996). Nanostructured materials synthesis using hypersonic plasma particle deposition. *Bulletin of the American Physical Society*, *41*, 1287–1288.
- Gomes, M. S. P., Pui, D. Y. H., Vincent, J. H., & Liu, B. Y. H. (1993). The effect of Taylor diffusion on time dependent particle concentration measurements. *Journal of Aerosol Science*, *24*, 643–654.
- Gomes, M. S. P., Vincent, J. H., & Pui, D. Y. H. (1999). The effect of freestream turbulence of the transport of particles in the vicinity of a blunt flow obstacle. *Atmospheric Environment*, *33*, 4459–4468.
- Gousman, A. D., Pun, W. M., Runchal, A. K., Spalding, D. S., & Wolfshtein, M. (1969). *Heat and mass transfer in recirculating flows*. New York, NY: Academic Press.
- Grant, D. C., & Liu, B. Y. H. (1991). Sieving capture of liquidborne particles by microporous membrane filtration media. *Particle & Particle Systems Characterization*, *8*, 142–150.
- Gupta, A., Tang, D., & McMurry, P. H. (1995). Growth of monodisperse, submicron aerosol particles exposed to SO₂, H₂O₂, and NH₃. *Journal of Atmospheric Chemistry*, *20*, 117–139.
- Han, H.-S., Chen, D.-R., Pui, D. Y. H., & Anderson, B. E. (2000). A nanometer aerosol size analyzer (nASA) for rapid measurement of high-concentration size distributions. *Journal of Nanoparticle Research*, *2*, 43–52.
- Heberlein, J., Rao, N. P., Neuman, A., Blum, J., Tymiak, N., McMurry, P., & Girshick, S. (1997). Thermal spraying of nanostructured coatings by hypersonic plasma particle deposition. *Thermal spray: A united forum for scientific and technological advances*. Materials Park, OH: ASM International.
- Helsper, C., Fissan, H., Kapadia, A., & Liu, B. Y. H. (1982). Data inversion by simplex minimization for the electrical aerosol analyzer. *Aerosol Science and Technology*, *1*, 135–146.
- Husar, R. B., Whitby, K. T., & Liu, B. Y. H. (1972). Physical mechanisms governing the dynamics of Los Angeles smog aerosol. *Journal of Colloid and Interface Science*, *39*, 211–224.

- Iida, K., Stolzenburg, M., & McMurry, P. H. (2009). Effect of working fluid on sub-2nm particle detection with a laminar flow ultrafine condensation particle counter. *Aerosol Science and Technology*, *43*, 81–96.
- Iribarne, J. V., Corr, D., Liu, B. Y. H., & Pui, D. Y. H. (1977). On the hypothesis of particle fragmentation during evaporation. *Atmospheric Environment*, *11*, 639–642.
- Jiang, J., Zhao, J., Chen, M., Scheckman, J., Williams, B.J., Eisele, F.L., et al. (in press). Aerosol Research Letter: First measurements of atmospheric cluster and 1-2nm particle number distributions during nucleation events. *Aerosol Science and Technology*.
- Kemp, S. J., Kuehn, T. H., Pui, D. Y. H., Vesley, D., & Streifel, A. J. (1995a). Filter collection efficiency and growth of microorganisms on filters loaded with outdoor air. *ASHRAE Transactions*, *101*, 228–238.
- Kemp, S. J., Kuehn, T. H., Pui, D. Y. H., Vesley, D., & Streifel, A. J. (1995b). Growth of microorganisms on HVAC filters under controlled temperature and humidity conditions. *ASHRAE Transactions*, *101*, 305–316.
- Kim, J. H., Fissan, H., Asbach, C., Yook, S. J., & Pui, D. Y. H. (2006b). Speed-controlled particle injection into a low-pressure system. *Journal of Vacuum Science and Technology, A: Vacuum, Surfaces, and Films*, *24*, 229–234.
- Kim, J. H., Fissan, H., Asbach, C., Yook, S. J., Pui, D. Y. H., & Orvek, K. (2006c). Investigation of thermophoretic protection with speed-controlled particles at 100, 50, and 25 mTorr. *Journal of Vacuum Science and Technology, B: Microelectronics and Nanometer Structures—Processing, Measurement, and Phenomena*, *24*, 1178–1184.
- Kim, J. H., Fissan, H., Asbach, C., Yook, S. J., Wang, J., & Pui, D. Y. H. (2006a). Effect of reverse flow by differential pressure on the protection of critical surfaces against particle contamination. *Journal of Vacuum Science and Technology, B: Microelectronics and Nanometer Structures—Processing, Measurement, and Phenomena*, *24*, 1844–1849.
- Kim, S. C., Harrington, M., & Pui, D. Y. H. (2007a). Experimental study of nanoparticle penetration through commercial filter media. *Journal of Nanoparticle Research*, *9*, 117–125.
- Kim, S. C., Wang, J., Emery, M., & Pui, D. Y. H. (2007b). Filtration of silver nanoparticle agglomerates. *10th World Filtration Congress*, Leipzig, Germany.

- Kim, T., Suh, S.-M., Girshick, S. L., Zachariah, M. R., McMurry, P. H., Rassel, R. M., Shen, Z., & Campbell, S. A. (2002). Particle formation during low-pressure chemical vapor deposition from silane and oxygen; Measurement, modeling and film properties. *Journal of Vacuum Science & Technology, A: Vacuum, Surfaces, and Films*, 20, 412–423.
- Kinney, P. D., Bae, G. N., Pui, D. Y. H., & Liu, B. Y. H. (1996). Particle behavior in vacuum systems: Implications for in situ particle monitoring in semiconductor process equipment. *Journal of the IEST*, 39, 40–48.
- Kinney, P., Pui, D. Y. H., & Liu, B. Y. H. (1997). Particle transmission through a turbo pump. *Journal of the IEST*, 43, 31–34.
- Kinney, P., Pui, D. Y. H., Mulholland, G., & Bryner, N. P. (1991). Use of the electrostatic classification method to size 0.1 μm SRM particles—A feasibility study. *Journal of Research of the National Institute of Standards and Technology*, 96, 147–176.
- Kittelson, D. B., Moon, K. C., & Liu, B. Y. H. (1984). Filtration of diesel particles. In *Second International Conference on Carbonaceous Particles in the Atmosphere*, Linz, Austria.
- Knutson, E. O., & Whitby, K. T. (1975a). Aerosol classification by electric mobility: Apparatus, theory, and applications. *Journal of Aerosol Science*, 6, 443–451.
- Knutson, E. O., & Whitby, K. T. (1975b). Accurate measurement of aerosol electric mobility moments. *Journal of Aerosol Science*, 6, 453–460.
- Kuang, C., McMurry, P. H., McCormick, A., & Eisele, F. L. (2008). Dependence of nucleation rates on sulfuric acid concentration in diverse atmospheric locations. *Journal of Geophysical Research*, 113, D10209.
- Kuehn, T. (1982). Field heat-transfer measurements and life-cycle cost analysis of four wood-frame wall construction. *ASHRAE Transactions*, 88(Pt. 1), 651–665.
- Kuehn, T., Gacek, B., Yang, C. H., Gimsrud, D. T., Janni, K. A., Streifel, A. J., & Pearce, M. (1996). Identification of contaminants, exposures, effects and control options for construction/renovation activities. *ASHRAE Transactions*, 102, 89–101.

- Kuehn, T., Gerstler, W., Ortiz, H., Sandberg, A., Tjandra, H., Vidhani, J., . . . Pui, D. (2001). *Effects of air velocity on grease deposition in exhaust ductwork*. ASHRAE Final Report (1033-RP). Retrieved from <http://rp.ashrae.biz/page/rp-1033.pdf>
- Kuehn, T., Gerstler, W., Pui, D. Y. H., & Ramsey, J. W. (1999). Comparison of emissions from selected commercial kitchen appliances and food products. *ASHRAE Transactions*, 105, 128–141.
- Kuehn, T., & Goldstein, R. J. (1976). An experimental and theoretical study of natural convection in the annulus between horizontal concentric cylinders. *Journal of Fluid Mechanics*, 74, 695–719.
- Kuehn, T., & Goldstein, R. J. (1980a). A parametric study of Prandtl number and diameter ratio effects on natural convection heat transfer in horizontal cylindrical annuli. *Journal of Heat Transfer ASME*, 102, 768–770.
- Kuehn, T., & Goldstein, R. J. (1980b). Numerical solution to the Navier-Stokes equations for laminar natural convection about a horizontal circular cylinder. *International Journal of Heat Mass Transfer*, 23, 971–979.
- Kuehn, T., Kwon, S., & Tolpadi, A. (1983). Similarity solution for conjugate natural convection heat transfer from a long vertical plate fin. *International Journal of Heat and Mass Transfer*, 26, 1718–1721.
- Kuehn, T., Olson, B., Ramsey, J., Friell, J., & Rocklage, J. (2004). *Development of a standard method of test for commercial kitchen effluent grease removal systems* (Report). San Ramon, CA: Fisher-Nickel, Inc.
- Kuehn, T. H. (2003). Airborne infection control in health care facilities. *Journal of Solar Energy Engineering*, 125, 366–371.
- Kuehn, T. H., Marple, V. A., Han, H., Liu, B. Y. H., Shanmugavelu, I., & Youssef, S. W. (1988). Comparison of measured and predicted airflow patterns in a clean room. In *34th annual technical meeting of the Institute of Environmental Sciences* (pp. 98–107). Valley Forge, PA.
- Kuehn, T. H., Pui, D. Y. H., & Gratzek, J. P. (1991). Numerical results of cleanroom flow modeling exercise. In *37th annual technical meeting of the Institute of Environmental Sciences* (pp. 98–107). San Diego, CA.
- Kuehn, T. H., Pui, D. Y. H., Vesley, D., Kemp, S. J., Streifel, A., Marx, J., & Alfred, A. (1994). *Matching filtration to health requirements*. Minneapolis, MN: Particle Technology Laboratory, Department of Mechanical Engineering, University of Minnesota.

- Kuehn, T. H., Ramsey, J. W., & Threlkeld, J. L. (1998). *Thermal environmental engineering* (3rd ed.). Upper Saddle River, NJ: Prentice Hall.
- Kuehn, T. H., Wu, Y., & Liu, B. Y. H. (1992). Particle contamination below a robot arm in a clean room. In *38th annual technical meeting of the Institute of Environmental Sciences*, (pp. 45–53). Baltimore, MD.
- Kuhlmeiy, G. A., Liu, B. Y. H., & Marple, V. A. (1981). A micro-orifice impactor for sub-micron aerosol size classification. In *89th national meeting of the American Institute of Chemical Engineers*, Portland, OR.
- Kulmala, M., Vehkamäki, H., Petaja, T., Dal Maso, M., Lauri, A., Kerminen, V.-M., Birmili, W., & McMurry, P. H. (2004). Formation and growth rates of ultrafine atmospheric particles: a review of observations. *Journal of Aerosol Science*, 35, 143–176.
- Kwok, K.-C., & Liu, B. Y. H. (1992). How atomization affects transfer efficiency. *Industrial Finishings*, 28, 28–32.
- Kwon, S., & Kuehn, T. (1983). Conjugate natural convection heat transfer from a horizontal cylinder with a long vertical longitudinal fin. *Numerical Heat Transfer*, 6, 85–102.
- Lee, J.-K., Rubow, K. L., Liu, B. Y. H., & Zahka, J. G. (1992). Particulate retention by microporous membrane filters in liquid filtration: A predictive model and experimental study. In *38th annual technical meeting of the Institute of Environmental Sciences* (pp. 297–308). Nashville, TN.
- Lee, J. K., Rubow, K. L., Pui, D. Y. H., & Liu, B. Y. H. (1995). Comparative study of pressure reducers for aerosol sampling from high purity gases. *Aerosol Science and Technology*, 23, 481–490.
- Lee, K. W., & Liu, B. Y. H. (1980). On the minimum efficiency and the most penetrating particle size for fibrous filters. *Journal of the Air Pollution Control Association*, 30, 377–381.
- Lee, K. W., & Liu, B. Y. H. (1982a). Theoretical study of aerosol filtration by fibrous filters. *Aerosol Science and Technology*, 1, 147–161.
- Lee, K. W., & Liu, B. Y. H. (1982b). Experimental study of aerosol filtration by fibrous filters. *Aerosol Science and Technology*, 1, 35–46.
- Liu, B. Y. H. (1974). Laboratory generation of particulates with emphasis on submicron aerosols. *Journal of the Air Pollution Control Association*, 24, 1170–1172.

- Liu, B. Y. H. (1984). Application of modern aerosol instrumentation for industrial particle measurement. In *European symposium on particle characterization* (pp. 501–513), Nuremberg, West Germany.
- Liu, B. Y. H. (1987). Particle filtration by fibrous and membrane filters. In *Pharm Tech Conference '87*, East Rutherford, NJ.
- Liu, B. Y. H. (1992). Aerosol science and contamination control in microelectronics. In *4th Chinese Aerosol Conference*, Heifei and Huangshan, China.
- Liu, B. Y. H. & Agarwal, J. K. (1974). Experimental observation of aerosol deposition in turbulent flow. *Journal of Aerosol Science*, 5, 145–155.
- Liu, B. Y. H. & Ahn, K. H. (1987). Particle deposition on semiconductor wafers. *Aerosol Science and Technology*, 6, 215–224.
- Liu, B. Y. H., Berglund, R. N., & Agarwal, J. K. (1974a). Experimental studies of optical particle counters. *Atmospheric Environment*, 8, 717–732.
- Liu, B. Y. H., Chae, S.-K., & Bae, G.-N. (1992). Sizing accuracy, counting efficiency, lower detection limit and repeatability of a wafer surface scanner to ideal and real-world particles. *Journal of the Electrochemical Society*, 140, 1403–1409.
- Liu, B. Y. H. & Fardi, B. (1985). *A fundamental study of respirator air filtration*. Minneapolis, MN: Particle Technology Laboratory, Department of Mechanical Engineering, U of Minnesota.
- Liu, B. Y. H., Fardi, B., & Ahn, K. H. (1987b). Deposition of charged and uncharged aerosol particles on semiconductor wafers. In *33rd annual technical meeting of the Institute of Environmental Sciences* (pp. 461–465). San Jose, CA.
- Liu, B. Y. H., & Hsieh, K. C. (1989). Progress towards an absolute zero particle gas. In *35th Annual Technical Meeting of the Institute of Environmental Sciences*, Anaheim, CA.
- Liu, B. Y. H., & Ilori, T. A. (1974). Aerosol deposition in turbulent pipe flow. *Environmental Science & Technology*, 8, 351–356.
- Liu, B. Y. H., & Japuntich, D. A. (1987). Respirator. In *McGraw-Hill encyclopedia of science and technology*, 6th ed. (pp. 394–397). New York, NY: McGraw-Hill.

- Liu, B. Y. H., & Kapadia, A. (1978). Combined field and diffusion charging of aerosol particles in the continuum regime. *Journal of Aerosol Science*, 9, 227–242.
- Liu, B. Y. H. & Kim, C. S. (1977). On the counting efficiency of condensation nuclei counters. *Atmospheric Environment*, 11, 1097–1100.
- Liu, B. Y. H., Kuehn, T. H., & Zhao, J. (1991). Particle generation during vacuum pump down. In *37th annual technical meeting of the Institute of Environmental Sciences* (pp. 737–740). San Diego, CA.
- Liu, B. Y. H., & Kuhlmeier, G. A. (1977). Efficiency of air sampling filter media. In *Symposium and workshop on X-ray fluorescence analysis of environmental samples* (pp. 107–119). Ann Arbor, MI: Ann Arbor Science Publishers.
- Liu, B. Y. H., & Lee, K. W. (1975). An aerosol generator of high stability. *American Industrial Hygiene Association Journal*, 36, 861–865.
- Liu, B. Y. H., & Lee, K. W. (1976). Efficiency of membrane and nuclepore filters for submicrometer aerosols. *Environmental Science & Technology*, 10, 345–350.
- Liu, B. Y. H., Lee, J. W., Pui, D. Y. H., Ahn, K. H., & Gilbert, S. L. (1986a). Performance of a model clean room. In *8th international symposium on contamination control* (pp. 22–25). Milan, Italy.
- Liu, B. Y. H., & Levi, J. (1980). Generation of submicron sulfuric acid aerosol by vaporization and condensation. In K. Willeke, (Ed.), *Generation of aerosols* (317–336). Ann Arbor, MI: Ann Arbor Science Publishers.
- Liu, B. Y. H., Marple, V. A., Whitby, K. T., & Barsic, N. J. (1974b). Size distribution measurement of airborne coal dust by optical particle counters. *American Industrial Hygiene Association Journal*, 35, 443–445.
- Liu, B. Y. H., Marple, V. A., & Yazdani, H. (1969b). Comparative size measurements of monodisperse liquid aerosols by electrical and optical methods. *Environmental Science & Technology*, 3, 381–386.
- Liu, B. Y. H., & Pui, D. Y. H. (1974a). A submicron aerosol standard and the primary, absolute calibration of the condensation nuclei counter. *Journal of Colloid and Interface Science*. 47, 155–171.
- Liu, B. Y. H., & Pui, D. Y. H. (1974b). Equilibrium bipolar charge distribution of aerosols. *Journal of Colloid and Interface Science*, 49, 305–312.

- Liu, B. Y. H., & Pui, D. Y. H. (1974c). Electrical neutralization of aerosols. *Journal of Aerosol Science*, 5, 465–472.
- Liu, B. Y. H., & Pui, D. Y. H. (1975). On the performance of the electrical aerosol analyzer. *Journal of Aerosol Science*, 6, 249–264.
- Liu, B. Y. H., & Pui, D. Y. H. (1977). On unipolar diffusion charging of aerosols in the continuum regime. *Journal of Colloid and Interface Science*, 58, 142–149.
- Liu, B. Y. H., & Pui, D. Y. H. (1981). Aerosol sampling inlets and inhalable particles. *Atmospheric Environment*, 15, 589–600.
- Liu, B. Y. H., & Pui, D. Y. H. (1985). A universal aerosol sampling probe for high efficiency particle sampling from flowing gas streams. *Particle & Particle Systems Characterization*, 2, 125–132.
- Liu, B. Y. H., & Pui, D. Y. H. (1986). Aerosol sampling and sampling inlets. In *Aerosols: 2nd U.S.-Dutch International Symposium*. Chelsea, MI: Lewis Publishers.
- Liu, B. Y. H., Pui, D. Y. H., Hogan, A. W., & Rich, T. A. (1975). Calibration of the Pollak counter with monodisperse aerosols. *Journal of Applied Meteorology*, 14, 46–51.
- Liu, B. Y. H., Pui, D. Y. H., & Kapadia, A. (1979). Electrical aerosol analyzer: History, principle, and data reduction. In *Aerosol Measurement Workshop* (pp. 341–383). Gainesville, FL: University Presses of Florida.
- Liu, B. Y. H., Pui, D. Y. H., Kinstley, W. O., & Fisher, W. G. (1987a). Aerosol charging and neutralization and electrostatic discharge in clean rooms. *Journal of Environmental Sciences*, 30, 42–46.
- Liu, B. Y. H., Pui, D. Y. H., & Lin, B. Y. (1986b). Aerosol charge neutralization by a radioactive alpha source. *Particle & Particle Systems Characterization*, 3, 111–116.
- Liu, B. Y. H., Pui, D. Y. H., & Rubow, K. L. (1983a). Characteristics of air sampling filter media. In *International symposium on aerosols in the mining and industrial work environment* (pp. 989–1038). Ann Arbor, MI: Ann Arbor Science Publishers.
- Liu, B. Y. H., Pui, D. Y. H., McKenzie, R. L., Agarwal, J. K., Jaenicke, R., Pohl, F. G., Preining, O., . . . Wagner, P. E. (1982a). Intercomparison of different “absolute” instruments for measurement of aerosol number concentration. *Journal of Aerosol Science*, 13, 429–450.

- Liu, B. Y. H., Pui, D. Y. H., McKenzie, R. L., Agarwal, J. K., Pohn, F. G., Preining, O., . . . Wagner, P. E. (1984). Measurements of Kelvin-equivalent size distributions of well-defined aerosols with particle diameters >13 nm. *Aerosol Science and Technology*, 3, 107–115.
- Liu, B. Y. H., Pui, D. Y. H., Rubow, K. L., & Szymanski, W. W. (1985a). Electrostatic effects in aerosol sampling and filtration. *Annals of Occupational Hygiene*, 29, 251–269.
- Liu, B. Y. H., Pui, D. Y. H., Schaller, R. E., McDonald, B. N., & Johnson, T. W. (1986c). An optical particle counting system for testing industrial pulse-cleaned cartridge dust collectors. *Particle & Particle Systems Characterization*, 3, 68–73.
- Liu, B. Y. H., Pui, D. Y. H., & Wang, X. Q. (1982b). Drop size measurement of liquid aerosols. *Atmospheric Environment*, 16, 563–567.
- Liu, B. Y. H., Pui, D. Y. H., Wang, X. Q., & Lewis, C. W. (1983c). Sampling of carbon fiber aerosols. *Aerosol Science and Technology*, 2, 499–511.
- Liu, B. Y. H., Pui, D. Y. H., Whitby, K.T., Kittelson, D. B., Kousaka, Y. & McKenzie, R. L. (1978). The aerosol mobility chromatograph: A new detector for sulfuric acid aerosols. In *International Symposium of Sulfur in the Atmosphere* (pp. 99–104). Dubrovnik, Yugoslavia.
- Liu, B. Y. H., Rubow, K. L., & Pui, B. Y. H. (1985c). On the performance of HEPA and ULPA filters. In *31st annual technical meeting of the Institute of Environmental Sciences* (pp. 25–28). Las Vegas, NV.
- Liu, B. Y. H., Rubow, K. L., & Pui, D. Y. H. (1988). New concepts in aerosol filtration: Data analysis and performance evaluation. In *1987 U.S. Army Chemical Research, Development and Engineering Center Scientific Conference on Chemical Defense Research* (pp. 457–465). Aberdeen Proving Ground, MD.
- Liu, B. Y. H., Sega, K., Rubow, K. L., Lenhart, S. W., & Myers, W. R. (1983b). In-mask aerosol sampling for powered air purifying respirators. *American Industrial Hygiene Association Journal*, 44, 361–367.
- Liu, B. Y. H., & Szymanski, W. W. (1987). Counting efficiency, lower detection limit and noise level of optical particle counter. In *33rd annual technical meeting of the Institute of Environmental Sciences* (pp. 417–421). San Jose, CA.

- Liu, B. Y. H., Szymanski, W., & Ahn, K. H. (1985b). On aerosol size distribution measurement by laser and white light optical particle counters. *Journal of Environmental Science*, 28, 19–24.
- Liu, B. Y. H., & Verma, A. C. (1968). A pulse-charging, pulse-precipitating electrostatic aerosol sampler. *Analytical Chemistry*, 40, 843–847.
- Liu, B. Y. H., Wajsfelner, R., Billard, F., & Bricard, J. (1969a). Etude de la charge électrique porte par des particules sphériques de latex polystyrène mises en suspension dans l'air. *Les Comptes Rendus de l'Académie des sciences*, 268, 1682–1685.
- Liu, B. Y. H., & Whitby, K. T. (1968). Dynamic equilibrium in self-preserving aerosols. *Journal of Colloid and Interface Science*, 26, 161–165.
- Liu, B. Y. H., Whitby, K. T., & Pui, D. Y. H. (1974c). A portable electrical analyzer for size distribution measurement of submicron aerosols. In *66th annual meeting of the Air Pollution Control Association: Journal of the Air Pollution Control Association* (pp. 1067–1072). Chicago, IL.
- Liu, B. Y. H., Whitby, K. T., & Yu, H. H. (1966). A condensation aerosol generator for producing monodispersed aerosols in the size range 0.036 μm to 1.3 μm . *Journal de Recherches Atmosphériques*, 3, 397–406.
- Liu, B. Y. H., Whitby, K. T., & Yu, H. H. S. (1967a). Diffusion charging of aerosol particles at low pressures. *Journal of Applied Physics*, 38, 1592–1597.
- Liu, B. Y. H., Whitby, K. T., & Yu, H. H. S. (1967b). Electrostatic aerosol sampler for light and electron microscopy. *Review of Scientific Instruments*, 38, 100–102.
- Liu, B. Y. H., & Yeh, H. C. (1968). On the theory of charging of aerosol particles in an electric field. *Journal of Applied Physics*, 39, 1396–1402.
- Liu, B. Y. H., & Zhang, Z. Q. (1989). A numerical study of inertial errors in anisokinetic sampling. *Journal of Aerosol Science*, 20, 367–380.
- Liu, P., Ziemann, P. J., Kittelson, D. B., & McMurry, P. H. (1995a). Generating particle beams of controlled dimensions and divergence: I. Theory of particle motion in aerodynamic lenses and nozzle expansions. *Aerosol Science and Technology*, 22, 293–313.
- Liu, P., Ziemann, P. J., Kittelson, D. B., & McMurry, P. H. (1995b). Generating particle beams of controlled dimensions and divergence: II. Experimental evaluation of particle motion in aerodynamic lenses and nozzle expansions. *Aerosol Science and Technology*, 22, 314–324.

- Lo, L. M., Chen, D. R., & Pui, D. Y. H. (2010a). Experimental study of pleated fabric cartridges in a pulse-jet cleaned dust collector. *Powder Technology*, 197, 141–149.
- Lo, L. M., Hu, S. C., Chen, D. R., & Pui, D. Y. H. (2010b). Numerical study of pleated fabric cartridge during pulse-jet cleaning. *Powder Technology*, 198, 75–81.
- Lo, L. M., Hu, S. C., Chen, D. R., & Pui, D. Y. H. (2008). *Effect of pleat ratio on pulsejet cleaning of pleated filter cartridge*. Manuscript submitted for publication.
- Lundgren, D. A., Hlaing, D. N., Rich, T. A., & Marple, V. A. (1996). PM₁₀/PM_{2.5}/PM_{1.0} Data from a trichotomous sampler (Technical Note). *Aerosol Science and Technology*, 25, 353–357.
- Marple, V. A. (1970). *A fundamental study of inertial impactors* (Unpublished doctoral dissertation). Department of Mechanical Engineering, University of Minnesota, Minneapolis, MN.
- Marple, V. A. (1978). Simulation of respirable penetration characteristics by inertial impaction. *Journal of Aerosol Science*, 9, 125–134.
- Marple, V. A., & Chien, C. M. (1980). Virtual impactors: A theoretical study. *Environmental Science & Technology*, 14, 976–985.
- Marple, V. A., & Liu, B. Y. H. (1974). Characteristics of laminar jet impactors. *Environmental Science & Technology*, 8, 648–654.
- Marple, V. A., & Liu, B. Y. H. (1975). On fluid flow and aerosol impaction in inertial impactors. *Journal of Colloid and Interface Science*, 53, 31–34.
- Marple, V. A., Liu, B. Y. H., & Burton, R. M. (1990). High-volume impactor for sampling fine and coarse particles. *Journal of the Air and Waste Management Association*, 40, 762–767.
- Marple, V. A., Liu, B. Y. H., & Kuhlmeier, G. A. (1981). A uniform deposit impactor. *Journal of Aerosol Science*, 12, 333–337.
- Marple, V. A., Liu, B. Y. H., & Rubow, K. L. (1978). A dust generator for laboratory use. *American Industrial Hygiene Association Journal*, 39, 26–32.
- Marple, V. A., Liu, B. Y. H., & Whitby, K. T. (1973). Fluid mechanics of the laminar flow aerosol impactor. *Journal of Aerosol Science*, 5, 1–16

- Marple, V. A., Liu, B. Y. H., & Whitby, K. T. (1974). On the flow fields of inertial impactors. *Journal of Fluids Engineering*, 96, 394–400.
- Marple, V. A., & McCormack, J. E. (1983). Personal sampling impactor with respirable aerosol penetration characteristics. *American Industrial Hygiene Association Journal*, 44, 916–922.
- Marple, V. A., & Olson, B. (1995). High volume PM_{10/2.5/1.0} trichotomous sampler. In *Particulate Matter: Health and Regulatory Issues, VIP-49*. Pittsburgh, PA: Air & Waste Management Association.
- Marple, V. A., & Olson, B. (1999). A microorifice impactor with cut sizes down to 10 nanometers (Final Report for Grant Number G1135242, G1145242, G1155242/2782). Morgantown, WV: West Virginia University, National Research Center for Coal and Energy, Generic Mineral Technology Center for Respirable Dust.
- Marple, V. A., Olson, B. A., & Miller, N. C. (1995a). A low loss cascade impactor with stage collection cups: Calibration and pharmaceutical inhaler applications. *Aerosol Science and Technology*, 22, 124–134.
- Marple, V. A., Olson, B., & Rader, D. (1992). The effect of gravity on particle collection efficiency of inertial impactors. In R. L. Frantz & R. V. Ramani (Eds.), *Generic Mineral Technology Center for Respirable Dust Publications 1990, 11*, 26–29.
- Marple, V., Olson, B., & Santhanakrishnan, K. (2005). Rapid check of cascade impactor cut-sizes using polydisperse challenge aerosol calibration method. *Aerosol Science and Technology*, 40, 1064–1070.
- Marple, V., Olson, B., Santhanakrishnan, K., & Mitchell, J. P. (2004). Next generation pharmaceutical impactor (a new impactor for pharmaceutical inhaler testing)—Part III: Extension of archival calibration to 15 L/min. *Journal of Aerosol Medicine*, 17, 335–343.
- Marple, V., Olson, B., Santhanakrishnan, K., Mitchell, J. P., Murray, S. C., & Hudson-Curtis, B. L. (2003b). Next generation pharmaceutical impactor (a new impactor for pharmaceutical inhaler testing)—Part II: Archival calibration. *Journal of Aerosol Medicine*, 16, 301–324.
- Marple, V. A., & Rader, D. J. (1985). Effect of ultrastokesian drag and particle interception on impaction characteristics. *Aerosol Science and Technology*, 4, 141–156.

- Marple, V., Roberts, D. L., Romay, F. J., Miller, N. C., Truman, K. G., Van Oort, M., . . . Hochrainer, D. (2003a). Next generation pharmaceutical impactor (a new impactor for pharmaceutical inhaler testing)—Part I: Design. *Journal of Aerosol Medicine*, 16, 283–299.
- Marple, V. A., Rubow, K. L., & Behm, S. M. (1991). A microorifice uniform deposit impactor (MOUDI): Description, calibration, and use. *Aerosol Science and Technology*, 14, 434–446.
- Marple, V. A., Rubow, K. L., & Olson, B. (1995b). Diesel exhaust/mine dust personal aerosol: Sampler design, calibration and field evaluation. *Aerosol Science and Technology*, 22, 140–150.
- Marple, V. A., Rubow, K. L., & Olson, B. (1996). Diesel exhaust/mine dust personal aerosol sampler utilizing virtual impactor technology. *Applied Occupational & Environmental Hygiene*, 11, 721–727.
- Marple, V. A., Rubow, K. L., Turner, W., & Spengler, J. D. (1987). Low flow rate sharp cut impactors for indoor air sampling: Design and calibration. *Journal of the Air Pollution Control Association*, 37, 1303–1307.
- Maynard, A. D., & Pui, D. Y. H. (Eds.). (2007a). *Nanoparticles and occupational health*. Dordrecht, The Netherlands: Springer.
- Maynard, A. D., & Pui, D. Y. H. (Eds.). (2007b). Special issue on nanoparticles and occupational health [Special issue]. *Journal of Nanoparticle Research*, 9(1).
- McDonald, B. N., Schaller, R. E., Engel, M. R., Liu, B. Y. H., Pui, D. Y. H., & Johnson, T. (1986). Time resolved measurements of industrial pulse-cleaned cartridge dust collectors. In R. R. Raber (Ed.), *Fluid Filtration: Gas*. Philadelphia, PA: ASTM.
- McFarland, A. R., & Tomaidēs, M. (1969a). Characterization of chain agglomerate aerosols—A low pressure impactor for aerosol sampling on electron microscope grids; An improved exploding wire aerosol generator; response of an optical counter to a chain agglomerate aerosol. Particle Technology Laboratory, Department of Mechanical Engineering, University of Minnesota: Minneapolis, MN.
- McFarland, A. R., & Tomaidēs, M. (1969b). Response of an optical counter to chain agglomerate aerosols. *Environmental Science & Technology*.

- McMurry, P. H. (1980). Photochemical aerosol formation from SO₂: A theoretical analysis of smog chamber data. *Journal of Colloid and Interface Science*, 78, 513–527.
- McMurry, P. H. (1983). New particle formation in the presence of an aerosol: Rates, time scales, and sub-0.01 μm size distributions. *Journal of Colloid and Interface Science*, 95, 72–80.
- McMurry, P. H., & Friedlander, S. K. (1979). New particle formation in the presence of an aerosol. *Atmospheric Environment*, 13, 1635–1651.
- McMurry, P. H., Litchy, M., Huang, P.-F., Cai, X., Turpin, B. J., Dick, W. D., & Hanson, A. (1996a). Elemental composition and morphology of individual particles separated by size and hygroscopicity with the TDMA. *Atmospheric Environment*, 30, 101–108.
- McMurry, P. H., Nijhawan, S., Rao, N., Ziemann, P., Kittelson, D. B., & Campbell, S. (1996c). Particle beam mass spectrometer measurements of particle formation during low pressure chemical vapor deposition of polysilicon and silicon dioxide films. *Journal of Vacuum Science and Technology*, A(14), 582–587.
- McMurry, P. H., & Rader, D. J. (1986). Application of the tandem differential mobility analyzer to studies of droplet growth or evaporation. *Journal of Aerosol Science*, 17, 771–787.
- McMurry, P. H., Rader, D. J., & Stith, J. (1981). Studies of aerosol formation in power plant plumes—I. Growth laws for secondary aerosols in power plant plumes: Implications for chemical conversion mechanisms. *Atmospheric Environment*, 15, 2315–2327.
- McMurry, P. H., & Wilson, J. C. (1982). Growth laws for the formation of secondary ambient aerosols: Implications for chemical conversion mechanisms. *Atmospheric Environment*, 16, 121–134.
- McMurry, P. H., & Wilson, J. C. (1983). Droplet phase (heterogeneous) and gas phase (homogenous) contributions to secondary ambient aerosol formation as functions of relative humidity. *Journal of Geophysical Research*, 88, 5101–5108.
- McMurry, P. H., Woo, K.-S., Weber, R. J., Chen, D.-R., & Pui, D. Y. H. (2000). Size distributions of 3–10 nm atmospheric particles: Implications for nucleation mechanisms. *Philosophical Transactions of the Royal Society of London, Series A: Physical Sciences and Engineering*, 358, 2625–2642.

- McMurry, P. H., Zhang, X., & Lee, C.-T. (1996b). Issues in aerosol measurement for optic assessments. *Journal of Geophysical Research*, *101*, 19189–19197.
- Mulholland, G. W., Donnelly, M., Hagwood, C., Kukuck, S., & Hackley, V. (2006). Measurement of 100nm and 60nm particle standards by differential mobility analysis. *Journal of Research of the National Institute of Standards and Technology*, *111*, 257–312.
- Mulholland, G. W., & Liu, B. Y. H. (1980). Response of smoke detectors to monodisperse aerosols. *Journal of Research of the National Bureau of Standards*, *85*, 223–238.
- Mulholland, G. W., Pui, D. Y. H., Kapadia, A., & Liu, B. Y. H. (1980). Aerosol number and mass concentration measurements: A comparison of the electrical aerosol analyzer with other measurement techniques. *Journal of Colloid and Interface Science*, *77*, 57–67.
- Nijhawan, S., McMurry, P. H., & Campbell, S. A. (2000). Particle transport in parallel-plate semiconductor reactor: Chamber modification and design criterion for enhanced process cleanliness. *Journal of Vacuum Science and Technology, A: Vacuum, Surfaces, and Films*, *18*, 2198–2206.
- Nijhawan, S., McMurry, P. H., Swihart, M. T., Suh, S.-M., Girshick, S. L., Campbell, S. A., & Brockmann, J. E. (2003). An experimental and numerical study of particle nucleation and growth during low-pressure thermal decomposition of silane. *Journal of Aerosol Science*, *34*, 691–711.
- Opiolka, S., Fissan, H., Ye, Y., & Pui, D. Y. H. (1990). Reduction of particle deposition on a free-standing semiconductor wafer by thermophoretic effect. In *10th international symposium on contamination control* (pp. 85–88). Zurich, Switzerland.
- Pak, S. S., Liu, B. Y. H., & Rubow, K. L. (1992). The effect of coating thickness on particle bounce in inertial impactors. *Aerosol Science and Technology*, *16*, 141–150.
- Park, K., Dutcher, D., Emery, M., Pagels, J., Sakurai, H., Scheckman, J., . . . & McMurry, P. H. (2008). Tandem measurements of aerosol properties—A review of mobility techniques with extensions. *Aerosol Science and Technology*, *42*, 801–816.

- Poon, W. S., Pui, D. Y. H., Lee, C.-T., & Liu, B. Y. H. (1994a). A compact porous denuder for atmospheric sampling of inorganic aerosols. *Journal of Aerosol Science*, 25, 923–934.
- Poon, W. S., Pui, D. Y. H., Liu, B. Y. H., & Sun, J.-J. (1994b). A compact porous-metal denuder sampler for atmospheric and indoor air sampling of inorganic acidic pollutants: Field comparison with an annular denuder system. *Journal of Aerosol Science*, 25, 923–934.
- Pui, D. Y. H. (1973). *Electrical neutralization and stationary charge distribution of aerosol particles* (Unpublished master's thesis). Department of Mechanical Engineering, University of Minnesota, Minneapolis, MN.
- Pui, D. Y. H. (1976). *Experimental study of diffusion charging of aerosols* (Unpublished doctoral dissertation). Department of Mechanical Engineering, University of Minnesota, Minneapolis, MN.
- Pui, D. Y. H., & Chen, D. R. (2002). *U.S. Patent No. 6,399,362*. Washington, DC: U.S. Patent and Trademark Office.
- Pui, D. Y. H., & Chen, D. R. (2004). *U.S. Patent No. 6,764,720*. Washington, DC: U.S. Patent and Trademark Office.
- Pui, D. Y. H., & Liu, B. Y. H. (1979). Electrical aerosol analyzer: Calibration and performance. In *Aerosol measurement workshop* (pp. 384–399). Gainesville, FL: University Presses of Florida.
- Pui, D. Y. H., Gratzek, J. P., & Kuehn, T. H. (1991). Experimental measurements of cleanroom airflow and particle transport for flow modelling exercise. In *37th annual technical meeting of the Institute of Environmental Sciences*, San Diego, CA.
- Pui, D. Y. H., Qi, C., Stanley, N., Oberdorster, G., & Maynard, A. (2008). Recirculating air filtration significantly reduces exposure to airborne nanoparticles. *Environmental Health Perspectives*, 116, 863–866.
- Pui, D. Y. H., Romay-Novas, F., & Liu, B. Y. H. (1987). Experimental study of particle deposition in bends of circular cross section. *Aerosol Science and Technology*, 7, 301–315.
- Pui, D. Y. H., Tsai, C. J., & Liu, B. Y. H. (1988). Charge level on aerosol particles: Measurement of particle charge and size distribution in disk drive. In *34th annual technical meeting of the Institute of Environmental Sciences*, King of Prussia, PA.

- Pui, D. Y. H., Ye, Y., & Liu, B. Y. H. (1990). Experimental study of particle deposition on semiconductor wafers. *Aerosol Science and Technology*, *12*, 795–804.
- Qi, C., Asbach, C., Shin, W. G., Fissan, H., & Pui, D. Y. H. (2009). The effect of particle pre-existing charge on unipolar charging and its implication on electrical aerosol measurements. *Aerosol Science and Technology*, *43*, 232–240.
- Qi, C., Stanley, N., Pui, D. Y. H., & Kuehn, T. H. (2008). Laboratory and on-road evaluations of cabin air filters using number and surface area concentration monitors. *Environmental Science and Technology*, *42*, 4128–4132.
- Rader, D. J., McMurry, P. H., & Smith, S. (1987). Evaporation rates of monodisperse organic aerosols in the 0.02- to 0.2- μm -diameter range. *Aerosol Science and Technology*, *6*, 247–260.
- Ramsey, J. W., Liu, B. Y. H., & Gallo, E. J. (1988). A non-contaminating fog generator for flow visualization in clean rooms. In *9th international symposium on contamination control* (pp. 637–645). Los Angeles, CA.
- Rao, N., Girshick, S., Heberlein, J., McMurry, P. H., Jones, S., Hansen, D., & Micheel, B. (1995b). Nanoparticle formation using a plasma expansion process. *Plasma Chemistry and Plasma Processing*, *15*, 581–606.
- Rao, N., Micheel, B., Hansen, D., Fandrey, C., Bench, M., Girshick, S., . . . & McMurry, P. H. (1995a). Synthesis of nanophase silicon, carbon, and silicon carbide powders using a plasma expansion process. *Journal of Material Research*, *10*, 2073–2084.
- Rao, N. P., & McMurry, P. H. (1989). Nucleation and growth of aerosol in chemically reacting systems: A theoretical study of the near-collision-controlled regime. *Aerosol Science and Technology*, *11*, 120–132.
- Rao, N. P., Nijhawan, S., Kim, T., Wu, Z., Campbell, S., Kittelson, D. B., . . . Mastromatteo, E. (1998c). Investigation of particle generation during the low pressure chemical vapor deposition of borophosphosilicate glass. *Journal of the Electrochemical Society*, *145*, 2051–2057.
- Rao, N. P., Tymiak, N., Blum, J., Neuman, A., Lee, H. J., Girshick, S. L., . . . & Heberlein, J. (1998b). Hypersonic plasma particle deposition of nanostructured silicon and silicon carbide. *Journal of Aerosol Science*, *29*, 707–720.

- Rao, N. P., Wu, Z., Nijhawan, S., Ziemann, P., Campbell, S., Kittelson, D. B., & McMurry, P. (1998a). Investigation of particle formation during the plasma enhanced chemical vapor deposition of amorphous silicon, oxide, and nitride films. *Journal of Vacuum Science and Technology, B: Microelectronics Processing and Phenomena*, 16, 483–489.
- Romay, F. J., & Pui, D. Y. H. (1992a). Free electron charging of ultrafine aerosol particles. *Journal of Aerosol Science*, 23, 679–692.
- Romay, F. J., & Pui, D. Y. H. (1992b). On the combination coefficient of positive ions with ultrafine neutral particles in the transition and free-molecule regimes. *Aerosol Science and Technology*, 17, 134–147.
- Romay, F., Pui, D. Y. H., & Adachi, M. (1991). Unipolar diffusion charging of aerosol particles at low pressure. *Aerosol Science and Technology*, 15, 60–68.
- Roth, P., Zell, U., & Liu, B. Y. H. (1984). Particle dispersion by shock and expansion waves: Preliminary observations and experiments. *Journal of Aerosol Science*, 15, 293–296.
- Rowley, F. B., & Beal, J. (1929). Determining the quantity of dust in air by impingement. *ASHVE Transactions*, 35, 483–498.
- Rowley, F. B., & Jordan, R. C. (1939). A standard air filter dust test. *ASHVE Journal Section, Heating, Piping, and Air Conditioning*, 11, 633–638.
- Rowley, F. B., & Jordan, R. C. (1941). A comparison of the weight, particle count and discoloration methods of testing air filters. *ASHVE Journal Section, Heating, Piping, and Air Conditioning*, 13, 246–255.
- Rowley, F. B., & Jordan, R. C. (1942). Overloading of viscous air filters during accelerated tests. *ASHVE Journal Section, Heating, Piping, and Air Conditioning*, 14, 438–477.
- Rubow, K. L., Cantrell, B. K., & Marple, V. A. (1990a). Measurement of coal dust and diesel exhaust aerosols in underground mines. In *VII international pneumoconiosis conference* (pp. 645–650). Pittsburgh, PA.
- Rubow, K. L., Lee, J. K., Pui, D. Y. H., & Liu, B. Y. H. (1990b). Performance evaluation and comparative study of pressure reducers for aerosol sampling from high purity gases. In *10th international symposium on contamination control*. Zurich, Switzerland.
- Rubow, K. L., & Liu, B. Y. H. (1984). Evaluation of ultra-high efficiency membrane filters. In *30th Annual Technical Meeting of the Institute of Environmental Sciences* (pp. 64–68).

- Rubow, K. L., & Liu, B. Y. H. (1985). Evaluation of ultra high-efficiency membrane filters. *Microcontamination*, 39–43.
- Rubow, K. L., & Liu, B. Y. H. (1986). Characteristics of membrane filters for particle collection. In R. R. Raber, (Ed.), *Filtration: Gas volume 1* (pp. 74–94). Philadelphia, PA: American Society for Testing and Materials.
- Rubow, K. L., Liu, B. Y. H., & Grant, D. C. (1988). Characteristics of ultra-high efficiency membrane filters in gas applications. In *33rd annual technical meeting of the Institute of Environmental Sciences* (pp. 383–387). San Jose, CA.
- Rubow, K. L., & Marple, V. (1988). Determining the size distribution of coal/diesel aerosol mixtures with the microorifice uniform deposit impactor. In *International symposium on respirable dust in the mineral industries*, University Park, PA.
- Rubow, K. L., & Marple, V. A. (1982). Instrument evaluation chamber: Calibration of commercial photometers. In *International symposium on aerosols in the mining and industrial work environment*, Minneapolis, MN.
- Rubow, K. L., Marple, V. A., Olin, J., & McCawley, M. A. (1987). A personal cascade impactor: Design, evaluation and calibration. *American Industrial Hygiene Association Journal*, 48, 532–538.
- Sachweh, B. A., Dick, W. D., & McMurry, P. H. (1995). Distinguishing between spherical and nonspherical particles by measuring the variability in azimuthal light scattering. *Aerosol Science and Technology*, 23, 373–391.
- Sadjadi, R. S. M., & Liu, B. Y. H. (1991). Characteristics of pin-hole leaks in HEPA and ULPA filters. In *36th annual technical meeting of the Institute of Environmental Sciences*. New Orleans, LA.
- Saros, M. T., Weber, R. J., Marti, J. J., & McMurry, P. H. (1996). Ultrafine aerosol measurement using a condensation nucleus counter with pulse height analysis. *Aerosol Science and Technology*, 25, 200–213.
- Sato, S., Chen, D.-R., & Pui, D. Y. H. (2001). Particle transport at low pressure: Particle deposition in bends of circular cross section. *Aerosol Science and Technology*, 37, 770–779.
- Sato, S., Chen, D.-R., & Pui, D. Y. H. (2002). Particle transport at low pressure: Particle deposition in a tube with an abrupt contraction. *Journal of Aerosol Science*, 33, 659–671.

- Schaefer, J. W., Barris, M. A., & Liu, B. Y. H. (1986). Filter media design for high purity air applications, *Journal of Environmental Science*, 29, 27–31.
- Scheckman, J. (2008). Mass mobility relationship for silica agglomerates: *Implications for transport and morphological properties* (Unpublished master's thesis). Department of Mechanical Engineering, University of Minnesota, Minneapolis, MN.
- Schrock, D. W., Olson, B., Urness, R. I., Kuehn, T., & Breitenfeld, A. L. (2006). A new standard method of test for determining the grease particulate removal efficiency of filter systems for kitchen ventilation. *ASHRAE Transactions*, 112, 583–590.
- Sem, G. J., Boulaud, D., Brimblecombe, P., Ensor, D. S., Gentry, J. W., Marijnissen, J. C. M., & Preining, O. (Eds.). (2005). *History and reviews of aerosol science. (Proceedings of the second symposium on the history of aerosol science, October 13–14, 2001, Portland, Oregon, USA)*. Mount Laurel, NJ: American Association for Aerosol Research.
- Shanmugavelly, I., Kuehn, T. H., & Liu, B. Y. H. (1987). Numerical simulation of flow fields in clean rooms. In *33rd annual technical meeting of the Institute of Environmental Sciences*, San Jose, CA.
- Shin, W. G., Mulholland, G. W., Kim, S. C., Wang, J., Emery, M., & Pui, D. Y. H. (2009a) Friction coefficient and mass of silver agglomerates in the transition regime. *Journal of Aerosol Science*, 40, 575–587.
- Shin, W. G., Pui, D. Y. H., Fissan, H., Neumann, S., & Trampe, A. (2007). Calibration and numerical simulation of the nanoparticle surface area monitor (TSI Model 3550 NSAM). *Journal of Nanoparticle Research*, 9, 61–69.
- Shin, W. G., Qi, C., Wang, J., Fissan, H., & Pui, D. Y. H. (2009b) The effect of dielectric constant of materials on unipolar charging. *Journal of Aerosol Science*, 40, 463–468.
- Shin, W. G., Wang, J., Mertler, M., Sachweh, B., Fissan, H., & Pui, D. Y. H. (2009c). Structural properties of silver nanoparticle agglomerates based on transmission electron microscopy: Relationship to particle mobility analysis. *Journal of Nanoparticle Research*, 11, 163–173.
- Sinclair, D., Countess, R. J., Liu, B. Y. H., & Pui, D. Y. H. (1976). Experimental verification of diffusion battery theory. In *68th annual meeting of the Air Pollution Control Association* (pp. 661–663). Boston, MA.

- Sinclair, D., Countess, R. J., Liu, B. Y. H., & Pui, D. Y. H. (1979). Automatic analysis of submicron aerosol. In *Aerosol measurement workshop* (pp. 544–563). Gainesville, FL: University of Florida Presses.
- Smith, J. N., Dunn, M. J., VanReken, T. M., Iida, K., Stolzenburg, M. R., . . . & Huey, G. (2008). The chemical composition of atmospheric nanoparticles formed from nucleation in Tecamac, Mexico: Evidence for an important role for organic species in nanoparticle growth. *Geophysical Research Letters*, *35*, L04808.
- Smith, J. N., Moore, K. F., Eisele, F. L., Voisin, D., Ghimire, A. K., Sakurai, H., & McMurry, P. H. (2005). Chemical composition of atmospheric nanoparticles during nucleation events in Atlanta, Georgia. *Journal of Geophysical Research*, *110*, D22S03.
- Smith, J. N., Barsanti, K. C., Friedli, H. R., Ehn, M., Kulmala, M., Collins, D. R., Scheckman, J. H., Williams, B. J., & McMurry, P. H. (2010). Observations of aminium salts in atmospheric nanoparticles and possible climatic implications. *Proceedings of the National Academy of Sciences*, *107*, 6634–6639.
- Stolzenburg, M. R., & McMurry, P. H. (1991). An ultrafine aerosol condensation nucleus counter. *Aerosol Science and Technology*, *14*, 48–65.
- Swietlicki, E., Hansson, H.-C., Hämeri, K., Svenningsson, B., Massling, A., McFiggans, G., . . . Kulmala, M. (2008). Hygroscopic properties of sub-micrometer atmospheric aerosol particles measured with H-TDMA instruments in various environments—A review. *Tellus. Series B: Chemical and Physical Meteorology*, *60B*, 432–469.
- Szydlowski, R., & Kuehn, T. (1981). Analysis of transient heat loss in earth sheltered structures. *American Underground Space Journal*, *5*, 237–246.
- Szymanski, W. W., & Liu, B. Y. H. (1986). On the sizing accuracy of laser optical particle counters. *Particle & Particle Systems Characterization*, *3*, 1–7.
- Tolpadi, A., & Kuehn, T. (1984). Conjugate three-dimensional natural convection heat transfer from a horizontal cylinder with long transverse plate fins. *Numerical Heat Transfer*, *7*, 319–341.
- Tomaidēs, M., Liu, B. Y. H., & Whitby, K. T. (1971). Evaluation of the condensation aerosol generator for producing monodispersed aerosols. *Journal of Aerosol Science*, *2*, 39–46.

- Tsai, C. J., & Pui, D. Y. H. (1990). Numerical study of particle deposition in bends of a circular cross section — laminar flow regime. *Aerosol Science and Technology*, 12, 813–831.
- Tsai, C. J., Pui, D. Y. H., & Liu, B. Y. H. (1990a). Capture and rebound of small particles upon impact with solid surfaces. *Aerosol Science and Technology*, 12, 497–507.
- Tsai, C. J., Pui, D. Y. H., & Liu, B. Y. H. (1991a). Elastic flattening and particle adhesion. *Aerosol Science and Technology*, 15, 239–255.
- Tsai, C.-J., Pui, D. Y. H., & Liu, B. Y. H. (1991d). Numerical study of transport and deposition of wear particles in computer disk drives. In *37th annual technical meeting of the Institute of Environmental Sciences*, San Diego, CA.
- Tsai, C. J., Pui, D. Y. H., & Liu, B. Y. H. (1991c). Particle detachment from disk surfaces of computer disk drives. *Journal of Aerosol Science*, 22, 737–746.
- Tsai, C. J., Pui, D. Y. H., & Liu, B. Y. H. (1991b). Wear particle generation in thin film computer disk drives: Experimental study. *Aerosol Science and Technology*, 15, 36–48.
- Tsai, C.-J., Pui, D. Y. H., & Liu, B. Y. H. (1992). Transport and deposition of wear particles in computer disk drives. *Particle & Particle Systems Characterization*, 9, 31–39.
- Tymiak, N., Blum, J., Neuman, N., Rao, N., Gerberich, W., McMurry, P. H., Heberlein, J.V.R., & Girshick, S. (2001). Hypersonic plasma particle deposition of nanostructured silicon carbide films for friction and wear resistance. *Journal of Thermal Spray Technology*, 10, 173–174.
- Voisin, D., Smith, J. N., Sakurai, H., McMurry, P. H., & Eisele, F. L. (2003). Thermal desorption chemical ionization mass spectrometer for ultrafine particle chemical composition. *Aerosol Science and Technology*, 37, 471–475.
- Wahi, B. N., & Liu, B. Y. H. (1971). The mobility of polystyrene latex particles in the transition and the free molecular regimes. *Journal of Colloid and Interface Science*, 37, 374–381.
- Wang, J., Chen, D.-R., & Pui, D. Y. H. (2007). Modeling of filtration efficiency of nanoparticles in standard filter media. *Journal of Nanoparticle Research*, 9, 109–115.

- Wang, J., Kim, S. C., & Pui, D. Y. H. (2008b). Figure of merit of composite filters with micrometer and nanometer fibers. *Aerosol Science and Technology*, *42*, 722–728.
- Wang, J., Pui, D. Y. H., Qi, C., Yook, S.-J., Fissan, H., Ultanir, E., & Liang, T. (2008a). Controlled deposition of NIST-traceable nanoparticles as additional size standards for photomask applications. In *SPIE symposium on advanced lithography* (pp. 1–10). San Jose, CA.
- Wang, X., Gidwani, A., Girshick, S. L., & McMurry, P. H. (2005a). Aerodynamic focusing of nanoparticles: II. Numerical simulation of particle motion through aerodynamic lenses. *Aerosol Science and Technology*, *39*, 624–636.
- Wang, X., Kruijs, F. E., & McMurry, P. H. (2005b). Aerodynamic focusing of nanoparticles: II. Numerical simulation of particle trajectories through aerodynamic lenses. *Aerosol Science and Technology*, *39*, 611–623.
- Wang, X., & McMurry, P. H. (2006b). A design tool for aerodynamic lens systems. *Aerosol Science and Technology*, *40*, 320–334.
- Wang, X., & McMurry, P. H. (2006a). An experimental study of nanoparticle focusing with aerodynamic lenses. *International Journal of Mass Spectroscopy*, *258*, 30–36.
- Weber, R. J., Marti, J. J., McMurry, P. H., Eisele, F. L., Tanner, D. J., & Jefferson, A. (1996). Measured atmospheric new particle formation rates: Implications for nucleation mechanisms. *Chemical Engineering Communications*, *151*, 53–64.
- Weber, R. J., Marti, J. J., McMurry, P. H., Eisele, F. L., Tanner, D. J., & Jefferson, A. (1997). Measurements of new particle formation and ultrafine particle growth rates at a clean continental site. *Journal Geophysical Research*, *102*, 4375–4385.
- Weber, R. J., & McMurry, P. H. (1996). Fine particle size distributions at the Mauna Loa observatory, Hawaii. *Journal of Geophysical Research*, *101*, 14767–14775.
- Weber, R. J., McMurry, P. H., Eisele, F. L., & Tanner, D. J. (1995). Measurement of expected nucleation precursor species and ultrafine and fine particles at Mauna Loa Observatory, Hawaii. *Journal of Atmospheric Science*, *52*, 2242–2257.

- Weber, R. J., McMurry, P. H., Mauldin, L., Tanner, D., Eissele, F., Clarke, A. D., & Kapustin, V. N. (1999). New particle formation in the remote troposphere: A comparison of observations at various sites. *Geophysical Research Letters*, *26*, 307–310.
- Weber, R. J., McMurry, P. H., Mauldin, L., Tanner, D. J., Eisele, F. L., Brechtel, F. J., Kreidenweis, S. M., Kok, G. L., Schillawski, R. D., & Baumgardner, D. (1998b). A study of new particle formation and growth involving biogenic and trace gas species measured during ACE 1. *Journal of Geophysical Research*, *103*, 16385–16396.
- Weber, R. J., Stolzenburg, M. R., Pandis, S. N., & McMurry, P. H. (1998a). Inversion of ultrafine condensation nucleus counter pulse height distributions to obtain nanoparticle (~3–10 nm) size distributions. *Journal of Aerosol Science*, *29*, 601–615.
- Whitby, E. R., & McMurry, P. H. (1997). Modal aerosol dynamics modeling. *Aerosol Science and Technology*, *27*, 673–688.
- Whitby, K. T. (1954). *The mechanics of fine sieving* (Unpublished doctoral dissertation). Department of Mechanical Engineering, University of Minnesota, Minneapolis, MN.
- Whitby, K. T. (1955). A rapid general purpose centrifuge sedimentation method for measurement of size distribution of small particles—Part II. Procedures and applications. *ASHAE Journal Section, Heating, Piping, and Air Conditioning*, *27*, 139–145.
- Whitby, K. T. (1961). Generator for producing high concentrations of small ions. *Review of Scientific Instruments*, *32*, 1351–1355.
- Whitby, K. T., Algren, A. B., Jordan, R. C., & Annis, J. C. (1957). The ASHAE air-borne dust survey. *ASHAE Journal Section, Heating, Piping, and Air Conditioning*, *29*, 185–192.
- Whitby, K. T., & Clark, W. E. (1966). Electric aerosol particle counting and size distribution measuring system for the 0.015 to 1 μ size range. *Tellus*, *18*, 573–586.
- Whitby, K. T., Clark, W. E., Marple, V. A., Sverdrup, G. M., Sem, G. J., Willeke, K., . . . & Pui, D. Y. H. (1975). Characterization of California aerosols—I. Size distributions of freeway aerosol. *Atmospheric Environment*, *9*, 463–482.

- Whitby, K. T., & Liu, B. Y. H. (1967). Generation of countable pulses by high concentrations of subcountable sized particles in the sensing volume of optical counters. *Journal of Colloid and Interface Science*, 25, 537–546.
- Whitby, K. T., & Liu, B. Y. H. (1968). Polystyrene aerosols-electrical charge and residue size distribution. *Atmospheric Environment*, 2, 103–116.
- Whitby, K. T., Liu, B. Y. H., Friedlander, S. K., Mueller, P. K., Charlson, R. A., Lundgren, D. A., & Noll, K. E. (1969). Los Angeles smog aerosol study. In *7th international conference on condensation and ice nuclei*. Prague, Czechoslovakia, Vienna, Austria.
- Whitby, K. T., Husar, R. B., & Liu, B. Y. H. (1972a). The aerosol size distribution of Los Angeles smog. *Journal of Colloid and Interface Science*, 39, 177–204.
- Whitby, K. T., Liu, B. Y. H., Husar, R. B., & Barsic, N. J. (1972b). The Minnesota aerosol-analyzing system used in the Los Angeles smog project. *Journal of Colloid and Interface Science*, 39, 136–164.
- Willeke, K., & Liu, B. Y. H. (1976). Single particle optical counter: Principle and application. In B. Y. Liu (Ed.), *Fine particles: Aerosol generation, measurement, sampling, and analysis* (pp. 697–729). New York, NY: Academic Press.
- Wilson, J. C., & Liu, B. Y. H. (1980). Aerodynamic particle size measurement by laser-doppler velocimetry. *Journal of Aerosol Science*, 11, 139–150.
- Wilson, J. C., & McMurry, P. H. (1981). Studies of aerosol formation in power plant plumes—II. Secondary aerosol formation in the Navajo Generating Station plume, *Atmospheric Environment*, 15, 2329–2339.
- Wilson, W. E., Han, H.-S., Stanek, J., Turner, J., Chen, D.-R., Johnson, T., & Pui, D. Y. H. (2005). Use of the electrical aerosol detector as an indicator for the total particle surface area deposited in the lung. *Journal of the Air and Waste Management Association*, 57, 211–220.
- Wilson, W. E., Spiller, L. L., Ellestad, T. G., Lamothe, P. J., Dzubay, T. G., Stevens, R. K., . . . Cantrell, B. K. (1977). General Motors sulfate dispersion experiment: Summary of EPA measurements. *Journal of the Air Pollution Control Association*, 27, 46–51.

- Woo, K. S., Chen, D. R., Pui, D. Y. H., & McMurry, P. H. (2001). Measurement of Atlanta aerosol size distributions: Observations of ultrafine particle events. *Aerosol Science and Technology*, *34*, 75–87.
- Ye, Y., & Pui, D. Y. H. (1990). Particle deposition in a tube with an abrupt contraction. *Journal of Aerosol Science*, *21*, 29–40.
- Ye, Y., Pui, D. Y. H., Liu, B. Y. H., Opiolka, S., Blumhorst, S., & Fissan, H. (1991a). Thermophoretic effect of particle deposition on a free standing semiconductor wafer in a clean room. *Journal of Aerosol Science*, *22*, 63–72.
- Ye, Y., Tsai, C. J., Pui, D. Y. H., & Lewis, C. (1991b). Particle transmission characteristics of an annular denuder ambient sampling system. *Aerosol Science and Technology*, *14*, 102–111.
- Yeh, H. C., & Liu, B. Y. H. (1973a). Aerosol filtration by fibrous filters—I. Theoretical. *Journal of Aerosol Science*, *5*, 191–204.
- Yeh, H. C., & Liu, B. Y. H. (1973b). Aerosol filtration by fibrous filters—II. Experimental. *Journal of Aerosol Science*, *5*, 205–217.
- Yook, S. J., Fissan, H., Asbach, C., Kim, J. H., Dutcher, D. D., Yan, P. Y., & Pui, D. Y. H. (2007b). Experimental investigations on particle contamination of masks without protective pellicles during vibration or shipping of mask carriers. *IEEE Transactions*, *20*, 578–584.
- Yook, S.-Y., Fissan, H., Asbach, C., Kim, J. H., van der Zwaag, T., Engelke, T., . . . & Pui, D. Y. H. (2007c). Experimental investigations of protection schemes for extreme ultraviolet lithography masks in carrier systems against horizontal aerosol flow. *IEEE Transactions*, *20*, 176–186.
- Yook, S.-J., Fissan, H., Asbach, C., Kim, J. H., Wang, J., Yan, P.-Y., & Pui, D. Y. H. (2007a). Evaluation of protection schemes for extreme ultraviolet lithography (Euvl) masks against top-down aerosol flow. *Aerosol Science*, *38*, 211–227.
- Yook, S. J., Fissan, H., Engelke, T., Asbach, C., Kim, J. H., van der Zwaag, T., . . . & Pui, D. Y. H. (2008b). Controlled deposition of SiO₂ nanoparticles of NIST-traceable particle sizes on mask surface inspection system characterization. *IEEE Transactions on Semiconductor Manufacturing*, *21*, 238–243.

- Yook, S. J., Fissan, H., Engelke, T., Asbach, C., van der Zwaag, T., Kim, J. H., . . . & Pui, D. Y. H. (2008a). Classification of highly monodisperse nanoparticles of NIST-traceable sizes by TDMA and control of deposition spot size on a surface by electrophoresis. *Journal of Aerosol Science*, *39*, 537–548.
- Zhang, R. Y., Khalizov, A. F., Pagels, J., Zhang, D., Xue, H. X., & McMurry, P. H. (2008). Variability in morphology, hygroscopicity, and optical properties of soot aerosols during atmospheric processing. *Proceedings of the National Academy of Sciences, USA*, *105*, 10291–10296.
- Zhang, X., McMurry, P. H., & Hering, S. (1993). Mixing characteristics and water content of submicron aerosols measured in Los Angeles and at the Grand Canyon. *Atmospheric Environment*, *27A*, 1593–1607.
- Zhang, X. Q., Turpin, B. J., McMurry, P. H., Hering, S. V., & Stolzenburg, M. R. (1994). Mie theory evaluation of species contributions to 1990 wintertime visibility reduction in the Grand Canyon. *Journal of the Air and Waste Management Association*, *44*, 153–162.
- Zhang, Z., & Liu, B. Y. H. (1991). Performance of TSI 3760 condensation nuclei counter at reduced pressures and flow rates. *Aerosol Science and Technology*, *15*, 228–238.
- Zhang, Z., & Liu, B. Y. H. (1992). Experimental study of aerosol filtration in the transition flow regime. *Aerosol Science and Technology*, *16*, 227–235.
- Zhang, Z. Q., & Liu, B. Y. H. (1989). On the empirical fitting equations for aspiration coefficients for thin-walled sampling probes. *Journal of Aerosol Science*, *20*, 713–720.
- Zhao, J., Eisele, F. L., Titcombe, M., Kuang, C., & McMurry, P. H. (2010). Chemical ionization mass spectrometric measurements of atmospheric neutral clusters using the cluster-CIMS. *Journal of Geophysical Research*, *115*, D08205.
- Zhao, J., Liu, B. Y. H., & Kuehn, T. H. (1991). The formation of water aerosols during pump-down of vacuum process tools. *Solid State Technology*, *34*, 85–89.
- Ziemann, P. J., Kittelson, D., & McMurry, P. H. (1996). Effects of particle shape and chemical composition on the electron impact charging properties of submicron inorganic particles. *Journal of Aerosol Science*, *27*, 587–606.

- Ziemann, P. J., Liu, P., Kittelson, D. B., & McMurry, P. H. (1995a). Electron impact charging properties of size-selected, submicrometer organic particles. *Journal of Physical Chemistry*, *99*, 5126–5138.
- Ziemann, P. J., Liu, P., Kittelson, D. B., & McMurry, P. H. (1995b). Particle beam mass spectrometry of submicron particles charged to saturation in an electron beam. *Journal of Aerosol Science*, *26*, 745–756.
- Ziemann, P. J., & McMurry, P. H. (1997). Spatial distribution of chemical components in aerosol particles as determined from secondary electron yield measurements: Implications for mechanisms of multicomponent aerosol crystallization. *Journal of Colloid and Interface Science*, *193*, 250–258.
- Ziemann, P. J., & McMurry, P. H. (1998). Secondary electron yield measurements as a means for probing thin organic aerosol particles. *Aerosol Science and Technology*, *28*, 77–90.

PART III

The Legacy of
the Pasadena Smog
Experiment

Reminiscences about Pasadena, ACHEX, and Beyond

George M. Hidy

Introduction

The mid-1960s was a period of transition in the “enabling” technologies for measurement of the properties of atmospheric aerosol particles. Before this time, the characterization of particles depended on a means of preconcentrating particles on substrates such as impactor plates or filters, then using either tedious microscopic examination for physicochemical characterization, including estimation of size distributions, or bulk chemical analysis of solvent-extracted material from the collectors. From such methods, a conceptual picture of airborne particles was reported in the literature and summarized in Junge’s (1963) treatise on air chemistry. About this time, a number of investigators set in motion a major effort to apply modern physical chemistry, fluid dynamics, and meteorology to advancing knowledge about the origins and characteristics of aerosols. After the mid-1960s, four major advances in aerosol measurement technology enabled atmospheric chemists to investigate atmospheric aerosols much more effectively. These enabling technologies included (a) the capability to measure nearly continuously particle size distributions from about 0.05 μm to $\sim 30 \mu\text{m}$ diameter, along with in situ optical properties; (b) mass sampling using efficient size segregation for chemical analysis by particle size increments; (c) reliable microchemical methods to analyze particle collections, not only efficiently from solvent extracts but also directly on collector media; and (d) sufficient determination of chemical composition to account for total mass of particles collected (approximate closure of a particle material balance). Combined with data collection by modern computer, these advances provided the means to rapidly expand the knowledge of the origins and characteristics of atmospheric aerosols.

Paralleling the rapid advance of measurement technologies were major advances in the knowledge about physical and chemical processes affecting aerosol particles. Included in this work was the recognition that a substantial amount of particulate material could be produced from chemical reactions in the atmosphere, followed by formation and growth of particle clouds (Cadle, 1972). Among the illusory phenomena of interest was the dense haze (smog) that accompanied photochemical processes in Southern California air. Scientists established the linkage of the haze with photochemistry in the 1950s, as noted in Leighton's (1961) classic text. But questions remained about the details of the origins and nature of the aerosols in the reactive gemisch.

Given the evolving new measurement techniques, four key investigators, Kenneth Whitby, Sheldon Friedlander, Peter Mueller, and Robert Charlson, combined their interests in August and September 1969 to organize an ad hoc experiment at the Keck Laboratory of the California Institute of Technology in Pasadena to apply these tools to advancing understanding of smog aerosol. Three of these investigators are shown with other interested participants in Figure 1. The Pasadena experiment obtained, for the first time in the presence of pollutant gases, under extreme photochemical oxidant conditions, extensive measurements of semicontinuous particle size distributions with



Figure 1. Three pioneers of the 1969 Pasadena experiment (see italicized names in note) with other participants at the Keck Laboratories, California Institute of Technology.

Note: Front row, left to right: *Kenneth Whitby*, George Hidy, *Sheldon Friedlander*, and *Peter Mueller*. Back row: Dale Lundgren and Josef Pich.

Photo: Courtesy of S. K. Friedlander.

size-fractionated chemical composition. The findings were reported at an American Chemical Society symposium honoring Professor Milton Kerker (Hidy, 1972a).

The Pasadena results were unique as bellwethers for linking reactive gases to aerosol characteristics, including optical properties, and emphasizing the production of particles in a highly reactive urban air environment. Adjunct to the principal thrust of the experiment were side-stream activities, including hourly photographic records of the daily evolution of smog in the Los Angeles Basin; the conceptualization of an aerosol background composed of particles from natural sources, mixed with the presence of particles “aged” in situ for a day or more; and exploratory observations of microscale measures of condensation and ice nuclei believed to be associated with inadvertent weather modification.

The Pasadena experiment was successful in demonstrating that the new measurement and interpretive techniques could vastly improve our knowledge of smog aerosol and its relevance to air quality management practices. This experiment motivated the California Air Resources Board (CARB) to sponsor perhaps the largest, most ambitious urban aerosol project of its time under the name of the California Aerosol Characterization Experiment (ACHEX), beginning in the early 1970s (Hidy et al., 1980). The news of ACHEX concept spread rapidly among a number of investigators. Under the umbrella of the study design, ACHEX drew a crowd of direct participants and interested ad hoc partners, some of whom are shown in the photograph in Figure 2. The Pasadena investigators provided an early intellectual leadership and were joined by scientists from many institutions to complement the earlier sustained work of the Los Angeles Air Pollution Control District.

For its large investment of approximately \$2 million (1970 dollars), CARB felt that the academic community had insufficient management experience to coordinate and move the experiment to completion. The CARB management chose Rockwell International, an aerospace giant and a perceived extraordinary “relatively big-science” management capability, to oversee the project. The heart of the experiment was a large mobile laboratory that provided the capabilities of measuring both reactive gases and particles as a true “aerosol” study (Sem et al., 2011). ACHEX was designed to provide a snapshot of a variety of atmospheric conditions, ranging from the key interest of smog chemistry to locations where one source was assumed to

dominate the aerosol (e.g., motor vehicles, vegetation, desert, and sea spray). The design was flexible enough to permit the successful application of all the knowledge from the 1969 Pasadena experiment, incorporated in a specially designed mobile unit to be moved around California. The ACHEX included ground and complementary aircraft sampling, the first extensive use of a minicomputer system to collect and record both smog containing gases and continuous particle size distribution measurements, credible measurements of liquid water in particles, and a blimp experiment to simulate Lagrangian motion of air masses (following air trajectories) across the Los Angeles Basin. The ACHEX was completed successfully, despite the frustrations of the “disappearance” of smog in the first summer 1972 activity in Southern California. The weather-related absence of smog required that the experiment be continued through the following summer-fall season of 1973.



Figure 2. Participants in the California Aerosol Characterization Experiment in 1977 at the Science Center, Rockwell International, Thousand Oaks, CA.

Note: Front row, left to right: Kenneth Whitby (University of Minnesota), co-principal investigator; Joe Behar (University of California, Riverside), photochemical processes; Sue Twiss (AIHL), data analysis; Sheldon Friedlander (California Institute of Technology [Caltech]), co-principal investigator. Second row: John Seinfeld (Caltech), photochemical modeling; Bob Bryan (Los Angeles County Air Pollution Control District), particle measurements; Peter Mueller (AIHL), co-principal investigator; George Lauer (Rockwell), computer system designer and software developer; Ted Smith (Meteorology Research, Inc.), meteorology; Bob Brattain (Research Advisory Committee, California Air Resources Board [CARB]). Third row: Lee Meyers (Rockwell), computer programming; Jerry Wesolowski (AIHL), laboratory coordinator; Bill Clark (University of Minnesota), field operations manager; Rudy Husar (Caltech), data analyst; Dale Hutchinson (CARB); Don Blumenthal (MRI), aircraft program manager. Fourth row: George Hidy (Rockwell), co-principal investigator; Tom Cahill (University of California, Davis), elemental analysis; H. Samuel (CARB); Tiche Novakov (Lawrence Berkeley Laboratory), special particle analyses; Bob Lamb (Caltech), photochemical modeling; Terry Loucks (Rockwell).

Photo: Courtesy of the author.

The combination of the results from the 1969 experiment and the ACHEX demonstrated a major advance in particle measurement techniques and interpretation of pollution aerosol data that laid the foundations for major changes in insight about particulate matter in relation to US Clean Air Act regulations, as well as California's particulate and visibility standard. The experiments also provided the framework for future major field experiments designed and executed to study lower tropospheric aerosols on a variety of spatial and temporal scales. Among the important results that have set the stage for contemporary measurements are the capabilities for size distribution measurements over more than two orders of magnitude of particle diameter (Whitby, Liu, et al., 1972), linked with the light scattering properties of the distributions (Ensor et al., 1972). Investigators explored the chemical composition in detail, not only for daily averages but also for three hourly averages, using elemental analysis by then-modern microchemical methods of X-ray fluorescence and neutron activation, water soluble ions by ion chromatography (Appel et al., 1980), and noncarbonate carbon determinations (Mueller et al., 1972). The interpretation of the results established a clear link with photochemical processes and air chemistry, characterized common particle sources, and pointed toward the multimodal particle volume-size distributions in the light of dynamic processes, the importance of secondary organic carbon in smog aerosols, and the greatly improved methodology of chemical mass balance as a receptor model (Gartrell et al., 1980; Miller et al., 1972).

An earlier article (Hidy, 2000) describes the evolution of the Pasadena experiment and the ACHEX concept. The details of the experimental results are given in Hidy (1972a), in the compendium of Hidy and colleagues (1980), and in the project reports (Hidy et al., 1975a–d), which are archived in the CARB library, Sacramento, California, and the Desert Research Institute library, Reno, Nevada. In this chapter, I offer a brief perspective of key results from the Pasadena experiment, whose applications have created the basis for major advances in tropospheric aerosol science.

Changing the 1960s Atmospheric Aerosol World

Prior to the late 1960s, scientists derived a sense of aerosol chemistry in US urban areas from basic air monitoring by the National Air Sampling Network (NASN) (Cadle, 1973). The basic knowledge of sources of airborne particles was relatively rudimentary, based on a few sampling campaigns and

laboratory studies. Much of the knowledge about smog aerosols was inferred from casual observations of the haze over Los Angeles, in combination with smog chamber studies at the University of California, Riverside, and the Stanford Research Institute (Cadle, 1972).

With the conception of the Pasadena experiment, an opportunity arose to apply new methods to characterizing smog aerosols in a location known to be heavily impacted by high concentrations of O₃, the historic indicator for photochemical air pollution, still used today. The results of the Pasadena experiment not only led to the ACHEX but added key knowledge in four important areas: (a) the semicontinuous measurement of particle size distributions in smog, (b) the demonstration of chemical composition as a function of particle size and the expansion of chemical understanding through analytical methods using modern microchemistry, (c) the nature of light scattering and visibility changes in smoggy conditions, and (d) the refinement of hypotheses about the origins and nature of aerosols.

Particle Size Distributions

Until Whitby and his colleagues at the University of Minnesota developed the electrical mobility–optical counter system analyzer (the Minnesota Aerosol Analysis System, or MAAS), the knowledge of the particle size distribution of airborne particles in urban and rural environments was rudimentary. As noted earlier, researchers obtained quantitative size distributions by microscopic counting. The number-diameter (D_p) distributions were found to have a power law form proportional to D_p^{-4} for the size fraction larger than about 0.5 μm , tailing away from a peak in the 0.05–0.1 μm diameter range. The power law was consistent with the Angstrom model for particle size and light scattering and had some theoretical foundations relating to the dynamics of the distribution function (Friedlander, 2000; Junge, 1963). The third moment of the number-size distribution as reported by Junge has an extended range of constant volume in the 0.1–4 μm range, based on the power law fit. (Note, however, that Junge's results offered a hint of bimodal distribution, as shown in Figure 24 of his [1963] book.)

The measurements taken with the Minnesota instrumentation, combined with other early observations, gave the first indications of the now-famous bimodal and multimodal volume- or mass-size distributions. Some of the data synthesized in the 1960s are shown in Figure 3. Here the bimodal nature of the volume- or mass-size distribution begins to appear, with the

minimum in the distribution about 1 μm diameter. Furthermore, the results of the experiment indicated that the mode of the aerodynamic size range between 0.1 and ~ 1.0 μm does not grow into large particles. Note that the 1969 Pasadena observations gave an incomplete picture of the bimodal size distribution in that the data were limited to values less than 10 μm diameter. Later in the refinements of the analyzer, with resolution for larger particles, the ACHEX confirmed the picture of the mode in the large particle fraction for smog aerosols. For those in the field, the multimodal characteristic of tropospheric aerosol distributions has become well known. It has been of major importance, along with knowledge of lung deposition, in consideration of the US ambient air quality standards for particulate matter (US Environmental Protection Agency [EPA], 1996).

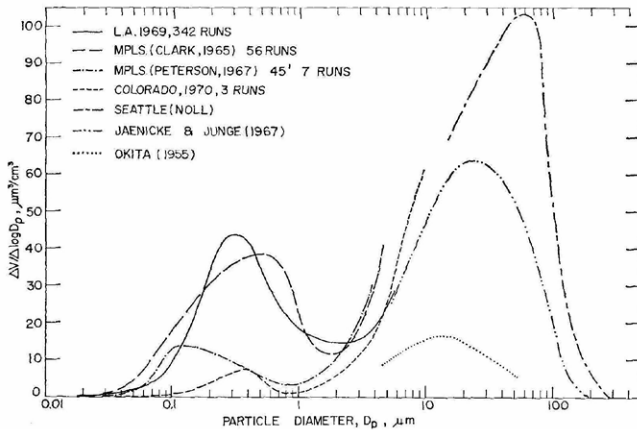

Figure 3. Volume-particle diameter distributions reported by several investigators.

Note: The average result for Pasadena during the 1969 experiment using the Minnesota Aerosol Analysis System is included. These data were a foundation for the hypothesis of a bimodal volume- and mass-size distribution for particles larger than ~ 0.05 μm in diameter.

Source: Whitby, Husar, et al. (1972). Reprinted with permission from Elsevier.

Beyond simply the beginnings of circumstantial evidence for the bimodal distribution, the continuous data from the Pasadena experiment indicated that the diurnal change in the volume-size distribution reflected the rapid morning growth of particles in the 0.1–1.0 μm range over a few hours' time (e.g., Figure 4), peaking roughly at midday with the maximum in solar radiation. As noted earlier, growth in the volume distribution evidently did not shift the diameter of this size range appreciably, unlike expectations

in a coagulation-dominated regime. Calculations of Husar and others (1972) indicated that the rapid accumulation of volume (or mass) in the submicrometer range of particle diameter could be interpreted in terms of vapor condensation theory. These calculations illustrated well the hypothesis that the photochemical smog found in Southern California produced large quantities of condensable material, which were identified with sulfuric acid and high-molecular-weight volatile organic carbon.

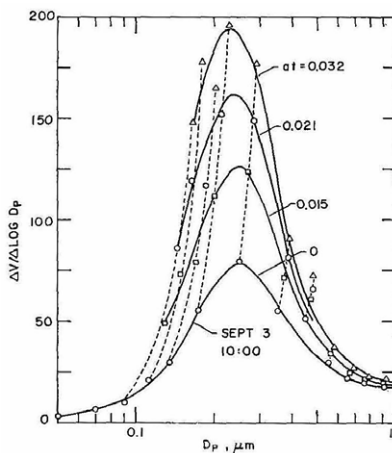

Figure 4. Calculated growth rate assuming vapor diffusion limited transfer to existing submicrometer particles in the 1969 Pasadena observations, beginning in the morning and followed into the midday.

Note: The figure uses a time scale defined as the product αI , where t is time, and α is a coefficient dependent on vapor supersaturation and diffusivity of an unknown condensable species in smog (later hypothesized to be sulfuric acid or organic compounds). The growth estimates are consistent with observations that the volume (proportional to mass) increased in the smog aerosol dramatically with time, but the median diameter of this mode changed little.

Source: Husar et al. (1972). Reprinted with permission from Elsevier.

The work of Husar and others (1972), along with other results, identified the regime between $0.1 \mu\text{m}$ and roughly $1 \mu\text{m}$ diameter as the accumulation mode. This region of the volume-size distribution is dynamically influenced by slow removal and slow coagulation processes, which create a “flow” of particles to larger sizes and ultimately removal by sedimentation or scavenging. Accumulation also is fostered by mass accrual from condensation or reactions of vapors with existing particles and is subject to flow of very small particles from the $<0.1 \mu\text{m}$ range from condensation, reactions, or new particle formation. The regime of particle size less than about $0.05 \mu\text{m}$, classically called the *Aitken particle regime* ($\leq 0.1 \mu\text{m}$) and now called the *ultrafine or nanoparticle particle regime*, has been recognized for many years (Junge, 1963; Mohnen & Hidy, 2011). This regime is currently a subject of extensive study using a variety of instrumentation.

A unique, dimensionless scaling of the number-size distribution in terms of the particle cumulative volume and number reflecting the power law ranges within the distribution has largely been abandoned in aerosol dynamics in recent years. However, this aspect of particle dynamics, reflecting physical processes of sedimentation, coagulation, and growth, remains an important component of tropospheric aerosol aging and evolution (Hidy, 1972b).

The linkage between particle light scattering and size distributions has been of interest to atmospheric scientists for many years, quite apart from issues of air pollution. However, in the 1960s an integral form of measurement of light scattering showed promise as an alternative to a filter-based gravimetric measure of mass concentration. Scientists accomplished the measurement with a simple instrument called an *integrating nephelometer*.

The Pasadena experiment offered an opportunity to investigate the integrating nephelometric determination of the light scattering coefficient as a function of particle size measured by the University of Minnesota group. The experiment also afforded an opportunity to examine the scattering coefficient as a function of different light wavelengths using instrumentation supplied by the University of Washington (Ensor et al., 1972; Ensor & Covert, 2006).

The Pasadena investigators combined the particle size distribution data with the smog light scattering as a function of size using a Mie scattering model with an index of refraction of 1.50 (Figure 5). They found strong scattering in the 0.1–1 μm diameter range using all four wavelengths (noted in Figure 5) from the integrating nephelometer. The strongest scattering occurred at the 365 nm and 436 nm wavelengths. The results obtained in this part of the experiment showed an expected consistency between the MAAS and the light scattering observations over a wide range of particle concentration and calculation parameters. The results basically provided a verification of Mie theory for polydisperse aerosol particles in reactive chemical conditions and a consistency test between the MAAS and the nephelometer. Complementary calculations of the relative contributions of haze and nitrogen dioxide to the optical extinction coefficient suggested that NO_2 was a significant factor about 20% of the time for the conditions found in the 1960s photochemical haze in Los Angeles (Charlson et al., 1972).

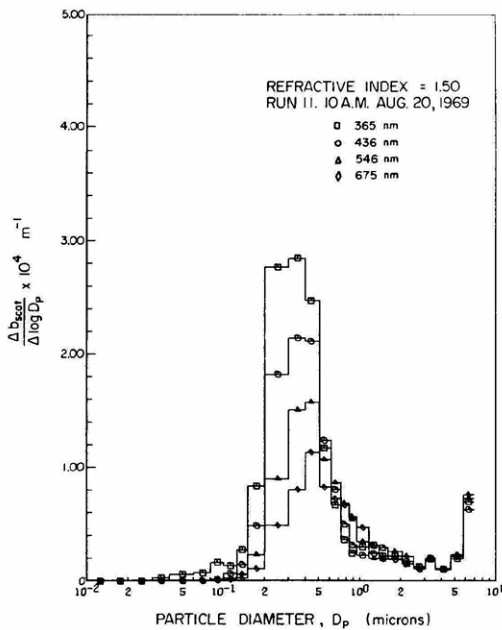

Figure 5. Light scattering coefficient as a function of particle diameter using multi-(light) wave length integrating nephelometer data and Mie scattering theory for an index of refraction of 1.5 (range 1.4–1.6).

Source: Ensor et al. (1972). Reprinted with permission from Elsevier.

Chemical Characterization

Determination of the chemical composition of the smog aerosol also was an important goal of the Pasadena experiment. From the knowledge of the diurnal nature of the size distribution, it was obvious that there was a need to determine in detail the chemistry by particle size on an hourly basis. These results depended on the use of the Lundgren impactor (Lundgren, 1971) for sampling as a function of particle size and a time resolution of about 4 hours during daylight periods.

The Pasadena investigators conducted analyses for the water-soluble anion fraction and for elemental concentrations by different methods, including atomic absorption, neutron activation, and X-ray fluorescence. The application of X-ray fluorescence analyses for elements has evolved into a “standard” for filter-based particulate analyses in contemporary air monitoring. The reported data were of interest in characterizing the size fractions of inorganic species and the diurnal changes in elemental or water-soluble species concentrations. These data form a unique collection representing conditions in the smog aerosol as a composite average when the maximum hourly ozone concentration is ~170 ppbv, with maxima of ~270 ppbv, a level of smog rarely seen in the United States today.

In addition to the basic chemical data obtained in the Pasadena study, and the intercomparison between methods for determining elements, the study explored two unique and forward-looking methods. The first was determination of carbonate and noncarbonate carbon by particle size by conversion to CO₂ measured with a flame ionization detector, and the second was the use of photoelectron spectroscopy to investigate species in terms of valence state as a function of time of day.

Table 1 presents an example of the carbon data. These data represent perhaps the first attempt to determine noncarbonate and carbonate carbon in urban aerosol particles. The results indicate that, for the Los Angeles particle distribution, little carbonate carbon was found in the sample, and the noncarbonate fraction was mainly found in the submicrometer fractions. This finding is consistent with attribution to combustion processes, including motor vehicle exhaust. The data provided an important alternative to the previous methods for carbon assessment, which relied on solvent extraction techniques and generally failed to account for more than a small fraction of total carbon present. These data also provided a means for approximately closing the particle mass balance by chemical composition (Miller et al., 1972), because noncarbonate carbon is an important fraction of airborne particles.

Table 1. Noncarbonate and carbonate components of the Pasadena aerosol by size fraction <30 μm aerodynamic diameter, obtained with a Lundgren impactor on September 3, 1969, between 0900 and 2000 hours

Particle Size (μm)	Impactor Stage	$\mu\text{gC}/\text{m}^3$ as		Total Particles $\mu\text{g}/\text{m}^3$	Percent C of Total Mass as	
		CO ₃ =	Non-CO ₃ =		CO ₃ =	Non-CO ₃ =
17-30	1	<0.02	<0.02	4.6	<0.5	<0.5
5-17	2	<0.02	<0.02	5.7	<0.4	<0.4
2-5	3	<0.02	0.17	12.5	<0.2	1.4
0.6-2	4	<0.02	2.05	20.3	<0.1	10.1
0.1-0.6	5	<0.02	19.8	72.8	<0.03	27.3

Source: Mueller et al. (1972). Reprinted with permission from Elsevier.

Novakov and colleagues (1972) obtained data from electron spectroscopy for chemical analysis (ESCA), now known as *X-ray photoelectron spectroscopy* (XPS). These data offered important insight into the nature of the nitrogen and sulfur fractions of the Pasadena aerosol by particle size and time of day.

The sulfur data indicated that the sulfite S present in the 0.6–2 μm diameter fraction was similar to, or larger than, the sulfate component. In the 2–5 μm range, sulfite concentrations tended to be somewhat larger than sulfate. Sulfur present in smog is assigned to secondary origins or from the atmospheric oxidation of sulfur dioxide. The oxidation process is believed to pass through particulate sulfite before oxidation to sulfate in some mechanisms, especially oxidation in aqueous conditions. The substantial presence of sulfite in the Pasadena samples hinted at an oxidation process involving wet haze particles in smog but did not preclude gas-phase oxidation in the presence of water vapor, and subsequent condensation as sulfuric acid, rapidly converting ammonium sulfate with ammonia.

Table 2 presents the results for the nitrogen component in the Pasadena aerosol. Novakov and colleagues found three valence states in the samples, including nitrate, ammonium, amino-N, and pyridino-N. These compounds were all hypothesized to be of secondary origin from atmospheric chemical reactions, and from absorption by strongly acid particles in the case of ammonium (and perhaps amino- and pyridine- compounds). Nitrate is commonly believed to derive from nitric acid present in smog, but the origins of amino- and pyridino- compounds are unclear and have not been followed up from the ESCA observations. The surprisingly large amounts of amino and pyridine material found in the morning to midday in the submicrometer fraction along with ammonium (found in agricultural emissions in Los Angeles) raise questions about their origins. It is also intriguing that the nitrate was found in the larger particles with ammonium, but much of the amino- and pyridino- fraction appeared in the submicrometer fraction. Typically ammonium nitrate is believed to form mainly in the submicrometer particle regime. Displacement of chloride from sea salt reaction with HNO_3 was likely taking place in the larger particles, forming NaNO_3 .

The characterization of particle species by valence state remains largely unexplored, even to this day. However, it appears that this direction of experimentation offers the potential for adding important knowledge about the origins and chemistry of N and S compounds that has not been exploited. This approach also might be used to investigate potentially toxic materials in particles, which is very much on the forefront of today's rationale for regulation of particulate matter.

Table 2. Chemical states of nitrogen in airborne particles by size fraction (μm) from samples obtained in Pasadena, California, in 1969

Chemical State and Size Class in μm								
Time Period (hrs)	Nitrate-N ($\mu\text{g}/\text{m}^3$)		Ammonium-N ($\mu\text{g}/\text{m}^3$)		Amino-N ($\mu\text{g}/\text{m}^3$)		Pyridino-N ($\mu\text{g}/\text{m}^3$)	
	0.6-2	2-5	0.6-2	2-5	0.6-2	2-5	0.6-2	2-5
September 3								
0900-1300	None	0.04	0.98	0.03	2.78	0.06	4.60	0.10
1300-1700	None	0.12	0.06	0.12	0.12	0.27	0.08	0.41
2000-2400	None	0.15	0.05	0.05	0.19	0.10	0.16	0.19
September 4								
0000-0400	None	0.03	0.08	0.01	0.48	0.02	0.34	0.05
0400-0800	None	0.07	0.64	0.04	3.85	0.08	3.08	0.1
1000-1400	None	0.43	1.25	0.57	2.37	0.98	3.63	1.58

Source: Novakov et al. (1972). Reprinted with permission from Elsevier.

Chemical Mass Balance

An important practical consideration for the basic chemistry of aerosol particles ensures that the principal species contributing to particle chemical composition are identified. This concept implies that the chemicals identified should add up to the mass determined by independent means. The Pasadena data provided for the first time the means of approximately closing the cumulative chemical base for a particle mass balance. The results indicated that sulfate and noncarbonate carbon were major fractions of the smog particles, along with motor vehicle exhaust as traced by lead from gasoline; soil dust also was an important component, based on Si or other light elements found in crustal (soil) material (Miller et al., 1972).

The chemical mass balance (CMB) method also relates to the sources of chemical components in particles. The chemistry of source particles should be identifiable from components of the ambient aerosol, as suggested by Hidy and Friedlander (1970). Subsequently, Miller and colleagues (1972) improved the concept of CMB and source profiling, at least for soil dust, sea salt, and motor vehicle emissions. Table 3 provides an example of their results, which used the Pasadena data. The results from the Pasadena sampling in smog are surprisingly similar to a much cruder calculation done earlier by two of the authors. The Pasadena results did not include sulfate and nitrate, as reported earlier from the NASN data. If the sulfate and nitrate data are included in the

Miller results, most of the mass of sampled particles in smog can be accounted for. These results, of course, did not consider the volatility of the nitrate fraction, which subsequently has been well established, or filter sampling artifacts, which were yet to be uncovered. The results also did not account for condensed water, which was later found to be important in the particle mass balance. Thus, even though the Miller analysis refined earlier work based on new data, it remained a qualitative source apportionment relative to the limitations resulting from subsequent knowledge of a variety of uncertainties in particle sampling (McMurry et al., 2004).

The CMB method and the alternatives of factor analyses have evolved into a formal method of semiquantitatively identifying sources of airborne particles known as *receptor modeling*. The methods are used widely in developing air quality management plans for particulate matter in urban areas across the world. The receptor-based methods are suitable mainly for identifying sources of primary particles but are less useful for assigning sources of (secondary) particles from atmospheric chemical reactions (McMurry et al., 2004).

Table 3. Estimates of the percentage contribution of some sources to aerosol samples in the Los Angeles area, based on chemical mass balance considerations

Source	Miller et al. (1972)	Hidy and Friedlander (1970)
Sea salt particles	2.5	5
Soil dust	9.8	6.8–16.8
Primary automobile emissions	8.2	12.5
Fuel oil fly ash	0.24	4.2
Sulfate ^{a,b}	(55) ^e	12.1
Nitrate ^{a,b}	—	11.3
Carbon (noncarbonate) ^{a,b,c}	17	—
Iron oxide (Fe ₂ O ₃) ^{a,d}	4.5	—

^a Based on data from the Pasadena experiment (see Miller et al., 1972), Table V.

^b Species generated mainly from reactions of gas-phase precursors.

^c Corrected for approximately 2% carbon originating in primary automobile emissions. Hence this figure includes aircraft emissions, secondary formation, and natural contributions.

^d Iron oxide arising from anthropogenic sources.

^e Estimated from Novakov et al. (1972), assuming that all of the sulfite is oxidized to sulfate and extrapolated to 24-hour average, and the sulfur compounds determined by photoelectron spectroscopy are representative of the elemental analysis reported for all samples in Pasadena (not included in Miller et al., 1972).

Source: Adapted from Miller et al. (1972).

Hypotheses about Particle Formation

The Pasadena results led to a major hypothesis that the smog haze was dominated by atmospheric production of fine particles, whose composition appeared to be strongly influenced by airborne sulfate, either as sulfuric acid or perhaps ammonium salts, and possibly organic carbon as a part of the noncarbonate carbon observed. In addition, the daily evolution of the size distribution indicated a coupling with oxidant production in the aerosol. The growth of existing particles through vapor condensation in the accumulation size range was a feature seen in the extinction coefficient measurements increasingly affecting visibility impairment during the day. These results provided a central theme, confirming earlier studies, that led to the major elements of the ACHEX concept.

The California Aerosol Characterization Experiment (ca. 1971–1973)

The results of the Pasadena experiment in 1969 provided an intriguing collection of knowledge describing photochemical aerosols. The methods adopted from application of new instrumentation and analytical chemistry proved their value for a means of adding considerable new insight about aerosols in different atmospheric conditions. The design of intensive campaigns to efficiently characterize aerometric conditions in polluted air emerged as a methodology adopted by many investigators. With the tools at hand in the late 1960s, the stage was set for the ACHEX study of ambient aerosols, not only in a photochemical regime but for conditions representing different source environment and different atmospheric conditions.

The “community” of the Pasadena experiment responded to a request for proposals from CARB in 1971 with the ACHEX concept to elaborate and enrich the finding characterizing the visibility-reducing elements of photochemical smog. The ACHEX investigators envisaged experiments not only in Southern California but in the San Francisco Bay area, in the San Joaquin Valley, in source-dominated environments near heavy traffic, and in natural marine, desert, and Mediterranean-like vegetation conditions (Hidy et al., 1980). The observations were to be taken using a large mobile laboratory whose core design relied on an expanded MAAS for continuous size distribution measurements (Sem et al., 2011). The ACHEX investigators carefully designed the laboratory sampling system for reactive gases and for collection of (impactor) size-differentiated particles (Lundgren, 1971). The system design also facilitated the systematic microchemical analyses

of particle samples taken day and night. This diurnal separation was key to characterizing the daytime build-up of smog aerosol. Because California has a visibility standard, the visibility component was important, so the investigators included measurement of the light extinction coefficient, along with human observations of visual range. As noted by Hidy and colleagues (1980), the study included a number of ancillary experiments, perhaps most important of which was the aircraft over-flight program to obtain vertical distributions (Blumenthal, 2011; Blumenthal et al., 1973, 1977; Husar et al., 1977).

In addition to the measurement elements designed into the ACHEX, the large body of data collected during this study required a major computerized data management effort, as well as a major commitment to quality control and assurance of the data. This study was the first time a minicomputer was adopted for acquiring and reporting gas and particle data in field operations. This modern “data management” in the air quality context came into acceptance and assisted in the efficiency of quality control and assurance of the data set.

The investigators acquired the measurements on a planned logistical schedule and coordinated them with the aircraft sampling and a number of other experiments, in cooperation with the ACHEX investigations. As is often typical of conditions in short-term field campaigns, the initial summer ACHEX sampling encountered unusually clean air conditions across California, including Southern California. Thus the principal goal of the study, to refine the characterization of photochemical smog aerosols, was unfulfilled. In addition to all of the experimental logistics, an effort on the part of the investigators, especially Peter Mueller, was needed to successfully convince CARB to extend the study via curtailing operations at the outlying sites and providing additional funding to enable a return to the Los Angeles area for a second summer.

The advanced technologies deployed in the ACHEX, which were well beyond the capabilities of conventional air monitoring, proved that intensive campaigns sustained over a longer period than a few days could provide valuable insights about ambient aerosols. Even over relatively short periods of sampling, data could be obtained for a variety of source and chemical conditions relevant to air quality management. The collection of data (a) provided major improvements in sampling and analytical chemistry techniques for ambient aerosols, (b) created a data set of literally thousands

of particle size distributions showing the relatively uniform nature of surface and volume-size distributions, (c) confirmed hypotheses about smog aerosol chemistry in relation to natural and anthropogenic particle sources, and (d) advanced an understanding of the nature of visibility impairment in urban and rural haze conditions in California.

Important concepts about ambient aerosols came out of the ACHEX that followed the hypotheses and speculation from the 1969 Pasadena experiment. Important inferences, which influenced many subsequent investigations, included the following:

- Verification of the multimodal nature of ambient surface and volume-size distributions for airborne particles and the identification of dynamic regimes that influence these distributions, including volume accumulation from secondary condensable material production in the submicrometer diameter range, the strong decline in coarse particle concentrations during aerosol aging, and the presence of ultrafine particles, especially near combustion sources
- Documentation of an overwhelming importance of secondary formation and growth of particles in the smog environment, particularly sulfate, nitrate, and probably (organic) carbon, which interact with precursors and oxidants from photochemical processes
- Demonstration from direct measurements of the significance of liquid water content in particles, which strongly influence both mass concentration of suspended particles and the extinction coefficient, leading in turn to visibility impairment much greater than expected from dry aerosols
- Demonstration of the importance of air chemistry on different spatial and temporal scales within and downwind of large urban particle sources, including the persistent vertical structure of the pollutant dispersal in the sea-land breeze environment of Southern California, and the nature of combined mesoscale, “chemical aging,” and pollution transport, which affect highly rural regions far downwind of major urban sources

Pasadena to ACHEX and Beyond

Retrospectively, the timing of the Pasadena experiment produced a major change in the outlook for investigating ambient aerosols. This change was defined in terms of the intellectual combination of its leaders and the application of several new measurement technologies that reached the science community. The momentum of the 1969 work that carried into the ACHEX provided a major collection of results, including instrument development and integration of methods and investigators, to achieve a collective, highly refined picture of aerosols' origins and evolution in the lowest parts of the troposphere. These results survive as a driving force of today's research agenda (Solomon et al., 2008). The California experiments provided the foundations for a large number of contemporary atmospheric aerosols studies based on intensive campaigns, perhaps including refinement in the most recent "supersite" experiments sponsored by EPA some 20 years later.

Knowledge about the spectrum of aerosol chemistry, both in terms of the particles themselves and the reactive gases surrounding them, has advanced greatly since the Pasadena experiment. However, many of the basic ideas prevail today that describe the importance of different sources to aerosol dynamics. Sources of interest range from natural occurrences to anthropogenic emissions, such as those from motor vehicles, electric power generation, or large industrial operations. The link of gas emissions to secondary products provides the structure for the modern descriptions of smog aerosol. Of course, the California investigators were unaware of later refinements, ranging from chemical characterization of the ultrafine (nanoparticle) fraction to the subtleties of sampling of stable condensed material to semivolatile material, including ammonium nitrate, certain organic species, and water. The investigators had some knowledge of the enormous variety of organic species to be found in ambient particles but did not know much about the chemistry of secondary organic species or the potential importance of natural volatile organic compounds in these processes.

The near-term future for contemporary research in ambient aerosols probably will continue focusing on the carbon component and on the dynamics of spatial and temporal processes affecting haze on local to regional scales. Much of today's research will continue to be driven by air quality issues influencing human and ecological health and by large spatial scale issues of aerosol perturbations in climate forcing. Thanks in major part to the motivations from the Pasadena experiment and the ACHEX, the complexity

and richness of contemporary urban and rural aerosol chemistry obtained a jump start leading from the 1970s into the 21st century.

References

- Appel, B., Kothny, E., Hoffer, E., & Wesolowski, J. (1980). Sulfate and nitrate data from the California Aerosol Characterization Experiment (ACHEX). In G. M. Hidy, P. K. Mueller, D. Grosjean, B. R. Appel, & J. J. Wesolowski (Eds.), *The character and origins of smog aerosols* (pp. 315–336). New York, NY: Wiley Interscience.
- Blumenthal, D. L. (2011). Measurements of the three-dimensional distribution and transport of aerosols. Precedents set by the Three-Dimensional Pollutant Gradient Study in cooperation with ACHEX. In David S. Ensor (Ed.), *Aerosol Science and Technology: History and Reviews* (Chapter 10). Research Triangle Park, NC: RTI Press.
- Blumenthal, D. L., Smith, T. B., & White, W. H. (1973). The evolution of the 3-D distribution of air pollutants during a Los Angeles smog episode: July 24–26, 1973. In G. M. Hidy, P. K. Mueller, D. Grosjean, B. R. Appel, & J. J. Wesolowski (Eds.), *The character and origins of smog aerosols* (pp. 613–650). New York, NY: Wiley Interscience.
- Blumenthal, D. L., White, S. H., & Smith, T. B. (1977). Anatomy of a Los Angeles smog episode: Pollutant transport in the daytime sea breeze regime. *Atmospheric Environment*, 12, 893–907.
- Cadle, R. D. (1972). Formation and chemical reactions of atmospheric particles. In G. M. Hidy (Ed.), *Aerosols and atmospheric chemistry* (pp. 141–147). New York, NY: Academic Press.
- Cadle, R. D. (1973). Particulate matter in the lower atmosphere. In S. I. Rasool (Ed.), *Chemistry of the lower atmosphere* (pp. 69–117). New York, NY: Plenum Press.
- Charlson, R. J., Covert, D. S., Tokiwa, Y., & Mueller, P. K. (1972). Multiwavelength nephelometer measurements in Los Angeles smog aerosol. III. Comparison to light extinction by NO₂. In G. M. Hidy (Ed.), *Aerosols and atmospheric chemistry, Part III: The 1969 Pasadena Smog Aerosol Experiment* (pp. 333–338). New York, NY: Academic Press.

- Ensor, D. S., Charlson, R. J., Ahlquist, N. C., & Whitby, K. T. (1972). Multiwavelength nephelometer measurements in Los Angeles smog aerosol. I. Comparison of calculated and measured light scattering. In G. M. Hidy (Ed.), *Aerosols and atmospheric chemistry, Part III: The 1969 Pasadena Smog Aerosol Experiment* (pp. 315–323). New York, NY: Academic Press.
- Ensor, D. S., & Covert, D. S. (2006, September). *Integrating nephelometer: Coming of age*. Paper presented at the Third Symposium on the History of Aerosols, St. Paul, MN.
- Friedlander, S. K. (2000). *Smoke, dust, and haze: Fundamentals of aerosol dynamics* (2nd ed.). New York, NY: Oxford University Press.
- Gartrell, G., Jr., Heisler, S. L., & Friedlander, S. K. (1980). Relating particulate properties to sources: The results of the California Aerosol Characterization Experiment. In G. M. Hidy, P. K. Mueller, D. Grosjean, B. R. Appel, & J. J. Wesolowski (Eds.), *The character and origins of smog aerosols* (pp. 665–713). New York, NY: Wiley Interscience.
- Hidy, G. M. (Ed.). (1972a). *Aerosols and atmospheric chemistry, Part III: The 1969 Pasadena Smog Aerosol Experiment*. New York, NY: Academic Press.
- Hidy, G. M. (1972b). Dynamics of aerosols in the lower troposphere. In T. Mercer, P. Morrow, & W. Stober (Eds.), *Assessment of airborne particles* (pp. 81–115). Springfield, IL: Charles C. Thomas.
- Hidy, G. M. (2000). Characterizing atmospheric aerosols in California. In O. Preining & E. J. Davis (Eds.), *History of aerosol science* (pp. 89–116). Vienna: Verlag der Osterreichischen Akademie der Wissenschaften.
- Hidy, G. M., et al. (1975a). *Characterization of aerosols in California, Vol. I. Summary. Final report* (Contract No. 358, NTIS No. PB-271733). Thousand Oaks, CA: Science Center, Rockwell International.
- Hidy, G. M., et al. (1975b). *Characterization of aerosols in California, Vol. II. Experimental methods and analytical techniques. Summary. Final report* (Contract No. 358, NTIS No. PB-248799). Thousand Oaks, CA: Science Center, Rockwell International.
- Hidy, G. M., et al. (1975c). *Characterization of aerosols in California, Vol. III (Parts 1 and 2). Observational data. Final report* (Contract No. 358, NTIS No. PB-265714 and PB-266613). Thousand Oaks, CA: Science Center, Rockwell International.

- Hidy, G. M., et al. (1975d). *Characterization of aerosols in California, Vol. IV. Analysis and interpretation of data. Final report* (Contract No. 358, NTIS No. PB-247947). Thousand Oaks, CA: Science Center, Rockwell International.
- Hidy, G. M., & Friedlander, S. K. (1970). The nature of the Los Angeles aerosol. In H. England (Ed.), *Proceedings of the Second IUAPPA Clean Air Congress*. New York, NY: Academic Press.
- Hidy, G. M., Mueller, P. K., Grosjean, D., Appel, B. R., & Wesolowski, J. J. (Eds.). (1980). *The character and origins of smog aerosols*. New York, NY: Wiley Interscience.
- Husar, R. B., Patterson, D. E., Blumenthal, D. L., White, W. H., & Smith, T. B. (1977). Three-dimensional distribution of air pollutants. *Journal of Applied Meteorology*, 16, 1089–1096.
- Husar, R. B., Whitby, K. T., & Liu, B. Y. H. (1972). Physical mechanisms governing the dynamics of Los Angeles smog. In G. M. Hidy (Ed.), *Aerosols and atmospheric chemistry, Part III: The 1969 Pasadena Smog Aerosol Experiment* (pp. 271–284). New York, NY: Academic Press.
- Junge, C. E. (1963). *Air chemistry and radioactivity*. New York, NY: Academic Press.
- Leighton, P. A. (1961). *Photochemistry of air pollution*. New York, NY: Academic Press.
- Lundgren, D. A. (1971). Determination of particulate composition, concentration and size distribution change with time. *Atmospheric Environment*, 5, 645–651.
- McMurry, P., Shepherd, M., & Vickery, J. (Eds.). (2004). *Particulate matter science for policy makers: A NARSTO assessment*. Cambridge: Cambridge University Press.
- Miller, M. S., Friedlander, S. K., & Hidy, G. M. (1972). A chemical element balance for the Pasadena aerosol. In G. M. Hidy (Ed.), *Aerosols and atmospheric chemistry, Part III: The 1969 Pasadena Smog Aerosol Experiment* (pp. 301–331). New York, NY: Academic Press.
- Mohnen, V., & Hidy, G. M. (2011). Atmospheric nanoparticles: Early metrology and observations (1875–1980). In David S. Ensor (Ed.), *Aerosol Science and Technology: History and Reviews* (Chapter 16). Research Triangle Park, NC: RTI Press.

- Mueller, P. K., Moseley, R. W., & Pierce, L. B. (1972). Chemical composition of Pasadena aerosol by particle size and time of day. IV. Carbonate and non-carbonate carbon content. In G. M. Hidy (Ed.), *Aerosols and atmospheric chemistry, Part III: The 1969 Pasadena Smog Aerosol Experiment* (pp. 295–299). New York, NY: Academic Press.
- Novakov, T., Mueller, P. K., Alcocer, A. E., & Otvos, J. W. (1972). Chemical composition of Pasadena aerosol by particle size and time of day. III. Chemical states of nitrogen and sulfur by photoelectron spectroscopy. In G. M. Hidy (Ed.), *Aerosols and atmospheric chemistry, Part III: The 1969 Pasadena Smog Aerosol Experiment* (pp. 285–294). New York, NY: Academic Press.
- Sem, G. J., Clark, W. E., Sverdrup, G. M., & Marple, V. A. (2011). Memories and legacy of the ACHEX Mobile Semitrailer Air Pollution Laboratory. In David S. Ensor (Ed.), *Aerosol Science and Technology: History and Reviews* (Chapter 9). Research Triangle Park, NC: RTI Press.
- Solomon, P., Hopke, P., & Froines, J. (2008). Key scientific and policy- and health-relevant insights from the US Environmental Protection Agency's Particulate Matter Supersites Program and related studies: An integration and synthesis of results. *Journal of the Air & Waste Management Association*, 58, S3–S92.
- US Environmental Protection Agency. (1996). *Air quality criteria for particulate matter* (EPA/600/P-95/001aF, Vol. I). Research Triangle Park, NC: US Environmental Protection Agency, Office of Research and Development.
- Whitby, K. T., Husar, R. B., & Liu, B. Y. H. (1972). The aerosol size distribution of Los Angeles smog. In G. M. Hidy (Ed.), *Aerosols and atmospheric chemistry, Part III: The 1969 Pasadena Smog Aerosol Experiment* (pp. 237–264). New York, NY: Academic Press.
- Whitby, K. T., Liu, B. Y. H., Husar, R. B., & Barrsic, N. J. (1972). The Minnesota aerosol-analyzing system used in the Los Angeles Smog Project. In G. M. Hidy (Ed.), *Aerosols and atmospheric chemistry, Part III: The 1969 Pasadena Smog Aerosol Experiment* (pp. 189–217). New York, NY: Academic Press.

Memories and Legacy of the ACHEX Mobile Semitrailer Air Pollution Laboratory

Gilmore J. Sem, William E. Clark, George M. Sverdrup,
and Virgil A. Marple

The 1969 Pasadena Smog Aerosol Experiment

As described by Peter K. Mueller (2006), this story began sometime during 1966–1968 when he and Kenneth T. Whitby attended a meeting of the Study Section of the National Institutes of Health. Whitby tried to convince Mueller that he should measure the size distributions and concentrations of California aerosols using a Minnesota Aerosol Analyzing System (MAAS) that Whitby and colleagues had recently developed. Mueller was convinced that Whitby's students should operate a MAAS while Mueller's crew performed size-fractionated chemical analysis of air pollution particles. Mueller challenged Whitby to come to California with his crew and his MAAS. The result was the Pasadena Smog Aerosol Experiment conducted from August 19 through September 19, 1969, at Sheldon K. Friedlander's California Institute of Technology (Caltech) laboratory in Pasadena.

A series of papers collected in a book edited by Hidy (1972) summarized the results of the Pasadena Experiment. Four papers included in the book described the Minnesota work on size distribution measurements (Husar et al., 1972; Lundgren, 1972; Whitby et al., 1972a, 1972c). The Minnesota group also published at least two other papers related to the Pasadena Experiment (Lundgren, 1973; Whitby et al., 1972b). In addition, Husar's (1971) doctoral thesis used Pasadena data extensively.

Summarizing the 1969 size distribution measurements, one could use a multimodal particle mass size distribution to describe the atmospheric aerosol in Pasadena at that time. However, this description leaves many remaining questions, including (1) what do the particle size distributions of aerosols look like in other locations at other times? (2) do multimodal particle

size distributions exist in other urban and rural locations? (3) what differences exist in the chemical composition of the size modes? and (4) what causes such size distribution modes? To test the universality and investigate possible reasons for the multimodality of atmospheric aerosols, aerosol scientists needed to obtain extensive additional data from a variety of atmospheres over a period of time. These questions directly motivated the group that conducted the Pasadena Experiment to plan a more extensive experiment in 1972.

Whitby and colleagues (1972c) describe in detail the MAAS used in the 1969 Pasadena experiment. The 1972 Aerosol Characterization Experiment (ACHEX) again used the MAAS and its associated instruments with minor modifications. The primary improvements for 1972 were a computerized data acquisition and analysis system and the mounting of all instruments in a semitrailer mobile laboratory with a carefully designed sampling system that would deliver aerosol and gas samples to the instruments.

The purpose of this chapter is not to comprehensively review the science of the ACHEX program, but to document the experience of the laboratory's operational crew during the 1972 ACHEX program. The research team extended ACHEX into part of 1973 in an attempt to capture heavy smog from Los Angeles. Because the 1973 experiments used a different crew of researchers, this chapter does not address the 1973 mobile laboratory operations.

Semitrailer Mobile Laboratory for the 1972 Aerosol Characterization Experiment

Kenneth T. Whitby (Particle Technology Laboratory [PTL], University of Minnesota, Minneapolis), Sheldon K. Friedlander (Caltech, Pasadena), and Peter K. Mueller (Air & Industrial Hygiene Laboratory, Berkeley) convinced California's Air Resources Board to fund ACHEX to find answers to the questions that still remained after the 1969 experiment. The design of ACHEX included an extensively equipped mobile aerosol and gas pollution laboratory, supported by a number of fixed laboratories around the state. The intensive experimental period of ACHEX was scheduled for late summer and fall of 1972. Rockwell Science Center, Thousand Oaks, California, was the prime contractor, with George M. Hidy as principal investigator, Terry Laucks as project manager, and many subcontractors, including PTL. Thermo-Systems Incorporated (which changed its name several years later to TSI

Incorporated), St. Paul, Minnesota, was subcontractor to PTL, responsible for designing and outfitting a converted Fruehauf 40-foot-long semitrailer to become the mobile laboratory. PTL students prepared the instruments and mounted them into the laboratory. A commercial tractor towed the mobile laboratory from Minnesota to Berkeley, where an intensive 3-week shakedown phase took place in late July and early August of 1972. Figure 1 is a schematic diagram of the trailer laboratory. We believe that this laboratory was, in 1972, the most sophisticated and complete facility in the world for characterizing the physics and chemistry of atmospheric aerosol, its gaseous precursors, and associated meteorological conditions.

The research team carefully considered aerosol sampling and transport to the instruments. Figure 2 shows the system that delivered a representative sample of aerosol from the atmosphere to the instruments with a minimum of sample loss or modification. The large diameter of the inlet region permitted the sampled aerosol to change direction from horizontal to vertical with a minimum of loss during windy conditions. The screen over the inlet prevented bugs, birds, large plant material, and other artifacts from entering the sample line. The system delivered a large quantity of aerosol vertically downward into the trailer, near the aerosol instruments, to reduce loss and modification of the aerosol particles. The sampling team had a choice of two sampling heights: one at 13 m above the ground and one at 6 m above the ground. We could switch a quick-change manifold inside the trailer to alter the sample line.

Inside the trailer, instruments that measured or collected particles larger than $0.5\ \mu\text{m}$ sampled directly downward, or as nearly downward as could be accommodated in the available space. Large-particle instruments sampled aerosol isokinetically from the high-flow aerosol stream. The instruments removed aerosol for particles smaller than $1\ \mu\text{m}$ using nonisokinetic methods. As needed, we drained rain and condensed water from the bottom of the sampling pipe. The entire sampling pipe was made of lightweight aluminum for ease of assembly and transport.

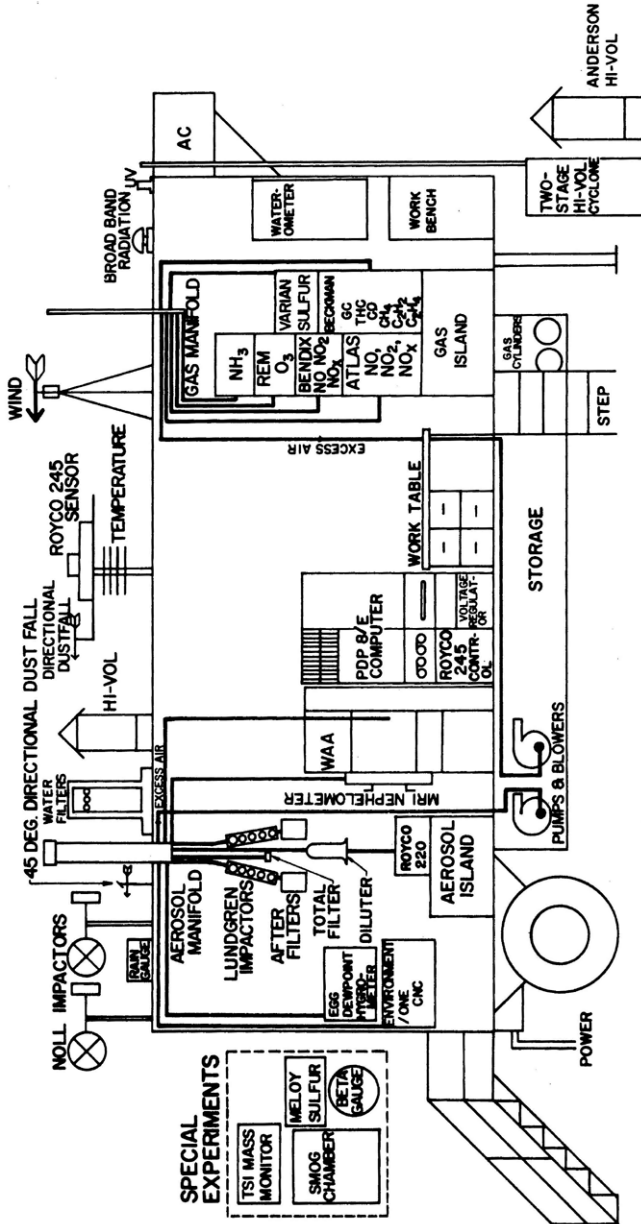

Figure 1. Semitrailer mobile air pollution laboratory used in the 1972 Aerosol Characterization Experiment program.

Source: Whitby et al. (1980). Reprinted with permission from George M. Hidy.

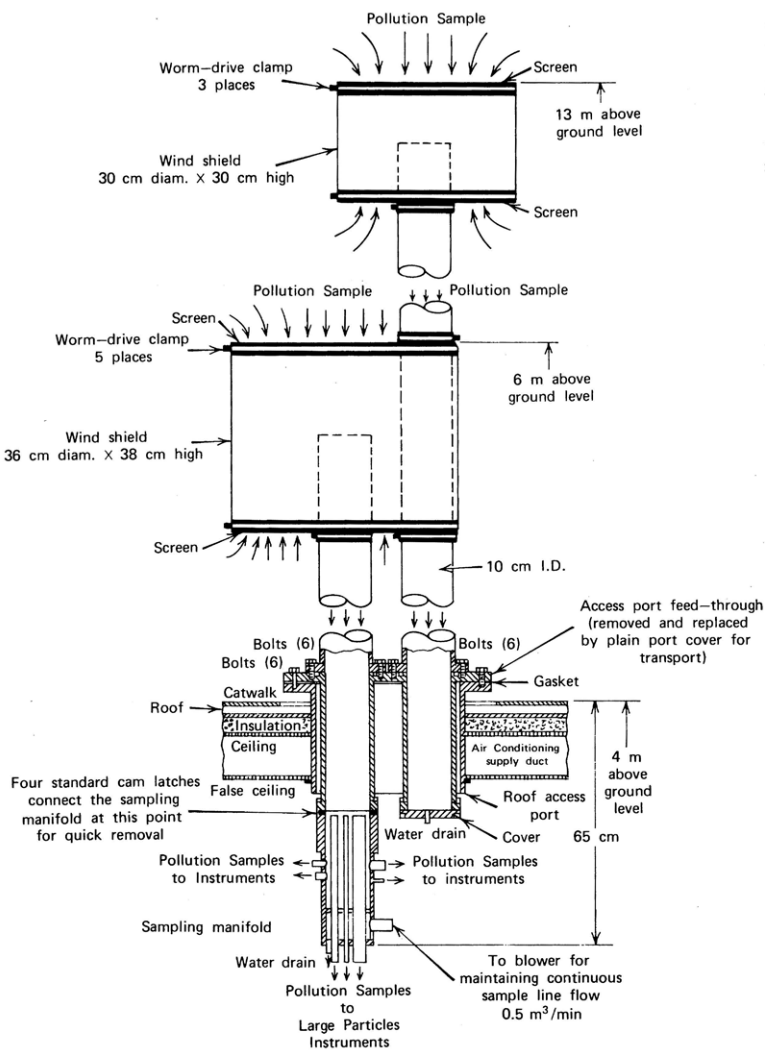

Figure 2. Aerosol sampling and sample delivery system used for the Aerosol Characterization Experiment semitrailer laboratory.

Source: Sem et al. (1980). Reprinted with permission from George M. Hidy.

Figure 3 shows the distribution of aerosol to the measuring and sampling instruments inside the trailer laboratory, the air flow adjustment system, and the air movers in the undercompartment of the trailer.

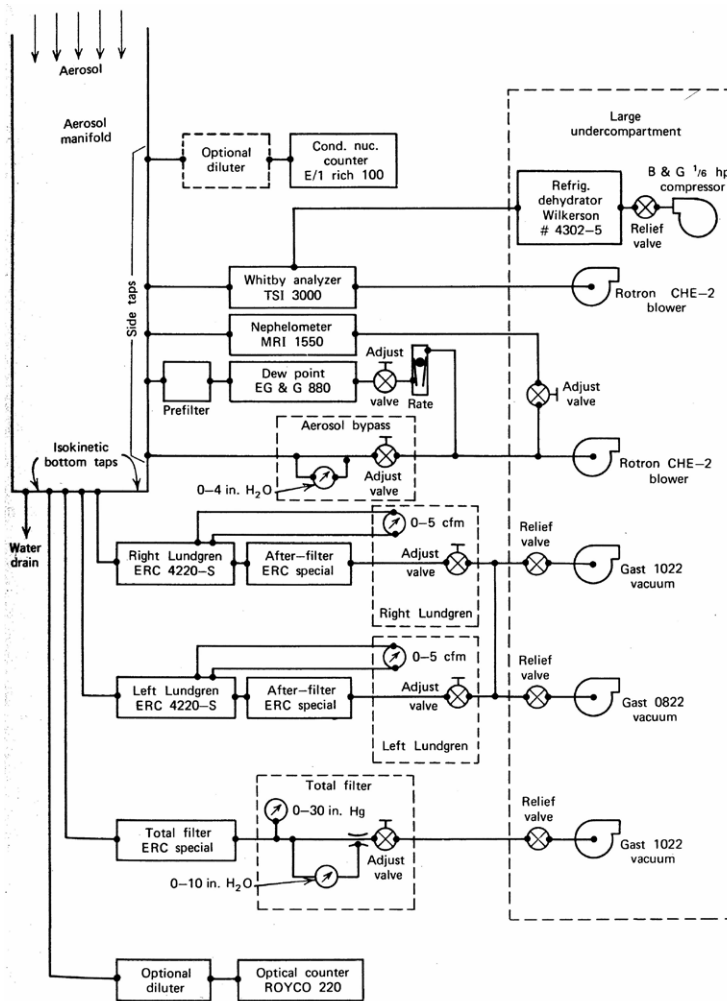

Figure 3. Distribution of aerosol samples to measuring instruments inside the Aerosol Characterization Experiment trailer laboratory.

Source: Sem et al. (1980). Reprinted with permission from George M. Hidy.

The MAAS comprised three instruments that performed the primary measurements of aerosol size distributions and concentrations. These instruments included (1) the condensation nucleus counter (CNC), (2) the optical particle counter (OPC), and (3) the electrical aerosol analyzer (EAA), then known as the Whitby aerosol analyzer. The first of these to be developed was the CNC (McMurry, 2000). Scientists developed the first manually operated CNCs during the period 1870–1890 and engineers during World War II automated the instruments as practical aerosol concentration detectors for aircraft to detect the presence of diesel-powered submarines upwind of the flight path. In 1972, the MAAS used a CNC manufactured by Environment/One to detect the concentration of aerosol particles larger than about 0.004 μm . As Whitby et al. (1972b) describe, concentrations above 100,000 per cubic centimeter were problematic for this CNC. In fact, the best way to calibrate the CNC at that time was by comparing it with a commercial version of the EAA. Experience convinced us that EAA-measured concentrations were more reliable than the Environment/One-calibrated CNC-measured concentrations. The Minnesota group found that CNC-indicated concentrations were about 1.75 times higher than those measured by an EAA.

The OPC was the next of the three key aerosol instruments to be commercialized. Scientists first developed the OPC during World War II to measure the size distribution of aerosol particles in the 0.5–10 μm range in filtered air chambers, often called clean spaces (Lieberman, 2005). Zinky (1962) described the first commercial OPC, the Royco 200 (manufactured by the Royco Company). To measure atmospheric aerosols, Whitby et al. (1972b) modified the clean room instrument so that it was able to dilute the aerosol sample and introduce sheath air to restrict the aerosol stream to the center of the sensing zone.

The EAA, as described by Whitby and Clark (1966), was the last of the three key aerosol instruments to be developed. TSI introduced a commercial model, TSI Model 3000 (known as “the Whitby aerosol analyzer” [WAA]), in 1967. The WAA was capable of measuring the size distribution of aerosol particles in the 0.005–1.0 μm range, although its primary range was 0.01–0.433 μm . Figure 4 is a schematic diagram of the WAA, similar to the way it was made in 1972.

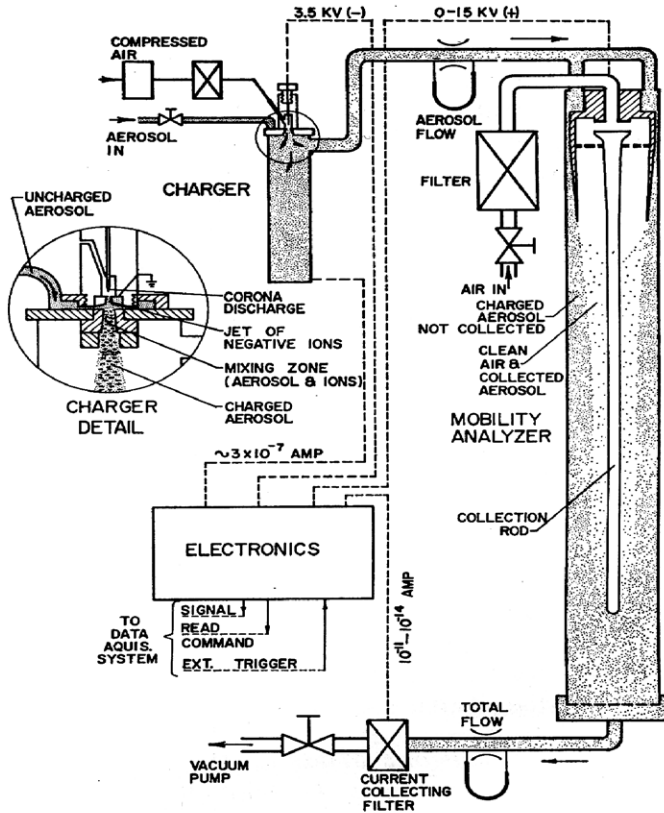

Figure 4. Schematic diagram of the Whitby aerosol analyzer, Thermo-Systems Incorporated Model 3000, used on the Aerosol Characterization Experiment trailer laboratory in 1972. A different version of this diagram was published by Whitby et al. (1972c). This instrument is a commercial version of the instrument described by Whitby and Clark (1966).

Together, the CNC, WAA, and OPC formed the MAAS and were capable of measuring the number concentration size distribution in the 0.004–10 μm range. In 1972, the ACHEX research team used a Model 220 Royco OPC to measure 0.433–5.62 μm particles. We added a fourth instrument to the MAAS—a Royco Model 245 OPC that operated on the roof of the trailer and measured the size distribution of particles larger than 5.62 μm and perhaps as large as 30 μm —as well as a mini-computer, a Digital Equipment Corporation (DEC) PDP-8, to acquire the data and perform a minimal amount of

analysis. The DEC computer also collected data from the gas-analysis and meteorological instruments. This was the first time anyone had attempted to collect and record such a wide range of aerosol, gaseous, and meteorological data in one place, simultaneously.

A Meteorology Research Incorporated Model 1550 integrating nephelometer measured the light scattering coefficient of the aerosol. Ensor and Covert (2006) and Heintzenberg and Charlson (1996) address the development of the integrating nephelometer. Our key aerosol samplers were two Lundgren cascade impactors that provided time-resolved and particle size-resolved samples for chemical analysis. We collected 4-hour samples on 47-mm filters for chemical analysis. On the roof of the trailer, we had two Noll rotating vane impactors to collect samples of particles too large (as large as 100 μm) to be sampled through the sampling tubes. We collected high-volume particle samples to compare with other measurements. Table 1 is a list of aerosol instruments routinely used on the mobile laboratory.

Table 1. Instruments for aerosol particle measurements during ACHEX 1972

Instrument	Aerosol Particle Measurement
<ul style="list-style-type: none"> • Whitby electrical aerosol analyzer • Thermo-Systems Incorporated Model 3000 	Submicrometer particle size distribution, 0.01–0.433 μm
<ul style="list-style-type: none"> • Condensation nuclei counter • Environment/One Rich 100 	Number concentration of particles larger than 0.01 μm , 0–300,000/ cm^3
<ul style="list-style-type: none"> • Optical particle counter, inside • Royco 220 	Particle size distribution, 0.433–5.62 μm
<ul style="list-style-type: none"> • Optical particle counter, outside • Royco 245 	Particle size distribution, 5.62–38 μm
<ul style="list-style-type: none"> • Lundgren cascade impactors (2) • Environmental Research Corporation 4220-S 	Time- and particle size-resolved particle samples
<ul style="list-style-type: none"> • Integrating nephelometer • Meteorology Research Incorporated 1550 	Light scattering coefficient, m^{-1}
<ul style="list-style-type: none"> • Total aerosol filter • Environmental Research Corporation Special 	Gravimetric and chemistry samples
<ul style="list-style-type: none"> • High-volume particulate sampler • Andersen Samplers 	Environmental Protection Agency (EPA) regulatory gravimetric and chemistry samples
<ul style="list-style-type: none"> • Rotating vane impactors (2) • Kenneth Noll Special 	Large-particle collectors, up to 100 μm
<ul style="list-style-type: none"> • Directional dust-fall samplers • Weather Measure Corporation 	Microscopic analysis of dust fall

The purpose of the gas analysis instruments on the trailer laboratory was to measure the concentrations of aerosol precursors and relate them to what was happening to the aerosol. Table 2 is a list of the gas-phase analysis instruments that the research team routinely used on the mobile laboratory.

Meteorological instruments measured the temperature, dew point temperature, wind direction and speed, and solar radiation in several wavelength bands. We measured rainfall with a collector mounted on the roof. Table 3 is a list of the meteorological instruments routinely operated on the mobile laboratory.

Table 2. Instruments for gas-phase concentration measurement during the 1972 Aerosol Characterization Experiment

Instrument	Measurement
Flame photometric sulfur analyzer	Varian 1440
Hydrocarbon analyzer	Beckman 6800
NO, NO ₂ , NO _x analyzer	Bendix B101B
Ozone analyzer	REM 612
Ammonia analyzer	Gelman sequential bubbler

Table 3. Instruments for meteorological measurements during the 1972 Aerosol Characterization Experiment

Instrument	Measurement
Wind speed and direction sensors	Meteorology Research Inc. 1074
Thermometers, inside and outside	Rosemount 4128
Dew point hygrometer	Cambridge 880
Broadband radiation detector	Eppley Laboratory Inc. 2(1154 F3)
Ultraviolet radiation detector	Eppley Laboratory Inc. 2(11692)
Rainfall	Weather Measure P561

1972 Mobile Laboratory Operations in California

The team that operated the mobile laboratory from mid-July into November of 1972 consisted of the authors of this paper (Sem, Clark, Sverdrup, and Marple), with strong logistic support from Don Hern of Rockwell Science Center. During 1972, we operated in the following nine locations, listed in chronological order (Hidy & Mueller, 1980a):

1. Berkeley, across the street from the Air and Industrial Hygiene Laboratory, July 15 through August 8. ACHEX leadership chose this site to complete instrument installation, perform acceptance tests of the mobile laboratory, and develop measurement protocol.
2. Richmond, San Pablo Water Pollution Control Plant just east of San Francisco Bay, August 9 through 16, with intensive experiments performed August 10 and 11 and August 15 and 16. This was an urban industrial site downwind of a chemical complex.
3. San Francisco Airport, just off the freeway, beside the end of the heavily-used north-south runway, August 18 through 25, with an intensive experiment performed August 21 and 22. This site had aircraft-enriched aerosol and was a receptor of aerosol from the west San Francisco Bay area.
4. Fresno County Fairgrounds, 1121 Chance Avenue, Fresno, near the middle of the farming area in San Joaquin Valley, August 28 through September 11, with intensive experiments performed August 31 and September 1 and September 6 and 7. This site offered photochemical and agricultural aerosol.
5. Hunter Liggett Military Reservation, a tank-training facility in a rural meadow of the coastal hills, a few kilometers southwest of King City, September 12 through 18, with an intensive experiment performed September 13 and 14. At this site, we expected to see photochemical aerosol produced from vegetative organic emissions.
6. Los Angeles, 50 m east of Harbor Freeway, across from University of Southern California campus, a few kilometers southwest of downtown Los Angeles, September 19 through October 2, with intensive experiments performed September 19 and 20 and September 27 and 28. This site offered urban aerosol enriched by vehicular traffic.

7. Los Angeles County Fairgrounds, Pomona, several kilometers north of Interstate 10, a few kilometers east of Los Angeles, October 3 through 30, with intensive experiments performed October 5 and 6 and October 24. This site was a receptor of aged Los Angeles photochemical aerosol.
8. Goldstone Tracking Station, 60 km north of Barstow, remote region, Mojave Desert, surrounded by military bases, October 30 through November 4, with an intensive experiment performed November 1 and 2. This site represented desert background aerosols; it also offered aged Los Angeles aerosol.
9. Point Arguello Coast Guard LORAN (LONg RANge Navigation) Station, Pacific Ocean from east-southeast to north-northwest, Vandenberg Air Force Base on the other sides, November 6 through 10, with an intensive experiment performed November 9 and 10. This site was chosen to represent marine background aerosols.

Except Berkeley and the Los Angeles County Fairgrounds in Pomona, these locations were “typical.” At these locations, a normal semitrailer tractor towed the trailer to the site and parked it at the preselected, prepared site. The crew usually arrived the following day, plugged the mobile laboratory’s power cord into the prepared electrical supply, and began preparing for one or more 24–36-hour intensive measurement periods. We set up, calibrated, and readied both external and internal components of the laboratory in preparation for the intensive periods.

The research team usually scheduled intensive experiments for 24-hour periods beginning during the daytime. During an intensive experiment, nearly every instrument was in operation. We took turns staying with the mobile laboratory throughout the night. The remainder of the crew would return to their families for the night, returning in the morning to finish the intensive experiment. If something went wrong, the person(s) on intensive duty did his best to correct the problem as quickly as possible.

Berkeley

Berkeley was not a typical location. ACHEX leadership chose the site to complete installation of the instruments and the data acquisition computer and to demonstrate that the trailer laboratory was ready for the remainder of the program. The location was just across the street from the Air and Industrial Hygiene Laboratory where Peter Mueller and his associates were

located. This was a convenient place to complete installation of the equipment, debug the computerized data acquisition system, and perform several shakedown tests during which we could learn how to operate efficiently and effectively. While we were at Berkeley, many people, in addition to our core team of four, helped to perform the many necessary duties.

A major problem that we had to solve while at Berkeley was how to establish effective communication between the DEC computer and the instruments. We vividly recall Kenneth Whitby stretched out on the floor, a soldering iron in one hand, a screwdriver in the other, ensuring that each electrical connection was truly conductive. He communicated at least daily with Rockwell's computer expert, George Lauer, during this time. The stress of the moment caused some conversations to become rather animated. Eventually, their collaboration was successful. Whitby labored at least as hard and as many hours as anyone else to make sure everything got done, and his work ethic inspired us.

In Berkeley, we adjusted to our responsibilities within the Minnesota team. Clark became the crew chief, responsible for communications with Whitby and George Hidy, scheduling the intensive experiment, making sure everything was ready before an intensive period, making sure data were handled properly, and scheduling moves between sites. Sverdrup became the computer operator; Marple became data analyst; and Sem was responsible for outdoor equipment and for trailer systems including air conditioner, electric power, vacuum pumps, and storage compartments. Although we used this division of responsibilities when all was operating normally and everyone was present, we were generally able to step in to help each other when necessary. We all took our turns alone in the laboratory during intensive experiments.

Don Hern of Rockwell was our contact with the outside world while we were on site. He delivered impactor and filter samples to the groups that analyzed them and brought back filters, impactor substrates, gas cylinders, and other equipment as needed. Sometimes, he drove through the night to make sure we had the proper equipment and supplies on schedule. His points of contact ranged from Berkeley to Thousand Oaks to wherever the laboratory was parked. Figure 5 shows the crew of five in front of the mobile laboratory at Point Arguello as the 1972 mobile laboratory operations drew to a close.

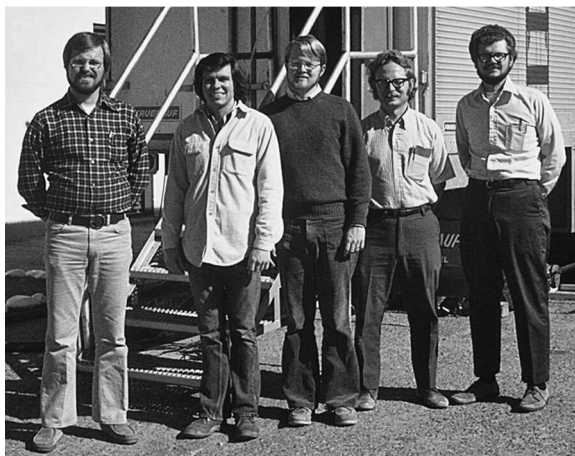

Figure 5. The crew in front of the trailer-laboratory at Point Arguello. Left to right: Don Hern, William Clark, George Sverdrup, Gilmore Sem, and Virgil Marple.

Source: Photo courtesy of Virgil Marple.

Richmond

When we arrived at the Richmond site in mid-August, we were finally on the way to do what we had set out to do: measure California aerosol. Richmond is on the east side of San Francisco Bay, near the waterfront, almost directly east of the Golden Gate Bridge. ACHEX leadership chose this location to measure urban industrial aerosol not far from a chemical complex. This was the first time that we operated with our normal crew. The mobile laboratory was parked beside water treatment ponds. We continued to live in apartments in Berkeley during this time.

At this site, we determined that we needed real-time plots of air quality and aerosol measurements to understand how the study was progressing. To that point we had used teletype printouts of data from the PDP-8 system. Tabular data were not going to help us adjust our operations to collect more relevant data. We met our needs by taping graph paper to the interior walls of the mobile laboratory and hand plotting data as a function of time of day.

San Francisco International Airport

The San Francisco International Airport was an exciting site. ACHEX leadership chose this location to measure the aerosol that resulted from aircraft and aerosol that came from elsewhere in the San Francisco Bay area. We were located a few meters from the end of a primary runway, where large airplanes lined up to begin takeoff. Some of the planes, notably older 727s, blew dark clouds of heavy black smoke toward our site whenever they applied maximum power at the beginning of takeoff. This site was also within several

hundred meters of the major north-south freeway between San Francisco and Silicon Valley. The concentration of the aerosol at this site varied rapidly depending on which local source was dominant and the direction of the wind.

During this period, the ACHEX program scheduled a press conference, resulting in newspaper articles about the program the following day. We continued to live across the bay in the Berkeley apartments at this time. However, at the end of the San Francisco International Airport measuring period, we moved with our families to Fresno for 1 week.

Fresno County Fairgrounds

Near the end of August, Fresno is generally hot and humid and does not experience much rain. The land around Fresno is flat, rich farm land that requires irrigation for reliable crops, but at this time of year, Thompson seedless grapes lie on paper mats on the ground, drying into raisins between rows of grape plants. In 1972, however, we found 0.3 inches of rain in the rain gauge one morning. A large fraction of the 1972 Fresno raisin crop was ruined that night.

Figure 6 is a photograph of the mobile laboratory at the Fresno site. We experienced the first case of condensation on particles when we sampled high temperature and high humidity aerosol into the air-conditioned interior of the mobile laboratory. Because of the temperature and humidity, the particles grew as they passed through the cool sampling tubes inside the laboratory, causing a poor match between the OPC-measured size distributions inside the trailer and the OPC-measured distributions measured on the exterior roof. That the measurement of particles smaller than $0.5 \mu\text{m}$ were affected significantly is unlikely.



Figure 6. Mobile laboratory parked at the Fresno County Fair Grounds, late in August 1972.

Source: Photo courtesy of Gilmore Sem.

Hunter Liggett Military Reservation

Hunter Liggett was a military tank training facility for the US Army. We chose this site to measure background aerosol and perhaps aerosol resulting from organic emissions from vegetation. ACHEX leadership chose to park the trailer laboratory on a meadow in the remote coastal hills. The only signs of human life were military tanks that occasionally chased each other on training exercises over dirt roads.

One of our tasks was measuring the visibility at least once each day by estimating how far away one could visually resolve a dark object in front of a light object. At Hunter Liggett, that required climbing a distant hill on foot. Along the way, scattered small pine trees grew, with huge cones, each with a diameter of 15–20 cm. The ground cover in this area in September was dried grass, giving everything a golden hue. The target for visibility measurements was usually a single dark-green tree backed by the golden grass of a distant hill.

During this visit, we lived with our families in a motel in King City. The drive to the reservation was pleasant—a few miles of rural paved road, followed by several miles within the reservation. On two such early-morning trips to the reservation, one of us (Sem) encountered herds of 6–12 wild boars.

Harbor Freeway

In mid-September, we returned to a big city. In Los Angeles, ACHEX leadership chose to park the mobile laboratory near the corner of an empty parking lot that covered much of a city block. We were the only occupants of the parking lot. The site was about 50 meters from the east side of Harbor Freeway, just across the freeway from the campus of University of Southern California. At this location, Harbor Freeway had four busy lanes in each direction. ACHEX leadership chose this site to measure the contribution of a major highway to the urban aerosol of Los Angeles (Whitby et al., 1980). In Chapter 20 of this book, Sem and colleagues consider the measurement shown in Figure 7 to be the first near-real-time measurement of the effect of vehicular traffic on the particle size distribution of urban aerosol. Figure 7 shows two consecutively measured size distributions—one with wind from the freeway and one with wind away from the freeway. We attributed this difference to vehicular traffic.

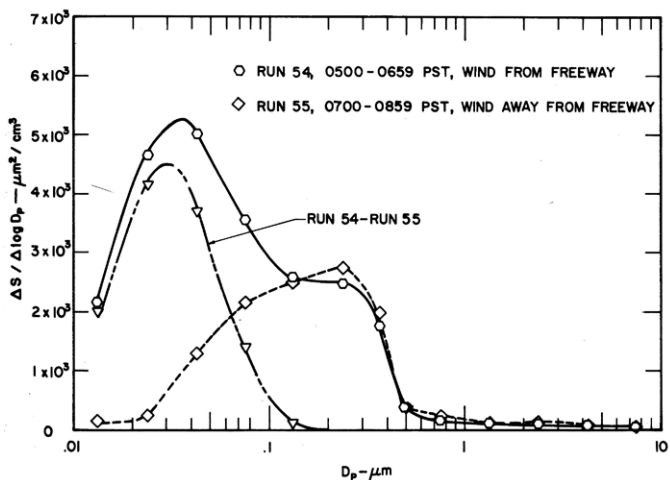

Figure 7. Two consecutively measured size distributions, one with wind from the freeway and one with wind away from the freeway. The difference distribution, shown on the figure, was attributed to vehicular traffic on the freeway.

Source: Whitby et al., 1975, 1980. Reprinted with permission from Elsevier.

At this site, we saw water evaporate from particles rather than condense on aerosol inside the sampling tube, as we did in Fresno. Early in the day at Harbor Freeway, when the interior of the laboratory was warmer than the outdoor air, water evaporated from the particles as they passed through the warm sampling tubes inside the laboratory. Figure 8 illustrates this effect.

During our stay at Harbor Freeway and Pomona, we lived at Newport Beach (Clark and Marple), Glendale (Sverdrup), and Santa Ana (Sem). The drives to and from the mobile laboratory sites were pleasant. We discussed what was happening, what we should do about problems, and what scheduling issues we faced. We usually drove together in one car, with the exception of the intensive collection day, when the person taking the overnight shift drove separately. That person usually went home when the crew arrived the next morning to relieve him.

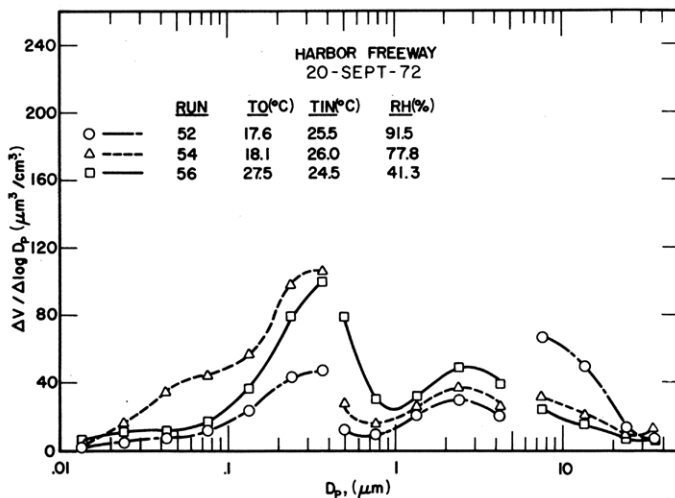

Figure 8. Size distributions illustrating the effect of water evaporation from particles as the aerosol was sampled from cooler outdoor air into the heated interior of the mobile laboratory. TO is the temperature outside; TIN is the temperature inside the laboratory; RH is relative humidity, which was measured outside. All three measurements were made in the morning as the sun warmed up the outdoor air and greatly reduced the relative humidity. The indoor optical particle counter (OPC) measured the particles between 0.5 and 5 μ m. The particles measured by the indoor OPC underwent evaporation of water during sampling. If the evaporation was not taking place, the portions of the size distribution in the middle size range would match much more closely the size distributions measured by the Whitby aerosol analyzer (smaller particles) and the outdoor OPC (largest particles). Sverdrup and Whitby (1980) showed that the results in this figure could not have been caused by index of refraction changes. They presented a method of correcting for the humidity effect.

Source: Sverdrup & Whitby (1980). Reprinted with permission from George M. Hidy.

Los Angeles County Fairgrounds, Pomona

The Los Angeles County Fairgrounds was not a typical location, although we intended to capture typical aged smog coming up the pass from the Los Angeles Basin. We thought that this site would be the focal point of the 1972 ACHEX program. We were there during the right season, so the somewhat aged Los Angeles smog should have been present during many of the days we were there. We set up the laboratory on the first day or two, and then waited for Los Angeles air pollution to arrive. Although we spent 4 weeks at this site, no heavy smog arrived. This was the most disappointing site for 1972, although the local residents enjoyed relatively clean air. In 1973, a different

crew returned to this site and measured heavy smog, but that is not the topic of this chapter.

One family grew as Sverdrup and his wife welcomed the birth of a daughter.

Goldstone Deep-Space Tracking Station

This desert site renewed our energy and enthusiasm, overcoming the monotony of waiting for Los Angeles smog to arrive in Pomona. We enjoyed Goldstone and made some significant measurements there. Goldstone is located in a remote area in the Mojave Desert, beside a dry lake bed, about 60 km north of Barstow and about 200 km northeast of Los Angeles. Surrounded by several military bases, one cannot access this area without a military pass. ACHEX leadership arranged to park the mobile laboratory beside radio signal receivers for deep-space satellites. Almost no plants grew higher than a very few centimeters in this desert area. This site gave us access to typical desert background aerosol.

As we drove up to this site from Barstow, we noticed unusually high visibility. Mountains located nearly 100 km away were clearly visible with almost no blue haze. We recognized that the air was unusually free of aerosol, so we rushed to set up the aerosol particle sizing instruments. They were running by 1:30 p.m., within a few minutes of our arrival at the site. We measured the lowest level of atmospheric aerosol that anyone in the Minnesota group had ever measured. The total number concentration was below the lower detection level of the condensation nuclei counter, about 500 particles per cm^3 . This was at least 100 times lower than the concentrations measured during the day near Harbor Freeway. Figure 9 shows the results of the particle size distribution measurements. The total volume concentration was $1.85 \mu\text{m}^3/\text{cm}^3$, almost an order of magnitude lower than the average level later in the week.

Later, we concluded that the clean air when we arrived was a result of a large downdraft of high-altitude clean air. The event was over by 6:00 p.m. The week before we arrived, rain had fallen in this area, and the “dry” lake bed near the trailer contained standing water when we arrived. The air we measured came from the north, crossing the lake bed just before we sampled it. Earlier on the day we arrived, gusty winds had blown in from the north. We were very fortunate to have captured such rare data.

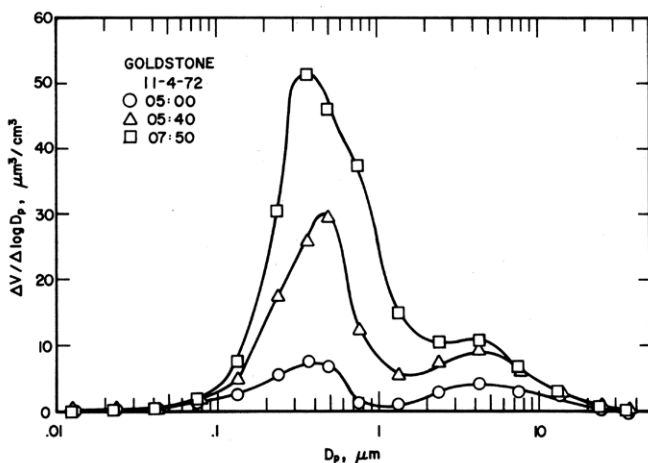

Figure 9. Three volume particle size distributions measured at Goldstone showing ultraclean (relatively particle-free) air at 5:00 p.m., followed by growing concentrations of aerosol as aged air pollution entered the region. Visibility was not measured during this time, but 5 hours before the measurements began, around 12:00 p.m., we observed mountains that were about 100 km away very clearly with almost no blue haze. By 7:50 p.m., the extreme visibility was no longer present.

Source: Sverdrup et al., 1975. Reprinted with permission from George M. Hidy.

The highest level of volumetric concentration that we recorded at this site was $30 \mu\text{m}^3/\text{cm}^3$, just before we left the site, during an incursion of an air mass from Los Angeles. This was comparable to the typical level measured during the 1969 Pasadena study. Very little of the aerosol was less than $0.1 \mu\text{m}$, indicating that it was aged atmospheric aerosol. Further details are described by Sverdrup et al. (1980).

Point Arguello Coast Guard Station

Point Arguello was the last stop of the 1972 ACHEX mobile laboratory program. ACHEX leadership chose this site to measure aerosol coming from the Pacific Ocean before it became contaminated by land-based sources. We were able to achieve our goal easily at this site because the wind almost always came from the ocean.

The trip to the US Coast Guard LORAN Station site each day was interesting. We drove by the Lompoc low-security federal prison farm and then through Vandenberg Air Force Base, passing the satellite launch facility. The Coast Guard Station was truly isolated, because visitors required special

passes to cross Vandenberg. The men assigned to the Coast Guard Station lived and worked there for year-long periods, having little contact with the outside world. We became a substantial diversion for them.

Summary of Experimental Results

At about the time of ACHEX, the University of Minnesota adopted new ways of plotting aerosol size distributions. Figure 10 shows five ways of displaying the same size distribution. For ACHEX data, the three plots in the lower right of Figure 10 proved most useful.

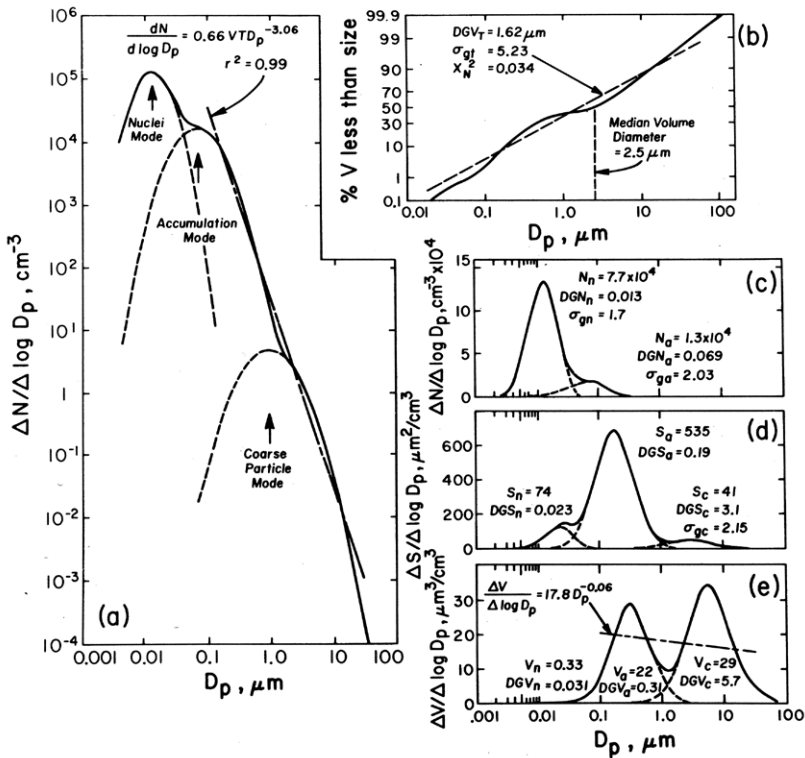

Figure 10. A single particle size distribution plotted five different ways to illustrate how features of the distribution can be emphasized or nearly hidden by the method of data presentation. In this example, an average urban aerosol distribution was fitted to a power law (left), a log-normal model (top right), and number, surface, and volume distributions that emphasize the modal nature of the aerosol.

Source: Whitby (1978) and Whitby & Sverdrup (1980). Reprinted with permission from George M. Hidy.

Figure 11 shows the grand average volume size distribution for 7 of the ACHEX 1972 mobile laboratory sampling sites compared with clean continental background aerosol.

If the experiment is done very carefully, the agreement between the near-real-time aerosol sizing instruments and a Lundgren cascade impactor can be remarkable, as Figure 12 shows.

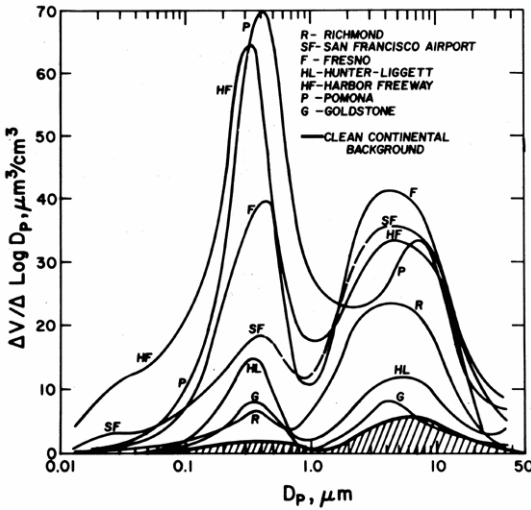

Figure 11. Grand average aerosol particle size distributions measured at seven sampling sites during the 1972 Aerosol Characterization Experiment program. During the 1970s, Whitby often presented "grand average" particle size distributions. Source: Whitby & Sverdrup (1980). Reprinted with permission from George M. Hidy.

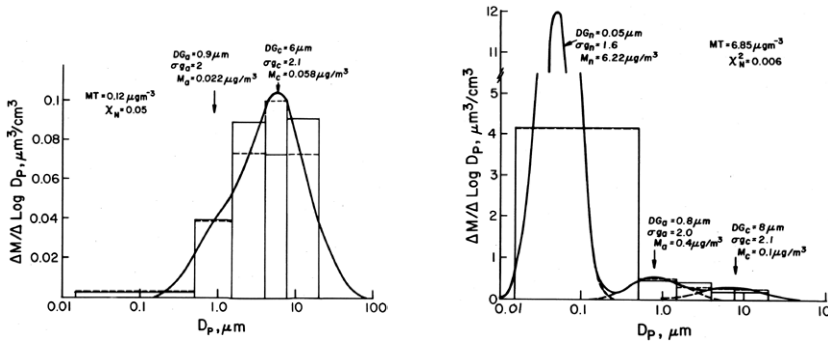

Figure 12. Comparison of mass distributions measured by real-time size distribution instruments and bromine concentration determined from Lundgren impactor samples on the trailer laboratory during the 1972 Aerosol Characterization Experiment. On the left is a coarse-mode dominated aerosol. On the right is a nuclei-mode dominated aerosol. Source: Whitby & Sverdrup (1980). Reprinted with permission from George M. Hidy.

Some of the key scientific results of the 1972 ACHEX included

- confirming the multimodal nature of aerosol size distributions in multiple California locations during a wide range of time periods. The original concept for multimodal aerosol size distributions grew out of data collected during the 1969 Pasadena Smog Project and at several other locations. Figure 13 is a schematic representation of multimodal atmospheric aerosol size distributions and the sources of each mode.

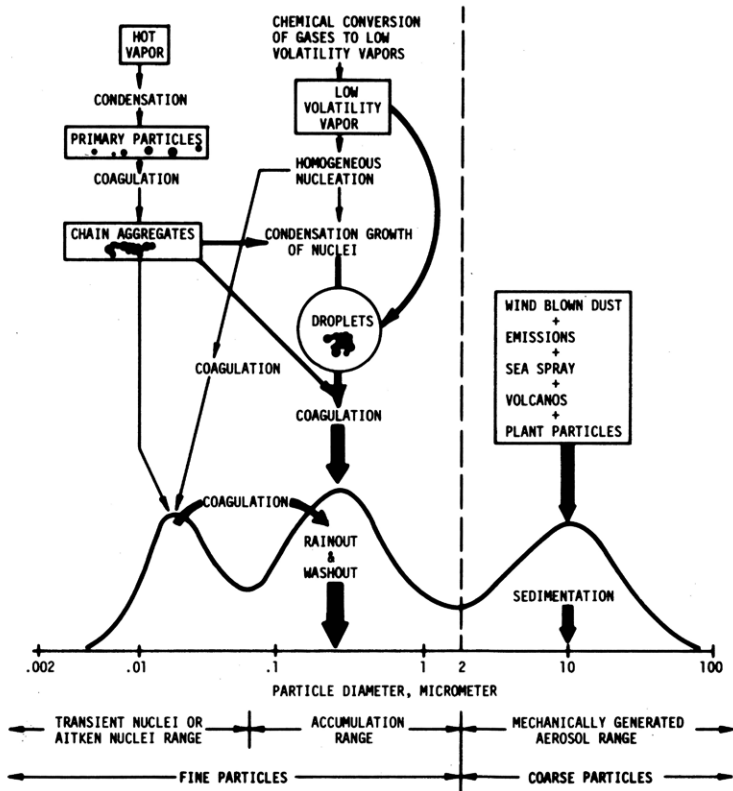

Figure 13. Schematic model showing a trimodal atmospheric aerosol volume size distribution showing how the modes are generated and terminology for the modes. This model was developed by Whitby (1978) and Whitby and Sverdrup (1980) shortly after ACHEX, based partially on ACHEX data.

Source: Reprinted with permission from George M. Hidy.

- performing the first measurements made with near-real-time instruments of the effects of freeway traffic on aerosol concentrations and size distributions. See Figure 7.
- measuring diurnal variations of aerosol size distributions and concentrations with time resolutions of several minutes.
- obtaining particle size- and time-resolved samples of aerosols for chemical compositional analysis with resolution of a few minutes to compare with other measurements. See Hidy et al. (1973, 1974).
- measuring the aerosol characteristics of air masses entering Los Angeles from the western ocean and the eastern desert.
- measuring the characteristics of relatively fresh aerosol within Los Angeles and the characteristics of aged aerosol 100–200km downwind of Los Angeles.
- performing the first measurements of the size distributions and concentrations of outdoor air that was unusually free of aerosol particles; these measurements were made during a short period in the Mojave Desert. See Figure 9.
- making the first large-scale simultaneous measurements of gaseous precursors, aerosol physical characteristics, and aerosol chemical characteristics in multiple locations over 24-hour periods. See Hidy et al. (1973, 1974).
- measuring aerosol size distributions, concentrations, and chemical composition using several different overlapping methods.
- proving the usefulness of near-real-time aerosol measurements for urban and rural environments.
- proving the usefulness of mobile air pollution platforms for intensive experiments using many different instruments simultaneously.
- developing sampling protocols and equipment for atmospheric aerosols.
- using, for the first time on a large scale, an on-site computer to collect data from a wide range of field instruments that measured aerosol and aerosol precursors.
- developing sampling protocols and equipment for atmospheric aerosols.
- serving as a model for at least a decade of large-scale experimental aerosol studies.

Legacy

The size distribution data that we obtained verified the multimodal nature of atmospheric aerosols in a wide variety of locations in California during a variety of times during the summer and fall of 1972. The near-real-time particle size data that we obtained using the Minnesota aerosol sizing system agreed with mass distributions that we obtained with cascade impaction sampling. Moreover, data that we obtained from Lundgren cascade impactors demonstrated that chemical analysis of each segment of the size distribution could be performed for urban atmospheric aerosol with 4-hour time resolution.

The data illustrated the power of collecting near-real-time data about aerosols and gaseous aerosol precursors simultaneously, all recorded in a single format in a single location by a mini-computer. This method evolved in the early 1980s, as scientists began using personal computers for data acquisition and real-time analysis.

The amount of data that we could acquire and partially reduce on-site and online for field experiments of this type was a precursor for future field experiments, and the sampling, sample delivery, and sample conditioning systems developed for the ACHEX mobile laboratory still serve as a model for aerosol field programs 35 years later.

The ACHEX semitrailer mobile laboratory served as a model for a semitrailer mobile laboratory that the Environmental Protection Agency (EPA) built and used the following year. The EPA laboratory participated in a number of aerosol field measurement programs during the 1970s. Figure 14 is an example of a trimodal size distribution obtained by the EPA mobile laboratory during the General Motors Sulfate Experiment in 1975 (Wilson et al., 1977).

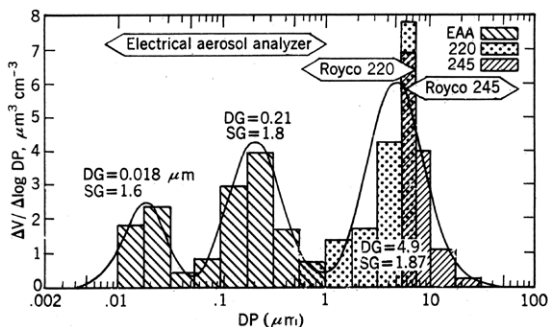

Figure 14. Trimodal volumetric size distribution of aerosol downwind of a major automobile exhaust test program at General Motors Test Track in 1975. This figure is the best experimental illustration of the multimodal nature of atmospheric aerosol.

Source: Wilson et al. (1977).
Reproduced with permission of Air and Waste Management Association via Copyright Clearance Center.

The ACHEX and EPA mobile laboratories served as learning platforms for development of a University of Minnesota “bread truck” mobile laboratory built during the mid-1970s (Wolf, 1978).

The instrumentation suite used on the ACHEX mobile laboratory served as a model for a number of field aerosol monitoring programs during the following 8 years (Hidy & Mueller, 1980b).

During ACHEX, David Pui briefly toured a number of Southern California locations with his new “portable” electrical aerosol analyzer. He measured submicrometer size distributions from several platforms, including a personal car and a small airplane (Liu et al., 1974). William Wilson of EPA noticed Pui’s activities with his new instrument and asked TSI to supply three of them for his programs. This led directly to TSI’s decision to develop and commercialize the Model 3030 electrical aerosol analyzer, a workhorse aerosol sizing instrument during the following 20 years.

ACHEX also served as an important spring-board for a number of careers.

Virgil Marple was an assistant professor of mechanical engineering at the time of ACHEX. He later became full professor of mechanical engineering, University of Minnesota. He continued his research in the Particle Technology Laboratory, eventually establishing a Particle Calibration Laboratory. His main areas of research included the study of respirable coal dust and diesel exhaust particles in the coal mining industry. He developed many cascade impactors, virtual impactors, and a next-generation pharmaceutical impactor for evaluation of medical respirable inhalers.

William Clark completed his doctoral degree (Clark, 1973) and joined the Rockwell Science Center, where he worked with George Hidy analyzing ACHEX data and taking part in subsequent aerosol monitoring studies using the ACHEX mobile laboratory. After 2 years, he joined the Rockwell Air Monitoring Center, where he was involved in aerosol monitoring programs for the EPA. In 1977, he became a professor in the Environmental Engineering Department, California Polytechnic State University (Cal Poly), San Luis Obispo, California. After a few years, he joined the Mechanical Engineering Department. He retired from Cal Poly in 2004.

George Sverdrup’s thesis (Sverdrup, 1977) involved many analyses of ACHEX data. He went on to a research position at Battelle Memorial Institute, Columbus, Ohio, where he led research on environmental issues. Using ACHEX experience, he led a major study of alternative motor fuels in

southern California from 1990 to 1994, involving about 20 organizations and a fleet of Federal Express trucks. This was followed by a major government-private study of the effects of sulfur in diesel fuel on emission control equipment providing a technical basis for EPA's regulations for low-sulfur diesel fuels. He now manages the hydrogen research program at the National Renewable Energy Laboratory, Golden, Colorado.

Gilmore Sem continued to develop commercial aerosol instruments for TSI for about 10 more years and then managed the aerosol instrument division for 23 years. During his final years at TSI, he served as director of market development for aerosol research. None of this would have happened if ACHEX had not served as an essential financial bridge between TSI's early investment in aerosol instrumentation and the introduction in 1973 of the highly successful Model 3030 EAA. It is probable that TSI would have decided to exit the aerosol instrumentation business if ACHEX had not provided a year of financial support for the embryonic aerosol instrument group during a critical time for the company. ACHEX also provided him with the necessary field measurement experience that led to a decade of highly productive development of field-ready commercial aerosol instruments.

There is, of course, one person missing from the list of authors for this manuscript. It is Kenneth T. Whitby, the key person behind the ACHEX mobile laboratory and the entire ACHEX program. Without his leadership in developing the MAAS, this program would not have been organized. His career after ACHEX involved several additional atmospheric aerosol measurement programs (Sem & Whitby, 2000). He also worked on atmospheric aerosol modeling. His life ended much too early, at age 58, on November 14, 1983, when he suffered a heart attack. All four of the authors owe a great deal of credit to him for his inspirational leadership.

Acknowledgments

The authors gratefully acknowledge the advice of two anonymous peer reviewers whose suggestions greatly improved the quality of this paper. We sincerely appreciate their suggestions.

References

- Clark, W. E. (1973). Measurements of aerosol produced by the photochemical oxidation of sulphur-dioxide in air (Doctoral dissertation). Particle Technology Laboratory, University of Minnesota, Minneapolis.
- Ensor, D. S., & Covert, D. S. (2006, September 8–9). *Integrating nephelometry: coming of age*. Oral presentation at the Third Symposium on the History of Aerosol Science, Saint Paul, MN.
- Heintzenberg, J., & Charlson, R. J. (1996). Design and applications of the integrating nephelometer: A review. *Journal of Atmospheric and Oceanic Technology*, 13, 987–1000.
- Hidy, G. M. (1972). *Aerosols and atmospheric chemistry*. New York, NY: Academic Press.
- Hidy, G. M., Appel, B. R., Charlson, R. J., Clark, W. E., Covert, D. S., Friedlander, S. K., Giauque, R., Heisler, S. L., Ho, W., Huntzicker, J. J., Novakov, T., Richards, W., Ragaini, R. C., Smith, T. B., Sverdrup, G. M., Twiss, S., Waggoner, A. P., Wang, H. H., Wesolowski, J. J., Whitby, K. T., & White, W. H. (1974). *Characterization of Aerosols in California (ACHEX), Volumes I-IV* (Report SC524.2FR). Thousand Oaks, CA: California Air Resources Board, Science Center, Rockwell International.
- Hidy, G. M., Appel, B. R., Charlson, R. J., Clark, W. E., Ensor, D. S., Friedlander, S. K., Giauque, R., Green, S., Ho, W., Huntzicker, J. J., Husar, R. B., Lauer, G., Mueller, P. K., Novakov, T., Smith, T. B., Stephens, E. R., Wesolowski, J. J., & Whitby, K. T. (1973). *Characterization of aerosols in California, interim report for Phase I* (Report SC524.191R). Thousand Oaks, CA: California Air Resources Board, Science Center, Rockwell International.
- Hidy, G. M., & Mueller, P. K. (1980a). Executive summary. In G. M. Hidy, P. K. Mueller, D. Grosjean, B. R. Appel, & J. J. Wesolowski (Eds.), *The character and origins of smog aerosols* (pp. 1–15). New York, NY: John Wiley & Sons.
- Hidy, G. M., & Mueller, P. K. (1980b). Epilogue. In G. M. Hidy, P. K. Mueller, D. Grosjean, B. R. Appel, & J. J. Wesolowski (Eds.), *The character and origins of smog aerosols* (pp. 755–765). New York, NY: John Wiley & Sons.

- Husar, R. B. (1971). Coagulation of Knudsen aerosols (Doctoral dissertation). Particle Technology Laboratory, Mechanical Engineering Department, University of Minnesota, Minneapolis.
- Husar, R. B., Whitby, K. T., & Liu, B. Y. H. (1972). Physical mechanisms governing the dynamics of Los Angeles smog aerosol. In G. M. Hidy (Ed.), *Aerosols and atmospheric chemistry* (pp. 271–284). New York, NY: Academic Press.
- Lieberman, A. (2005). Optical particle counters: Then, now, and tomorrow. In G. J. Sem, D. Boulaud, P. Brimblecombe, D. S. Ensor, J. W. Gentry, J. C. M. Marijnissen, & O. Preining (Eds.), *History & reviews of aerosol science*. Mount Laurel, NJ: American Association for Aerosol Research.
- Liu, B. Y. H., Whitby, K. T., & Pui, D. Y. H. (1974). A portable electrical analyzer for size distribution measurement of submicron aerosols. *Journal of the Air Pollution Control Association*, 24, 1067–1072.
- Lundgren, D. A. (1972). Mass distribution data from the 1969 Pasadena smog experiment. In G. M. Hidy (Ed.), *Aerosols and atmospheric chemistry* (pp. 265–270). New York, NY: Academic Press.
- Lundgren, D. A. (1973). Mass distribution of large atmospheric particles (Doctoral dissertation). University of Minnesota, Minneapolis.
- McMurry, P. H. (2000). The history of condensation nucleus counters. *Aerosol Science and Technology*, 33, 297–322.
- Mueller, P. K. (2006, September 8–9). *How the Pasadena aerosol study and subsequent ACHEX started, survived and tested propositions still in vogue*. Some personal histories and analyses. Oral presentation at the Third Symposium on the History of Aerosol Science, St. Paul, MN.
- Sem, G. J., & Whitby, E. R. (2000). Kenneth Thomas Whitby: A pioneer of aerosol characterization. In O. Preining & E. J. Davis (Eds.), *History of aerosol science, Proceedings of the Symposium on the History of Aerosol Science, Vienna, Austria, August 31–September 2, 1999* (pp. 245–259). Wien: Verlag der Österreichischen Akademie der Wissenschaften.
- Sem, G. J., Whitby, K. T., & Sverdrup, G. M. (1980). Design, instrumentation, and operation of a large mobile air pollution laboratory for ACHEX. In G. M. Hidy, P. K. Mueller, D. Grosjean, B. R. Appel, & J. J. Wesolowski (Eds.), *The character and origins of smog aerosols* (pp. 55–68). New York, NY: John Wiley & Sons.

- Sverdrup, G. M. (1977). Parametric measurements of submicron atmospheric aerosol size distributions (Doctoral dissertation). Particle Technology Laboratory, University of Minnesota, Minneapolis.
- Sverdrup, G. M., & Whitby, K. T. (1980). The effect of changing relative humidity on aerosol size distribution measurements. In G. M. Hidy, P. K. Mueller, D. Grosjean, B. R. Appel, & J. J. Wesolowski (Eds.), *The character and origins of smog aerosols* (pp. 527–538). New York, NY: John Wiley & Sons.
- Sverdrup, G. M., Whitby, K. T., & Clark, W. E. (1975). Characterization of California aerosols—II. Aerosol size distribution measurements in the Mojave desert. *Atmospheric Environment*, 9, 483–494.
- Sverdrup, G. M., Whitby, K. T., & Clark, W. E. (1980). Appendix B: Aerosol size distribution measurements in the Mojave Desert. In G. M. Hidy, P. K. Mueller, D. Grosjean, B. R. Appel, & J. J. Wesolowski (Eds.), *The character and origins of smog aerosols* (pp. 523–525). New York, NY: John Wiley & Sons.
- Whitby, K. T. (1978). The physical characteristics of sulfur aerosols. *Atmospheric Environment*, 12, 135–159.
- Whitby, K. T., & Clark, W. E. (1966). Electrical aerosol particle counting and size distribution measuring system for the 0.015 to 1 μ size range. *Tellus*, 18, 573–586.
- Whitby, K. T., Clark, W. E., Marple, V. A., Sverdrup, G. M., Sem, G. J., Willeke, K., Liu, B. Y. H., & Pui, D. Y. H. (1975). Characterization of California aerosols—I. Size distributions of freeway aerosol. *Atmospheric Environment*, 9, 463–482.
- Whitby, K. T., Clark, W. E., Marple, V. A., Sverdrup, G. M., Sem, G. J., Willeke, K., Liu, B. Y. H., & Pui, D. Y. H. (1980). Appendix A: Size distribution of freeway aerosol. In G. M. Hidy, P. K. Mueller, D. Grosjean, B. R. Appel, & J. J. Wesolowski (Eds.), *The character and origins of smog aerosols* (pp. 519–521). New York, NY: John Wiley & Sons.
- Whitby, K. T., Husar, R. B., & Liu, B. Y. H. (1972a). The aerosol size distribution of Los Angeles smog. In G. M. Hidy (Ed.), *Aerosols and atmospheric chemistry* (pp. 237–264). New York: Academic Press.

- Whitby, K. T., Liu, B. Y. H., Husar, R. B., & Barsic, N. J. (1972b). The Minnesota aerosol-analyzing system used in the Los Angeles smog project. *Journal of Colloid & Interface Science*, 39, 136–164.
- Whitby, K. T., Liu, B. Y. H., Husar, R. B., & Barsic, N. J. (1972c). The Minnesota aerosol-analyzing system used in the Los Angeles smog project. In G. M. Hidy (Ed.), *Aerosols and atmospheric chemistry* (pp. 189–217). New York, NY: Academic Press.
- Whitby, K. T., & Sverdrup, G. M. (1980). California aerosols: their physical and chemical characteristics. In G. M. Hidy, P. K. Mueller, D. Grosjean, B. R. Appel, & J. J. Wesolowski (Eds.), *The character and origins of smog aerosols* (pp. 477–517). New York, NY: John Wiley & Sons.
- Wilson, W. E., Spiller, L. L., Ellestad, T. G., Lamothe, P. J., Dzubay, T. G., Stevens, R. K., Macias, E. S., Fletcher, R. A., Husar, J. D., Husar, R. B., Whitby, K. T., Kittelson, D. B., & Cantrell, B. K. (1977). General Motors sulfate dispersion experiment: Summary of EPA measurements. *Journal of the Air Pollution Control Association*, 27, 46–51.
- Wolf, J. L. (1978). Design, construction and operation of a mobile air pollution laboratory (Master's thesis). Particle Technology Laboratory, University of Minnesota, Minneapolis.
- Zinky, W. R. (1962). The aerosol particle counter. *Journal of the Air Pollution Control Association*, 12, 578–583.

Measurements of the Three-Dimensional Distribution and Transport of Aerosols

Precedents Set by the Three-Dimensional Pollutant Gradient Study in Cooperation with ACHEX

Donald L. Blumenthal

Introduction

A team of researchers conducted the Three-Dimensional Pollutant Gradient Study (3-D Study) in 1972 and 1973, in cooperation with the California Aerosol Characterization Experiment (ACHEX). The ACHEX-related studies were the first intensive, large-scale, integrated (e.g., chemistry, aerosol, and meteorology; surface and upper-air) project to address the evolution of regional air pollution. The 3-D Study included extensive measurements of air pollution distribution and transport in California, primarily in the South Coast (“Los Angeles”) Air Basin (SoCAB), using two light aircraft, a van, and weather balloons. This chapter describes the study context, design, key results, and precedents derived from the 3-D Study.

In the early 1970s, the most obvious manifestations of air pollution in the SoCAB were poor visibility, severe eye irritation, and breathing impairment during smog episodes. During bad smog episodes, visibility was reduced to below 5 km (3 statute miles, a threshold requiring instrument flight rules for aircraft); the light scattering coefficient (b_{scat}) was more than $1,000 \text{ Mm}^{-1}$; the 2-hour particulate mass exceeded $300 \mu\text{g}/\text{m}^3$ (White & Roberts, 1977); and ozone concentrations exceeded 500 ppb. Figure 1 shows an example of pollutants trapped below a temperature inversion in the SoCAB and the resulting poor visibility conditions present in the mixing layer. At the time, researchers did not understand the causes of the high particulate matter (PM) concentrations and poor visibility in the SoCAB. Ozone and PM issues were believed to be local problems, resulting primarily from nearby emissions.



Figure 1. Pollutant aerosol (not fog) trapped below the inversion, eastern Los Angeles Basin, September 26, 1972.

Photo: Courtesy of the author.

To address California's air pollution issues, the California legislature passed the Mulford-Carrell Act in 1967, which established the California Air Resources Board (CARB). In addition, the US government enacted the Clean Air Act in 1970 to set forth regulatory air quality legislation for the nation, and the US Environmental Protection Agency was created in 1971 to implement the various requirements in the Act. These actions and the organization of the first Earth Day on April 22, 1970, advanced the public's awareness of air pollution issues and created a demand for improvement. The severity of the nation's air quality problems and the public's overwhelming support for action resulted in substantial funding becoming available for new research on air pollution causes and solutions.

In 1969, several investigators got together in an informal collaboration to study aerosols and visibility in the SoCAB. This pioneering study became known as the Pasadena Smog Experiment (Hidy, 1972, 2011). CARB later used the cooperative infrastructure of the Pasadena experiments as the basis for the much larger and more formal ACHEX group of studies (Hidy et al., 1980; Hidy, 2011). These studies showed the power and necessity of comprehensive integrated measurements to explain regional pollutant phenomena.

From the 1969 Pasadena experiment and other work done in the 1960s, it was clear that the emission, formation, and transport of aerosols in the SoCAB were elements of a complex problem. The concentrations, composition, and size distribution of aerosols varied temporally and spatially (both horizontally and vertically), and it was becoming evident that the evolution of pollutant concentrations at any site could be affected by transport as well as chemistry. Air quality study results indicated that (1) there were layers of pollutants aloft from unknown origins; (2) the mixing layer structure was more complex than typically assumed in models (Edinger et al., 1972; Edinger, 1973); (3) pollutant concentrations were dependent on both chemistry and meteorology (e.g., diffusion, transport, mixing heights); and (4) simulation models that accounted for both meteorology and chemistry would be needed for use in developing control strategies (Seinfeld et al., 1972).

Although the scientific community was beginning to understand the importance of pollutant transport and the regional nature of the problem, the regulatory structure still considered air pollution a local issue. As a result, four air pollution control districts (APCDs) in the SoCAB concurrently and independently were trying to control pollutants without an understanding of the transport phenomena. For example, the Los Angeles APCD contended that Los Angeles emissions did not significantly affect concentrations in (downwind) Riverside County.

CARB realized that an understanding of the interaction of meteorology and chemistry was needed to understand the evolution of pollutant concentrations in the SoCAB and that knowledge of horizontal and vertical transport would be necessary to determine which sources affected which receptors and to develop control strategies. Although some investigators had performed measurements aloft, most air quality observations had been confined to the surface. Thus, in cooperation with ACHEx, CARB sponsored the 3-D Study to document the three-dimensional distribution and transport of pollutants in California's South Coast, San Joaquin Valley (SJV), and San Francisco air basins and to help identify the role of three-dimensional transport in the evolution of aerosol (and ozone) concentrations at ground-level measurement sites. This research, which took place in the summer and early fall of 1972 and 1973 and focused mainly on the SoCAB, advanced the understanding of the evolution of ozone, as well as aerosol concentrations.

Study Design—Influences, Insights, Rationale

The 3-D Study was groundbreaking in its design and results; however, its success was dependent on a confluence of factors. To perform the upper-air measurements, the study required that light aircraft fly complex flight plans in the SoCAB among busy air traffic in poor visibility. This required a team that understood the aircraft and air traffic control requirements and limitations, as well as the science and instrumentation used in the study.

Although there were no incumbent experts at the time, Meteorology Research, Inc. (MRI), located in Pasadena, California, had extensive experience instrumenting aircraft for diffusion, vortex wake, and weather modification studies. In addition, MRI had recently developed instrumentation to make meteorological measurements onboard aircraft and had started manufacturing Integrating Nephelometers under license from Professor Robert Charlson at the University of Washington in Seattle. MRI also was peripherally involved in the 1969 Pasadena experiment, making cloud condensation nuclei measurements.

Through a competitive process, MRI was awarded the contract and led the study, with assistance from the US Naval Weapons Center (USNWC) at China Lake, California. The USNWC was interested in learning more about the effects of air pollutants on visibility in their test range in the Owens Valley north of Los Angeles, and they offered use of an aircraft and some staff at low cost to the study.

Although new to the burgeoning environmental field and to MRI, the author had personal experience in the SoCAB as a pilot and flight instructor and was familiar with light-aircraft capabilities and limitations, air traffic control requirements, and the operational problems of flying in the limited visibility conditions of the SoCAB.

In addition to an experienced research team, the study needed instrumentation that had adequate time response for aircraft operations and that was lightweight and required low power. Data loggers and computers also were needed to record and process the massive amount of data obtained.

In the early 1970s, new instruments became commercially available to make the required measurements; most of these instruments were among the first off the production lines. A small data logger was developed for the study of cloud physics; lightweight power inverters were available to run 110 V AC instruments from 24 V DC aircraft power; and affordable minicomputers

became available that could support the extensive data processing and display requirements.

MRI operated one aircraft (a Cessna 205, Figure 2) and weather balloons for the study, and the USNWC provided a separate aircraft (a Cessna 310) and an air quality monitoring van. Both aircraft measured b_{scat} , condensation nuclei count (CN), ozone (O_3), nitrogen oxides (NO_x), carbon monoxide (CO), sulfur dioxide (SO_2), temperature, humidity, turbulence, altitude, and approximate position. The van measured b_{scat} , CN, O_3 , NO_x , CO, SO_2 , temperature, humidity, and winds. Data for both aircraft and van measurements were recorded once per second (see Blumenthal et al., 1974; Blumenthal et al., 1978).



(A) In flight



(B) Sampling inlets

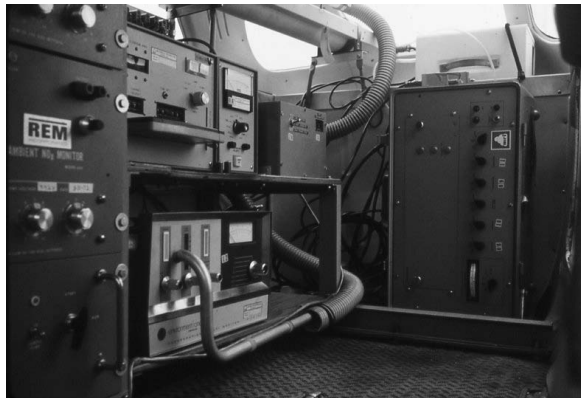

(C) Instrumentation

Figure 2. MRI instrumented Cessna 205, 1973.

Photo: Courtesy of the author.

Although at the time mini computers had recently become available, software had not. Software for data processing and analysis for both the aircraft measurements and the ACHEX surface measurements had to be developed from scratch. The software tools developed were crude but effective, although hand-drawn maps and plots were still required. Figures presented later in this chapter are representative of the state of the art at the time of the 3-D Study.

The research team conducted a total of 241 sampling flights over 59 days with the two aircraft. We coordinated the aircraft measurements with ACHEX-related studies in the San Francisco Bay Area, the SJV, and the SoCAB, conducting flights in the San Francisco Bay area and the SJV in the summer of 1972, and in the SoCAB in summer and fall of both 1972 and 1973. When possible, we coordinated flights with the ACHEX/University of Minnesota mobile aerosol laboratory measurements (Sem et al., 2011). Several flights were made to support ACHEX-related fluorescent-particle tracer studies in the SoCAB (Vaughn & Stankunas, 1974). The USNWC van made continuous measurements at strategic airport locations along the flight routes on most flight days.

The design of the 3-D Study was based on several insights. From some initial flights and analyses, the research team recognized that the strongest gradients across the SoCAB were vertical and often greatest near the surface and that there were substantial spatial gradients across the Basin. Coming from a meteorological perspective, we knew that transport was affected by the sea breeze, which started in midday and could carry pollutants that accumulated in source areas far downwind. As a result, surface pollutant concentrations were affected by both reactions and transport. It was evident that we needed to document the meteorology and to sample along trajectories to detect the evolution of the concentrations with time. Yet, the haze in the SoCAB made visual navigation difficult, and point-to-point radio navigation was not yet readily available; so repeated horizontal flights along a trajectory in the haze below the mixing height would be difficult and not very safe. Also, although it would have been useful to follow air parcel trajectories in a Lagrangian approach, we had no way of knowing the daily trajectories in advance.

In prior studies, airborne measurements typically involved horizontal flights or gradual climbs and descents. These types of patterns made it hard to distinguish horizontal from vertical gradients. Also, these patterns generally

were not repeated, making it difficult to establish the representativeness of the study data. These airborne measurements also often did not show the elevation of the mixed layer and how concentrations differed above and below the trapping inversions. In addition, although aloft pollutant layers had been detected (Edinger et al., 1972; Edinger, 1973), their origins and extent were not well understood.

For this study, flight plans had to be designed to address the insights and issues discussed above. In addition, our operations had to minimize interference with ATC. Measurements needed to be made near surface measurement sites if possible for comparison purposes. A sufficient variety of measurements was needed to distinguish the characteristics of air masses of different ages or origins. The flight data had to be displayable in an understandable fashion. The data from so many flights also had to be averaged in some way so that they could be interpreted by scientists.

To address these challenges, the research team developed the “spiral” flight pattern and the concept of the “vertical profile,” allowing us to plot together numerous parameters versus height. The spirals involved a helical descent or ascent over an airport, allowing measurements from above the mixed layer to the surface. Because the SoCAB has numerous well-spaced airports, we recognized that we could do an Eulerian experiment and document the evolution of the spatial distribution over time throughout the SoCAB. By repeating spirals in the same locations several times a day, day after day, we would be able to assess, after the fact, the evolution of the spatial pollutant distribution and of concentrations along trajectories (calculated from surface and upper-air wind data) and explore the differences (and similarities) in concentrations under different meteorological conditions.

Using this flight pattern, we could measure the near-surface gradients, identify the top of the mixed layer, and characterize the differences in composition above and below the mixing height. The vertical profiles from the spirals were easy to interpret and could later be averaged to show the representativeness of various characteristics.

Spirals were made at about 14 locations, three times per day. There were three standard flight routes in the SoCAB, two of which were used on any given day. This strategy allowed us to document the spatial and temporal evolution of the 3-D distribution of pollutants over most of the SoCAB. Figure 3 shows a schematic of a spiral flight pattern and the sampling routes for July 25, 1973, the only day that federal offices have ever been closed for an air pollution episode.

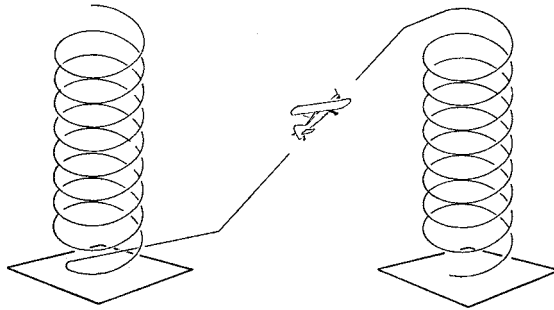

(A) Schematic of the spirals

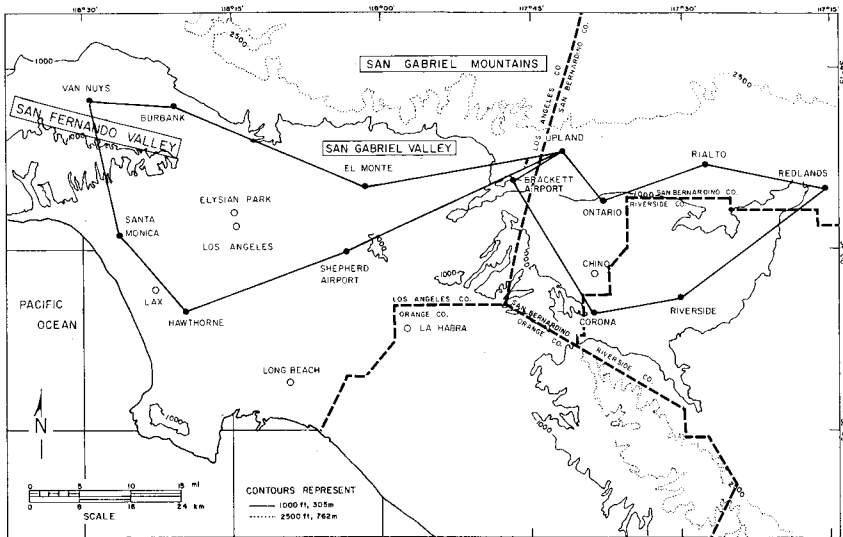

(B) Spiral locations for the two aircraft on July 25, 1973

Figure 3. 3-D gradient study flight patterns.

Source: Blumenthal et al. (1978). Reprinted with permission from Elsevier.

Because most data were obtained in spirals over airports, aircraft could travel between airports at higher elevations, where navigation signals were receivable, visibility was better, and the mountains served as visual references. During smog episodes, pilots had difficulty seeing airports until the aircraft were directly above them. The spirals allowed time for a pilot to work with ATC at each airport while the aircraft was descending, as well as allowed for flexibility in routing between airports to accommodate air traffic control.

We conducted pilot-balloon upper-air wind measurements in conjunction with aircraft spirals to measure the pollutant fluxes in the mixed layer and document the transport between political jurisdictions (e.g., counties). By measuring b_{scat} and CN and the primary and secondary pollutant gases, we were able to distinguish the air masses with fresh emissions from those that had aged.

The van typically made continuous measurements at an airport along the flight route to provide a temporal context for the instantaneous flight data and to show the temporal representativeness of the aircraft measurements.

Results

Detailed analyses of the 3-D Study data from the July 24–26, 1973, pollutant episode illuminated the general characteristics of the SoCAB episodes of the time (Blumenthal et al., 1974; Blumenthal et al., 1978; Hidy et al., 1980; Husar et al., 1977). From these analyses, it was clear that emissions accumulated in the urban/industrial areas of the western SoCAB in the night and morning hours and were subsequently transported with the sea breeze to the more rural, eastern areas of the SoCAB in the afternoon. The emissions reacted to form ozone and secondary aerosol en route. We observed the highest ozone concentrations of the day in two areas: (1) just above the marine layer in stagnant air decoupled from the surface after passage of the sea breeze and (2) just ahead of the sea breeze front in photochemically aged air that was transported into low emission-density areas. Maximum PM usually occurred in air that accumulated both auto emissions and sulfur-containing point-source emissions and was exposed to high relative humidity. These characteristics are evident in Figures 4 and 5, excerpted from Blumenthal et al. (1978).

Figure 4 shows the horizontal and vertical distribution of ozone in midday and in the late afternoon on July 25, 1973. In midday, ozone concentrations were highest in the northern part of the western SoCAB. By afternoon, the

(A1 and A2) Surface ozone concentrations at 1300–1400 and 1600–1700 PDT and wind streamlines at 1300 and 1600 PDT

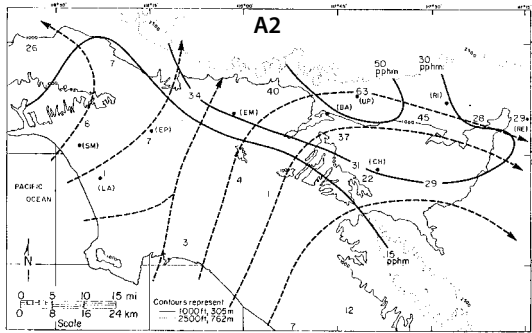
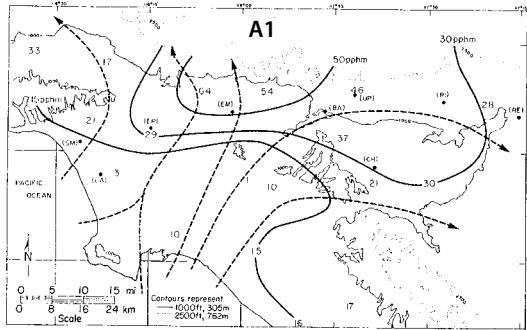

(B1 and B2) Vertical ozone cross-section and winds at 1245–1500 and 1630–1830 PDT; wind speeds are proportional to the arrow lengths

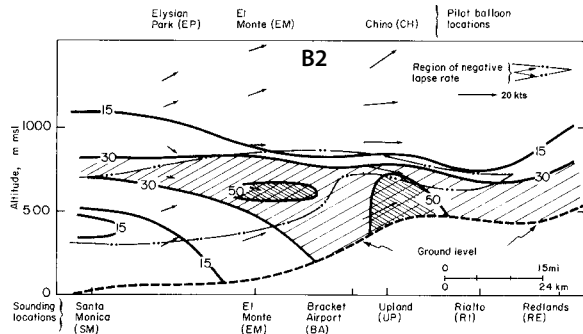
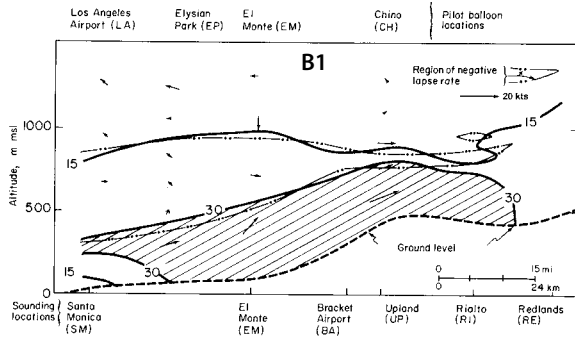
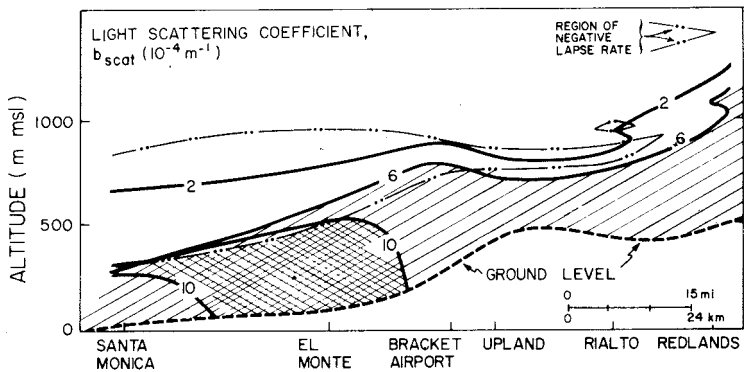

Figure 4. Ozone distribution (pphm) midday (A1 and B1) and afternoon (A2 and B2) on July 25, 1973.

Source: Blumenthal et al. (1978). Reprinted with permission from Elsevier.

peak ozone had been transported eastward to Upland, California. The vertical cross-sections in the lower panels show the midday accumulation in the western SoCAB and also the afternoon transport eastward. Undercutting by the sea breeze is evident in the afternoon, with high concentrations of ozone remaining aloft in the stable region below the subsidence inversion. Similar effects are seen in Figure 5, which shows the b_{scat} for the same vertical cross-sections as in Figure 4. Note that the peak ozone concentrations were over 500 ppb (shown as 50 pphm) and the high aerosol concentrations resulted in b_{scat} greater than 1000 Mm^{-1} (shown as $10 \times 10^{-4} \text{ m}^{-1}$). This level of b_{scat} was roughly equivalent to aerosol total mass of over $300 \mu\text{g}/\text{m}^3$ (White & Roberts, 1977).



(A) Midday, July 25, 1973

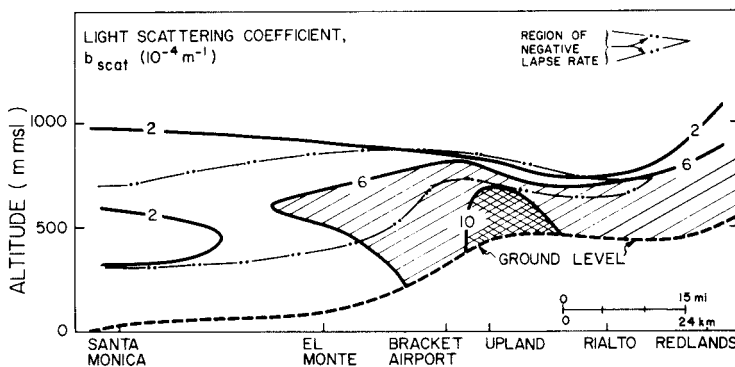

(B) Afternoon, July 25, 1973

Figure 5. b_{scat} vertical cross-sections.

Source: Blumenthal et al. (1978).

Reprinted with permission from Elsevier.

The difference between the aged pollution aloft and the fresh emissions near the surface is evident in Figure 6, which shows data from the afternoon spiral over El Monte Airport. (Data from the same spiral are included in Figures 4b and 5b.) In the aged air in the aloft layer, high amounts of the secondary pollutants, b_{scat} (over 1000 Mm^{-1}), and ozone (about 450 ppb) remained. In the surface air, which had been scrubbed by the sea breeze, the secondary pollutant concentrations were much lower, but the CN count, which is representative of fresh combustion emissions, was much greater. Aloft, the CN had been scavenged by the accumulation-mode aerosol (represented by b_{scat}). Carbon monoxide, which is basically a conservative primary pollutant, can be seen in both the aloft and surface layers at similar concentrations.

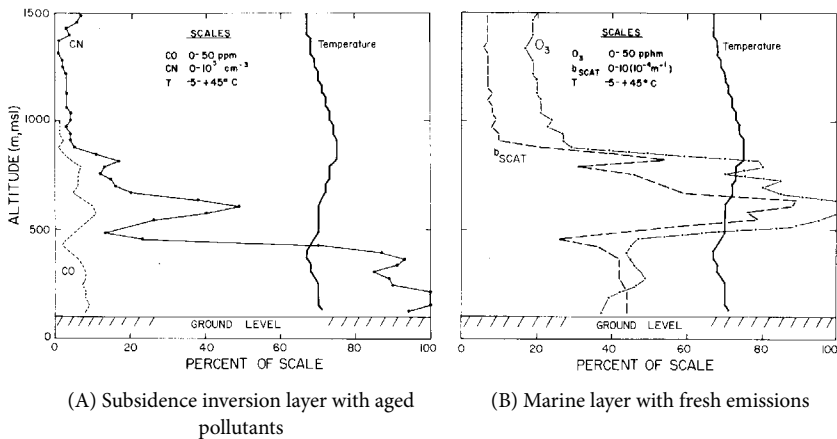

Figure 6. Vertical profile over El Monte Airport, ending 1656 PDT on July 25, 1973. Spiral made just after the passage of the marine front, showing strong undercutting of aged air. Air in the surface mixed layer was of recent marine origin; air above had been over land much of the day.

Source: Blumenthal et al. (1978). Reprinted with permission from Elsevier.

The accumulation of emissions in the western SoCAB and the subsequent transport eastward was confirmed by trajectory analysis using upper-air wind data from pilot balloons. Figure 7 shows a trajectory envelope for air arriving in Upland at 1600 PST, the time of maximum ozone concentration in Figure 4A. The envelope was calculated from the range of wind directions and speeds measured within the mixing layer. It is evident from Figure 7 that the air with the peak ozone concentrations in Upland had stagnated over central Los Angeles through midday and then was carried east with the sea breeze.

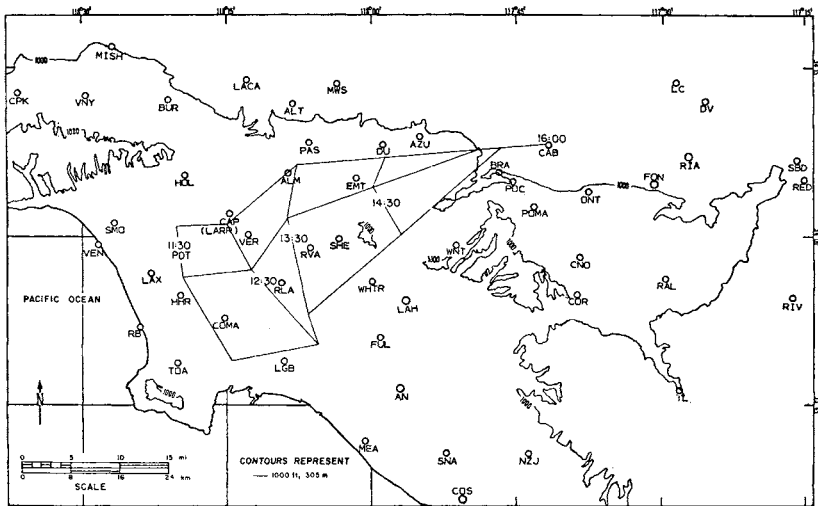

Figure 7. Trajectory envelope arriving at Upland (Cable Airport, CAB) at 1600 PDT on July 25, 1973.

Source: Blumenthal et al. (1980). Reprinted with permission from Elsevier.

Although the ozone peak in Upland was higher, Figure 4 shows ozone concentrations of roughly 200–400+ ppb over much of the eastern SoCAB in the late afternoon. Trajectory envelope calculations similar to those shown in Figure 7 indicate that air arriving in most of the eastern SoCAB in the late afternoon originated in the central and southern parts of the western SoCAB in midday. Flux calculations were made using aircraft spiral and traverse data between the Bracket and Corona airports (Figure 3) and upper-air wind data from Chino to calculate the ozone transported from the western SoCAB to the eastern SoCAB. These calculations showed that, in late afternoon, sufficient ozone was transported within the mixing layer from the western Basin to the eastern Basin in one hour to fill the eastern Basin to 250 ppb (Blumenthal et

al., 1978; Blumenthal et al., 1980). This calculation was among the first solid evidence that emissions in the western Basin could cause exceedances of the then-existing 80-ppb, 1-hour ozone standard in the eastern Basin.

Another factor that contributes to high pollutant concentrations is the entrainment of pollutants carried over aloft from the prior day. Figure 8 from Blumenthal et al. (1980) shows data from a morning spiral over Ontario in the eastern SoCAB. This figure shows the complexity and multi-day nature of the entrainment problem. It includes a surface layer with fresh emissions, a point-source plume trapped in a stable layer, and a higher stable layer isolated from surface emissions with about 250 ppb of ozone from the prior day. These elevated layers are available to be entrained as the mixing layer rises and can contribute to the rapid build up of surface concentrations.

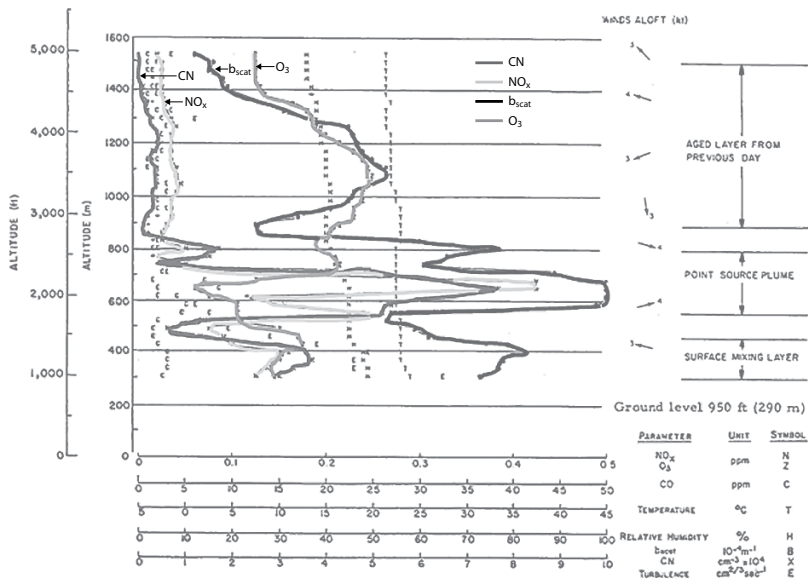

Figure 8. Ontario vertical profile at 0952 PDT on July 26, 1973.

Source: Blumenthal et al. (1980). Reprinted with permission from George Hidy.

Although the data shown here are from one episode, certain phenomena on episode days were so characteristic that they survived averaging over numerous episodes. Husar et al. (1977) prepared grand average profiles for 24 episode days for spirals over the cities of Hawthorne (coastal), El Monte (north-central SoCAB), Ontario (eastern SoCAB), and Riverside (eastern SoCAB downwind receptor area). Comparison of early-morning and

afternoon average profiles showed the erosion of the nighttime radiation inversion at all locations, increased temperatures and more intense mixing in the inland areas, and a semi-permanent subsidence inversion covering the whole SoCAB at higher altitudes. Comparison of the air quality parameters showed high values of the primary emissions (NO_x and CN) near the coast (Hawthorne) and high values of secondary pollutants (ozone and b_{scat}) inland at Riverside. Ozone values aloft in the early morning at all sites were substantially higher than at the surface, with the aloft averages for all inland sites peaking above 120 ppb, indicating that overnight carryover of ozone aloft was a common occurrence.

The results of the 3-D Study are presented in Blumenthal et al. (1974), Blumenthal et al. (1978), Blumenthal et al. (1980), and Husar et al. (1977). Hidy et al. (1980) presents an extensive digest of the background and results of both ACHEX and the 3-D Study, with contributions by all the investigators.

Precedents

The 3-D Study greatly improved our understanding of the transport processes in the SoCAB and the effects of three-dimensional transport on surface pollutant concentrations. We were able to show that air pollution is a regional, multi-day problem. In ACHEX, there was extensive carryover from day to day of both aerosol and ozone in aloft layers, and this carryover affected next-day surface concentrations. We were also able to identify mechanisms controlling the evolution of the aloft layers.

The 3-D Study demonstrated that air moves: emissions in upwind urban areas can cause exceedances of standards in far downwind areas. These results provided overwhelming evidence that the SoCAB should be considered a single air basin for regulatory purposes, and helped establish the scientific basis to require the consolidation of the SoCAB's four independent APCDs into the South Coast Air Quality Management District.

The 3-D Study showed the effects of transport, sea-breeze undercutting, and downmixing of elevated aged pollutants on the evolution of surface concentrations. These results also showed that the diurnal changes of surface concentrations cannot be explained through chemistry alone, or by considering only surface concentrations and surface winds.

Repeated measurements from the coast inland showed the aging of the air mass (i.e., the increase in secondary aerosol and ozone) as polluted air ahead of the sea-breeze front moved inland, and documented the inland

concentrations that remained aloft overnight. These key characteristics were so pervasive that they survived averaging over 24 days of the 1973 sampling season.

The study also demonstrated that clean-air background ozone throughout California was about 40–50 ppb. As part of the 3-D Study, measurements were made in plumes, and flight patterns were developed to document pollutant transformations and fluxes, as well as plume location and concentrations (Blumenthal et al., 1974).

The measurement techniques and flight patterns developed for the 3-D Study proved to be operationally efficient and provided the basis for numerous future regional and plume studies throughout the United States. Modern-day researchers still use aircraft to measure urban and point-source plume transport, transformations, and fluxes, and use spirals to document the vertical distribution, carryover, mixing height, and upwind or aloft background conditions.

It is now recognized that aloft air quality and meteorological data are essential for model input and evaluation. The 3-D Study showed the importance of documenting the carryover, mixing height, and vertical distribution to constrain and evaluate models and to ensure that models get the right answers for the right reasons. The analyses performed in the ACHEX-related studies provided a conceptual model of the physical and chemical processes leading to high pollutant concentrations. Such conceptual models have become useful to constrain the inputs and assumptions of grid models and to assess whether grid models provide realistic and accurate simulations.

The ACHEX-related studies showed that large-scale integrated studies are needed to understand regional pollutant evolution and to support air quality models. The author has subsequently been involved in dozens of similar urban, regional, and point-source plume studies throughout the United States, addressing aerosol, ozone, and visibility issues. Such studies have become the standard for addressing regional problems. These studies are generally motivated by policy concerns rather than basic-science reasons; thus, they are most useful to the sponsors when they yield easy to understand policy-relevant results (e.g., the flux-plane results from the 3-D Study.)

Acknowledgments

The Three-Dimensional Pollutant Gradient Study was a team effort among numerous investigators and staff from MRI, the USNWC at China Lake, and the California Institute of Technology (Caltech). The main participants included Donald Blumenthal, Theodore Smith, David Ensor, Warren White, Stuart Muller, Stanley Marsh, and Pamela McMurry from MRI; Paul Owens and Raymond Kelso from the USNWC at China Lake; and Rudolf Husar and Paul Roberts from Caltech.

The 3-D Study was sponsored by the California Air Resources Board.

Many thanks are due to Dr. Theodore Smith for his sound advice, mentoring, and patience throughout the 3-D Study and for many years afterward.

References

- Blumenthal, D. L., Smith, T. B., White, W. H., Marsh, S. L., Ensor, D. S., Husar, R. B., . . . Owens, P. (1974). Three-dimensional pollutant gradient study—1972–1973 program (NTIS PB 241982/66). Report prepared for the California Air Resources Board, Sacramento, CA, by Meteorology Research Inc., Altadena, CA, MRI 74 FR 1262.
- Blumenthal, D. L., Smith, T. B., & White, W. H. (1978). Anatomy of a Los Angeles smog episode: pollutant transport in the daytime sea breeze regime. *Atmospheric Environment*, *12*, 893–907. Retrieved from <http://www.sciencedirect.com>.
- Blumenthal, D. L., Smith, T. B., & White, W. H. (1980). The evolution of the 3-D distribution of air pollutants during a Los Angeles smog episode: July 24–26, 1973. In G. M. Hidy, P. K. Mueller, D. Grosjean, B. R. Appel, & J. J. Wesolowski (Eds.), *The character and origins of smog aerosols* (pp. 613–650). New York, NY: Wiley-Interscience.
- Edinger, J. G., McCutshan, M. H., Miller, P. R., Ryan, B. C., Schroeder, M. J., & Behar, J. V. (1972). Penetration and duration of oxidant air pollution in the South Coast air basin of California. *Journal of the Air Pollution Control Association*, *22*, 882–886. Retrieved from <http://www.researchgate.net>.
- Edinger, J. G. (1973). Vertical distribution of photochemical smog in the Los Angeles basin. *Environmental Science and Technology*, *7*, 247–252. doi: 10.1021/es60075a004.

- Hidy, G. M. (Ed.) (1972). *Aerosols and atmospheric chemistry. Part III: The 1969 Pasadena smog aerosol experiment*, (pp. 189–332). New York, NY: Academic Press.
- Hidy, G. M. (2011). Reminiscences about Pasadena, ACHEX, and beyond. In David S. Ensor (Ed.), *Aerosol Science and Technology: History and Reviews* (Chapter 8). Research Triangle Park, NC: RTI Press.
- Hidy, G. M., Mueller, P. K., Grosjean, D., Appel, B. R., & Wesolowski, J. J. (Eds.). (1980). The character and origins of smog aerosol (Volume 9). *Advances in Environmental Science and Technology*. New York, NY: Wiley-Interscience.
- Husar, R. B., Patterson, D. E., Blumenthal, D. L., White, W. H., & Smith, T. B. (1977). Three-dimensional distribution of air pollutants in the Los Angeles basin. *Journal of Applied Meteorology*, 16, 1089–1096. Retrieved from <http://journals.ametsoc.org>.
- Seinfeld, J. H., Reynolds, S. D., & Roth, P. M. (1972). Simulation of urban air pollution. In R. F. Gould (Ed.), *Photochemical smog and ozone reactions, advances in chemistry series 113* (pp. 58–100). Washington, DC: American Chemical Society.
- Sem, G. J., Clark, W. E., Sverdrup, G. M., & Marple, V. A. (2011). Memories and legacy of the ACHEX Mobile Semitrailer Air Pollution Laboratory. In David S. Ensor (Ed.), *Aerosol Science and Technology: History and Reviews* (Chapter 9). Research Triangle Park, NC: RTI Press.
- Vaughn, L. M., & Stankunas, A. R. (1974). *Field study of air pollution transport in the South Coast air basin* (Technical Report No. 197). Report prepared for the California Air Resources Board, Sacramento, CA, by Metronics Associates, Inc., Palo Alto, CA.
- White, W. H., & Roberts, P. T. (1977). On the nature and origin of visibility reducing aerosols in the Los Angeles Air Basin. *Atmospheric Environment* 11, 803–812. doi: 10.1016/0004-6981(77)90042-7.

PART IV

Military Applications and
Nuclear Aerosols

Aerosol Wars

A Short History of Defensive and Offensive Military Applications, Advances, and Challenges

Arthur K. Stuempfle

Introduction

The generation of particulate and liquid aerosols is an inevitable result of military operations during both peacetime and wartime. Matter can become airborne through the inadvertent creation of particulates by re-aerosolizing dust and dirt particles such as that caused by a helicopter downwash, the residue of propellant smokes or explosive bursts from artillery munitions, or any number of other means. Even more ominous is the deliberate or unintentional dispersion in aerosol form of liquid or solid chemical compounds, biological agents, or radioactive materials.

Military aerosols of all types are integral elements in every aspect of chemical warfare defense and can pose a serious threat to Soldiers and civilians during military operations. Aerosolized materials must be taken into account when planning and preparing an effective defense against chemical and biological materials. Chemical warfare defense and research efforts require an understanding of a wide range of interrelated topics where aerosols are involved. These topics include

- chemical weaponry,
- detection technology,
- respiratory and body protection,
- decontamination processes,
- prophylaxis and treatment,
- restoration and recovery,
- atmospheric transport modeling and prediction,
- indoor air quality, and
- operations research.

Other areas falling within the general arena of chemical warfare defense include the development and use of obscurants, defoliants, and riot control agents.

Entire chapters could be written on the history of each of these elements as they pertain to the corresponding aerosol science. However, this chapter presents only brief overviews of some important advances made in aerosol science as viewed from the military perspective on chemical warfare defense and offense. The primary elements discussed here are obscurants, chemical weaponry, respiratory protection, and atmospheric transport modeling and prediction, as well as how pre-1982 military sponsorship of aerosol science conferences contributed to the formation of the American Association for Aerosol Research (AAAR).

Discussion

Obscurants

Smokes and obscurants are considered force multipliers on the battlefield. An informative talk by Chris Noble at the 2006 International Aerosol Conference outlined the development of military smokes and obscurants and described how smokes have been used to obscure the battlefield and prevent target acquisition (Noble, 2011). An example of a successful use of smoke in a military operation is one conducted by Charles XII (1682–1718), the King of Sweden from 1697 to 1718 and a highly capable military general. In 1701, he used smoke aerosols generated by burning wet hay and straw to aid a river-bridge crossing (Figure 1).

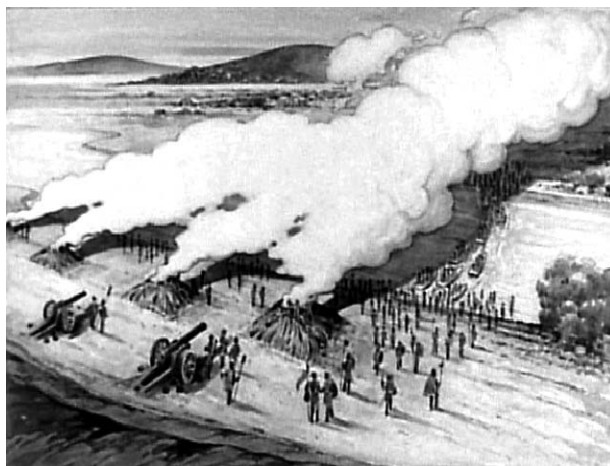

Figure 1. Obscuring smoke river crossing—1701.

Photo: Courtesy of US Army Chemical Biological Defense Command Historical Research and Response Team, Aberdeen Proving Ground, MD.

Although Carl von Clausewitz (1780–1831) never specifically used the words “fog of war” (circa 1827), the concept of how weather and smoke clouds on the battlefield can deceive the eye and result in general confusion is indicative of the role that military aerosols play in defensive and offensive operations (von Clausewitz, 1976).

Smokes have been used to screen ongoing military activities and operations and can be employed as smoke screens or smoke blankets. Properly delivered, visual smoke curtains can obscure large areas and distances such as the New York City skyline (Figure 2A). Placing multiple numbers of fog oil smoke generators along a line can blanket a large area, resulting in reduced visibility (Figure 2B). Colored smokes can also be used for signaling purposes as demonstrated at Fort McClellan, Alabama, in 1963 (Figure 3A).



(A) Aircraft-generated smoke curtain—New York City, 1924



(B) Fog oil smoke generator

Figure 2. Smoke generation methods.

Photos: Courtesy of US Army Chemical and Biological Defense Command Historical Research and Response Team, Aberdeen Proving Ground, MD.



(A) Signaling smokes—1963

(B) Smoke curtain—1963

Figure 3. Uses of smoke.

Photos: Courtesy of the author.

In some cases, smokes can produce collateral effects as well. During a smoke training exercise near the Black Hills National Forest area in 1998, the 300th Chemical Company provided smoke coverage in support of a medium girder bridge company. The smoke operation was conducted on an open, private ranch. About 1½ hours into the 3½-hour operation, approximately 100 head of cattle appeared and contently grazed inside the smoke cloud. Apparently, the smoke either provided pleasing shade and a cooling effect, or shielded the animals from harassing flies.

Some of the earlier effective smoke screens used FS (sulfur trioxide dissolved in chlorosulfonic acid), which was developed between 1929 and 1930. FS produces an intense white cloud when aerosolized. Unfortunately, when FS reacts with atmospheric moisture, sulfuric acid and hydrochloric acid drops are formed, which can be quite detrimental to materials such as nylon. In another example of collateral effects during a live fire demonstration, FS smoke was released from an aircraft spray tank to establish a smoke curtain, similar to that shown in Figure 3B. Suddenly, the winds shifted, sending the acidic smoke over the viewing stands where the VIPs were seated. The ladies of the audience did not appreciate the holes that were caused in their stockings.

More recently, as a consequence of laser technology, it was determined that infrared (IR) screening smokes were needed. The development of such obscurants to counter IR guidance and target acquisition systems required intense research into the fundamental properties of aerosols and electromagnetic wave propagation processes. Smoke screens played a significant role on the mobile battlefield during the 1967 Yom Kippur War between Israel and several Arab countries. Those experiences contributed to

an initiative in the early 1970s by the US Army Materiel Command (AMC) to bring together a team of scientists and engineers to form a Smoke Task Force. The objectives of the Smoke Task Force were twofold: to devise methods to quickly deploy a smoke screen around armored vehicles, and to develop advanced smokes that could counter laser-guided munitions. The efforts were headed by personnel at the Chemical Systems Laboratory located in Edgewood, Maryland. Theoretical studies at Edgewood by the Obscuration Sciences Branch of the Physics Division led to the successful demonstration of an effective IR countermeasure (Embury, 2002a, 2002b, 2004; Embury et al., 1993, 1994a, 1994b). This countermeasure came about through a change in the geometry of the obscurant material and by making it a conductive substrate rather than a dielectric. However, the desire to produce a one-way obscuring smoke or make an object totally invisible may be beyond the reach of practicability even with the future development of metamaterials (Boyle, 2006).

Chemical Weaponry

The weaponization of chemicals to achieve military objectives dates back to as early as 1000 B.C. when arsenical smokes were used by the Chinese. The history of chemical warfare and an excellent overview of weapons development from the decades following World War I (WWI) to the present have been documented by Jeff Smart, Command Historian of the US Army Research, Development and Engineering Command (RDECOM), Aberdeen Proving Ground, Maryland (Smart, 1997).

An appreciation of chemical and biological defense research must begin with an understanding of the threat that such compounds present to soldiers and must take into account today's potential terrorism threats to unprotected civilians and first responders.

The possibilities of using toxic materials on the battlefield were considered well before the 16th century when Leonardo da Vinci (1452–1519) suggested an offensive use of toxic materials against war ships (McCurdy, 1977). Da Vinci proposed the following, “Throw poison in the form of powder upon galleys. Chalk, fine sulfide of arsenic, and powdered verdegriis may be thrown among enemy ships by means of small mangonels. And all those who, as they breathe, inhale the said powder with their breath will become asphyxiated.”

However, the modern use of chemicals on the battlefield began in earnest as a result of the substantial advances in the manufacture and use of industrial

chemicals. Germany's chemical industry during the early 1900s enabled the first large-scale use of toxic chemicals to influence the battlefield. In April 1915, the Germans released chlorine from 1,600 large and 4,130 small cylinders (a total of 168 tons of chlorine) to create a vapor cloud that resulted in significant French and Algerian force casualties (Figure 4A). Over a 2-day period, estimates were that 5,000 French and Algerian Soldiers were killed, and at least 10,000 more were disabled. The era of chemical warfare had begun. In a retaliation effort, the French countered in kind in September 1915 (Figure 4B). The necessity of using protective masks became urgent (Figure 5).



(A) First German chlorine attack—April 1915



(B) French gas attack—September 1915

Figure 4. World War I chlorine gas attacks.

Photos: Courtesy of US Army Chemical and Biological Defense Command Historical Research and Response Team, Aberdeen Proving Ground, MD.



(A) Protective masks—April 1915



(B) Chlorine cylinders, Battle of Loos—September 1915

Figure 5. Allied response to German use of chemical weapons.

Photos: Courtesy of US Army Chemical and Biological Defense Command Historical Research and Response Team, Aberdeen Proving Ground, MD.

During WWI, more than 3,000 different chemicals were studied and considered for use as possible chemical warfare agents; 45 were actually employed in combat operations. The range of materials first included gases but quickly shifted to liquids and solids dispersed as aerosols (Prentiss, 1937).

The United States entered WWI in 1917 unprepared for chemical warfare. The responsibilities for chemical warfare defense and offense were divided among several government agencies. The Bureau of Mines undertook protective mask production because of its experience in developing mine gas and rescue apparatus; research on chemical agents and weapons was performed at American University in Washington, DC; pharmacological aspects of chemical warfare defense fell under the Medical Department; and chemical agent production and munition-filling plants were the responsibility of the Ordnance Department with production facilities instituted at the Edgewood Arsenal in Maryland.

In June 1918, the War Department centralized all gas warfare functions and established the Chemical Warfare Service (CWS) (Figure 6). In 1920, all chemical warfare functions, including chemical training, research, and gas mask production, were centralized at the Edgewood Arsenal in Maryland (Figure 7).

Chemical weaponization is the process of effectively disseminating a liquid or solid payload in the appropriate particle size range depending on the intended respiratory or dermal effects. Research into chemical weaponry continued at Edgewood on a peacetime basis until the United States entered World War II (WWII) in 1941. In 1942, the Edgewood Arsenal was renamed the Army Chemical Center. Preparations for engaging in chemical warfare resumed in earnest and notable advances were made in understanding the behavior and effects of aerosols on the battlefield. Prior to the ban on open-air testing of chemical munitions in 1969, research continued on how to rapidly and effectively disseminate liquids and solids. One system in use during the 1960s for assessing the munition effectiveness for aerosolizing its payload was the ultra-high-speed camera.

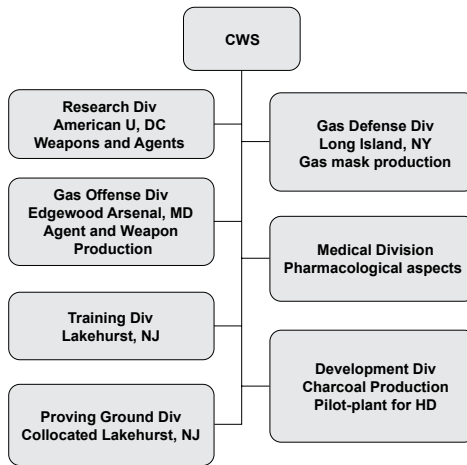

(A) CWS made permanent July 1, 1920; centralized at Edgewood Arsenal.

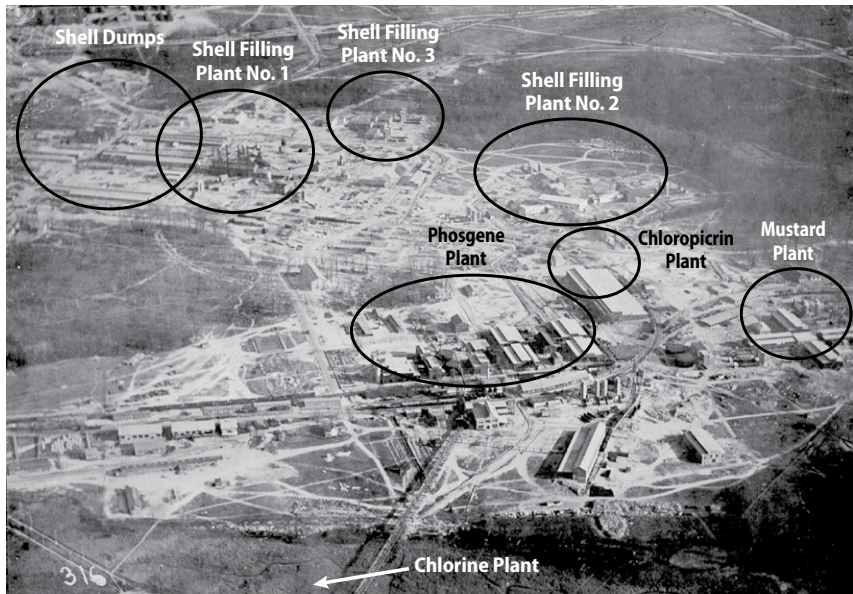

(B) Edgewood Arsenal

Figure 6. Chemical Warfare Service (CWS)—June 28, 1918.

Note: (A) Courtesy of author; (B) Photo: Courtesy of US Army Chemical and Biological Defense Command Historical Research and Response Team, Aberdeen Proving Ground, MD.



Figure 7. Chemical warfare school.

Photos: Courtesy of US Army Chemical and Biological Defense Command Historical Research and Response Team, Aberdeen Proving Ground, MD.

High-speed photography at 1.3 million frames per second enabled the initial breakup of a munition to be captured on film (Figure 8A). The bursting of a liquid-filled plastic sphere device is shown in Figure 8B. The cloud front expands at an average rate of 1,875 feet per second.

However, determination of the particle size distribution of the initial cloud could not be discerned due to the limited focal length and depth of field of the photographs.

In 1947, Dennis Gabor (1900–1979), a British/Hungarian scientist, developed the theory of holography; however, it was not until the invention of the laser in 1960 that major advances in this field became possible. The laser provided the coherent light source necessary for making holograms. The military quickly recognized that holograms had the potential to greatly extend the depth of field and to “see” into clouds. As early as 1963, the Air Force pursued holographic technology for particle size determination, and the Army Chemical Center sponsored work with Technical Operations Research in Burlington, Massachusetts, to develop a laser-hologram system to capture images of exploding munitions in test chambers (Zinky, 1965). The proof of principle of the Hologram Recording System, demonstrated in 1965, enabled the measurement of particles during their dynamic formation in the size range of 3–30 micrometers at a concentration up to 100,000 particles per cubic centimeter (Figure 8C).

The need to determine the aerosol size generated by various explosive or spray systems and to track cloud travel in the environment led to the development of novel methods for collecting samples of particulate aerosols, especially biological aerosols under field conditions.

Among these sampling devices is the now familiar Andersen Aerosol Sampler (Andersen, 1958) (Figure 9A). This product of military research advanced the methodology to more clearly define the particle size distribution of aerosols. Another example is the Rotorod Sampler (Metronics, 1969) (Figure 9B). This device captured atmospheric particles in the size range of 1 to 10 micrometers at an effective sampling rate of 52 liters per minute, and with a U-shaped collector rod, particulates from 10 to 100 micrometers at 118 liters per minute. Edgewood researchers extended this device into a moving filament rotating sampler from which the time history and concentration of an aerosol cloud could be obtained.

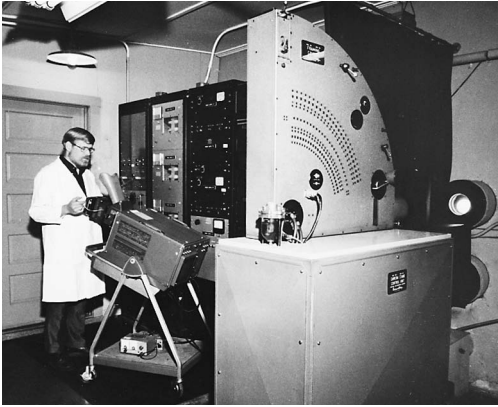

(A) High-speed camera—1.3 million frames per second



(B) Liquid agent dissemination sequence

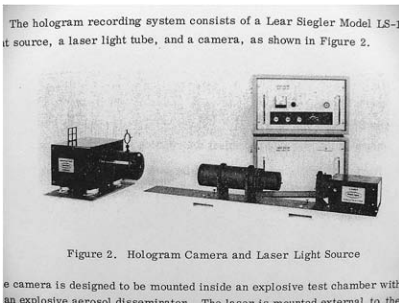
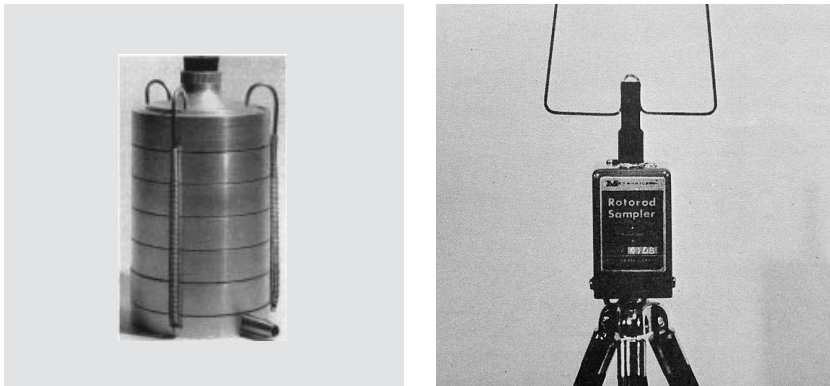

Figure 2. Hologram Camera and Laser Light Source
The camera is designed to be mounted inside an explosive test chamber with an explosive aerosol disseminator. The laser is mounted external to the chamber.

(C) Hologram recording system—1965

Figure 8. Munition dissemination assessment methods.

Photos: (A) Source: Courtesy of US Army Chemical and Biological Defense Command Historical Research and Response Team, Aberdeen Proving Ground, MD; (B) and (C) Courtesy of the author.



(A) Andersen Aerosol Sampler—1958

(B) Rotorod Sampler—1962

Figure 9. Aerosol sampling devices.

Photos: Courtesy of the author.

Providing aerosol test standards for the calibration and quantification of the performance of aerosol sampling devices sometimes makes use of liquid or particulate atomizing systems. The concept of an aerosol sprayer originated in 1790 when self-pressurized carbonated beverages were first introduced in France. This technology was advanced prior to and during WWII by Department of Agriculture researchers, Lyle Goodhue and William Sullivan, who developed the first portable aerosol spray can (U.S. Patent No. 2,321,023, 1941). Their invention was patented in 1941, and during WWII, the small cans were filled with insecticide and pressurized by a liquefied fluorocarbon gas for use against malaria-carrying insects. This invention led the way for the many practical applications of aerosol cans common today.

Today, ink-jet technology is available to produce custom aerosols of known composition and size at practically any desired rate (Figure 10). The Ink Jet Aerosol Generator (IJAG) invention (U.S. Patent No. 5,918,254, 1999) at Edgewood is used to test the sensitivity of bioaerosol detection candidates at very low threat levels of a few particles per liter of air. The IJAG is also used for creating uniformly sized aerosols for the calibration of sampling devices at rates up to 2,000 particles per second.



(A) The IJAG provides a source of well-characterized biological aerosol particles at low concentrations to test BW detection equipment. An ink jet cartridge, loaded with water and dissolved or suspended material, produces 50 micrometer droplets which are quickly dried in a vertical oven, producing the desired residue particles.

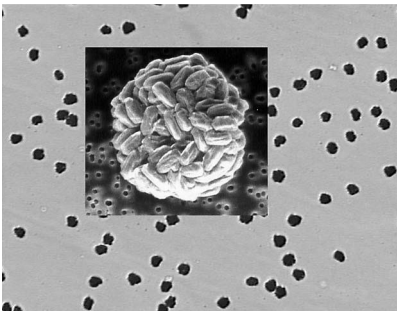

(B) Clusters of BG spores

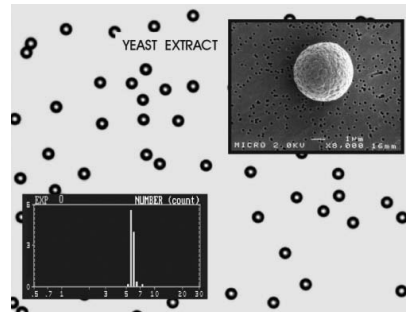

(C) Spherical particles of yeast extract

Figure 10. Ink jet aerosol generator (IJAG).

Photos: Courtesy of US Army Chemical and Biological Defense Command Historical Research and Response Team, Aberdeen Proving Ground, MD.

Respiratory and Body Protection

In addition to his weaponry ideas, Leonardo da Vinci also had ideas for respiratory protection in the 16th century. His advice for protection against toxic powder was to “have your nose and mouth covered over with a fine cloth dipped in water so that the powder may not enter” (McCurdy, 1977). A more refined respirator for firefighters and mine workers was developed in 1850 by John Stenhouse of Glasgow, Scotland. It consisted of a wood charcoal filter element and velvet-lined facepiece with an elastic headband to provide

a tight fit (Smart, 1999). However, WWI found the allied armies unprepared for gas attacks even though respirators were used in civilian matters. Efforts were immediately undertaken in 1915, primarily by the British, to develop respirators to protect the wearer from noxious vapors. However, researchers were aware that aerosols of lesser volatile compounds could be expected and therefore also included particulate filtration in the protective masks.

A discussion of the United Kingdom's development of particulate filters was presented by J. M. (Don) Clark at the Second Symposium on the History of Aerosol Science (Clark, 2005).

During the beginning of WWII, the filter papers from captured German gas mask canisters were sent to Edgewood for the purpose of reverse engineering. Large quantities of the German-designed filter paper that contained 14% of asbestos fibers were manufactured in the United States for protective masks, but even better smoke filters were needed. The assistance of university and industrial scientists was solicited, and major advances in the theory and technology of aerosol filtration resulted from the work of Irving Langmuir (1942) and Victor LaMer (1951). The requirement for high-airflow rate air purifiers to serve in collective protection shelters gave rise to the development of high-performance filters. The Edgewood Arsenal thereby became the sole supplier of filters for the Manhattan Project, which used them to confine airborne radioactive particles in the exhaust ventilation systems of experimental reactors. These became known as absolute, super-interception, and super-efficiency filters. In 1961, Humphrey Gilbert authored a report called *High-Efficiency Particulate Air Filter Units, Inspection, Handling, Installation* (Gilbert, 1961), and the term "HEPA filters" stuck.

Atmospheric Transport Modeling and Prediction

The transport of aerosols from munition functioning has required research into the complex arena of micrometeorology. In the case of biological aerosols, which can be infective at very low inhaled dose levels, the downwind transport is long range, in some cases covering hundreds of miles downwind depending on the release point. For chemical aerosols, the downwind transport of aerosols and vapors is of shorter range because atmospheric dilution and diffusion lessen the potential hazard. The first means of predicting transport distances made use of hand calculations and slide rules. The first straight logarithmic slide rule was invented in 1632 by William Oughtred (1574–1660), an English clergyman and writer on mathematics.

During the 1950s and 1960s, mechanical calculators with a constant multiplier function, such as the Marchant calculator, made numerical estimations by hand much faster. A slide rule for estimating downwind hazard levels based on O. G. Sutton's mathematical models (Sutton, 1947) was then invented (Stuempfle et al., 1962), and other slide rules were developed for quickly obtaining aerosol property values (TSI Incorporated, 1981) (Figure 11).

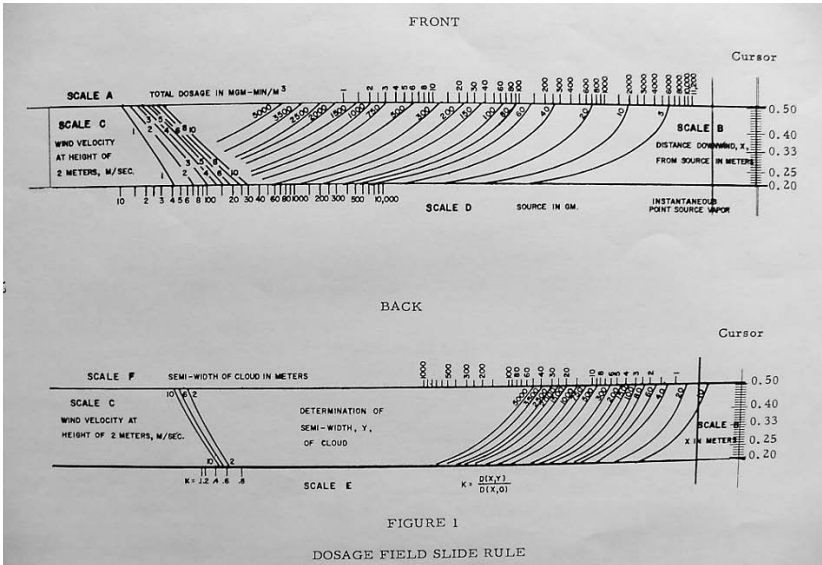

(A) Cloud Travel Slide Rule—1962



(B) Aerosol Properties Slide Rule—1981

Figure 11. Slide rules.

Photos: Courtesy of the author.

The advent of the electronic computer provided the capability for advanced atmospheric transport modeling and prediction. The first electronic computer supported by Department of Defense research funds was the Electronic Numerical Integrator and Calculator (ENIAC) (Figure 12A).

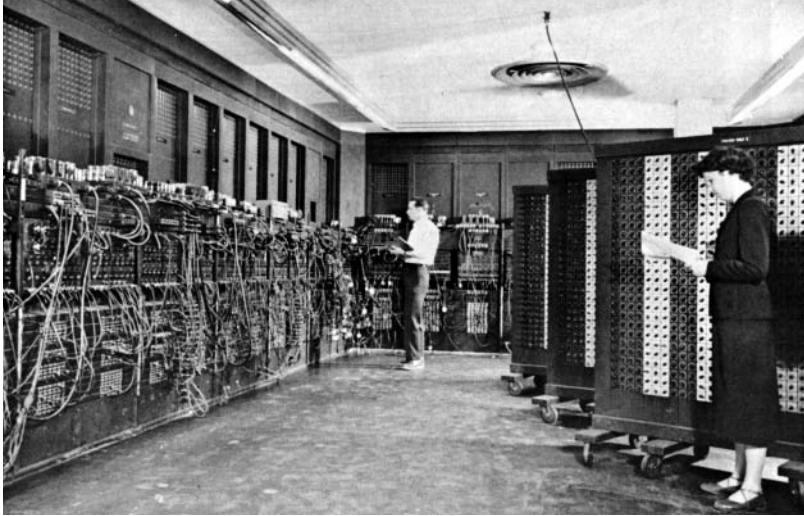

(A) Electronic Numerical Integrator and Calculator (ENIAC)—1946
Ballistics Research Laboratory, Bldg 328

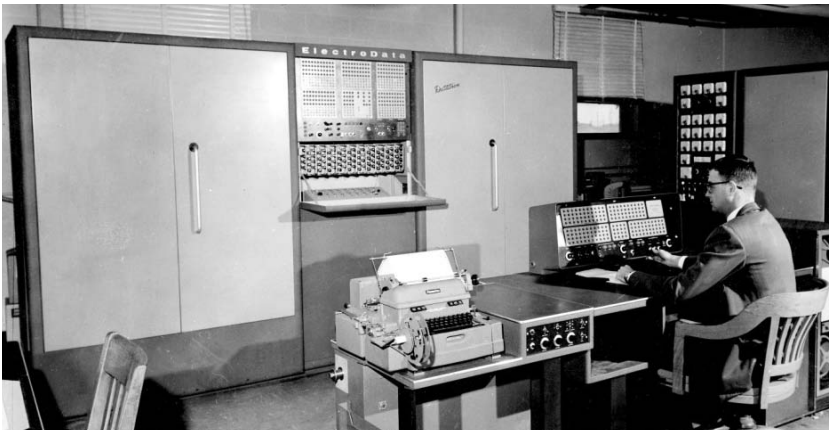

(B) Datatron 205 Electrodata Computer—1960

Figure 12. Early electronic computers.

Photos: (A) Courtesy of US Army Chemical and Biological Defense Command Historical Research and Response Team, Aberdeen Proving Ground, MD; (B) Courtesy of the author.

Development of ENIAC began in 1943 but was not completed until 1946. It was used at the Ballistic Research Laboratory at Aberdeen Proving Ground, Maryland, to compute ballistic firing tables and was capable of reducing the time of calculation for a 60 second shell trajectory from 20 hours of hand calculations to 30 seconds. It consisted of 18,000 vacuum tubes and 70,000 resistors. A smaller-sized digital computer acquired by the Edgewood Arsenal for rapid and more accurate estimates of downwind cloud and aerosol transport was the Datatron 205 Electrodata Computer (Stuempfle, 1960) (Figure 12B).

An additional benefit of operating such a power-consuming and heat-generating device, with its 1,500 vacuum tubes that generated 56,000 BTU per hour, was that the room containing it needed to be air-conditioned whereas the rest of the government building was not. In 1960, this electronic data processing system cost \$150,000. The discovery of transistors in 1958 eventually led to the development of second generation computers that were smaller, faster, and less power-consuming. Over the past 50 years, major advances in computer technology have occurred, and a typical programmable hand calculator purchased for \$20 can now rapidly perform all the tasks that required massive equipment and intensive programming labor in 1960.

Aerosol Research Conferences

In the 1970s, one of the early technical objectives of the Edgewood Arsenal was to assemble a team of scientists to develop improved obscurants, especially against laser systems. This required knowledge of aerosol physics and chemistry. Starting in June 1978, Ed Stuebing brought together, on an annual basis, a number of recognized experts in a variety of technical specialties to share research advances in aerosol physics. The first conference topics focused on the optical and physical properties of aerosols and aerosol characterization methods (Stuebing, 1978). Interest in the conference grew as its proceedings became known. The number of attendees increased and soon included researchers from the government, academia, and industry, as well as international visitors. Some of the attendees at the CSL Aerosol Science Conference in 1981 are shown in Figure 13.



Figure 13. CSL Aerosol Science Conference—1981.

Photo: Courtesy of the author.

These conferences brought together researchers with a variety of specialties who contributed to the understanding of aerosol behavior and thus provided a stimulus for creating a national organization for aerosol researchers. In collaboration with key personnel from the scientific community, these series of information exchanges served as the forerunner to AAAR, which held its first conference in Santa Monica, California, in February 1982 (Ensor, 2000). Subsequently, the First International Aerosol Conference was held in Minneapolis, Minnesota, in 1984 (Liu et al., 1984). Through these conferences, the advances gained from aerosol science research are now exchanged on an international basis.

Conclusion

This chapter touched very briefly on some historical developments regarding obscurants, chemical aerosol generation and characterization, holography, particulate filter development, aerosol sampling techniques and calibration devices, spray can technology, atmospheric transport, and computer technology. The military and government sponsorship of research efforts has resulted in the advancement of knowledge and the technologies of aerosol science.

Acknowledgments

Discussions with and the assistance of Mr. Jeffery Smart, Command Historian, US Army Research, Development and Engineering Command, Aberdeen Proving Ground (APG), MD, in researching the technical archives of the Edgewood Arsenal files, are greatly appreciated. Informative discussions with Dr. Edward Stuebing, Team Leader, Aerosol Sciences, Edgewood Biological Chemical Center (ECBC), APG, and with Mr. Craig Allan (retired), formerly of ECBC, are appreciated. OptiMetrics, Inc. is acknowledged for providing the opportunity to attend the Seventh International Aerosol Conference.

References

- Andersen, A. A. (1958). New sampler for the collection, sizing, and enumeration of viable airborne particles. *Journal of Bacteriology*, 76(5), 471–484.
- Bottiger, J. R., & DeLuca, P. J. (1999). Low concentration aerosol generator. U.S. Patent No. 5,918,254. Washington, DC: U.S. Patent and Trademark Office.
- Boyle, A. (2006). *Here's how to make an invisibility cloak*. Retrieved May 31, 2006, from <http://www.msnbc.msn.com>
- Clark, J. M. (2005). A history of the development of aerosol science for chemical and biological defense at Porton Down. In G. J. Sem, D. Boulaud, P. Brimblecombe, D. S. Ensor, J. W. Gentry, J. C. M. Marijnissen, & O. Preining (Eds.), *History and reviews of aerosol science: Proceedings of the Second Symposium on the History of Aerosol Science, Portland, Oregon, October 13-14, 2001* (pp. 397–409). Mt. Laurel, NJ: American Association for Aerosol Research.
- Embury, J. F. (2002a). *Maximizing infrared extinction coefficients for metal discs, rods, and spheres* (ECBC-TR-226, ADA400404). Aberdeen Proving Ground (APG), MD: Edgewood Chemical Biological Center.
- Embury, J. F. (2002b). *Emissive versus attenuating smokes* (ECBC-TR-225, ADA400816). Aberdeen Proving Ground, MD: Edgewood Chemical Biological Center.
- Embury, J. F. (2004). Optimum smoke nanoparticles that maximize attenuation at infrared and radar wavelengths. *Proceedings of the 24th Army Science Conference*. Orlando, FL.

- Embury, J. F., Walker, D. L., & Zimmermann, C. J. (1993). *Screening smoke performance of commercially available powders I: Infrared screening by graphite flake* (ERDEC-TR-093, ADA272461). Aberdeen Proving Ground, MD: Edgewood Chemical Biological Center.
- Embury, J. F., Walker, D. L., & Zimmermann, C. J. (1994a). *Screening smoke performance of commercially available powders II: Visible screening by titanium dioxide* (ERDEC-TR-168, ADA284072). Aberdeen Proving Ground, MD: Edgewood Chemical Biological Center.
- Embury, J. F., Walker, D. L., & Zimmermann, C. J. (1994b). *Screening smoke performance of commercially available powders III. Infrared and visible screening by carbon black* (ERDEC-TR-215, ADA290105). Aberdeen Proving Ground, MD: Edgewood Chemical Biological Center.
- Ensor, D. S. (2000). History of the American Association for Aerosol Research. In O. Preining and E. J. Davis (Eds.) *History of Aerosol Science* (Chapter XXVIII). Vienna, Austria: Verlag der Österreichischen Akademie der Wissenschaften.
- Gilbert, H. (1961). High-efficiency particulate air filter units, inspection, handling, installation. *Atomic Energy Commission Report* (TID-7023). Springfield, VA: National Technical Information Service.
- Goodhue, L., & Sullivan, W. (1941). U.S. Patent No. 2,321,023. Washington, DC: U.S. Patent and Trademark Office.
- LaMer, V. K. (1951). *Atomic energy commission report* (NYO-512). Oak Ridge, TN: Technical Information Service.
- Langmuir, I. (1942). *Report on smokes and filters* (OSRD 865). Washington, DC: Office of Scientific Research and Development, Office of Technical Services.
- Liu, B. Y. H., Pui, D. Y. H., & Fissan, H. J. (Eds.). (1984). Aerosols: Science, technology, and industrial applications of airborne particles. In *Proceedings of the First International Aerosol Conference held September 17–21, 1984, Minneapolis, Minnesota*. New York, NY: Elsevier Science Publishing Co., Inc.
- McCurdy, E. (Ed.). (1977). *The notebooks of Leonardo da Vinci* (Vol. 2). London, England: Jonathan Cape.

- Metronics. (1969). Air sampling equipment: The rotorod sampler. *Metronics Product Bulletin No. 23-69*. Palo Alto, CA: Metronics Associates, Inc.
- Noble, C. A. (2001). From China's great wall to Hollywood's great spy: The story of military smokes and obscurants. In David S. Ensor (Ed.), *Aerosol Science and Technology: History and Reviews* (Chapter 14). Research Triangle Park, NC: RTI Press.
- Prentiss, A. M. (1937). *Chemicals in War*. New York, NY: McGraw-Hill.
- Smart, J. K. (1997). History of chemical and biological warfare: An American perspective. In *Textbook of Military Medicine, Part I. Warfare, Weaponry, and the Casualty. Medical Aspects of Chemical and Biological Warfare* (pp. 9–86). Washington, DC: Office of the Surgeon General, Walter Reed Army Medical Center.
- Smart, J. K. (1999). *History of the Army's protective mask*. Aberdeen Proving Ground, MD: U.S. Army Soldier and Biological Chemical Command.
- Stuebing, E. (1978). *First CSL Scientific Conference on Obscuration and Aerosol Research*. Aberdeen Proving Ground, MD: Chemical Systems Laboratory.
- Stuempfle, A. K. (1960). *Introduction to the Datatron "205" electrodata computer*. Unpublished report.
- Stuempfle, A. K., Egner, D. O., & Campbell, D. (1962). *Cloud travel slide rules for the determination of downwind travel and area coverage* (CRDLR 3124). Army Chemical Center, MD: U.S. Army Chemical Research and Development Laboratories.
- Sutton, O. G. (1947). The problem of diffusion in the lower atmosphere. *Quarterly Journal of the Royal Meteorological Society*, 73, 268.
- TSI Incorporated. (1981). *Aerosol properties calculator*. St. Paul, MN: V. A. Marple.
- von Clausewitz, C. (1976). Friction in war. In M. Howard & P. Paret (Eds.), *On war* (pp. 119–140). Princeton, NJ: Princeton University Press.
- Zinky, W. R. (1965). *Hologram camera and reconstruction system for assessment of explosively generated aerosols: Final report* (Report No. TO-B 65-90, Contract No. DA-18-035-AMC-256[A]). Burlington, MA: Technical Operations Research.

Chernobyl

Observations in Finland and Sweden

Jussi Paatero, Kaarle Hämeri, Matti Jantunen,
Pertti Hari, Christer Persson, Markku Kulmala, Rolf Mattsson,
Hans-Christen Hansson, and Taisto Raunemaa

Introduction

The Chernobyl nuclear accident happened in the former Soviet Union on April 26, 1986. The accident destroyed one of the RBMK-1000-type reactors and released significant radioactive contamination into the environment. The Chernobyl nuclear power plant is situated in the Ukraine, 130 km north of the capital, Kiev. The rare RBMK-type graphite-moderated reactors used a light-water cooling system and 180 tons of relatively lightly enriched uranium dioxide fuel. The acronym RBMK comes from *Reaktor Bolshoy Moshchnosty Kanalny*, meaning high-power channel reactor. The thermal output of the reactor model was 3,200 MW with an electrical output of 1,000 MW. Several of the RBMK's design characteristics—for example, the control rod design and positive temperature and void coefficients of reactivity—were unsafe. An advantage of this reactor model is its good neutron economy, requiring less enriched uranium fuel compared with conventional light-water reactors. In addition, the nuclear fuel can be replenished while the reactor is in operation.

This chapter discusses the impact of nuclear fallout from Chernobyl in Finland and Sweden and presents an overview of related research activities and main results.

The Accident

The reactor was scheduled for a regular maintenance shutdown on Friday, April 25. In connection with this maintenance, a test program was planned to assess how long the steam turbines' kinetic energy could deliver power to safely operate the power plant in case of shutdown resulting from a lack of external power. Because there was an abundance of short-lived

neutron-absorbing nuclides after reactor shutdown, the reactor could not be restarted for a few days. However, the power plant operators were requested to deliver full power again the following Monday morning, April 28, after reactor shutdown. In an attempt to meet the two opposing objectives, the operators planned not to close the reactor down but to keep it operating at a very low power level, at which the reactor was inherently unstable. To do this, several reactor safety systems had to be switched off. The power plant's staff started the experiment on April 26 at 1:22:30 a.m. local time (21:22:30 UTC on April 25), ignoring the process-control computer's recommendation for an immediate reactor shutdown. A minute later, a power surge in the reactor fragmented the fuel elements, causing the cooling water to vaporize. The resulting pressure broke the fuel channels, and the water vapor reacted with the zirconium of the fuel rods and with the graphite moderator, producing hydrogen and carbon monoxide. These mixed with atmospheric oxygen, and the mixture ignited, causing a secondary explosion. The graphite moderator caught fire, possibly supported by the Wigner effect (i.e., a sudden energy release caused by the annealing of radiation damage in the graphite lattice). Several fires started in the reactor building. The reactor core burned for at least 1 week, prolonging the emissions of radioactivity into the atmosphere. The fire was extinguished and the emissions halted by dropping 4,000 tons of sand, clay, boron, and lead from helicopters over the reactor ruins.

According to Soviet Union estimates, all the radioactive noble gases from the core inventory were liberated during the accident (Table 1). Ten to twenty percent of the volatile nuclides (e.g., ^{131}I and ^{137}Cs) were released into the environment. A 2–6% fraction of the refractory nuclides, such as ^{95}Zr and transuranium elements, were also released (International Atomic Energy Agency, 1986).

Dispersion of the Plume

The energy released during the accident caused the radioactive plume to reach considerable altitudes and spread the debris with high wind speeds (8–11 m/s) quickly into the atmosphere. At first, the emissions were transported northwestward over Poland, the Baltic states, Finland, and Sweden. The plume arrived in Finland from the southwest on April 27 at 12:00 UTC, with a release height of 2,000 m. The plume then moved across the country northeast to the Kuhmo region and then back to the Soviet Union and toward the southern shore of the White Sea.

Table 1. Core inventory and total release of radionuclides from Chernobyl reactor accident April 26, 1986. Assumed accuracy is $\pm 50\%$

Radionuclide	Activity Bq	Release %	Radionuclide	Activity Bq	Release %
^{85}Kr	3.3×10^{16}	~100	^{141}Ce	4.4×10^{18}	2.3
^{133}Xe	1.7×10^{18}	~100	^{144}Ce	3.2×10^{18}	2.8
^{131}I	1.3×10^{18}	20	^{89}Sr	2.0×10^{18}	4.0
^{132}Te	3.2×10^{17}	15	^{90}Sr	2.0×10^{17}	4.0
^{134}Cs	1.9×10^{17}	10	^{239}Np	1.4×10^{17}	3
^{137}Cs	2.9×10^{17}	13	^{238}Pu	1.0×10^{15}	3
^{99}Mo	4.8×10^{18}	2.3	^{239}Pu	8.5×10^{14}	3
^{95}Zr	4.4×10^{18}	3.2	^{240}Pu	1.2×10^{15}	3
^{103}Ru	4.1×10^{18}	2.9	^{241}Pu	1.7×10^{17}	3
^{106}Ru	2.0×10^{18}	2.9	^{242}Cm	2.6×10^{16}	3
^{140}Ba	2.9×10^{18}	5.6			

Source: International Atomic Energy Agency, 1986.

As of April 27, emissions were spreading to eastern central Europe, southern Germany, Italy, and Yugoslavia. Within the next week, the plume was transported southward from Chernobyl to Rumania, Bulgaria, the Balkans, the Black Sea, and Turkey. After that, the emissions arrived again over Central Europe, Scandinavia, and Finland (Persson et al., 1987). Finally, the plume nearly covered the northern hemisphere. Most of the Chernobyl-originated activity remained in the troposphere, but it could also be detected in the stratosphere (Jaworowski & Kownacka, 1988).

The air parcel trajectories originating from Chernobyl at the time of the accident show that the radioactive plume moved first northwestward (Valkama et al., 1995). Over Lithuania, the plume separated into two main paths. At lower altitudes (750–1,000 m), the plume continued toward Sweden and Norway. At higher altitudes (1,500–2,500 m), the plume turned toward the north. The plume arrived in Finland from the southwest, arriving in southwestern Finland on April 27 at 12:00 UTC, with a release height of 2,000 m.

First Observations in Sweden and Finland

In Sweden, the first clear registrations were being made in eastern Svealand, north of Stockholm on April 27 at 12:00 UTC (Persson et al., 1987). The Forsmark nuclear power plant, which is situated in the contaminated area, received rain on April 27 and 28, and the rains' radioactivity caused a radiation alarm to sound in the external monitoring system on the morning of April 28. Also, the contamination monitors of the personnel detected unusual radioactivity. The Swedish reactor safety authorities demanded that the Forsmark plant be shut down if the source of the radioactivity was not found immediately. However, since the radioactivity was detected on persons entering the plant rather than leaving it, this indicated that the plant was not the source of contamination. The composition of the radionuclide mixture, absence of neutron activation products, and certain elemental isotope ratios suggested the fallout was from fission that had been occurring for some time. In combination with the weather data, Swedish scientists concluded that the source of the radioactivity was a reactor accident somewhere in the western Soviet Union.

The existence of radionuclide contamination in the air forced the Swedish National Radiation Protection Institute to conduct a mapping of statewide radiation. According to the gamma activity measured via airborne counting at a height of 150 m from May 1–8, a high dose rate region (300–400 $\mu\text{R/h}$ [3–4 $\mu\text{Sv/h}$]) was distinguishable around Gävle, 200 km northwest of Stockholm. The deposition was later converted from dose rate units to ^{137}Cs ground surface deposition in kBq/m^2 . The gamma activity map was published by the local newspaper *Dagens Nyheter* on May 8, 1986. The flight survey covering all of Sweden disclosed two other high-activity areas north of Gävle in Västernorrland and in the central mountain area (Linden & Mellander, 1986).

In Finland, many of the radioactivity and weather observations and dispersion estimates were not available during the acute fallout phase because of a government employees strike. The Chernobyl plume did not reach ground-level air in the archipelago of Ahvenanmaa southwest of the Finnish mainland on April 27, but two hot particles (i.e., highly radioactive agglomerates discussed in detail below) were observed with the aerosol beta activity monitors of the Finnish Meteorological Institute (FMI) (Mattsson & Hatakka, 1986). The particles were large enough to settle by gravitation through a clean layer of air beneath the plume. On the afternoon of April 27,

an aerosol beta activity monitor reacted to the artificial radioactivity in Nurmijärvi but not in Helsinki, despite the short (about 40 km) distance between the monitoring stations. This was probably because of the convection over inland Nurmijärvi, while the lower troposphere was stratified in Helsinki because of the cold sea surface. Most of the FMI's aerosol beta activity monitors in southern and central Finland detected artificial radioactivity on April 28, especially in the afternoon when there was increased vertical mixing of the troposphere.

The external dose rate was not significantly affected by the radioactivity in the ground-level air. At Kajaani, in northeastern Finland, a Ministry of the Interior monitoring station measured an increased exposure rate value of 0.1 mR/h (1 μ Sv/h) on the evening of April 27 in connection with a rain shower (Finnish Centre for Radiation and Nuclear Safety, 1986a). However, at the time, the ground-level air there was still free from artificial radioactivity (Mattsson & Hatakka, 1986). On April 29, an area of rain moved from the west coast of Finland in an easterly direction. The rain was considerably heavy in western areas of Finland (2.5–10 mm Turku-Tampere region) (Koivukoski, 1986; Savolainen et al., 1986). The rain brought the activity to the ground, causing notable increases in the external dose rate; in Uusikaupunki on the west coast of Finland, the dose rate increased from 0.2 to 4 μ Sv/h (Puhakka et al., 1990). In eastern parts of Finland, the advancing air met a cold northerly airstream resulting in icy rainfall and thunderstorms. After April 29, a rather uniform rain area was located over central Sweden and Finland.

The Finnish Centre for Radiation and Nuclear Safety, currently STUK (Radiation and Nuclear Safety Authority), found fresh fission products from aerosol, snow, and lichen samples collected from April 28 onward (Finnish Centre for Radiation and Nuclear Safety, 1986b). After the first few days, no significant amounts of radioactivity were deposited in Finland, although somewhat elevated values were observed on May 11 and May 13 in southern Finland.

Organization of Research

Since many of the radionuclides were short lived, the collection and measurement of environmental samples had to begin as soon as possible. In the rapid surveys carried out by the researchers from the universities of Helsinki and Kuopio, the National Public Health Institute (KTL), the FMI, and the State Technical Research Centre (VTT), radioactive substances were

detected in samples taken from living trees, needle fall, traffic signs, rain water, ventilation filters, and numerous other places (Anttila et al., 1987; Jantunen et al., 1992; Raunemaa et al., 1987; Sinkko et al., 1987; Suutarinen, 1986). Because of possible health effects, extensive programs were started in the STUK to obtain information on population dose assessment and the radioecological parameters in the environment. In the following section, only some major findings from those investigations are included, as the main scope is directed to the scientific- and aerosol-related research activities and to the outcomes of those activities.

Soon after the accident, following an initiative of active researchers, the government funding agency Academy of Finland provided about 1 million Finnish marks (150,000 euros) in first aid money for the research projects (Kauranen, 1988). The scarcity of funding was a chronic problem, however, and persisted throughout the duration of the projects. The Academy of Finland established a working group as a link between the research groups. The working group organized three open symposia in 1986, 1987, and 1988, along with a number of group meetings. The Academy of Finland granted research support that helped to obtain efficient instrumentation for research groups.

External Radiation and Air Electricity

Radioactivity mapping over Finland was organized by the Finnish Ministry of Interior between April 26 and May 16; this mapping showed that the ground deposition in Finland covered southern and central parts of the country and had an irregular distribution like in Sweden. In Finland, the highest contamination (over 100 $\mu\text{R}/\text{h}$ [$\approx 1 \mu\text{Sv}/\text{h}$]) disclosed by the mapping was around Uusikaupunki in western Finland and Kotka in southeastern Finland (Koivukoski, 1986).

The first surveys of radiation in the atmosphere were performed by military aircrafts responding to the news about a suspected radioactive plume (Sinkko et al., 1987). Vertical profiles of gamma radiation values at airport regions in Helsinki, Tampere, and Pori before noon on April 29 showed that the external radiation was at its maximum between 1,000 and 2,000 m above ground (Sinkko et al., 1987). The gamma dose-rate levels were between 0.1–0.8 $\mu\text{Sv}/\text{h}$. In the afternoon of April 29, alarms sounded in several ground-level radiation monitoring stations when precipitation scavenged the substances from the troposphere. In Sweden, the overall picture of the

radioactive fallout was much clearer because the first alarms were sounded early at the Forsmark nuclear power plant as described previously (Devell et al., 1986; Persson et al., 1986).

A need for a prompt warning tool to alert the authorities about an approaching radioactive plume became apparent when special research at FMI during the time of the accident became public. Radioactive substances in the air can affect the air's electrical conductivity. A tenfold increase in the conductivity was observed at the Helsinki-Vantaa airport in April and May of 1986. From April 30 to May 1, the conductivity meter was off the scale, but from the recordings of potential gradient, it was estimated that conductivity had been 150–200 fS/m (Tuomi, 1988, 1989). Conductivity reached a normal level again by the end of summer 1986. However, later it became apparent that if the conductivity would be used for monitoring radioactivity, it would require a simultaneous measurement of aerosol particle-size distribution. Similar conductivity observations were made in Sweden. In Uppsala, northwest of Stockholm, the electrical conductivity of the air increased from 20 fS/m to 220 fS/m after a rainfall on April 29 (Israelsson & Knudsen, 1986).

Radionuclides in the Air

The FMI has collected daily aerosol samples with a high-volume filter sampler at Nurmijärvi since 1962. The filter samples are measured for total beta activity. The measurements are carried out 5 days after the end of sampling when the short-lived daughter nuclides of ^{222}Rn have decayed to ^{210}Pb and the ^{220}Rn progeny have decayed to stable lead. The measured activity consists of ^{210}Pb and possible artificial beta-emitting fission products. The monthly mean total beta activity concentration in April 1986 was the highest ever recorded, 1 Bq/m^3 (Paatero & Hatakka, 1994). However, the time-integrated activity concentration was significantly higher in the early 1960s because of the Soviet and U.S. atmospheric nuclear tests.

In Finland, analysis of a filter sample taken at a height of 1,500 m at noon on April 29 showed that the most dominant radionuclides were ^{131}I , ^{132}Te , and ^{137}Cs ; ^{103}Ru activity was also observed. Ground-level air in Helsinki was concentrated at that time with about 1/200 of the plume activity (Sinkko et al., 1987). Coincidentally, a geological survey aircraft equipped with a NaI(Tl) spectrometer flew through the Chernobyl plume on April 29. The following could be found in the analyzed gamma spectra: ^{131}I , ^{132}I , ^{134}Cs , ^{137}Cs , and ^{140}La (Grasty et al., 1997).

Between April 28 and May 16, 1986, the concentration of ^{137}Cs in ground-level air at Nurmijärvi decreased four orders of magnitude, starting from 10^4 mBq/m³ (Finnish Centre for Radiation and Nuclear Safety, 1986b). On April 28, the ground-level air at Nurmijärvi contained 32 $\mu\text{Bq}/\text{m}^3$ of $^{239,240}\text{Pu}$ and 506 $\mu\text{Bq}/\text{m}^3$ of ^{242}Cm (Jaakkola et al., 1986). For comparison, the annual mean $^{239,240}\text{Pu}$ concentration in the air in Helsinki varied between 7 and 26 $\mu\text{Bq}/\text{m}^3$ from 1962–1964 because of the atmospheric nuclear detonations (Jaakkola et al., 1979). ^{14}C and tritium could be observed in the air in Helsinki during only the first 3 days after the arrival of the Chernobyl plume. The maximum ^{14}C activity concentration was 30 times higher and tritium activity concentration was 100 times higher than the background level (Salonen, 1987).

The characteristics of radioactive aerosols in ambient air in Finland were measured by Kauppinen and colleagues (1986). Iodine, whose isotopes are short-lived, was transported mainly in the gaseous phase and was adsorbed on local aerosol during travel. Geometric mean aerodynamic diameter for particle-bound ^{131}I measured from May 7–9 was 0.33 μm (Figure 1). Iodine particle size was reported to be smaller than that of the isotopes ^{103}Ru , ^{132}Te , and ^{137}Cs , having geometric mean diameters between 0.63 and 0.93 μm . The values determined with the aid of an 11-stage Berner low-pressure impactor were equal to those observed by Reineking and colleagues (1987) in Germany.

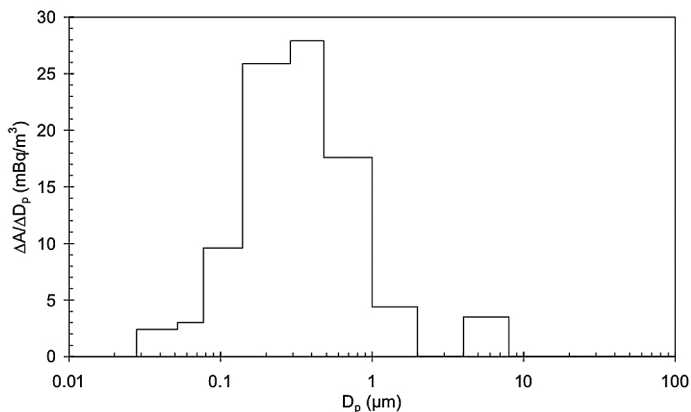

Figure 1. ^{131}I -activity concentration as a function of particle size distribution, Helsinki May 7–9, 1986.

Source: Kauppinen et al., 1986.

Deposition

In stark contrast to the fallout from nuclear weapons tests during the 1960s, the Chernobyl fallout was extremely unevenly distributed in Sweden and Finland. In Finland, the regional deposition pattern of different nuclides has been studied by mobile and airborne in situ gamma spectrometric measurements and by collecting lichen, peat, and soil samples for laboratory analysis (Arvela et al., 1990; Kettunen, 2006; Paatero et al., 2002; Reponen, 1992). A portion the radionuclides was associated with hot particles. In addition, the nuclide ratios showed large and apparently random variations, even between close locations. For example, ^{95}Zr was mainly deposited on a relatively narrow band from southwestern Finland toward the northeast. ^{137}Cs , however, was deposited in larger areas in southwestern, central, and southeastern Finland. These variations resulted from the composition of the emissions varying as a function of time. The first emissions contained reactor fuel debris, including ^{95}Zr and plutonium isotopes, while later, during the subsequent fire, the volatility of the nuclides affected the composition of the emissions (Figure 2). In addition, there might have been short-term criticality events that produced new fission products from the remains of the reactor core. The Finnish Defence Forces later surveyed the regional distribution of ^{137}Cs in south and central Finland using airborne gamma spectrometry (Kettunen, 2006).

Figure 2. Deposition of $^{239,240}\text{Pu}$ (Bq/m^2) in Finland after the Chernobyl accident.

Source: Courtesy of the author.

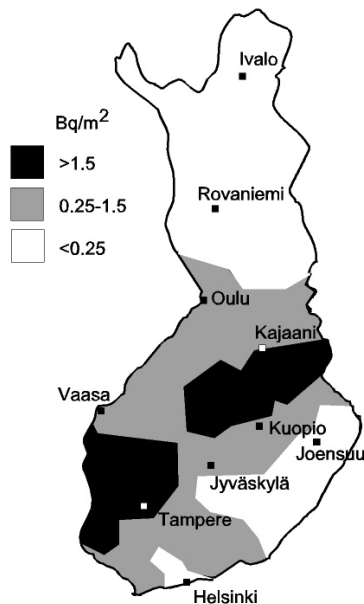

Two consistencies with the activity ratios, however, soon emerged: the $^{95}\text{Zr}:$ ^{141}Ce activity ratio was constant at 1.04, and the $^{134}\text{Cs}:$ ^{137}Cs activity ratio was also constant at 0.549, corresponding to a fuel burn-up of $9 \text{ GWd}(\text{tU})^{-1}$ (Anttila, 1986). Kirchner and Noack (1988) reported a $^{134}\text{Cs}:$ ^{137}Cs ratio of 0.528, and a corresponding fuel burn-up of $12.85 \text{ GWd}(\text{tU})^{-1}$. The term “burn-up” is defined as the amount of energy extracted from the nuclear fuel. The nuclide composition of the nuclear fuel changes as a function of burn-up and, thus, provides information on the operational history of the nuclear fuel. These consistent results indicated that there were also logical explanations to be found for the other, apparently illogical, results (Jantunen et al., 1991).

Based mainly on the sample analyses of lichen (*Hypogymnia physodes*, *Cladonia sp.*) and pine needle (*Pinus sylvestris*), it was found that deposition could vary significantly, even within a few kilometers. These unsystematic high-deposition spots with a radius of about 5 km were identified in three to four locations, the highest ^{95}Nb activity being about 40 kBq/kg of sample mass in some areas. Average analyzed nuclide activity composition in samples from 160 locations is given in Table 2. In these hot spots, the ^{95}Zr , ^{95}Nb , and ^{144}Ce activities had a relatively higher contribution to total activity compared with other areas (Luokkanen et al., 1988a).

^{134}Cs and ^{137}Cs appeared in particles with the size range below $1 \mu\text{m}$ and were deposited mainly by rain scavenging, which was also identified in aerial fallout mappings (Arvela et al., 1987; Arvela et al., 1989; Jantunen et al., 1991; Lang et al., 1988; Luokkanen et al., 1988b). The highest aerial deposition values obtained in the analyses were 70 kBq/m^2 for ^{137}Cs and 420 kBq/m^2 for ^{131}I (Jantunen et al., 1991) and about 30 kBq/m^2 for ^{95}Zr (Arvela et al., 1990).

Table 2. Average activity composition of hot particles

Isotope	T $\frac{1}{2}$ (days)	Average composition (%)	
		Saari	Rytömaa
^{95}Zr	64.0	24.8	18.9
^{95}Nb	34.0	24.9	
^{103}Ru	39.4	8.6	43.2
^{106}Ru	367.0	1.8	8.9
^{141}Ce	32.55	25.7	19.0
^{144}Ce	284.5	14.2	10.0

Source: Saari et al., 1989, from Scots pine needles on May 1, 1986; Rytömaa et al., 1986b, airborne April 28, 1986.

The Finnish Centre for Radiation and Nuclear Safety divided the deposition into five categories according to ^{137}Cs fallout, with the highest three areas having 10–67 kBq/m² (Rantavaara, 1988). In the cluster analysis of 257 samples (Lang et al., 1988), the nonvolatile elements zirconium, niobium, and cerium coupled properly together, but ruthenium was observed to couple with the more volatile cesium.

Radioactive fallout may also cause an external radiation dose in people. The level of this radiation changes with time because of physical decay, but also because of rain washing it away, migration into the soil, leaching from organic material, and removal or covering of the surface soil in various urban development processes. The effective decay rate was investigated by repeated measurements from the same locations on hard (asphalt), porous (sand), and natural (grass, forest) surfaces for about 900 days after May 1, 1986 (Reponen, 1992; Reponen & Jantunen, 1991). The radiation level in 1986 decreased very quickly during the summer but slowed considerably by autumn. As expected, the quickest decay was from the hard, artificial urban surfaces (e.g., stone, concrete and asphalt), and surfaces like gravel and sand; decay was the slowest—essentially identical to physical decay—from natural surfaces (e.g., grass and forest) in the parks. The effective half-life for the 1986 decay of ^{137}Cs (physical half-life is 30 years) was 80–200 days for hard surfaces and 150–400 days for sand surfaces. For the 1987–1988 decay period, the respective values slowed down to 330–720 days and 1,200–4,200 days. These numbers mean that removal of the fallout radionuclides from many typical urban surfaces—with the exception of parks—is relatively fast, and that the external radiation in the cities is, therefore, reduced more rapidly than the physical decay of the nuclides alone would indicate. This finding is important for estimating the external radiation from those fallout radionuclides with a half-life of years or more.

The highest specific concentrations in the soil were usually below rain channels emanating from dwellings. For ^{131}I , the 42 kBq/kg concentration observed May 18, 1986, decayed to 6 kBq/kg in 1 month and a similar decrease was also observed for ^{103}Ru activity (Raunemaa, 1986). Precipitation scavenging was studied by Jylhä (1991) using Chernobyl fallout and weather radar data to obtain empirical values for the scavenging coefficient from the radioactive plume approaching Finland at the height of 1,500 m. Coefficients could be determined for 10 radionuclides, including iodine, by considering the in-cloud and below-cloud wet-removal effect caused mostly

by rain droplets. The average scavenging coefficient was $\Lambda = 10^{-4} \text{ s}^{-1} R^{0.64}$, incorporating both the rainout and washout effects. Three-dimensional data from weather radars produce real-time precipitation information and can thus provide a fast, qualitative estimate on regional deposition patterns.

Hot Particles

The existence of radioactive hot particles in the core debris was a specific feature during the early stage of emission. These particles were highly radioactive agglomerates, being either fragments of the nuclear fuel or particles formed by interactions between condensed radionuclides, nuclear fuel, and structural reactor materials (Devell et al., 1986; Lancsarics et al., 1988; Raunemaa et al., 1987).

The appearance of hot particles was not a unique event. They were often observed with autoradiography in the 1960s and 1970s as a result of atmospheric nuclear tests (Moore et al., 1973; Sisefsky, 1964; Sisefsky & Persson, 1970). The aerodynamic diameter of the Chernobyl-originated hot particles varied from one to several hundred micrometers; gravitational settling thus had to be taken into account when assessing their atmospheric transport behavior (Pöllänen et al., 1997).

Altogether, high-activity hot particles with an activity over 200 Bq were detected from an aerosol sample collected between April 28 UTC and April 29 UTC from the roof of the FMI's main building in Helsinki. The air volume of the sample was about 3,500 m³. The number of lower-level radioactivity particles (0.05–200 Bq) in the filters was well over 10,000 during the first 3 days (Figure 3). From May 1 onward, no significant hot particle radioactivity

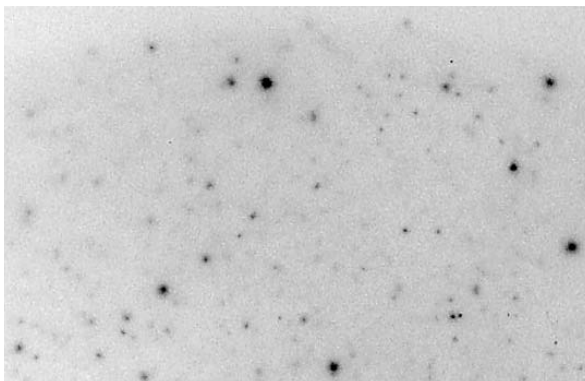

Figure 3. Hot particles on a glass-fiber filter as measured with autoradiography, sampling at Nurmijärvi, southern Finland April 28–29, 1986, exposure in September 1993. The picture represents a filter area of ca. 5 cm x 10 cm.

Source: Mattsson and Hatakka, 1986.

was found because scavenging rain on April 29 cleared the air and the plume transport direction had changed (Mattsson & Hatakka, 1986).

Studies to identify hot particle characteristics began immediately at the universities of Helsinki and Kuopio and at the laboratories at FMI and STUK (Mattsson & Hatakka, 1986; Raunemaa et al., 1987; Saari et al., 1989; Reponen, 1992; Rytömaa et al., 1986a). Using residence time estimation, researchers deduced that the size of transported hot particles was below 20 μm (Nordlund, 1986). Using radiographic and scanning electron microscopy (SEM) analysis techniques, a particle diameter range from 2–6 μm was later analyzed from particles isolated and pictured in Finland (Luokkanen et al., 1988b; Saari et al., 1989). A mean geometric diameter of 3.8 μm for these particles corresponds to an aerodynamic diameter of 10 μm . Rytömaa et al. (1986b) found airborne hot particles with a size ranging from 3–7 μm .

Ventilation filters, needle and lichen materials, and solid surfaces were intensively searched by research groups for hot particle deposition; this detailed research continued during the year following the accident. Many types of environmental material, which were systematically gathered and stored by state and research institutes, were offered and often used in analyses, but an enormous amount of study materials were collected by individual researchers. In a meeting at Skokloster, Sweden, on November 3–4, 1986, research findings, including hot particle studies on Chernobyl fallout, were quickly disseminated around the Nordic countries. One of the first summary reports concerning the Chernobyl hot particles came out 1 year later in the Theuern meeting (von Philipsborn & Steinhäusler, 1988). Later, hot particle studies were reviewed by Sandalls and colleagues (1993).

Most of the isolated hot particles were found from pine tree needles. Coniferous trees (spruce and pine) are good collectors of airborne particles because of their large leaf area. Their leaf area index (LAI) is 4–5, which is used to compare actual collecting leaf surface area to the projected leaf area. The existence and location of a radioactive particle on a single needle surface among tens or hundreds of particles was first detected by autoradiography on hundreds of collected needles (Saari et al., 1989). When a hot spot on the film was identified after 2 days' exposure, efforts were made to remove the radioactive particle from the needle surface onto a suitable backing material for further analysis. A nuclepore filter was an excellent substance for gathering particles. By repeated needle cutting, picking up, and radiography, particles were prepared for electron microscopic analysis. Some of the particles were

even identified and photographed on the needle surface without removal. The amount of radioactivity in a single particle was then determined by gamma spectroscopy using an efficient gamma detector. In the Department of Physics of the University of Helsinki, a 120 cm³ high-purity germanium detector and an ORTEC 4K channel pulse-height analyzer were used for the analysis. Paatero and colleagues (1998) used radiochemical separation and alpha spectrometry to analyze the content of transuranium nuclides in two isolated hot particles. Based on the ²³⁸Pu/^{239,240}Pu activity ratio, they deduced that the nuclear fuel burn-up values represented by these particles were 10,000 and 14,000 GWd(tU)⁻¹. New analytical techniques have since been developed to characterize hot particles (Jernström, 2006).

The results of 21 isolated hot particles showed total gamma activity between 15–560 Bq, with the major radioactivity attributed to ⁹⁵Zr, ⁹⁵Nb, ¹⁴¹Ce, and ¹⁴⁴Ce isotopes. The elements zirconium and niobium have high melting points (1,852°C and 2,800°C), and cerium melts at a somewhat lower temperature (799°C). The co-existence of these elements in the debris was first taken as an indication of virtually unexplainable temperatures at the time of their release. Elemental ruthenium also has a high melting point (2,310°C). In some particles, only ¹⁰³Ru and ¹⁰⁶Ru were identified; therefore, researchers assumed chemical reactions happened during the melting process. Several researchers reported finding only ruthenium-containing hot particles (Devell et al., 1986; Rytömaa et al., 1986b).

Ruthenium enriched in hot particles could be partly explained by rich inclusions formed in the UO₂ fuel—the mechanism of which had been observed in normal power plant operation. Ruthenium could have been released in an oxidized form (RuO₄ mp is 25.5°C), which could explain the “volatile” ruthenium release. Fuel oxidation in the high-temperature fire during core meltdown produced ruthenium vapors out of the UO₂ matrix, which then would have condensed onto fine particles. In the late—and hottest—phases of the reactor burning, their dispersion into the air would then correlate with the dispersion of volatile cesium. The amounts of zirconium, niobium, and cerium radioactivity were in agreement with those expected for the fuel burn-up at the time of the accident (Jantunen et al., 1991). Average burn-up estimated by various research groups ranged from 7,500–15,000 GWd(tU)⁻¹ as compared with the early Soviet estimate of 10,300 GWd(tU)⁻¹ (Petrosyants, 1986). Studies concerning the behavior of ruthenium in high temperatures are ongoing (Kärkelä et al., 2006).

Microscopic X-ray analysis of hot particles showed also that uranium was the bulk material of most individual particles, confirming that pure, solid nuclear fuel fragments were emitted during the core collapse. The fragmented shapes were confirmed from SEM pictures revealing sharp crystal formations (Raunemaa et al., 1987; Saari, 1987). On the surface of some fuel fragments, small solid spherules were ultimately identified as resulting from the melting and solidification process. In addition to fuel fragment forms, other hot particle structures and compositions were recognized. Similar to uranium, zirconium was identified as the other main element by Saari and colleagues (1989). Based on X-ray microanalysis, Salbu (1988) identified ruthenium, technetium, and molybdenum in addition to iron and nickel in a 2- μm spherical particle situated on the surface of a large silicon-containing particle. Zirconium and steel material are used in the fuel rods and fuel channels, and their presence in fallout particles confirms the core melting process.

There is a considerable scientific and public interest in the nuclide activity ratios in nuclear power plants, especially in the core fuel. Chernobyl fallout debris represents the minute core inventory at the release time, and the nuclide ratios reveal both the age of the core's fuel and whether the reactor was used to extract plutonium. From the measurement data, researchers found that the average fuel age was 2 years, and from this, it could be seen that no monthly removal of fuel elements had been conducted.

An important outcome in identifying radioactive hot particles was the intensification of studying their health effects. A particle causes local, nonstochastic damage in its closest location in a human body and may introduce possible long-term effects. Health effect studies were initiated on these after Chernobyl, as in Finland (Lang & Raunemaa, 1991; Pöllänen, 2002; Rytömaa et al., 1986b).

Radionuclides in the Indoor Air

Since most of the fallout was because of rain washout, initially very little of it entered indoors. However, penetration of resuspended, contaminated soil dust from outdoor air and transport of the dust located on shoes transported Chernobyl fallout indoors, and the respective measurements were used as a tool to identify indoor accumulation and to determine the outdoor-to-indoor transport ratios. Indoor concentrations are influenced by house filtration and ventilation, indoor activity, resuspension, and wall deposition mechanisms. The surface accumulation of radioactive particles was studied at the

Department of Physics at the University of Helsinki by using surface wiping and vacuuming techniques to collect samples from solid surfaces. Analysis from gamma-active aerosol accumulated within 19 days of the accident (Kulmala & Raunemaa, 1988) indicated that most dust activity indoors originated in sand and soil transported by humans. From wipe samples, a mean surface activity was estimated to be 3 Bq/m² for ¹³⁷Cs. By assuming a 1-month deposition period, the calculated deposition velocity was 0.003 cm/s. To specify the outdoor-to-indoor transport in dwellings, an indoor aerosol model was developed (Kulmala et al., 1988).

Radioecology

The extremely sharp radioactivity pulse generated by the Chernobyl fallout affected biological processes and in turn served as a very precise analytical tool in ecological research. Researchers used the Chernobyl fallout as an indicator to analyze aerial deposition characteristics in the outdoor environment (Lang et al., 1988; Reponen et al., 1993); to measure the consequences of using the 1986 peat to fuel peat power plants (Jantunen et al., 1992); and to analyze the radioactivity transport in Scots pine trees, using this to identify nutrient transport in trees and applying it to forest growth modeling (Hari, 1988; Nygren et al., 1994). The unusual situation created during the release initiated considerations about core compound chemical behavior at high temperatures, and the plume transport produced striking data about dispersion of a gaseous and aerosol pollutant mix over long distances.

In forest science, the alkali metal cesium isotopes were employed as timed tracers to study nutrient cycles and canopy interactions since all of the cesium radioactivity exceeding the background level were of this origin. Cesium is chemically analogous to potassium and is supposed to behave the same way as potassium in plant metabolism (Hari, 1988; Hari et al., 1986). The cycling of cesium in a young Scots pine stand was investigated in 1986 and 1987 at the Hyytiälä Forestry Field Station in central Finland by collecting needles from 13 randomly located trees. Cesium concentrations decreased slowly during the summer of 1986 because of the leaching process, but a sharp increase in cesium was observed in new needles formed during late summer 1987. Since new needles had not formed during the deposition phase, the only way for cesium to get into the new needles was by metabolic transport. Cesium can be metabolized directly through the leaves or through soil and solution.

Direct uptake was inferred from two phenomena: (1) high concentrations were found in the needles when the first measurements were taken, and (2) the concentration pattern was similar between old and new needles. Cesium entering through metabolism is explained by gathering ions from wet and dry deposition and recycling the cations leached from leaves. Cesium in needles can, thus, originate either from older needles and is recycled within the tree or from soil through normal nutrient uptake. High concentrations in new needles indicate internal cycling, and an increase in all needle classes in 1987 was then attributed to the nutrient uptake from soil (Nygren et al., 1994).

Peat is used in Finland to fuel large peat-powered boilers of 100 MW power scale. Before the Chernobyl accident, peat ash from some boiler plants was used as concrete filler. The total amount of peat for boilers harvested in summer 1986 was some 2.2 million tons from about 27,000 ha of bogs. This amount of peat contained an estimated ^{137}Cs activity of 4–5 TBq (Jantunen et al., 1991; Mustonen et al., 1989). Calculations made by STUK soon revealed that concrete containing peat ash with the estimated levels of ^{134}Cs and ^{137}Cs would, if used for building houses, result in unacceptable external gamma radiation doses for the entire service life of the buildings, and peat ash use for concrete was thereby forbidden, until its safety and acceptability could be reconfirmed. The concentration of ^{137}Cs in peat fly ash varied between 14–100 kBq/kg, which is two orders of magnitude above the pre-Chernobyl level.

At the Department of Radiochemistry at the University of Helsinki, the deposition of the transuranium elements plutonium, americium, and curium, and their transfer along the terrestrial food chains and in lakes, was thoroughly investigated (Paatero, 2000; Paatero & Jaakkola, 1998; Paatero et al., 1998; Pilviö, 1998; Salminen et al., 2005). The deposition of $^{239,240}\text{Pu}$, ^{241}Am , and ^{244}Cm in most of the reindeer husbandry area was $<0.25\text{ Bq/m}^2$, $<0.036\text{ Bq/m}^2$, and $<0.023\text{ Bq/m}^2$, respectively. Only in the southernmost reindeer herding district of Halla were the deposition values some three times higher. The biological half-lives of plutonium and americium in lichen (*Cladonia sp.*) were found to be 730 and 320 days, respectively. The activity concentrations of $^{239,240}\text{Pu}$ in reindeer liver (0.0094–0.062 Bq/kg dry weight) were low compared with the concentrations found in the 1960s, even though most of the samples were from the Halla reindeer herding district. However, the ^{241}Pu activity concentrations found were comparable to those observed in the 1960s. ^{137}Cs was found to transfer from fallout to reindeer meat 100 times

more efficiently than americium and 10,000 times more efficiently than plutonium. The behavior of transuranium elements in the Baltic Sea has been studied by Ikäheimonen (2003).

To recognize possible routes of radionuclides into humans, STUK conducted an extensive monitoring program of foodstuff. About 5,000 samples were analyzed for radiocesium during the first 2 years after the accident (Rantavaara, 1988). Within the first 12 months, the mean internal dose from radiocesium was 0.15–0.20 mSv. The highest contributions to the average daily dietary intake of ^{137}Cs within the first year originated in milk and during the second year in fish. According to the 1986–1987 population survey, the mean body burden of ^{137}Cs at the end of 1986 was on average 2 kBq as compared with 0.54 kBq before the accident. The body burden decreased considerably after this maximum (Rahola & Suomela, 1988).

In Finland, with the exception of the southernmost reindeer herding districts, no significant restrictions for the use of reindeer meat were issued by STUK. However, in central Finland, it was recommended that fish from small lakes should not be consumed more than three times a week. Similar countermeasures were also put in place for mushrooms (Ikäheimonen, 2006). In Sweden, about 100,000 reindeers were slaughtered because of suspected radioactivity intake in their diet. This inflicted severe socioeconomic troubles among the reindeer herders.

Aftermath of the Accident

A wide variety of consequences resulted from the Chernobyl accident both in Finland and in Sweden. Medical consequences were luckily mild, the most notable symptoms being psychological ones. No increase in thyroid cancer occurrence has been observed in Finland (Ikäheimonen, 2006).

Based on the lessons learned from this accident, numerous efforts have aimed to improve information dissemination, including improving international and interagency communication and responding to the information demands from the mass media and the general public. However, researchers submitting manuscripts about the Chernobyl accident noted strange behavior among scientific publishers. A considerable number of Chernobyl manuscripts from Finland and other countries were sent to the journal *Nature* in 1986. Many of the authors received a note of acceptance for publication or even galley proofs, but to date none of these works have been published. At first, *Nature* did not reply to inquiries about the fate of the

manuscripts (Kauranen, 1988). Finally, a signed, open letter was submitted to *Nature* requesting an explanation about why numerous Chernobyl-related articles were accepted but never published. *Nature* did not publish this open letter, but the British science magazine *The New Scientist* (Milne, 1988) reported on it and *Nature's* odd behavior. *Nature* did publish an explanation for not publishing accepted papers, citing that they received an overload of Chernobyl-related manuscripts ("Uncensored *Nature*," 1988).

The Chernobyl accident boosted radioecological research, which had calmed down after the last atmospheric nuclear test in China in October 1980. Important new results concerning, among other things, hot particles have been achieved. The Chernobyl signal can be used for a long time in, for example, the sediment core dating. The observations of airborne radioactivity are still used in validating atmospheric dispersion models.

The most important effects of the accident in Finland and Sweden were, however, increased public awareness about environmental issues, in general, and nuclear energy, in particular. After a public referendum in 1980, Sweden decided to abandon nuclear energy following the aftermath of the 1978 Three Mile Island accident. But in Finland, the nuclear energy program was halted, and not until 2002 did the Parliament of Finland decide to accept the building license application for the fifth nuclear reactor in Finland.

Epilogue

Our co-author and friend Dr. Taisto Raunemaa died while jogging in a forest close to his home in Espoo, Finland, on June 12, 2006. He was the pioneer of aerosol science in Finland, a great visionary, and an outstanding researcher. Immediately after the Chernobyl accident, Taisto Raunemaa actively initiated research projects focusing on environmental effects of the radioactive fallout. He was the initiator of the review work presented here. We dedicate this chapter to Taisto's memory.

References

- Anttila, M. (1986). The activity content of an RBMK-reactor. Technical Report No. TSHERNO-2/86. *Technical Research Centre of Finland, Helsinki*, 10.
- Anttila, P., Kulmala, M., & Raunemaa, T. (1987). Dry and wet deposition of chernobyl aerosols in Southern Finland. *Journal of Aerosol Science*, 18(6), 939–942.

- Arvela, H., Blomqvist, L., Lemmelä, H., Savolainen, A.-L., & Sarkkula, S. (1987). Environmental gamma radiation measurements in Finland and the influence of meteorological conditions after the Chernobyl accident in 1986. STUK-A65. *Finnish Centre for Radiation and Nuclear Safety, Helsinki*, 40.
- Arvela, H., Markkanen, M., & Lemmelä, H. (1990). Environmental gamma radiation and fall-out levels in Finland after the Chernobyl accident. *Radiation Protection Dosimetry*, 32, 177–184.
- Arvela, H., Markkanen, M., Lemmelä, H., & Blomqvist, L. (1989). Environmental gamma radiation and fallout measurements in Finland, 1986–87. STUK-A76. *Finnish Centre for Radiation and Nuclear Safety, Helsinki*, 32.
- Devell, L., Tovedal, H., Bergstrom, U., Appelgren, A., Chyssler, J., & Andersson, L. (1986). Initial observations of fallout from the reactor accident at Chernobyl. [10.1038/321192a0]. *Nature*, 321(6067), 192–193.
- Finnish Centre for Radiation and Nuclear Safety. (1986a). Väliaikainen raportti säteilytilanteesta Suomessa 26.4.-4.5.1986 (Interim report on fallout situation in Finland from April 26 to May 4 1986.) STUK-B-VALO Report 44. *Finnish Centre for Radiation and Nuclear Safety, Helsinki*, 40.
- Finnish Centre for Radiation and Nuclear Safety. (1986b). Toinen väliaikaisraportti säteilytilanteesta Suomessa 5.-16.5.1986 (Second interim report on fallout situation in Finland from May 5 to May 16 1986.) STUK-B-VALO Report 45. *Finnish Centre for Radiation and Nuclear Safety, Helsinki*, 48.
- Grasty, R. L., Hovgaard, J., & Multala, J. (1997). Airborne gamma ray measurements in the Chernobyl plume. *Radiation Protection Dosimetry*, 73(1–4), 225–230.
- Hari, P. (1988). Chernobyl fallout cesium in pine canopy, in: Kulmala, M., Luokkanen, S., Aspila, P. (Eds.), Symposium on Chernobyl fallout studies, Helsinki 9.12.1988. Report Series in Aerosol Science No. 7. *Finnish Association for Aerosol Research, Helsinki*, 52–54.
- Hari, P., Holmberg, M., Raunemaa, T., Kulmala, M., Saari, H., Mäkelä, J., . . . Björklund, A. (1986). Chernobyl signal in Finnish forests. Accepted for publication in *Nature*.

- Ikäheimonen, T. K. (2003). Determination of transuranic elements, their behaviour and sources in aquatic environment. STUK-A-194. STUK—*Radiation and Nuclear Safety Authority, Helsinki*, 82.
- Ikäheimonen, T. K. E. (2006). Ympäristön radioaktiivisuus Suomessa—20 vuotta Tshernobylista. Symposium Helsingissä 25.-26.4.2006 (Environmental Radioactivity in Finland—20 Years since Chernobyl. Symposium in Helsinki 25.-26.4.2006). STUK-A-217. *STUK—Radiation and Nuclear Safety Authority, Helsinki*, 223.
- International Atomic Energy Agency. (1986). Summary report on the post-accident review meeting on the Chernobyl accident. Safety Series No. 75-INSAG-1. *International Atomic Energy Agency, Vienna*, 106.
- Israelsson, S., & Knudsen, E. (1986). Effects of radioactive fallout from a nuclear power plant accident on electrical parameters. *Journal of Geophysical Research*, 91(D11), 11909–11910.
- Jaakkola, T., Mussalo, H., & Tiainen, S. (1979). Plutonium in the Helsinki air during 1962–1977. Paper No. 99, in: Radioactive Foodchains in the Subarctic Environment: Final Report of the Project. *University of Helsinki, Department of Radiochemistry, Helsinki*, 60–67.
- Jaakkola, T., Suutarinen, R., & Paatero, J. (1986). Transuraanialkuaineiden esiintyminen ympäristössä (Transuranium elements in the environment), in: Kulmala, M., Saari, H., Kauranen, P. (eds.), Seminar on effects of the Chernobyl accident in Finland, Helsinki 10.11.1986. Report series in aerosol science No 2. *Finnish Association for Aerosol Research, Helsinki*, 31–32.
- Jantunen, M., Reponen, A., Kauranen, P., & Vartiainen, M. (1991). Chernobyl fallout in southern and central Finland. *Health Physics*, 60(3), 427–434.
- Jantunen, M., Reponen, A., Mustonen, R., Itkonen, A., & Kauranen, P. (1992). Behaviour of the Chernobyl fallout nuclides in peat combustion. *Health Physics*, 62(3), 245–249.
- Jaworowski, Z., & Kownacka, L. (1988). Tropospheric and stratospheric distributions of radioactive iodine and cesium after the Chernobyl accident. *Journal of Environmental Radioactivity*, 6(2), 145–150.

- Jernström, J. (2006). Development of analytical techniques for studies on dispersion of actinides in the environment and characterization of environmental radioactive particles. Report Series in Radiochemistry 26/2006. *University of Helsinki, Laboratory of Radiochemistry, Helsinki*, 65.
- Jylhä, K. (1991). Empirical scavenging coefficients of radioactive substances released from chernobyl. *Atmospheric Environment. Part A. General Topics*, 25(2), 263–270.
- Kärkelä, T., Backman, U., Auvinen, A., Zilliacus, R., Lipponen, M., Kekki, T., et al. (2006). Transport of ruthenium in diverse oxidising conditions, in: Vehkamäki, H., Bergman, T., Julin, J., Salonen, M., Kulmala, M. (Eds.), NOSA 2006 Aerosol Symposium, combined with the X Finnish National Aerosol Symposium, Finnish-Czech Aerosol Symposium, and BACCI workshop, Helsinki 8.10.11.2006. Report Series in Aerosol Science No. 83. *Finnish Association for Aerosol Research, Helsinki*, 184–185.
- Kauppinen, E. I., Hillamo, R. E., Aaltonen, S. H., & Sinkko, K. T. S. (1986). Radioactivity size distributions of ambient aerosols in Helsinki, Finland, during May 1986 after Chernobyl accident: preliminary report. *Environmental Science & Technology*, 20(12), 1257–1259.
- Kauranen, P. (1988). Introduction, in: Kulmala, M., Luokkanen, S., Aspila, P. (Eds.), Symposium on Chernobyl fallout studies, Helsinki 9.12.1988. Report Series in Aerosol Science No. 7. *Finnish Association for Aerosol Research, Helsinki*, 1–2.
- Kettunen, M. (2006). Säteilylähteiden etsintä ja laskeuman kartoitus ilmaluoksista (Search for radiation sources and mapping of fallout from aircrafts), in: Ikäheimonen, T.K. (Ed.), Ympäristön Radioaktiivisuus Suomessa—20 vuotta Tshernobylistä. Symposium Helsingissä 25.-26.4.2006. STUK-A-217. *STUK—Radiation and Nuclear Safety Authority, Helsinki*, 129–134.
- Kirchner, G., & Noack, C. C. (1988). Core history and nuclide inventory of the Chernobyl core at the time of accident. *Nuclear Safety*, 29, 1–5.
- Koivukoski, J. (1986). Radiation maps over southern Finland. *Ministry of Interior, Helsinki*.

- Kulmala, M., & Raunemaa, T. (1988). Surface accumulation of gamma-active particles and transportation from outdoor to indoor, in: Kulmala, M., Luokkanen, S., Aspila, P. (Eds.), Symposium on Chernobyl fallout studies, Helsinki 9.12.1988. Report Series in Aerosol Science No. 7. *Finnish Association for Aerosol Research, Helsinki*, 40–45.
- Kulmala, M., Raunemaa, T., Mecke, M., Saari, H., Keronen, P., & Issakainen, E. (1988). Indoor surface accumulation of radioactive particles after Chernobyl fallout. *Journal of Aerosol Science*, 19, 1359–1361.
- Lancsarics, G., Fehér, I., Sági, L., & Pálfalvi, J. (1988). Transuranium elements in the hot particles emitted during the Chernobyl accident. *Radiation Protection Dosimetry*, 22(2), 111–113.
- Lang, S., & Raunemaa, T. (1991). Behaviour of neutron activated UO_2 dust particles in the gastrointestinal tract of the rat. *Radiation Research*, 126(3), 273–279.
- Lang, S., Raunemaa, T., Kulmala, M., & Rauhamaa, M. (1988). Latitudinal and longitudinal distribution of the Chernobyl fallout in Finland and deposition characteristics. *Journal of Aerosol Science*, 19, 1191–1194.
- Linden, A., & Mellander, H. (1986). Airborne measurements in Sweden of the radioactive fallout after the nuclear reactor accident in Chernobyl, USSR. TFRAP report 8606. *Swedish Geological Company*.
- Luokkanen, S., Kulmala, M., & Raunemaa, T. (1988a). Characteristics of hot areas in Finland, in: Kulmala, M., Luokkanen, S., Aspila, P. (Eds.), Symposium on Chernobyl fallout studies, Helsinki 9.12.1988. Report Series in Aerosol Science No. 7. *Finnish Association for Aerosol Research, Helsinki*, 46–51.
- Luokkanen, S., Kulmala, M., & Raunemaa, T. (1988b). Chernobyl fallout in Finland: hot areas. *Journal of Aerosol Science*, 19, 1363–1366.
- Mattsson, R., & Hatakka, J. (1986). Hengitysilman kuumat hiukkaset Tshernobylin jälkeisinä päivinä (Hot particles in the respirable air in the days after Chernobyl), in: Kulmala, M., Saari, H., Kauranen, P. (Eds.), Seminar on effects of the Chernobyl accident in Finland, Helsinki 10.11.1986. Report Series in Aerosol Science No. 2. *Finnish Association for Aerosol Research, Helsinki*, 28–30.

- Milne, R. (1988). Mystery of Nature's Chernobyl fallout. *New Scientist*, 120(1640), 15.
- Moore, D. T., Beck, J. N., Miller, D. K., & Kuroda, P. K. (1973). Radioactive hot particles from the recent Chinese nuclear weapons tests. *Journal of Geophysical Research*, 78, 7039–7049.
- Mustonen, R., Reponen, A., & Jantunen, M. (1989). Artificial radioactivity in fuel peat and peat ash in Finland after the Chernobyl accident. *Health Physics*, 56, 451–458.
- Nordlund, G. (1986). Kaukokulkeutuminen Suomeen ja kulkeutuminen muualle Eurooppaan (Long-range transport to Finland and transport to other parts of Europe), in: Kulmala, M., Saari, H., & Kauranen, P. (Eds.), Seminar on effects of the Chernobyl accident in Finland, Helsinki 10.11.1986. Report Series in Aerosol Science No. 2. *Finnish Association for Aerosol Research, Helsinki*, 3–4.
- Nygren, P., Hari, P., Raunemaa, T., Kulmala, M., Luokkanen, S., Holmberg, M., et al. (1994). Behaviour of cesium-137 from Chernobyl fallout in a Scots Pine canopy in Southern Finland. *Canadian Journal of Forest Research*, 24, 1210–1215.
- Paatero, J. (2000). Deposition of Chernobyl-derived transuranium nuclides and short-lived radon-222 progeny in Finland. Contributions No. 28. *Finnish Meteorological Institute, Helsinki*, 128.
- Paatero, J., & Jaakkola, T. (1998). Transfer of plutonium, americium and curium from fallout into reindeer after the Chernobyl accident. *Boreal Environment Research*, 3, 181–189.
- Paatero, J., Jaakkola, T., & Ikäheimonen, T. K. (2002). Regional distribution of Chernobyl-derived plutonium deposition in Finland. [10.1023/A:1015795028775]. *Journal of Radioanalytical and Nuclear Chemistry*, 252(2), 407–412.
- Paatero, J., Jaakkola, T., & Kulmala, S. (1998). Lichen (sp. *Cladonia*) as a deposition indicator for transuranium elements investigated with the Chernobyl fallout. *Journal of Environmental Radioactivity*, 38(2), 223–247.
- Paatero, J. R. M., & Hatakka, J. (1994). Measurements of airborne radioactivity in Finland, 1983–1990, and applications to air quality studies. Publications on Air Quality No. 17. *Finnish Meteorological Institute, Helsinki*, 106.

- Persson, C., Rodhe, H., & De Geer, L.-E. (1986). Tjernobylyolyckan—En meteorologisk analys av hur radioaktivitet spreds till Sverige (The Chernobyl accident—A meteorological analysis of how radionuclides reached Sweden). SMHIMeteorologi No. 24. *Swedish Meteorological and Hydrological Institute, Norrköping, Sweden*, 45.
- Persson, C., Rodhe, H., & De Geer, L.-E. (1987). The Chernobyl accident—a meteorological analysis of how radionuclides reached and were deposited in Sweden. *Ambio*, 16, 20–31.
- Petrosyants, A. (1986). The Soviet Union and the development of nuclear power: an overview of plans and the Chernobyl accident. *IAEA Bulletin* 28, 5–8.
- Pilviö, R. (1998). Methods for the determination of low-level actinide concentrations and their behaviour in the aquatic environment. Report Series in Radiochemistry 10/1998. *University of Helsinki, Laboratory of Radiochemistry, Helsinki*, 43.
- Pöllänen, R. (2002). Nuclear fuel particles in the environment—characteristics, atmospheric transport and skin doses. STUK-A-188. *STUK—Radiation and Nuclear Safety Authority, Helsinki*.
- Pöllänen, R., Valkama, I., & Toivonen, H. (1997). Transport of radioactive particles from the chernobyl accident. *Atmospheric Environment*, 31(21), 3575–3590.
- Puhakka, T., Jylhä, K., Saarikivi, P., Koistinen, J., & Koivukoski, J. (1990). Meteorological factors influencing the radioactive deposition in Finland after the Chernobyl accident. *Journal of Applied Meteorology*, 29(9), 813–829.
- Rahola, T., & Suomela, M. (1988). Radiocesium amounts in Finns—changes since the 1960s, in: Kulmala, M., Luokkanen, S., Aspila, P. (Eds.), Symposium on Chernobyl fallout studies, Helsinki 9.12.1988. Report Series in Aerosol Science No. 7. *Finnish Association for Aerosol Research, Helsinki*, 17–20.
- Rantavaara, A. (1988). Radiocesium in domestic foodstuffs in Finland 1986–1988, in: Kulmala, M., Luokkanen, S., Aspila, P. (Eds.), Symposium on Chernobyl fallout studies, Helsinki 9.12.1988. Report Series in Aerosol Science No. 7. *Finnish Association for Aerosol Research, Helsinki*, 11–16.

- Raunemaa, T. (1986). Kuumien hiukkasten esiintyminen Suomessa (Hot particles in Finland), in: Kulmala, M., Saari, H., Kauranen, P. (Eds.), Seminar on effects of the Chernobyl accident in Finland, Helsinki 10.11.1986. Report Series in Aerosol Science No. 2. *Finnish Association for Aerosol Research, Helsinki*, 16–18.
- Raunemaa, T., Lehtinen, S., Saari, H., & Kulmala, M. (1987). 2–10 μm sized hot particles in Chernobyl fallout to Finland. *Journal of Aerosol Science*, 18, 693–696.
- Reineking, A., Becker, K. H., Porstendörfer, J., & Wicke, A. (1987). Air activity concentrations and particle size distributions of the Chernobyl aerosol. *Radiation Protection Dosimetry*, 19(3), 159–163.
- Reponen, A. (1992). Behaviour of Chernobyl fallout nuclides deposited on peat and urban surfaces in Finland. Publications of the National Public Health Institute NPHI-A7/1992. *National Public Health Institute, Kuopio, Finland*, 59.
- Reponen, A., & Jantunen, M. (1991). Removal rates of Chernobyl radioactivity on urban surfaces. *Health Physics*, 60(4), 569–573.
- Reponen, A., Jantunen, M., Paatero, J., & Jaakkola, T. (1993). Plutonium fallout in Southern Finland after the Chernobyl accident. *Journal of Environmental Radioactivity*, 21(2), 119–130.
- Rytömaa, T., Servomaa, K., & Toivonen, H. (1986a). Tšernobylin ydinvoimalaturmassa syntyneet kuumat hiukkaset: mahdollinen vaara terveydelle Suomessa (Hot particles from the Chernobyl nuclear accident: potential threat towards the human health in Finland). *Duodecim*, 102, 1190–1196.
- Rytömaa, T., Toivonen, H., Servomaa, K., Sinkko, K., & Kaituri, M. (1986b). Uranium aerosols in Chernobyl fallout. *Finnish Centre for Radiation and Nuclear Safety, Helsinki, Finland. Submitted to Nature in 1986*.
- Saari, H. (1987). Kuumat hiukkaset Tšernobylin ydinvoimalaonnettomuuden laskeumassa (Hot particles in the fallout of the Chernobyl nuclear power plant accident). M.Sc. Thesis, University of Helsinki, Department of Physics. 91.

- Saari, H., Luokkanen, S., Kulmala, M., Lehtinen, S., & Raunemaa, T. (1989). Isolation and characterization of hot particles from Chernobyl fallout in Southwestern Finland. *Health Physics*, 57, 975–984.
- Salbu, B. (1988). Radionuclides associated with colloids and particles in the Chernobyl fallout. Agricultural University of Norway, Aas-NHL, Norway. Internal report.
- Salminen, S., Paatero, J., Jaakkola, T., & Lehto, J. (2005). Americium and curium deposition in Finland from the Chernobyl accident. *Radiochimica Acta*, 93, 771–779.
- Salonen, L. (1987). Carbon-14 and tritium in air in Finland after the Chernobyl accident. *Radiochimica Acta*, 41, 145–148.
- Sandalls, F. J., Segal, M. G., & Victorova, N. (1993). Hot particles from Chernobyl—a review. *Journal of Environmental Radioactivity*, 18(1), 5–22.
- Savolainen, A.-L., Hopeakoski, T., Kilpinen, J., Kukkonen, P., Kulmala, A., & Valkama, I. (1986). Dispersion of radioactive releases following the Chernobyl nuclear power plant accident. Interim report. Reports 1986:2. *Finnish Meteorological Institute, Helsinki*, 44.
- Sinkko, K., Aaltonen, H., Mustonen, R., Taipale, T. K., & Juutilainen, J. (1987). Airborne radioactivity in Finland after the Chernobyl accident in 1986. *STUK—A56. Finnish Centre for Radiation and Nuclear Safety, Helsinki*, 42.
- Sisefsky, J. (1964). Investigation of nuclear weapon debris with X-ray microanalyser. [10.1038/203708a0]. *Nature*, 203(4946), 708–710.
- Sisefsky, J., & Persson, G. (1970). Fractionation properties of nuclear debris from the Chinese test of 24 December 1967. *Health Physics*, 18(4), 347–356.
- Suutarinen, R. (1986). Transuraanipitoisuuksien määrittäminen sadevesinäytteistä (Determination of transuranium elements in precipitation samples). Internal report 15.5.1986. *University of Helsinki, Department of Radiochemistry*, 3.
- Tuomi, T. (1988). Observations of atmospheric electricity 1986. Geophysical Publications No. 7. *Finnish Meteorological Institute, Helsinki*, 61.
- Tuomi, T. (1989). Ten-year summary 1977–1986 of atmospheric electricity at Helsinki-Vantaa Airport, Finland. *Geophysica*, 25, 1–20.

Uncensored Nature. [Opinion]. (1988). *Nature*, 336, 294.

Valkama, I., Salonoja, M., Toivonen, H., Lahtinen, J., & Pöllänen, R. (1995). Transport of radioactive gases and particles from the Chernobyl accident, in: Environmental impact of radioactive releases. IAEA-SM-339/69. *International Atomic Energy Agency, Vienna*, 57–68.

von Philipsborn, H., & Steinhäusler, F. (1988). Hot particles from the Chernobyl fallout. Proceedings of an International Workshop held in Theuern 28/29 October, 1987. Band 16. Schriftenreihe des Bergbau und Industriemuseums Ostbayern Theuern, Germany. 147.

The Development of FIDO (Fog Intensive Dispersal Operation)

Ian Colbeck

Introduction

Fog disposal research has been carried out for more than 100 years. Early patents concerned fog dispersal for the safety of trains and boats. For instance, in 1896 a patent entitled “A New or Improved Method of, and Apparatus for, Dispersing or Otherwise Removing Fog from the Path of Moving Bodies or Vessels” postulated that fog could be removed by spraying a liquid or liquefied gas of greater density than the constituents of the fog in advance of the moving body or vessel (G.B. Patent No. 189608928, 1896).

With the introduction of aircraft, especially in warfare, emphasis began to be placed on clearing runways of fog. In 1923, questions were raised in the House of Commons regarding the United Kingdom’s awareness of work on fog dispersal, using electrically charged sand, by the US Army Air Service (Brooks, 1923). Investigations into fog dispersal continued throughout the 20th century; even today, patents are still being filed on the subject.

Any method of fog dissipation technique requires a basic knowledge of fog formation and decay. A combination of two basic factors appears to control fog formation (Mason, 1957). These are the concentration and type of nuclei and the concentration and temperature of the water vapor. To succeed, fog dispersal techniques must change at least one of these basic parameters.

Many methods, including the use of supersonic waves, electrical discharges, drying by refrigerating and outdoor air conditioning apparatus, had been tried in both the United States and the United Kingdom. Brunt (1936, 1939) concluded that only two methods needed to be seriously considered: the chemical method and the thermal method. The first aimed to remove part of the water vapor from the air, with consequent evaporation of the water drops. Brunt proposed that a saturated solution of calcium chloride would be sprayed into the air. However, the spray would have to be distributed from

pipes at about the level of the top of the fog. Such a pipe installation would be a formidable obstacle on an aerodrome. The pipes and nozzles used for the projection would also be susceptible to serious corrosion. If the method were to be available for use at short notice, very large and costly storage tanks would have to be installed; alternatively, if the chloride were stored dry, a plant would be required for rapidly dissolving the very large amounts needed. Brunt concluded that the various difficulties made the chemical method an unlikely practical solution to the problem of fog dissipation.

The second method suggested was based on heating. Brunt calculated that if initially the temperature within the fog increases by 5°C from the ground to 110 yards, it would be necessary to heat the air sufficiently to convert the variation of temperature with height to the adiabatic rate to cause the fog to dissipate. The temperature at the top of the fog would have to be increased by 0.5°C in order to evaporate the fog droplets at that level, and the surface temperature would have to be increased by 6.5°C , thus requiring an average temperature increase of 3.5°C through the fog. The heat required could be obtained by burning 7,500 cubic feet of domestic gas, or about 20 gallons of paraffin per minute.

Trials were carried out between 1936 and 1939 by staff of the Royal Aircraft Establishment. The first experiments involved trays containing smokeless liquid fuels; this was succeeded by agricultural spray burners fed by pipes. Further developments involved two 600-foot pipelines at right angles to each other, with burners 10 feet apart, until finally the pipelines were doubled and the burners staggered so that they were effectively 5 feet apart. For a fuel consumption of 8 gallons per burner per hour, test results indicated that visibility could be increased threefold. The heat generated was not sufficient to raise the temperature by the required amount to fully dissipate the fog. However, the test had shown that the method was feasible. Because of the predicted high fuel consumption, further work was abandoned with the outbreak of World War II (WWII).

Development

In the early stages of WWII, Royal Air Force (RAF) aircraft and their crews were being lost at a faster rate than they could be produced and trained. The War Cabinet became aware that the losses due to crashes not caused by enemy action were significant and they identified fog as a major factor.

Lord Cherwell reported to Prime Minister Winston Churchill that urgent action was required.

For some years, work was done in a leisurely fashion by the Air Ministry on the best way of clearing aerodromes of fog. Though the experiments were promising, they were discontinued. It may be that the expenditure is too great to justify the adoption of these methods in peace-time; but such arguments have no weight today. In view of the appalling losses we occasionally suffer from unexpected fogs...it seems urgent to take up this work again.... If we have even two or three aerodromes fitted to disperse fog in case of need the cost would be recovered in a very short time (quoted in Williams, 1995).

Experts did not hold out much hope of success, but Churchill, after consulting with staff from the Air Ministry and the Ministry of Aircraft Production decided to entrust the task to the Petroleum Warfare Department (PWD). Within days, the PWD experimental station at Moody Down and an unfinished reservoir at Staines were in a position to conduct trials. In addition, wind tunnel experiments could be undertaken at the Earl's Court ice-skating rink.

The project had several, short-lived names (Williams, 1995). It was suggested by Lyn Urwick of the PWD that FIDO (Fog Intensive Dispersal Operation) would compliment PLUTO (Pipe Line Under The Ocean), which was already in use. The earliest documents referring to FIDO date from September 26, 1942 (Williams, 1995).

At Moody Down, petrol burners were installed, and the initial experiment of November 4, 1942, cleared the fog between two rows of burners 160 yards long and 100 yards apart. However, this produced considerable smoke. On the same day, coke braziers were used at Staines, and clearance was confined to ground level due to the low heat output. As a result, an experimental coke-burning installation was installed at Lakenheath. Considerable effort was invested into improving the petrol burners before adopting the HAIGAS (Hartley Anglo-Iranian Gas) burner. Here the delivery pipes were laid around the burner so that the incoming petrol was heated prior to combustion. Another pipe was perforated and the escaping petrol vapor was lit so that the petrol flames extended beside the runway like two walls of flame. This system was installed at Graveley airfield.

Field Trials

The initial requirement set by the RAF was for a space 1,000 yards long and 100 feet high over the runway to be cleared of fog. For safety reasons, burners also had to be 50 yards from the edge of the runway. Brunt's earlier work was confirmed by measurements at Staines and in the Earl's Court wind tunnel: the air temperature had to be raised, on average, by 3°C–4°C for fog to clear.

The system at Graveley was tested February 18, 1943, with the successful landing of a Lancaster bomber. The pilot reported that the heat from the burners had produced little turbulence and that the conditions were like daylight. The runway could be seen from a distance of 60 miles, whereas searchlights were visible from only 5 to 10 miles. Clearance was given by the PWD for FIDO to be installed at the Downham Market airfield. Throughout these trials, work continued on improving the burners and the Hartley Anglo-Iranian Gill (HAIGILL) design replaced the HAIGAS. With the HAIGILL design, 40 gallons per yard per hour could be burned with no smoke, and the pipe work was easy to install with the minimum of obstruction.

Successful trials in foggy weather were held July 16–17, 1943. Visibility was between 100 yards and 200 yards, and FIDO was able to clear the runway for several takeoffs and landings. The Air Ministry gave permission for several FIDOs to be installed elsewhere.

Concurrent research with the coke braziers was not as promising due to problems increasing the heat output and the difficulties of transporting and handling vast quantities of coke. The Lakenheath installation consisted of 340 braziers; 9 feet 6 inches long by 3 feet 9 inches wide, enclosing a total area of 425 yards by 150 yards. The braziers contained 70 tons of wood shavings, 90 tons of firewood, and 200 tons of coke. They were sprayed with paraffin prior to ignition. At a trial on February 20, 1943, the fires created a copious amount of black smoke, and the great heat caused a breeze of its own, which blew around burning debris. This resulted in the abandonment of such installations.

Aviation history was made on November 19, 1943, when four Halifaxes of No. 35 Squadron landed safely at Graveley in the first operational use of FIDO. By the end of 1943, 39 successful landings had been made.

Wind Tunnel Contribution

A number of full-scale experiments in the open air could have been carried out from the start. However, this would have been a very lengthy and difficult process because the lack of control over atmospheric conditions would have restricted observations to the occasions when conditions were favorable. Hence, there was the need to carry out experiments on a much smaller scale, under artificial conditions that were reproduced whenever required.

The model work had been carried out between April 1943 and December 1944. The wind tunnel was 100 feet long, 30 feet wide, and 12 feet high; the sides and roof were composed of wooden boards. At one end, the rectangular cross-section was flared down to a distance of 30 feet to a square cross-section of 12 feet side, and thereafter to a circular channel 10 feet in diameter, which housed an electric fan. The wind speed in the tunnel ranged from 0.5 feet to 5 feet per second. Initially, cup anemometers were used but it soon became evident that such anemometers were not sufficiently accurate to measure low wind speeds. In addition, for the scale of the work, the anemometers were too large and interfered with the air flow. This led to the development of the hot-wire anemometer (Simmons, 1949).

One of the main goals of the wind tunnel work was to investigate heat flow pattern downwind of a burning line with crosswinds of various strengths. The idea was to scale up the results to determine how much heat should be provided in a burning line and where the line should be placed relative to the axis of the runway so that fog clearance may be achieved to adequate heights over the middle of the runway. A scaling model was developed to predict the behavior of full-size installations and hence to specify the requirements of the successful dissipation of fog. Figure 1 shows a comparison between the model and field observations at Staines.

Operational

Several airfields were identified for the installation of FIDO (Figure 2). Most were coastal airfields that used FIDO to help bombers returning from the raids and to combat sea fog. The airfields at Carnaby in Yorkshire, Woodbridge in Suffolk, and Manston in Kent were used as emergency rescue stations, and their runways were 250 yards wide and 3,000 yards long. This posed problems because the burner lines needed to be at least 270 yards apart. Using the results of the wind tunnel experiments, it was shown that if the normal 20 gallons per yard per hour for 150 yard spacing were increased to

55 gallons, clearance could be achieved. The HAIGILL burners were capable of burning 40 gallons per yard per hour, so the solution was to install two rows of burners 20 feet apart down each side of the runway.

Figure 1. Petrol burning at Staines on December 14, 1942. Wind speed normal to the burning line at 8.5 miles per hour; convective heat flux 22.4 therms/year per hour.

Comparison of model predictions with field results (Redrawn from Rankine, 1950).

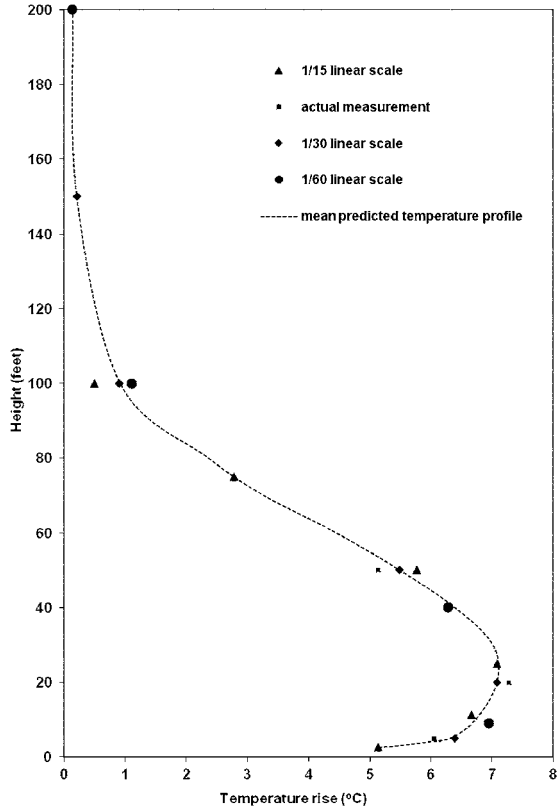
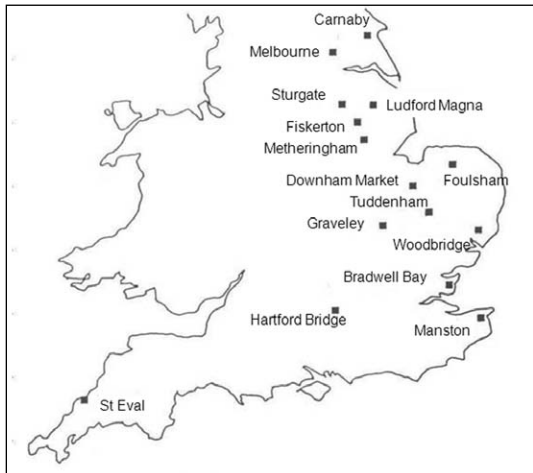

Figure 2. Location of FIDO-equipped airfields.



At every FIDO installation, storage tanks with sufficient capacity to allow 6 hours of continuous burning had to be installed. Early installations required a convoy of road tankers to meet the demand, but later all airfields were equipped with storage tanks with capacities ranging from 80,000 to 250,000 gallons. Delivery to the tanks was typically via underground pipes from a railway siding. At Woodbridge this involved a pipeline over 4 miles long, while at Manston the pipeline was 1½ miles long with an ascent of 150 feet.

By the spring of 1944, FIDO was in operation at eight airfields. Later that year, during the Ardennes Offensive, FIDO enabled 400 landings in November and 704 in December. From November 1943 until the end of the war, an estimated 3,000 allied planes took off or landed with the help of FIDO. The FIDO at Woodbridge enabled more than 90 aircraft to land one foggy afternoon in December 1944 with landings nearly every 2 minutes. Operations were fewer in February and March 1945 with 233 and 54 FIDO landings, respectively. Overall, FIDO was involved in over 2,700 operations, as shown in Table 1.

Table 1. Summary of FIDO operations

Number of landings in fog and conditions of low visibility when the whole or a major part of the installation was used	1,068
Number of landings in poor visibility when a few burners were used as markers	1,456
Number of takeoffs	182
Total	2,706

Source: Williams, 1995.

Table 2 shows the use of FIDO in fogs of various thicknesses. Not all occasions are recorded, and some records have not survived. However, this indicates that over 700 aircraft landed with the aid of FIDO, which translates into approximately 3,500 aircrew.

Table 2. Use of FIDO with visibility

Visibility (yards)	Occasions when fog lifted	Landings
1–55	14	28
55–110	29	51
110–220	28	57
220–550	46	170
550–1,100	44	416
Total	161	722

Source: Williams, 1995.

The US Navy became interested in FIDO for use in the Aleutians where bad fogs prevailed. The first installation was on the Army Air Base at Amchitka where the first aircraft test occurred on July 25, 1944. The burners were lighted just before dawn, and within 10 minutes the area over the runway and downwind of the burners had been completely cleared of fog. In August 1944, the Amchitka equipment was used tactically for the first time when, in spite of heavy fog, six aircraft were launched with the aid of FIDO to form an anti-submarine screen for President Roosevelt who was in the Adak area.

At the end of the war, the FIDO installations fell into disrepair. RAF Manston continued to use FIDO until 1949—it was on standby for London airport. After that, radar had so improved that FIDO was phased out. In 1949, a system patterned after FIDO was installed at the Los Angeles International Airport (Christensen & Frost, 1980), but this system was abandoned in 1953 after it was found to be too expensive to operate.

References

- Brooks, C. F. (1923). The Dayton experiments in fog dispersal by electrified sand. *Geographical Review*, 13, 478.
- Brunt, D. (1936). The dissipation of fog. *Transactions of the Faraday Society*, 32, 1264–1268.
- Brunt, D. (1939). The artificial dissipation of fog. *Journal of Scientific Instruments*, 16, 137–140.

- Christensen, L. S., & Frost, W. (1980). *Fog Dispersion* (NASA Contractor Report 3255). Washington, DC: NASA. Retrieved from http://ntrs.nasa.gov/archive/nasa/casi.ntrs.nasa.gov/19800011422_1980011422.pdf
- Frey, F. (1896). *G.B. Patent No. 189608928*. London, United Kingdom.
- Hartley, A. C. (1946). Fog dispersal. *Journal of the Royal Society of Arts*, 95, 22-44.
- Mason, B. J. (1957). *The physics of clouds*. London, United Kingdom: Oxford University Press.
- Rankine, A. O. (1950). Experimental studies in thermal convection. *Proceedings of the Physical Society*, 63, 225–251.
- Simmons, L. F. G. (1949). A shielded hot-wire anemometer for low speeds. *Journal of Scientific Instruments*, 26, 407–411.
- Williams, G. (1995) *Flying through fire*. Stroud, United Kingdom: Sutton Publishing Limited.

From China's Great Wall to Hollywood's Great Spy

The Story of Military Smokes and Obscurants

Christopher A. Noble

Introduction

Military smokes, also known as obscurants, have been exploited in battlefield environments for several millennia for the purposes of communicating remotely, screening from enemies, and marking intended targets. Historic records of obscurants date back to approximately 1500 BC and were first employed for military functions in the Middle East. One early application of obscurants used as smoke signals was to communicate enemy threats along the Great Wall of China. Obscurants were used, or at least described, by many of the most well-known military leaders in history, including Moses, Sun Tzu, Hannibal, and Julius Caesar. Today, obscurants are no longer used exclusively by military forces but have expanded in scope to uses as varied as recreation, engineering, religion, and even entertainment, as typified by the smoke screen deployed by James Bond's highly accessorized spy car.

Obscurants in Context

In the earliest days of obscurant use, smoke was created by the most practical and simplest means known, through the burning of wood, twigs, vegetation, animal dung, oil, pitch, or naphtha. Smoke from such fires could produce a plume of smoke that was used to signal friendly forces by sending coded messages or, on dispersing the fuel, could be used to create a smoke screen through which the enemy could not see. As an alternative to smoke—airborne particulate matter derived from incomplete combustion—fine soil and dust also were used as obscurants to create visual screens (Echols, 1952).

In military applications, obscuring smokes overlap two distinct disciplines: chemical warfare and communications.

Technically, obscurants are a specific class of chemical weapons (i.e., chemical substances that are used for offensive or defensive military functions), which can be divided into the following broad categories (Mayor, 2003; Smart, 1997):

- poisons that have a specific toxic effect on cells or organs,
- caustics that chemically burn or corrode cells or tissues,
- incendiaries that create or intensify fire,
- explosives that can be used for weapons or pyrotechnics, and
- obscurants that communicate or screen.

Military application of all categories of chemical weapons goes back over a thousand years—often, several thousands of years (Bodeau, 1993; Smart, 1997)—and, in many cases, extends into the realms of myth and folklore (Mayor, 2003). In contrast to all other chemical weapons, obscurants are not intended to cause physical damage to the environment, structures, or people. In fact, modern studies have been performed to evaluate possible health effects on combat soldiers and on the environment to minimize their deleterious influences (US National Research Council, 1997).

Because of their role in signaling, obscuring smokes also have been strongly tied to remote and secret communication from their earliest inception (Chakravarthi, 1992; Leighton, 1969; Southern, 1990). In frontier and embattled regions, beacon towers were often collocated with troop fortifications to transmit military intelligence to a nearby troop outpost for supplies or reinforcements. Beacon towers commonly used fire signals for night communications and smoke signals for daylight communications. Such beacon towers may have been stand-alone structures but more likely were part of a communication chain that might have included tens to hundreds of similar towers for transmitting military intelligence rapidly over distances of tens to hundreds of kilometers.

Both historic and modern documentation of obscurants are associated mainly with military applications and maneuvers, but records of such are found in obscure sources ranging from religious texts to oral traditions to artwork. And, though smoke signals and screens have played critical roles in military battles—at times being the difference between victory and defeat—historic records tend to report their use as an afterthought, sometimes with only a brief phrase or even a single word. The purpose of this chapter is to

provide historical highlights of the use of military smokes that, as with world history and culture, first arose in the Levant before drifting to the Far East and westward around the Mediterranean.

Obscurants in History

Israel

Likely the earliest dateable written records of both the smoke signal and smoke screen are found in the Bible associated with the Israelite exodus from Egypt (ca. 1500 BC) (Gum & Weeks, 1996). According to the biblical account, immediately following the escape of the Israelites, Egypt's Pharaoh regretted releasing the Israelites from servitude and sent his army to retrieve them (Orr, 1915). As the Egyptian army approached, the fleeing Israelites found themselves trapped between their enemy and the western banks of the Red Sea. As the pursuers gained ground, a miraculous cloud—essentially, the first smoke screen—settled between the two encampments, confounding the Egyptians and preventing them from locating their prey (Canney, 1921; Gabriel, 2003). This obscuring cloud protected Israel throughout the night and into the next day, when the Israelites escaped through the Sea. Following this victory, the Israelites wandered in the deserts of the Arabian Peninsula for 40 years, living seminomadic lives. During this time, social and religious life was centered, literally, on the Levitical tabernacle that was physically located at the middle of the national camp. Over this centralized place of worship, a signal cloud indicated to the people the national state of preparedness with a simple predefined code. When the cloud remained directly over the tabernacle, the people knew that they were to remain in their current camp location and go about the business of their daily lives. However, by lifting away from the tabernacle, the signal cloud informed the people to disassemble and bundle their tents, pack their belongings, and mobilize for relocation. For a nomadic people with a population of probably several million, this visual signal likely was the most efficient method of internal communication.

China

In his seminal work *The Art of War*, Sun Tzu briefly mentions a wartime scenario that advocates the use of smoke screens by lighting fires upwind of an enemy (ca. 500 BC) (Griffith, 1971). However, we know little more until the earliest days of imperial China (ca. 200 BC) when smoke signals were used as a threat warning system along China's Great Wall (Lovell, 2006; Turnbull,

2007). Beacon towers were situated along the length of the Wall at distances ranging from a few tenths of a kilometer up to several kilometers apart. Watchmen stationed at the beacon towers would collect grass, straw, and wolf dung as fuel for their signal fires to communicate with neighboring beacon towers. During the night, the fire itself would suffice to signal neighboring beacon towers to an imminent threat, and warned watchmen would respond by relaying the message along the signal chain until it reached a garrison that could deploy the needed soldiers. However, during daylight hours the fires often went unnoticed. So simple smoke signals were created based on the number of fires and, therefore, the number of smoke plumes rising from any given beacon tower. Though there is evidence that smoke signals were used early in China's history, the codification of China's smoke signaling system was not formalized until 1468 AD under the rule of the Ming dynasty, which brought the Great Wall to its current state of completion. Under the formalized coding, one smoke column represented up to 100 enemies, two columns indicated 500, and three columns indicated 1,000, based on the best, quick estimate by the watchmen (Guo et al., 2003). At this time, cannon fire was added to the warning routine to provide both visual and audible signaling. Using these remote communication methods, watchmen could send warnings that would travel hundreds of kilometers in a few hours, although the response could still take days to weeks depending on the distance to and the terrain between the nearest adequately equipped outpost.

India

The *Arthashastra*—an Indian political and military treatise written by Kautilya (ca. 300 BC)—provides specific recipes for different types of military smokes, as well as poisons, potions, and tonics (Chaturvedi, 2001; Mayor, 2003). Ingredients for these concoctions are quite exotic, including pigeon dung, elephant urine, peacock tail, frog eyes, insects, and lizards. And the effects of these mixtures were nearly as varied as the ingredients, ranging from insanity to “biting madness” (possibly rabies) to immediate death. The smoke of several of the powders, when burned, was purported to cause blindness. Although the resulting blindness might be the perceived result of some shamanistic curse, it also might be the simple result of an effective obscurant.

Carthage

During his legendary march to Rome in the Second Punic War (ca. 220 BC), Hannibal's army of about 50,000 Carthaginian soldiers—it was originally closer to 100,000 when Hannibal set out from New Carthage, but disease and desertion had led to a reduction in ranks—encountered Gallic resistance encamped along the eastern shore of the Rhone River (Abbott, 1902; Arnold, 1868; Church & Gilman, 1886). Hannibal used the next 3 days to rest his troops, construct boats for crossing the river, and strategize about the crossing. Knowing that his troops would be challenged by archers during the river crossing and that they would face more heated opposition on reaching the Rhone's eastern shore, Hannibal needed a means to distract the Gauls from their river watch. On the third evening at the western shore, Hannibal called Hanno, a trusted officer, to his tent and laid out plans for a secondary force to secretly cross the Rhone and circle behind the Gauls for a stealthy attack. That very night, Hanno set out with about 10,000 soldiers who traveled upriver about 30 kilometers before crossing the river and turning back to encircle the Gauls for an ambush. Two days later, when Hannibal saw Hanno's smoke signal—a predetermined indicator that Hanno's troops were in place—Hannibal led his men across the Rhone and engaged the Gauls in battle. At the same time, Hanno's force attacked the Gauls from the rear, sending the Gauls into great confusion and ending with a conclusive victory for Hannibal. Following the rout of the Gauls, Hannibal proceeded to bring his war elephants across the Rhone by raft. Several of them panicked during the crossing and fell into the river. Although all 37 elephants eventually made it across, several mahouts—elephant drivers—died during the crossing.

Greece

In the declining days of Hellenistic Greece, the Greek states sought external aid from the Seleucid Empire in removing Roman influence from the Greek mainland (ca. 190 BC). In one extended battle, Roman troops had surrounded the walled city of Ambracia and laid siege to it. Because efforts to break through the walls were continually thwarted by the besieged Greeks, the Romans changed tactics and attempted to tunnel underneath the city wall (Campbell, 2005; Gillies, 1820; Ihne, 1877). Alarmed by the growing mounds of soil outside their walls, the Greeks realized what the Romans were attempting and counter-tunneled to meet the invaders. Initially the Greeks tried to repel the Romans with standard weapons but quickly realized that

this was a frustratingly slow means of rebuffing the attack. Instead, the Greeks devised a smoke machine—a large jar filled with burning feathers and fueled with oxygen by pumping blacksmith bellows—and forced smoke into the tunnel. Whether due to the pungent odor of burning feathers or the inability to advance down the tunnel unaware of where traps or enemies might be, the Roman soldiers withdrew from the tunnel, and the undermining effort was ceased. Despite the lack of Roman progress at this front of the war, Roman troops elsewhere were defeating the Greek's Seleucid allies in several decisive battles. In hearing of the final defeat of the Seleucids, Ambracia surrendered to the Romans.

Rome

During the waning days of the Roman Republic and the corresponding waxing of the Roman Empire, Gaius Julius Caesar found himself at odds with the Roman Senate (ca. 50 BC) (Roberts, 2006). By this time in his career, Caesar had demonstrated himself to be an accomplished politician as well as an adept military general. Fearing Caesar's aspirations as much as his army, the Senate ordered Caesar to disband his army and return to Rome. Caesar was selective in complying with the Senate and, though he did return to Rome, he brought one legion of his army with him across the Rubicon River, thus igniting the Roman Civil War (Cawthorne, 2005a). During the intervening months, Caesar engaged in several battles with the Senate's primary defender, General Gnaeus Pompey, a former friend and political ally. In one campaign, Caesar laid siege to Pompey at Dyrrhachium, one of Pompey's vital military depots (Cawthorne, 2005b; Sheppard & Hook, 2006). After several unsuccessful attempts by Pompey to break the siege, the course of the engagement was decisively altered by defectors from Caesar's army. Two cavalry commanders betrayed Caesar's army and crossed over to the besieged Pompey, bringing news of weaknesses in Caesar's lines—a small portion that had not yet completed its fortifications—of which Pompey took immediate advantage. In the subsequent battle, Caesar's lines broke and his troops were routed. Only one thing prevented the siege from turning completely to Pompey's advantage, namely reinforcements from Mark Antony and, later, Caesar himself who were summoned to the melee by a prearranged smoke signal that had been prepared for just such a contingency (Sheppard & Hook, 2006). This loss by Caesar represented one of only a few rare military defeats in Caesar's career, but it could have been much worse. Caesar himself

observed, “Today my enemies would have finished the war if they had a commander who knew how to win a victory.”

Americas

Because of a lack of written records, setting specific dates when Native Americans began using the smoke signal is difficult, but it is clear that this form of communication already was well established among many tribes when explorers from the Old World made their way to the New World (Woods & Woods, 2000). Smoke signaling may well have been used as early as 500 or 600 AD in the Americas. In general, the smoke signal is thought to have been used more broadly among plains and southwestern Indians than among woodland tribes, because highly forested areas would tend to make viewing of such signals difficult. Because one of the primary uses of the smoke signal was during wartime, smoke signal coding tended to be specific to each tribe so that enemies in the area would not be able to decipher the encoded message (Eastman, 1974; Tomkins, 1969). Thus, there was no standard signal code. Messages that were commonly sent via smoke signals might communicate the number of horses retrieved from a successful raiding party, the number of enemy scalps won in battle, the success or failure of a game hunt, or a call for help. One of the earliest dated uses of the Indian smoke signal was in 1542 AD (Debo, 1970). Francisco Vásquez de Coronado, the Spanish conquistador, had been living as the governor in Mexico where he heard from explorers of a wealthy “city of gold” in the north called Cíbola. Mounting an expedition, he led a group of approximately 1,500 people to capture the riches of the north. His journey led him through modern day Arizona and New Mexico, until he met the native Zunis of the pueblo Cíbola. As the Cíbolan warriors retreated before Coronado in battle, they used simple smoke signals to communicate the progress of the retreat back to their tribe. Eventually, Coronado captured Cíbola but was deeply disappointed by the lack of gold.

Obscurants in Modernity

Highlights

World War I (WWI) signified the dawn of the modern age of military smokes. Although obscurants were used only sparingly during WWI, their success during key naval engagements—when smoke screens were generated by changing the fuel-to-air ratio for the ship’s engines—garnered the attention

of military commanders, ultimately leading to the advent of state-funded research and development (Brodie & Brodie, 1973). One of the early successful deployments of obscurants was in the Battle of Jutland, fought between Great Britain and Germany in 1918 in the waters of the North Sea just off the coast of Denmark (Allen, 1919; Griffiths, 2003). At a turning point in the battle, it appeared as though Germany had fallen into a trap from which they could not escape. However, the German fleet was able to escape and cover their retreat with a highly effective smoke screen, which prevented the British fleet from engagement and discouraged pursuit. Both Germany and Great Britain experienced significant losses during the battle, but there was no conclusive victory by either country.

Toward the end of WWI, the US Army established their Chemical Warfare Service (CWS) in response to the chemical gas weapons employed by Germany during the War. Among the tasks assigned to the CWS were the investigation, research, and development of military applications of smoke (Smart, 1997). One such study sought to determine the effectiveness of rifle fire during three potential battlefield scenarios (Butler, 1998). The first scenario was under a clear field of view to the target (i.e., no smoke), which resulted in a typical efficiency of 58% shot-fired to target-hit ratio. With smoke on the target, this ratio substantially dropped to only 11%. And with smoke on the firing line, the ratio again dropped to only 3%. Although a relatively simple experiment, this indicated the potential usefulness of smokes to prevent visual target acquisition in a wartime situation.

Doctrine

From a technical perspective, obscurants are chemical weapons and are even referred to as chemical smokes in obscurant literature. However, from a psychological perspective, obscurants are in a weapons class by themselves, playing a unique role in visual and electronic countermeasures (Smart, 1997). Therefore, obscurants have not been included in any international treaties banning chemical weapons; as a result, obscurants have been employed in virtually every major international conflict that has occurred since WWI, including World War II and the Korean, Vietnam, and Persian Gulf wars (Butler, 1998; Smart, 1997).

In the modern military, obscurants are referred to as a “force multiplier,” meaning that using obscurants enhances or multiplies the combat effectiveness of soldiers, both individually and collectively. Essentially, force

multipliers allow two or three soldiers of today to perform the work of 20 to 30 soldiers of yesterday and, usually, to perform more safely and efficiently.

Obscurants may effectively increase the combat ability of troops in specific battlefield scenarios through any of five different generalized applications: obscuring smoke, screening smoke, protecting smoke, marking smoke, and deceptive smoke (US Army, 1986, 1990). Specific battlefield scenarios and tactics are laid out regarding wartime conditions under which different obscurants can be employed. Obscuring smoke is delivered among or directly in front of enemy forces and is intended to disorient enemy soldiers and confuse normal troop operations. Screening smoke is employed in the space between friendly and enemy forces and is meant to discourage combat fire—for example, gun, mortar, artillery, tank, aircraft, naval—by hindering target acquisition between the forces. Protecting smoke also is deployed in the area between friendly and enemy lines—typically close to friendly forces, depending on meteorological conditions—and is used to attenuate directed electromagnetic energy in the microwave and infrared regions, which defeats targeting and guidance systems. Marking smoke is delivered directly on top of or immediately adjacent to a site of interest and serves to visually highlight a friendly position, assembly point, or an enemy target in a way that is observable from a remote distance or from the air. Finally, deceptive smoke is used in an area removed from friendly forces but still within the greater battlespace arena and is intended to obfuscate enemy command and control by raising questions of friendly force strength, position, and action.

Obscurants in Postmodernity

In the postmodern world, obscurants that were originally developed for military functions have developed a much more diverse market in the entertainment, recreational, engineering, and even religious communities. In entertainment, obscurants have been used in varied formats ranging from colored smokes in pyrotechnic displays, to fogs in light shows and at haunted houses, and to special effects in movies and television shows. And, just as Hollywood stylized the smoke signal in western-themed productions, they also glorified the smoke screen in their adventure thrillers, particularly the spy genre. Anyone who is a fan of the James Bond franchise is familiar with the ultimate spy vehicle, 007's candy-apple red Aston Martin DB5, which allowed him to lose any tail through the smoke screen initiated with the touch of a button. In recreation, colored smokes are used in acrobatic flying and skydiving, and also as distress markers for boating and extreme hiking. In

industry, obscurants are used in wind tunnels to evaluate aerodynamic flow around model cars and airplanes. And, finally, in religion, smoke signals are used to indicate the results of papal elections—black smoke (*fumata nera*) indicating that a vote has not been decisive and white smoke (*fumata bianca*) indicating that a new pope has been selected.

References

- Abbott, J. (1902). Chapter 4: The passage of the Rhone. In *Hannibal* (pp. 69–89). New York, NY: Harper & Brothers.
- Allen, G. H. (1919). Chapter 18: The battle of Jutland (May 31–June 1, 1916). In *The great war. The wavering balance of forces* (Vol. 4, pp. 399–430). Philadelphia, PA: George Barrie's Sons.
- Arnold, T. (1868). *The history of Rome*. New York, NY: D. Appleton and Company.
- Bodeau, D. T. (1993). Chapter 9: Military energetic materials: Explosives and propellants. In D. P. Deeter & J. C. Gaydos (Eds.), *Occupational health: The soldier and the industrial base* (pp. 305–357). Washington, DC: Borden Institute.
- Brodie, B., & Brodie, F. M. (1973). *From crossbow to H-bomb*. Bloomington, IN: Indiana University Press.
- Butler, B. A. (1998). *Smoke and obscurant operations in a joint environment*. (Unpublished master's thesis). Air Command and Staff College, Air University, Maxwell Air Force Base, AL.
- Campbell, D. B. (2005). *Ancient siege warfare: Persians, Greeks, Carthaginians, and Romans—546–146 BC*. Oxford, England: Osprey Publishing.
- Canney, M. A. (1921). *An encyclopedia of religions*. London, England: George Routledge & Sons.
- Cawthorne, N. (2005a). Chapter 6: Crossing the Rubicon: 51 to 49 BC. In *Julius Caesar* (pp. 49–56). London, England: Haus Publishing.
- Cawthorne, N. (2005b). Chapter 7: The destruction of Pompey: 48 BC. In *Julius Caesar* (pp. 57–71). London, England: Haus Publishing.
- Chakravarthi, P. (1992). The history of communications from cave drawings to mail messages. *IEEE Aerospace and Electronic Systems Magazine*, 7, 30–35.

- Chaturvedi, B. K. (2001). *Kautilya's Arthashastra*. New Delhi, India: Diamond Pocket Books.
- Church, A. J., & Gilman, A. (1886). *Carthage*. London, England: G. P. Putnam's Sons.
- Debo, A. (1970). *A history of the Indians of the United States*. Norman: University of Oklahoma Press.
- Eastman, C. A. (1974). Chapter 12: Indian signals in camp and field. In *Indian scout craft and lore* (pp. 85–90). New York, NY: Dover Publications.
- Echols, E. (1952). Military dust. *The Classical Journal*, 47, 285–288, 297.
- Gabriel, R. A. (2003). *The military history of ancient Israel*. Westport, CT: Praeger Publishers.
- Gillies, J. (1820). *The history of ancient Greece: Its colonies, and conquests*. London, England: T. Cadell and W. Davies.
- Griffith, S. B. (1971). *Sun Tzu: The art of war*. London, England: Oxford University Press.
- Griffiths, W. R. (2003). *The great war*. Garden City Park, NY: Square One Publishers, 88–89.
- Gum, R. M., & Weeks, M. H. (1996). Smoke and obscurants. *Military Review*, 76, 84–90.
- Guo, C., Song, J., & Feng, L. (2003). *World heritage sites in China*. Beijing, China: China Intercontinental Press.
- Ihne, W. (1877). *The history of Rome*. (Vol. III). London, England: Longmans, Green and Company.
- Leighton, A. C. (1969). Secret communication among the Greeks and Romans. *Technology and Culture*, 10, 139–154.
- Lovell, J. (2006). *The Great Wall: China against the world*. New York, NY: Grove Press.
- Mayor, A. (2003). *Greek fire, poison arrows, and scorpion bombs: Biological and chemical warfare in the ancient world*. Woodstock, England: Overlook Duckworth.
- Orr, J. (1915). *The international standard Bible encyclopaedia*. Chicago, IL: Howard-Severance Company.
- Roberts, P. (2006). Chapter 10: Julius Caesar. In *Ancient history. Book 2* (pp. 139–155). Glebe, Australia: Pascal Press.

- Sheppard, S., & Hook, A. (2006). *Pharsalus 48 BC: Caesar and Pompey—Clash of the titans*. Oxford, England: Osprey Publishing.
- Smart, J. K. (1997). History of chemical and biological warfare: An American perspective. In F. R. Sidell, E. T. Takafuji, & D. R. Franz (Eds.), *Medical aspects of chemical and biological warfare* (pp. 9–86). Washington, DC: Borden Institute.
- Southern, P. (1990). Signals versus illumination on Roman frontiers. *Britannia*, 21, 233–242.
- Tomkins, W. (1969). *Indian sign language*. New York, NY: Dover Publications.
- Turnbull, S. (2007). *The Great Wall of China: 221 BC—AD 1644*. Oxford, England: Osprey Publishing.
- US Army. (1986). *Field behavior of NBC agents (including smoke and incendiaries)*. Field Manual FM 3 6.
- US Army. (1990). *Smoke operations*. Field Manual FM 3 50.
- US National Research Council. (1997). *Toxicity of military smokes and obscurants* (Vol. 1). Washington, DC: National Academy Press.
- Woods, M., & Woods, M. B. (2000). *Ancient communication*. Minneapolis, MN: Runestone Press.

PART V

Reviews

A Brief History of Respiratory Deposition Modeling

Chiu-sen Wang

Introduction

Smoke exposure has been a health hazard ever since humans began to use fire for cooking. Although not as ancient as the problem of smoke exposure, aerosol therapy was already in use over 4 millennia ago, according to the description in Ayurvedic medicine. Despite these early experiences in aerosol inhalation, it was not until 1700 that a comprehensive discourse of dust diseases was given in a book on occupational medicine by Ramazzini (1700). It took another 170 years before the first scientific observation of pulmonary deposition was described in a lecture delivered by John Tyndall (1870) at the Royal Institution of Great Britain. Given the complexity of respiratory deposition, remarkable progress has been made in both experimental determination and mathematical modeling of respiratory deposition since the late 1930s. This brief historical account focuses on the progress in mathematical modeling.

The ability to measure and predict respiratory deposition rates is of central importance in environmental health and respiratory drug delivery. The link between inhalation exposure and health response is the particle dose specific to target tissues. It takes a number of steps for particles in ambient air to reach a target tissue in an individual. These steps include entry through the nose or mouth, transport in the respiratory tract, deposition on airway surfaces, translocation of deposited particles to other sites, and dissolution of soluble particles at sites of deposition or during translocation. The rate at which particles go through each of these steps depends on the anatomical and physiological factors of an individual, the airflow characteristics, and particle properties. The factors influencing the fate of deposited particles include deposition site, particle properties, and the health status of an individual. Because of marked intersubject variations in morphometry of the respiratory

tract, deposition patterns differ considerably from individual to individual even under identical breathing conditions.

The respiratory tract consists of three distinct regions: the head airways, the tracheobronchial tree, and the alveolar region. These regions have dissimilar anatomical characteristics and clear deposited particles by different pathways. Consequently, the rate at which particles deposit and the length of time deposited particles remain in a region differ from region to region. Furthermore, particles deposit on airway surfaces in nonuniform patterns: the deposition density (number of particles deposited over a unit surface area of the airways) is markedly higher at the carinal ridge where the two daughter tubes intersect in an airway bifurcation. The site of deposition and the deposition density both have great influences on the response to a specific toxicant or therapeutic agent. As a result, assessment of the health effects of inhaled aerosols requires not only data on total deposition (fraction of inhaled particles deposited in the entire respiratory tract) and regional deposition (fraction of inhaled particles deposited in a respiratory region), but also information on local deposition (rate of deposition over a small surface area of the respiratory airways).

Particle deposition in the human lung has been assessed using both experimental methods and theoretical calculations. Since the 1940s, a substantial amount of consistent data has been obtained from experiments with human subjects of markedly different lung morphometry. Although measurements can be made with human subjects to provide data on total and regional deposition, experimental techniques available today are not sufficiently sensitive for quantitative assessment of local deposition in the human lung. However, mathematical modeling is capable of predicting total, regional, and local deposition for any breathing frequency, tidal volume, particle size, and particle density. A deposition model is a computational scheme that contains four elements required for an adequate description of respiratory deposition: morphometry of the respiratory tract, respiratory physiology, aerodynamic characteristics, and particle behavior. It is generally developed using a specified lung structure, but its computational scheme can be applied to any lung morphometry. Validated theoretical models are, therefore, useful for estimating deposition rates for children and patients with damaged lungs, for whom experimental data are difficult to obtain.

Because of anatomical complexity of the respiratory tract, mathematical modeling of particle deposition by necessity makes use of simplifying

assumptions on lung morphometry. Two basic types of morphometric models have been used: (1) compartments-in-series models that treat the respiratory tract as a number of compartments connected in series and (2) continuous models that consider the respiratory tract as a continuous conduit of variable cross section (trumpet models) or as a continuous tubular filter bed (Wang, 2005). Both basic types of morphometric models have been used in respiratory deposition modeling. Only compartments-in-series models and trumpet models are discussed in this brief historical account.

Compartments-in-Series Models

Findeisen's Deposition Model

Findeisen (1935) was the first to develop a mathematical model for deposition of inhaled particles. He worked on this problem during his appointment as a physicist at the Institute for Aviation Medicine and Climate Research in Hamburg (Eppendorfer Hospital). The morphometric model he used consists of nine compartments connected in series, starting with the trachea and ending with alveolar sacs (Figure 1). Each compartment contains a number of parallel airway segments, which have identical diameter and length. A respiratory cycle comprises an inspiratory phase, an expiratory phase, and a short pause following each phase. The inspiratory and expiratory flows are constant. The flow has a uniform velocity profile in each airway segment; therefore, no convective mixing occurs in the airways. Deposition mechanisms considered in the model include inertial impaction, gravitational settling, Brownian diffusion, and interception (deposition due to the finite size of a particle). The efficiency of deposition by each mechanism in an airway segment is calculated using an approximate equation derived with simplifying assumptions. The deposition efficiencies calculated for various mechanisms are then summed to give the combined deposition efficiency. In calculations for the fractional deposition in each compartment, the progressive loss

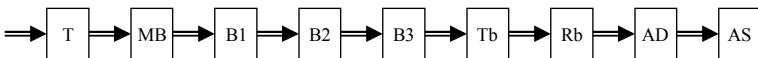

Figure 1. A compartments-in-series model of the respiratory tract used by Findeisen for deposition calculations. T: trachea, MB: main bronchi, B1: bronchi of order 1, B2: bronchi of order 2, B3: bronchi of order 3, Tb: terminal bronchioles, Rb: respiratory bronchioles, AD: alveolar ducts, AS: alveolar sacs.

of particles in the inhaled aerosol as it passes from compartment to compartment is taken into consideration.

A particle can deposit in an airway via several mechanisms (Figure 2). Findeisen's model takes into account the three most important mechanisms: inertial impaction, gravitational settling, and Brownian diffusion. Deposition by interception, which is also considered in the model, is generally negligible except for elongated particles. Electrostatic forces are important only for highly charged particles, and turbulent deposition occurs mainly in upper airways. Thermophoretic and diffusiophoretic forces (not shown in Figure 2) can retard deposition of nanoparticles in upper airways when the temperature and relative humidity of inspired air are lower than those in the respiratory tract (Wang & Friedlander, 2006).

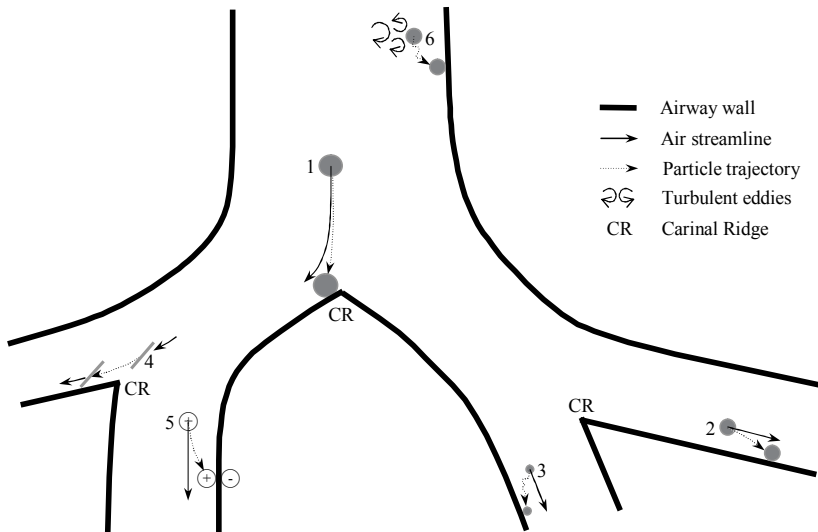

Figure 2. Mechanisms of particle deposition in the respiratory tract: (1) inertial impaction, (2) gravitational settling, (3) Brownian motion, (4) interception, (5) electrostatic forces, (6) turbulent deposition.

Findeisen's model represents a computational scheme containing all four important elements required for an adequate description of respiratory deposition: morphometry of the respiratory tract, respiratory physiology, aerodynamic characteristics, and particle behavior. However, two of the assumptions Findeisen made are inconsistent with the transport processes of air and airborne particles in the lungs: (1) the entire volume of inhaled

aerosol reaches every compartment of the lung model and (2) there is no deposition during exhalation. The first assumption tends to overestimate total deposition, while the second leads to a lower estimate. The errors resulting from these two assumptions cancel each other to some extent. Consequently, the model predictions are in fair agreement with the total deposition curves (the curve displaying total deposition as a function of particle size) obtained by experiments for normal breathing.

Modifications of Findeisen's Deposition Model

Following the pioneering work of Findeisen, several modifications were made to the model (Beeckmans, 1965; Landahl, 1950) that incorporate various degrees of refinements in morphology of the respiratory tract, aerodynamic characteristics in the lungs, and equations used in calculations for deposition efficiency.

In Landahl's analysis (1950), the mouth, the larynx, and one extra order of alveolar ducts were added to the morphometric model proposed by Findeisen, and the equations for deposition efficiencies were simplified. An equation was derived for the combined deposition efficiency to account for the simultaneous action of various mechanisms. In addition, the improved model takes into consideration the deposition during exhalation and the progressively smaller volume of inhaled aerosol that passes from compartment to compartment. With these modifications, the predictions of total deposition for various breathing frequencies and tidal volumes are in general agreement with the experimental data of Landahl and Herrmann (1948).

Flow patterns in the repeatedly bifurcating respiratory tract are complex. During inhalation, the flow velocity distribution in a daughter tube of an airway bifurcation takes the shape of a skewed parabola with the peak shifted toward the inner edge of the tube. As a result of these nonuniform flow profiles and the intrinsic motion of particles, inhaled aerosol has a tendency to mix with residual air in the lungs (Wang, 2005). Landahl (1950) noted the mixing between inhaled aerosol and residual air but did not take it into account in his calculations. Employing an aerosol wash-in and wash-out technique, Altshuler and colleagues (1959) demonstrated that a portion of inhaled aerosol is exchanged with residual air in each respiratory cycle as a result of convective mixing. The data for three healthy subjects indicated that the degree of convective mixing can differ considerably from individual

to individual. Subsequently, Altshuler (1959) proposed an expression for convective mixing in the lungs and used it in a filter-bed model for calculating regional deposition.

In an extension of the analyses of Findeisen and Landahl, Beeckmans (1965) modified Altshuler's expression for convective mixing and made some changes in the equations for deposition efficiency. He used the solution derived by Gormley and Kennedy (1949), instead of the empirical equation given by Landahl, to calculate the rate of deposition by convective Brownian diffusion in each airway segment. Using a computer, which became more available in the early 1960s, Beeckmans was able to calculate many points for each deposition curve to study the effects of convective mixing and recycling of particles that remain airborne at the end of exhalation. The calculations for total deposition under various breathing frequencies and tidal volumes are in fair agreement with published experimental data (Landahl et al., 1951; 1952). The calculated total deposition curve shows a minimum in the particle diameter range between 0.3 and 0.4 μm , confirming the results of experimental studies. The minimum occurs because the rates of inertial deposition and gravitational settling increase with increasing particle size, whereas the rate of diffusional deposition increases with decreasing particle size. As a result, none of these mechanisms makes a notable contribution to deposition for particles between 0.3 and 0.4 μm . The deposition model based on the analyses of Findeisen, Landahl, and Beeckmans is known as the Findeisen-Landahl-Beeckmans model.

The ICRP and NCRP Deposition Models

Since 1960, the International Commission on Radiological Protection (ICRP) has published three models for deposition and retention of inhaled radioactive particles. The first model appeared in ICRP Publication 2 (ICRP, 1960), the second in Publication 30 (ICRP, 1979), and the third in Publication 66 (ICRP, 1994). In the second model, developed and published by the Task Group on Lung Dynamics of the International Commission on Radiological Protection (TGLD, 1966), the deposition calculations are essentially identical to the theoretical analyses of Findeisen and Landahl. Minor modifications made by TGLD include use of an empirical equation for nasopharyngeal deposition and the solution of Gormley and Kennedy for convective Brownian diffusion in tracheobronchial and pulmonary regions.

In the latest ICRP model (ICRP, 1994), the respiratory tract used for calculations consists of five regions: (1) the anterior nasal passages; (2) the posterior nasal passages, pharynx, and larynx; (3) the trachea and bronchi; (4) the bronchioles; and (5) the alveolar region. The morphometric model is adopted from several published lung models and, therefore, can be considered as a composite model. By the early 1990s, a substantial amount of deposition data obtained with human subjects and lung casts had been published. Several equations of deposition efficiency used in the ICRP model are empirical expressions derived by curve-fitting procedures using these experimental data, whereas some other empirical equations are based on the theoretical calculations of Egan and colleagues (1989), which have been validated with experimental data. In the theoretical analysis of Egan and colleagues, the respiratory tract is assumed to be a trumpet-shaped continuous conduit, and either empirical or analytical expressions are used for the deposition term in the time-dependent transport equation for particles. The continuous deposition models are discussed in a later section.

Computer programs and simplified equations have been developed to make calculations with the ICRP model easier. A new version of the computer program for the model is now available (Jarvis et al., 2010). By curve fitting the model calculations, Hinds (1999) obtained simplified equations for total and regional deposition of standard density particles during nose breathing. Following is the equation for total deposition fitted to averaged values for men and women at three levels of physical activity (resting, light exercise, and heavy exercise):

$$DF = 0.0587 + \frac{0.911}{1 + \exp(4.77 + 1.485 \ln d_p)} + \frac{0.943}{1 + \exp(0.508 - 2.58 \ln d_p)} \quad (1)$$

Here d_p is particle diameter in micrometers. The equation does not take into account the loss of particles during entry into the nose and, therefore, can be directly compared with the experimental data for nasal breathing. Figure 3 shows that the calculations from Equation 1 agree well with the data reported by Heyder and colleagues (1986).

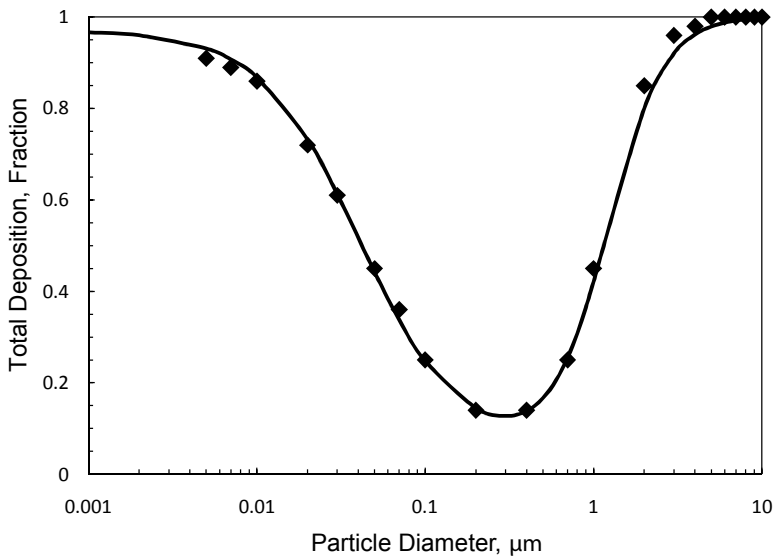

Figure 3. Comparison of measured and calculated total deposition of standard density spheres during nasal breathing. Experimental data are from Heyder et al. (1986) for the breathing pattern: $750 \text{ cm}^3\text{s}^{-1}$ mean flow rate, 4 s breathing cycle period, and $1,500 \text{ cm}^3$ tidal volume.

Three years after publication of the latest ICRP model, the National Council on Radiation Protection and Measurements (NCRP) presented its own model for deposition and retention of inhaled radioactive substances (NCRP, 1997). To avoid confusion in the radiation protection community, the NCRP recommended adopting the ICRP model for exposure calculations and indicated that publication of its own model was only intended to be NCRP's contribution to the field of radiation protection.

The NCRP deposition model is mainly based on the work of Yeh and Schum (1980). The respiratory tract used for calculations consists of three regions: (1) the naso-oro-pharyngo-laryngeal region, (2) the tracheobronchial region, and (3) the pulmonary region. The tracheobronchial region contains 16 generations of airways extending from the trachea to terminal bronchioles, and the pulmonary region consists of eight generations of airways and the alveoli. These airway generations are connected in series. Each airway generation comprises a number of parallel airway segments that have identical diameter and length. Empirical equations are used to calculate deposition in head airways, whereas either analytical or empirical expressions are used for

deposition in each generation of airways in the tracheobronchial and alveolar regions. Convective mixing is not considered in the model.

To compare the ICRP and NCRP models, Yeh and colleagues (1996) used both models to calculate regional deposition for the same particle size distribution, lung volume, and breathing pattern. The results indicate that the deposition fractions in head airways calculated by the two models are very similar for the range of particle diameter between 0.001 and 10 μm , but for particles smaller than 0.1 μm the NCRP model gives somewhat higher deposition in the tracheobronchial tree and consequently lower deposition in the alveolar region. The difference arises probably because convective mixing is not considered in the NCRP model, and different expressions are used in the two models to calculate enhanced deposition that occurs near the carinal ridge of an airway bifurcation. Enhanced deposition is discussed in a later section.

Multiple-Path Deposition Models

The deposition models described in the preceding subsections are known as single typical path models, because the respiratory tract is represented by a single series of compartments in which the same values of diameter and length are assumed for all airways in the same generation. In fact, the human respiratory tract does not bifurcate regularly, and airway bifurcations are not symmetric. To account for variations in deposition rate among the five lobes in the lungs, Yeh and Schum (1980) used one typical pathway for each lobe to calculate the deposition fraction. The morphometric models for the five lobes, each of which has a symmetric structure, were developed from detailed measurements of a silicone rubber cast of the human tracheobronchial tree (Raabe et al., 1976) and an idealized model of the alveolar region. Calculations for each lobe are based on the computational scheme of Landahl (1950) with some modifications. The analytical solution given by Ingham (1975) is used to compute the rate of deposition by Brownian diffusion from laminar flow in each airway segment, whereas deposition efficiencies by other mechanisms are evaluated using empirical expressions. The fraction of air flow distributed to a lobe, a parameter required for lobar deposition calculations, is assumed to be proportional to the number of terminal bronchioles associated with the lobe. Results for a normal breath show that, for standard-density particles between 0.01 and 10 μm , the deposition fractions in the right lower lobe and the left lower lobe are notably higher than in other lobes.

Extending Yeh and Schum's analysis, Asgharian and colleagues (2001) used 10 asymmetric, structurally different human respiratory tract models to calculate deposition fractions in the tracheobronchial tree, the alveolar region, each of the five lobes, and each generation of airways. The tracheobronchial trees of the 10 respiratory tract models are also based on the morphometric measurements of Raabe and colleagues (1976). Each of the 10 structurally different models is constructed with the values of airway parameters chosen randomly in accordance with their statistical distributions, instead of the mean or median values. Calculations are carried out with the computational scheme developed earlier for a multiple-path model of particle deposition in the rat lung (Anjilvel & Asgharian, 1995). The equations given by Cai and Yu (1988), Ingham (1975), and Wang (1975) are used to calculate deposition due to inertial impaction, convective diffusion, and gravitational settling, respectively. Results for regional deposition are similar to those calculated from a single typical path model and the five-lobe lung model of Yeh and Schum, but lobar deposition is found to be strongly dependent on the lung morphometry used in calculations. A software program based on a refined version of the multiple-path deposition model has been developed (Price et al., 2002).

As a variation from typical path models, Koblinger and Hofmann (1988) introduced a stochastic approach to account for the effect of asymmetry in lung structure. In this multiple-path model, each inspired particle moves through a single pathway selected randomly by a Monte Carlo code from a lung model with statistically distributed airway dimensions. Each pathway comprises a number of airway bifurcation units connected in series. The model retains the concept of airway generations but takes into consideration the variations in diameter, length, and branching angle of airways in each generation. Deposition probabilities are calculated using the equations previously employed by Yeh and Schum (1980) in the five-lobe lung model. For each airway bifurcation unit, the model is used to simulate the transport of about 10,000 particles and the results are then used to obtain a statistical mean value of deposition fraction. Results for lobar deposition are in reasonable agreement with those of Yeh and Schum (1980). Because the coordinates of each airway are specified in the simulation, the model is capable of providing detailed three-dimensional deposition patterns in the entire respiratory tract.

Using the same stochastic approach but different assumptions on selection of parameter values for the airways, Goo and Kim (2003) developed another computational scheme for tracking the movement of inspired particles. The equations employed by Yeh and Schum (1980) in the five-lobe lung model are used to calculate deposition probabilities for each airway segment. For submicron size particles, results of the stochastic model and the single typical path model are in good agreement, but for deposition of micron size particles in large conducting airways, the stochastic model gives higher deposition. The discrepancy indicates that the stochastic model is more sensitive to the parameters governing inertial impaction.

Continuous Models

As a notable departure from the compartments-in-series model, Taulbee and Yu (1975) proposed a continuous model for particle deposition. A trumpet-shaped conduit with a continuously increasing cross section along its axis (Figure 4) is used to represent the respiratory tract; therefore, the model is known as a trumpet model. As a result of deposition, the concentration of airborne particles in the conduit varies with position and time. An apparent diffusion coefficient is used to account for the effect of aerosol mixing along the axial direction. The axial flow velocity and particle concentration are assumed to be uniform at each cross section of the conduit. Under these assumptions, a mass balance for airborne particles over a short section of the conduit gives the following time-dependent transport equation:

Figure 4. A trumpet model of the respiratory tract.

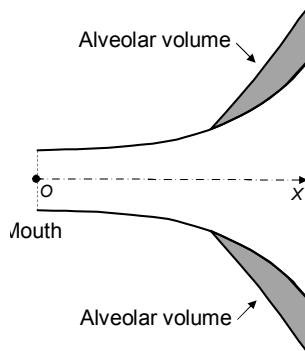

$$A_T \frac{\partial n}{\partial t} = -A_A U \frac{\partial n}{\partial x} + \frac{\partial}{\partial x} \left(A_A D_e \frac{\partial n}{\partial x} \right) - L_d \tag{2}$$

Here $n(x, t)$ is the mean particle concentration at the axial coordinate x and time t , $A_A(x)$ the cross-sectional area of the conduit obtained by summing over all airways at x , $A_T(x, t)$ the time-dependent total cross-sectional area of the conduit (in the alveolar region the additional cross-sectional area contributed by the alveolar volume is included; the area is time dependent because of the change in alveolar volume during a breath), $U(x)$ the average axial flow velocity, $D_e(x)$ the apparent diffusion coefficient in the axial direction, and $L_d(x, t)$ a function representing the particle deposition rate per unit length of the conduit. The functions for deposition due to diffusion and gravitational settling in nonalveolated airways are derived from the expressions used by Beeckmans (1965), whereas an empirical expression is used for inertial deposition. For alveolated airways, approximate expressions are derived for deposition due to gravitational settling and Brownian diffusion.

According to Taulbee and Yu (1975), the apparent axial diffusion of aerosol particles arises from the distribution of flow velocities in various airways of the same generation, which in turn is caused by the distributions of airway length and diameter in each generation of the respiratory tract. If the flow velocities are assumed to be normally distributed with a standard deviation of 0.6, the apparent diffusion coefficient is shown to be $0.3Ul_t$, where l_t is the length of an airway segment.

Taulbee and Yu solved Equation 2 with the values of airway diameter and length given in Weibel's lung model A (Weibel, 1963). For particles in the diameter range between 0.05 and 5 μm , calculated total deposition fractions for normal breathing are in fair agreement with the experimental data of Heyder and colleagues (1973). Equation 2 can be used to calculate the concentration of airborne particles at the mouth during a sequence of breaths. The calculated fractional recovery of half-micron particles in each breath during aerosol wash-in and wash-out is in good agreement with the experimental results of Davies and colleagues (1972).

Egan and Nixon (1985) also used Equation 2 to develop a continuous model. Their model differs from that of Taulbee and Yu in the expression for the apparent axial diffusion coefficient and particle deposition functions. In Egan and Nixon's model, two empirical expressions proposed by Scherer and colleagues (1975) for gas mixing in bronchial airways are used:

$De(x) = D + 1.08Ud_t$ for inspiration and $De(x) = D + 0.37Ud_t$ for expiration, where D is the particle diffusion coefficient and d_t the diameter of an airway

segment. These two expressions are in fact quite similar to the one used by Taulbee and Yu, for the particle diffusion coefficient is negligibly small and d_t is generally about one-quarter to one-half of l_t . The analytical solutions derived by Pich (1972) and Ingham (1975) are used in Egan and Nixon's model for deposition due to gravitational settling and convective diffusion in nonalveolated airways, whereas empirical expressions are used for inertial deposition. For alveolated airways, approximate expressions are derived for deposition due to gravitational settling and Brownian diffusion. For particles in the diameter range between 0.2 and 3 μm , calculated total depositions under various breathing conditions are in good agreement with published experimental results (Heyder et al., 1975). The agreement is fair between model calculations of regional deposition and the experimental data of Stahlhofen and colleagues (1980). As noted earlier, some empirical equations of deposition efficiency used in the ICRP model are based on the calculations with this continuous model.

Local Deposition

Deposition is enhanced near the carinal ridge of an airway bifurcation (see Figure 2), because particles are brought closer to the wall surface that faces the approaching airflow during inhalation. Enhancement in deposition occurs for particles of any size but is considerably greater for larger particles approaching the carinal ridge at higher velocities. Information on local deposition is useful for estimating tissue doses of highly toxic particles.

Detailed studies on local deposition began in the early 1970s. Using a three-dimensional airway model with dimensions approximately equivalent to the first lung bifurcation, Bell (1978) measured deposition velocity (the number of particles deposited on a unit surface area per unit time divided by the main stream concentration, also known as local transfer coefficient) over the entire surface area of an airway segment downstream of the carinal ridge. To describe the degree of nonuniformity in deposition, Bell introduced the term hot spot intensity, defined as the ratio of local deposition velocity to the average deposition velocity over the entire wall surface of an airway segment. If the local deposition velocity is obtained by averaging over 0.6% of the total surface area, the hot spot intensity is 25.4 for 5.7 μm latex particles and 200 cm/s air velocity in the airway preceding the carina. For 1.1 μm latex particles and 100 cm/s air velocity, the hot spot intensity is 3.35. The area chosen to calculate the hot spot deposition velocity, 0.6% of the total surface area of an

airway segment in the bifurcation model, corresponds to roughly 150,000 epithelial cells.

Since the early 1990s, advances in computational software have made it possible to solve the three-dimensional particle transport equations numerically to provide information on local deposition in an airway bifurcation (Gradon & Orlicki, 1990). To express the enhancement of deposition at hot spots, Balásházy and colleagues (1999) introduced a local deposition enhancement factor, defined as the ratio of the local deposition density in a given surface element to the average deposition density in the entire surface area of an airway bifurcation. For deposition in the upper bronchial airways during inhalation, the enhancement factor for any particle size in the range between 0.01 and 10 μm has a maximum value of about 100 for a surface element of $100 \times 100 \mu\text{m}$, which corresponds to about 10×10 biological cells, an area needed for development of tumors.

Conclusion

Respiratory deposition modeling is difficult because lung structure and aerodynamic characteristics in lung airways are complicated. Nevertheless, substantial progress has been made during the past 7 decades. Refinements in deposition models mainly came from improved morphometric data of the human lung, better understanding of air flow and particle transport in the bronchial tree, and advances in computational fluid dynamics. With these advances and improvements, deposition models available today are capable of predicting local deposition density in an airway segment of the bronchial tree under any breathing conditions for a variety of particle types, including compact particles, elongated particles, nanoparticle aggregates, charged particles, and hygroscopic particles. Information obtained from improved deposition models has found applications in respiratory drug delivery, environmental health, occupational health, and aerosol diagnosis such as assessment of airway obstruction and mucociliary transport.

Further progress in deposition modeling can be made when the distribution of air flow among various lobes in response to changes in airway resistance and parenchymal compliance of the lungs are better understood. Another area for improvement is incorporation of particle transport by thermophoretic and diffusiophoretic forces into deposition models. If the temperature and relative humidity of ambient air are lower

than the conditions in the lungs, inspired air will be gradually heated and humidified as it passes through head airways and the first few generations of the tracheobronchial tree. Consequently, gradients in temperature and water vapor concentration are established in a thin boundary layer near the walls of each airway segment. For nanoparticles, the thermophoretic and diffusiophoretic velocities resulting from these temperature and vapor concentration gradients are comparable in magnitude to Brownian deposition velocities. The combined phoretic motion is directed away from airway walls and, as a result, can lead to considerable suppression of deposition in head airways and the trachea. Reduction of deposition in upper airways will bring additional inhaled particles to lower airways, thereby increasing the deposition fractions in bronchiolar and alveolar regions (Wang & Friedlander, 2006).

Acknowledgments

I would like to thank Professor Lutz Mädler for helping me search for information about W. Findeisen and calling to my attention the lecture entitled “On Dust and Disease,” delivered by John Tyndall at the weekly evening meeting of the Royal Institution of Great Britain on January 21, 1870.

References

- Altshuler, B. (1959). Calculation of regional deposition of aerosol in the respiratory tract. *Bulletin of Mathematical Biophysics*, 21, 257–270.
- Altshuler, B., Palmes, E. D., Yarmus, L., & Nelson, N. (1959). Intrapulmonary mixing of gases studied with aerosols. *Journal of Applied Physiology*, 14, 321–327.
- Anjilvel, S., & Asgharian, B. (1995). A multiple-path model of particle deposition in the rat lung. *Fundamental & Applied Toxicology*, 28, 41–50.
- Asgharian, B., Hofmann, W., & Bergmann, R. (2001). Particle deposition in a multiple-path model of the human lung. *Aerosol Science & Technology*, 34, 332–339.
- Balásházy, I., Hofmann, W., & Heistracher, T. (1999). Computation of local enhancement factors for the quantification of particle deposition patterns in airway bifurcations. *Journal of Aerosol Science*, 30, 185–203.

- Beeckmans, J. M. (1965). The deposition of aerosols in the respiratory tract-I. Mathematical analysis and comparison with experimental data. *Canadian Journal of Physiology & Pharmacology*, *43*, 157–172.
- Bell, K. A. (1978). Local particle deposition in respiratory airway models. In D. T. Shaw (Ed.), *Recent developments in aerosol science* (pp. 97–134). New York, NY: Wiley.
- Cai, F. S., & Yu, C. P. (1988). Inertial and interceptional deposition of spherical particles and fibers in a bifurcating airway. *Journal of Aerosol Science*, *19*, 679–688.
- Davies, C. N., Heyder, J., & Subba Ramu, M. C. (1972). Breathing of half-micron aerosols. I. Experimental. *Journal of Applied Physiology*, *32*, 591–600.
- Egan, M. J., & Nixon, W. (1985). A model of aerosol deposition in the lung for use in inhalation dose assessments. *Radiation Protection Dosimetry*, *11*, 5–17.
- Egan, M. J., Nixon, W., Robinson, N. I., James, A. C., & Phalen, R. F. (1989). Inhaled aerosol transport and deposition calculations for the ICRP task group. *Journal of Aerosol Science*, *20*, 1301–1304.
- Findeisen, W. (1935). Über das Absetzen kleiner, in der Luft suspendierter Teilchen in der menschlichen Lunge bei der Atmung. *Pflügers Archiv für gesamte Physiologie des Menschen und der Tiere*, *236*, 367–379.
- Goo, J. H., & Kim, C. S. (2003). Theoretical analysis of particle deposition in human lungs considering stochastic variations of airway morphology. *Journal of Aerosol Science*, *34*, 585–602.
- Gormley, P., & Kennedy, M. (1949). Diffusion from a stream flowing through a cylindrical tube. *Proceedings of the Royal Irish Academy*, *52A*, 163–169.
- Gradon, L., & Orlicki, D. (1990). Deposition of inhaled aerosol particles in a generation of the tracheobronchial tree. *Journal of Aerosol Science*, *21*, 3–19.
- Heyder, J., Armbruster, L., Gebhart, J., Grein, E., & Stahlhofen, W. (1975). Total deposition of aerosol particles in the human respiratory tract for nose and mouth breathing. *Journal of Aerosol Science*, *6*, 311–328.

- Heyder, J., Gebhart, J., Heigwer, G., Roth, C., & Stahlhofen, W. (1973). Experimental studies of the total deposition of aerosol particles in the human respiratory tract. *Journal of Aerosol Science*, 4, 191–208.
- Heyder, J., Gebhart, J., Rudolf, G., Schiller, C. F., & Stahlhofen, W. (1986). Deposition of particles in the human respiratory tract in the size range 0.005–15 μm . *Journal of Aerosol Science*, 17: 811–825.
- Hinds, W. C. (1999). *Aerosol technology: Properties, behavior, and measurement of airborne particles* (2nd ed.). New York, NY: Wiley.
- International Commission on Radiological Protection (ICRP). (1960). Recommendations of the International Commission on Radiological Protection, Report of Committee II on permissible dose for internal radiation (1959). (ICRP Publication 2). Elmsford, NY: Pergamon Press.
- International Commission on Radiological Protection (ICRP). (1979). Limits for intakes of radionuclides by workers. (ICRP Publication 30. Part 1). Elmsford, NY: Pergamon Press.
- International Commission on Radiological Protection (ICRP). (1994). Human respiratory tract model for radiological protection. A report of a Task Group of the International Commission on Radiological Protection. *Annals of the ICRP*, 24, 1–482.
- Ingham, D. B. (1975). Diffusion of aerosols from a stream flowing through a cylindrical tube. *Journal of Aerosol Science*, 6, 125–132.
- Jarvis, N. S., Birchall, A., James, A. C., Bailey, M. R., & Dorrian, M. D. (2010). LUDEP 2.07: Personal computer program for calculating internal doses using the ICRP publication 66 respiratory tract model. Retrieved from <http://www.hpa.org.uk/Publications/Radiation/Software/softwareLUDEP>.
- Koblinger, L., & Hofmann, W. (1988). Monte Carlo model for aerosol deposition in human lungs. In J. Dodgson, R. I. McCallum, M. R. Bailey, & D. R. Fisher (Eds.), *Inhaled particles VI, Proceedings of the Sixth International Symposium on Inhaled Particles*, Organized by the British Occupational Hygiene Society, Cambridge, England, September 2–6, 1985. *Annals of Occupational Hygiene*, 32, Suppl. 1, 65–70.
- Landahl, H. D. (1950). On the removal of airborne droplets by the human respiratory tract: I. The lung. *Bulletin of Mathematical Biophysics*, 12, 43–56.

- Landahl, H. D., & Herrmann, R. (1948). On the retention of air-borne particles in the human lung. *Journal of Industrial Hygiene & Toxicology*, 30, 181–188.
- Landahl, H. D., Tracewell, T. N., & Lassen, W. H. (1951). On the retention of air-borne particulates in the human lung: II. A.M.A. *Archives of Industrial Hygiene & Occupational Medicine*, 3, 359–366.
- Landahl, H. D., Tracewell, T. N., & Lassen, W. H. (1952). Retention of air-borne particulates in the human lung: III. A.M.A. *Archives of Industrial Hygiene & Occupational Medicine*, 6, 508–511.
- National Council on Radiation Protection (NCRP). (1997). *Deposition, retention and dosimetry of inhaled radioactive substances*. (NCRP Report 125). Bethesda, MD: National Council on Radiation Protection and Measurements.
- Pich, J. (1972). Theory of gravitational deposition of particles from laminar flows in channels. *Journal of Aerosol Science*, 3, 351–361.
- Price, O. T., Asgharian, B., Miller, F. J., Cassee, F. R., & De Winter-Sorkina, R. (2002). Multiple Path Particle Dosimetry model (MPPD v1.0): A model for human and rat airway particle dosimetry (Report No. 650010030). [CD-ROM]. Bilthoven, The Netherlands: National Institute of Public Health and the Environment (RIVM).
- Raabe, O. G., Yeh, H. C., Schum, G. M., & Phalen, R. F. (1976). Tracheobronchial geometry: Human, dog, rat, hamster—A compilation of selected data from the project Respiratory Tract Deposition Models (Report LF-53). Albuquerque, NM: Lovelace Foundation.
- Ramazzini, B. (1700). *De Morbis Artificum Diatriba*. Mutinae: Typis Antonii Capponi. Translated by W. C. Wright as *Diseases of workers* (Chicago, IL: The University of Chicago Press, 1940). (Reprinted in 1964, New York, NY: Hafner).
- Scherer, P. W., Shendalman, L. H., Greene, N. M., & Bouhuys, A. (1975). Measurement of axial diffusivities in a model of the bronchial airways. *Journal of Applied Physiology*, 38, 719–723.
- Stahlhofen, W., Gebhart, J., & Heyder, J. (1980). Experimental determination of the regional deposition of aerosol particles in the human respiratory tract. *American Industrial Hygiene Association Journal*, 41, 385–398.

- Taulbee, D. B., & Yu, C. P. (1975). A theory of aerosol deposition in the human respiratory tract. *Journal of Applied Physiology*, 38, 77–85.
- Task Group on Lung Dynamics (TGLD). (1966). Deposition and retention models for internal dosimetry of the human respiratory tract. A report prepared by the Task Group on Lung Dynamics for Committee II of the International Commission on Radiological Protection. *Health Physics*, 12, 173–207.
- Tyndall, J. (1870). On dust and disease. *Proceedings of the Royal Institution of Great Britain*, 6, 1–14.
- Wang, C. S. (1975). Gravitational deposition of particles from laminar flows in inclined channels. *Journal of Aerosol Science*, 6, 191–204.
- Wang, C. S. (2005). *Inhaled particles*. Amsterdam, The Netherlands: Elsevier.
- Wang, C. S., & Friedlander, S. K. (2006). Effects of thermophoresis and diffusio-phoresis on regional deposition of inhaled nanoparticles. In R. F. Phalen, M. J. Oldham, S. W. Akhavan, M. D. Hoover, & K. Asotra (Eds.), *Proceedings of the Conference on Frontiers in Aerosol Dosimetry Research* (pp. 5–85–5–96). (APHEL Report No. 06-01). Irvine, CA: University of California, Air Pollution Health Effects Laboratory.
- Weibel, E. R. (1963). *Morphometry of the human lung*. New York, NY: Academic Press.
- Yeh, H. C., Cuddihy, R. G., Phalen, R. F., & Chang, I. Y. (1996). Comparisons of calculated respiratory tract deposition of particles based on the proposed NCRP model and the new ICRP66 model. *Aerosol Science & Technology*, 25, 134–140.
- Yeh, H. C., & Schum, G. M. (1980). Models of human lung airways and their application to inhaled particle deposition. *Bulletin of Mathematical Biology*, 42, 461–480.

Atmospheric Nanoparticles

Early Metrology and Observations (1875–1980)

Volker A. Mohnen and George M. Hidy

Introduction

Contemporary investigation of atmospheric aerosols concerns the origins and nature of very small particles—smaller than 0.1 μm diameter (100 nanometers). Present-day study of these tiny particles, known as nanoparticles, derives from improvements in sampling and analytical instrumentation that have taken place in the past decade. The nanoparticle range has been of great historical interest as well, because nanoparticles are part of the total number concentration of particles that have been observed by various means since the mid-19th century. The nanoparticle size range represents a miniscule size regime of “Aitken nuclei,” from unstable clusters of molecules and ions to stable submicrometer particles capable of further growth. In the early 20th century, scientists built instruments to measure electric charge-mobility (movement of electrically charged particles in an electric field) and determined that ions present in the air had much lower mobility than expected for gases. These ions later were described as small and large ions (Flagan, 1998), identified with the nano-regime, and included in the phenomenology of atmospheric aerosols. Exclusive of the atmosphere, nanoparticles have unusual optical, electrical, diffusional, mechanical, catalytic, and biochemical properties that make them of special interest. Nanoparticles are small enough to be in a transition regime between bulk material and molecular clusters representing very high microsurface exposure that have long been of interest in fundamental colloidal chemistry and microtechnology (Hidy & Brock, 1970).

Over the years, the nomenclature describing particles in different size ranges has evolved. For this chapter, the mid-1960s definitions, superimposed with later descriptions, are a useful starting point. Junge (1952, 1955) described these definitions for the aerosol number-size distribution, as shown

in Figure 1. A current definition of nanoparticles is superimposed on the figure. Particle numbers in the nano range are inferred from instruments used to measure the total number concentrations of particles (N), including Aitken or condensation nuclei (CN), large ions, and Langevin ions (Langevin, 1905). Larger particles, such as ultralarge ions and large and giant nuclei, including cloud condensation nuclei (CCN), are generally present in the atmosphere at much smaller concentrations than the nanoparticles.

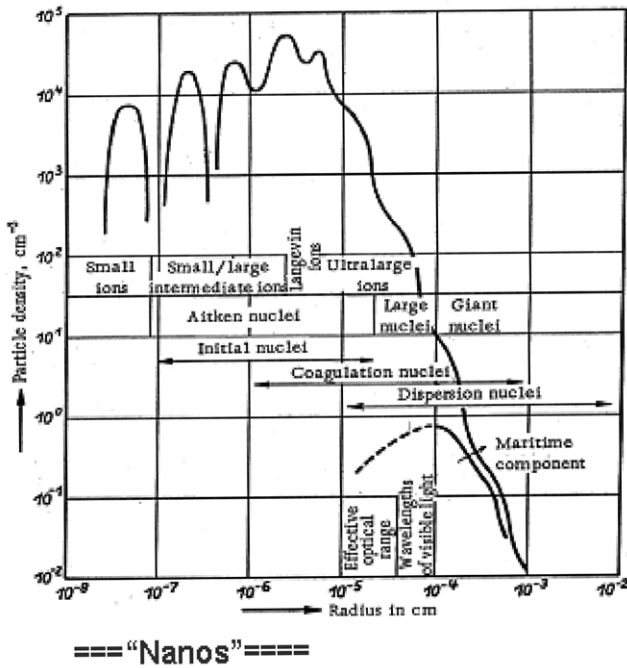

Figure 1. Schematic diagram of nomenclature for regimes of aerosol particle size versus number concentration increment.

Note: Superimposed on this diagram is the nominal range currently considered as nanoparticles (10⁻⁸ to 10⁻⁵ cm). Junge believed the gaps in the ion range were real, though we now know that the nanoparticle size range appears to be continuous to molecular cluster sizes ~1 nm. Knowledge of the number-size distribution indicates that measurement of the total number of particles (N) is a very good approximation for nanoparticle concentration. The nanoparticle concentration is readily deduced from the shape of the distribution curve, which shows a sharp decline in particle density for particles larger than 10⁻⁵ cm.

Source: Adapted from Junge (1952).

Although observations of airborne particles have been documented through casual study of optical effects for centuries (e.g., DaVinci, noted by Went, 1960), perhaps Coulier (1875) first reported observations of total nuclei concentration, using a primitive vapor-expansion device. A decade later, the English physicist John Aitken (1887/1888) became interested in atmospheric particles. He began systematic observations of the number concentration of CN (assumed as N) using a portable adiabatic expansion chamber that produced water vapor supersaturation, in which nucleated droplets could grow to an optically detectable size. Aitken's instrument formed the basis for CN detectors for decades.

A succession of research beyond Aitken's time, especially in the post-World War II years, determined that clouds in the atmosphere were created through the nucleation and growth of particles $>0.5 \mu\text{m}$ diameter at water vapor supersaturations of a few percent greater than saturation, far lower than generally achieved in vapor-expansion counters. The total number concentration of particles (N) present in the air is far larger than those particles (CCN) involved in cloud formation. Nevertheless, interest in very small particles has persisted as part of atmospheric chemistry and atmospheric electricity. Tracing the concentrations of CN has provided insight into spatial exchange mechanisms in atmospheric dynamics; they also have important practical applications in air pollution.

Paralleling the development of instruments that employed a vapor supersaturation measuring CN, the atmospheric ion detectors came into use. Initially scientists were interested in gaseous ions observed in electrical condenser mobility analyzers. However, observations offered by investigators such as Langevin (1905) suggested the presence of ions with mobility three orders of magnitude less than gases in the laboratory. The aspiration condenser of McClelland (1898) and Zeleny (1900) was used extensively to measure the mobility of atmospheric ions for more than 20 years.

With the advent of the differential mobility analyzers in the 1920s, researchers made additional observations, giving some understanding of the classification of large and small ions. A differential instrument was reintroduced in the 1950s with Junge's work, which began to clarify the presence of nano- or ultrafine particles as part of the tropospheric particle size distribution (Junge, 1963). Later, in the 1960s, Whitby and his colleagues at the University of Minnesota (Whitby & Clark, 1966) refined an earlier differential mobility analyzer design and coupled the new instrument with

a CN counter and an optical counter to obtain continuous observations of particle size distributions in many locations.

The direct measurement of nanoparticles as a function of size proved to be very difficult with methods available prior to the 1970s. To some degree, the diffusion battery (Nolan & Guerrini, 1935) offered opportunities for such observations; however, these devices were difficult to use for size-differentiated nanoparticle studies because of the limited means available for particle size determinations.

The metrology of nanoparticles represents an unusually rich topic in the history of atmospheric aerosols. The purpose of this chapter is to present a brief review of the variety of instruments adopted for nuclei measurement and to illustrate the results of observations achieved into the 1970s, especially in relation to cloud microphysics and air pollution. Some interesting applications of the method are included to indicate the technological ingenuity of the users of the method.

Measurement Principles

Design of instrumentation for measuring nanoparticle concentrations relies on three fundamental, size-dependent principles: (a) nucleation or growth by condensation of supersaturated vapor, (b) diffusion of particles by Brownian motion, and (c) electrically charged particle mobility induced by electrical forces.

Vapor Supersaturation

Supersaturation is achieved by cooling during expansion of a moist gas or by vapor transfer between a warm, wet surface and a nearby cool surface. Production of particles as a condensate fog at a given supersaturation depends on the absence or presence of “centers for condensation,” or nuclei. If no nuclei are present, nucleation and condensation take place at high vapor supersaturation by homogeneous processes. If nuclei are present, such as ions or visually nondetectable particles, the supersaturation required is lower, and the vapor condenses on the existing particles. Nucleation and growth in water vapor are dependent not only on particle size but on their physicochemical properties, including solubility (Mason, 1957a; Fletcher, 1966).

The supersaturation ratio (S) for the expansion devices can be estimated readily from the ideal gas law; the percent supersaturation is given as

$$100(S - 1), \text{ where } S = p/p_{\infty} = p_1/p_2 (V_1/V_2)^{\gamma}, \quad (1)$$

where p_{∞} is the saturation vapor pressure of the fluid. The volume V_1 is the volume before expansion, and V_2 is the volume after expansion; p_1 is the saturation vapor pressure of the fluid at temperature T_1 before expansion, and p_2 is that at temperature T_2 after expansion. The exponent γ is the ratio of the specific heats of the vapor at constant pressure and constant volume. The relation between the supersaturation ratio and the expansion ratio is nonlinear; supersaturations of a few percent are generally sufficient to activate natural occurring CN, except for small ions and particles with very large fluid contact angles with a solid nucleus.

Vapor supersaturation also can be achieved by passing air through a volume with the upper and lower plates saturated with water at different temperatures (T_1 and T_2). Supersaturation is reached in mid-chamber as a result of mass and heat transfer across the plates. The condensable vapor is distributed by diffusion, and provided there is no heat loss to the side walls, the fluid vapor pressure in the air will be linearly related to the temperature. Because the saturation vapor pressure is not linearly related to its temperature, the diffusional mixing leads to a supersaturated condition in the chamber. The vapor in the chamber must be at p and T lying between the conditions of the two wet plates. The equilibrium vapor pressure of the fluid at temperature T is however p' , so that the supersaturation is $(p - p')/p'$. This ratio has a maximum near the temperature $(T_2 - T_1)/2$. If there is stirring in the chamber, all particles should experience a supersaturation equivalent to a maximum during their residence in the chamber.

Counters using the diffusion principle have an advantage over the expansion devices because the supersaturation tends to be constant until appreciable particle growth is achieved. However, high supersaturation is difficult to achieve, but values in the range of 0.1% to 3% can be obtained—a regime for which it is difficult to design with expansion instruments. A serious drawback to the diffusion chambers is the influence of the side walls. If they become cooler than the vapor, then larger supersaturation may occur along these walls, upsetting the measurements.

Once supersaturation is achieved in the vapor, nucleation can take place on existing airborne ions or particles, or in some circumstances by self- or

homogeneous nucleation. Macroscopic theory of nucleation basically depends on estimating a rate of production of particles, which is a function of the vapor-supersaturation-extending equilibrium models. At equilibrium, the vapor pressure $p_s(r)$ of condensable vapor over the surface of a droplet of radius r exceeds pressure $p_s(\infty)$ over a plane water surface at the same temperature, as expressed by the Kelvin equation (Mason, 1957a). For a pure liquid, this is as follows:

$$p_s(r)/p_s(\infty) = \exp \left(\frac{2\sigma}{\rho_w R_v T r} \right) = \exp (k/r), \quad (2)$$

where

r = droplet radius,

$p_s(r)$ = saturation vapor pressure of a droplet of size r ,

$p_s(\infty)$ = saturation vapor pressure over a bulk surface of water,

σ = surface tension,

ρ_w = water density,

$R_v = \frac{R}{M_w}$ = gas constant of the condensable vapor,

M_w = mole weight of water,

R = universal gas constant,

T = temperature °K, and

$k = \frac{2\sigma}{\rho_w R_v} = \frac{3.3 \cdot 10^{-5}}{T}$.

Thus, a droplet introduced into a just-saturated atmosphere will evaporate; a droplet cannot persist, much less grow, unless the environment is supersaturated by the amount required by the Kelvin relationship. A critical radius can be defined for a droplet to be at equilibrium with its vapor. Table 1 gives critical radii for pure water as an example. One can readily see the dramatic difference in droplet size with the increased supersaturation ratio from these calculations.

Table 1. Critical radii for water droplets at 20°C for different supersaturation ratios calculated from the Kelvin model

Supersaturation Ratio	Critical Radius, r^* (nm)	Number of Molecules in the Nucleus
1.01	120	2.5×10^8
1.1	12.6	2.8×10^5
2.0	1.73	730
10	0.52	20

Note: Realization of a high supersaturation would activate a range of particles of different size. Landsberg (1938) discussed supersaturation calculations, including probability distributions for homogeneous nucleation.

If a droplet is formed on a wholly or partially soluble nucleus, the equilibrium vapor pressure at its surface is reduced by an amount depending on the nature and concentration of the solute, which means that condensation will occur at a lower supersaturation than on an insoluble particle of the same size. This behavior is governed by Köhler's (1921, 1926) vapor pressure ratio to solubility relationship for critical droplet size. This relationship was modified somewhat later by Mason (1957a). A condensation nucleus is said to be activated when the droplet formed around it reaches r^* , given by the Kelvin-Köhler relationships. Once the droplet exceeds this size, it will continue to grow to cloud droplet size if the ambient saturation ratio remains at a value above the equilibrium curve.

Junge (1935) used the Köhler equation to calculate r^* as a function of solute concentration (e.g., pure water versus a sulfuric acid nucleus) and temperature. Sulfuric acid was assumed as a surrogate for a seed nucleus for CN production. As an example, a sulfuric acid nuclei of 10 nm (10^{-6} cm) in diameter would require a 5% supersaturation to be activated. However, in many cases the chemical composition of a CN is unknown. In the theory of nucleation and formation of CN, one of the persistent questions concerns the lowest size r^* at which they are activated by the applied supersaturation.

Because the classical equilibrium theory for nucleation or growth of pure compounds or soluble mixtures was worked out in the 1930s, the theory has become increasingly complex and has involved considerations of multicomponent solutions, surface properties, and molecular clusters for the nano-size range. However, the classical thermodynamics model is sufficient for characterizing the principles of nucleation, as seen in the CN counters.

Brownian Diffusion

Scientists observed thermal agitation of tiny particles in the nano-range in liquids early in the 19th century. In analogy to diffusion in gases, small particles can “diffuse” through concentration gradients. Later, Einstein (1905) theorized that this motion is inversely proportional to particle size but principally affected the nano-range, because inertial forces on particles are important for larger particle motion. Diffusion of particles by Brownian motion has been observed since the 19th century, but Einstein worked out the theory for such motion shortly after the turn of the 20th century. Basically, the thermal motion of particles is described through a diffusion coefficient,

$$D = BkT, \quad (3)$$

where T is the absolute temperature, k is the Boltzmann constant, and B is the particle mobility, given by Einstein’s theory as $1/6\pi\eta r$, where η is the viscosity of the suspending gas. For very small particles, an added multiplier is the Stokes-Cunningham correction for gas “slip” around the particle. In analogy to gaseous diffusion, Brownian diffusion to a surface is given in terms of a flux proportional to particle concentration gradient (Hidy & Brock, 1970).

Using the particle mobility, a device could be constructed to trap flowing particles as a function of size on a surface. With suitable detection with distance, such devices, called diffusion batteries, appeared in the 1920s (Nolan & Guerrini, 1935).

The theory for particle deposition by diffusion in a slow-moving aerosol was developed before 1940, as reviewed by Knutson (1999) and others. For example, in an appendix to a paper by Nolan and Nolan (1938), Gormley derived the expression for the fraction of particles of diffusion coefficient D penetrating the channel of length L , half height b , and width a with a gas flow rate of q .

$$F = 0.910 \exp(-x) + 0.053 \exp(-11.4x), \quad (4)$$

$$\text{where } x = \frac{3.77bDL}{aq} .$$

The theory of the diffusion battery is thus well established, and the use of such a battery presents an attractive and convenient method of determining the diffusion coefficients of submicrometer particles and subsequently their effective “mean” size and size distribution from the variation in penetration of particles through the battery.

Electrical Forces

Measurement of ions and conductivity in the atmosphere's electrical field has been used to infer nanoparticle concentrations (Ebert, 1901; Israel & Schultz, 1932; Junge, 1963; Reiter, 1985; Flagan, 1998). Particles carrying electrostatic charge move at different rates in an electric field, depending on particle size and charge. Scientists applied this principle to measure ions present in the air.

Electrical mobility analyzers depend on the detection of a collected charged particle, in analogy to a diffusion battery. Millikan (1917) showed that small particles carrying an electrical charge move in a gas under an electrical field E . Instead of relying on particle diffusion to a surface, electrical mobility depends on the action of an external force on the particle to induce motion toward a surface. Electrical mobility Z for a charged particle is given as

$$Z = v/E = neB, \quad (5)$$

where v is the cross-stream particle velocity, E is the electric field strength, and n is the number of unit charges (e) on the particle. Using a suitable electric charge detector, the presence of a particle of given size can be counted, because Z is inversely proportional to particle diameter.

As a rough analogy to Gormley's relationship for a diffusion battery, a relationship between a charged-particle mobility spectrum and the second derivative of the current-voltage in an instrument with cylindrical geometry is given as

$$dN/dZ = (d^2i / dE^2) \times 2LE^2 / [\pi e^2v^2 (b^2 - a^2)2 \ln(b/a)], \quad (6)$$

where dN = number of ions/cm³ in the mobility range between mobility Z and $Z + dZ$, L = length of the electrode, E = condenser voltage, v = average velocity of the ion, b and a = radii of the outer and the inner electrode, respectively, and i = ion current. This equation represents the basis for the experimental determination of the mobility values by observing the breakpoints of the current-voltage characteristics in a cylindrical condenser.

Evolution of Instrumentation

Vapor Condensation

Instruments to detect nuclei are readily designed to produce vapor supersaturation in analogy to atmospheric processes. Nuclei then can be detected optically after rapid condensation growth in a supersaturated vapor

(Podzimek, 1989; McMurry, 2000a). The first experiments to demonstrate condensation of water vapor on nuclei were reported by Coulier (1875) and Aitken (1890/1891), who showed that a fog formed by expansion (adiabatic cooling) in supersaturated air was made denser on introducing combustion products. Aitken concluded that when water vapor condensed in the atmosphere, it always did so upon the dust particles present, using the term “dust” in a wider sense to include hygroscopic and nonhygroscopic particles of all sizes. He was also able to show that the nuclei were not equally effective. Condensation occurs on some with expansion ratios of less than 1%, whereas others required very large expansions of a few hundred percent. Aitken constructed various forms of his dust- (or condensation) nucleus-counter for measuring the number of aerosol particles per unit volume, one of which is shown in Figure 2, along with a later design of Scholz (1932) in Figure 3.

In today’s terminology, the Aitken and Scholz designs are water-based, noncontinuous- expansion-type instruments, with single droplet counting. Sufficient supersaturation (typically 200% to 350%) was achieved by rapid adiabatic expansion. Under these conditions, homogeneous or nanoparticle-based nucleation may take place on “nuclei” as centers for condensation, growing into an easily visible droplet. Particle concentrations then could be calculated by visually counting the droplets after they precipitated onto a microscope counting graticule.

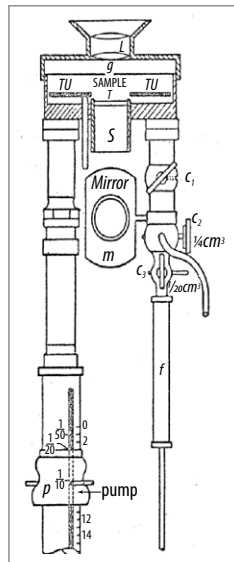
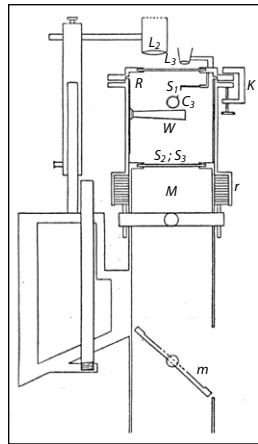

Figure 2. Aitken counter (far left) and schematic diagram of the counter (left).

Note: The replica of the Aitken counter was manufactured by Casella Ltd., London. The central receiver (expansion chamber), r , is lined with wet blotting paper for near supersaturation; p is a piston to introduce air samples into r for vapor rarefaction and condensation; c_1 to c_3 are cocks for outside air or to a cotton wool filter, f ; and l (lens), g (glass), and m (mirror for light transmission) are the optical system for nuclei counts.

Photo: Courtesy of the author; schematic diagram from Landsberg (1938).



Note: This instrument was manufactured by Schulze, Potsdam. It was brought over from Germany in 1934 by Landsberg and eventually given to Woods Hole Oceanographic Institution. *R* is the receiver (expansion chamber) lined with wet blotting paper, *W* is a wetted cotton wool filter to equalize pressure in *R*, and *c₃* is the cock for injecting air into *R*. The optical system includes lenses *L₂* and *L₃* for viewing the reticulated glass plates *S₁*, *S₂*, and *S₃*, with light from the mirror, *m*. *M* is an open cylinder, and *r* is leather ring seals. Photo: Courtesy of the author; schematic diagram from Landsberg (1938).

Figure 3. Modified Aitken counter design of Scholz (left) and schematic of the receiver section (right).

A stereoscopic viewing, photographic version of the Pollak counter, designed by Pollak and Daly (1958), is shown in Figure 4. Visual counting was replaced by photographing the droplets formed after expansion (Pollak, 1952; Pollak & Daly, 1958). These instruments are called absolute nucleus counters because they require only calibration using a fixed geometry in the optical microscope graticule. A considerable operational improvement

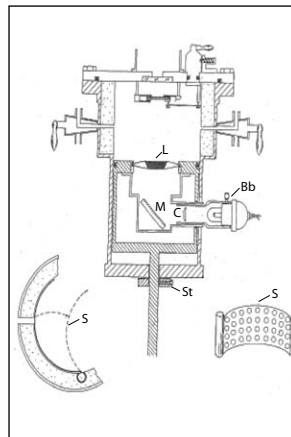
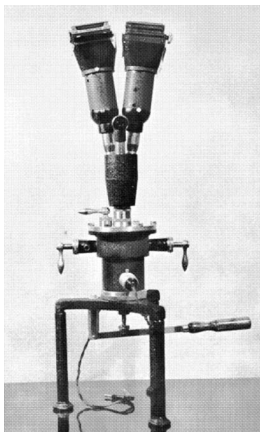

Note: The dark-field illuminator in the lower section below the expansion chamber is accommodated in the piston of the expansion pump and moves with the piston. The illuminator consists of a lens, *L*, blackened in the center; a mirror, *M*; and an electric bulb, *Bb*, with a condenser lens, *C*. (Prolonged and uninterrupted use of this counter was found not to produce fogging of the graticule—a deficiency of earlier counters.) Source: Pollak and Daly (1958).

Figure 4. The Pollak and Daly condensation nuclei counter with stereo-photomicrographic recording (left) and schematic of the receiver section (right).

of these manual counters was reported by Bradbury and Meuron (1938), who developed a photoelectric nucleus counter. Their instrument sensed photoelectrically the attenuation of a light beam by the droplets formed on the nuclei rather than actually counting the number of drops.

Nolan and Pollak (1946) constructed two models of photoelectric counters, the direct-beam photoelectric nucleus counter and the multiflex photoelectric nucleus counter. A photograph of Nolan and Pollak, with T. A. Rich, is included as Figure 5. Subsequent improvements (Pollak & O'Connor, 1955) led to the final Pollak Model 1957 built by Pollak and Metnieks (1957), as shown in Figure 6. Improvements in the photoelectric counter included reducing the diameter of the fog tube to 1 inch and changing the illumination through this tube to a slightly convergent beam. This instrument became the reference for many CN networks and was manufactured until the early 1980s by Robert Gussman (BGI) of Waltham, Massachusetts. Four replicas of the Pollak counter manufactured by BGI were used by the National Oceanic and Atmospheric Administration at Mauna Loa, Samoa, and the South Pole. A recalibration of these instruments after 20 years showed a response curve to be unchanged.

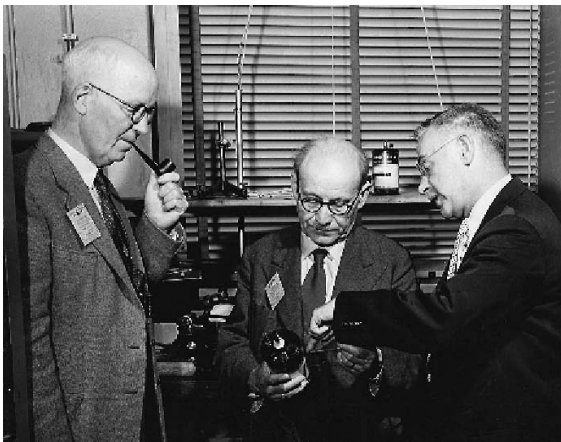
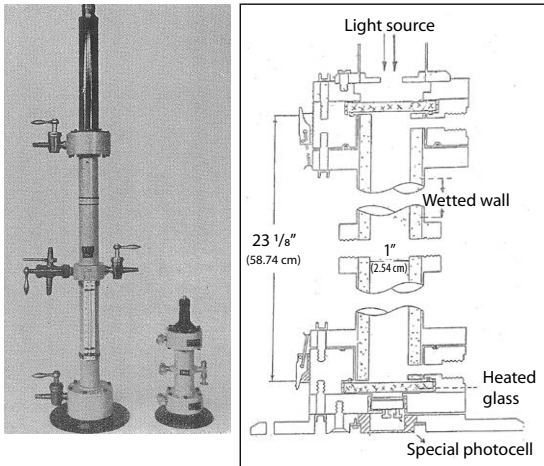

Figure 5. Prof. Pollak (center) and Prof. Nolan (left) with Dr. T. A. Rich (right) at the General Electric laboratories, Schenectady, New York.

Photo: Courtesy of the author.



Note: The chamber consisted of a wetted, porous wall cylinder at the top and a fog chamber below. The formation of an aerosol cloud with supersaturation by vapor expansion in the sample chamber was observed optically by light transmission to the photocell at the base. Outside air or filtered air was introduced into the chamber through the cocks, along with rarefaction of the vapor sample by release of pressure.

Source: Photo from Pollak and Metnieks (1963); schematic diagram adapted from Metnieks and Pollak (1959).

Figure 6. Photoelectric condensation nuclei counter (Pollak Model 1957) and small, portable photoelectric condensation nuclei counter (left) and diagram of the receiving chamber of the counter (right).

Photoelectric counters are relative instruments and were calibrated against some reference, such as an Aitken counter. The calibration of the Pollak counter was done by a tube-bridge dilution system that produced a response curve for the instrument. The response curve was fitted to absolute values at several points by using simultaneous measurements with a photographic version of an expansion-type counter. The Pollak and Metnieks (1960) calibration of the photoelectric nucleus counter is within 10% of that obtained by comparison with several “absolute” nucleus counters and also when compared with independent, nondroplet-forming aerosol techniques (Liu et al., 1975). Using a slide placed between the photocell and the fog tube, William Winters developed a simple field optical calibration of the Pollak counters. The slide contained an open window, three neutral density filters, and an opaque window. Winters set the instrument at full scale on the open window and simulated an expansion by sliding a neutral density filter in place. Loss of transmission equal to that of the filter verified that the optical and electrical components were responding properly.

Vonnegut (1949, 1954) designed the first fully automated and continuously operating, water-based, expansion-type photoelectric CN counter, with improvements added later by Rich (1961). The air was bubbled through water to humidify it, and a cloud was formed in a small chamber by a

pulsating pressure from a diaphragm pump. The density of the cloud was measured by the forward scattered light in a dark illuminator. This instrument was used on aircraft searching for submarines (combustion aerosol from submarine diesel engines). Skala (1963) developed the General Electric (GE) condensation nuclei meter, as shown in Figure 7. Skala adopted many of the Rich (1961) design features and developed the first commercially available “automatic” photoelectric instrument, with five expansion cycles per second and a concentration range from 300 to more than 10^7 particles/cm³. Upon founding the Environment One Company in 1972, Skala and Rich developed a new automatic CN counter, which they marketed commercially as the E/One Rich 100 and 200 instruments.

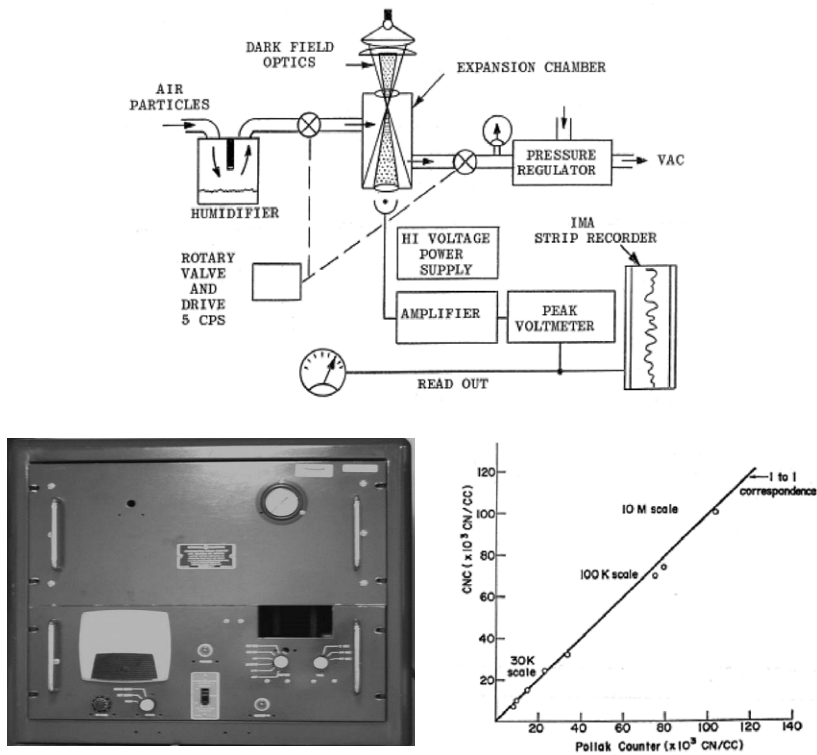

Figure 7. General Electric continuous condensation nuclei counter.

Note: The counter involves expansion and compression with a continuous air sampling and exhaust through a rotary diaphragm valve and photoelectric detection of the onset of nucleation. At the top is a schematic of the instrument. Lower left is a photo of the front face of the instrument, and the calibration curve for the counter versus the Pollak counter reference is at the lower right.

Photo: Courtesy of the author; schematic diagram and calibration adapted from Skala (1963).

Virtually all research and CN monitoring before the mid-1970s used expansion-type instruments, with water as the working fluid. Since then, expansion-type CN counters were increasingly replaced by vapor-diffusion-based CN counters, where the condensation growth is achieved by forced convection. Early on, Langsdorf (1936) built a vapor-diffusion-based CN counter using methyl alcohol as a working fluid. Rosen designed the first continuous particle counters (CPCs) of this kind during the 1970s (Rosen et al., 1974; Bricard et al., 1976; Sinclair & Hoopes, 1975). Rosen's instrument was a thermal-gradient diffusion cloud chamber using water as the condensing species. The Bricard and Sinclair and Hoopes instruments used a warm saturator followed by a cold condenser where the growth started. These two instruments employed alcohols as the condensing vapor. Alcohols were used mainly because their vapor pressure is high enough that particles grow to detectable sizes and their diffusivity is low enough to prevent the vapor from diffusing too fast to the walls of the instrument. Agarwal and Sem (1980) described a later model.

Another type of steady-flow instrument is the mixing-type CPC. In these instruments, cold aerosol flow is turbulently mixed with hot vapor and then cooled rapidly. Typical working fluids are water and different oily substances, such as dioctyl-phthalate. Sutugin and Fuchs (1965) built the first of these instruments in Russia. The advantages of these instruments are that they can be designed easily to have small diffusional losses and small detectable sizes. They can also handle large sample flow rates. The steady-flow instruments have grown in favor because of the ease with which absolute concentrations can be measured using single particle counting techniques and because the steady flow eliminates pulsations that can interfere with associated instrumentation, such as differential mobility analyzers or diffusion batteries.

The Diffusion Battery

In the early 20th century, samplers based on diffusion of particles in Brownian motion emerged that have been useful for detecting nano-range particles. Nolan and Guerrini (1935) initially applied the method to CN by using a diffusion battery containing a number of parallel rectangular channels. Diffusion batteries based on Brownian diffusion in laminar flow have been designed and used for particle number-size estimates (Thomas, 1955; Fuchs & Stechkina, 1962) or have been used with supersaturators for size-differentiated nuclei counting (Pedder, 1971). A variety of designs for diffusion batteries

were developed (Knutson, 1999) and applied to atmospheric nanoparticle sampling (Twomey & Severynse, 1964). After the 1970s, the use of diffusion batteries was supplanted by continuous methods, such as the electrical mobility analyzer, and the diffusion batteries were largely abandoned for atmospheric observations.

The usefulness of diffusion batteries was significantly enhanced when Pollak and Metnieks (1957) showed that, through application of a mathematical algorithm, called data inversion, these devices could be used to determine aerosol size distributions, not just the mean particle size. Knutson (1999) also noted that D. Sinclair simplified the inversion problem by using a graphical stripping technique for a polydispersed aerosol to obtain a size distribution. Fuchs and Stechkina (1962) and a number of other investigators refined the data inversion theory, extending into the 1990s (Knutson, 1999).

Rich (1966) developed an example of a combination of the diffusion battery concept and an electrical detector. He described a parallel-plate device with electrically isolated metal plates. With the plates at the same potential, the sampler functioned as a diffusion battery. With 300 volts applied to alternate plates, it could be used to measure not only the particle diffusion losses but also the fraction of particles charged. If readings were taken of an aerosol fed directly to a CN counter, after passing through the diffusion battery with no voltage applied and with voltage applied, then two component aerosol particle models could be determined. This process would characterize the unknown aerosol being measured, providing the mean diffusion coefficient (diffusion size) and the mean electrical mobility of the aerosol.

Ion Mobility Analyzers

The application of electrical mobility to atmospheric particle measurements occurred roughly a decade after Aitken's work. The coaxial condenser mobility analyzer (integral method), introduced by McClelland (1898) and improved by Zeleny (1900), enabled Ebert (1901) to measure atmospheric ions as early as 1901. Other observations of atmospheric ions date back to Langevin (1905), McClelland and Kennedy (1912), and Pollock (1909, 1915). A broad range of electrical mobility observations were made from small ions with mobility of about $1 \text{ cm}^2/\text{volt sec}$ and an estimated size of a few tenths of nm to ultralarge ions with mobility of about $10^{-4} \text{ cm}^2/\text{volt}$ and estimated sizes of well over 100 nm (Nolan et al., 1925). Torreson and Wait (1934), as well as others, showed that the large ions are related to the neutral CN in the

atmosphere, their only difference being the acquisition of a charge through collision with small ions of either sign (bipolar ion charging).

Scientists obtained small ion and nanoparticle mobility spectra in the diameter range of 0.4 nm to around 15 nm from instruments derived from the ventilated cylindrical capacitor designs of Zeleny (1900) and Gerdien (1905). The distinction between small ions and nanoparticles was defined by mobility, with particles of mobility greater than $5 \times 10^{-5} \text{ m}^2 \text{ V}^{-1} \text{ s}^{-1}$ (smaller than ~ 1.8 nm) classified as small ions and particles of lesser mobility (larger size) classified as nanoparticles. Mobility, mass, and diameter are evaluated by application of kinetic theory (Chapman & Cowling, 1960), which can include the effects of direct coulomb interaction, image charge interaction, and a Lennard-Jones interatomic potential.

The aspiration condenser, which used a cumulative estimate of electrical mobility from equation 6, dominated measurements of atmospheric ions until the late 1960s, even though Erikson (1921) previously developed a differential mobility analyzer. The differential method of determining mobility has the advantage over the integral method of directly giving the percentage of particles with mobility lying in a given range. The current flowing to the electrode is so small, however, that it is difficult to measure. After the electronics were improved in the 1960s, these instruments were reintroduced. They were based on condenser measurements of atmospheric ions, which Junge (1955) used to describe the structure of the nanoparticle number-size distribution (Figure 1).

In the 1960s, Whitby and his colleagues at the University of Minnesota developed an electrical mobility analyzer, which is the basic prototype used today for a range of nanoparticle size determinations. The electrical mobility analyzer was a refinement of earlier developments, including a Faraday cup electrometer used earlier by Zeleny and McClelland. The instrument with electrical charge detection associated with particle mobility represented an important breakthrough for continuous observations of particle size distributions in the nano-range. Whitby and Clark (1966) incorporated a sensitive micro-microammeter into their differential mobility analyzer design. This 1960s Keithley electrometer avoided the delicate electronics of earlier detectors and was more robust for field use. The sensitivity of their mobility analyzer with the Keithley electrometer was determined to be 10^{-13} amperes or 10^6 electrons/sec. The minimum charged particle concentration that could be measured was $\sim 1,000/\text{cm}^3$ with an aerosol flow of 1 liter/sec. Thus, without

further refinement, the mobility analyzer could measure urban nanoparticle levels but not offshore marine or upper tropospheric conditions.

The concept of the Whitby mobility analyzer for segregating polydispersed aerosols is shown in Figure 8. This instrument depends on controlled charging of particles as a function of size, followed by lamellar flow of the charged aerosol through an annulus such that the smallest particles migrate to a central annular electrode or to the tube walls in an electric field across the tube. Larger particles deposit farther down the annulus. The radial velocity is determined by a balance between the electrical force field and the opposing drag force on the particles. Those particles that are not collected on the electrode at a given voltage flow into an electrometer for measurement. By varying the imposed voltage across the outer wall of the tube and the inner electrode, a resulting particle flow to the electrometer can determine electrical mobility of a size fraction and thereby deduce particle number-size distributions in the range of ~ 5 to 500 nm.

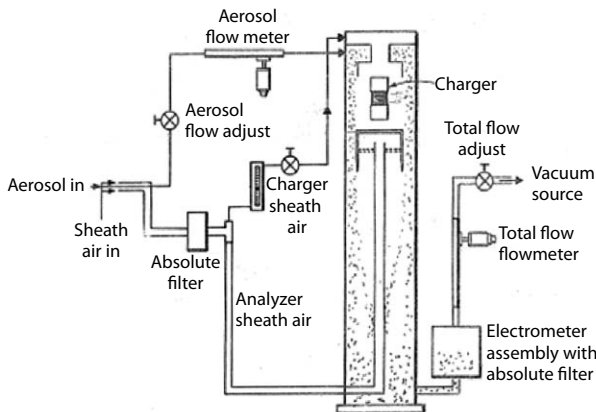

Figure 8. Conceptual scheme for the electrical mobility analyzer.

Note: This analyzer is most effective for particle measurements in the ~ 5 to 500 nm diameter range and is based on a relationship between unique charge accumulations as a function of particle size.

Source: Adapted from Whitby and Clark (1966).

The electrical mobility analyzer was coupled with a calibrated optical counter for the 500 to 10,000 nm range and a CN counter to provide a means of measuring N and the number-size distribution from the nano-range of ≤ 5 nm to the coarse or giant particle regime of 10,000 nm diameter (Whitby & Sverdrup, 1980). This hybrid, called the Minnesota Aerosol Analyzer System (MAAS), was sufficiently robust and reliable to be commercially produced after the 1970s by TSI, Inc., of Minneapolis, Minnesota. With modern CPCs and fast digital signal processing, the MAAS technology serves as a basis for measuring particle number-size distributions today.

The Whitby electrical mobility analyzer was calibrated in the laboratory using suspended monodispersed particles of a known diameter. This instrument was compared with the Pollak CN counter in the 1970s (Liu et al., 1975). A comparison between the two instruments is shown in Figure 9. These experiments showed conclusively that the Pollak water-based CN counter is indeed an aerosol particle detector, and its response is unaffected by the size and the chemical constituency of the particles with the range of conditions covered by these experiments. Thus, the Pollak instrument and associated CN devices are capable of measuring particle number concentration comparable with alternate methods.

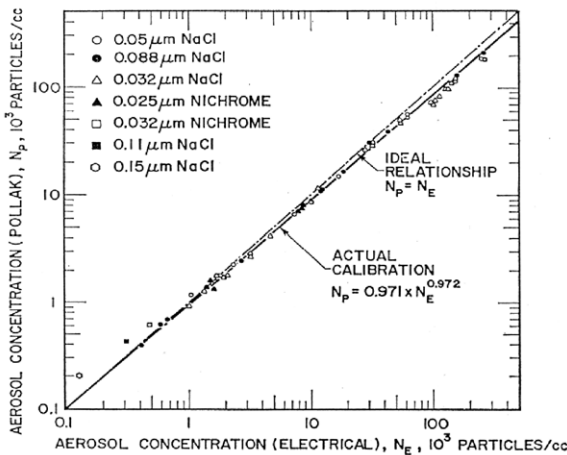

Figure 9. Water-based expansion counter (Pollak Model 1957) versus electrical mobility analyzer of the University of Minnesota for monodispersed aerosol particles of NaCl and Nichrome.

Source: Liu et al. (1975). Reprinted by permission of the American Meteorological Society.

Nuclei Observations in the Atmosphere

The discovery of nanoparticles in the atmosphere in 1875 triggered intense scientific interest as to their origin, chemical constitution, and global distribution. Early on, scientists postulated that all radiations originating beyond the earth's atmosphere, in particular, the ultraviolet radiation, as well as radioactive gases emanating from the soil and other ionizing radiation (e.g., X-rays and electrical discharges), potentially initiate the creation of nuclei if the proper precursor gases are present in sufficient quantity (Aitken, in Knott, 1923). Researchers investigated a host of substances for their nucleation potential, and human activities, especially combustion of all kinds of material, came under scrutiny. Even the passage of the earth through the tail of Halley's Comet in 1910 was watched for increase of nuclei, but nothing abnormal could be found (Aitken, 1910; Tetens, 1911). Some hundred years after their discovery, a rather broad knowledge base as to the presence of CN in the earth's atmosphere has accumulated. An understanding of the physicochemical processes and mechanisms involved in homogeneous and heterogeneous particle formation now exists.

Using the early counters in parallel with other aerosol particle sampling, scientists reported a variety of observations, beginning with Aitken's work. Thousands of observations of early CN concentrations across the world were summarized before World War II for different conditions in the troposphere, as listed in Table 2. The table indicates that the nuclei concentrations vary widely, depending on the remoteness of the location and in marine or continental conditions. It appears that the lowest concentrations typically fall in the 10^2 to 10^3 nuclei/cm³ range, whereas in polluted air concentrations exceeding 10^4 to 10^6 nuclei/cm³ can be found. These ranges suggest that aerosol particles are present from sources or from atmospheric formation under virtually all conditions. The CN data also show a strong contrast between rural and urban conditions—an early measure of air pollution.

Representative CN concentrations over the oceans, remote from human activity and not modulated by local variations in topography and terrain, were first reported from the research ship Carnegie on her various cruises. Before the Carnegie voyage, researchers reported a number of atmospheric conductivity observations, which evidently were unadjusted for CN concentrations. Observations from 221 locations indicated that concentrations less than 40×10^2 nuclei/cm³ comprise more than two-thirds of all the observations (Shiratori, 1934). Scientists aboard the Carnegie also

measured electrical conductivity of the atmosphere (air-earth current) during the ship's voyages. The observed levels of conductivity depended on the N concentration, because small ions are annihilated rapidly by particle collisions and thereby reduce the conductivity. The sources of particles in the remote marine atmosphere were largely attributed to evaporated sea spray.

Table 2. Summary of Aitken nuclei (CN) concentration ranges in the troposphere in different geographical conditions (observations in 10^3 nuclei/cm³)

Locality	Places	Observations	Average	Avg. of Maxima	Avg. of Minima	Absolute Maximum	Absolute Minimum
City	28	2,500	147	397	49.1	4,000	3.5
Town	15	4,700	34.3	114	5.9	400	0.620
Country inland	25	3,500	9.5	66.5	1.05	336	0.180
Country seashore	21	2,700	9.5	33.4	1.56	150	0
Mountain 0.5 to 1.0 km altitude	13	870	6.0	36.0	1.39	155	0.03
1 km	16	1,000	2.13	9.8	0.450	37	0
>2 km	25	190	21	5.3	0.160	27	0.006
Islands	7	480	9.2	43.6	0.460	109	0.08
Oceans	21	600	0.941	4.68	0.840	39.8	0.002

Source: Landsberg (1938).

Several decades later, the State University of New York at Albany created a network for CN measurements. This program measured the geographic distribution of CN over the North Atlantic Ocean with the participation of the State University Maritime College and many of its alumni, who made observations from ships. The US Merchant Marine also contributed to the project. Merchant ships frequently crossed the ocean on fixed routes, providing opportunities for repeated measurements by location (Hogan et al., 1967). An analysis of the average value of CN concentrations recorded with specially modified and calibrated photoelectric counters is shown in Figure 10 for the time period 1966 to 1971 (Hogan et al., 1973). On average, a strong continental influence was observed well west of Europe and east of North America and in the Bermuda and Azores high barometric-pressure

regions. These continentally influenced CN concentrations were often found to extend across the Atlantic Ocean at 40°N in fair weather. In contrast, during stormy conditions, concentrations $<3 \times 10^2$ nuclei/cm³ were often found a few kilometers offshore. A chronology of mid-Atlantic CN data shown in Figure 11 from different investigators does not reveal an obvious long-term trend.

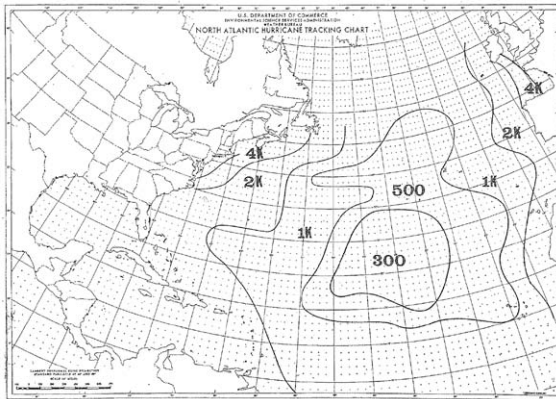

Note: The highest mean values were found in the regions generally characterized by persistent high-pressure systems. The lowest concentrations were found in mid-ocean. The large-scale gradients in condensation nuclei (CN) imply long-range transport of CN with near-surface air flow from the continents, which was well established in the 1980s. Source: Hogan et al. (1973). Reprinted by permission of the American Meteorological Society.

Figure 10. Mean condensation nuclei concentrations (nuclei/cm³) observed over the North Atlantic Ocean during the period 1966–1971.

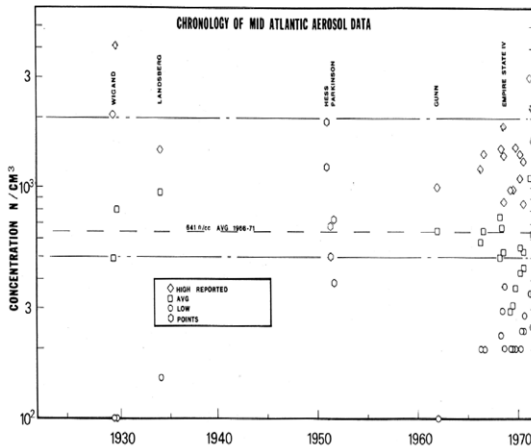

Note: The graph includes data from Wigand (1929), Landsberg (1934), Hess and Parkinson (1952), Gunn (1964), and Hogan and colleagues (1973) (Empire State, 1966–1971). Data show a large scatter, but no evidence of trends from the 1930s to 1970, even though Gunn (1964) suggests a few percent increase in fine particle concentrations between 1929 and 1962. Source: Data collected by Hogan et al. (1973)

Figure 11. Measurements of marine condensation nuclei concentrations (nuclei/cm³).

Early in the 1900s, Wigand (1919) explored the vertical distribution of CN in the troposphere. Much later, Junge (1961; Junge et al., 1961) combined his results with earlier results in conjunction with developing a description of particle concentrations in the troposphere and the lower stratosphere. A composite of these observations is shown in Figure 12. The CN concentrations generally decrease with altitude to levels well below 10^2 particle/cm³, as Junge demonstrated. Included in Figure 12 is an altitude profile obtained over Sioux Falls, South Dakota, in June 1960 with a specially designed, balloon-borne, expansion-type counter with photographic recording (Junge, 1961). The instrument measured all particles below 100 nm and concentrations between 1 and 500 particles/cm³. Junge’s investigation eventually led to the discovery of the stratospheric aerosol layer around 20 km altitude, called the Junge layer in his honor (Junge et al., 1961). The average distribution shown in the troposphere from Junge’s composite below about 12 km can be interpreted in terms of the vertical mixing of a ground-based, “global” particle source (Hidy, 1972).

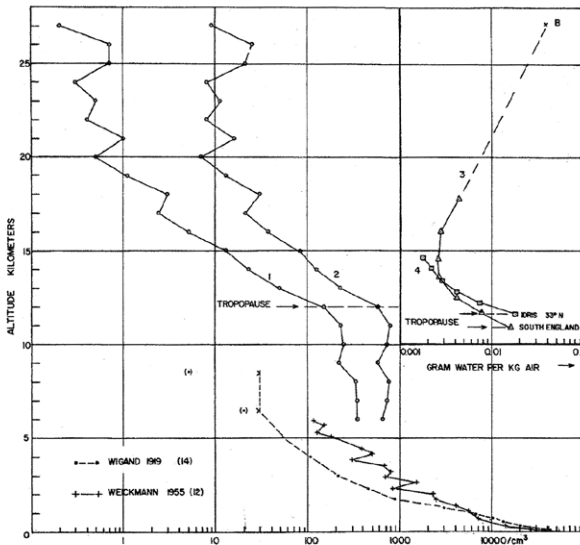

Figure 12. Observations of the vertical distribution of condensation nuclei (nuclei/cm³) based on Junge’s summary.

Note: The increases in concentrations in the lower stratosphere are often associated with Junge’s discovery of the sulfate layer at ~25 km. Curves 1 and 2 are from aircraft flights. The two lower curves are based on data of Wigand (1919) and observations of Weickmann (1955). The inset curves are water vapor mixing ratios. The decline in concentration with height can be attributed largely to vertical mixing of a ground-based particle source with atmospheric turbulence (e.g., Hidy, 1972).

Source: Junge (1963).

A group of University of Wyoming scientists (Rosen et al., 1974) obtained regular stratospheric CN profiles by using a thermal-gradient diffusion cloud chamber that dated back to the stratospheric Climatic Impact Assessment Program (CIAP) of the mid-1970s. These profiles, an example of which is shown in Figure 13, have been used as a fundamental measure for the calibration of lidar-based remote sensing of the atmosphere. The sampling aloft continues to be of significant importance as a trend indicator for the CN concentration aloft and for characterizing the stratospheric aerosol.

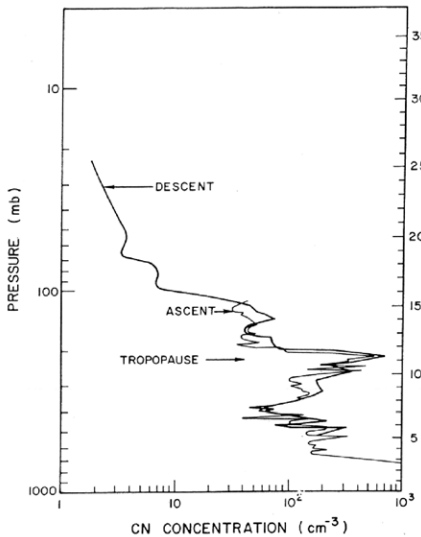

Figure 13. Example altitude profile obtained with the Wyoming condensation nuclei counter (Climatic Impact Assessment Program) thermal-gradient diffusion cloud chamber (working fluid: ethylene glycol).

Source: Rosen et al. (1974).

Hogan and Mohnen (1979) reported an unusual experiment to examine the distribution of CN at all latitudes during a brief period as part of a circumpolar navigation of the earth on October 28–31, 1977, by Pan American Airways Flight 50 in celebration of that airline's 50th year of operation. A Boeing 747SP was used for that flight and carried instruments deployed by the National Aeronautics and Space Administration for its Global Atmospheric Sampling Program (GASP). The 747SP aircraft, cruising at altitudes near the tropopause (as high as 13 km), was equipped with an automatic CN counter specially designed for the GASP program by the Environment One Company. The latitudinal variation in CN concentration around the world from the flight is shown in Figure 14. Concentrations of 10 to 40 nuclei/cm³ were found in

the Arctic and northern mid-latitude stratosphere, and concentrations of 10 to 25 nuclei/cm³ were found in the stratosphere in those latitudes over the Southern Hemisphere. CN concentrations measured in the tropical troposphere are of interest because a symmetry of high CN concentrations exists over both the land and the water hemisphere, unlike in the boundary layer air. Higher concentrations were also found over the extratropical frontal regime north of New Zealand.

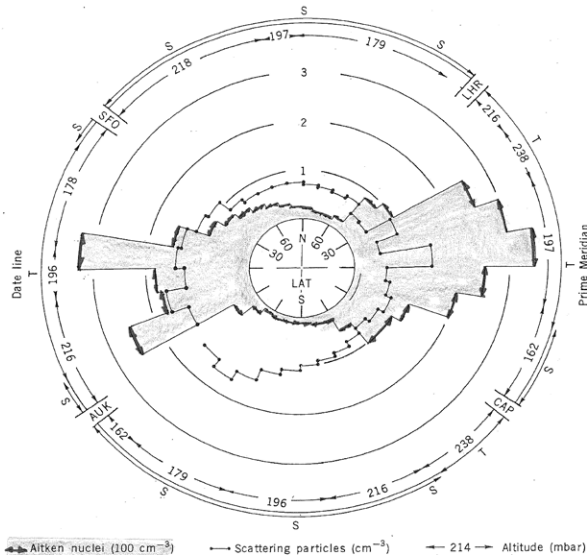

Figure 14. Global distribution of condensation nuclei at tropopause levels from the Boeing 747 SP circum-globe flight in October 1977.

Note: Data were taken from an Environment One water-based, expansion-type photoelectric condensation nuclei counter. Larger light-scattering particles are also included. Locations include San Francisco (SFO), Capetown (CAP), LHR (London), and Auckland (AUK).

Source: Hogan and Mohnen (1979).

CN concentrations in the boundary layer over land vary by orders of magnitude and over short temporal and spatial scales, depending on proximity to sources and meteorological factors, including mixing depth and clouds. This variance was demonstrated by systematic studies of CN concentrations, such as those carried out by Hogan (1966) in New York City; on the eastern shore of Lake Ontario (Oswego, New York); in a sparsely settled area within

the Adirondack State Park at Whiteface Mountain, New York; and at Yellowstone National Park in Wyoming. These sites, except New York City, were examined for a minimum amount of influence from local sources. A frequency distribution of concentration is used to describe an Aitken nuclei climate. As shown in Figure 15, the cumulative frequency distribution of CN concentrations very closely approximates a log-normal distribution at all locations, with the standard deviation and median being a characteristic of the site and season. The mean concentration levels reported by Hogan (1966) are in good agreement with the corresponding concentration levels quoted by Landsberg (1938).

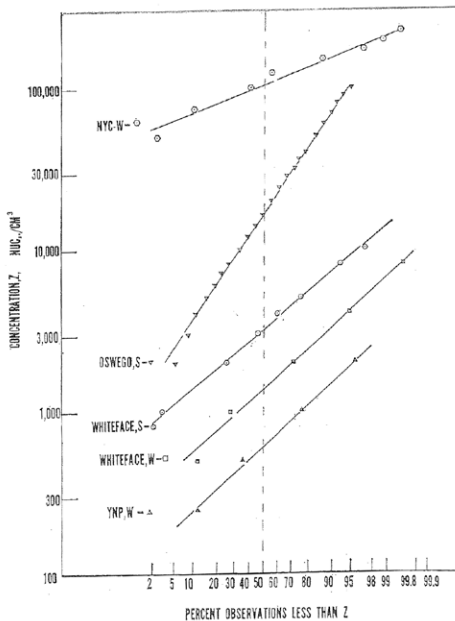

Figure 15. Representative cumulative frequency distributions of condensation nuclei concentrations at several sites in the mid-1960s.

Note: Data are from winter (W) and summer (S), covering background to highly polluted areas of the United States (New York City, Oswego, Whiteface Summit, 0.82 km altitude; Whiteface Lodge, 0.5 km altitude; Yellowstone National Park, 2.1 km altitude).

Source: Hogan (1966).

The variation of CN from the outskirts of a large settlement to its interior has been the subject of several investigations. Gemuend (1907, 1908) was the first to conduct surveys in various cities throughout Germany. In Hamburg he found in the central part of the harbor 1.4×10^5 nuclei/cm³, as against 8.0×10^4 in the court of the city hall, and 1.6×10^3 on the outskirts of town. Kiel showed a variation between 8.0×10^4 nuclei/cm³ in the center of town and 10^4 nuclei/cm³ about 2 km outside of town. In Aachen the variation was between 1.60×10^5 and 3.0×10^4 nuclei/cm³. Schmidt (1918) was one

of the first to document this dependency near Vienna (Austria). The average nuclei concentration was 1.7×10^4 nuclei/cm³ when the wind came from the open country, rose to 4.6×10^4 nuclei/cm³ when the wind had traveled 8 km from an industrial section, and became 1.9×10^5 nuclei/cm³ if the distance to the factories and dwellings downwind was within 3 km. From Innsbruck (Austria), Ginner and Hess (1937) reported as an average of many measurements 3.6×10^4 nuclei/cm³ in the center versus 1.2×10^4 nuclei/cm³ outside of town. As is now well accepted, the location of an observation place with regard to the sources of pollution is the deciding factor when analyzing CN data as to their connection with wind direction.

A perspective on the concentration differences between size fractions of the tropospheric aerosol and different measures of cloud or ice nuclei is shown in Figure 14 from 1960s observations in northeastern Colorado (Hidy et al., 1970). This location is in a rural agricultural area 100 to 200 km east of the urbanization of the region adjacent to the Front Range of the Rocky Mountains. A ground-level record in the summer of 1970 at New Raymer, Colorado, is shown in Figure 16. The data record shows an order of magnitude difference between CN and CCN concentrations (at 1.5% water vapor supersaturation) at this site and two orders of magnitude difference between optical particle counts >150 nm radius and the CCN concentrations. The concentrations of ice nuclei (IN, nominally insoluble particles assumed to be mainly soil dust) are even lower in the region. These observations for CN and CCN are consistent with the expectations from Junge's schematic picture in Figure 1.

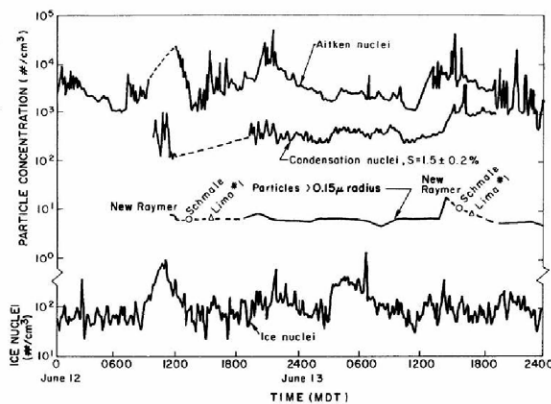

Figure 16. Observations of condensation nuclei, cloud condensation nuclei, and ice nuclei concentrations obtained in a remote area of the Great Plains in northeastern Colorado.

Note: The graph shows different characteristic measures of cloud-related particles in the lower troposphere. Each of the measures of particles involves particle size and characteristic physical properties (especially ice nuclei).

Source: Hidy et al. (1970).

Hidy and colleagues (1970) also reported typical observations for CN from aircraft flights over New Raymer in different summer cloud conditions. At 2 km above the ground, near summer cumulus cloud base, CN concentrations ranged from 4×10^3 to $>1.8 \times 10^4$ nuclei/cm³, depending on cumulus cloud presence or haze observed. Above 6.5 km altitude, the concentrations observed ranged from $>10^4$ nuclei/cm³ under clear conditions to 2×10^2 nuclei/cm³ for developed cumulus to cumulonimbus cloud conditions. Such data indicate the high degree of variability in the troposphere depending on continental air mass conditions.

Mid-continental conditions are compared with summer “background” observations in Greenland of Flyger and colleagues (1976). At the surface, CN were ~ 150 nuclei/cm³, whereas airborne observations varied from 10^2 to 10^4 nuclei/cm³. In contrast, CCN (at 0.5% water supersaturation) over the neighboring North Atlantic Ocean were ~ 12 nuclei/cm³, and IN were 0.01 to 0.1 particles/l. Both of these cloud-active nuclei levels were much lower than those in Colorado; however, the CN levels aloft over land tended to be in the upper range of those over Greenland.

One important part of Junge’s research was establishing the linkage between the CN-ion measures for particles and the atmospheric particle size distribution, as shown schematically in Figure 1. The basis for his conceptual model of the aerosol size distribution derived from his careful work with electrical mobility measurements and his observations of particle size and number from microscopic evaluations. Junge’s pioneering efforts led him to the formulation of a number-size distribution function that by and large is still valid today. Junge’s original particle number-size distribution is shown in Figure 17. The observations illustrate the abundance of Aitken (CN) nuclei in ambient air, though their contribution to total aerosol mass concentration is minor.

Scientists expanded Junge’s classical work on particle size distributions significantly in the late 1960s and beyond, once the MAAS analyzer was placed in the field. They generated a large number of particle size distributions, which ranged from remote areas to urban conditions in parts of the United States. The conditions representing photochemical smog in comparison with rural conditions in California were well described in the 1969 Pasadena experiment (Whitby et al., 1972) and later in the California Aerosol Characterization Experiment (ACHEX) (Whitby & Sverdrup, 1980). These experiments clarified the “universal” characteristics of Junge’s number-

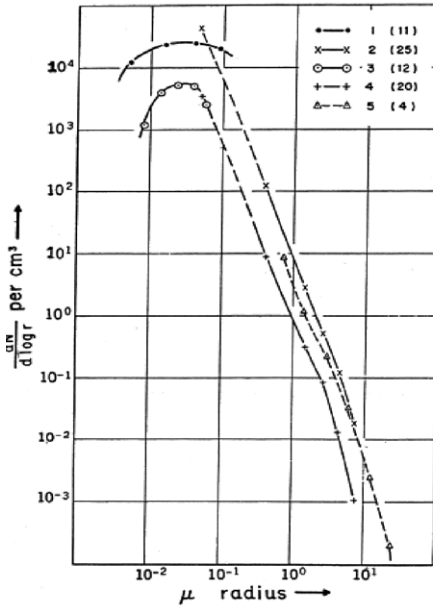

Figure 17. Junge's average number-size distribution for tropospheric aerosols.

Note: Curves 1, 2, and 5 are measurements from Frankfurt/Main, Germany. Curve 1 represents ion counts converted to nuclei numbers. Curve 2 represents data from impactor samples. The point below $0.1 \mu\text{m}$ radius was obtained from the total condensation nuclei (CN) number under the assumption that the radius (r) interval of the CN is $\Delta \log r = 1.0$. Curve 5 represents average sedimentation data over a period of 11 days. Curves 3 and 4 are measurements at the Zugspitze, Germany, 3 km above sea level, and correspond to Curves 1 and 2 for Frankfurt. The numbers in parentheses give the number of individual measurements. The dashed curves between 8×10^{-2} and $4 \times 10^{-1} \mu\text{m}$ are interpolated to connect the ion counts or CN counts with the optical microscope determinations.

Source: Junge (1955). Reprinted by permission of the American Meteorological Society.

size distribution and showed that the surface density-size and the volume density-size distributions were multimodal in character for tropospheric aerosols. The multimodality was not clear in the original observations reported from Junge's (1963) assessment.

The examples provided here give a brief overview of the observations of CN and CCN related by investigators to basic tropospheric aerosol chemistry and cloud microphysics before 1975. Investigators almost universally obtained their observations of CN with Aitken-type counters, either with handheld devices or with continuous instruments, combined with the later entry of observations from electrical mobility instruments. The collection of these historical data appears to have been largely lost to the current generation of atmospheric nanoparticle investigators. Nevertheless, the data represent a rich resource of observations that characterize the presence of tiny particles in one form or another across the globe in marine and continental conditions.

As an outgrowth of interest in atmospheric nuclei, much of the post-World War II research was devoted to nuclei measurements involving cloud microphysics. The measurements of CN were embedded in the general topic of cloud microphysics and spawned sufficient interest in the atmospheric science community to organize a series of international conferences

on nucleation and condensation processes, beginning in 1955 with the participation of 40 scientists in the First International Conference on Condensation Nuclei, held at the School of Cosmic Physics at the University of Dublin. At the Second Symposium on Condensation Nuclei, B. J. Mason (1957b), London's Imperial College world authority on cloud physics of the 1950s and later head of the British Meteorology Service, commented that with the expanding knowledge of cloud microphysics, there was a move from the Aitken particle regime to focus on larger (CCN) particles as the driver for cloud formation. A reason for this shift in emphasis derived largely from the unresolved problem of accounting for growth of hydrometeors from small droplets $\leq 50 \mu\text{m}$ to precipitation size ($>1,000 \mu\text{m}$) in the time interval for cloud formation and dissipation. An analogous problem exists for nanoparticle growth to the submicrometer and micrometer size range of aerosols. Formation and growth rates across the particle-hydrometeor size spectrum remain a challenging issue for scientists today.

Some Applications for Aerosol Source Identification

An important feature of modern CN counters is their superior sensitivity, being capable of detecting ultimately a single nanoparticle with diameter larger than 5 nm by magnifying its size with condensing vapors (water or other suitable fluids) into the optically active or visible size range (around $10 \mu\text{m}$). The corresponding volume magnification of a factor 10^{10} enables a theoretical mass detection capability of less than 10^{-18} grams. Only very few instruments can match this performance level and then only with considerably more demanding technology. But even under more realistic conditions, CN counters offer applications in several different scientific, industrial, or even military areas other than atmospheric research. In general, all gas-to-particle conversion (GPC) processes are of potential interest for further investigation as to the characterization potential of a specific source or for a specific purpose (Mohnen & Lodge, 1969).

For example, it is well known that ammonia reacts with nitric acid to form ammonium nitrate particles. Ozone reacting with terpene vapor is also known to form particles. Consequently, the potential exists for detecting either of these gases in the atmosphere, provided the GPC conversion can be optimized with regard to particle detection and noninterference. Schaefer (1978) built a simple device to measure nitric acid and ozone across the United States, sampling ambient air in a plastic bag saturated with either ammonia (for

HNO_3 detection) or beta-pinene (for O_3 detection) and recording the particles formed in this reaction with a portable photoelectric CN counter of Rich (1955). Schaefer wrote, "In relatively clean air having a total concentration of particles larger than 5 nm diameter of 10^3 particles/cm³, the presence of 20 parts per billion of ozone will increase the particle concentration within a couple of seconds to more than 10^6 particles/cm³." Anecdotally, in the Antarctic winter, S. Barnard apparently was able to obtain similar CN levels by squeezing an orange peel.

Ammonia and hydrochloric acid vapors react to form a visible ammonium chloride fume. In the mid-1960s, researchers from GE (Schenectady, New York) designed an instrument based on this reaction for deployment in Vietnam as a "man sniffer" (Figure 18). The idea was that people perspire and emit ammonia and thus reveal their presence in underground tunnels or in the jungle. The security-classified gas-to-particle converter used an ion molecule reaction and subsequent ion nucleation. First the air was ionized, leading to the formation of hydrated ammonium ions $\text{NH}_4^+(\text{H}_2\text{O})_n$, and then exposed to saturated hydrochloric acid vapor (Coffey, 1972), leading to the nano-size cluster ions $\text{NH}_4\text{Cl}^+(\text{H}_2\text{O})_x(\text{HCl})_y$ that were detected in a portable, automatic photoelectric CN counter specially designed by GE for that purpose. The lowest detection limit for this device was slightly below 100 parts per trillion NH_3 in ambient air. The specially designed CN instrument without converter was used in Vietnam as a combustion sensor by dropping it from aircraft near the major supply routes through the jungle to detect and monitor vehicular traffic of the North Vietnamese army.

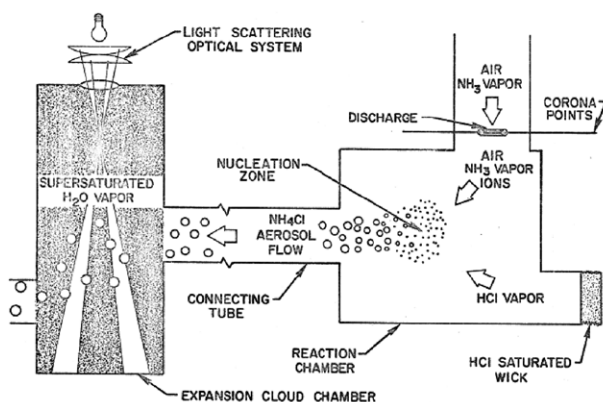

Figure 18. General Electric military photoelectric condensation nuclei counter, "man sniffer."

Note: The man sniffer measures ammonia in ambient air at concentrations >100 ppt. interpolated to connect the ion counts or CN counts with the optical microscope determinations.

Source: US Department of the Army (1971).

Combustion-produced nanoparticles from snorkeling diesel submarines were also the focus of a GE research effort, which led to the design of an airborne automatic photoelectric CN counter based on the Vonnegut (1949) design. This “submarine detector” was manufactured as Model ASR by the GE Defense Electronic Division and extensively used on aircrafts during the 1950s. It is generally considered as the forerunner of the commercial GE counter introduced in 1963 (Skala, 1963).

To the extent that nanoparticles are emitted by numerous sources, including fires, heated plastic materials (macro-molecules), and electric discharges, CN counters have been put to work worldwide as process monitors or early warning detectors. Although CN detectors have not been used for routine air pollution monitoring of nanoparticles, other than for research purposes or as an indicator for highly contaminated air masses, the continuous instruments have been adopted for high-altitude flight—for example, by the US Department of Transportation (DOT) during CIAP in the 1970s (Grobeck, 1975). The measurements in the upper troposphere and lower stratosphere enabled DOT investigators to extend their knowledge of the impact of commercial and military aircraft on particle concentrations aloft. These data were also useful in assessing the importance of aircraft emissions to the inadvertent cloud nucleation at high altitude.

Toward the Present (1980–2010)

Recently, interest in nanoparticles has surged with continuing evidence of their ubiquitous presence in the atmosphere in both urban and highly remote areas. This interest has been stimulated further by evidence that their presence has environmental consequences. These minute particles also have a potential for modifying cloud processes through changes in CCN. Scientists have hypothesized that, through this microscale process, nanoparticles may be a factor in indirect forcing of climate change. Advances in instrumentation in the past 30 years for physicochemical characterization have facilitated the investigation of nanoparticle chemistry (Flagan, 1998; McMurry, 2000b). Measurements still rely heavily on the classical methods of CN counting or mobility analyzers but with greatly improved methods for size segregation and continuous, fast response counting.

Researchers around the world have developed novel experimental and theoretical methods to characterize nanoparticle formation, chemical composition, and behavior. No routine network-monitoring measurements

of nanoparticle number-size distributions, mass concentration, or chemical composition exist. However, observations have shown that these particles universally make up only a small portion of the mass concentration of particulate matter, compared with the larger particle fractions. As noted by Junge (1963) and many others, their number concentration is significantly larger than the fine and coarse fractions, and their chemical composition is distinct from these larger fractions. Recent results from North American sampling, for example, also show a difference by size fraction in the relative amounts of carbon, sulfate, nitrate, and soil dust components. Observations suggest that primary sources of tropospheric nanoparticles derive from combustion processes, especially motor vehicle emissions (Sgro et al., 2003; Zhu et al., 2004). Scientists also have documented the formation of nanoparticles in urban and rural atmospheric conditions favoring homogeneous or ion nucleation processes (e.g., Kulmala, 2004; Woo et al., 2001; Stanier et al., 2004; Watson et al., 2006). The observations suggest that these particles are composed mainly of sulfuric acid or sulfate salts and possibly some organic species.

One of the contemporary motivations for investigating nanoparticles in the atmosphere stems from concerns about environmental effects. Recently, researchers have explored the role of ultrafine or nano-aerosols in promoting adverse human respiratory and cardiovascular health effects upon inhalation (Seaton et al., 1995; Donaldson et al., 1998; Oberdörster et al., 2005; Maynard & Kuempel, 2005). A potentially important mechanism for causation of health problems by nanoparticles is pulmonary inflammation via oxidative stress (Donaldson et al., 1998). A proposed metric for determining the magnitude of the effect is total particulate surface area (Stoeger et al., 2006). Particles in the nano-range have a larger specific surface area (surface area per unit mass) than their larger counterparts, resulting in a greater dose per unit particulate mass.

On a global scale, perhaps the most important formation processes are by homogeneous, heterogeneous, ternary, or ion-induced nucleation. Once formed, nanoparticle growth after nucleation, which can be over 20 nm/hr, can occur as a result of coagulation or physicochemical uptake of low vapor pressure gases (condensation) into the particle (Weber et al., 1997). Most evidence from observations suggests that the high concentrations of nanoparticles near their origins decline rapidly as the particles coagulate or grow to form larger particles, adding to the size fraction 500 to 1,000 nm,

called the accumulation range. A few observations, however, suggest that the nanoparticles may remain stable for hours in conditions that have low concentrations of larger particles. Such growth potential links the presence of nanoparticles to a variety of phenomena, ranging from atmospheric chemical processing to modification of cloud-forming nuclei.

The global baseline conditions for CN distributions have emerged from measurements taken since the mid-1970s. Examples of the observations found in remote regions of the Southern Hemisphere are shown in Figures 19 and 20. Figure 19 displays concentrations observed by John Gras that are likely tied to natural processes. Figure 20 shows a similar long-term data record taken in Antarctica by Hogan and colleagues (1993). Here a similar seasonal cycle is observed, which almost certainly is natural in origin, perhaps linked with sulfate formation from dimethyl sulfide oxidation, the presence of sea animal or microbiota activity, or variations in tropospheric mixing.

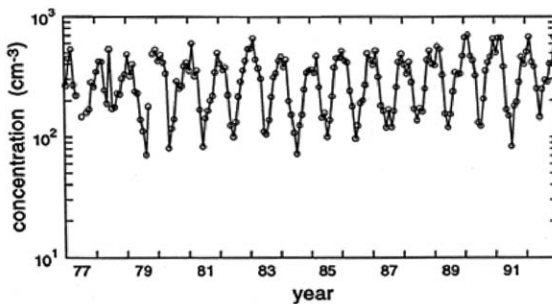

Figure 19. Long-term record of condensation nuclei observed at Aspendale, Australia.

Note: Aspendale is a relatively remote area influenced by both continental and marine air. The record indicates a seasonal condensation nuclei accumulation or production cycle in the Southern Hemisphere. Source: Gras, personal communication (2006).

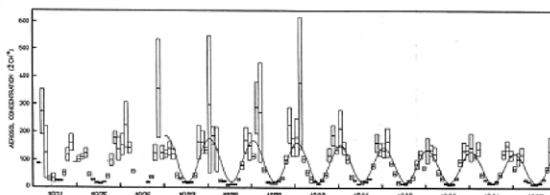

Figure 20. Long-term record of condensation nuclei concentrations observed in Antarctica.

Note: The record shows a seasonal pattern of very low concentrations with maxima in the Austral summer, presumed to be mainly natural-marine in origin. Source: Hogan et al. (1993).

Hogan (1986) also reported latitudinal measurements from summer flights in 1977 to 1980 over the Pacific Ocean between the United States and Antarctica. He reported that, in clear air, average CN concentrations were in the range of 200 to 400 nuclei/cm³ in the upper troposphere, with maxima in the intertropical convergence zone near the equator and in the region of the subtropical jet at 25°S to 30°S. Hogan compared these findings with surface observations along a similar pathway. At the surface, minima of ~200 nuclei/cm³ appear near the South Pole and at the equator, while at ~60°S to 20°S a maximum CN was found to be ~400 nuclei/cm³. These and other results suggest the application of CN distributions as tracers of large-scale atmospheric processes.

An example of apparent post-mid-1970s trends in the ground-level CN compared with CCN concentrations in relatively remote areas can be seen in Figure 21 for the Australian data at the World Meteorological Organization (WMO) site at Cape Grim, Tasmania (Gras, personal communication, 2006). The data reported at this remote site are obtained under conditions of wind direction oriented toward clean air away from continental sources of Australia. The data are believed to be representative of clean air in the global Southern Hemisphere. Unlike the earlier marine sample in Figure 11, these data indicate a systematic increase in CN concentration, and to a lesser extent CN in winter,

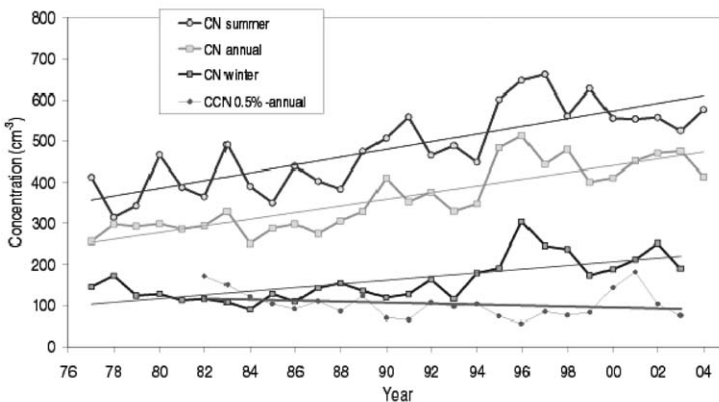

Figure 21. Trends in condensation nuclei and cloud condensation nuclei concentrations (determined at 0.5% water supersaturation) reported from a remote site in the Southern Hemisphere at Cape Grim, Tasmania.

Source: Gras, personal communication (2006).

from 1976 to 2003. In contrast the CCN tend to decrease at this location over the same period. The reason for the CN increase is unclear but presumably represents a trend in “residual” nuclei concentrations throughout the region south of Australia resulting from industrialization and perhaps large-scale vegetation fires that have occurred in Southeast Asia (Hidy, 2009).

In the 1980s, B. Bohdaine collected additional continuous, baseline CN and light-scattering coefficient data for the Northern Hemisphere. These data are available from National Oceanic and Atmospheric Administration internal reports but generally are not accessible in the reviewed literature.

Summary and Conclusions

Although the science of atmospheric nanoparticle aerosols is over a century old, and despite recent progress, much remains to be done. A considerable knowledge gap exists on quantifying the formation processes of nanoparticles as CN and how they grow to sizes that can serve as CCN and affect the earth’s climate and albedo. Knowledge is also lacking on the fraction of these particles that are formed by direct emissions, nucleation of hot vapor upon cooling, or atmospheric formation of gases that undergo nucleation. Nanoparticle physical, chemical, and especially toxicological properties are incompletely understood. Many of the measurements that are needed require instrumentation that is currently under development, with special focus on elucidating the chemical composition of nanoparticles. These techniques are undergoing rapid progress, with on-line aerosol mass spectrometers now capable of characterizing the size-segregated chemical composition of particles in the >5 to 100 nm diameter range.

The characterization of nanoparticles in the atmosphere has generated increased interest in recent times because of new instrumentation for the measurement of their physical and chemical properties. Although this interest has stimulated the generation of a substantial body of new information about atmospheric particles, a large body of historical knowledge also is accessible dating back to the 19th century. Indeed some of the earliest truly scientific interests in atmospheric aerosols derived from observations of the total number of particles in the air, dominated by the nanoparticle range. The observations of Aitken and his many successors, including C. Junge, H. Landsberg, and later A. Hogan, should not be neglected by contemporary scientists in their quest for understanding of the broad and diverse range of aerosols present in the earth’s atmosphere.

Today, with air pollution as a continuing concern and with new instrumentation and methods, the pendulum appears to have swung back to the nano-range for another generation of researchers (Weber et al., 1997; Kulmala, 2004; McMurry et al., 2005).

Acknowledgments

Our thanks to Austin Hogan for a number of comments and suggestions about the CN instruments and atmospheric observations of CN, especially in remote areas. Thanks also to John Gras for permission to use his graphs from Australia. We appreciate the efforts of Daryl Morris in assisting with the preparation of the manuscript.

References

- Aitken, J. (1887/1888). On the number of particles in the atmosphere. *Transactions of the Royal Society of Edinburgh*, 35, 1–19.
- Aitken, J. (1890/1891). On a simple pocket dust counter. *Proceedings of the Royal Society of Edinburgh*, 18, 39–53.
- Aitken, J. (1910). Did the tail of Halley's Comet affect the earth's atmosphere? *Nature*, 84, 228.
- Agarwal, J., & Sem, G. (1980). Continuous flow, single-particle counting condensation nucleus counter. *Journal of Aerosol Science*, 11, 343–357.
- Bradbury, N. E., & Meuron, H. J. (1938). The diurnal variation of atmospheric condensation nuclei. *Terrestrial Magnetism*, 43, 231–240.
- Bricard, J. A., Delattre, P., Madelaine, G., & Pourprix, M. (1976). Detection of ultrafine particles by means of continuous flux condensation nucleus counter. In *Fine particles: Aerosol generation, measurement, sampling, and analysis* (pp. 565–580). New York, NY: Academic Press.
- Chapman, S., & Cowling, T. G. (1960). *The mathematical theory of non-uniform gases*. Cambridge, United Kingdom: Cambridge University Press.
- Coffey, P. E. (1972). *Explosive growth reactions induced by the $\text{NH}_4^+(\text{H}_2\text{O})$ cluster* (Report No. 204). Albany, NY: Atmospheric Science Research Center, State University of New York.

- Coulier, M. (1875). Note sur une nouvelle propriete de l'air. *Journal de Pharmacie et de Chimie*, 4, 165–172.
- Donaldson, K., Li, X. Y., & MacNee, W. (1998). Ultrafine (nanometre) particle mediated lung injury. *Journal of Aerosol Science*, 29, 553–560.
- Ebert, H. (1901). Aspriationsapparat zur Bestimmung des Ionengehaltes der Atmosphere. *Physz. Zeitr.*, 2, 662–664.
- Einstein, A. (1905). On the kinetic molecular theory of thermal movements of particles suspended in a quiescent fluid. *Annalen der Physik*, 17, 549–560.
- Erikson, H. A. (1921). The change of mobility of the positive ions in air with age. *Physical Review*, 2(17), 100–101.
- Flagan, R. C. (1998). History of electrical aerosol measurements. *Aerosol Science and Technology*, 28, 301–380.
- Fletcher, N. (1966). *The physics of rainclouds*. Cambridge, United Kingdom: Cambridge University Press.
- Flyger, A., Heidam, N., Hansen, K., Megaw, W., Walther, E., & Hogan, A. W. (1976). The background level of the summer tropospheric aerosol, sulphur dioxide, and ozone over Greenland and the North Atlantic Ocean. *Journal of Aerosol Science*, 7, 103–140.
- Fuchs, N. A., & Stechkina, I. B. (1962). On the determination of particle size distributions in polydisperse aerosols by diffusion method. *Journal of Applied Physics*, 13, 280–281.
- Gemuend, W. (1907). Die Beurteilung und Intensitaet der Rauch- und Russplage unserer Staedte mittels des Aitkenschen Staubzaehlers. *Gesundheitsing*, 30, 21–27.
- Gemuend, W. (1908). Beitrage zur Kenntnis der gross-staedtischen Luftverunreinigung und des Gross-stadtklimas auf Grund von Untersuchungen mittels des Aitkenschen Staubzaehlers. *Dtsch. Vieteljschr. F. Oeff. Ges. Pfl.*, 40, 401–429.
- Gerdien, H. (1905). Demonstration eines Apparates zur absoluten Messung der elektrischen Leitfahigkeit der Luft. *Phys. Z.*, 6, 800–801.
- Ginner, R., & Hess, V. F. (1937). Studium ueber die Verteilung der Aerosole in der Luft von Innsbruck und Umgebung. *Gerlands Beitrage zur Geophysik*, 50, 22–43.

- Grobecker, A. J. (Ed.). (1975). *The stratosphere perturbed by propulsion effluents* (Monograph 3, DOT-TST-75-53). Washington, DC: Climate Impact Assessment Program, US Department of Transportation.
- Gunn, R. (1964). The secular increase of the world-wide fine particle pollution. *Journal of the Atmospheric Sciences*, 21, 168–181.
- Hess, V. A., & Parkinson, W. D. (1952). *Small ion balance over the ocean* (Contract AF19[122]409). New York, NY: Fordham University.
- Hidy, G. M. (1972). The dynamics of aerosols in the lower troposphere. In T. Mercer, P. Morrow, & W. Stober (Eds.), *Assessment of airborne particles: Fundamentals, applications, and implications to inhalation toxicology* (pp. 81–115). Springfield, IL: Charles C. Thomas.
- Hidy, G. M. (2009). Worldwide aerosol chemistry: From hemispheric distributions to megacity sources. *Journal of the Air and Waste Management Association*, 59, 770–789.
- Hidy, G. M., Bleck, R., Blifford, I., Jr., Brown, P., Langer, G., Lodge, J. P., Jr., Rosinski, J., & Shedlovsky, J. (1970). *Observations of aerosols over northeastern Colorado* (NCAR Report TN-49). Boulder, CO: National Center for Atmospheric Research.
- Hidy, G. M., & Brock, J. R. (1970). *Dynamics of aerocolloidal systems*. New York, NY: Pergamon Press.
- Hogan, A. W. (1966). Some characteristics of Aitken nuclei concentrations. *Journal de Recherche Atmospherique II*, 2-3, 87–93.
- Hogan, A. W. (1986). Aerosol exchange in the remote troposphere. *Tellus*, 36B, 197–213.
- Hogan, A. W., Aymer, A. L., Bishop, J. M., Harlow, B. W., Klepper, J. C., & Lupo, G. (1967). Aitken nuclei observations over the North Atlantic Ocean. *Journal of Applied Meteorology*, 6, 726–728.
- Hogan, A. W., & Mohnen, V. A. (1979). On the global distribution of aerosols. *Science*, 205, 1373–1375.
- Hogan, A. W., Mohnen, V. A., & Schaefer, V. J. (1973). Comments on oceanic aerosol levels deduced from measurements of the electrical conductivity of the atmosphere. *Journal of the Atmospheric Sciences*, 30, 1455–1460.

- Hogan, A. W., Samson, J. A., & Barnard, S. C. (1993). Amundsen-Scott South Pole Station monthly mean CN concentration. *Antarctic Research Series*, 61, 175–199.
- Israel, H., & Schulz, L. (1932). Über die Grossenverteilung der Atmosphärischen Ionen. *Meteorol. Z.*, 12, 456–462.
- Junge, C. (1935). Übersättigungsmessungen an atmosphärischen Kondensationskernen (Supersaturation measurements on atmospheric condensation nuclei). *Gerlands Beiträge zur Geophysik*, 46, 108–129.
- Junge, C. (1952). Gesetzmässigkeiten in der Grossenverteilung atmosphärischer Aerosol über dem Kontinent. *Ber. Deut. Wetterd. US-Zone*, 35, 261–277.
- Junge, C. (1955). The size distribution and aging of natural aerosols as determined from electrical and optical data in the atmosphere. *Journal of Meteorology*, 12, 13–25.
- Junge, C. (1961). Vertical profiles of condensation nuclei in the stratosphere. *Journal of Meteorology*, 18, 501–509.
- Junge, C. E. (1963). *Air chemistry and radioactivity*. New York, NY: Academic Press.
- Junge, C. E., Chagnon, C. W., & Manson, J. E. (1961). A world-wide stratospheric aerosol layer. *Science*, 133, 1478–1479.
- Knott, C. (Ed.). (1923). *Collected scientific papers of John Aitken*. Cambridge, United Kingdom: Cambridge University Press.
- Knutson, E. (1999). History of diffusion batteries in aerosol measurements. *Aerosol Science and Technology*, 31, 83–128.
- Köhler, H. (1921). Zur Kondensation des Wasserdampfes in der Atmosphäre. *Geofys. Pub.*, 2(1 and 6).
- Köhler, H. (1926). Zur Thermodynamik der Kondensation an hygroskopischen Kernen und Bemerkungen über das Zusammenfliessen der Tropfen. *Meddel. Met.-hydr. Anstalt-Stockholm*, 3(8).
- Kulmala, M. (2004). Formation and growth rates of ultrafine atmospheric particles: A review of observations. *Journal of Aerosol Science*, 35, 143–176.
- Landsberg, H. (1934). Observations of condensation nuclei in the atmosphere. *Monthly Weather Review*, 62, 442–445.

- Landsberg, H. (1938). Atmospheric condensation nuclei. *Ergebnisse. Kosm. Phys.*, 48, 410.
- Langevin, P. (1905). Sur les ions de l'atmosphère. *Compt. Rend.*, 140, 232–234.
- Langsdorf, A. (1936). A continuously sensitive cloud chamber. *Physical Review*, 49, 422.
- Liu, B. Y. H., Pui, D., Hogan, A., & Rich, T. (1975). Calibration of the Pollak counter with monodisperse aerosol. *Journal of Applied Meteorology*, 14, 46–51.
- Mason, B. J. (1957a). *The physics of clouds*. London, United Kingdom: Clarendon Press.
- Mason, B. J. (1957b). The nuclei of atmospheric condensation. *Geofisica e Pura Applicata*, 36, 9–20.
- Maynard, A. D., & Kuempel, E. D. (2005). Airborne nanostructured particles and occupational health. *Journal of Nanoparticle Research*, 7, 587–614.
- McClelland, J. A. (1898). On the conductivity of the hot gases from flames. *Phil. Mag.*, 46, 29–42.
- McClelland, J. A., & Kennedy, H. (1912). The large ions in the atmosphere. *Proceedings of the Royal Irish Academy*, 30, 72–91.
- McMurry, P. (2000a). A review of atmospheric aerosol measurements. *Atmospheric Environment*, 34, 1959–2000.
- McMurry, P. (2000b). History of condensation nuclei counters. *Aerosol Science and Technology*, 33, 297–322.
- McMurry, P. H., Fink, M., Sakurai, H., Stolzenburg, M. R., Mauldin, III, R. L., Smith, J., . . . Voisin, D. (2005). A criterion for new particle formation in the sulfur-rich Atlanta atmosphere. *Journal of Geophysical Research*, 110. doi:10.1029/2005JD005901
- Metnieks, A. L., & Pollak, L. W. (1959). *Instructions for use of photo-electric condensation nucleus counters*. Dublin, Ireland: School of Cosmic Physics, Dublin Institute for Advanced Studies.
- Millikan, R. A. (1917). *The electron*. Chicago, IL: University of Chicago Press.

- Mohnen, V. A., & Lodge, J. P., Jr. (1969). General review and survey of gas-to-particle conversions (GPC). In J. Podzimek (Ed.), *Proceedings of the 7th International Conference on Condensation and Ice Nuclei* (pp. 69–91). Prague, Czech Republic: Academia Publishing House of the Czechoslovak Academy of Sciences.
- Nolan, J. J., Boylan, R. K., & deSachy, G. P. (1925). The equilibrium of ions in the atmosphere. *Proceedings of the Royal Irish Academy*, *A37*, 1–12.
- Nolan, J. J., & Guerrini, V. H. (1935). The diffusion coefficient and velocities of fall in air of atmospheric condensation nuclei. *Proceedings of the Royal Irish Academy*, *A43*, 5–24.
- Nolan, J. J., & Nolan, P. J. (1938). Diffusion and fall of atmospheric condensation nuclei. *Proceedings of the Royal Irish Academy*, *A45*, 47–63.
- Nolan, P. J., & Pollak, L. W. (1946). The calibration of a photoelectric nucleus counter. *Proceedings of the Royal Irish Academy*, *A51*, 9–31.
- Oberdörster, G., Oberdörster, E., & Oberdörster, J. (2005). Nanotoxicology: An emerging discipline evolving from studies of ultrafine particles. *Environmental Health Perspectives*, *113*, 823–839.
- Pedder, M. (1971). The measurement of size and diffusion characteristics of aerosols with particle sizes less than $0.01\mu\text{m}$ using the Pollak condensation nuclei counter. *Journal of Physics D: Applied Physics*, *4*, 531–538.
- Podzimek, J. (1989). John Aitken's contribution to atmospheric and aerosol sciences: One hundred years of condensation nuclei counting. *Bulletin of the American Meteorological Society*, *70*, 1538–1545.
- Pollak, L., & Daly, J. (1958). An improved model of the condensation nucleus counter with stereo-photomicrographic recording. *Geophysica Pura e Applicata*, *41*, 211–216.
- Pollak, L. W. (1952). A condensation nuclei counter with photographic recording. *Geophysica Pura e Applicata*, *22*, 75–83.
- Pollak, L. W., & Metnieks, A. L. (1957). Photoelectric condensation nucleus counters of high precision for measuring low and very low concentrations of nuclei. *Geophysica Pura e Applicata*, *37*, 174–182.

- Pollak, L. W., & Metnieks, A. L. (1960). *Intrinsic calibration of the photo electric nucleus counter model 1957 with convergent light beam* (Technical Note 9, Contract AF61[052]26). Dublin, Ireland: School of Cosmic Physics, Dublin Institute for Advanced Study.
- Pollak, L. W., & Metnieks, A. L. (1963). A small portable photo-electric condensation nucleus counter. *Geofisica Pura E Applicata*, 55, 137–150.
- Pollak, L. W., & O'Connor, T. C. (1955). A photoelectric nucleus counter of high precision. *Geofisica Pura e Applicata*, 32, 139–146.
- Pollock, J. A. (1909). Les ions d'ans l'atmosphère. *Le Radium*, 6, 129–135.
- Pollock, J. A. (1915). The nature of the large ions in the air. *Phil. Mag.*, 29, 514–526.
- Reiter, J. R. (1985). *Fields, currents and aerosols in the lower atmosphere*. New Delhi, India: Amerind.
- Rich, T. A. (1955). A photoelectric nuclear counter with size discrimination. *Geofisica Pura e Applicata*, 31, 60–65.
- Rich, T. A. (1961). A continuous recorder for condensation nuclei. *Geofisica Pura e Applicata*, 50, 46–52.
- Rich, T. A. (1966). Apparatus and method for measuring the size of aerosol. *Journal de Recherche Atmospherique II*, 2–3, 79–86.
- Rosen, J. M., Pinnick, R. G., & Hall, R. (1974). Recent measurements of condensation nuclei in the stratosphere. In A. J. Broderick & T. M. Hart (Eds.), *Proceedings of the 3rd Conference on the Climatic Impact Assessment Program* (DOT-TSC-OST-74-15, pp. 298–302). Washington, DC: U.S. Department of Transportation.
- Schmidt, W. (1918). Messungen des Staubkerngehaltes der Luft am Rande einer Gross-Stadt. *Meteorol Z*, 35, 281–285.
- Scholz, J. (1932). Vereinfachter Bau eines Kernzaehlers. *Meteorol Z*, 49, 381–388.
- Seaton, A., MacNee, W., Donaldson, K., & Godden, D. (1995). Particulate air pollution and acute health effects. *Lancet*, 345, 176–178.
- Sgro, L. A., Basile, G., Barone, A. C., D'Anna, A., Minutolo, P., Borghese, A., & D'Alessio, A. (2003). Detection of combustion formed nanoparticles. *Chemosphere*, 51, 1079–1090.

- Shiratori, K. (1934). Ionic balance in air and nuclei over ocean. *Mem. Faculty Sci. and Agr. Taihoku Imp. Univ.*, 10, 175–201.
- Sinclair, D., & Hoopes, G. S. (1975). A continuous flow condensation nucleus counter. *Journal of Aerosol Science*, 6, 1–7.
- Skala, G. F. (1963). A new instrument for the continuous measurement of condensation nuclei. *Analytical Chemistry*, 35, 702–706.
- Stanier, C. O., Khlystov, A. Y., & Pandis, S. N. (2004). Ambient aerosol size distributions and number concentrations measured during the Pittsburgh Air Quality Study (PAWS). *Atmospheric Environment*, 38, 3275–3284.
- Stoeger, T., Reinhard, C., Takenaka, S., Schroepel, A., Karg, E., Ritter, B., . . . Schulz, H. (2006). Instillation of six different ultrafine carbon particles indicates a surface area threshold dose for acute lung inflammation in mice. *Environmental Health Perspectives*, 114(3), 328–333.
- Sutugin, A. G., & Fuchs, N. A. (1965). Coagulation rate of highly dispersed aerosols. *Journal of Colloid Science*, 20, 492–500.
- Tetens, O. (1911). Aerologische Beobachtungen waehrend des am 18./19. Mai 1910 erwarteten Durchganges der Erde durch den Schweif des Halley'schen Kometen. *Erg.d.Arb.d.Kgl.Preuss, Aeronaut. Obs. Lindenberg i.J.*, 6, 219–255.
- Thomas, J. (1955). The diffusion battery method for aerosol particle size determination. *Journal of Colloid Science*, 11, 107–117.
- Torreson, O. W., & Wait, G. R. (1934). Measurement of total nuclei, of uncharged nuclei, and of large ions in the free atmosphere at Washington, D.C. *Terrest. Mag. Atmos. Elect.*, 39, 47–64.
- Twomey, S., & Severynse, G. (1964). Size distribution of natural aerosols below 0.1 microns. *Journal of the Atmospheric Sciences*, 21, 558–564.
- US Department of the Army. (1971). *Detector, concealed personnel*. Aircraft mounted, XM3 (Technical Manual TM 3-6665-267-12). Washington, DC: Author.
- Vonnegut, B. (1949). A continuous recording condensation nuclei meter. In *Proceedings of the 1st National Air Pollution Symposium* (pp. 36–44). Los Angeles, CA.

- Vonnegut, B. (1954). *US Patent No. 2,684,009*. Washington, DC: US Patent and Trademark Office.
- Watson, J. G., Chow, J. C., Park, K., & Lowenthal, D. (2006). Nanoparticle and ultrafine particle events at the Fresno supersite. *Journal of the Air and Waste Management Association*, 56, 417–430.
- Weber, R. J., Marti, J. J., McMurry, P. H., Eisele, F. I., Tanner, D. J., & Jefferson, A. (1997). Measurements of new particle formation and ultrafine particle growth rates at a clean continental site. *Journal of Geophysical Research*, 102, 4375–4385.
- Weickmann, H. (1955). Recent measurements of the vertical distribution of Aitken nuclei. In H. Weickman & W. Smith (Eds.), *Artificial stimulation of rain. Proceedings of the 1st Conference on Phys. Clouds and Precipitation* (pp. 81–88). New York, NY: Pergamon Press.
- Went, F. W. (1960). Organic matter in the atmosphere, and its possible relation to petroleum formation. In *Proceedings of the National Academy of Sciences*, 46, 212–221.
- Whitby, K. T., & Clark, W. E. (1966). Electrical aerosol particle counting and size distribution measuring system. *Tellus*, 18, 573–586.
- Whitby, K. T., Husar, R. B., & Liu, B. Y. H. (1972). The aerosol size distribution of Los Angeles smog. *Journal of Colloid and Interface Science*, 39, 177–204.
- Whitby, K. T., & Sverdrup, G. (1980). California aerosols: Their physical and chemical characteristics. In G. M. Hidy, P. K. Mueller, D. Grosjean, B. R. Appel, & J. J. Wesolowski (Eds.), *The character and origins of smog aerosols* (pp. 477–525). New York, NY: Wiley Interscience.
- Wigand, A. (1919). Die vertikale Verteilung der Kondensaationskerne in der freien Atmosphaere. *Ann. Physik.*, 59, 689–742.
- Wigand, A. (1929). Aerophysikalische Forschung mit dem Flugzeug. *Naturwissenschaften*, 7, 487–491.
- Woo, K. S., Chen, D. R., Pui, D. Y. H., & McMurry, P. H. (2001). Measurement of Atlanta aerosol size distributions: Observations of ultrafine particle events. *Aerosol Science and Technology*, 34, 75–87.
- Zeleny, J. (1900). The velocity of ions produced in gases by Röntgen rays. *Philosophical Transactions of the Royal Society of London*, A195, 193–234.

Zhu, Y., Hinds, W. C., Shen, S., & Sioutas, C. (2004). Seasonal trends of concentration and size distribution of ultrafine particles near major highways in Los Angeles. *Aerosol Science and Technology*, 38(S1), 5–13.

History of the Flow Diffusion Chamber Development

Michael Anisimov

Introduction

The flow diffusion chamber (FDC) combines the ability of a static diffusion chamber to define the nucleation conditions with the simplicity of flow systems for measuring aerosol concentration and size distribution. It decouples aerosol generation volume and aerosol detecting zones, which is useful for growing small critical clusters into optically detectable particles in residual supersaturated vapor. The FDC's basic scheme is similar to that of the uniform size particle generator designed by Sinclair and La-Mer (1949). Anisimov and colleagues (1978a, 1978b) created the original FDC prototype for vapor-homogeneous nucleation rate measurements. The FDC has continued to develop since that time, and several research groups in Europe and North America have reproduced the FDC. The strongest reason for developing similar systems to measure nucleation rates is that data inconsistencies are observed between different devices.

Short Overview of the Experimental Techniques for Nucleation Studies

Presumably, the first nucleation experiments were associated with the liquid and crystal supercooling measurements that Daniel Gabriel Fahrenheit conducted (Ostwald, 1896–1903). Then, as Volmer (1939) notes, in the second half of the nineteenth century, nucleation science introduced gas-saturated solutions, characterized by bubble nucleation and the critical embryos of the new phase formation. Aitken (1888) provided the first research on vapor nucleation. He used adiabatic expansion of water vapor in air. Allen and Kassner (1969) suggested a recompression cycle to grow the generated clusters to optically detectable sizes. The two-piston expansion chamber later realized this cycle (Strey et al., 1986). At the end of the 1930s, Langsdorf (1939) created the static diffusion chamber. It consisted of two wet plates under different

temperatures. The vapor diffusion and temperature gradient provided the vapor supersaturation, thereby causing nucleation to occur under appropriate conditions. The Russian scientist Amelin (1948) introduced a system in which vapor-gas streams with different temperatures were joined in the turbulent regime.

At the end of the 1980s, Anisimov and colleagues (see, e.g., Anisimov et al., 1978a, 1978b; Anisimov & Cherevko, 1985) created the first prototype of the laminar flow diffusion chamber (LFDC) as an instrument for measuring vapor homogeneous nucleation rates. The quality of experimental research increased substantially in the 1980s. Peters & Paikert (1989) developed the shock tube as an expansion technique that allowed the high-quality nucleation rate measurements. A shock tube is a tube containing a diaphragm that initially forms two chambers, one of which has a higher pressure than the other. When the diaphragm ruptures, an adiabatic expansion occurs. With expansion and adiabatic cooling, the vapor-gas mixture from the high-pressure section forms a supersaturated vapor with subsequent nucleation. A shock tube (Peters & Paikert, 1989) and supersonic jets (Kim et al., 2004) have demonstrated the highest measured nucleation rates, in the range of 10^{11} to 10^{12} $\text{cm}^{-3}\text{s}^{-1}$. Unfortunately, agreement between experimentally measured vapor nucleation rates and current theoretical predictions exists only for a limited number of systems. Anisimov and colleagues (2009) provide a detailed review of the experimental techniques used for supersaturated vapor nucleation rate measurements. This chapter presents a short history of the FDC design.

Flow Diffusion Chamber: Method and Results

The FDC scheme involves using hot laminar vapor-gas flowing within colder boundaries. The chamber is similar to, for example, the laminar part of the apparatus for particle growth in the aerosol generator developed by Sinclair and La-Mer (1949), which Figure 1 presents. The laminar vapor-gas flows out of the vapor superheater (Figure 1) to grow heterogeneous seeds that can obtain uniform-size particles.

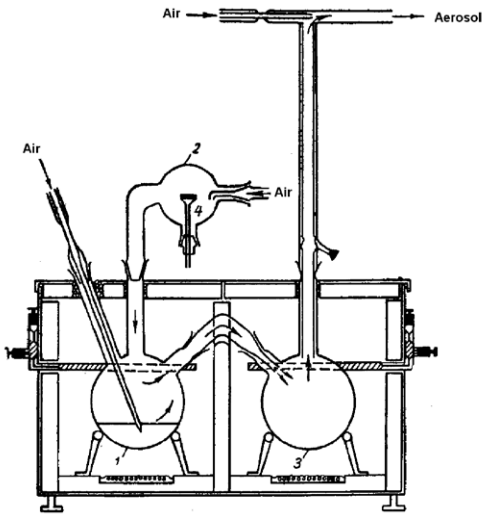

Figure 1. Sinclair and La-Mer's (1949) generator scheme for producing monodispersed particles. Systems for vapor and heterogeneous seeds generation are numbered as 1, 2, and 4; the vapor superheater is number 3.

Flow Diffusion Chamber Scheme

Several articles devoted to the first versions of the FDC were published by Anisimov and colleagues in scientific journals (e.g., Anisimov et al., 1978a, 1978b). Figure 2 shows one of the first versions of the aerosol generator (Anisimov & Cherevko, 1985). This aerosol generator is an open system that operates under atmospheric pressure. Gas pressure from a high-pressure cylinder is reduced to appropriate pressure conditions. A filtered carrier gas passes through a vapor saturator, in which the substance under investigation saturates the gas. The hot vapor-gas flow then enters a cylindrical cooler. Coaxial cooled gas surrounds the hot vapor-gas in the cooler/condenser. The laminar vapor-gas flow then becomes supersaturated, and nucleation occurs in the condenser.

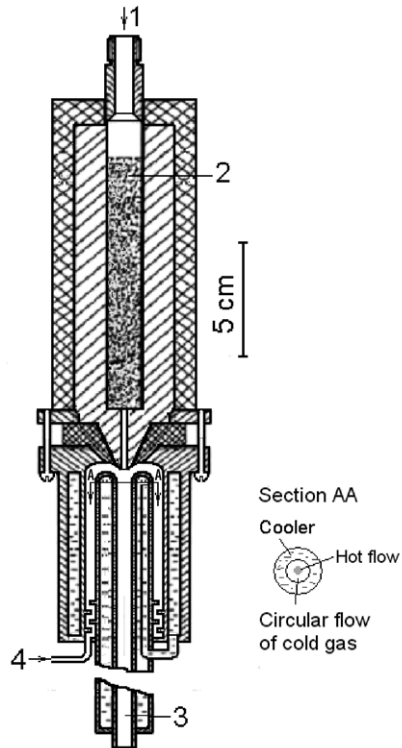

Figure 2. This scheme shows the first version of Anisimov and colleagues' (1978a) aerosol generator. The filtered carrier gas is 1; the vapor saturator is 2; the cooler/condenser is 3; the axial rung-shape co-flow system for cooled gas is 4. A laminar vapor-gas flow becomes supersaturated, and nucleation occurs in the condenser.

Figure 3 shows the current FDC scheme (Anisimov & Hopke, 2001). A filtered carrier gas passes through a flow controller and, in the saturator, becomes saturated with the substance under investigation. The FDC uses a flow laminator to obtain a fully developed laminar vapor-gas flow. That procedure makes it possible to define the boundary conditions of the initial vapor-gas flow velocity distribution for input to the stationary heat-mass transfer problem. Nucleation occurs in the condenser. An aerosol counter measures aerosol concentration and particle size distribution; the counter is placed in front of the pressure controller to avoid the nucleation artifacts in the controller caused by pressure drop. The data acquisition unit collects all experimental parameters. The current FDC measures vapor nucleation rates at total pressures of 0.03 to 0.30 MPa. Several research teams (e.g., Anisimov et al., 1993, 1994; Wilck et al., 1998) have constructed and tested the LFDC at Helsinki University, Finland; Clarkson University, Pottsdam, New York (Anisimova et al., 2001); the Institute of Chemical Process Fundamental, Czech Republic (Brus et al., 2005); and other institutions.

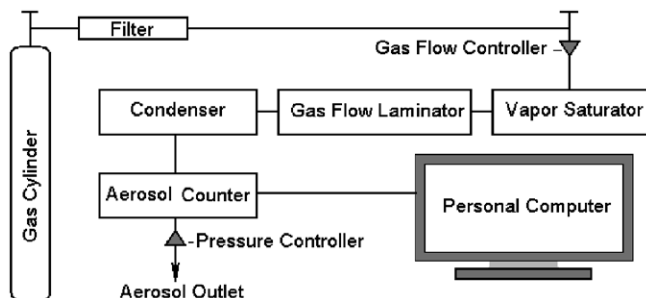

Figure 3. Anisimov and Hopke's (2001) block-scheme for the flow diffusion chamber; still in current use.

Algorithms for the Nucleation Rate Measurements

Anisimov and colleagues (1980) suggest an algorithm for estimating the average nucleation rates in FDC. That algorithm assumes an estimation of the nucleation zone and a residence time within a nucleation zone for a unit volume of a supersaturated vapor. The ratio of experimental aerosol concentration over the aerosol residence time gives the average nucleation rate. The maximum value of the nucleation rate in the FDC is currently estimated using an algorithm described by Wagner and Anisimov (1993).

One can measure the maximum empirical value of nucleation rate, J_{max} , in diffusion chambers using an obvious relationship $J_{theor} / N_{theor} = J_{max} / N_{exp}$, where J_{theor} is maximum theoretical nucleation rate; N_{theor} and N_{exp} are the theoretical and experimental FDC particle concentrations, respectively.

Flow Diffusion Chamber Data Re-evaluation

Evaluating the experimental homogeneous nucleation rates data from LFDC experiments requires a computation of the nucleation conditions. Mitrakos and colleagues (2008) studied the influence of the computational methodology used on the derived nucleation rate curves. These authors recalculated FDC experimental data published by Brus and colleagues (2005) by using two different computational methods for measuring 1-butanol–helium nucleation rates. FDC data evaluations commonly use the first method, which is based on single fluid heat and vapor transport in the carrier gas, ignoring aerosol generation. The second method is more comprehensive and is based on multidimensional computational fluid-particle dynamics. These two methods produced nearly the same results. This finding corroborates the usual approach of neglecting aerosol generation in the mass transfer problem solution when evaluating FDC experimental data.

Herrmann and colleagues (2006) used the computational fluid dynamics software FLUENT in combination with the fine particle model (FPM) for aerosol dynamics calculations to verify experimental data obtained by Hyvärinen and colleagues (2006). The calculated results for the nucleation conditions were practically identical to those computed by Hyvärinen and colleagues (2006). Herrmann and colleagues (2009) used this computer model to estimate the effect of total pressure on homogeneous nucleation rates of *n*-butanol in helium, *n*-pentanol in helium, and argon using a LFDC.

Flow Diffusion Chamber Use

Anisimov and Cherevko (1985), in the first experiments, used a nephelometer to measure aerosol concentration in the FDC. A two-coordinate recorder documented variations in aerosol concentration (y-axis in log-scale) versus the saturation temperature (x-axis). That case was presented as the isothermal nucleation rate. A nucleation temperature was varied at constant partial vapor pressure to obtain the isobaric vapor nucleation rates. Figure 4 shows the first examples of isobaric nucleation rate data. As Anisimov and Cherevko (1982, 1985) show, this type of experimental data can help to determine the enthalpy and/or entropy of critical embryo formation.

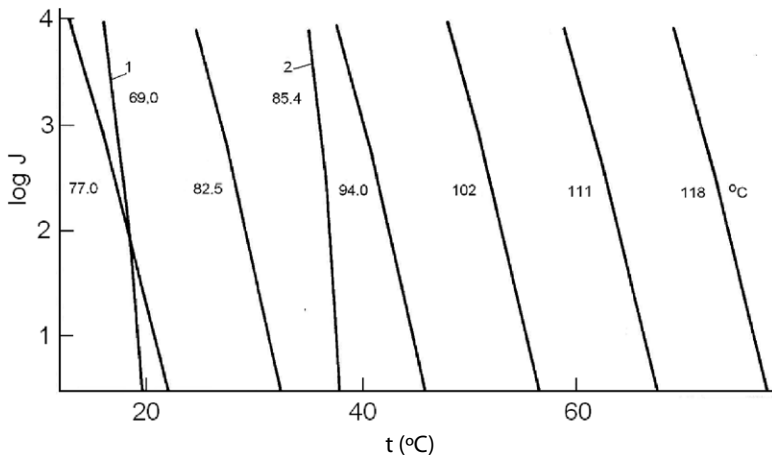

Figure 4. Experimental isobaric nucleation rate, J , of glycerin (1, 2) and dibutyl phthalate on the nucleation temperature, t . The temperatures of vapor at equilibrium are presented near each curve.

Brock and colleagues designed and described a laminar coaxial flow system to study single-component (Brock et al., 1986) and multicomponent (Brock et al., 1988) vapor nucleation. These authors compared the experimentally obtained aerosol concentrations with classical nucleation theory predictions and the theoretical results for binary nucleation that Wilemski (1975) describes. In the late 1980s, only four groups measured the isothermal nucleation rates for two vapors in gas media systems within a range of 4 or more orders of magnitude (Anisimov et al., 1987; Brock et al., 1988; Strey & Wagner, 1988 [expansion chamber]; Okuyama et al., 1988 [turbulent flow]). At that time, other researchers measured critical vapor supersaturations or nucleation rates within a range of only 2 orders of magnitude for two vapors in a gas media systems (e.g., Mirabel & Clavelin, 1978; Kulmala et al., 1988).

Nguyen and colleagues (1987) studied homogeneous and heterogeneous nucleation of a single vapor using a laminar flow aerosol generator. Kodenev and colleagues (1987) experimented with applying the Thomson equation to small clusters using FDC and the “nucleation theorem” (Kashchiev, 1982; Oxtoby & Kashchiev, 1994; see also Anisimov et al. 1978b, 1980, 1987; Anisimov & Cherevko, 1982, 1985).

Data Inconsistencies

Anisimov and colleagues (1993, 1994) compared homogeneous nucleation results of n-hexanol with data obtained by Strey and colleagues (1986) (Figure 5). The expansion chamber data are 4 orders of magnitude higher than the FDC nucleation rate results. However, slopes for the isotherms obtained with different experimental systems are nearly the same. In the same fashion, recent data obtained by Brus and colleagues (2005) illustrate the inconsistencies between the static diffusion chamber and FDC data; the FDC values are higher than the static diffusion chamber results by 3.5 orders of magnitude (Figure 6). These two examples illustrate the internal inconsistency of experimental data from different experimental sets because those experimental measurements have uncontrollable variations of at least one physical parameter.

One can better understand the nature of the data discrepancy when one recalls that Anisimov and colleagues (1998a) designed the nucleation rate surfaces. Considering vapor-gas as a binary system in terms of nucleation helps one to see how different experimental systems can obtain different

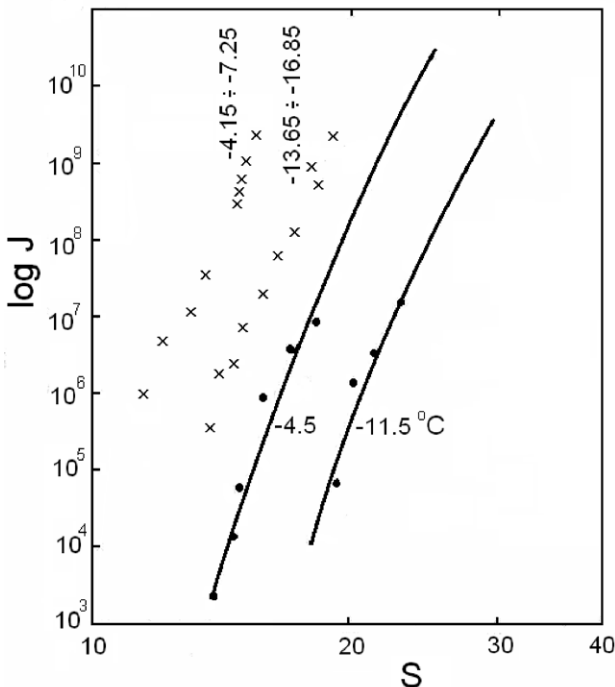

Figure 5. Comparison of the n-hexanol experimental nucleation rate, J , versus vapor supersaturation ratio, S , from the two-piston expansion chamber (crosses) by Strey and colleagues (1986) and the flow diffusion chamber (dots) by Anisimov and colleagues (1994).

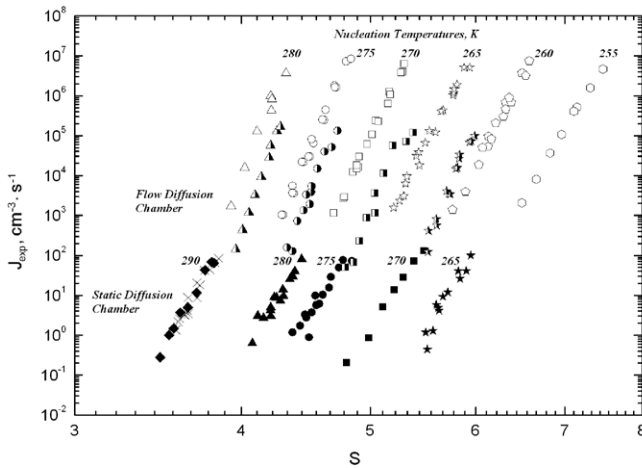

Figure 6. Recent data by Brus and colleagues (2005) illustrate the inconsistent results obtained by the static diffusion chamber and the laminar flow diffusion chamber (LFDC), which are caused by the different experimental trajectories in the space of nucleation conditions (Anisimov et al., 2009). Denotation J_{exp} indicates the experimental nucleation rates as a function of saturation ratio, S , for 1-butanol. Filled symbols: from left to right, the static diffusion chamber at temperatures of 290, 280, 275, 270, and 265 °K. Half-filled symbols: from left to right, new LFDC at temperatures of 280, 275, 270, and 265 °K. Open symbols: Lihavainen and Viisanen (1998a, 1998b) at temperatures of 280–255 °K at 5 °K intervals from left to right. Crosses: the static diffusion chamber at temperature of 290 °K and at 120 kPa pressure (Brus et al., 2005).

trajectories of the experimental conditions and associated nucleation rates on the nucleation surface. Currently, gas is treated, in most cases, as an inert medium that absorbs the heat from the phase transition; however, experimental and theoretical evidence exists that vapor-gas should be considered as a binary system. That different experimental systems have inconsistent trajectories on the nucleation rate surface, representing vapor-gas nucleation as the nucleation of a binary system, is quite plausible.

Empirical Gas Pressure Effect

During the past two decades, several research groups have performed intensive research on the effects of pressure and the type of carrier gas on homogeneous nucleation. This research is part of an effort to obtain better

experimental data for probing vapor to condensed phase nucleation. Using the FDC has produced nontrivial results. Anisimov and colleagues (1998b), for example, experimentally detected a nucleation rate surface singularity that resulted from phase transition in critical embryos formed from both gas and vapor molecules. Anisimov and colleagues (1998b; 2000a) document instances in which the phase transitions in the embryo of the new phase are used as markers of a gas-pressure effect to show that the gas molecules are incorporated into the condensed matter. Anisimov and Hopke (2001) found multichannel *n*-pentanol–sulfur hexafluoride nucleation. In that case, the Gibbs free energy surface has several saddle points for the formation of binary system embryos (each saddle point is associated with a nucleation channel; for details, see Anisimov & Hopke, 2001). Several studies (e.g., Anisimova et al., 2001; Anisimov et al., 1998b) have shown that a high-pressure flow diffusion chamber needs to be designed for the profound research of multichannel nucleation. While a new experimental system is in development, researchers have used an existing FDC to study nucleation systems. Using the FDC, researchers have shown that the carrier gas and multiphase phenomena have effects that need to be explored further.

Nucleation Rate Surface Singularity

Figure 7 provides an example of experimental data that shows the gap in nucleation rate. The gap is initiated by the phase change in critical embryos generated by a supersaturated vapor-gas system (Anisimov et al., 1998b). A conceptual problem in vapor-liquid nucleation is that it is treated as a single-component problem. In general, the carrier gas–vapor nucleation should be considered as a binary system, as Anisimov and colleagues (1998b, 2000a, 2000b) have proved.

Another possible avenue for nucleation experiments opens when a phase change in the critical embryo is probable. Phase change means that the generation of other phase state embryos statistically prevails over the initially prevailing embryo phase state. We have not yet mentioned the phase transition in the single cluster. Apparently, when critical clusters grow, the initial phase state of the critical embryo can exist for a longer time relative to the nucleation and embryo growth time interval. Anisimova and colleagues (2001) obtained that result using the example of glycerine vapor nucleation and condensation. These researchers found a bimodal aerosol particle size distribution that was initiated by two different embryo phase states. The

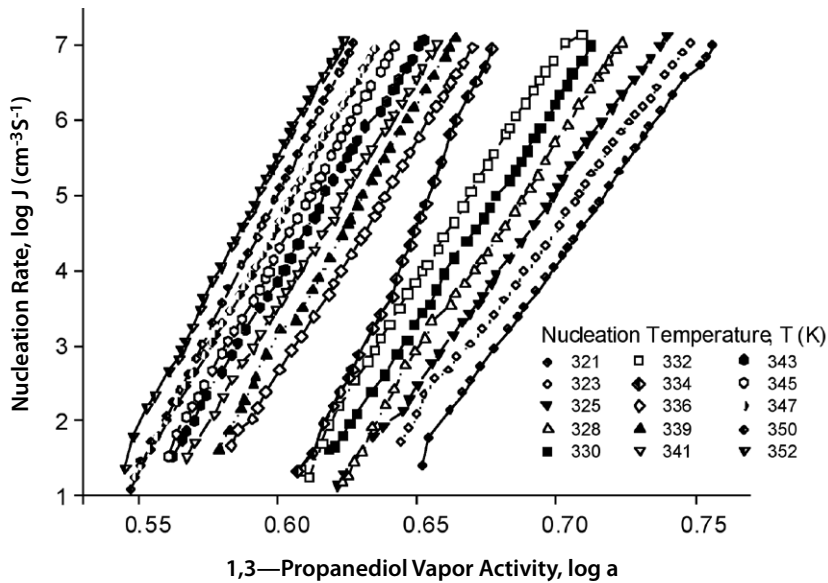

Figure 7. Nucleation rates for the 1,3-propanediol–sulphur hexafluoride system at a total pressure of 0.3 MPa. The gap in nucleation rate is associated with the phase state change in the condensate critical embryos of the binary system (Anisimov et al., 2000c).

phase transitions in the growing clusters acted to smooth the clearly detected bimodal size distribution of glycerine particles in those measurements (Anisimova et al., 2001).

The random errors inherent in any experimental data pose a major problem in detecting nucleation rate surface singularities (Figure 7). This problem exists even in highly accurate experimental results such as those produced by Strey and colleagues (1995); in that study, the results missed a nucleation rate surface singularity. Anisimov and colleagues (2000b) suggest using the mathematical condition of the continuity and monotony for FDC data analysis to find the anomalies of the nucleation rate surfaces.

Anisimova and colleagues (2001) examined nucleation in the vicinity of the glycerine triple point using FDC and applied the particle size measurements to observe two condensed phases generated by two independent nucleation channels, representing two nucleation rate surfaces. The experimental scheme that Anisimova and colleagues (2001) propose uses size distribution measurements and can be an effective tool for measuring nucleation rates independently for each nucleation channel.

Vapor Nucleation Rate Standard

In order to test the accuracy of an experimental setup, one must have a standard system that can be measured over a range of typical nucleation conditions. The Nucleation Experiments—State of the Art and Future Development workshop, held in 1995 in Prague—proposed using the *n*-pentanol–helium system for such measurements. Anisimov and colleagues (2000c) presented the results of the available experimental results from several research groups. The data were parameterized using classical nucleation theory with Tolmen’s correction for surface tension. The fitting parameter, δ , was equal to 0.4 angstroms. The resulting approximation can be presented as

$$J_{fit} = \frac{V}{(kT)^2} \sqrt{\frac{2\sigma}{\pi \cdot M}} \cdot P^2 \cdot \exp\left(-\frac{16\pi \cdot \sigma^3 \cdot V^2}{3(kT)^3 \cdot (\ln S)^2} \cdot \left(1 - \frac{2\beta}{\ln S} \cdot \frac{P_{tot} - P_{atm}}{P_{atm}}\right)\right), \quad (1)$$

where J_{fit} is vapor nucleation rate, P_{tot} is total pressure, V is the volume per molecule in the liquid phase, and S is the vapor supersaturation ratio. The equation for surface tension, σ , is applied as $\sigma = \sigma_0 / (1 + 2\delta / r^*)$, where σ_0 is the surface tension for a bulk liquid, and r^* is the radius of critical embryos. The fitting parameter, β , is expressed as $\beta = 1.486T_r^3$, where $T_r = T / T_c$ is the reduced nucleation temperature; T_c is the critical temperature of *n*-pentanol, which is equal to 588.15 K. The critical embryo radius is calculated as $r^* = 2\sigma M / (RT \ln S)$, where M is the molecular weight of *n*-pentanol and R is the universal gas constant. The term for the pressure effect was taken into the linear approximation as $(2\beta / \ln S)(P_{tot} - P_{atm}) / P_{atm}$ for experimental data obtained by van Remoortere and colleagues (1996) and Anisimov and colleagues (2000c). Recently, Hyvärinen and colleagues (2007) have found the positive and negative pressure effects of that system.

Although one can criticize Anisimov and colleagues (2000c) for this approximation, there is currently no alternative to it. In its present form, the approximation is useful for comparing results obtained by the different research groups until a better description of the pressure effect is discovered. The problem of the nucleation standard will seemingly be solved when independent research groups can obtain consistent results with the different experimental schemes. We believe that the vapor-gas nucleation rate should be represented by a surface rather than by the single line currently used in most isothermal nucleation data for vapor-gas systems.

Conclusion

The FDC for vapor homogeneous nucleation rate measurements first appeared at the end of the 1970s. The FDC is used worldwide to measure vapor nucleation rates at low and elevated pressure conditions from 0.03 MPa to 0.4 MPa and nucleation temperatures from -30°C to 80°C . The FDC is a well-developed system, which can be used for single and multicomponent vapor-gas nucleation under a relatively wide variety of conditions. The FDC can be developed easily for measurements at pressures up to 20 MPa. Several results illustrated that a high-pressure flow diffusion chamber should be designed for the careful research of multichannel nucleation (e.g., Anisimova et al., 2001; Anisimov et al., 1998a, 1998b). While a new experimental system is being developed, research teams have used existing FDCs to study nucleation systems, showing that there are effects of the carrier gas and multiphase phenomena that need to be explored further. Experimentalists will hopefully find the uncontrollable parameter(s) soon in order to obtain consistent nucleation rate data from several research groups with different experimental schemes. Difficulty developing one or several nucleation standard(s) has been an ongoing problem. Developing a successful nucleation standard and introducing this standard into common nucleation research practice will be key advancements in the field. Having a better understanding of the effects of carrier gas will clarify the nature of the inconsistencies between different experimental data sets (Anisimov et al., 2003, 2009). The FDC is an important and capable tool for measuring vapor nucleation rates as well as expansion jet techniques and static cloud chambers.

Acknowledgments

We thank H. Reiss, J. Seinfeld, P. Hopke, R. Heist, M. Kulmala, P. Wagner, K. Hämeri, V. Zdimal, K. Okuyama, H. Lihavainen, Y. Viisanen, and many other researchers for critical discussions of the main idea and for developing and using the flow diffusion chamber.

References

- Aitken, J. (1888). On the number of dust particles in the atmosphere. *Transactions of the Royal Society of Edinburgh*, 35, 1.
- Allen, L. B., & Kassner, J. L., Jr. (1969). Nucleation of water vapor in the absence of particulate matter and ions. *Journal of Colloid and Interface Science*, 30, 81–93.
- Amelin, A. G. (1948). Generation of supersaturated vapor and aerosol under mixing of the vapor containing gases at different temperatures. *Kolloidnyi Zhurnal*, 10, 169–176.
- Anisimov, M. P., & Cherevko, A. G. (1982). Experimental measurement of the critical embryo molecules number at phase transitions of the first order and entropy of metastable to stable state transition. *Izvestiya Akademii Nauk Gruzii, Seriya Khimicheskaya*, 4(2), 15–19.
- Anisimov, M. P., & Cherevko, A. G. (1985). Gas-flow diffusion chamber for vapor nucleation studies. Relations between nucleation rate, critical nucleus size and entropy of transition from a metastable into a stable state. *Journal of Aerosol Science*, 16(2), 97–107.
- Anisimov, M. P., Costrovskii, V. G., & Shtein, M. S. (1978a). Generation of supersaturated vapors and aerosols of dibutyl phthalate by molecular diffusion mixing of different temperature coaxial flows. *Kolloidnyi Zhurnal*, 40(1), 116–121.
- Anisimov, M. P., Costrovskii, V. G., & Shtein, M. S. (1978b). Molecule number and surface tension for critical embryos from the vapor nucleation rate measurements. *Kolloidnyi Zhurnal*, 40(2), 317–321.
- Anisimov, M. P., Costrovskii, V. G., Shtein, M. S., & Mikheev, V. B. (1980). Spontaneous nucleation of water vapor. *Kolloidnyi Zhurnal*, 42, 941–945.
- Anisimov, M. P., Fominykh, E. G., Akimov, S. V., & Hopke, P. K. (2009). Vapor-gas/liquid nucleation experiments: A review of the challenges. *Journal of Aerosol Science*, 40, 733–746.
- Anisimov, M. P., Hämeri, K., Kulmala, M., & Ovchinnikova, T. E. (1993). Homogeneous nucleation of DBF and *n*-hexanol in a laminar flow diffusion chamber. *Report Series in Aerosol Science*, 23, 19–24.

- Anisimov, M. P., Hämeri, K., & Kulmala, M. (1994). Construction and test of laminar flow diffusion chamber: Homogeneous nucleation of DBP and *n*-hexanol. *Journal of Aerosol Science*, 25(1), 23–32.
- Anisimov, M. P., & Hopke, P. K. (2001) Nucleation rate surface topologies for binary systems. *Journal of Physical Chemistry B*, 105, 11817–11822.
- Anisimov, M. P., Hopke, P. K., & Berezina, A. S. (2003). General requirements and recommendations for vapor nucleation rate experiments. *Aerosol Science and Technology*, 37, 183–186.
- Anisimov, M. P., Hopke, P. K., Rasmussen, D. H., Shandakov, S. D., & Pinaev, V. A. (1998a). Relation of phase state diagrams and surfaces of new phase nucleation rates. *Journal of Chemical Physics*, 109(4), 1435–1444.
- Anisimov, M. P., Hopke, P. K., Shandakov, S. D., & Shvets, I. (2000c). *n*-pentanol-helium homogeneous nucleation rates. *Journal of Chemical Physics*, 113(5), 1971–1975.
- Anisimov, M. P., Koropchak, J. A., Nasibulin, A. G., & Timoshina, L. V. (1998b). Critical embryo phase transitions in the nucleated binary glycerin-carbon dioxide system. *Journal of Chemical Physics*, 109(22), 10004–10010.
- Anisimov, M. P., Koropchak, J. A., Nasibulin, A. G., & Timoshina, L. V. (2000a). 1-2 propanediol and 1-3 propanediol homogeneous nucleation rates and phase transitions in the new phase critical embryos. *Journal of Chemical Physics*, 112(22), 9917–9928.
- Anisimov, M. P., Nasibulin, A. G., & Shandakov, S. D. (2000b). Experimental detection of nucleation rate surface singularity. *Journal of Chemical Physics*, 112(5), 2348–2354.
- Anisimov, M. P., Vershinin, S. N., Aksenov, A. A., Sgonnov, A. M., & Semin, G. L. (1987). Experimental determination of the spontaneous nucleation rate, the size, and composition of a critical embryos in a supersaturated multicomponent vapor. *Kolloidnyi Zhurnal*, 49, 842–846.
- Anisimova, L., Hopke, P. K., & Terry, J. (2001). Two channel vapor nucleation in the vicinity of the triple point. *Journal of Chemical Physics*, 114, 9852–9855.

- Brock, J. R., Kuhn, P. J., & Zenavi, D. (1986). Condensation aerosol formation and growth in a laminar coaxial jet: Experimental. *Journal of Aerosol Science*, 17, 11–22.
- Brock, J. R., Kuhn, P. J., & Zenavi, D. (1988). Formation and growth of binary aerosol in a laminar coaxial jet. *Journal of Aerosol Science*, 19, 413–424.
- Brus, D., Hyvärinen, A., Zdimal, V., & Lihavainen H. (2005). Homogeneous nucleation rate measurements of 1-butanol in helium: A comparative study of a thermal cloud chamber and a laminar flow diffusion chamber. *Journal of Chemical Physics*, 122, 214506.
- Herrmann, E., Lihavainen, H., Hyvärinen, A.-P., Riipinen, I., Wilck, M., Stratmann, F., & Kulmala, M. (2006). Nucleation simulations using the fluid dynamics software FLUENT with the fine particle model FPM. *Journal of Physical Chemistry A*, 110(45), 12448–12455.
- Herrmann, E., Hyvärinen, A. P., Brus, D., Lihavainen, H., & Kulmala, M. (2009, February 3). Re-evaluation of the pressure effect for nucleation in laminar flow diffusion chamber experiments with FLUENT and the fine particle model. *Journal of Physical Chemistry A*, 113(8), 1434–1439.
- Hyvärinen, A. P., Brus, D., Zdimal, V., Smolík, J., Kulmala, M., Viisanen, Y., & Lihavainen, H. (2006). The carrier gas pressure effect in a laminar flow diffusion chamber, homogeneous nucleation of *n*-butanol in helium. *Journal of Chemical Physics*, 124(22), 224304. Erratum in: *Journal of Chemical Physics*, 128(10), 109901.
- Hyvärinen, A.P., Brus, D., Zdimal, V., Smolík, J., Kulmala, M., Viisanen, Y., & Lihavainen, H. (2007). The effect of total pressure on nucleation in a laminar flow diffusion chamber: *n*-pentanol + helium. In C. D. O'Dowd & P. E. Wagner (Eds.), *Nucleation and atmospheric aerosols: 17th international conference, Galway, Ireland, 2007* (Vol. 2, pp. 293–296). Netherlands: Springer.
- Kim, Y. J., Wislouzil, B. E., Wilemski, G., Wolk, J., & Strey, R. (2004). Isothermal nucleation rates in supersonic nozzles and properties of small water clusters. *Journal of Physical Chemistry A*, 108, 4365–4377.
- Kashchiev, D. (1982). On the relation between nucleation work, nucleus size, and nucleation rate. *Journal of Chemical Physics*, 76(10), 5098–5102.

- Kodenev, G. G., Baldin, M. N., & Vaganov, V. S. (1987). On applicability of Thompson's equation for small clusters. In A. A. Vostrikov & A. K. Rebrov (Eds.), *Clusters physics* (pp. 110–115). Novosibirsk, Russia: ITP.
- Kulmala, M., Viisanen, Y., & Hillamo, R. (1988). Experimental study of heteromolecular nucleation in sulphuric acid–water vapour binary system. In P. E. Wagner & G. Vali (Eds.), *Atmospheric aerosols and nucleation* (Lecture Notes in Physics, Vol. 309, pp. 379–382). New York, NY: Springer. DOI: 10.1007/3-540-50108-8_1093
- Langsdorf, A. (1939) A continuously sensitive diffusion cloud chamber. *Review of Scientific Instruments*, 10, 91–103.
- Lihavainen, H., & Viisanen, Y. (1998a). Laminar flow diffusion chamber for nucleation rate measurements. *Journal of Aerosol Science*, 29(Suppl.1), S381–S382.
- Lihavainen, H., & Viisanen, Y. (1998b). Laminar flow diffusion chamber for nucleation rate measurements. In J. Hienola & K. Hämeri (Eds.), *NOSA [Nordic Society for Aerosol Research] and the VII Finnish National Aerosol Symposium, Helsinki, November 12–13, 1998* (Report Series in Aerosol Science No. 41, pp. 381–382). Helsinki, Finland: Finnish Association for Aerosol Research.
- Mirabel, P., & Clavelin, J. L. (1978). Experimental study of nucleation in binary mixtures: The nitric acid–water and sulfuric acid–water systems. *Journal of Chemical Physics*, 68, 5020–5027.
- Mitrakos, D., Zdimal, V., Brus, D., & Housiadas, C. (2008). Data evaluation of laminar flow diffusion chamber nucleation experiments with different computational methods. *Journal of Chemical Physics*, 129(5), 054503.
- Nguyen, H. V., Okuyama, K., Mimura, T., Kousaka, Y., Flagan, R. C., & Seinfeld, J. H. (1987). Homogeneous and heterogeneous nucleation in a laminar flow aerosol generator. *Journal of Colloid and Interface Science*, 119(2), 491–504.
- Okuyama, K., Kousaka, Y., Kreidenweis, S., Flagan, R. C., & Seinfeld, J. H. (1988). Studies in binary nucleation: The dibutylphthalate/dioctylphthalate system. *Journal of Chemical Physics*, 89(10), 6442–6453.
- Ostwald, W. (1896–1903). *Lehrbuch der Allgemeinen Chemie*. Leipzig, Germany: W. Engelmann.

- Oxtoby, D., & Kashchiev, D. (1994). A general relation between the nucleation work and the size of the nucleus in multicomponent nucleation. *Journal of Chemical Physics*, 100, 7665–7671.
- Peters, F., & Paikert, B. (1989). Experimental results in the rate of nucleation in supersaturated n-propanol, ethanol, and methanol vapors. *Journal of Chemical Physics*, 91, 5672–5678.
- Sinclair, D., & La-Mer, V. K. (1949). Light scattering as a measure of particle size in aerosols. *Chemical Reviews (Washington, DC)*, 44, 245–251.
- Strey, R., Viisanen, Y., & Wagner, P. E. (1995). Measurement of the molecular content of binary nuclei. III. Use of the rate surfaces for the water–n-alcohol series. *Journal of Chemical Physics*, 103(10), 4333–4345.
- Strey, R., & Wagner, P. E. (1988). Measurements of the heteromolecular homogeneous nucleation of partially miscible liquids. *Journal of Aerosol Science*, 19, 813–816.
- Strey, R., Wagner, P. E., & Schmeling, T. (1986). Homogeneous nucleation rate for n-alcohol vapors measured in two-piston expansion chamber. *Journal of Chemical Physics*, 84(4), 2325–2335.
- van Remoortere, P., Heath, C., Wagner, P., & Strey, R. (1996). Effect of supersaturation, temperature and total pressure on the homogeneous nucleation of n-pentanol. In M. Kulmala & P. Wagner (Eds.), *Proceedings of the 14th ICNAA, Helsinki* (pp. 256–259). Oxford, England: Pergamon.
- Volmer, M. (1939). *Kinetik der Phasenbildung*. Dresden-Leipzig, Germany: T. Steinkopf.
- Wagner, P. E., & Anisimov, M. P. (1993) Evaluation of nucleation rates from gas flow diffusion chamber experiments. *Journal of Aerosol Science*, 24(Suppl. 1), 103–104.
- Wilck, M., Hämeri, K., Stratmann, F., & Kulmala, M. (1998). Determination of homogeneous nucleation rates from laminar-flow diffusion chamber data. *Journal of Aerosol Science*, 29(8), 899–911.
- Wilemski, G. (1975), Binary nucleation. I. Theory applied to water-ethanol vapor. *Journal of Chemical Physics*, 62, 3763–3771.

History of Manufacture of Fine Particles in High-Temperature Aerosol Reactors

Sotiris E. Pratsinis

This chapter reviews the historic development of aerosol reactors for the manufacture of commercially available fine particles, placing emphasis on flame-made carbon black, titanium dioxide (TiO_2), and silicon dioxide (SiO_2), which dominate the aerosol-made material market by volume and value, followed by particles made in hot-wall reactors (zinc oxide [ZnO], nickel [Ni], tungsten carbide [WC], and others). Early discoveries have shaped this industry: carbon black can be used to reinforce tires, and carbon black made from flare gas in oil fields is equivalent to that made from natural gas. Carbon black engineers were some of the first to introduce the fractal characterization of aerosol particles. Also the competition between coagulation and sintering for synthesis of fractal-like or ramified particles seems to have been reported first in reference to the manufacture of fumed silica. The success of DuPont's research on the aerosol synthesis of titania is best illustrated by the fact that DuPont started using the process in 1951 but DuPont's competitors did not build similar plants for TiO_2 production for more than 12 years. Despite such technologies being developed through trial and error, aerosol engineers today understand the mechanisms controlling the characteristics of these particles. In this chapter, the role of process variables on particle characteristics is highlighted. Such understanding guides the rational design and operation of aerosol reactors for synthesis of a number of commodities today. It also enables aerosol technology to develop a score of new processes and products, such as catalysts, sensors, biomaterials, photonics, and even nutritional supplements and functional devices to name a few that have evolved from academic laboratories and start-up companies.

Introduction

Smoke has been used throughout human history: in prehistoric drawings on cave walls and art in ancient Egypt, India, Greece, and China; as a preservative for meat and fish by Romans and Scandinavians; and even as a means of telecommunications by ancient Trojans and American Indians. Flame-made particles have special structure and high purity, resulting in unique products such as carbon black and fumed silica for light guides (Ulrich, 1984). Furthermore, gas phase (aerosol) technology involves fewer process steps than liquid phase technology, and separation of product particles from gases is easier than from liquids because it does not involve liquid by-products and costly effluent cleaning (Pratsinis & Mastrangelo, 1989). As such, it is no surprise that aerosol processing is preferred over wet chemistry processes for many industrial uses, including production of titania pigments (chloride vs. sulfate processes) and cleaning effluent streams (gas vs. wet scrubbing). Very recently, it has been shown that aerosol processes can make metastable materials such as low-temperature barium carbonate (BaCO_3) for NO_x -storage and reduction (NSR) catalysts (Strobel et al., 2006a) or tungsten trioxide ($\epsilon\text{-WO}_3$) for highly selective sensors of acetone, a diabetes marker in the human breath (Righettoni et al., 2010).

Historically, aerosol manufacturing technologies have been developed around specific products that predominately use flame or hot-wall reactors. Today flame reactors produce 90% (by value and volume) of aerosol-made commodities, including carbon black, pigmentary titania, and fumed silica (Stamatakis et al., 1991; Wegner & Pratsinis, 2003a). Hot-wall reactors have been used to manufacture ZnO, Ni, iron (Fe), and nonoxide ceramics (e.g., tungsten carbide). The early development of aerosol reactor technology was driven solely by product discovery and application (e.g., the reinforcement of rubber by carbon black was developed specifically for the production of tires for motor vehicles).

With the paucity of scientific information available in the early 20th century, the ability to construct and continuously operate huge units for aerosol manufacture of such materials at really high production rates was a miracle of engineering. Although much is known about soot formation, this knowledge may be of little relevance to materials manufacture (Skillas et al., 2005). When soot is viewed as a nuisance or a pollutant, there is little motivation for detailed characterization and performance evaluation, which are the focus of the carbon black industry. Typically, soot formation research

focuses on understanding pathways for soot's suppression. In contrast, the materials industry focuses on the development and characterization of soot after particle formation (e.g., the development of particle morphology, structure, surface, and crystallinity), especially at the high concentrations that are of most interest for the efficient and sustainable manufacture of such particles. As a result, the development of aerosol reactor technology is closely associated with the performance of its specific products.

This chapter reviews the historic evolution of this technology for the manufacture of today's particulate commodities so that one may better understand the factors that may guide the future manufacture of other aerosol-made products such as electroceramics, catalysts, and sensors. As such, this chapter does not cover synthesis of films, coatings, or deposits that are made by aerosol processes, including suspended droplets or particles deposited in a molten state on surfaces at high temperatures by flames, plasma, or torches, or at low temperatures by high-pressure sprays or electrospraying. This technology is called "thermal spray coating," as reviewed by Clyne and Gill (1996), or just "spray coating" or "combustion chemical vapor deposition" (Hunt et al., 1993); and Tricoli and colleagues (2010) have recently reviewed its use for gas sensors. This chapter also does not discuss the manufacture of optical fibers involving oxidation of precursor vapors and deposition of fine silica-based particles and eventual fiber drawing (Rowell, 1986). One should note, however, that aerosol science truly guided the design and operation of optical fiber preforms by modified chemical vapor deposition because aerosol thermophoresis dominated the yield of this process. The present chapter excludes materials made by spray pyrolysis or aerosol decomposition because this is a small (albeit increasing) market, especially for select ceramic materials (Kodas & Hampden-Smith, 1999). Similarly, I do not address nanoparticle synthesis in plasma and laser reactors, including laser ablation, because of their limited contribution to large-scale manufacture materials until recently. Nevertheless, several excellent studies have been published on the topic: Vollath (2007) has reviewed plasma synthesis of materials, focusing on microwave plasmas that allow even organic coatings on nanoparticles; Semaltianos (2010) has examined nanoparticle synthesis by laser ablation; and Van Erven and colleagues (2009) have focused on the scale-up of laser reactors.

The present chapter focuses on the history of the development of aerosol reactors for synthesis of *commercially available* fine particles (carbon black,

titania, silica, zinc oxide, and nickel), emphasizing the flame and hot-wall reactors that dominate this field. Other authors provide additional insight into various aspects of aerosol reactors:

- Ulrich (1984) gives an excellent overview of flame aerosol technology for materials manufacture that ought to be read by anyone working in this field.
- Gurav and colleagues (1993) superbly review nearly 350 papers on aerosol processing of materials in a special issue of *Aerosol Science and Technology* that contains some seminal articles in the field.
- Rosner (1997) gives an outstanding account of combustion synthesis of commodity gases, particles, and films.
- Wooldridge (1998) and Pratsinis (1998) tutorially review flame reactors and models for synthesis of particles until the mid-1990s, outlining how flame variables affect product particle size and morphology.
- Kudas and Hampden-Smith (1999) describe a broad spectrum of pertinent applications of aerosol processing of materials, and the second edition of Friedlander's (2000) classic aerosol textbook addresses dynamics of irregularly shaped particles that are so relevant to this technology.
- Swihart (2003) critically reviews the state of the art in vapor synthesis of materials, focusing on methods and processes.
- Strobel and colleagues (2006b) summarize the recent, rapid development of heterogeneous catalysts by flame aerosol technology.
- Roth (2007) highlights recent experimental, diagnostics, and modeling aspects of particle formation in flames for materials processing.
- Strobel and Pratsinis (2007) review how flame aerosol technology can be used to make various sophisticated materials for sensors, biomaterials, electroceramics, and even nutritional supplements.
- Biskos and colleagues (2008) review aerosol generation and characterization methods for nanoparticles.
- Athanassiou and colleagues (2010) show how ceramics and even metals are made in scalable flame aerosol reactors.
- Camenzind and colleagues (2010) review how aerosol-made nanoparticles affect the mechanical and optical properties of nanocomposites.

- Pratsinis (2010) shows how critical is aerosol technology to nanoscale manufacturing: from functional materials to sophisticated devices.

Finally, it should be noted that aerosol synthesis of materials has recently expanded rapidly as the potential of aerosol technology has become recognized across scientific disciplines. Furthermore, academic laboratories and start-up companies have recently developed a number of new aerosol processes for synthesizing novel materials; because this chapter examines the use of aerosol in large-scale commercial manufacture, it does not cover these new developments because they have not yet reached their full commercial scale. As such, there is much more in recent literature than is discussed here, especially with new processes and products being developed in both industrial and academic laboratories.

I start by looking at the manufacture of carbon black. Carbon black was the first flame-made product to attain industrial status; from prehistoric times, it has been used to make inks, and since the early 20th century, it has been used to reinforce rubber tires. Each automobile tire contains about 20% carbon black by weight. I then discuss TiO_2 , the largest (by volume and value) ceramic material made in flame aerosol reactors, followed by fumed silica and its diverse applications, mostly as a flowing aid to particulate commodities in a multitude of applications (e.g., cosmetics, food, and drugs) and as the basic material for optical fibers. Finally, I discuss particles—such as ZnO, WC, and filamentary Ni (which is the leading aerosol-made metal today)—that are made in hot-wall reactors.

Carbon Black

Carbon black is the oldest aerosol that is still manufactured today. Its history is well documented in encyclopedias and specialized books (Cabot, 1979; Kühner & Voll, 1993; Collin, 2000; Wang et al., 2004). In short, carbon black was first made in India and Egypt at prehistoric times and was systematically manufactured for pigments in China by pyrolysis of vegetable oils, using the “lampblack” process at about 1500 BC. This process involves the evaporation and pyrolysis of hydrocarbon vapors in a closed chamber to which a controlled amount of air is supplied. Carbon black is formed in the gas phase (aerosol) and is deposited by thermophoresis onto the smooth walls and ceilings of the chamber; it is then scraped from the surfaces of the chamber and is suspended in fluids for various applications.

The lampblack process was rather simple because only one parameter, the supplied air, controlled the carbon black's characteristics. Simplicity, however, was accompanied by a lack of flexibility because selective evaporation of the volatile oil fraction from the evaporating pans during manufacturing required systematic removal of the remaining heavy residue from the pans. Lampblack carbon black had a broad particle size distribution caused by its exceedingly broad residence time distribution resulting from the inhomogeneous mixing of incoming air and freshly formed carbon black over the pans. Flexibility was also limited because manufacturers were required to replace small with larger pans for evaporation of oil when shifting the average particle size from fine to large. Today, only large carbon blacks, up to 500 nm primary particle size, are made by the lampblack process (Kühner & Voll, 1993).

In the late 19th century, "channel" or "gas" carbon black was discovered. This form of carbon black had a finer texture than the carbon black produced by the lampblack process, making it attractive for use in more viscous printing ink. Its raw material was natural gas (in the United States) or vaporized oil from coal tar distillates (in Europe). The combustion plume impinged on cold surfaces at the bottom of water-cooled channels (hence "channel carbon black") or rotating drums, where it was collected. The yield of this process was 3%–5%, and a large fraction of carbon black ended up in the atmosphere, making the smoke from these plants visible from far away (Kühner & Voll, 1993). This form of carbon black had a finer structure (primary particle size 10–30 nm) than lampblack because of its short high-temperature residence time. It appealed successfully to the dominant ink industry at the time and contributed to discovering the reinforcing role of carbon black on natural rubber.

After the discovery of the reinforcing role of carbon black in tires (by the turn of the 20th century) and the beginning of automobile mass production after World War I, the demand for natural gas increased rapidly. Gas suppliers could store natural gas and distribute it at will, controlling the market. At that point, Thomas Cabot, whose family owned a small carbon black company in Pennsylvania, discovered that flare gas from oil fields was as good as natural gas for synthesizing gas carbon black and shifted the carbon black feedstock from natural to flare gas, which was cheaply available. From 1925 to 1930, Cabot Corporation built nine such plants, becoming one of the carbon black technology leaders, which still is today (Cabot, 1979).

Further improvements in handling carbon black, including pelletization to reduce dust problems, allowed shipping and distribution of carbon black over

great distances. However, the inherently low yield of the channel/gas process and the onset of World War II pushed engineers to develop the furnace process in 1941. This is a classic aerosol reactor that allows scalable, single flame synthesis of carbon black with flexible characteristics such as variable primary and agglomerate size, variable structure, and even variable primary particle porosity. A change in raw material to aromatic-based feedstock facilitated the current dominance of the furnace process; more than 80% of carbon black is made by this process today. Other carbon blacks include thermal and acetylene carbon black. The former is made by a batch process, whereas the latter has a very small primary particle size, a graphitic structure, and a high degree of aggregation, leading to the high conductivity that makes acetylene carbon black attractive for electrical applications (Kühner & Voll, 1993).

The development of a single reactor for carbon black synthesis by the furnace process and its flexibility in product characteristics emphasized the need for a better scientific understanding for process scale-up. Indeed, right after World War II, there was a huge need for carbon black to reinforce natural and synthetic rubber. The first attempts to characterize agglomerates were made in the carbon black industry. Medalia and Heckman (1969) introduced new ways to characterize agglomerate particles by optical microscopy in their effort to link carbon black reinforcing performance to carbon black characteristics and furnace process design and operation. By counting the primary particles in agglomerates, N_p , they reported a power law relating agglomerate size (radius of gyration), R , to the fractal dimension, D_f , introduced 10 years later by Mandelbrot (1982):

$$N_p \sim R^{D_f} \quad (1)$$

In fact, carbon black particles are frequently cited as fractal applications by Mandelbrot (1982) and others. According to the early patent literature, a lot of industrial research focused on reactor design, wall deposits, and additive use for the control of agglomeration (Mezey, 1966).

The lack of basic studies on carbon black formation and growth is most amazing given its history and industrial volume. Notable exceptions to this are the chemical kinetics of benzene pyrolysis for carbon black formation (Ivie & Forney, 1988) and the carbon black reactor model of Skillas and colleagues (2005) that interfaces aerosol dynamics with fluid mechanics. Most

of the prevailing understanding of carbon black formation and growth relies, however, on fuel lean soot formation (Donnet & Bansal, 1993). Accordingly, carbon black is made by nucleation followed by surface growth, coagulation, and partial oxidation. During carbon black formation, fuel-rich combustion takes place because about half of the fed carbon is combusted to pyrolyze the rest and form carbon black in a gas mixture containing mostly products of incomplete combustion, hydrogen (H_2), and traces of oxygen (O_2) that may give different surface growth rates than classic soot formation models. Necks between carbon black primary particles are probably formed when carbon black is rather soft and liquid, containing lots of hydrogen, which should happen at low rather than at high temperatures, when hard, graphitic structures are created. This process contrasts starkly with aggregate formation of ceramic particles by sintering, in which complete coalescence takes place at high temperatures (Koch & Friedlander, 1990).

As a result, there is considerable uncertainty in present carbon black models that qualitatively predict the effect of process variables on carbon black characteristics (Skillas et al., 2005). Additionally, in the dominant furnace process, the carbon black plume is quenched much faster than in ceramic flame-made aerosols because the carbon black plume is also a fuel (containing carbon and H_2 from hydrocarbon pyrolysis) and can be readily oxidized. In fact, water injection is used to quench carbon black aerosols right after they exit the burner rather than relying on gentle cooling through pipe walls, as with pigmentary titania. Depending on the cooling rate, the surface of carbon black primary particles may become porous, releasing carbon monoxide (CO) and H_2 later on (Kühner & Voll, 1993).

This scientific uncertainty, however, has not prevented the construction and operation of carbon black plants all over the world for more than a century. In fact, the production volume of carbon black is more than 3 times that of the next aerosol-made material (TiO_2), and its value is almost twice that of TiO_2 (Wegner & Pratsinis, 2003a). The evolutionary growth of this process has reached a point at which the design of some of its components are quite close to their optimum.

So it is not an overstatement that carbon black manufacture is an engineering marvel that produces a commodity that is quite modern, considering that it is also the cheapest nanostructured material available in the market today. Nevertheless, improved understanding of the process can have a large impact on its economics, because carbon black is a high-volume commodity. In fact, the fraction of combusted and pyrolyzed hydrocarbon

produced by the furnace process is critical for this industry. Furthermore, understanding the production process could help to reduce the prices of today’s costly carbon nanotubes, making them available for a score of applications (Pratsinis, 2010). Last, but not least, safety and occupational health issues, including detailed air-quality monitoring, play an important role during carbon black production (e.g., Kuhlbusch & Fissan, 2006). Such issues become increasingly important for manufacture of all nanostructured materials. As a result, the carbon black industry experience is invaluable in the regard.

Titania, TiO₂

Manufacturing of TiO₂ constitutes the second largest industrial aerosol commodity (in value and volume) after carbon black. About 5 million tons of titanium dioxide are made annually, representing 85% of worldwide use of titanium metal. Most TiO₂ is used as pigment for paints (65%), plastics (20%), and paper (10%), with the rest being used for specialty applications including catalysts, sunscreens, and, very recently, photocatalysts. Today, about 60% of TiO₂ is made in aerosol reactors by the so-called “chloride” process, which involves ore chlorination, distillation of titanium tetrachloride (TiCl₄), and oxidation of the TiCl₄ vapor at high temperatures (Figure 1). The remaining TiO₂ is made by the older “sulfate” process, in which ore is dissolved in sulfuric acid (H₂SO₄), followed by precipitation and separation of iron sulfate (FeSO₄) from the liquid titanium sulfate [Ti(SO₄)₂] that, upon

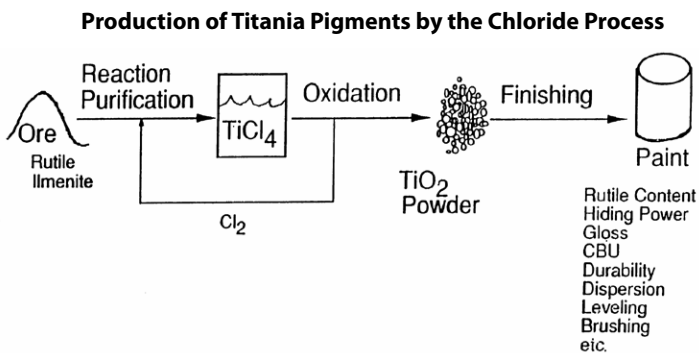

Figure 1. Schematic of the chloride process: Pure TiCl₄ made by chlorination of rutile or ilmenite ores is purified by distillation and fed to the flame reactor (oxidizer). There, mostly TiO₂ (about 200 nm) in primary particles is produced and led to a series of wet processes (finishing) to be suspended in paints while by-product Cl₂ is recycled for ore chlorination.

heating, decomposes and precipitates out TiO_2 . The chloride process was developed first by DuPont, currently the largest producer of TiO_2 , with 25% of worldwide production, followed by Cristal (formerly Millennium and SCM Co.) with about 20%, and Tronox (formerly Kerr-McGee) with 13% (Bohnet, 2003).

The use of TiO_2 as a superior white pigment has been known since 1916, but initially the high manufacturing cost of the wet sulfate process prohibited its widespread use. By 1930, DuPont was the largest US producer of lithopone (ZnS/BaSO_4), the white pigment of choice at that time. However, as TiO_2 quality and price became competitive with lithopone's, DuPont realized that, within a few years, its leadership in this market would be undercut. DuPont then evaluated the patent landscape for manufacturing of TiO_2 by the sulfate process, carried out its own research, and bought a sulfate TiO_2 patent-holding company. By 1934, DuPont had decided to make its own sulfate plant for TiO_2 manufacture.

DuPont's early success in the TiO_2 business was its marketing, as early as 1941, of sulfate-made rutile TiO_2 that had 20% higher hiding power than anatase, because of a higher refractive index of rutile, 2.72, than that of anatase, 2.55 (Hounshell & Smith, 1988). Manufacture of TiO_2 by present-day methods produces pigments with a closely controlled size distribution and average particle size, and this probably explains its success over other white pigments (Hounshell & Smith, 1988). The opacity of TiO_2 is an exceptionally strong function of particle size (Kingery et al., 1976). In fact, there is little tolerance in particle size variation (about 10%) by pigment manufacturers. When, in the late 1980s, I had remarked that this could not be detected reliably by then-current aerosol instruments, one DuPont engineer replied that their accountants would detect such a difference, given DuPont's production volume!

DuPont's dominance in TiO_2 markets relies on its industrial development of the chloride process:

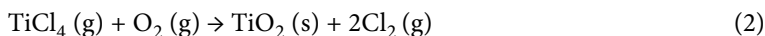

Although the process was discovered as early as 1928, a series of DuPont patents starting in 1949 covered a number of process aspects and details, including the use of additives such as AlCl_3 to promote rutile formation and many ways to prevent deposits on the TiCl_4 injection orifice and reactor

walls (Mezey, 1966). The scale-up of the chloride process was direct from bench to commercial scale, without having the benefit of a pilot plant. The process was effectively piloted at full scale until a really workable process emerged (Hounshell & Smith, 1988). The success of DuPont's research and development effort is probably best illustrated by the fact that although the company started chloride-process TiO_2 production in 1951, it was 12 more years before any corporate competitors were able to build chloride-like plants for TiO_2 production. In fact, DuPont's chloride process is one of the best-kept secrets in the business (Mezey, 1966). Rumor has it that other DuPont plants bought proprietary additives for the chloride process and delivered them internally to the chloride sites. In the mid-1960s, chloride-like plants were built by Tioxide in the United Kingdom, followed by Kronos in Germany and Kerr-McGee in the Netherlands (which now operates under the name "Tronox") and in Saudi Arabia (which now operates under the name "Cristal"). A chloride-like process was introduced in Japan in 1974 by Sangyo Ishihara, although related patents had been awarded in Japan since 1958. In Asia, the first DuPont chloride plant was built in Taiwan in 1994, and the biggest one is planned for Dongying, China, about 500 km south of Beijing on the Pacific coast.

Nevertheless, other manufacturers (e.g., Tioxide, Cristal, and Kronos, to list a few) have developed similar but legally unique processes. In these processes, the precursor, TiCl_4 , is typically obtained from chlorination of rutile or ilmenite ores containing either 95% or 50%, respectively, titanium, as well as iron, vanadium, and other metal oxides (Figure 1). High-purity TiCl_4 is obtained by distillation and is fed as vapor to the aerosol reactor (oxidizer) unit, where it is oxidized or burned at $1,000^\circ\text{C}$ – $1,500^\circ\text{C}$ with an O_2 –CO flame, air, external heating, or preheating TiCl_4 with O_2 at intermediate temperatures (Clark, 1975; Wiseman, 1976). Typically the exothermic TiCl_4 oxidation reaction sustains the process and facilitates particle growth to the optimal crystallite size of about 200 nm (Mezey, 1966). To assure synthesis of rutile or anatase crystallites, 0.5%–2%, respectively, of aluminum- or silicon-based promoters or catalysts are co-oxidized with TiCl_4 (Mezey, 1966; Wiseman, 1976).

Titania particles for pigments are made at high concentrations by TiCl_4 oxidation at nearly stoichiometric conditions and grow by coagulation, surface growth (Spicer et al., 2002), and sintering (Kobata et al., 1991) in

turbulent flows ($Re = 10^5 - 10^6$) at or near atmospheric pressures (1–4 bars) (Xiong & Pratsinis, 1991), forming agglomerates and aggregates (Figure 2) of primary particles (Grass et al., 2006). By-product chlorine gas is recycled for ore chlorination. To minimize fusion or necking of the TiO_2 particles and formation of large hard agglomerates (or aggregates), their temperature has to be reduced to less than $600^\circ C$ (Mezey, 1966). Titania particles leaving the oxidizer (flame aerosol reactor) are typically soft agglomerates, several micrometers in diameter, consisting of smaller (about 500 nm) hard agglomerates (aggregates) that contain even smaller (about 200 nm) primary particles (Heine & Pratsinis, 2007). As a result, special milling (grinding) is used to break up the soft agglomerates before feeding them to the finishing plant where their surfaces are coated and conditioned for suspension in paints or compounding in polymer or paper matrixes. Aggregate formation can be controlled by adding alkali metal halides (e.g., potassium chloride [KCl] as in soot formation) in the presence of $AlCl_3$ or $SiCl_4$ (Xiong et al., 1992a; Akhtar et al., 1994).

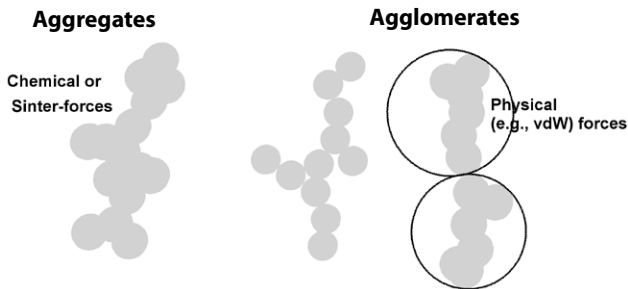

Figure 2. Structure of flame-made particles: Aggregates of primary nanoparticles (or hard-agglomerates) are held together by chemical (e.g., sinter) forces while agglomerates (or soft-agglomerates) of primary particles and/or aggregates are held together by physical forces.

Source: Derived from Tsantilis and Pratsinis (2004).

In contrast with the carbon black process, the ensuing global (Pratsinis et al., 1990) and detailed (West et al., 2009) kinetics of $TiCl_4$ oxidation in the gas phase and on the surface of freshly formed TiO_2 particles (Ghoshtagore, 1970) are known. Today, the role of process parameters on TiO_2 size, morphology, and crystallinity is well understood. The essential concept is the *particle residence time at high temperature*. In premixed flame reactors, perfectly spherical titania particles of increasing diameter are formed at increasing distances (or residence times) away from the burner (Arabi-Katbi et al., 2001) in both upward and downward flame configurations (Arabi-Katbi

et al., 2002). These particles attain the self-preserving number size distribution (George et al., 1973) having a geometric standard deviation, σ_g , of 1.45 in excellent agreement with theory (Tsantilis et al., 2002). Increasing precursor concentration increases enthalpy and TiO_2 concentration, which results in producing larger particles by coagulation and sintering without altering their polydispersity (Arabi-Katbi et al., 2001).

Compared with premixed flames, diffusion flames allow for more parameters to control a broader range of characteristics of the produced titania and other oxides. In a classic diffusion flame, the fuel (any hydrocarbon or hydrogen) and TiCl_4 or other precursor are in the center stream, surrounded by the oxidant (air or oxygen) in the outer stream. The product particle size and rutile fraction decrease with increasing oxidant flow rate as particle concentration, visible flame height, and particle residence time at high temperature are reduced for constant flow rate of precursor TiCl_4 (Zhu & Pratsinis, 1996) or titanium isopropoxide (TTIP) (Stark et al., 2001). This decrease in size comes from reducing the coagulation rate by dilution with the added oxidant gas and reducing the sintering rate by cooling from the additional, effectively inert, oxidant gas stream. The rutile fraction decreases by increased oxidant flow rate, reduced high temperature particle residence time, and higher oxygen concentration.

The particle morphology is affected drastically by the oxidant flow rate in diffusion flames. At low oxidant flow rates, long laminar diffusion flames result in spherical nonagglomerated particles, whereas at high flow rates, agglomerates of much finer particles are made (Wegner & Pratsinis, 2003b). The increased oxidant flow rates gradually transform a laminar diffusion flame to a turbulent, effectively premixed flame in which the rapid gas cooling prevents the coalescence of colliding titania clusters, resulting in the collected agglomerates.

Replacing oxygen with air in diffusion flames reduces particle size and rutile fraction, although the visible flame height is increased. Clearly, air flames have longer residence times, but at lower temperatures than oxygen flames (Zhu & Pratsinis, 1996). For constant oxidant flow rate, increasing Ti-precursor flow results in larger primary particles regardless of whether TiCl_4 (Pratsinis et al., 1996) or TTIP (Stark et al., 2002) is used as the precursor. The rutile fraction increases with TTIP concentration but not with TiCl_4 at constant fuel (CH_4 or H_2) concentration. When the latter is increased (Pratsinis et al., 1996), the rutile fraction increases as particles experience higher temperature residence times in agreement with the thermodynamics

of anatase-to-rutile transformation. Interestingly enough, this trend has a limit, because further increasing the fuel flow rate reduces the rutile fraction although the primary particle size increases, indicating that the high-temperature particle residence time is sufficient for grain growth but not for the anatase-to-rutile transformation (Stark et al., 2002).

The most fascinating effect of oxidant composition, however, is on particle morphology. By gradually changing the oxygen content of the oxidant stream, product particles transform from necked aggregates or hard agglomerates (pure air) to perfect colloidal-like spheres (pure O₂). Pure O₂ accelerates fuel consumption so that particles experience a higher maximum temperature than when oxidized with air, and because the fuel is consumed faster than with air, they experience a steeper cooling with O₂ (Zhu & Pratsinis, 1996). Using O₂ as an oxidant, particles can grow more before the end of coalescence. When full coalescence ends, it does so abruptly, preventing neck formation between colliding particles by their omnipresent Brownian motion, which can only lead to soft agglomerates (Grass et al., 2006).

A major challenge in the development of chloride aerosol reactors has been identifying materials of construction that will hold up to high temperatures and corrosive atmospheres. Early development was conducted on quartz reactors, and plants had several glass blowers skilled at repairing damage to quartz reactors. That skill has disappeared from chloride plants. As materials development in the area of high-temperature alloys has progressed, precious metal use in the process has decreased. The heaters for vaporization of AlCl₃/TiCl₄ used to be made out of platinum, and some chloride plants had the world's largest inventories of platinum. This is no longer the case because the heaters are now made of high-quality metal alloys. Quartz did have its advantages. The early developers were strong adherents of the adage "seeing is believing"; the quartz allowed the flow patterns in the burner and reactor to be visually observed, and this helped to refine aerosol reactor design before the days of computational fluid dynamics. Developments to reduce thermophoretic deposition attracted a lot of attention: the method of choice was knocking the pipe walls, either manually or with vibrators. A common practice for preventing wall deposit was to judiciously inject large particles to "scrape" such deposits from reactor walls. Process efficiency drove the search for particles that were easier to use, and the industry settled on sand and salt—one insoluble in water and the other soluble.

Currently, the TiO₂ pigment industry grows at about 3% annually, especially as new markets are evolving in India and China, making

new investments attractive. Furthermore, there is growing interest in manufacturing finer TiO_2 (less than 50 nm in diameter) for photocatalytic, cosmetic, ultraviolet (UV) protection, and other applications. Wet-made TiO_2 (e.g., by Sachtleben Chemie) and Evonik's flame-made P25 TiO_2 cater to these markets. The latter is mostly (70%) anatase and is approximately 50 nm in primary particle diameter with a ramified morphology that is made by the oxychloride flame aerosol process employed widely for fumed silica manufacture (as discussed in the subsequent section). Most of today's research on aerosol-made TiO_2 focuses on nanoparticles for catalysts, sensors, films by laser flame synthesis by the NanoGram Corporation, low pressure flames (Lindackers et al., 1994), and flame spray pyrolysis (Teoh et al., 2007), to name a few.

Silica, SiO_2

Fumed silica is the third largest industrial aerosol commodity by value and the fourth largest by volume. As with carbon black, it is made solely by aerosol technology. Most of it is used as a flowing aid in a wide spectrum of applications including paints, microelectronics, pharmaceuticals, and cosmetics. Synthesis of fumed silica by combustion of SiCl_4 in an oxy-hydrogen flame was discovered in the late 1930s by scientists at Degussa (now part of Evonik) who were looking for a replacement for carbon black as a reinforcing agent for rubber. However, it was never used as such because fumed silica quickly captured other more profitable markets as a flowing aid. Right after World War II, Cabot sold it in the United States. When the US market grew large enough, Cabot cross-licensed Degussa's process and built a plant producing about 1,500 tons of fumed silica in the United States in 1958 (White & Duffy, 1959). Today Evonik, Wacker, and Cabot dominate the worldwide market in fumed silica.

Manufacturing of fumed silica is somewhat similar to the chloride process for manufacturing TiO_2 . In fact, manufacture of optical fiber preforms by the modified chemical vapor deposition process involving SiCl_4 oxidation in pipe flow resembles the chloride process for TiO_2 , although the product is deposited on the pipe walls instead of being collected (Rowell, 1986). A major difference between these two flame-made oxides lies in their sintering characteristics. The fumed silica has a primary particle diameter of 7–60 nm, whereas that of TiO_2 made at identical conditions is almost an order of magnitude larger (Xiong et al., 1993). Fumed silica aggregates (hard agglomerates) are typically about 200–300 nm in diameter, consisting of

several primary particles. As a result, fumed silica possesses very high surface area, necessitating special care in its handling (e.g., removal of adsorbed chlorine), because impurities are picked up easily. In fact, the preservation of the “fluffiness” of fumed silica imposed by its highly ramified structure is essential for many of its applications.

Today, the dominant route for synthesis of fumed SiO₂ relies on the oxychloride process for oxidizing various silica precursors, especially SiCl₄:

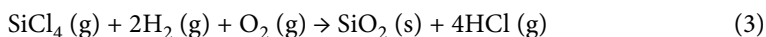

In particular, the capacity and flexibility of a given plant to employ alternative chlorosilane precursors (e.g., by-products of microelectronics processing) and cheap H₂ along with the ability to sell hydrochloric acid (HCl) is essential for the success of an industrial fumed silica synthesis unit. In fact, the location of any new plant is largely decided on these factors, as the history of existing units amply tells. For example, the decision to build Cabot's first unit in Tuscola, Illinois, was influenced by the existence of a nearby plant that could supply it with H₂ and buy its by-product HCl (White & Duffy, 1959). This continues today, as with Cabot's plant in Rheinfelden, Germany, where chemicals are shared with Evonik's fumed silica plant.

As with TiO₂, a number of patents cover various process aspects for fumed silica manufacture (Mezey, 1966). In the current oxychloride process, high-purity tetrachlorosilane (SiCl₄) or other chlorosilanes are obtained and fed as vapor to the aerosol reactor (oxidizer) unit where they are burned at 1,000°C–1,500°C with an H₂–O₂ flame (Bohnet, 2003). Again, the heat of that flame and the exothermic chlorosilane oxidation reaction sustain the process, facilitating particle growth by coagulation and sintering that result in the desired product. Excess heat is converted to electric energy and supplied to the local electric network.

Ulrich (1971) presented the first systematic investigation of a flame-made material, fumed silica, in premixed laminar and turbulent jet flames. He showed that aerosol coagulation by Brownian motion, rather than by turbulence, is the dominant particle formation mechanism in these reactors. He quantitatively explained particle growth with increased residence time by Brownian coagulation and predicted that these particles reach a self-preserving size distribution in the free-molecular regime. In fact, he published this distribution a year ahead of Lai and colleagues (1972), who have been

largely credited for it. This was proven experimentally by measuring the sizes of flame-made titania from micrographs at Tioxide, United Kingdom (George et al., 1973). Thermophoretic sampling was used for particle collection to infer the significance of surface growth of flame-made TiO_2 . This sampling technique was systematically introduced by Dobbins and Megaridis (1987) and effectively opened up the “black box” of combustion synthesis of materials.

Product SiO_2 particles grow by coagulation and sintering in turbulent flows at or slightly below atmospheric pressure, forming aggregates (hard agglomerates) and soft agglomerates of primary particles (see Figure 2 in this chapter, which is derived from Tsantilis & Pratsinis, 2004). The existence of such aggregates is established by small-angle X-ray or neutron scattering, because aggregates exhibit two distinct slopes of intensity versus frequency (inverse particle size), whereas nonaggregates exhibit only one slope (Kammler et al., 2004). Fumed SiO_2 particles are collected mostly by baghouse filters, preceded by cyclones (Mezey, 1966) for all but high-purity silica products. As pointed out above, emphasis is put on SiO_2 surface treatment by removing attached HCl from its surface (de-acidification), typically in fluidized beds with or without chemical reaction (Flesch et al., 2008). In addition, the hydrophilic surface of fumed silica can be treated with organic functional groups to become hydrophobic for selected applications.

The detailed chemical kinetics of SiCl_4 oxidation in O_2 - H_2 flames have been presented by Hannebauer and Menzel (2003). The effect of flame parameters on silica characteristics is also reasonably well understood. For example, as with TiO_2 , increasing the oxidant flow rate in a diffusion flame dilutes the aerosol and reduces its high-temperature residence time, reducing flame height and primary particle size and increasing the extent of aggregation (Mueller et al., 2004). Similarly, nonaggregated, perfectly spherical fumed silica can be made by replacing oxidant air with O_2 in diffusion flames (Zhu & Pratsinis, 1997). Recently, it has been shown that coagulation and growth of agglomerated fumed silica (e.g., Aerosil or Cab-O-Sil 380, HDK 440) at industrial manufacturing conditions may not follow classic coagulation theory. At high concentrations, these fractal-like particles quickly grow and occupy far more space than dictated by their solid volume fraction, causing their effective volume fraction to increase rapidly and more quickly reach gelation conditions that may force restructuring and fragmentation in industrial aerosol flow reactors (Heine & Pratsinis, 2006). It

should be noted, however, that there is uncertainty about the sintering rate of silica even though expressions have been proposed in the literature (Tsantilis et al., 2001), which is important because detailed aerosol reactor models are developed by combining aerosol and fluid dynamics (Johanessen et al., 2000).

Today, fumed silica consumption is growing at a rate of 4% annually, which is faster than the consumption of any other aerosol-made commodity. Some of the leading manufacturers of fumed silica have established a quantitative understanding of the oxychloride process by interfacing particle dynamics with computational fluid dynamics. That way, the effect of process variables on some fumed silica features can be described in considerable detail (Mühlenweg et al., 2001). Figure 3 pictorially summarizes this understanding, showing how the morphology and primary particle size can be determined by a “cube” of temperature, precursor concentration, and cooling rate. Such diagrams greatly facilitate the design and operation of industrial aerosol reactors, as well as training of personnel, process maintenance, and new product development.

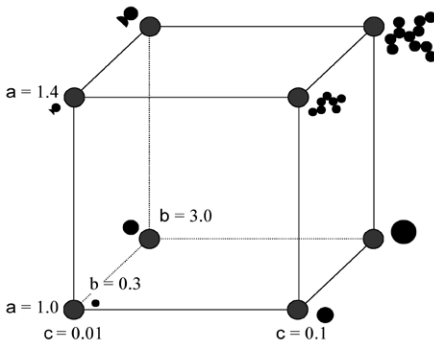

Figure 3. Summary of coupled particle dynamics and fluid mechanic simulations showing qualitatively the conditions for synthesis of particles with selected size and morphology as a function of (a) temperature, (b) cooling rate, and (c) concentration.

Source: Adapted from Mühlenweg et al., 2001.

ZnO, Ni, WC, and Other Materials

ZnO is the fourth largest aerosol-made product by value and the third largest by production volume, with a worldwide annual consumption of about 600,000 tons. Almost all ZnO is made by aerosol processes—the so-called “French” and “American” processes that produce 85% and 14%, respectively, of commercially manufactured ZnO (Bohnet, 2003). The French process was put into industrial practice in 1840, making it the second industrial aerosol material manufacturing process after the lampblack process for carbon black. The difference between the French and American processes lies in how Zn

vapor is generated: by boiling Zn metal (in the French process) or by reducing Zn minerals with coke (in the American process) (Bohnet, 2003). In these processes, Zn vapor is oxidized with air, resulting in micron-sized ZnO particles that are used mostly as accelerators for curing or vulcanizing natural or synthetic rubber.

Despite ZnO's long history of aerosol manufacture, its formation fundamentals have been studied the least (Tani et al., 2002). There is no straightforward way to use the French and American processes to synthesize nanosized ZnO, which has a number of promising applications in microelectronics, quantum dots, UV filters, and other uses. For these applications, ZnO is typically made by wet chemistry (e.g., Meulenkamp, 1998). However, flame technology is capable of making filamentary ZnO (Jensen et al., 2000) with closely controlled crystallite size by SiO₂ doping, exhibiting even quantum dot behavior (Mädler et al., 2002b).

Many sizes and morphologies of Ni powder are made in industrial hot-wall aerosol reactors. Typically, the metal is reacted with CO, forming nickel tetracarbonyl [Ni(CO)₄] that is thermally decomposed in these reactors, resulting in micron and submicron metal particles by nucleation, surface growth, and coagulation (Wasmund & Coley, 2009). This process was developed and patented in Germany in the mid-1920s by A. Mittasch at I. G. Farbenindustrie for producing Fe and Ni equiaxed multi-micron-sized single particles (Trout, 1938). It was later adapted for use at Inco's nickel refinery in the United Kingdom for making products such as Type 255, a filamentary Ni powder that is used to make porous metal electrodes, coatings, and catalysts. Today more than 20,000 tons per year of Ni powder are made by this process, and recent basic understanding of its fundamentals led to synthesis of Ni nanopowders (Wasmund & Coley, 2006). Recent studies in microwave reactors have elucidated the gas-phase synthesis of filamentary Fe nanoparticles from iron pentacarbonyl [Fe(CO)₅] decomposition (Giesen et al., 2004).

Probably the latest success story of aerosol-made materials is the manufacture of ultrafine WC for cutting tools by rapid carbothermal reduction, a process that was originally developed by Dow Chemicals for the manufacture of borides, nitrides, and carbides by pyrolysis of powder mixtures of metal salts and starch flowing down graphite tube reactors heated above 2,000°C and followed by rapid cooling (Weimer et al., 1991; Weimer et al., 1994). Despite the solid precursors employed by this process, the fine structure characteristics of the product powder are determined by coagulation

and sintering, because they can be inferred by the aerosol dynamics of similar carbides such as boron carbide (B_4C) (Xiong et al., 1992b). Likewise, silicon carbide (SiC) grains grow by sintering on the surface of carbon primary particles resulting in SiC that is quite fluffy (Johnson et al., 2002). Today, about 500 tons/year of the world's finest WC are made by rapid carbothermal reduction.

Hot-wall reactors—which use “spray roasting,” “pyrolysis,” or “decomposition” processes—are used to manufacture a spectrum of materials (e.g., ferrites; Li et al., 1993), typically mixed oxides or metal/ceramics. Hot-wall reactors are known for their excellent control of temperature and, as a result, phase composition of the product. For example, Alam and Flagan (1986) first used such reactors for the aerosol synthesis of silicon for semiconductors. Silicon synthesis in such reactors has been scaled up, resulting in aggregated nanoparticles (Knipping et al., 2004), whereas plasma reactors have been used to manufacture nonaggregated luminescent silicon nanoparticles (Mangolini et al., 2005; Gupta et al., 2009), which are being explored by start-ups. Such processes have attracted renewed interest in photovoltaic applications of silicon, and the academic community has studied hot-wall reactors more than any other aerosol reactor because a number of fundamental processes such as nucleation, condensation, evaporation, sintering, and coagulation can be isolated and studied with close control of temperature and residence time for materials synthesis by spray pyrolysis (Kodas & Hampden-Smith, 1999).

Recently, both Cabot and Evonik have begun marketing fumed alumina made by the oxychloride process, similar to SiO_2 and P25 TiO_2 , mostly for chemical-mechanical polishing in microelectronics. A special consideration is that aluminum chloride ($AlCl_3$) vapor is supplied to the process by sublimation. A number of other oxides are possible by this technology, as Kreichbaum and Kleinschmidt (1989) have shown.

Mixed oxides can have some unique properties, such as iron oxide (Fe_2O_3)/ SiO_2 made in a premixed methane (CH_4)- O_2 flame or a H_2 - O_2 -argon (Ar) premixed low-pressure flame. The thermal decomposition of the iron precursor $Fe(CO)_5$ is much faster than the thermal decomposition of the Si-precursor (hexamethyl di-silane [$Si_2(CH_3)_6$] or silane [SiH_4]). Consequently, the iron oxide particles are formed first in the flame and are later encapsulated by SiO_2 . Such powders exhibit superparamagnetic properties and are commercially available (Roth, 2007).

A number of new small start-up companies make fine particles by aerosol technology using flames, plasmas, lasers, and other high-energy sources for specialized applications such as microelectronics, photonics, and nanocomposites. It is worth mentioning Admafine, a joint venture between Toyota and Shin-Etsu, which makes perfectly spherical alumina or silica particles that are 100–500 nm in diameter and are either pure or contain zirconia or titania from combustion and oxidation of metal vapors at very high temperatures. As business interests focus on high-value products, small companies such as Nanogram in Milpitas, California; nGimat in Atlanta, Georgia; Tal in Michigan; and Turbobeads, HeiQ, and Nanograde in Zurich, Switzerland, to name only a few, use flame aerosol technology to make such products. To that effect, combustion of sprays of organic solutions similar to the furnace process for carbon black (Kühner & Voll, 1993) but for ceramics (Sokolowski et al., 1977; Lewis, 1991; Bickmore et al., 1996; Mädler et al., 2002a) and flame pyrolysis of sprays of aqueous solutions of inorganic precursors (Marshall et al., 1971; Purwanto et al., 2008) relieve the constraint of using vaporizable precursors and create unprecedented opportunities for synthesizing sophisticated materials beyond the simple oxides of the recent past (Strobel & Pratsinis, 2007). Most notably, Johnson Matthey, a leading manufacturer of heterogeneous catalysts, actively explores such aerosol technology for synthesizing a wide spectrum of nanomaterials (Figure 4).



Figure 4. A flame aerosol reactor pilot plant at the Johnson Matthey Research Center, UK. This plant offers synthesis of various nanoparticle compositions by flame spray pyrolysis within the NanoCentral alliance (www.nanocentral.eu).

Photo: Courtesy of Dr. Peter Bishop, Johnson-Matthey Co.

Conclusions

Aerosol reactors are used today to manufacture commodities such as carbon blacks, fumed silica, pigmentary titania, ZnO, and filamentary nickel. More than 90% of these products, by both volume and value, are made in flame aerosol reactors that were built initially by persistent engineering with little formal input from aerosol science. Nevertheless, in the last 20 years, significant developments in aerosol and combustion science and engineering have given the design and operation of such reactors a firm scientific basis.

Aerosol science is now challenged to describe the dynamics of ramified or fractal-like aerosol particles from low to high concentrations, as dictated by the economic manufacture of aerosol-made materials. Coagulation and surface growth rates of such particles still need to be better understood, because they determine all particle sizes, especially those of agglomerates. Sintering or coalescence rates also need to be better understood (especially when additives or impurities are present on the particle surface) because they determine primary particle and aggregate diameters that are critical to all applications. Nucleation rates of such materials are also unknown and can be quite important when producing nanoparticles with a diameter of only a few nanometers. For most of these materials made at high production rates, coagulation washes out (so to speak) the effect of nucleation because precursors are rapidly consumed and product particles attain self-preserving distribution by coagulation. Developing aerosol processes and scaling them up would greatly facilitate their adoption for the manufacture of new materials and the devices that contain them.

There is currently a strong interest in aerosol reactors for manufacturing materials and devices, but there has already been a sizeable investment in materials made by conventional (e.g., wet chemistry) routes, so aerosol reactors will not replace these materials overnight. Nevertheless, the capacity of flame spray aerosol reactors (Figure 5), in particular, to form new materials, nanothin hermetically layered particles (Teleki et al., 2008; Phillips et al., 2009; Guo et al., 2010), and even highly porous (98%) nanostructured semiconducting micropatterns on electronic circuitry (Tricoli et al., 2008) creates the opportunity to make products with new properties and functionalities. These products include catalysts (Strobel et al., 2006b), sensors (Tricoli et al., 2010), transparent but radiopaque dental prosthetics (Schulz et al., 2005), phosphor particles (Camenzind et al., 2005; Purwanto et al., 2008) and films (Kubrin et al., 2010), lithium-ion battery materials



Figure 5. A flame spray pyrolysis aerosol reactor at the Swiss Federal Institute of Technology (ETH Zurich) for continuous synthesis of mixed noble metal and ceramic nanopowders up to 1 kg/h.

Photo: Courtesy of the author.

(Ernst et al., 2007), nutritional supplements (Rohner et al., 2007) with rigorous physiological evaluation (Hilty et al., 2010), anti-fogging films made by in situ grown silica nanowires (Tricoli et al., 2009), and even highly durable sorbents for CO₂ sequestration (Lu et al., 2009). Thus, some of these products may soon appear on the market. Furthermore, synthesis of metal and metal alloys, as well as nonoxide ceramics, can be carried out in scalable flame (Athanassiou et al., 2010) and plasma reactors (Phillips et al., 2009) at respectable production rates (Ryu et al., 2010), even in a laboratory-scale (0.5–2 g/min) plasma reactor, promising many opportunities for aerosol technology to contribute to the rapidly evolving field of nanomaterials and its breadth of applications.

Acknowledgments

I acknowledge financial support from the European Research Council, the Swiss National Science Foundation, and the Commission for Technology and Innovation. I also greatly appreciate comments by G. Skillas (Degussa AG), R. Strobel and M. Eggersdorfer (ETH Zurich), G. D. Ulrich (University of New Hampshire), K. Okuyama (University of Hiroshima, Japan), A. Weimer (University of Colorado), E. Wasmund (INCO) and literature suggestions by B. Diemer (DuPont).

References

- Akhtar, M. K., Vemury, S., & Pratsinis, S. E. (1994). The role of electrolytes in aerosol synthesis of TiO_2 . *NanoStructured Materials*, 4, 537–543.
- Alam, M. K., & Flagan, R. C. (1986). Controlled nucleation aerosol reactors—Production of bulk silicon. *Aerosol Science and Technology*, 5(2), 237–248.
- Arabi-Katbi, O. I., Pratsinis, S. E., Morrison, P. W., & Megaridis, C. M. (2001). Monitoring the flame synthesis of TiO_2 particles by in-situ FTIR spectroscopy and thermophoretic sampling. *Combustion and Flame*, 124(4), 560–572.
- Arabi-Katbi, O. I., Wegner, K., & Pratsinis, S. E. (2002). Aerosol synthesis of titania nanoparticles: Effect of flame orientation and configuration. *Annales De Chimie-Science Des Materiaux*, 27(6), 37–46.
- Athanassiou, E. K., Grass, R. N., & Stark, W. J. (2010). Chemical aerosol engineering as a novel tool for material science: From oxides to salt and metal nanoparticles. *Aerosol Science and Technology*, 44(2), 161–172.
- Bickmore, C. R., Waldner, K. F., Treadwell, D. R., & Laine, R. M. (1996). Ultrafine spinel powders by flame spray pyrolysis of a magnesium aluminum double alkoxide. *Journal of the American Ceramic Society*, 79(5), 1419–1423.
- Biskos, G., Vons, V., Yuteri, C. U., & Schmidt-Ott, A. (2008) Generation and sizing of aerosol-based nanotechnology. *Kona Powder and Particle Journal*, 26, 13–35.
- Bohnet, M. (2003). *Ullmann's encyclopedia of industrial chemistry* (6th ed.). Weinheim, Germany: Wiley-VCH.
- Cabot, T. D. (1979). *Beggar on horseback*. Boston, MA: Godine.
- Camenzind, A., Caseri, W. R., & Pratsinis, S. E. (2010). Flame-made nanoparticles for nanocomposites. *Nano Today*, 5(1), 48–65.
- Camenzind, A., Strobel, R., & Pratsinis, S. E. (2005). Cubic or monoclinic Y_2O_3 : Eu^{3+} nanoparticles by one step flame spray pyrolysis. *Chemical Physics Letters*, 416(4–6), 193–197.
- Clark, H. B. (1975). Titanium dioxide pigments. In P. R. Myers & J. S. Long (Eds.), *Treatise on coatings* (pp. 479–532). New York, NY: M. Dekker.

- Clyne, T. W., & Gill, S. C. (1996). Residual stresses in thermal spray coatings and their effect on interfacial adhesion: A review of recent work. *Journal of Thermal Spray Technology*, 5(4), 401–418.
- Collin, G. (2000). On the history of technical carbon. *Ceramic Forum International*, 77(3), 28–35.
- Dobbins, R. A., & Megaridis, C. M. (1987). Morphology of flame-generated soot as determined by thermophoretic sampling. *Langmuir*, 3, 254–259.
- Donnet, J. B., & Bansal, R. C. (1993). Mechanism of carbon black formation. In J. B. Donnet, R. C. Bansal, M. J. Wang, & M. Dekker (Eds.), *Carbon black* (2nd ed., pp. 67–88). New York, NY: CRC Press.
- Ernst, F. O., Kammler, H. K., Roessler, A., Pratsinis, S. E., Stark, W. J., Ufheil, J., & Novak, P. (2007). Electrochemically active flame-made nanosized spinels: LiMn_2O_4 , $\text{Li}_4\text{Ti}_5\text{O}_{12}$ and LiFe_5O_8 . *Materials Chemistry and Physics*, 101(2–3), 372–378.
- Flesch, J., Kerner, D., Riernenschneider, H., & Reirner, R. (2008). Experiments and modeling on the deacidification of agglomerates of nanoparticles in a fluidized bed. *Powder Technology*, 183(3), 467–479.
- Friedlander, S. K. (2000). *Smoke, dust, and haze: Fundamentals of aerosol dynamics* (2nd ed., Topics in Chemical Engineering). New York, NY: Oxford University Press.
- George, A. P., Murley, R. D., & Place, E. R. (1973). Formation of TiO_2 aerosol from combustion supported reaction of TiCl_4 and O_2 . *Faraday Symposium Chemical Society*, 7, 63–71.
- Ghoshtagore, R. N. (1970). Mechanism of heterogeneous deposition of thin film rutile. *Journal of the Electrochemical Society*, 117(4), 529–536.
- Giesen, B., Orthner, H. R., Kowalik, A., & Roth, P. (2004). On the interaction of coagulation and coalescence during gas-phase synthesis of Fe-nanoparticle agglomerates. *Chemical Engineering Science*, 59(11), 2201–2211.
- Grass, R. N., Tsantilis, S., & Pratsinis, S. E. (2006). Design of high-temperature, gas-phase synthesis of hard or soft TiO_2 agglomerates. *AIChE Journal*, 52(4), 1318–1325.

- Guo, B., Yim, H., Khasanov, A., & Stevens, J. (2010). Formation of magnetic Fe₃O₄/Silica core-shell particles in a one-step flame aerosol process. *Aerosol Science and Technology*, 44(4), 281–291.
- Gupta, A., Swihart, M. T., & Wiggers H. (2009). Luminescent colloidal dispersion of silicon quantum dots from microwave plasma synthesis: Exploring the photoluminescence behavior across the visible spectrum. *Advanced Functional Materials*, 19(5), 696–703.
- Gurav, A., Kodas, T., Pluym, T., & Xiong, Y. (1993). Aerosol processing of materials. *Aerosol Science and Technology*, 19(4), 411–452.
- Hannebauer, B., & Menzel, F. (2003). The combustion of SiCl₄ in hot O₂/H₂ flames. *Zeitschrift für anorganische und allgemeine Chemie*, 629, 1485–1490.
- Heine, M. C., & Pratsinis, S. E. (2006). High concentration agglomerate dynamics at high temperatures. *Langmuir*, 22, 10238–10245.
- Heine, M. C., & Pratsinis, S. E. (2007). Agglomerate TiO₂ aerosol dynamics at high concentration. *Particle & Particle Systems Characterization*, 24, 56–65.
- Hilty, F. M., Arnold, M., Hilbe, M., Teleki, A., Knijnenburg, J. T. N., Ehrensberger, F., . . . Zimmermann, M. B. (2010). Iron from nano-structured compounds containing iron and zinc is highly bioavailable in rats, without detectable tissue iron accumulation. *Nature Nanotechnology*, 5, 374–380.
- Hounshell, D. A., & Smith, J. K., Jr. (1988). *Science and corporate strategy: DuPont R&D, 1902–1980*. Cambridge, UK: Cambridge University Press.
- Hunt, A. T., Carter, W. B., & Cochran, J. K. (1993). Combustion chemical-vapor-deposition—A novel thin-film deposition technique. *Applied Physics Letters*, 63(2), 266–268.
- Ivie, J. J., & Forney, L. J. (1988). A numerical-model of the synthesis of carbon-black by benzene pyrolysis. *AIChE Journal*, 34, 1813–1820.
- Jensen, J. R., Johanessen, T., Wedel, S., & Livbjerg, H. (2000). Preparation of ZnO–Al₂O₃ particles in a premixed flame. *Journal of Nanoparticle Research*, 2, 363–373.
- Johannessen, T., Pratsinis, S. E., & Livbjerg, H. (2000). Computational fluid-particle dynamics for the flame synthesis of alumina particles. *Chemical Engineering Science*, 55(1), 177–191.

- Johnson, J. A., Krantz, W. B., Hrenya, C. M., & Weimer, A. W. (2002). Analysis of the rapid carbothermal reduction synthesis of ultra-fine silicon carbide powders. *Aerosol Science and Technology*, 36(12), 1087–1098.
- Kammler, H. K., Beaucage, G., Mueller, R., & Pratsinis, S. E. (2004). Structure of flame-made silica nanoparticles by ultra small-angle X-ray scattering. *Langmuir*, 20, 1915–1921.
- Kingery, W. D., Bowen, H. K., & Uhlmann, D. R. (1976). *Introduction to ceramics*. New York, NY: John Wiley & Sons.
- Knipping, J., Wiggers, H., Rellinghaus, B., Roth, P., Konjhodzic, D., & Meier, C. (2004). Synthesis of high purity silicon nanoparticles in a low pressure microwave reactor. *Journal of Nanoscience and Nanotechnology*, 4(8), 1039–1044.
- Kobata, A., Kusakabe, K., & Morooka, S. (1991). Growth and transformation of TiO₂ crystallites in aerosol reactor. *AIChE Journal*, 37, 347–359.
- Koch, W., & Friedlander, S. K. (1990). The effect of particle coalescence on the surface-area of a coagulating aerosol. *Journal of Colloid and Interface Science*, 140(2), 419–427.
- Kodas, T. T., & Hampden-Smith, M. J. (1999). *Aerosol processing of materials*. New York, NY: Wiley-VCH.
- Kriechbaum, G. W., & Kleinschmit, P. (1989). Superfine oxide powders—Flame hydrolysis and hydrothermal synthesis. *Angewandte Chemie-International Edition in English*, 28(10), 1416–1423.
- Kubrin, R., Tricoli, A., Camenzind, A., Pratsinis, S. E., & Bauhofer, W. (2010). Flame aerosol deposition of Y₂O₃:Eu nanophosphor screens and their photoluminescent performance. *Nanotechnology*, 21(22), 225603. doi: 10.1088/0957-4484/21/22/225603
- Kuhlbusch, T. A. J., & Fissan, H. (2006). Particle characteristics in the reactor and pelletizing areas of carbon black production. *Journal of Occupational and Environmental Hygiene*, 3(10), 558–567.
- Kühner, G., & Voll, M. (1993). Manufacture of carbon black. In J. B. Donnet, R. C. Bansal, M. J. Wang, & M. Dekker (Eds.), *Carbon black* (2nd ed., pp. 1–66). New York, NY: CRC Press.

- Lai, F. S., Hidy, G. M., Friedlander, S. K., & Pich, J. (1972). Self-preserving particle-size distribution for Brownian coagulation in free-molecule regime. *Journal of Colloid and Interface Science*, 39(2), 395–405.
- Lewis, D. J. (1991). Technique for producing mullite and other mixed-oxide systems. *Journal of the American Ceramic Society*, 74(10), 2410–2413.
- Li, Q., Sorensen, C. M., Klabunde, K. J., & Hadjipanayis, G. C. (1993). Aerosol spray-pyrolysis synthesis of magnetic manganese ferrite particles. *Aerosol Science and Technology*, 19(4), 453–467.
- Lindackers, D., Strecker, M. G. D., & Roth P. (1994). Particle formation behavior in H_2/O_2 low-pressure flames doped with SiH_4 and $TiCl_4$. *Nanostructured Materials*, 4, 545–550.
- Lu, H., Khan, A., Pratsinis, S. E., & Smirniotis, P. G. (2009). Flame-made durable doped-CaO nanosorbents for CO_2 capture. *Energy & Fuels*, 23, 1093–1100.
- Mädler, L., Kammler, H. K., Mueller, R., & Pratsinis, S. E. (2002a). Controlled synthesis of nanostructured particles by flame spray pyrolysis. *Journal of Aerosol Science*, 33, 161–181
- Mädler, L., Stark, W. J., & Pratsinis, S. E. (2002b). Rapid synthesis of stable ZnO quantum dots. *Journal of Applied Physics*, 92, 6537–6540.
- Mandelbrot, B. B. (1982). *The fractal geometry of nature*. San Francisco, CA: Freeman.
- Mangolini, L., Thimsen, E., & Kortshagen, U. (2005). High-yield plasma synthesis of luminescent silicon nanocrystals. *Nano Letters*, 5(4), 655–659.
- Marshall, B. S., Telford, I., & Wood, R. (1971). A field method for the determination of zinc oxide fume in air. *Analyst*, 96, 569–578.
- Medalia, A. I., & Heckman, F. A. (1969). Morphology of aggregates—II. Size and shape factors of carbon black aggregates from electron microscopy. *Carbon*, 7, 567–582.
- Meulenkamp, E. A. (1998). Synthesis and growth of ZnO nanoparticles. *Journal of Physical Chemistry B*, 102(29), 5566–5572.
- Mezey, E. J. (1966). Pigments and reinforcing agents. In C. F. Palmer, J. H. Oxley, & J. M. Blocher (Eds.), *Vapor deposition*. New York, NY: John Wiley & Sons.

- Mueller, R., Kammler, H. K., Pratsinis, S. E., Vidal, A., Beaucage, G., & Burtscher, P. (2004). Non-agglomerated dry silica nanoparticles. *Powder Technology*, 140, 40–48.
- Mühlenweg, H., Gutsch, A., Schild, A., Riest, K., & Becker, C. (2001). Simulation for process and product optimization. In A. Vidal & B. Haidar (Eds.), *Silica 2001*. Mulhouse, France: Institut de Chimie des Surfaces et Interfaces.
- Phillips, J., Luhrs, C. C., & Richard, M. (2009). Review: Engineering particles using the aerosol-through-plasma method. *IEEE Transactions on Plasma Science*, 37(6), 726–739.
- Pratsinis, S. E. (2010). Aerosol-based technologies in nanoscale manufacturing: From functional materials to devices through core chemical engineering. *AIChE Journal*, 56(12), 3028–3035.
- Pratsinis, S. E. (1998). Flame aerosol synthesis of ceramic powders. *Progress in Energy and Combustion Science*, 24(3), 197–219.
- Pratsinis, S. E., Bai, H., Biswas, P., Frenklach, M., & Mastrangelo, S. V. R. (1990). Kinetics of TiCl_4 oxidation. *Journal of the American Ceramics Society*, 73, 2158–2162.
- Pratsinis, S. E., & Mastrangelo, S. V. R. (1989). Material synthesis in aerosol reactors. *Chemical Engineering Progress*, 85(5), 62–66.
- Pratsinis, S. E., Zhu, W. H., & Vemury, S. (1996). The role of gas mixing in flame synthesis of titania powders. *Powder Technology*, 86(1), 87–93.
- Purwanto, A., Wang, W. N., Ogi, T., Lenggoro, I. W., Tanabe, E., & Okuyama, K. (2008). High luminance YAG:Ce nanoparticles fabricated from urea added aqueous precursor by flame process. *Journal of Alloys and Compounds*, 463(1–2), 350–357.
- Righettoni, M., Tricoli, A., & Pratsinis, S. E. (2010). Si:WO_3 sensors for highly selective detection of acetone for easy diagnosis of diabetes by breath analysis. *Analytical Chemistry*, 82(9), 3581–3587.
- Rohner, F., Ernst, F. O., Arnold, M., Hibe, M., Biebinger, R., Ehrensperger, F., . . . Zimmermann, M. B. (2007). Synthesis, characterization, and bioavailability in rats of ferric phosphate nanoparticles. *Journal of Nutrition*, 137(3), 614–619.

- Rosner, D. E. (1997). Combustion synthesis and materials processing. *Chemical Engineering Education*, 31, 228–235.
- Roth, P. (2007). Particle synthesis in flames. *Proceedings of the Combustion Institute*, 31, 1773–1788.
- Rowell, J. M. (1986). Photonic materials. *Scientific American*, 255(4), 146–157.
- Ryu, T., Choi, Y. J., Hwang, S., Sohn, H. Y., & Kim, I. (2010). Synthesis of yttria-stabilized zirconia nanopowders by a thermal plasma process. *Journal of the American Ceramic Society*, 93, 3130–3135.
- Schulz, H., Madler, L., Pratsinis, S. E., Burtscher, P., & Mozner, N. (2005). Transparent nanocomposites of radiopaque, flame-made Ta₂O₅/SiO₂ particles in an acrylic matrix. *Advanced Functional Materials*, 15, 830–837.
- Semaltianos, N. G. (2010). Nanoparticles by laser ablation. *Critical Reviews in Solid State and Materials Sciences*, 35(2), 105–124.
- Skillas, G., Becker, C., Muhlenweg, H., & Behnisch, J. (2005). Simulation of particulates in a carbon black reactor. *Journal of Nanoparticle Research*, 7, 15–27.
- Sokolowski, M., Sokolowska, M., Michalski, A., & Gokieli, B. (1977). The in-flame-reaction method for Al₂O₃ aerosol formation. *Journal of Aerosol Science*, 8, 219–229.
- Spicer, P., Chaoul, O., Tsantilis, S., & Pratsinis, S. E. (2002). Titania formation by TiCl₄ gas phase oxidation, surface growth and coagulation. *Journal of Aerosol Science*, 33, 17–34.
- Stamatakis, P., Natalie, C. A., Palmer B. R., & Yuill, W. A. (1991). Research needs in aerosol processing. *Aerosol Science and Technology*, 14, 316–321.
- Stark, W. J., Baiker, A., & Pratsinis, S. E. (2002). Nanoparticle opportunities: Pilot-scale flame synthesis of vanadia/titania catalysts. *Particle & Particle Systems Characterization*, 19(5), 306–311.
- Stark, W. J., Wegner, K., Pratsinis, S. E., & Baiker, A. (2001). Flame aerosol synthesis of vanadia-titania nanoparticles: Structural and catalytic properties in the selective catalytic reduction of NO by NH₃. *Journal of Catalysis*, 197(1), 182–191.
- Strobel, R., Baiker, A., & Pratsinis, S. E. (2006b). Aerosol flame synthesis of catalysts. *Advanced Powder Technology*, 17(5), 457–480.

- Strobel, R., Maciejewski, M., Pratsinis, S. E., & Baiker, A. (2006a). Unprecedented formation of metastable monoclinic BaCO₃ nanoparticles. *Thermochimica Acta*, 445(1), 23–26.
- Strobel, R., & Pratsinis, S. E. (2007). Flame aerosol synthesis of smart nanostructured materials. *Journal of Materials Chemistry*, 17(45), 4743–4756.
- Swihart, M. T. (2003). Vapor-phase synthesis of nanoparticles. *Current Opinion in Colloid & Interface Science*, 8(1), 127–133.
- Tani, T., Mädler, L., & Pratsinis, S. E. (2002). Homogeneous ZnO nanoparticles. *Journal of Nanoparticle Research*, 4, 337–343.
- Teleki, A., Heine, M. C., Krumeich, F., Akhtar, M. K., & Pratsinis, S. E. (2008). In-situ coating of flame-made TiO₂ particles by nanosized SiO₂ films. *Langmuir*, 24, 12553–12558.
- Teoh, W. Y., Amal, R., Madler, L., & Pratsinis, S. E. (2007). Flame sprayed visible light-active Fe-TiO₂ for photomineralisation of oxalic acid. *Catalysis Today*, 120(2), 203–213.
- Tricoli, A., Graf, M., Mayer, F., Kühne, S., Hierlemann, A., & Pratsinis, S. E. (2008). Micropatterning layers by flame aerosol deposition-annealing. *Advanced Materials*, 20(16), 3005–3010.
- Tricoli, A., Righettoni, M., & Pratsinis, S. E. (2009). Anti-fogging nanofibrous SiO₂ and nanostructured SiO₂-TiO₂ films made by rapid flame deposition and in-situ annealing. *Langmuir*, 25, 12578–12584.
- Tricoli, A., Righettoni, M., & Teleki, A. (2010). Semiconducting gas sensors: dry synthesis and applications. *Angewandte Chemie-International Edition in English*, 49(42), 7632–7659.
- Trout, W. E. (1938). The metal carbonyls. VII. Industrial significance. *Journal of Chemical Education*, 15(3), 113–121.
- Tsantilis, S., Briesen, H., & Pratsinis, S. E. (2001). Sintering time for silica particle growth. *Aerosol Science and Technology*, 34(3), 237–246.
- Tsantilis, S., Kammler, H. K., & Pratsinis, S. E. (2002). Population balance modeling of flame synthesis of titania nanoparticles. *Chemical Engineering Science*, 57(12), 2139–2156.
- Tsantilis, S., & Pratsinis, S. E. (2004). Soft- and hard-agglomerate aerosols made at high temperatures. *Langmuir*, 20, 5933–5939.

- Ulrich, G. D. (1971). Theory of particle formation and growth in oxide synthesis flames. *Combustion Science and Technology*, 4(2), 47–57.
- Ulrich, G. D. (1984). Flame synthesis of fine particles. *Chemical & Engineering News*, 62(32), 22–29.
- van Erven, J., Munao, D., Fu, Z., Trzeciak, T., Janssen, R., Kelder, E., & Marijnissen, J. C. M. (2009). The improvement and upscaling of a laser chemical vapor pyrolysis reactor. *Kona Powder and Particle Journal*, 27, 157–173.
- Vollath, D. (2007). Plasma synthesis of nanoparticles. *Kona Powder and Particle Journal*, 25, 39–55.
- Wang, M.-J., Gray, C. A., Resnek, S. A., Khaled, M., & Kutsovsky, Y. (2004). Carbon black. In J. I. Kroschwitz & A. Seidel (Eds.), *Kirk-Othmer Encyclopedia of Chemical Technology* (5th ed., pp. 761–803). Hoboken, NJ: Wiley-Interscience.
- Wasmund, E. B., & Coley, K. (2009). A study of nucleation and the early stage of growth of nickel powder from a vapour nickel carbonyl precursor. *Chemical Engineering Science*, 64(10), 2353–2360.
- Wasmund, E. B., & Coley, K. S. (2006). In situ sampling uncovers the dynamics of particle genesis and growth in an aerosol tube reactor. *Journal of Materials Science*, 41(21), 7103–7110.
- Wegner, K., & Pratsinis, S. E. (2003a). Scale-up of nanoparticle synthesis in diffusion flame reactors. *Chemical Engineering Science*, 58(20), 4581–4589.
- Wegner, K., & Pratsinis, S. E. (2003b). Nozzle quenching process for controlled flame synthesis of titania nanoparticles. *AIChE Journal*, 49(7), 1667–1675.
- Weimer, A. W., Moore, W. G., Rafaniello, W., & Roach, R. P. (1994). *U.S. Patent No. 5,340,417*. Washington, DC: U.S. Patent and Trademark Office.
- Weimer, A. W., Roach, R. P., Haney, C. N., Moore, W. G., & Rafaniello, W. (1991). Rapid carbothermal reduction of boron-oxide in a graphite transport reactor. *AIChE Journal*, 37(5), 759–768.
- West, R. H., Shirley, R. A., Kraft, M., Goldsmith, C. F., & Green, W. H. (2009). A detailed kinetic model for combustion synthesis of titania by TiCl_4 oxidation. *Combustion and Flame*, 156(9), 1764–1770.

- White, L. J., & Duffy, G. J. (1959). Vapor-phase production of colloidal silica. *Industrial and Engineering Chemistry*, 51(3), 232–238.
- Wiseman, T. J. (1976). Inorganic white pigments. In G. D. Parfitt & K. S. W. Sing (Eds.), *Characterization of powder surfaces*. London, UK: Academic Press.
- Wooldridge, M. S. (1998). Gas-phase combustion synthesis of particles. *Progress in Energy and Combustion Science*, 24(1), 63–87.
- Xiong, Y., Akhtar, M. K., & Pratsinis, S. E. (1993). Formation of agglomerate particles by coagulation and sintering. II. The evolution of the morphology of aerosol made titania, silica and silica-doped titania. *Journal of Aerosol Science*, 24, 301–313.
- Xiong, Y., & Pratsinis, S. E. (1991). Gas-phase production of particles in reactive turbulent flows. *Journal of Aerosol Science*, 22(5), 637–655.
- Xiong, Y., Pratsinis, S. E., & Mastrangelo, S. V. R. (1992a). The effect of ionic additives on aerosol coagulation. *Journal of Colloid and Interface Science*, 153(1), 106–117.
- Xiong, Y., Pratsinis, S. E., & Weimer, A. W. (1992b). Modeling of the formation of boron carbide particles in an aerosol flow reactor. *AIChE Journal*, 38, 1685–1692.
- Zhu, W., & Pratsinis, S. E. (1996). Flame synthesis of nanosize particles: Effect of flame configuration and oxidant composition. In G. M. Chow & K. E. Gonsalves (Eds.), *Nanotechnology, ACS Symposium Series G* (Vol. 622, pp. 64–78). Washington, DC: American Chemical Society.
- Zhu, W., & Pratsinis, S. E. (1997). Synthesis of SiO₂ and SnO₂ particles in diffusion flame reactors. *AIChE Journal*, 43(Suppl. 11A), 2657–2664.

History of Virtual Impactors

Virgil A. Marple and Bernard A. Olson

Introduction

The virtual impactor is a subclass of the conventional inertial impactor. The conventional impactor accelerates a jet of air through a nozzle and directs it at an impaction plate, as Figure 1A shows. The impactor will separate particles with sufficient inertia from the air stream; these particles will then impact on the impaction plate. A virtual impactor replaces the impaction plate with a collection probe, as Figure 1B shows; it separates the particles that would be collected on the impaction plate of a conventional impactor from the air stream inside the collection probe and flushes them out of the collection probe with a small fraction of the total flow (i.e., the “minor flow”). The larger portion of the flow (i.e., the “major flow”) passes out the side of the virtual impactor, carrying with it particles too small to be captured in the minor flow.

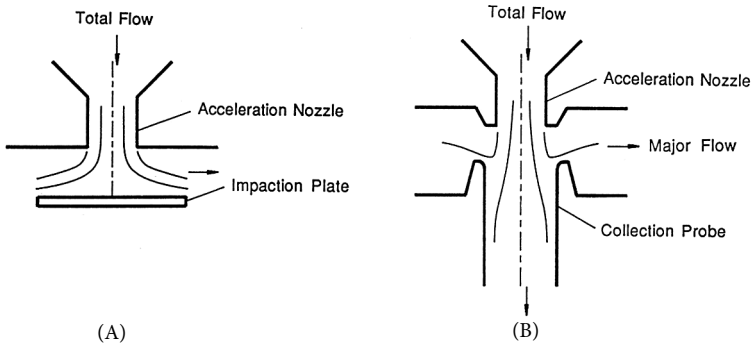

Figure 1. (A) Conventional plate (or jet) impactor and (B) virtual impactor.

In the limited number of pages that this book can allot to describing the history of virtual impactors, it would be impossible to list and discuss every paper that has been written on virtual impactors. In the interest of covering virtual impactor history and not performing a total review of virtual

impactors, we have limited the time span of our history from the origin of virtual impactors through the year 2000. Thus, this chapter investigates the origin of the virtual impactor, reviews some studies on the general flow fields and particle collection characteristics, discusses problem areas and unique variations that make the virtual impactor an interesting and versatile particle sampler, and finally, explores the role of the virtual impactor as a particle concentrator.

Origin of the Virtual Impactor

Many papers written on virtual impactors credit the centripeter with being the first virtual impactor (Hounam & Sherwood, 1965). However, according to David Ensor (personal communication, February 2, 2006), the centripeter may not have been the original virtual impactor but just the first such device to be reported in the literature; also, as we explain in this chapter, the centripeter itself is not a virtual impactor. Ensor's communication states:

I had a discussion on that topic [the origin of virtual impactor] with Bill Conner about 20 years ago. Bill said that the assignment to make a particle separator was his first when he started with the USPHS [US Public Health Service] in the early 1960s. He also said that he successfully developed the device but did not publish anything for a few years. He also claimed that Hounam visited his lab in Cincinnati, got all excited about his device and got inspired to develop the Centripeter. Further, Conner claimed that the reason that he finally published in 1966 was because Hounam published the Centripeter paper based on extending Conner's unpublished idea. (Ensor, personal communication, February 2, 2006)

Investigation into the centripeter article (Hounam & Sherwood, 1965) and the article by Conner (1966) indicates that Conner's claim is probably correct. For example, Conner's paper describes an analysis of particle trajectories and states that "the converging air entering the tube tends to throw the larger particles toward the axis of the tube." He also shows that a perfectly sharp cut can be obtained if all particles are on the centerline of the flow. The centripeter article indicates that focusing the large particles into the center of the flow and then collecting only the particles near the centerline are the goals of the centripeter design. Figure 2 and the following statement illustrate these goals:

Fine particles will travel with the air stream, while coarse particles originally on the axis of the orifice will be carried in the center of the stream and be trapped in the nozzle. Coarse particles approaching the orifice radially will be carried by their momentum across the flow lines to the axis of the orifice and again be collected in the nozzle. (Hounam & Sherwood, 1965)

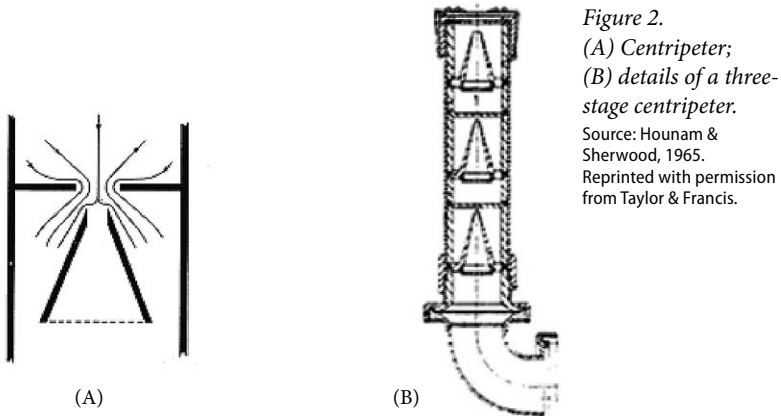

Figure 2.
(A) Centripeter;
(B) details of a three-stage centripeter.
Source: Hounam & Sherwood, 1965.
Reprinted with permission from Taylor & Francis.

Figure 2 also shows that each stage of the centripeter actually comprises a focusing lens followed by a centerline particle skimmer; thus, the centripeter is not a virtual impactor as Baron and Willeke (2001) define it in Appendix A (glossary of terms) of their book *Aerosol Measurement*. This definition states that a virtual impactor is

a device in which particles are removed by impacting them through a virtual surface into a stagnant volume, or a volume with a slowly moving air flow, so that large particles remain in this volume, while smaller particles are deflected with the bulk of the original air flow. (Baron & Willeke, 2001)

The diameters of the collection probes of the centripeter are half the diameter of the nozzles for all stages, and the collection probe does not create the virtual surface below the nozzle that the definition for virtual impactors describes. Thus, the centripeter is not a virtual impactor but a series of particle-focusing lenses with centerline particle skimmers. Hounam and Sherwood do not claim that the centripeter is the instrument described in Conner's paper, which is a virtual impactor, but authors of subsequent papers on virtual impactors have erroneously referred to the centripeter as a virtual impactor.

We have concluded that the instrument described by Conner (1966), shown in Figure 3, is the original virtual impactor.

The name “virtual impactor” was not given to this device until later. The US Army coined the term when they were testing a particle concentrator, built by the Environmental Research Corporation (ERC), that was based on a particle classifier similar to the device described by Conner (C. Peterson, personal communication, February 2006). This device (Figure 4) was later studied by Dzuby and Stevens (1975) for application as an ambient sampler and became the first dichotomous sampler. The development of this sampler eventually led to the widely used dichotomous virtual impactor sampler developed by Loo et al. (1976), shown in Figure 5, for large-scale monitoring of airborne particulate matter. This sampler is probably the most widely used virtual impactor and has been the subject of several studies and reviews

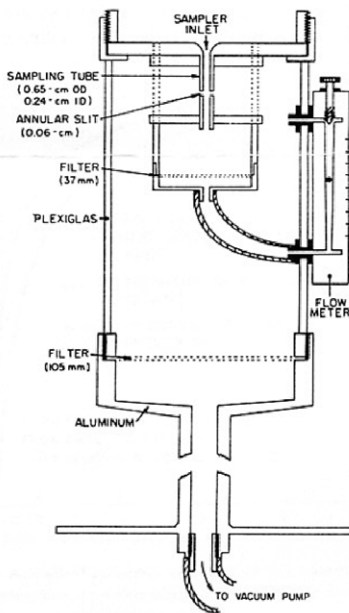

Figure 3. Conner's inertial-type particle separator for collecting large samples (the first virtual impactor).

Source: Conner, 1966. Reproduced with permission from the Air and Waste Management Association, *Journal of the Air Pollution Control Association*. Permission via the Copyright Clearance Center.

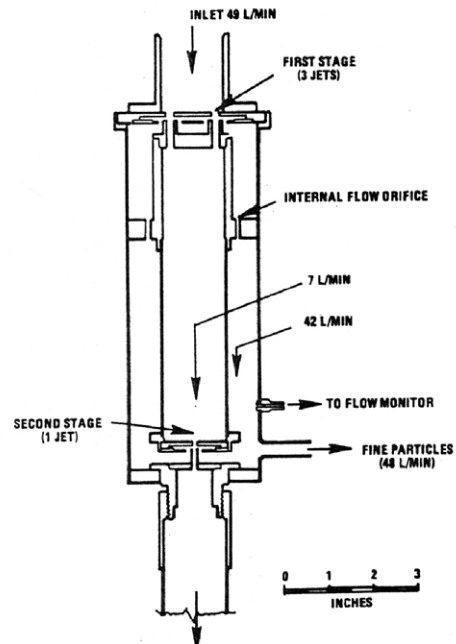

Figure 4. First virtual impactor-based dichotomous sampler.

Source: Dzuby & Stevens, 1975. Reprinted with permission from the American Chemical Society.

(Loo & Jaklevic, 1974, 1979; Loo et al., 1976; Loo & Cork, 1988; McFarland et al., 1978; US Patent No. 4,301,002, 1981). Thus, between 1966 and 1976, the virtual impactor went from a discovery to a widespread application in a network of ambient air samplers.

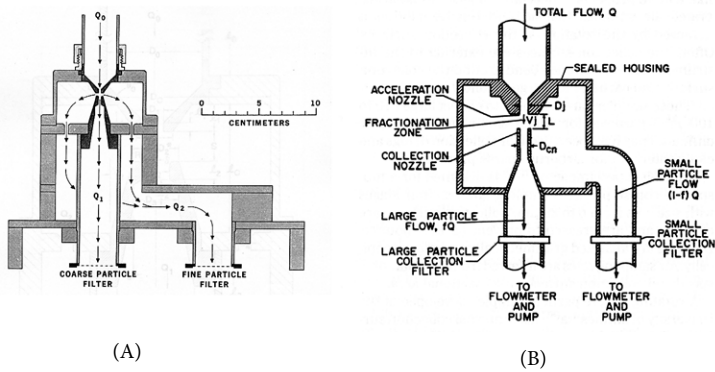

Figure 5. Dichotomous virtual impactor sampler.

Source: (A) Loo et al. 1976; (B) McFarland et al. 1978.

General Studies of Virtual Impactors

Some studies have examined how certain parameters (airflow and geometry) affect the separation of particles in a virtual impactor. These parameters include a wide variety of geometric parameters, the flow split ratio between the minor and major flows, and the Reynolds number of the flow through the acceleration nozzle.

Forney and co-workers studied the influence of flow field and slit virtual impactors on particle separation (Forney, 1976; Forney et al., 1978, 1982; Ravenhall et al., 1978). They assumed ideal fluid flow and used a coordinate transformation technique to map the flow field and a water model with dye streamlines to trace the flow streamlines. Han and Moss (1997) conducted a water model flow visualization study of round nozzle virtual impactors. Although their work was to study clean core virtual impactors, figures in the article provide insight into the flow fields in round nozzle virtual impactors.

A theoretical analysis of round nozzle virtual impactors, performed by Marple and Chien (1980), solved the complete Navier-Stokes equations using computational fluid dynamics (CFD) analysis to determine the flow fields.

They then traced particle trajectories through these flow fields by numerically solving the particle equations of motion, using a Runge-Kutta integration technique. This technique allowed Marple and Chien to determine the particle collection efficiencies in the minor flow and major flow, as well as wall losses. Upon developing this analysis technique, Marple and Chien performed a parametric study to determine the influence of parameters, such as jet Reynolds number, minor flow rate ratio, collection probe/nozzle diameter ratio, nozzle length, entrance cone angle, nozzle-to-collection probe distance, and several collection probe entrance configurations on the minor flow and major flow particle collection efficiency and wall loss curves.

Loo and Cork (1988) conducted an experimental study on the effect of geometric configurations on the performance of the $2.5\ \mu\text{m}$ dichotomous sampler. They investigated the effect of 27 geometric parameters on the particle collection efficiency curves and on particle losses within the virtual impactor.

Xu (1991) studied the effect of nozzle and collection probe design and minor flow ratio on the performance of round jet virtual impactors. His basic test apparatus, shown in Figure 6, consisted of a frame in which he could insert different nozzles and collection probes and then determine the particle losses for these two components as well as the particle collection curves.

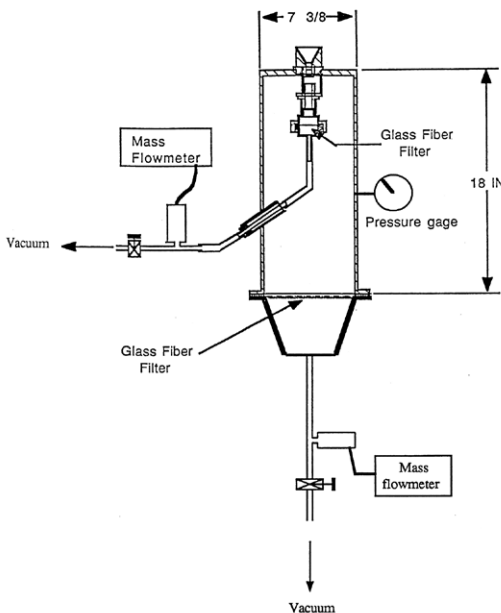

Figure 6. Test apparatus for evaluating different nozzle/collection probe designs.
Source: Xu, 1991.

Problem Areas of Virtual Impactors and Solutions

The virtual impactor was developed to sample large quantities of particles without the problems of particle bounce and fragile particle shattering inherent to traditional impactors. However, the virtual impactor has its own problems, including internal particle losses and contamination of the large particle fraction with small particles in the minor flow. For example, if the minor flow is 10 percent of the total flow, 10 percent of the small particles end up in the minor flow with the large particle fraction, essentially “contaminating” the large particle fraction with small particles.

Internal Losses

The problem of internal losses, which normally occur in the entrance of the collection probe or on the backside of the nozzle, cannot be completely eliminated. However, proper design of the virtual impactor components can reduce internal losses. For example, Loo and Cork (1988) identified 27 geometric parameters in the design of the virtual impactor. They suggested ranges for these parameters that would optimize the virtual impactor design; however, because this work was based around the design of a single instrument operation at a single total flow rate and minor flow rate (i.e., the dichotomous sampler), only a limited number of his suggested parametric ranges could be used in general virtual impactor designs. Xu (1991) studied Loo’s design and concluded that Loo’s design appeared to be optimized for minimum collection probe tip losses, whereas nozzle backside losses increased with decreasing minor flow rate ratio. Xu was able to solve this problem using a protruding nozzle (Figure 7). This modification allowed the small particles exiting the collection probe to reduce their velocity so that they would not impact on the backside of the nozzle.

Losses can also occur in the minor flow cavity. The minor flow propels large particles into this cavity at high speeds. If the cavity is not sufficiently long, the particles will impact on the surface opposite the exit of the collection

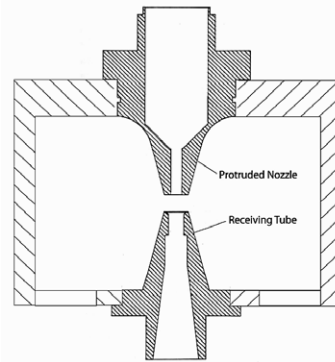

Figure 7. Protruded nozzle.

Source: Xu, 1991.

probe. One solution is to make the minor flow cavity long enough so that the large particles will slow and not impact. This solution results in a rather large virtual impactor minor flow cavity. Another solution to this problem is to use a pair of virtual impactor nozzle/collection probe sets configured so that the outlets of the two collection probes are directed at each other. This was the solution devised by Marple et al. (1990) in the high-volume virtual impactor (HVVI) (Figure 8); this solution allowed for a $2.5\ \mu\text{m}$ cut size, 40 cfm virtual impactor with a size of only $16.4 \times 17.1 \times 12.1\ \text{cm}$. The HVVI was developed for the US Environmental Protection Agency (EPA) for the separation of wood smoke from ambient aerosols in areas in which there were considerable rates of residential fireplace wood burning. Figure 8 also shows that 12 virtual impactor nozzle/collection probe pairs are incorporated in one body. This design is unique in that it includes flow restrictors at the exit of the collection probes so that the minor flow is distributed evenly across the 12 collection probes. Also, multiple nozzles on a single stage, compared with a single nozzle with the same cut size, will have a smaller pressure drop. Marple et al. (1990) showed that the pressure drop is inversely proportional to the number of nozzles to the $2/3$ power.

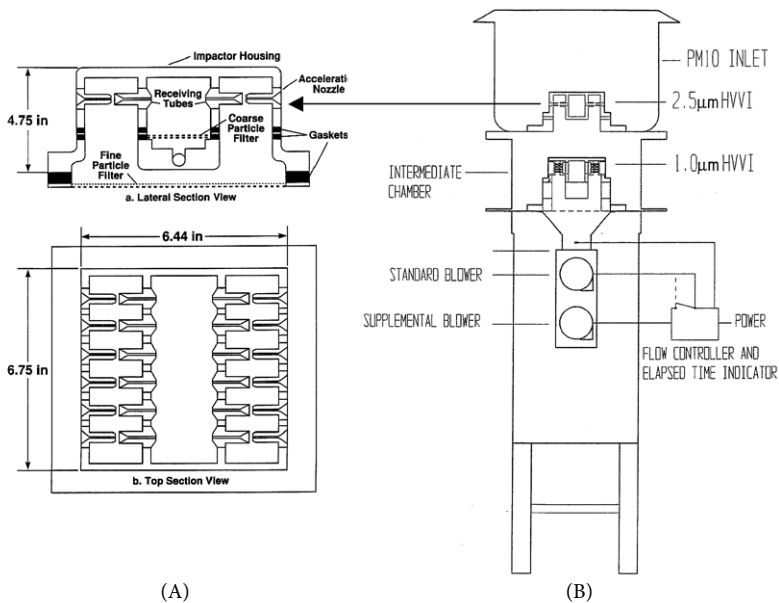

Figure 8. (A) High-volume virtual impactor; (B) high-volume $\text{PM}_{10/2.5/1.0}$ trichotomous sampler.

Source: (A) Marple et al., 1990. Reproduced with permission from the Air and Waste Management Association, *Journal of the Air Pollution Control Association*. Permission via the Copyright Clearance Center. (B) Marple & Olson, 1995.

Contamination of Large Particle Fraction by Small Particles

Several widely different approaches can address the problem of small particle contamination in the minor flow. The most obvious solution is to reduce the minor flow ratio. Xu (1991) showed that this was feasible by operating his apparatus at minor flow ratios as low as 0.05 percent. He concluded that 0.1 percent was the practical lower limit.

Another technique is to provide for a core of particle-free air in the center of the flow passing through the nozzle (Masuda et al., 1979; Chen & Yeh, 1987; Chein & Lundgren, 1993; Li & Lundgren, 1997). The clean core virtual impactor designed by Masuda et al. (1979) is shown in Figure 9. With this technique, no small particles enter the minor flow. However, the design of the sampler is much more complex because filtered clean air must be provided at the center of the nozzle; thus, this technique is not practical for multiple nozzle samplers or cascade samplers. The Masuda virtual impactor also introduces a sheath of clean air along the surface of the nozzle. This keeps particles out of the boundary layer along the wall and should provide for sharper efficiency curves and fewer particle losses on the walls of the nozzle.

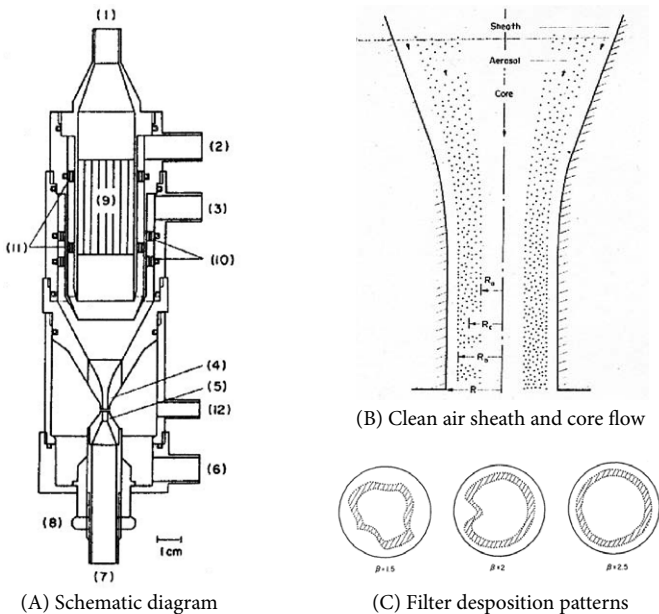

Figure 9. Virtual impactor with a core of clean air to eliminate small particles in the minor flow and a sheath to reduce particle losses.

Source: Masuda et al., 1979. Reprinted with permission from Elsevier.

A third technique is to determine the concentration of the small particles in the major flow and subtract these results from the results of the minor flow. This was used extensively in the high-volume $PM_{10/2.5/1.0}$ trichotomous sampler, shown in Figure 8b (Marple & Olson, 1995). This sampler determines whether the particles in the 1.0 to 2.5 μm range have the same chemical composition as the particles in the 2.5 to 10 μm size range or in the less than 1.0 μm size range. Thus, the chemical composition of the small particle contamination in the minor flow is important. To solve the problem, the sampler collects particles from the major flow with filters made of the same material and having the same flow rate as the filters used to collect the minor flow particles. One can then subtract the quantity of material captured in the filters in the major flow stream from that captured from the minor flow filter, effectively negating the influence of the small contaminate particles that exist in the minor flow.

Unique Designs and Applications of the Virtual Impactor Classifier

Virtual impactors have been used for some special applications besides particle sampling or particle concentrating. Three types of specialty virtual impactors are multistage (cascade) virtual impactors, cascade impactors used as aerosol generators, and virtual impactors used to deliver respirable particle classification for analysis.

Cascade Virtual Impactors

Novick and Alvarez (1987) designed and calibrated a 2 L/min, two-stage cascade virtual impactor as an alternative to conventional cascade impactors. This sampler, shown in Figure 10, allows for three size classes (two virtual impactor minor flows and an after filter) to be collected on one plane. Novick and Alvarez compared the size distribution defined by the cascade virtual impactor with that of a real cascade impactor and found fairly good agreement in the mass median aerodynamic diameter (MMAD) and the geometric standard deviation (GSD). Although this was only a two-stage sampler, Novick and Alvarez indicated that more stages could be easily added.

Liu et al. (1991) designed and tested the shuttle particle sampler, a somewhat different configuration of a cascade virtual impactor, shown in Figure 11. The cut sizes were 10 and 2.5 μm at a flow rate of 12 L/min. The Space Shuttle *Columbia* used this sampler on board to determine the size of particles that existed inside the shuttle cabin during zero gravity conditions. Liu et al.

collected the particles from the two minor flows and the after filter on filters to determine the particle size distribution and to identify particles by scanning electron microscopy (SEM) and energy dispersive spectroscopy (EDS).

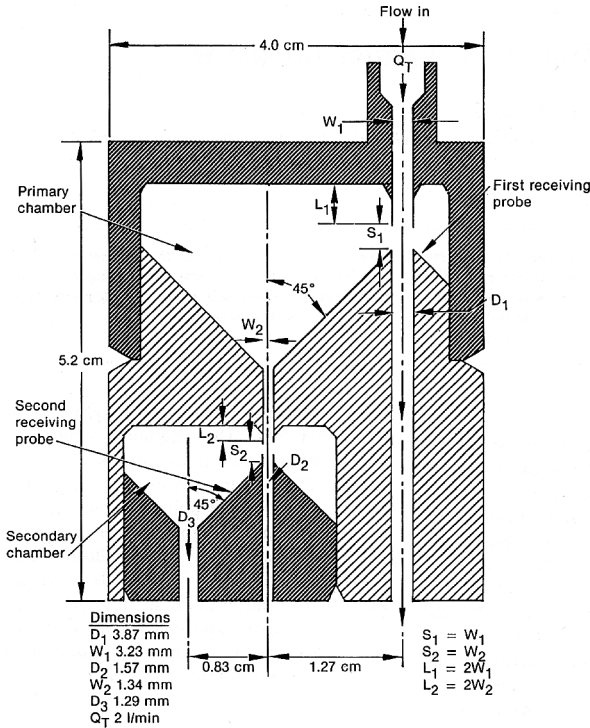
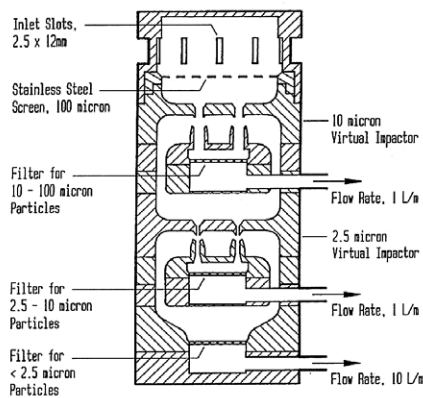
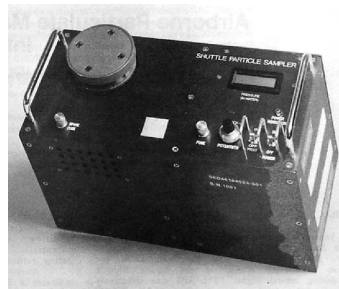

Figure 10. Two-stage cascade impactor. Source: Novick & Alvarez, 1987.



(A) Schematic diagram



(B) Enclosure

Figure 11. Virtual impactor used in the Space Shuttle Columbia.

Source: Liu et al., 1991. Reprinted with permission from SAE paper 911476 © 1991 SAE International.

Another cascade virtual impactor, the Respicon, was a personal sampler with time-resolved concentration monitoring designed to provide cuts corresponding to the total, thoracic, and respirable size cuts (Koch et al., 1999; Figure 12). The instrument combined inertial classification, filter sampling, and photometric aerosol detection. It consisted of a two-stage virtual impactor with cut sizes of 4 and 10 μm , three filters, three light-scattering photometers; the instrument operated at a flow rate of 3.1 L/min. Koch et al. calibrated the optical sensors in situ, using the mass concentrations obtained gravimetrically from the filter samples.

The high-volume $\text{PM}_{10/2.5/1.0}$ trichotomous sampler (Marple & Olson, 1995), shown in Figure 8 and discussed earlier, was also a cascade virtual impactor with cut sizes of 2.5 and 1.0 μm at 1,200 L/min. This sampler was a modified Andersen high-volume sampler and was used for ambient sampling.

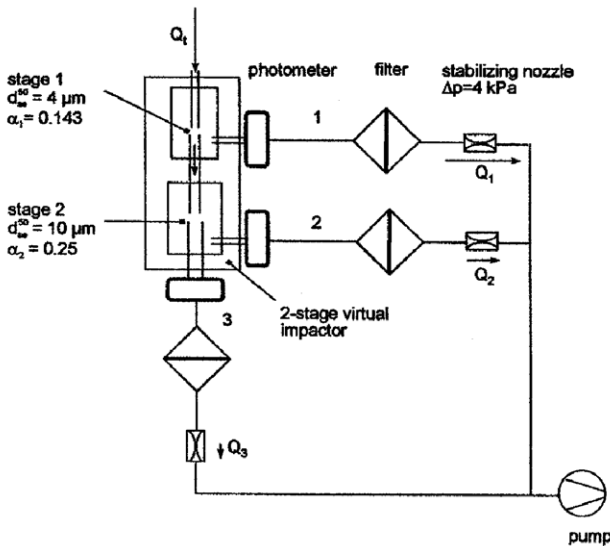

Figure 12. Schematic diagram of Respicon cascade virtual impactor.

Source: Koch et al., 1999.

Virtual Impactors for Sampling in Dieselized Coal Mines

Diesel powered coal-mining equipment, with the exhaust passing through scrubbers, emitted exhaust particles from the scrubbers that were all less than 0.8 μm in diameter (Rubow et al., 1990). Moreover, coal dust particles resulting from mining operations were all larger than 0.8 μm in diameter. To separate the diesel exhaust particulates from the coal dust particles, Marple et al. (1995) developed a virtual impactor personal aerosol sampler (VIPAS) for

use in diesel-equipped mines. As Figure 13 shows, the sampler consists of a 10 mm respirable cyclone, a 0.8 μm cutpoint virtual impactor, and two filter cassettes. The respirable particles penetrating the cyclone pass through a 0.8 μm cutpoint virtual impactor, which collects the particles larger than (coal dust particles) and smaller than (diesel exhaust particles) 0.8 μm on two 37 mm filter cassettes. The sampling flow rate is 2 L/min, which is compatible with the standard respirable dust sampler and personal sampling pumps.

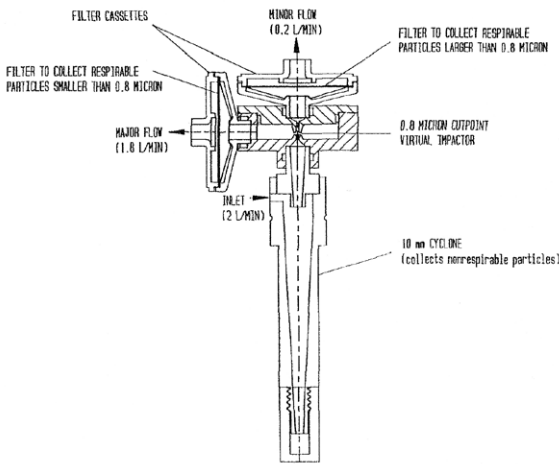

Figure 13. Schematic diagram of virtual impactor personal aerosol sampler

Source: Marple et al., 1995.

Virtual Impactors in Dust Generators to Provide Narrow Size Distributions

By passing a broad distribution aerosol through two virtual impactors with different cut sizes, one can remove the small particles in one virtual impactor and remove the large particles in the other virtual impactor, resulting in the availability of a narrow slice of the distribution. These particles can be used as test, or calibration, aerosols or may be used for process control.

Masuda et al. (1979) used two “improved” virtual impactors (virtual impactors with clean sheath air at the outer walls and clean cores of air) for classifying paraffin aerosols, coal dust, slate powder, and asbestos fibers. Later, Masuda et al. (1987) used a single-stage rectangular virtual impactor to classify powders for the ceramic industry.

Chen et al. (1988) used two virtual impactors to generate narrow size ranges of raw oil shale, talc, and fly ash particles. They used two virtual impactors with cut sizes of 4.4 and 3.1 μm , respectively, and classified the

powder into three size classes: (1) greater than the larger cut size (coarse), (2) smaller than the smaller cut size (fine), and (3) between the two cut sizes (middle).

Chen and Lundgren (1993) took a slightly different approach, using a virtual impactor to remove the small particles and a conventional impactor to remove the large particles. The virtual impactor used clean sheath air and interchangeable nozzles to vary the size of generated dust particles.

Virtual Impactors with Respirable Particle Collection Efficiencies

Historically, virtual impactors have been designed to provide a sharp size cut between the particles in the major and minor flow fractions. However, if the virtual impactor is used as a respirable sampler, the separation characteristics must mimic a respirable curve such as that of the British Medical Research Council (BMRC), the American Conference of Industrial Hygienists (ACGIH), or the International Organization for Standardization (ISO). Olson (2000) developed such a virtual impactor to monitor a continuous coal-mining machine (see Figure 14). Olson achieved these respirable curves with the virtual impactor by adjusting (1) the minor-to-total flow ratio, (2) the inlet angle, (3) the nozzle throat length, and (4) the nozzle-to-collection probe distance.

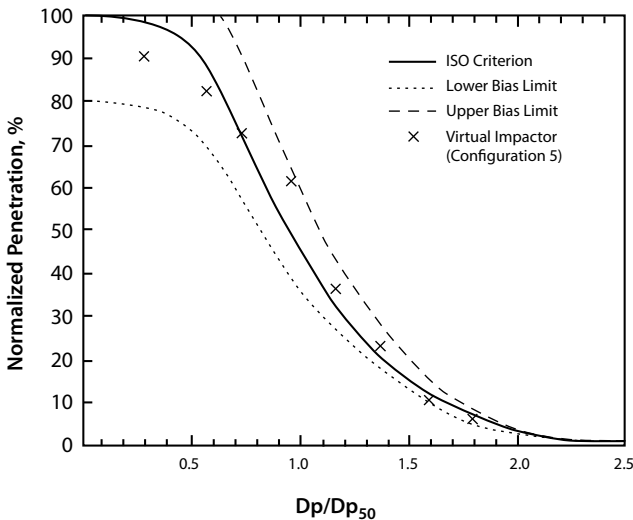

Figure 14. Respirable cut virtual impactor following the International Organization for Standardization (ISO) respirable criteria.

Source: Olson, 2000.

Virtual Impactor as a Particle Concentrator

The feature that originally made the virtual impactor a popular sampler was its ability to separate particles into two size classes and keep both classifications airborne. This solved the problems of particle bounce and stage overloading that were common in conventional impactors. Thus, much of the early work in the field involved developing virtual impactors with sharp, well-defined separation characteristics between large and small particle fractions, as well as low internal particle losses. A key feature of virtual impactors is that the large particle fraction is concentrated in the minor flow, which is a small fraction of the total flow.

This feature has been important for several applications, including use of virtual impactors as concentrators for particle sizing instrumentation (Keskinen et al., 1987; Wu et al., 1989; Liebhaber et al., 1991), environmental particulate exposure chambers (Barr et al., 1983; Sioutas et al., 1994a, 1994b, 1995), and biological particle samplers.

The feature is particularly interesting in its application to exposure chambers. These virtual impactors use a rectangular slit design with a flow rate of 1,000 L/min and a cut size of 0.1 μm . Figure 15 shows a schematic diagram of a slit virtual impactor (Sioutas et al., 1995).

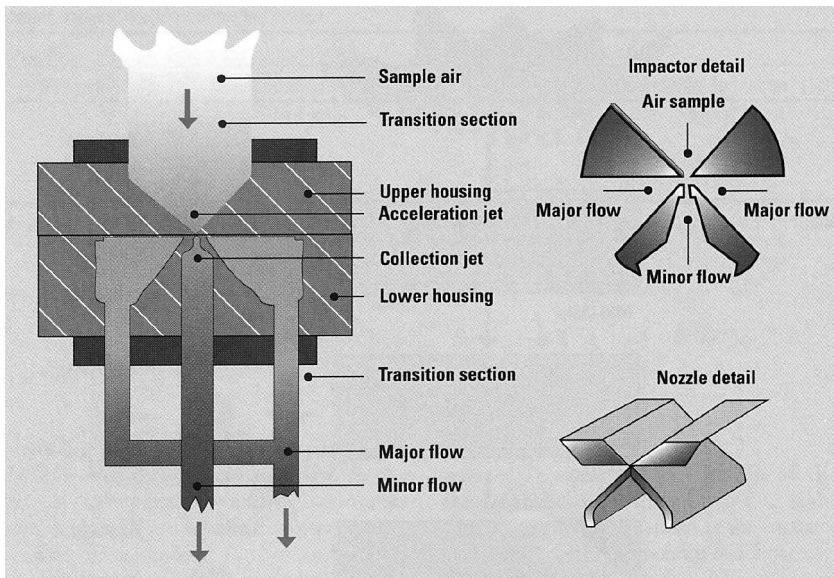

Figure 15. High-volume slit virtual impactor.

Source: Sioutas et al., 1995.

Another version of this type of concentrator, in which even smaller particles can be concentrated, first grows the particles in size by condensing water vapor on the particles and then passes the grown particles through a virtual impactor concentrator. After the particles are concentrated, the particles are dried, and the concentrated particles in their original state can be used for the exposure tests (Sioutas & Koutrakis, 1996).

The particle concentrating feature of virtual impactors has been important in sampling biological particles of the type used in biological warfare and terrorism activity. Here the purpose of the virtual impactor is to concentrate the threat particles into a small flow so that an appropriate instrument can analyze them. In these cases, it is not important that the cut size is well defined or that the particle concentration is known accurately, it is only important to know that some of the threat particles are present. Because the use of virtual impactors to sample aerosols from biological warfare and terrorism activity is a rather recent development and numerous variations of virtual impactors have been developed for this purpose, this chapter will not cover these virtual impactors.

Conclusion

Conventional impactors were introduced in 1860 (Marple, 2004); thus, the virtual impactor, which was introduced in the 1960s, is a relatively new type of inertial size separator. Despite its relative newness, the virtual impactor has proved to be very useful as both a particle classifier and a particle concentrator. Conner (1966) originally developed the virtual impactor as an aerosol classifier. As such, the virtual impactor has been most valuable as the 2.5 μm dichotomous sampler, having the ability to measure coarse ($\text{PM}_{10-2.5}$) and fine particles ($\text{PM}_{2.5}$). The advantage of using a virtual impactor rather than a conventional inertial impactor in this sampler is that there are not problems of particle overloading and particle bounce from the impaction plate. Biological samplers in which particles are concentrated in a small fraction of the flow have made extensive use of virtual impactors as particle concentrators, because they are suitable for a variety of analysis techniques.

Finally, the literature has disputed the origin of the virtual impactor. Many authors have credited the centripeter developed by Hounam and Sherwood (1965) as the first virtual impactor; however, other authors have credited the device developed by Connor (1966) as the first virtual impactor. Our analysis of these two papers shows that the device reported by Connor (1966) was

the original virtual impactor. Our analysis also shows that the centripeter is not a virtual impactor but is instead a series of particle-focusing lenses with centerline particle skimmers.

References

- Baron, P. A., & Willeke, K. (Eds.). (2001). *Aerosol measurement: Principles, techniques, and applications* (2nd ed.). New York, NY: John Wiley & Sons.
- Barr, E. B., Hoover, M. D., Kanapilly, G. M., Yeh, H. C., & Rothenberg, S. J. (1983). Aerosol concentrator: Design, construction, calibration and use. *Aerosol Science and Technology*, 2, 437–442.
- Chein, H., & Lundgren, D. A. (1993). Virtual impactor with clean air core for the generation of aerosols with narrow size distributions. *Aerosol Science and Technology*, 18, 376–388.
- Chen, B. T., & Yeh, H. C. (1987). An improved virtual impactor: Design and performance. *Journal of Aerosol Science*, 18, 203–214.
- Chen, B. T., Yeh, H. C., & Rivero, M. A. (1988). Use of two virtual impactors in series as an aerosol generator. *Journal of Aerosol Science*, 16, 343–354.
- Conner, W. D. (1966). An inertial-type particle separator for collecting large samples. *Journal of the Air Pollution Control Association*, 16, 35.
- Dzubay, T. G., & Stevens, R. K. (1975). Ambient air analysis with dichotomous sampler and X-ray fluorescence. *Environmental Science & Technology*, 9, 663–668.
- Forney, L. J. (1976). Aerosol fractionator for large-scale sampling. *Review of Scientific Instruments*, 47, 1264–1269.
- Forney, L. J., Ravenhall, D. G., & Lee, S. S. (1982). Experimental and theoretical study of a two-dimensional virtual impactor. *Environmental Science & Technology*, 16, 492–497.
- Forney, L. J., Ravenhall, D. G., & Wins, D. S. (1978). Aerosol impactors: A study of a fluid jet impinging upon a void. *Journal of Applied Physics*, 49, 2339–2345.
- Han, R., & Moss, O. R. (1997). Flow visualization inside a water model virtual impactor. *Journal of Aerosol Science*, 28, 1005–1014.

- Hounam, R. F., & Sherwood, R. J. (1965). The cascade centripeter: A device for determining the concentration and size distribution of aerosols. *American Industrial Hygiene Journal*, 26, 122–131.
- Keskinen, J., Janka, K., & Lehtimäki, M. (1987). Virtual impactor as an accessory to optical particle counters. *Aerosol Science and Technology*, 6, 79–83.
- Koch, W., Dunkhorst, W., & Lodding, H. (1999). Design and performance of a new personal aerosol monitor. *Aerosol Science and Technology*, 31, 231–246.
- Li, S., & Lundgren, D. A. (1997). Effect of clean air core geometry on fine particle contamination and calibration of a virtual impactor. *Aerosol Science and Technology*, 27, 625–635.
- Liebhaber, F. B., Lehtimäki, M., & Willeke, K. (1991). Low-cost virtual impactor for large-particle amplification in optical particle counters. *Aerosol Science and Technology*, 15, 208–213.
- Liu, B. Y. H., Rubow, K. L., McMurry P. H., & Kotz, T. J. (1991, July 7). *Airborne particulate matter and spacecraft internal environments* (SAE Paper No. 911476). Paper presented at the International Conference on Environmental Systems, San Francisco, CA.
- Loo, B. W. (1981). *United States Patent No. 4,301,002*. Washington, DC: US Patent and Trademark Office.
- Loo, B. W., & Cork, C. C. (1988). Development of high efficiency virtual impactors. *Aerosol Science and Technology*, 9, 167–176.
- Loo, B. W., & Jaklevic, J. M. (1974). *An evaluation of the ERC virtual impactor* (Report to EPA and US Atomic Energy Commission, Contract No. W-7405-ENG-48). Berkeley, CA: Lawrence Berkeley Laboratory.
- Loo, B. W., & Jaklevic, J. M. (1979). *A second generation dichotomous sampler for large scale monitoring of airborne particulate matter* (Report to the US Department of Energy, Contract No. W-7405-ENG-48). Berkeley, CA: Lawrence Berkeley Laboratory.
- Loo, B. W., Jaklevic, J. M., & Goulding, F. S. (1976). Dichotomous virtual impactors for large scale monitoring of airborne particulate matter. In B. Y. H. Liu (Ed.), *Fine particles: Aerosol generation, measurement, sampling and analysis* (pp. 311–350). New York, NY: Academic Press.

- Marple, V. A. (2004). History of impactors—The first 110 years. *Aerosol Science and Technology*, 38, 247–292.
- Marple, V. A., & Chien, C. M. (1980). Virtual impactors: A theoretical study. *Environmental Science & Technology*, 14, 976–985.
- Marple, V. A., Liu, B. Y. H., & Burton, R. M. (1990). High-volume impactor for sampling fine and coarse particles. *Journal of the Air & Waste Management Association*, 40, 762–767.
- Marple, V. A., & Olson, B. A. (1995). A high volume PM_{10/2.5/1.0} trichotomous sampler. *Particulate matter: Health and regulatory issues, VIP-49. Proceedings of an International Specialty Conference*. Pittsburgh, PA: Air and Waste Management Association.
- Marple, V. A., Rubow, K. L., & Olson, B. A. (1995). Diesel exhaust/mine dust personal aerosol: Sampler design, calibration and field evaluation. *Aerosol Science and Technology*, 22, 140–150.
- Masuda, H., Hochrainer, D., & Stober, W. (1979). An improved virtual impactor for particle classification and generation of test aerosols with narrow size distributions. *Journal of Aerosol Science*, 10, 275–287.
- Masuda, H., Motooka, T., Tanabe, T., Hong, G. H., & Watanabe, K. (1987). Size classification of industrial sub-micron powder by a virtual impactor. *Powder Technology*, 50, 155–161.
- McFarland, A. R., Ortiz, C. A., & Bertch, R. W., Jr. (1978). Particle collection characteristics of a single-stage dichotomous sampler. *Environmental Science & Technology*, 12, 679–682.
- Novick, V. J., & Alvarez, J. L. (1987). Design of a multistage virtual impactor. *Aerosol Science and Technology*, 6, 63–70.
- Olson, B. A. (2000). *Simulation of respirable mass sampling criteria using single round-nozzle virtual impactor technology* (Doctoral dissertation). University of Minnesota, Minneapolis.
- Ravenhall, D. G., Forney, L. J., & Jazayeri, M. (1978). Aerosol sizing with a slotted virtual impactor. *Journal of Colloid and Interface Science*, 1, 108–117.

- Rubow, K. L., Cantrell, B. K., & Marple, V. A. (1990). Measurement of coal dust and diesel exhaust aerosols in underground mines. In *Proceedings of the 7th International Conference on the Pneumoconiosis, August 23-26, 1988, Pittsburgh, PA* (NIOSH Publication No. 90-108, pp. 645-650). Atlanta, GA: US Department of Health and Human Services.
- Sioutas, C., & Koutrakis, P. (1996). Inertial separation of ultrafine particles using a condensational growth virtual impaction system. *Aerosol Science and Technology*, 25, 424-436.
- Sioutas, C., Koutrakis, P., & Burton, R. M. (1994b). Development of a low cutpoint slit virtual impactor for sampling ambient fine particles. *Aerosol Science and Technology*, 25, 1321-1330.
- Sioutas, C., Koutrakis, P., & Burton, R. M. (1995). A technique to expose animals to concentrated fine ambient aerosols. *Environmental Health Perspectives*, 103, 172-177.
- Sioutas, C., Koutrakis, P., & Olson, B. A. (1994a). Development and evaluation of a low cutpoint virtual impactor. *Aerosol Science and Technology*, 21, 223-235.
- Wu, J. J., Cooper, D. W., & Miller, R. J. (1989). Virtual impactor aerosol concentrator for cleanroom monitoring. *Journal of Environmental Sciences*, 5, 52-56.
- Xu, X. (1991). *A study of virtual impactor* (Doctoral dissertation). University of Minnesota, Minneapolis.

Review of Particle Size Distribution Measurements of Engine Exhaust Before 1985

Gilmore J. Sem, Oliver F. Bischof, and David B. Kittelson

Introduction

Real-time measurement of the size distribution of particles in engine exhaust emissions is used by engine manufacturers to optimize engines with regard to emissions, by automotive suppliers to develop efficient exhaust aftertreatment systems, and by scientists and legislators to assess the effect of engine exhaust on air quality and possible adverse health effects.

Few measurements of the size distribution of engine exhaust particles were made before 1970. One reason for this was the lack of suitable measuring instruments. Many early measurements required an electron microscope. In addition, representative samples of airborne particles for electron microscopy were difficult to obtain and required long sampling periods. Researchers also were required to manually view at least 1,000 particle images to obtain a single size distribution. Another difficulty was that researchers had to observe two dimensions of a 3-dimensional object to assign a single size to a nonspherical aggregate, a human process that often produced rather arbitrary results.

An excellent review of the state of the art of measuring the size distribution of exhaust particles in 1967 was given in a landmark paper by Frey and Corn (1967), published in the *American Industrial Hygiene Association Journal*, that described diesel exhaust particle size and other data summarized from 27 references. In their own work, Frey and Corn collected particles onto a suitable substrate using thermal precipitation. The difficulty of assigning a single size measure to any diesel particle aggregate is illustrated by the paper's Figure 2, which shows an electron micrograph of diesel particles.

Interestingly, Frey and Corn measured far more than just particle size distributions. Table V of their paper shows a number of diesel particle

characteristics from a limited number of observations from a single, small diesel engine. They used a thermal precipitator to collect the particles from the air and a microscope to size the particles. Additionally, they measured weight concentration in mg/m^3 ; rate-of-weight emissions in mg/min and mg/cm^3 fuel; number concentration in $\text{particles}/\text{cm}^3$; number emissions in $\text{particles}/\text{min}$ and $\text{particles}/\text{cm}^3$ fuel; specific surface in m^2/gm , m^2/m^3 , m^2/min , and m^2/cm^3 fuel; bulk density; particle projected area diameter; and free acidity. Frey and Corn were quite visionary in expressing emissions in units of “number of particles per cm^3 fuel,” and they foresaw fuel-specific emissions (per kg fuel) commonly used today.

About 10 years later, Vuk et al. (1976) published an update on manual methods for measuring the size distribution of diesel exhaust. Much of this report is associated with the master’s of science work of Vuk (1975) and Jones (1975). The primary particle sizing tool discussed in Vuk et al. (1976) is an Andersen Mark III cascade impactor, and many of the figures in the report show how to identify good or bad deposits on impactor plates. For a Caterpillar 3150 direct-injection, naturally aspirated engine, they found that 90% of the mass was contained by particles smaller than $0.6 \mu\text{m}$, the upper end of the smallest size bin they could detect.

By 1970, it was possible to measure aerosol particle size distributions down to 5 nm using automated instrumentation. The first such measurements of automotive aerosols were made in 1972 beside a major highway, and several research groups measured engine-exhaust particle size distribution with this equipment before 1985 using various methods of sampling and aerosol conditioning. By 1985, new instruments became available with far higher size resolution, making earlier instruments obsolete. This chapter describes early (before 1985) attempts to measure particle size distributions of engine exhaust aerosols. Much of the sampling, aerosol conditioning, and electrical mobility measurement technology developed before 1985 is still in use today.

Development of Automated Aerosol Measurement Technology

The technology for automated measurement of aerosol particle size distributions was built on the development of aerosol instruments for other purposes. Some of the mileposts on the path toward the development of fast, automated measurement of engine exhaust particle size are included in the following timeline:

-
- 1875 P. J. Coulier describes experiments showing that expansion of air in a chamber causes condensation to occur on airborne dust particles (Coulier, 1875a, 1875b). Coulier is the first author to explicitly describe the critical role that particles play as nuclei upon which water condenses to form rain droplets. Five years later, John Aitken describes independent experiments similar to Coulier's (Aitken, 1880). A year later, Aitken (1881) explains why his 1880 paper did not acknowledge Coulier's work.
-
- 1890 John Aitken describes a simple condensation nucleus counter (CNC), primarily developed to measure particle concentrations of outdoor atmospheres (Aitken, 1890).
-
- 1900 John Zeleny describes an electrical mobility classifier for electrically charged aerosol particles and ions (Zeleny, 1900).
-
- 1947 Frank Gucker, Jr., Chester O'Konski, Hugh Pickard, and James Pitts, Jr. report on their 1944 achievement developing a photoelectronic counter for measurement of size (i.e., diameter) distributions of aerosol particles larger than about 0.5 μm (Gucker et al., 1947). In 2005, Alvin Lieberman identifies this paper as the first to describe an optical particle counter (OPC; Lieberman, 2005).
-
- 1957 G. W. Hewitt publishes a landmark paper on controlled, reproducible, unipolar electrical charging of aerosol particles (Hewitt, 1957).
-
- 1961 Alvin Lieberman and John Stockham describe an OPC for cleanroom applications (Lieberman & Stockham, 1961).
-
- 1962 W. R. Zinky describes the first commercial OPC, the Royco model 200 (Zinky, 1962).
-
- 1966 Kenneth T. Whitby and William E. Clark describe an instrument based on electrical mobility classification of unipolarly charged particles to rapidly measure submicrometer aerosol size distributions (Whitby & Clark, 1966). The initial prototype was engineered and built in 1964 by Carl M. Peterson. In 1967, under the technical direction of Gilmore J. Sem, Thermo Systems Incorporated (TSI) introduces a commercial version of the instrument, the TSI model 3000 Whitby aerosol analyzer (WAA).
-
- 1966 A new commercial Royco OPC is introduced in a much smaller package, the Royco model 220.
-
- 1972 Burton G. Schuster and Robert Knollenberg describe a new form of OPC that illuminates individual particles within the active cavity of a laser, permitting the sizing of smaller particles by optical means than previously possible (Schuster & Knollenberg, 1972). This technology leads to the development of OPCs that measure bright, nonabsorbing particles as small as 50 nm.
-

-
- 1974 Benjamin Y. H. Liu, Kenneth T. Whitby, and David Y. H. Pui describe a greatly improved instrument that is based on the use of electrical mobility classification for measuring submicrometer aerosol particle size distributions in near-real-time (Liu et al., 1974). In 1974, TSI introduces the model 3030 electrical aerosol analyzer (EAA), which is partially based on the design of Liu and colleagues and much smaller than the model 3000.
-
- 1975 Earl O. Knutson and Kenneth T. Whitby describe a differential mobility analyzer (DMA) in detail in two classic papers (Knutson & Whitby, 1975a, 1975b). In 1976, Knutson provides detail about size measurement (Knutson, 1976), and TSI introduces a commercial DMA, the model 3071 electrostatic classifier. By 1985, it is possible to use this method to greatly improve the size resolution of aerosol size distribution measurements down to 3 nm.
-
- 1977 Jugal K. Agarwal, Gilmore J. Sem, and Michel Pourprix describe a new commercial CNC capable of counting single aerosol particles larger than about 7 nm at the Ninth International Conference on Atmospheric Aerosols, Condensation & Ice Nuclei, held in Galway, Ireland (Agarwal et al., 1977). A separate paper by Agarwal and Sem provides further detail (Agarwal & Sem, 1980). This technology is necessary to detect the aerosol concentration selected by a DMA.
-
- 1978 William A. Hoppel describes how to obtain size distributions of aerosol particles from the mobility distribution of the charged fraction of the aerosol (Hoppel, 1978). Darrell J. Alofs and P. Balakumar describe an alternative method in 1982 (Alofs & Balakumar, 1982).
-
- 1983 Two European groups, one at the University of Duisburg, Germany, led by Heinz Fissan, and the other at the Netherlands Energy Research Foundation, Petten, led by Andreas Plomp, simultaneously and independently develop submicrometer aerosol-sizing instruments that combine the high size resolution of a DMA, the low concentration detection of a single-particle-counting CNC, and the data reduction methods of Hoppel (1978) and Alofs and Balakumar (1982). The resulting instrument system measures aerosol particle size distributions with much higher size and concentration resolution than previously possible. This same year, Patricia B. Keady and colleagues describe the first commercial version of the differential mobility particle sizer (DMPS) system, which is developed by TSI (Keady et al., 1983).
-

It should be emphasized that an aerosol concentration detector capable of accurate measurements of aerosol concentrations in the 10 to 10,000 particles/cm³ range is essential for using a DMA to measure aerosol particle size distributions. Until single-particle-counting condensation particle counters (CPCs) became available in 1979 (Agarwal & Sem, 1980; Agarwal et al., 1977), it was not practical to use a DMA to measure particle size distributions of

most aerosols. It was highly useful to attach the instruments to a computer to control the measurement and convert the data into particle size distributions. All of these components became available in 1981 and 1982.

Automated Engine Exhaust Measurements Near Roads

In 1972, as part of the Aerosol Characterization Experiment (ACHEX), Whitby et al. (1975) measured aerosol size distributions and concentrations less than 100 meters east of the Harbor Freeway near the University of Southern California campus in Los Angeles. This series of measurements over a 24-hour period was the first measurement of primarily fresh vehicle exhaust using a WAA, which at the time was a new technology. The result of the experiment was partial verification of the newly developed concept of the multimodal nature of outdoor atmospheric aerosol size distributions.

Sem et al. (2011) described the trailer laboratory and its operation during the 1972 ACHEX program. Figure 1 shows results from two experimental runs—one with wind blowing across the freeway upwind of the sampling location, and the other with wind blowing in the opposite direction. The difference between the two size distributions represents an estimate of the contribution of traffic to the aerosol size distribution of urban air. During the

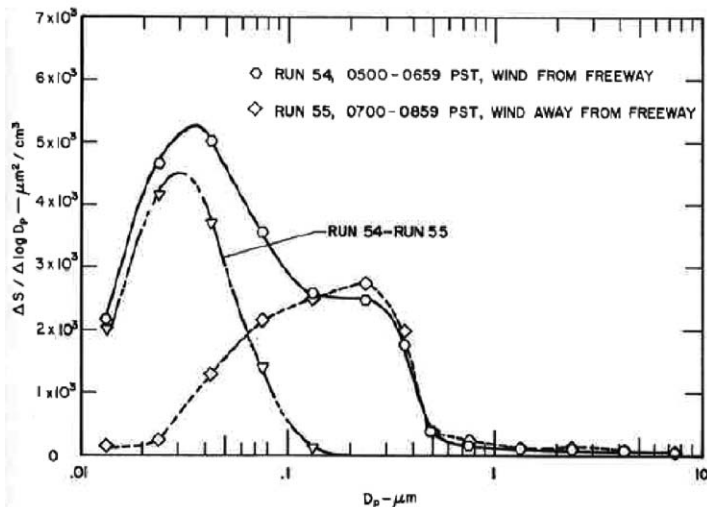

Figure 1. Surface area size distributions beside the Harbor Freeway, Los Angeles, California, September 1972. First distribution: Run 54—the freeway is upwind of the sampling site. Second distribution: Run 55—the freeway is downwind of the sampling site. Third distribution: the difference between Runs 54 and 55.

Source: Whitby et al., 1975; Whitby et al., 1980. Reprinted with permission from Elsevier.

ACHEX program, a WAA was used to measure particles smaller than $1 \mu\text{m}$, and an OPC Royco model 220 was used to measure particles larger than $0.5 \mu\text{m}$.

In 1975, Wilson et al. (1977) measured the particle size distribution and concentration of fresh vehicle exhaust beside the General Motors Test Track in Michigan. The purpose was to test the effect of new catalytic converters on a fleet of new vehicles. The particle size distributions were measured by second-generation EAAs and OPCs. Royco models 220 and 245 OPCs measured the size distributions of particles larger than $0.5 \mu\text{m}$. Another EAA was installed, along with other instruments, in a passenger car that made on-road measurements as it drove as part of the test fleet. One result of this work is shown in Figure 2, which outlines the classical experimental evidence of tri-modal aerosol size distributions that has been published numerous times. The smallest particle (nuclei) mode is fresh exhaust particles; the mid-sized particle (accumulation) mode originates primarily from the aging of combustion-generated particles; and the largest particle (coarse) mode is resuspended dust, partially stirred up by the vehicles driving on the track.

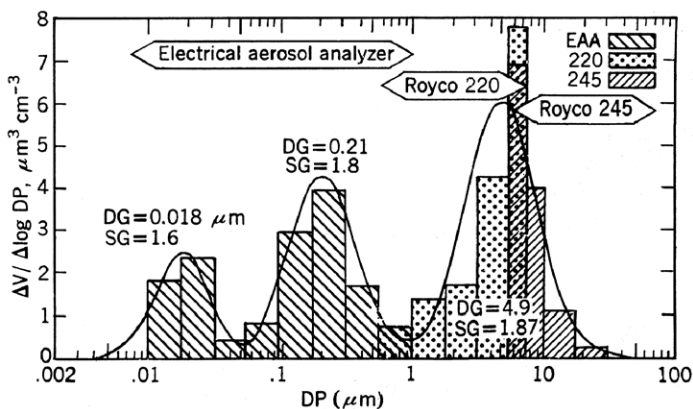

Figure 2. A tri-modal particle size distribution from the General Motors Test Track experiment on a day with low background aerosol concentration.

Source: Wilson et al., 1977. Reproduced with permission from the Air and Waste Management Association, *Journal of the Air Pollution Control Association*. Permission via the Copyright Clearance Center.

Miller et al. (1976) described experiments comparing laboratory-generated aerosol from two identical gasoline-powered cars—one burning leaded fuel and the other burning unleaded fuel. They looked in depth at the effect of dilution and aging on the resulting particle size distribution and found that lower rates of dilution or added aging time resulted in larger particles. They

compared the size distributions of laboratory-generated aerosol with size distributions of vehicles beside the Harbor Freeway, Los Angeles, Calif. (see Figure 1), and found good agreement. In several experiments, they measured the size distributions of irradiated automobile exhaust aerosol in a smog chamber. An EAA was the primary instrument used in this work.

Dolan and Kittelson (1979) used an EAA that had been installed in a mobile laboratory to do on-road chase experiments sampling from the exhaust plumes of individual vehicles. They measured particle size distributions and dilution ratios as a function of distance from the tailpipe and road speed for two light-duty diesel passenger cars.

Near-Real-Time Measurement of Particles in Engine Emissions

Beginning about 1974, David B. Kittelson and colleagues began adapting the particle sizing instrumentation system developed in Minnesota for atmospheric aerosols to their work on engine exhaust. Their approach was to measure diesel exhaust particle size distributions after diluting and conditioning the sample to reduce coagulation, effectively “freezing” the particle size distribution while reducing both the sample temperature and humidity. During the dilution process, the concentration, temperature, and humidity of the aerosol were conditioned to be within the range of atmospheric aerosols in urban environments. The dilution process simulated what happens when engine exhaust enters the atmosphere at the end of an exhaust pipe. It also permitted instruments designed for atmospheric aerosol to measure engine exhaust. The earliest work was summarized by Dolan et al. (1975), Dolan (1977), and Verrant and Kittelson (1977). Figures 3, 4, and 5 illustrate the evolution of sampling and dilution systems used by these authors. Figure 6 from Dolan et al. (1980) illustrates the difficulty of assigning a single size number to a 3-dimensional chain aggregate particle. It should be noted that the work of Kittelson and his colleagues continues in 2010, more than 30 years later (Kittelson et al., 2006a, 2006b, 2006c).

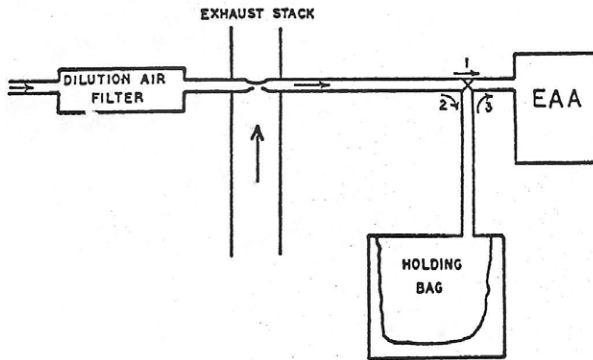

Figure 3. Very early sampling system used by Dolan et al. (1975) at the University of Minnesota to measure the size distribution of engine exhaust aerosol particles. The sampling system provided dilution to reduce aerosol concentration, temperature, and humidity. The holding bag stabilized the aerosol concentration and size distribution during the 2-minute sampling cycle of the electrical aerosol analyzer.

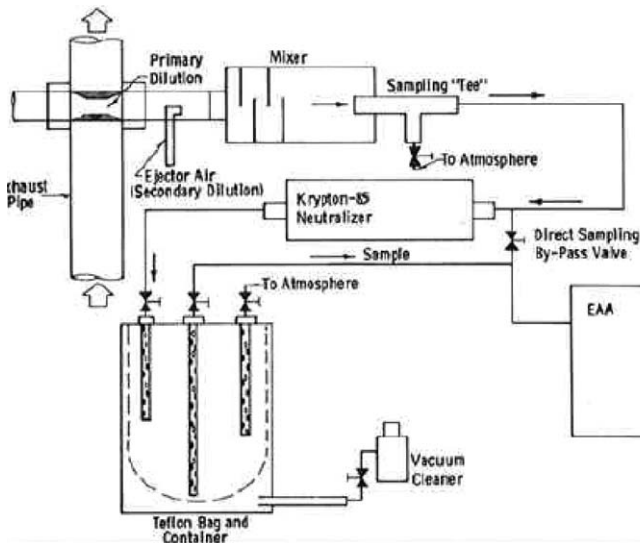

Figure 4. Improved University of Minnesota sampling system developed by Verrant (1976) and used by Verrant and Kittelson (1977). An air ejector provided dilution and pumping power. The EAA could sample directly during stable engine operation. A holding bag provided a stable aerosol to the EAA during periods when the engine was not stable.

The Minnesota work was followed almost immediately by the work of John H. Johnson and colleagues from Michigan Technological University in Houghton, using similar techniques. Johnson studied engine exhaust particles before this time using other techniques, as summarized by Khatri (1977), Khatri and Johnson (1978), and Lipkea et al. (1979). Figures 7, 8, and 9 illustrate the development of engine exhaust from a truck, including dilution of the exhaust as it enters the atmosphere while the truck is being driven on a highway (Lipkea et al., 1979).

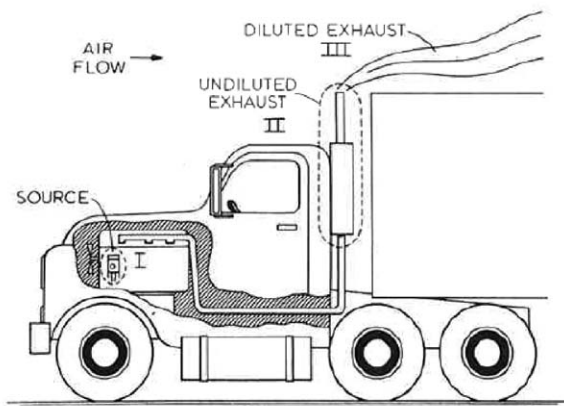

Figure 7. Illustration of exhaust dilution following a diesel truck on a highway.

Source: Lipkea et al., 1979. Reprinted with permission from the Society of Automotive Engineers.

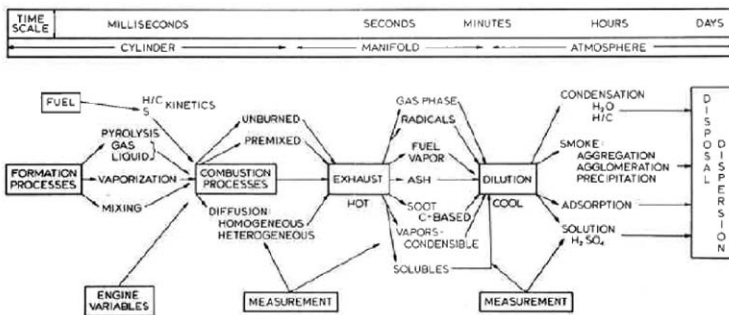

Figure 8. Combustion factors related to time for diesel particle emissions.

Source: Lipkea et al., 1979. Reprinted with permission from the Society of Automotive Engineers.

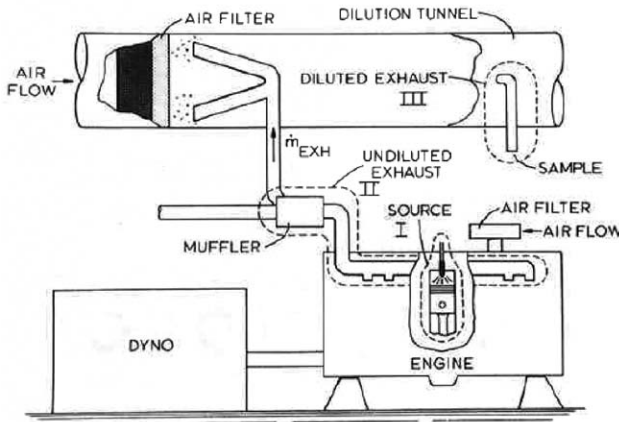

Figure 9. Sample dilution system used by Michigan Technological University for aerosol particle size distribution measurements.

Source: Lipkea et al., 1979. Reprinted with permission from the Society of Automotive Engineers.

Both Kittelson's group and Johnson's group developed sampling systems for laboratory simulation of what happens as a diesel vehicle travels down the highway. Figures 9 and 10 illustrate the Michigan Technological University sampling and dilution system for aerosol particle size measurement using an EAA to size the particles.

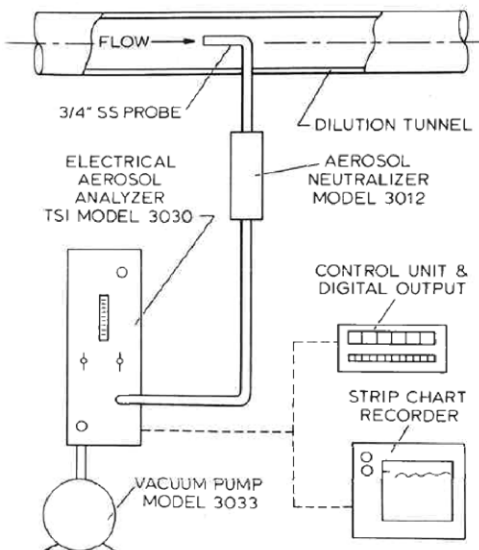

Figure 10. Engine exhaust sampling system for steady-state aerosol particle size measurement using an EAA at Michigan Technological University. The dilution tunnel is identified in Figure 9. A bag system similar to that shown in Figures 3 and 4 was used for unstable aerosol measurements

Source: Khatri & Johnson, 1978. Reprinted with permission from the Society of Automotive Engineers.

As shown in Figure 11, Khatri (1977) found that the particle size distributions from a single heavy-duty diesel engine varied considerably. Khatri used the equipment shown in Figure 10 for these measurements.

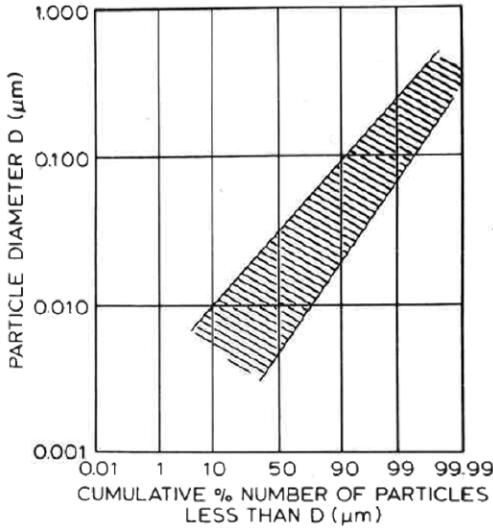

Figure 11. Size distributions measured using the system in Figures 9 and 10 at Michigan Technological University for a Caterpillar 3150 engine.

Source: Lipkea et al. (1979) attributed this work to Khatri (1977). Reprinted with permission from John H. Johnson.

Vuk et al. (1976) struggled with the definition of particle “diameter” for a chain-like agglomerate that may be made up of dozens or hundreds of nearly spherical primary particles. Figure 12 illustrates two ways they found to define the particle “diameter” of such a particle. Any microscopic method of measuring particle size must contend with this difficulty. While it may be difficult to determine exactly what an automated instrument measures, a

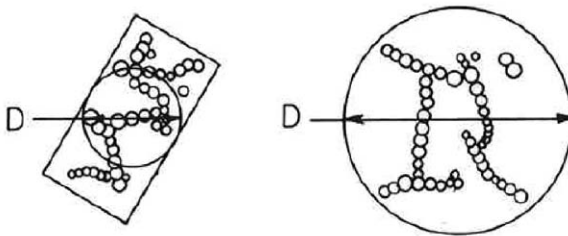

Figure 12. Schematic diagrams of two diesel aggregates illustrating two different ways to define diameter. See also Figure 6.

Source: Lipkea et al. (1979) attributed this work to Vuk et al. (1976). Reprinted with permission from the Society of Automotive Engineers.

properly operated instrument will measure each particle, today and tomorrow, in the same way. The same cannot be said for methods that depend on human observation and judgment to assign a size to an aggregate. In order to make their work more quantitative, Vuk et al. (1976) characterized aggregates found in a diesel engine by counting the number of primary particles within each aggregate. Figure 13 is a summary of their results.

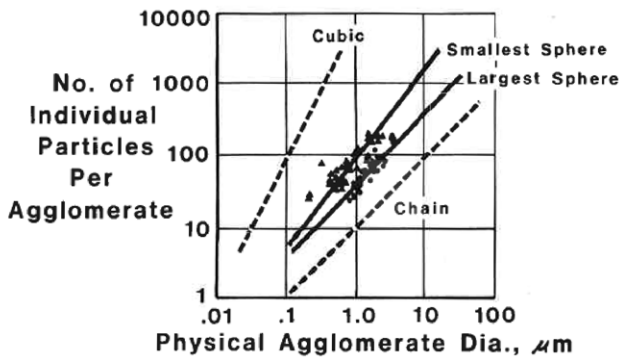

Figure 13. Number of individual particles per agglomerate versus the diameter of the aggregate.

Source: Lipkea et al. (1979) attributed this work to Vuk et al. (1976). Reprinted with permission from the Society of Automotive Engineers.

Groblicki (1976), Groblicki and Begeman (1979), and Countess et al. (1981) from General Motors Research Laboratory made measurements of automobile exhaust particle size using an EAA in the mid- to late-1970s. This work often was aimed at chemical analysis of particles segmented by size distribution and frequently compared EAA-measured size distributions with cascade impactor size distributions.

Dolan et al. (1980) described the use of a diffusion battery with a CPC detector to measure the size distribution of diesel exhaust aerosol (see Figure 5). Cheng et al. (1984) also used diffusion batteries with CPCs to measure the size of diesel exhaust particles for chronic inhalation studies. In both cases, the diffusion battery was a screen battery (TSI model 3040) and the CPC was a continuous-flow instrument (TSI model 3020). The low size resolution for diffusion measurement methods led to the abandonment of this approach.

Israel et al. (1980, 1981) appear to have been the first Europeans to use near-real-time aerosol size measuring instruments, reporting on the use of an EAA in West Berlin for measurements of diesel exhaust particle size distributions. Figure 14 is a schematic diagram of their sampling and dilution system.

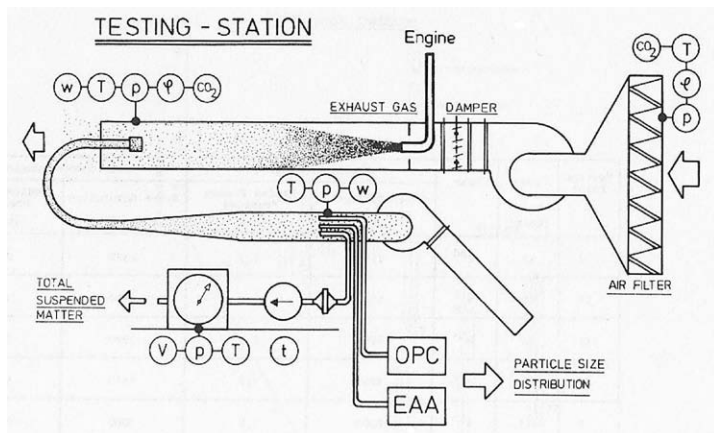

Figure 14. Schematic diagram of setup used by Israel et al. (1980) showing sampling and dilution system, particle size measurement with an electrical aerosol analyzer and optical particle counter, and relevant measurement parameters. Reprinted with permission from Gerhard Kasper.

One year later, Reischl (1981) published data comparing cascade impactor measurements with those obtained by combining a DMA with a Faraday cup aerosol electrometer. Although Reischl initially looked at paraffin wax aerosol, we believe this was the beginning of his work to validate DMA measurements for measuring exhaust particles. As shown in Figure 15, the validation for paraffin wax particles experimentally demonstrated that there were only slight deviations between the two techniques.

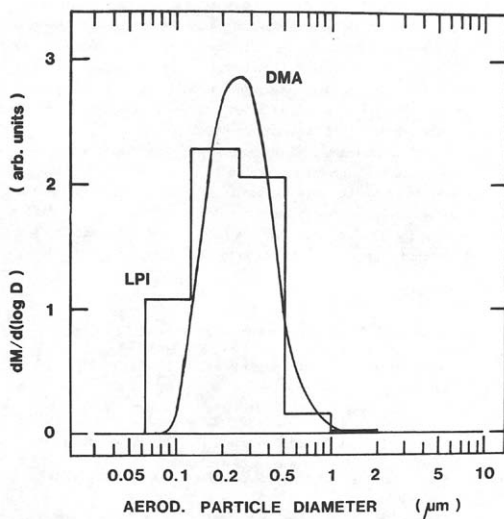

Figure 15. Comparison of paraffin wax aerosol size distributions measured with a DMA/Faraday cup aerosol electrometer sizing system and a cascade impactor. Source: Reischl, 1981. Reprinted with permission from Gerhard Kasper.

Several investigators looked into using differential mobility analysis with an appropriate concentration detector to measure submicrometer size distributions of aerosol particles with high resolution. Knutson (1971) and Knutson and Whitby (1975a) proposed data reduction methods, but did not have a detector sensitive enough to measure most aerosols. Hoppel (1978) and Alofs and Balakumar (1982) proposed alternative methods of converting the raw measurement to a particle size distribution. None of these investigators applied a DMA to engine exhaust.

Dolan et al. (1980) described the first use of a DMA with CPC detection to calibrate particle sizing instruments for diesel exhaust measurement (see Figure 5). Calibration of an EAA for measurement of diesel exhaust using a DMA and CPC is not the same as actually using the DMA and CPC to measure the size distribution of diesel exhaust particles, but it was a first step in applying these instruments for that purpose several years later.

During the early 1980s, two European groups working independently (Plomp and colleagues of the Netherlands Energy Research Foundation, Petten, and Fissan and colleagues of the University of Duisburg, Germany) simultaneously first developed practical DMA particle sizing systems, including computerized data reduction techniques (Plomp et al, 1983; Fissan et al, 1983). Both groups described their work in back-to-back oral presentations at the 1982 Annual Meeting, Gesellschaft für Aerosolforschung, in Bologna, Italy. Keady et al. (1983, 1984) described the first commercial version of the Fissan et al. system, which was developed by TSI and named the DMPS spectrometer. The stage was now set for the use of engine exhaust particle sizing technology that was still in use, with improvements, in 2010.

Kittelson et al. (1986) reported on the use of a DMA and a CPC to measure the electrical charge on diesel exhaust aerosol particles. They found the particles to be highly charged, with the charges quite evenly distributed between positive and negative polarity. However, for particles in the 0.3 to 0.5 μm range, they found the polarities to be less evenly distributed. The researchers were not able to determine the cause of the nonuniform polarity distribution on larger particles, but speculated that it was related to contact with a surface. In this experiment, they used a second DMA and CPC to measure the size distribution of charged particles within a narrow mobility range emitted from the first DMA.

It should be noted that we found no paper describing the measurement of diesel exhaust particles using DMA/CNC technologies before 1985, although

Wen et al. (1984) come enticingly close to it with their measurements of chain aggregate particles. Kasper stated that the work he did with Wen et al. (1984) at the State University of New York at Buffalo did not include automotive exhaust measurements (personal communication with G. Kasper, Universität Karlsruhe, D-76128 Karlsruhe, Germany, 2006). We suspect that Georg Reischl continued this work in Vienna and may have measured diesel exhaust particle size distributions using DMA/CNC technologies during the mid-1980s. At about this time, Reischl developed a DMA of his own design for this work, known as the Vienna or Reischl DMA. Reischl often used a Faraday cup aerosol electrometer as the detector in his measurement systems.

Conclusions

This chapter reviewed the evolution of engine exhaust particle size distribution measurements up to the introduction of the DMPS. We have described the state-of-the-art of engine exhaust particle size distribution measurement as it existed in the early 1970s and traced the beginnings of automated, near-real-time engine exhaust particle size measurements up to 1985, when differential mobility particle sizing with much higher size resolution was introduced.

Engine exhaust particle size distribution measurement used instruments developed largely for outdoor ambient aerosol measurements. Therefore, we have traced the development of aerosol particle sizing instruments from the 1870s up until 1985. For further historical information about this topic, see Flagan (1998) and McMurry (2000a, 2000b).

Acknowledgments

The authors acknowledge Andreas Mayer (TTM, Niederrohrdorf, Switzerland) for the original suggestion to prepare a paper on early engine exhaust particle size distribution measurements. He invited us to present it orally at the 9th ETH Conference on Combustion Generated Nanoparticles, Zürich, Switzerland, August 15 to 17, 2005. We appreciate the comments from two anonymous reviewers that led to significant improvements to the manuscript.

References

- Agarwal, J. K., & Sem, G. J. (1980). Continuous-flow, single-particle-counting condensation nucleus counter. *Journal of Aerosol Science*, 11(4), 343–357.
- Agarwal, J. K., Sem, G. J., & Pourprix, M. (1977). A continuous flow CNC capable of counting single particles. In A. F. Roddy & T. C. O'Connor (Eds.), *Atmospheric aerosols and nuclei, Proceedings, 9th International Conference on Atmospheric Aerosols, Condensation & Ice Nuclei* (pp. 118–122). Galway, Ireland: Galway University Press.
- Aitken, J. (1880). On dust, fogs and clouds. *Transactions of the Royal Society of Edinburgh*, 30(1), 337–368.
- Aitken, J. (1881). Dust, fogs, and clouds. *Nature* 23(591), 384–385.
- Aitken, J. (1890). On a simple pocket dust-counter. *Proceedings of the Royal Society of Edinburgh (1890–1891)*18(February), 39–52.
- Alofs, D. J., & Balakumar, P. (1982). Inversion to obtain aerosol size distributions from measurements with a differential mobility analyzer. *Journal of Aerosol Science*, 13(6), 513–527.
- Cheng, Y. S., Yeh, H. C., Mauderly, J. L., & Mokler, B. V. (1984). Characterization of diesel exhaust in a chronic inhalation study. *American Industrial Hygiene Association Journal*, 45(8), 547–555.
- Coulier, P. J. (1875a). Note sur une nouvelle propriété de l'air. *Journal de Pharmacie et de Chimie, Paris, Series 4*, 22, 165–173.
- Coulier, P. J. (1875b). Note sur une nouvelle propriété de l'air. *Journal de Pharmacie et de Chimie, Paris, Series 4*, 22, 254–255.
- Countess, R. J., Cadle, S. H., Groblicki, P. J., & Wolff, G. T. (1981). Chemical-analysis of size-segregated samples of Denver ambient particulate. *Journal of the Air Pollution Control Association*, 31(3), 247–252.
- Dolan, D. F. (1977). Experimental theoretical investigation of diesel exhaust particulate matter (Unpublished doctoral dissertation). University of Minnesota, Minneapolis.
- Dolan, D. F., & Kittelson, D. B. (1979). *Roadway measurements on diesel exhaust aerosols*. (SAE Technical Paper 790492). Warrendale, PA: Society of Automotive Engineers.

- Dolan, D. F., Kittelson, D. B., & Pui, D. Y. H. (1980). Diesel exhaust particle size distribution measurement techniques (SAE Technical Paper 800187). In *Diesel combustion and emissions, Proceedings P-86* (pp. 149–164). Warrendale, PA: Society of Automotive Engineers.
- Dolan, D. F., Kittelson, D. B., & Whitby, K. T. (1975). *Measurement of diesel exhaust particle size distributions* (ASME Paper 75-WA/APC-5). New York: American Society of Mechanical Engineers.
- Fissan, H. J., Helsper, C., & Thielen, H. J. (1983). Determination of particle-size distributions by means of an electrostatic classifier. *Journal of Aerosol Science*, 14(3), 354–357.
- Flagan, R. C. (1998). History of electrical aerosol measurements. *Aerosol Science and Technology*, 28(4), 301–380.
- Frey, J. W., & Corn, M. (1967). Physical and chemical characteristics of particulates in a diesel exhaust. *American Industrial Hygiene Association Journal*, 28(5), 468–478.
- Groblicki, P. J. (1976). *General Motors sulfate dispersion experiment: Aerosol sizing measurements* (GM Research Publication GMR-2127). Warren, MI: GM Research Laboratories.
- Groblicki, P. J., & Begeman, C. R. (1979). *Particle size variation in diesel car exhaust* (SAE Technical Paper 790421, SAE/PT-79/17). Warrendale, PA: Society of Automotive Engineers.
- Gucker, F. T., Okonski, C. T., Pickard, H. B., & Pitts, J. N. (1947). A photoelectronic counter for colloidal particles. *Journal of the American Chemical Society*, 69(10), 2422–2431.
- Hewitt, G. W. (1957). The charging of small particles for electrostatic precipitation. *Transactions of the American Institute of Electrical Engineers*, 76, 300–306.
- Hoppel, W. A. (1978). Determination of the aerosol size distribution from the mobility distribution of the charged fraction of aerosols. *Journal of Aerosol Science*, 9, 41–54.
- Israel, G. W., Zierock, K.-H., & Mollenhauer, K. (1980). Die Schwebstoff-Emissionscharakteristik von stationär betriebenen Dieselmotoren. In W. Stöber & D. Hochrainer (Eds.), *Proceedings of the 8th Conference of the Gesellschaft für Aerosolforschung* (pp. 330–335). Schmallenberg, W. Germany: Gesellschaft für Aerosolforschung.

- Israel, G. W., Zierock, K.-H., & Mollenhauer, K. (1981). Properties of particulate-emissions from diesel-engines. *Journal of Aerosol Science*, 12(3), 222–222.
- Jones, M. A. (1975). *The effect of engine load and speed on the physical characteristics of diesel particulate emissions* (Unpublished master's thesis). Michigan Technological University, Houghton.
- Keady, P. B., Quant, F. R., & Sem, G. J. (1983). Differential mobility particle sizer: A new instrument for high-resolution aerosol size distribution measurement below 1 μm . *TSI Quarterly*, IX(2), 3–11.
- Keady, P. B., Quant, F. R., & Sem, G. J. (1984). Automated differential mobility particle sizer. In B. Y. H. Liu, D. Y. H. Pui & H. J. Fissan (Eds.), *Proceedings, First International Aerosol Conference* (pp. 71–74). Minneapolis, MN.
- Khatri, N. J. (1977). *The measurement of diesel particulate matter size distribution using the electrical aerosol analyzer and the analysis of the sulfate fraction using the barium chloranilate method* (Unpublished master's thesis). Michigan Technological University, Houghton.
- Khatri, N. J., & Johnson, J. H. (1978). *Physical size distribution characterization of diesel particulate matter and the study of the coagulation process* (SAE Technical Paper 780788). Warrendale, PA: Society of Automotive Engineers.
- Kittelson, D. B., Moon, K. C., & Pui, D. Y. H. (1986). *Diesel particle control with a simple electrostatic trap* (SAE Technical Paper 860009). Warrendale, PA: Society of Automotive Engineers.
- Kittelson, D. B., Watts, W. F., & Johnson, J. P. (2006a). On-road and laboratory evaluation of combustion aerosols, Part 1: Summary of diesel engine results. *Journal of Aerosol Science*, 37(8), 913–930.
- Kittelson, D. B., Watts, W. F., Johnson, J. P., Rowntree, C., Payne, M., Goodier, S., Warrens, C., Preston, H., Zink, U., Ortiz, M., Goersmann, C., Twigg, M.V., Walker, A.P., & Caldow, R. (2006b). On-road evaluation of two diesel exhaust aftertreatment devices. *Journal of Aerosol Science*, 37(9), 1140–1151.
- Kittelson, D. B., Watts, W. F., Johnson, J. P., Schauer, J., & Lawson, D. R. (2006c). On-road and laboratory evaluation of combustion aerosols, Part 2: Summary of spark ignition engine results. *Journal of Aerosol Science*, 37(8), 931–949.

- Knutson, E. O. (1971). *The distribution of electrical charge among the particles of an artificially charged aerosol* (Unpublished doctoral dissertation). University of Minnesota, Minneapolis.
- Knutson, E. O. (1976). Extended electric mobility method for measuring aerosol particle size and concentration. In B. Y. H. Liu (Ed.), *Fine particles: Aerosol generation, measurement, and sampling* (pp. 740–762). New York, NY: Academic Press.
- Knutson, E. O., & Whitby, K. T. (1975a). Accurate measurement of aerosol electric mobility moments. *Journal of Aerosol Science*, 6, 453–466.
- Knutson, E. O., & Whitby, K. T. (1975b). Aerosol classification by electrical mobility: Apparatus, theory, and applications. *Journal of Aerosol Science*, 6, 443–451.
- Lieberman, A. (2005). Optical particle counters; then, now, and tomorrow. In G. J. Sem, D. Boulaud, P. Brimblecombe, D. S. Ensor, J. W. Gentry, J. C. M. Marijnissen, & O. Preining (Eds.), *History & reviews of aerosol science* (pp. 157–163). Mount Laurel, NJ: American Association for Aerosol Research.
- Lieberman, A., & Stockham, J. (1961). Automatic techniques for airborne particle counting. *Air Engineering*, 2(1), 37–39.
- Lipkea, W. H., Johnson, J. H., & Vuk, C. T. (1979). *The physical and chemical character of diesel particulate emissions—measurement techniques and fundamental considerations* (SAE Technical Paper 780108, SAE/PT-79/17, 1-57). Warrendale, PA: Society of Automotive Engineers.
- Liu, B. Y. H., Whitby, K. T., & Pui, D. Y. H. (1974). A portable electrical analyzer for size distribution measurement of submicron aerosols. *Journal of the Air Pollution Control Association*, 24(11), 1067–1072.
- McMurry, P. H. (2000a). A review of atmospheric aerosol measurements. *Atmospheric Environment*, 34(12–14), 1959–1999.
- McMurry, P. H. (2000b). The history of condensation nucleus counters. *Aerosol Science and Technology*, 33(4), 297–322.
- Miller, D. F., Levy, A., Pui, D. Y. H., Whitby, K. T., & Wilson Jr., W. E. (1976). Combustion and photochemical aerosols attributable to automobiles. *Journal of the Air Pollution Control Association*, 26(6), 576–581.

- Plomp, A., ten Brink, H. M., Spoelstra, H., & van de Vate, J. F. (1983). A high resolution electrical mobility aerosol spectrometer (MAS). *Journal of Aerosol Science*, 14(3), 363–367.
- Reischl, G. P. (1981). On the equivalence of low pressure impactor and differential mobility analyzer data for submicron particle size distributions. In W. Stöber & D. Hochrainer (Eds.), *Proceedings of the 8th Conference of the Gesellschaft für Aerosolforschung* (pp. 217–222). Schmallenberg, W. Germany: Gesellschaft für Aerosolforschung.
- Schuster, B. G., & Knollenberg, R. (1972). Detection and sizing of small particles in open cavity gas laser. *Applied Optics*, 11(7), 1515–1520.
- Sem, G. J., Clark, W. E., Sverdrup, G. M., & Marple, V. A. (2011). Memories and legacy of the ACHEX Mobile Semitrailer Air Pollution Laboratory. In David S. Ensor (Ed.), *Aerosol Science and Technology: History and Reviews* (Chapter 9). Research Triangle Park, NC: RTI Press.
- Verrant, J. A. (1976). *Development of a dilution system for measuring diesel exhaust particulate matter* (Unpublished master's thesis). University of Minnesota, Minneapolis.
- Verrant, J. A., & Kittelson, D. B. (1977). *Sampling and physical characterization of diesel exhaust aerosols* (SAE Technical Paper 770720, SAE/PT-79/17, 59-72). Warrendale, PA: Society of Automotive Engineers.
- Vuk, C. T. (1975). *The development and application of techniques for the measurement and analysis of diesel particulate emissions* (Unpublished master's thesis). Michigan Technological University, Houghton.
- Vuk, C. T., Jones, M. A., & Johnson, J. H. (1976). *Measurement and analysis of the physical character of diesel particulate emissions* (SAE Technical Paper 760131). Warrendale, PA: Society of Automotive Engineers.
- Wen, H. Y., Reischl, G. P., & Kasper, G. (1984). Bipolar diffusion charging of fibrous aerosol particles – II. Charge and electrical mobility measurements on linear chain aggregates. *Journal of Aerosol Science*, 15(2), 103–122.
- Whitby, K. T., & Clark, W. E. (1966). Electrical aerosol particle counting and size distribution measuring system for the 0.015 to 1 μ size range. *Tellus*, 18, 573–586.

- Whitby, K. T., Clark, W. E., Marple, V. A., Sverdrup, G. M., Sem, G. J., Willeke, K., Liu, B. H. Y., Pui, D. Y. H. (1975). Characterization of California aerosols – I. Size distributions of freeway aerosol. *Atmospheric Environment*, 9(5), 463–482.
- Whitby, K. T., Clark, W. E., Marple, V. A., Sverdrup, G. M., Sem, G. J., Willeke, K., Liu, B. H. Y., Pui, D. Y. H. (1980). Appendix A: Size distribution of freeway aerosol. In G. M. Hidy, P. K. Mueller, D. Grosjean, B. R. Appel & J. J. Wesolowski (Eds.), *The character and origins of smog aerosols, a digest of results from the California Aerosol Characterization Experiment (ACHEX)*. New York, NY: Wiley-Interscience.
- Wilson, W. E., Spiller, L. L., Ellestad, T. G., Lamothe, P. J., Dzubay, T. G., Stevens, R. K., Kittelson, D. B., Cantrell, B. K. (1977). General Motors sulfate dispersion experiment—Summary of EPA measurements. *Journal of the Air Pollution Control Association*, 27(1), 46–51.
- Zeleny, J. (1900). The velocity of the ions produced in gases by Röntgen rays. *Philosophical Transactions of the Royal Society*, A195, 193–234.
- Zinky, W. R. (1962). The aerosol particle counter. *Journal of the Air Pollution Control Association*, 12, 578–583.

Trends in Airborne Concentrations of Total Suspended Particles, PM_{10} , SO_2 , and NO_2 in Five Chinese Cities

Shen Tian, Cliff I. Davidson, and H. Keith Florig

Introduction

During the past few decades, China's sustained and unprecedented economic growth has been accompanied by persistent urban air pollution problems. Significant sources of urban air pollutants include stationary sources such as coal boilers, industrial furnaces, motor vehicles, construction dust, and crop burning in upwind rural areas. National policies for management of urban air pollution were first promulgated by the National Environmental Protection Agency. Reflecting the growing importance of environmental issues in Chinese domestic policy, this agency was twice elevated—once to the State Environmental Protection Administration in 1998 and again to the Ministry of Environmental Protection (MEP) in 2008 (Jaheil, 1998; Sun, 2001).

This chapter addresses the historical ambient air pollution records for five Chinese cities, each chosen for its importance as a center of government, commerce, or industry. The cities include China's capital city, Beijing (population 13 million); the country's financial hub, Shanghai (population 20 million); and Taiyuan (5 million), Tianjin (8 million), and Xian (2 million), which are industrial centers in the central, north, and mid-west regions, respectively.

China's urban ambient monitoring network was launched in the mid-1980s, initially recording total suspended particles (TSP) and sulfur dioxide (SO_2). Nitrogen dioxide (NO_2) monitoring was added in the mid-1990s. PM_{10} monitoring was phased in around 2000. Today, carbon monoxide (CO) and ozone (O_3) are also frequently monitored. Annual average levels of monitored pollutants for many dozens of selected cities (not always the same cities from year to year) are available in the China Environment Yearbook series, published by the MEP.

Beginning in 2000, each Chinese city has been required to publish a daily air pollution index. The reported number is actually the greatest of several indices, one each for PM_{10} , SO_2 , and NO_x representing the sum of nitric oxide (NO) and NO_2 , and sometimes CO and O_3 . Each index ranges from 0–500, corresponding to different concentration ranges for each pollutant. The daily reported index consists of both the numeric value of the index and the pollutant on which it is based. For many cities, this pollutant changes over periods of days. Currently, the daily air pollution index for a number of cities is available on the MEP website (<http://www.zhb.gov.cn>).

Beginning in 1982, China established primary and secondary ambient air quality standards for several pollutants. Values of these standards for the pollutants of interest here are presented in Table 1. Primary standards are those designed for national parks and historic sites. Secondary standards are for protection of human health and apply to residential and commercial areas in both cities and rural areas. These standards have been adopted based on criteria similar to standards in other countries, such as the United States.

In this chapter, we present airborne concentration data reported by the MEP and discuss data trends in terms of economic development, regulations, and control technologies.

Table 1. National primary and secondary ambient air quality standards—annual average, micrograms per cubic meter

Pollutant	Primary	Secondary	US National Ambient Air Quality Standards: Primary Standard
SO_2	20	60	0.03 ppm (80 $\mu\text{g}/\text{m}^3$) annual average
Total Suspended Particles	80	200	N/A
PM_{10}	40	100	N/A
NO_2	40	40	0.053 ppm (100 $\mu\text{g}/\text{m}^3$) annual average

Source: State Environmental Protection Administration, 1996.

Air Pollutant Concentrations in Chinese Cities

Figure 1 presents annual average particle concentrations in the five cities over a 20-year period. The secondary ambient air quality standards for TSP and PM_{10} are indicated by horizontal broken lines. These data show that

particle levels declined in each of the five cities over this period, with the most dramatic declines in the more industrial cities of Taiyuan, Tianjin, and Xian. Despite these improvements, ambient particle concentrations remain above the Chinese standard for residential areas in all cities except Shanghai. Levels in Shanghai may be low due to lesser quantities of heavy industry there.

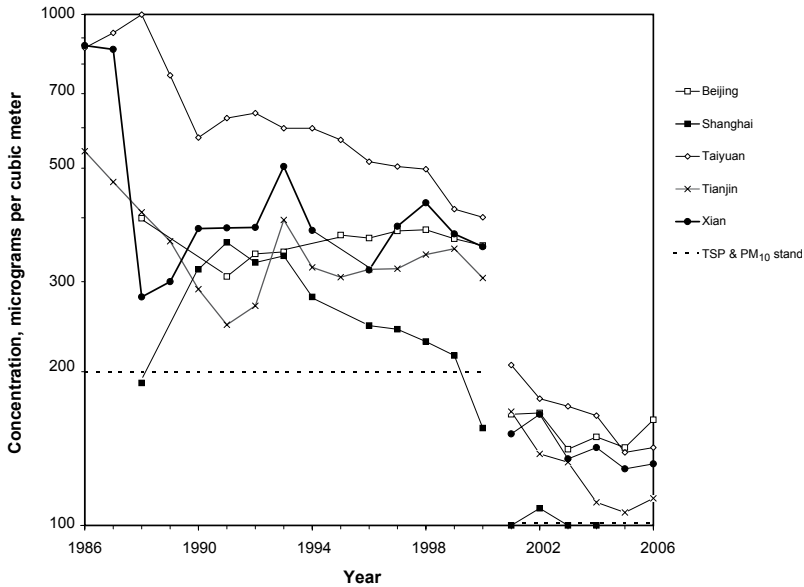

Figure 1. Average annual TSP (1986–1999) and PM₁₀ (2001–2006) concentrations in five Chinese cities, showing comparison with the secondary ambient air quality standards for annual average concentration. Around the year 2000, TSP measurements were largely replaced with PM₁₀ measurements. The horizontal broken lines indicate the secondary standards for TSP and PM₁₀, where the latter standard is coincident with the x-axis.

Source: Ministry of Environmental Protection, various years.

Figures 2 and 3 present similar plots for annual average SO₂ and NO_x/NO₂ concentrations in the five cities, along with their respective secondary ambient air quality standards. SO₂ levels have declined markedly in many cities over the past 20 years, but concentrations in some cities remain above the secondary ambient air quality standard. In contrast to particle and SO₂ concentrations, NO_x and NO₂ concentrations have increased in many cities over the past 20 years, presumably the result of the dramatic increase in motor vehicles in urban areas. Nationwide, from 1989–2006, the number of cars, trucks, and buses in Chinese cities increased from 13 million to 37 million (Fridley & Arden, 2008).

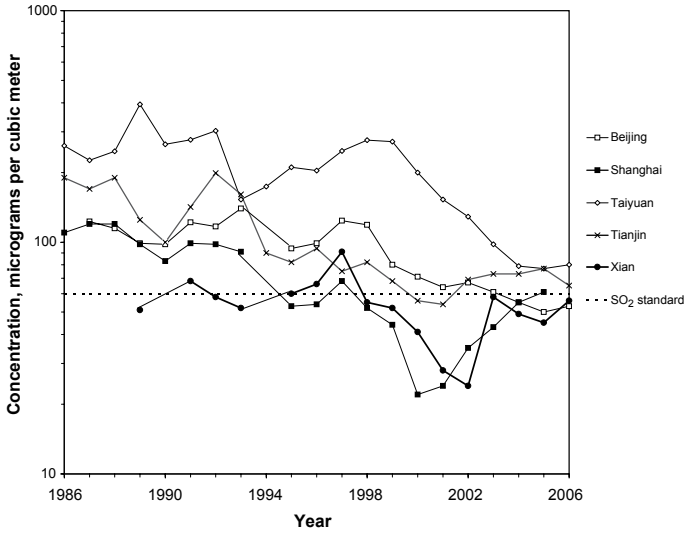
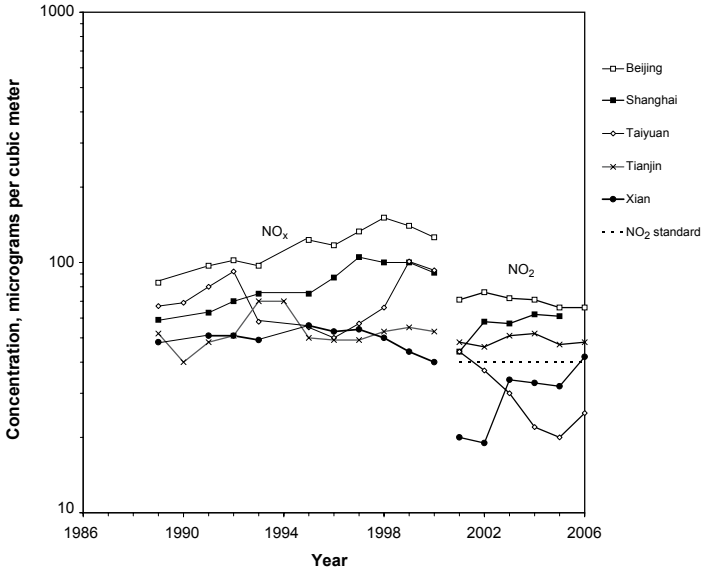

Figure 2. Average annual SO₂ concentrations in five Chinese cities, showing comparison with the secondary standard for annual average concentration.



Source: Ministry of Environmental Protection, various years.

Figure 3. Average annual NO_x (1988–2000) and NO₂ (2001–2006) concentrations in five Chinese cities, showing comparison with the secondary standard for annual average concentration.

Source: Ministry of Environmental Protection, various years.

Air Pollution Management and Emission Trends

The history of air pollution control in China is summarized by Sun (2001). China's first national environmental protection law was implemented on a trial basis in 1979, and China's first air pollution control measures were introduced by local governments in the mid-1980s to address high particle levels. These measures included retrofitting coal boilers with cyclones, substituting coal briquettes and gaseous fuel for raw coal in household stoves used for cooking and heating, and replacing smaller residential heating units with larger centralized heating. These measures were responsible for the dramatic declines in particle levels experienced in the 1980s and 1990s by many northern cities with cold weather and high coal consumption.

Since then, both local and national governments have implemented a variety of laws, standards, and regulations to manage air pollution. In addition, each province has passed its own environmental regulations. In the following sections, we describe the progress that the five selected cities in China have made in recent years in pursuing a variety of air pollution control strategies. Other Chinese cities have adopted similar strategies.

Air Pollution Management in Beijing

In the decade leading up to the 2008 Olympic Games, the Beijing municipal government established an aggressive program of air pollution management, consisting of 11 measures aimed at industry, agriculture, construction, transportation, and residential heating (Chai et al., 2006). The measures included closing or moving large industrial facilities far from the city, installing flue gas desulfurization in power plants, substituting gas for coal in many applications, reformulating gasoline and removing old vehicles from the roadways, and reducing dust from construction sites.

These control measures were highly effective in reducing emissions, which, in turn, reduced airborne levels. In China, data on particle and SO₂ emissions are self-reported by every enterprise that operates a boiler or furnace, including industrial, commercial, residential, and government entities. Enterprises estimate their emissions based on regulatory formulas that use the mass of coal burned, coal ash and sulfur content, and the technology for flue gas treatment. Reported emissions of particles and SO₂ by enterprises in Beijing from 1998 to 2005 are shown in Figures 4 and 5. Note that the designation of "particles" is not necessarily the same as TSP measured in ambient air reported above. TSP is an operational definition referring to all

particles collected by the samplers used for ambient monitoring, while the particle emissions in Figure 4 are estimates based on the regulatory formulas.

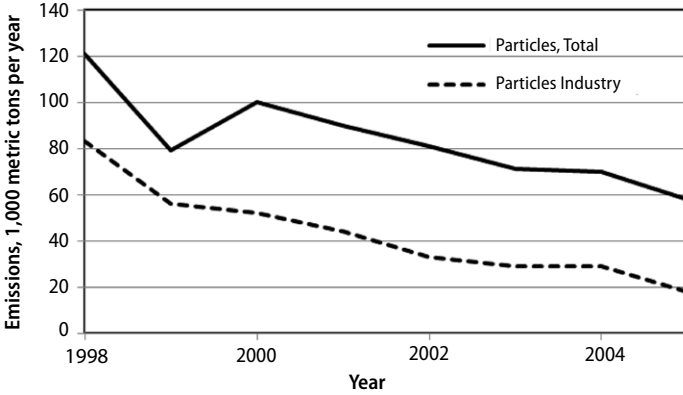

Figure 4. Self-reported particle emissions in Beijing from coal combustion by industrial, commercial, residential, and governmental end users.

Source: Fridley & Arden, 2008.

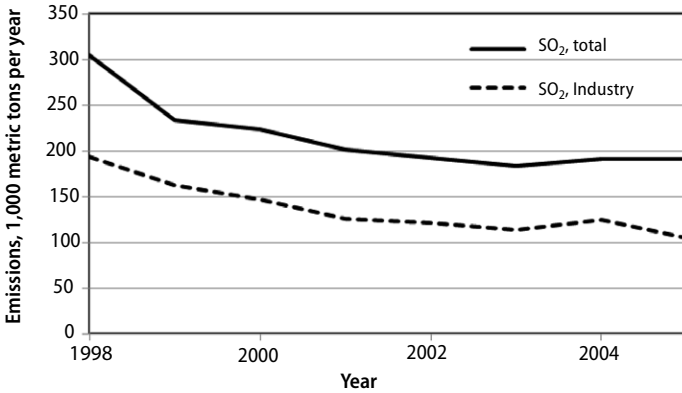

Figure 5. Self-reported SO₂ emissions in Beijing from coal combustion by industrial, commercial, residential, and governmental end users.

Source: Fridley & Arden, 2008.

Automobile Emission Control

In 1995, Beijing started a pilot inspection/maintenance program. This program, which was upgraded to full-scale operations beginning in 1999, focused on CO. In addition, an acceleration simulation mode testing program was implemented specifically to reduce PM₁₀ and NO_x emissions beginning

in 2003. Many older vehicles were required to obtain retrofits to reduce emissions. For example, approximately 190,000 carbureted vehicles registered after 1995 were retrofitted with three-way catalysts between 1998 and 2001. This retrofit reduced CO emissions by 78–90% and reduced hydrocarbon plus NO_x emissions by 71–88% immediately after the retrofit (Hao et al., 2006).

In 1999, the Beijing municipal government implemented the Euro 1 emission standard, which was then adopted by all of China the following year. In 2003, Beijing also implemented the Euro 2, which was subsequently adopted across China in 2004. The two standards are shown in Table 2.

Table 2. Euro 1 and Euro 2 emission standards

Vehicle type	Emission standard	Maximum Emissions				
		CO	HC + NO _x	HC	NO _x	PM
Light-duty gasoline automobiles (g/km)	Euro 1	3.16	1.13	—	—	—
	Euro 2	2.20	0.5	—	—	—
Heavy-duty diesel vehicles (g/kwh)	Euro 1	4.5	—	1.1	8	0.36
	Euro 2	4.0	—	1.1	7	0.15

Note: kwh = kilowatt-hours.

Source: Hao et al., 2006.

Beijing adopted a law requiring the retirement of older vehicles starting in 2003. All light-duty cars are forced to retire in 15 years, while taxis and buses are forced to retire in 8 years. In 1999, the government increased the taxes on leaded gasoline to discourage its use. Furthermore, a new rule granted a 30% reduction in the excise tax, which is 5% of the vehicle price for a typical car in China, for light-duty vehicles meeting Euro 2 emission standards. This rule went into effect at the end of 2001, prior to the requirement of Euro 2 standards in Beijing in 2003 (Hao et al., 2006).

Closing and Relocating Industries

Since 2000, the Beijing municipal government has undertaken a major effort to relocate industries with high pollutant emissions. At the end of 2000, the Beijing Steel Alloy Company closed and the Beijing Yanshan Cement Company moved to the city of Tangshan, 200 miles southeast of Beijing. The Beijing Coke Industry, one of the largest pollutant emitters in the city, closed in 2006. The biggest company to relocate thus far is Beijing Capital Steel

Company. Starting in 2002, with a total steel production of 8 million metric tons per year, this company decreased its operations by 2 million metric tons per year while building a new facility in Hebei province. The company eventually closed a blast furnace, four sinter boilers, one coke plant, and three converters at its Beijing location. By the end of 2007, the company had moved its entire production to the new location, which had state-of-the-art equipment.

Changes in Energy Sources

Changing furnaces from coal to natural gas or to coal gas can be an effective way to decrease air pollutants, especially SO_2 . Coal gas, a synthetic gas made from coal, is composed of hydrogen, carbon monoxide, methane, and volatile hydrocarbons. Natural gas and coal gas have replaced coal for residential heating in Beijing. Coal has also been replaced as a raw material in the chemical industry and in industrial boilers, stoves, and furnaces.

From 1990 to 2005, total energy consumption in Beijing more than doubled, from 27 Mtce per year to 55 Mtce per year, where Mtce is million metric tons of coal equivalent (Beijing Municipal Statistics Bureau, 2006). This increase in consumption has been accompanied by a significant change in the sources of energy consumed. In particular, Figure 6 shows that the direct use of coal has been replaced by direct use of natural gas and by the use of electricity. Although electricity in China is largely generated by coal, it is listed as a separate category in the figure because managing the combustion process in large, centralized power generation plants allows more efficient control technology to be used to reduce emissions. Furthermore, the pollutants are emitted at the power plants, which are usually located in less densely populated areas compared with urban residences. The percentage of direct coal use in total energy consumption decreased from 77% in 1990 to 21% in 2005; the percentage of electricity use increased from 9% to 35%; the percentage of natural gas use increased from 1.4% to 8.4%; and the percentage of petroleum (in the form of liquefied petroleum gas and gasoline) increased from 6% to 25%. Much of the reduction in pollutant concentrations summarized in Figures 1 and 2 is the result of these changes in energy sources. Table 3 shows the emission standards for Beijing for TSP, SO_2 , NO_x , and opacity of the plume based on the Ringelmann number.

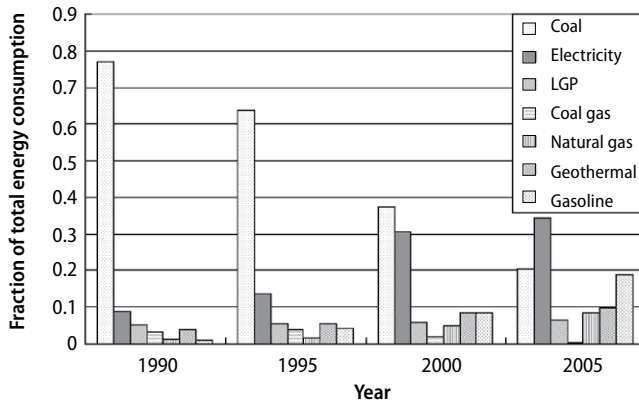

Figure 6. Sources of energy consumed in Beijing from 1990 to 2005.

Source: Beijing Municipal Statistics Bureau, 2006.

Table 3. Emission standards for boilers in Beijing

	Power Plant Boiler	Industry Boiler
TSP (mg/m ³ in the plume)	10	10
SO ₂ (mg/m ³ in the plume)	20	20
NO _x (mg/m ³ in the plume)	100	150
Ringelmann number	1	1

Source: Beijing Municipal Environmental Protection Bureau, 2007.

Construction Site Dust Control

Extracted surface soils at construction sites are usually stored on site for 1 or 2 days before being transported. Based on Beijing's Air Pollution Prevention and Control Law (Chai et al., 2006), this soil must be covered, which is often done with plastic canvas. Trucks transporting the soil must also be covered. Similar regulations for construction sites as well as for mobile and stationary sources can be found in the local Air Pollution Prevention and Control Laws for each of the other four cities.

Air Pollution Management in Shanghai

The Shanghai municipal government began implementing air pollution control measures in 1976. In the first 7 years of its control program, 17 large industrial boilers were renovated, and this decreased self-reported particle emissions by 25,000 metric tons over this period. Between 1982 and 1985, many small industrial boilers were renovated. These measures were largely

responsible for a 38% decrease in dust fall between 1978 and 1984. From 1986 to 1988, the government passed several particle emission regulations that required industries to install precipitators. The efficiency of these precipitators was required to be 50% after this 2-year period. In 1990, the minimum efficiency was increased to 70%, and in 1992 it was increased to 81%. This last regulation required companies to use multicyclones rather than monocyclones for their precipitators. As a result, the average TSP concentration in plumes emitted from industries in Shanghai decreased from 378 mg/m³ to 241 mg/m³ (Li, 1996).

Relocation of Industries

He Tian is an industrial area of Shanghai with 32 major companies, each having significant emissions. The municipal government began moving these companies out of the city in 1992, and as a result coal consumption in the Shanghai urban area decreased steadily: 5,000 kt in 1993, 4,500 kt in 1994, and 3,900 kt in 1995 (Li, 1996), where kt is a thousand metric tons. Starting in 2000, all electricity generating plants using coal in the city were required to install desulfurization equipment.

Changes in Energy Sources

With a rapidly increasing population and rapidly increasing energy consumption, Shanghai is the largest city in China. Because of efforts to control escalating coal use, the proportion of energy supplied by coal decreased by 5–8% between the 5-year period beginning in 1995 and the 5-year period beginning in 2000. However, the total amount of coal used in Shanghai increased from 45 million metric tons in 2000 to 53 million metric tons in 2005 (Qian & Wang, 2004).

There are other areas of progress. By 2005, nearly 3,300 small and midsized boilers had switched from coal to natural gas, thus decreasing their emissions by 10 kt for PM₁₀, 57 kt for SO₂, and 15 kt for NO_x.

To decrease SO₂ emissions from direct coal use in residences, the municipal government encouraged citizens to use coal gas as a substitute. By the end of 2000, 86% of families in the city used coal gas, which decreased SO₂ emissions from direct coal use in residences by about half (Qian & Wang, 2004).

The fraction of energy contributed by each source during the period 2001–2005 is shown in Figure 7.

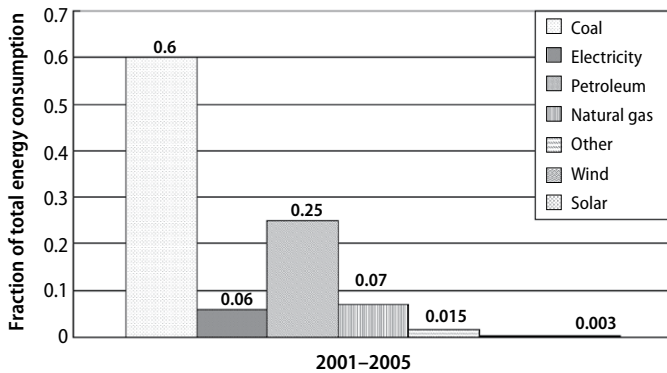

Figure 7. Sources of energy consumed in Shanghai from 2001 to 2005.

Source: Data are from Qian & Wang (2004).

Air Pollution Management in Taiyuan

Because Taiyuan was one of the most polluted cities in China, the local government passed a series of regulations to control air pollution, including the clean development regulation and particulate control laws (Wang, 2004).

Taiyuan has also attempted to decrease industrial emissions. Because small companies emit more pollutants per unit product than larger companies, in 2004 the government closed all the cement factories with a capacity less than 300,000 metric tons per year. The government also closed all paper, steel, and coke plants with annual capacities less than 0.5 million, 0.5 million, and 0.4 million metric tons, respectively.

Taiyuan implemented the Kyoto Protocol Clean Development Mechanism by switching from coal to natural gas in 2,000 boilers and closing 600 boilers in a 177 km² emission control area within the city. In 2003, every company emitting sulfur in Taiyuan was required to install desulfurization equipment. This measure decreased SO₂ by 2,500 metric tons in that year. Also in 2003, a 21 km² clean fuels area and a 3 km² coal-free area were established within the city.

By building a centralizing heating system, Taiyuan was able to close 718 small boilers, which decreased coal use by 95,000 metric tons per year and reduced annual emissions of TSP and SO₂ by 48,000 metric tons and 38,100 metric tons, respectively.

Air Pollution Management in Tianjin

Tianjin is 200 km southeast of Beijing. Like most cities in northern China, the major air pollutants there were from coal combustion, automobile emissions, and construction sites. To reduce air emissions, the government took similar measures as in Beijing, such as substituting natural gas for coal in boilers. By April 1999, over 19,000 residential boilers and 500 industrial boilers had been converted to natural gas. Based on the Air Pollution Control and Prevention Act for the city of Tianjin, a coal-free area was established, and sources outside this area were required to use low-sulfur coal. Dust from construction sites has also been regulated.

Air Pollution Management in Xian

The municipal government of Xian made progress in air pollution control beginning in the 1980s. Of the total particle emissions in the city, 40% comes from soil, 27% from coal combustion, and 22% from construction sites.

The Xian government has promulgated several laws to restrict air pollutant emissions, such as the Air Pollution Control Act Phase I (City of Xian, 1999), Phase II (City of Xian, 2000), and Phase III (City of Xian, 2001). Xian has also enforced the national standard for air pollutant emissions from boilers (State Environmental Protection Administration, 2002). The following is a summary of some of the most important changes in Xian:

- Seventy-five percent of the automobiles in Xian are required to pass an emission test, and this is enforced through fines.
- An area of coal combustion control was established for 92% of the city land area by 2006. (Achieving this required updating boilers and using low-sulfur coal.)
- Residents were provided with natural gas for domestic use instead of coal.
- Dust emissions from construction sites were reduced by covering excavated soil.

The use of natural gas was especially important: During Air Pollution Control Act Phase III, approximately 40,000 families switched from coal to natural gas. This significantly reduced the amount of coal use in Xian, as shown in Table 4. But economic development and associated emissions from other sources were probably responsible for preventing the airborne SO₂ concentration from decreasing substantially over the longer term, as indicated by Figure 2.

Table 4. Residential energy fuel mix in Xian, 1995–2000

Type of Energy	1995	1996	1997	1998	1999	2000
Liquefied Petroleum Gas (t)	29,000	30,300	27,500	26,800	39,200	43,000
Natural Gas (10 ⁴ m ³)	~0	~0	61	1,250	4,050	11,500
Coal (10 ⁴ t)	18,400	8,370	8,230	7,830	3,750	2,160

Note: t = metric tons.

Source: Cheng, 2003.

Conclusion

In recent years, air quality in major Chinese cities has improved. The municipal governments no longer focus only on economic development; they also take steps to improve environmental quality. Particle levels have decreased rapidly in the past 20 years, although PM₁₀ is still the air pollutant most frequently in violation of ambient standards. As a result of establishing coal-free regions within cities, use of low sulfur coal, and other actions, airborne SO₂ is decreasing in most, but not all, urban areas. Most of these cities also target specific sources for air pollutant regulation, focusing on four strategies. The first is automobile emission control, especially in Beijing where the government is restricting operation of vehicles and establishing laws to reduce emissions. The second is closing, renovating, or relocating industries. The third is changing sources of energy, such as switching from coal to natural gas. The fourth is dust control at urban construction sites. Air pollution levels may continue to decrease in Chinese cities as additional pollutant regulations are established.

Despite reduction of emissions in Chinese cities, long-range transport from rural areas can contribute substantially to urban air pollutant concentrations as local emissions in cities are reduced. This has been documented in other countries and has recently been documented in China as well (Streets et al., 2007). Furthermore, improving standards of living are likely to increase energy use, which may counteract pollution reduction efforts. Increasing population levels in these cities will also put upward pressure on pollution levels.

Acknowledgments

The authors wish to thank Dr. Thomas Rawski, Department of Economics, University of Pittsburgh, for his help with this work.

References

- Beijing Municipal Environmental Protection Bureau and the Beijing Quality and Technical Supervision Bureau. (2007). *Emission standard of air pollutants for boilers* (Report DB11/139-2007, implemented September 1, 2007). Retrieved from <http://www.bjepb.gov.cn/bjhb/portals/0/fujian/zwgk/flfg/20070904.pdf>. (in Chinese)
- Beijing Municipal Statistics Bureau, Industrial Transportation Statistics Office, Industrial Investigative Branch. (2006). *Beijing energy and economic development analysis* (2006-08-23). Retrieved from http://www.bjstats.gov.cn/lcdxxt/tjfx/tjbg/200609/t20060901_62529.htm. (in Chinese)
- Chai, F., et al. (2006, July). Analysis of effectiveness of air pollutant emission control in Beijing. *Environmental Protection*, 49–52. (in Chinese)
- Cheng, J. (2003, September). Changing from coal to natural gas to improve air quality in the city of Xian, *Journal of Changan University—Arch. and Envir. Science Edition*, 44-47. (in Chinese)
- City of Xian. (1999). Air Pollution Control Act Phase I, 1999. Retrieved from <http://law.lawtime.cn/d456068461162.html>. (in Chinese)
- City of Xian. (2000). Air Pollution Control Act Phase II, 2000. Retrieved from http://law.laweach.com/rule_200367_2.html. (in Chinese)
- City of Xian. (2001). Air Pollution Control Act Phase III, 2001. Retrieved from <http://www.66law.cn/lawlib/viewlawlib.aspx?id=74159>. (in Chinese)
- Fridley, D., & Arden, N. (Eds.) (2008). *China energy databook* (7th ed.). Berkeley, CA: Lawrence Berkeley Laboratory.
- Hao, J., Hu, J., & Fu, L. (2006). Controlling vehicular emissions in Beijing during the last decade. *Transportation Research, Part A: Policy and Practice*, 40, 639–651.
- Jaheil, A. R. (1998). The organization of environmental protection in China. *The China Quarterly*, 156, 757–787.
- Li, J. (1996). Analysis of countermeasure effects of amelioration on atmospheric quality in Shanghai, *Shanghai Environmental Science*, 15, 1–3. (in Chinese)

- Ministry of Environmental Protection. (1986–1999, 2001–2006). *China environment yearbook series*. Beijing: China Environment Yearbook Publishing House. (in Chinese)
- Qian, H., & Wang, B. Y. (2004) Factors influencing ambient air quality in Shanghai, *Journal of Environmental and Occupational Medicine*, 21, 245–247. (in Chinese)
- State Environmental Protection Administration. (1996). *Ambient air quality standard* (GB 3095-1996, implemented October 1, 1996). Retrieved from <http://www.sepa.gov.cn/image20010518/5298.pdf>. (in Chinese)
- State Environmental Protection Administration. (2002). *Emission standard for air pollutants from coal-burning, oil-burning and gas-fired boilers* (GB 13271-2001, implemented January 1, 2002). Retrieved from <http://www.lhepb.gov.cn/showinfo.asp?xid=4&id=372>. (in Chinese)
- Streets, D. G., Fu, J. S., Jang, C. J., Hao, J., He, K., Tang, X., . . . Yu, C. (2007). Air quality during the 2008 Beijing Olympic Games. *Atmospheric Environment*, 41, 480–492.
- Sun, G. (2001) *An integrated study of China's air pollution management*. Unpublished doctoral dissertation. Department of Engineering and Public Policy, Carnegie Mellon University, Pittsburgh, PA.
- Wang, Z. (2004, May). Analyses of air pollution in Taiyuan and control countermeasures. *Shanxi Science and Technology*, 25–26. (in Chinese)

Contributors

Michael P. Anisimov, Dr.Sci. in physics and mathematics, Ph.D. in aerosol science, and MD in thermophysics, is head of the Nanoaerosol Research Laboratory at the Technological Design Institute of Scientific Instrument Engineering, Siberian Division of the Russian Academy of Sciences, Novosibirsk, Russia. He is also research professor at Clarkson University, Potsdam, USA. Dr. Anisimov is the founder of the Nucleation Research Laboratory at Siberian Division of the Russian Academy of Sciences at Kemerovo. He is developing semiempirical design of the nucleation rate surfaces over diagrams of phase equilibria and a flow diffusion chamber as a new tool for studies of supersaturated vapor nucleation kinetics. Since 2007, he has been Editor-in-Chief of *The Open Physical Chemistry Journal*.

Oliver F. Bischof received a degree in chemical engineering from the University of Technology in Dresden, Germany, and did his final year at the Particle Technology Group of Delft University of Technology, Netherlands. From 1991 to 1992 he visited the Particle Technology Group at Loughborough University of Technology, Great Britain. He has worked at TSI Inc., since 1994 and currently heads the research and analytic team in Europe, the Middle East and Africa. His interests are in aerosol instrumentation, atmospheric aerosols, and particulate exhaust emissions. From 2006 to 2010 he was an elected member of the board of GAeF,

the German Association for Aerosol Research. In 2009, he received the NOSA Aerosologist Award of the Nordic Society for Aerosol Research recognizing his contributions in the field of aerosol instrumentation and his encouragement of the work of young Nordic scientists.

Donald L. Blumenthal, Ph.D., is co-founder and chairman of Sonoma Technology, Inc. His contributions to the air quality field include his work on understanding the three-dimensional distribution and transport of pollutants; pioneering use of light aircraft to document pollutant spatial distributions, transport, and transformations; and design and management of large-scale field studies. Dr. Blumenthal is a past chair of the Editorial Review Board of the *Journal of the Air & Waste Management Association*. He was awarded the association's 2001 Frank Chambers Award for outstanding achievement in the science and art of air pollution control.

William E. Clark, Ph.D., completed his Ph.D. and joined the Rockwell Science Center where he worked with Dr. George M. Hidy analyzing ACHEX data and taking part in subsequent aerosol monitoring studies utilizing the ACHEX mobile laboratory. After two years, he joined the Rockwell Air Monitoring Center where he was involved in aerosol monitoring programs for the Environmental Protection Agency. In 1977, he became a professor in the Environmental Engineering Department, California Polytechnic

State University, and later joined the Mechanical Engineering Department. He retired from Cal Poly in 2004.

Beverly S. Cohen, Ph.D., is a professor of environmental medicine at the New York University School of Medicine (NYU-SOM). She is a recognized expert in inhalation exposure and dosimetry, aerosol measurements, and occupational and environmental health. Dr. Cohen has served on government and professional expert committees including the Safety and Occupational Health Study Section, National Institute of Occupational Safety and Health, Centers for Disease Control and Prevention and the U.S. Department of Energy Advisory Committee to the Rocky Flats Beryllium Health Surveillance Study. She was associate editor of the journal *Aerosol Science and Technology* from 1996 to 2003. Dr. Cohen has authored over 100 scientific publications and textbook chapters, served as co-editor for two editions of *Air Sampling Instruments for the Evaluation of Atmospheric Contaminants* (American Conference of Governmental Industrial Hygienists, Cincinnati, OH, 2001) and is a co-author of *Environmental Health Science: Recognition, Evaluation and Control of Chemical and Physical Health Hazards*. She also served as director of the NYU-SOM NIEHS Center's Facility in Inhalation and Exposure Assessment and of the Exposure, Dosimetry, and Modeling Research Core of the EPA-NYU PM10 Center.

Ian Colbeck, Ph.D., is professor of aerosol science at the University of Essex. He has edited a number of books related to aerosol science. His current research focuses on physico-chemical properties of aerosols, indoor air quality, and environment–society interactions.

Cliff Davidson, Ph.D., received a bachelor of science in electrical engineering from Carnegie Mellon University, and his master's and Ph.D. degrees in environmental engineering science from California Institute of Technology. He served for 33 years on the Carnegie Mellon faculty in the Department of Civil and Environmental Engineering (CEE) and the Department of Engineering and Public Policy (EPP). In 2010, he moved to Syracuse University where he is the Thomas C. and Colleen L. Wilmot Professor in the Department of Civil and Environmental Engineering and the Syracuse Center of Excellence in Environmental and Energy Systems. He also has adjunct appointments in the CEE and EPP Departments at Carnegie Mellon.

David S. Ensor, Ph.D., is a distinguished fellow at RTI International. He received a bachelor of science in chemical engineering from Washington State University. He has a master's degree in chemical engineering and a Ph.D. in engineering from the University of Washington. Dr. Ensor has over 40 years experience in the field of aerosol science. He was President of the American Association for Aerosol Research (1988–1990) and is a founding editor of *Aerosol Science and Technology*. Dr. Ensor is an adjunct professor of environmental engineering at the University of North Carolina at Chapel Hill. He has published over 90 peer reviewed publications and 200 presentations, and received 7 patents.

H. Keith Florig, Ph.D., holds Ph.D.'s in engineering and public policy, as well as master's degrees in nuclear science, engineering, and physics from Carnegie Mellon University. Currently, he is associate research

scholar at the Warrington College of Business, University of Florida, and adjunct professor in the Department of Engineering and Public Policy at Carnegie Mellon University. He has 30 years of research, teaching, and consulting experience in the analysis of environmental, energy, security, and business risks, which includes extensive work in China. His research in these areas has been published in numerous journals such as *Environmental Science and Technology*, *Health Physics*, *Risk Analysis*, and *Science*.

Kaarle Hämeri, Ph.D., is a professor in aerosol physics in the University of Helsinki, Finland. He is working on topics related to atmospheric aerosols, air quality, and climate change and health effects.

Hans-Christen Hansson, Ph.D., is a professor in physics in the Stockholm University. He is working on topics related to urban aerosols and air quality as well as aerosol-climate -interactions.

Pertti Hari, Ph.D., is a retired professor in forest ecology in the University of Helsinki, Finland. His research activity is forest-atmosphere-interaction.

George M. Hidy, Ph. D., is currently a principal of Envair/Aerochem, where he continues his research on atmospheric aerosols. He has worked in this area of science for more than 50 years as a student and colleague of Professor S. K. Friedlander. In the 1970s, Dr. Hidy was co-principal investigator of the California Aerosol Characterization Experiment (ACHEx), and later the Sulfate Regional Experiment. He is the author of more than 150 publications, including three books on aerosol science. His leadership includes acting as a vice president of Environmental

Research and Technology, Inc., president of the Desert Research Institute and vice president, Environment Division of the Electric Power Research Institute.

Helmuth Horvath, Ph.D., graduated from the University of Vienna and spent several years with research institutions abroad, including the University of Washington, the University of Colorado at Boulder, the Universidad de Santiago de Chile, and the University of Kyoto. He was professor of experimental physics at the University of Vienna and director of the Institute of Experimental Physics; he retired in 2006. His research interest is aerosol science, especially aerosol optics. Throughout his career, he conducted aerosol optical measurements with newly developed instruments. He mentored many master's and doctoral students and also taught classes covering various aspects of aerosol science at the University of Vienna as well as at other institutions.

Matti Jantunen, Ph.D., research professor at the National Institute for Health and Welfare, Department of Environmental Health, Kuopio, Finland, is an engineer with a Ph.D. from the University of North Carolina at Chapel Hill. He has over four decades of work related to aerosol physics and chemistry, outdoor and indoor air, combustion-generated and bio-aerosols, stack and traffic emissions, atmospheric transformation, outdoor to indoor penetration and human exposure to and source attribution of aerosols, and aerosols from Chernobyl. Between 1989 and 1995, he coordinated the EU Air Pollution Epidemiology Programme and since then several international research projects, most importantly EXPOLIS, which laid foundations for European air pollution exposure data.

David B. Kittelson, Ph.D., received his Ph.D. in chemical engineering at the University of Cambridge, England. He joined the Department of Mechanical Engineering at the University of Minnesota in 1970 and is currently the director of the University's Center for Diesel Research. He has worked for more than 40 years on improving performance and reducing emissions from engines. Current research includes sampling and characterization of ultrafine and nanoparticles from engines; development of advanced engine exhaust after treatment systems; production and use of biofuels, including biodiesel, butanol, DME, Fischer-Tropsch liquids, ethanol, and biocrudes; reduction of greenhouse gas emissions from transportation; use of hydrogen rich gases to modify combustion in engines; and development of fast response sensors for engine control. He is a fellow of the Society of Automotive Engineers.

Thomas H. Kuehn, Ph. D., is a professor in the Department of Mechanical Engineering at the University of Minnesota. Since 1983, he has conducted research within the University's Particle Technology Laboratory. He has published over 100 journal articles and 40 technical reports on topics related to thermal sciences and aerosols and co-authored a text book on HVAC&R. His main areas of aerosol research include measurements and modeling of aerosol generation and transport within buildings primarily in commercial kitchens and more recently various aspects of bioaerosols, including the airborne transmission of viral disease. In addition to teaching and research, Professor Kuehn has held administrative positions including director of graduate studies and director of the environmental division within the department.

Markku Kulmala, Ph.D., is an academy professor at the University of Helsinki, Finland. His main research activity focuses on the formation and growth of atmospheric aerosols.

Benjamin Y. H. Liu, Ph.D., is currently CEO/president of MSP Corporation, a company he cofounded with Virgil A. Marple. He earned his Ph.D. in solar energy at the University of Minnesota. He began his aerosol research in collaboration with Professor Kenneth T. Whitby in the Particle Technology Laboratory in 1962, becoming a full professor in 1969, and the laboratory director in 1972. Dr. Liu was elected to the National Academy of Engineering in 1987 for his contribution to aerosol and solar energy research. In 1995, he was named a Regents' Professor, the highest academic honor given to a faculty member at the University of Minnesota. He also served as the president of the American Association for Aerosol Research (1986–1988), a founding editor-in-chief of *Aerosol Science and Technology* (1981–1993) and a co-recipient of the Fuchs Memorial Award (1994). He retired from the University of Minnesota in 2002.

Alexey Lushnikov, Ph.D., is a graduate of the Moscow Engineering Physical Institute, with a specialization in theoretical nuclear physics. Dr. Lushnikov received his doctorate from the Karpov Institute of Physical Chemistry; he has been affiliated with the Institute for nearly four decades. Since 1976, he has been the head of the Laboratory for Physics of Aerodispersed Systems. Dr. Lushnikov's main areas of interest include the kinetics of a single aerosol particle, coagulation, and the optics and electrodynamics of aerosols. He has published nearly 130 papers and reviews in peer-reviewed professional journals.

Virgil A. Marple, Ph.D., is currently a professor of mechanical engineering at the University of Minnesota with a research focus on inertial separation and classification of aerosol particles, and the development and evaluation of inertial particle classifiers. His doctoral research, a fundamental study of inertial impactors, was carried out under Dr. Benjamin Y. H. Liu. After completing his Ph.D. in 1970, he joined the faculty at the University of Minnesota, becoming a full professor in 1977. He continued his work on inertial particle separation and went on to develop various inertial impactors, and conduct studies on industrial respirable aerosols in the mining industry. He joined Dr. Liu in cofounding MSP Corporation to explore commercial application of aerosol science and technology, and to make these impactors commercially available. In 1988, he received the first David Sinclair Award for his work in the field of aerosol science and technology. He is currently director of a Particle Calibration Laboratory within the Particle Technology Laboratory.

Rolf Mattsson, Ph.D., is a retired research professor at the Finnish Meteorological Institute (FMI). He started the FMI's monitoring program for airborne radioactivity in the late 1950s and worked extensively in the utilization of airborne natural and artificial radionuclides as tracers in air quality and meteorological studies. Dr. Mattsson was also an adjunct professor (docent) at the Laboratory of Radiochemistry, University of Helsinki.

Peter H. McMurry, Ph.D., joined the mechanical engineering faculty at the University of Minnesota in 1977. He served as department head from 1997–2007 and was named Kenneth T. Whitby Professor in 2000. He holds

a bachelor's degree in physics from the University of Pennsylvania, and master's of science and Ph.D. (physics minor) in environmental engineering sciences from the California Institute of Technology. He served as president of the American Association for Aerosol Research from 1994–1995 and became editor-in-chief of *Aerosol Science and Technology* in 2008. He has received Fulbright (1989) and Guggenheim (2007) fellowships and several professional awards including the Fuchs Memorial Award (2006).

Volker A. Mohnen, Ph.D., is professor emeritus of the Department of Atmospheric Sciences at the State University of New York at Albany. He received his bachelor's degree (physics, 1959) from University Karlsruhe, his master's degree (meteorology, physics, 1963) from University Munich, and his Ph.D. (physics, meteorology, astrophysical, 1967) from University Munich. He is the former director of the Atmospheric Sciences Research Center of the university. He directed the World Meteorological Organization-Quality Assurance/Science Activity Center for the Americas. Dr. Mohnen is also affiliated with the Institute for Atmospheric Environmental Research in Garmisch-Partenkirchen, Germany. His main research activities focus on the atmospheric aerosols including cloud interactions and acid rain. He has published more than 300 scientific articles and reports. Dr. Mohnen is a Fellow of the American Association for the Advancement of Science, the New York Academy of Sciences, and the American Meteorological Society.

Christopher A. Noble, Ph.D., is an aerosol chemist with over 20 years of experience in environmental research, analysis, and modeling. He has a

bachelor's degree in engineering-physics from Point Loma Nazarene University (1990) and a Ph.D. in analytical chemistry from the University of California, Riverside (1999). Dr. Noble received the American Association of Aerosol Research Sheldon K. Friedlander Award for his doctoral dissertation *Single Particle Analysis of Transient Variations Occurring in Atmospheric Aerosols*.

Thomas C. O'Connor, Ph.D., is a retired lecturer in physics at the National University of Ireland Galway with a life-long interest in the history of aerosol science. He was the founder of the university's Atmospheric Research Station at Mace Head for the study of the marine atmosphere, and of the Air Quality Technology Center for studies on urban and indoor air pollution that are now incorporated into the Center for Climate and Air Pollution Studies.

Bernard A. Olson, Ph.D., is a senior research associate and particle calibration laboratory manager in the Particle Technology Laboratory of the Mechanical Engineering Department at the University of Minnesota. He received his doctorate and has been affiliated with the University of Minnesota for the last 23 years. His fundamental research has focused on the inertial separation of particles with an emphasis on computational fluid dynamics analysis. His main areas of interest include the development and calibration of aerosol sampling instruments, and particulate emissions characterization.

Jussi Paatero, Ph.D., is a head of laboratory at the Finnish Meteorological Institute (FMI). He has been working with the FMI's monitoring program for airborne radioactivity since 1990. His prior position was at the Laboratory of Radiochemistry, University of Helsinki,

where he studied the deposition of transuranium elements from the Chernobyl accident and their transfer along terrestrial food-chains.

Christer Persson is programme manager at the Swedish Meteorological and Hydrological Institute, with a lifelong interest in atmospheric transport and dispersion processes and atmospheric chemistry. He was involved in the early tracing of radioactivity over Sweden to a nuclear power plant in southwest Soviet Union, which subsequently was confirmed by the Soviet Union's official information about the Chernobyl reactor accident. Recently, he has been active as programme manager for a pan-European gridded climate data project. In 2010, he participated with European expert groups on volcanic ash crisis prevention and management.

Sotiris E. Pratsinis, Ph.D., was professor (1985–2000) of chemical engineering at the University of Cincinnati, Ohio until 1998 when he was elected professor of mechanical and process engineering at the Swiss Federal Institute of Technology (ETH Zurich) Zurich, Switzerland. There he founded the Particle Technology Laboratory. His research focuses on aerosol dynamics and synthesis of materials for ceramics, catalysts, sensors and biomaterials. He has published more than 300 refereed articles and received 20 European and U.S. patents licensed to various industries. He has contributed to the formation of four spinoffs, received a number of awards, and serves on the editorial board of six scientific journals.

Othmar Preining (1927–2007), Ph.D., did his Ph.D. thesis with Felix Ehrenhaft on photophoresis and learned about the science of submicrometer particles when

the word aerosol was almost unknown. He broadened his knowledge in this field as a post-doctoral student at the California Institute of Technology, and returned to the University of Vienna, where he built up the world famous Vienna Aerosol Group. He spent many years at research institutions around the world, both trying to promote aerosol science and to keep up with latest developments. As professor of physics he taught interesting classes and motivated many students to do a thesis in aerosol science.

David Y. H. Pui, Ph.D., is a Distinguished McKnight University Professor and the L. M. Fingerson/TSI Inc. Chair in mechanical engineering at the University of Minnesota. He received his Ph.D. in mechanical engineering in 1976 with Dr. Benjamin Liu as advisor, and is currently the third director of the Particle Technology Laboratory. He has published more than 200 journal papers and received 18 patents. His research has focused on industrial applications of aerosol technology, and on developing instrumentation and experimental techniques for aerosol measurements. He has led several successful industrial projects and is currently the director of the Center for Filtration Research consisting of ten major filter manufacturers and end users. He received the Fuchs Memorial Award at the International Aerosol Conference in Helsinki in 2010.

Taisto Raunemaa (1939–2006), Ph.D., was a Finnish professor and physicist, referred to as the father of Finnish aerosol. He received his master's degree in physics from Helsinki University in 1965 and a Ph.D. in nuclear physics in 1975. He was a professor in physics in the Department of Environmental

Science at the University of Kuopio, Finland from 1983–2004. He was the founder of the Environmental and Aerosol Physics group at the University of Helsinki and of the Laboratory of Atmospheric Physics and Chemistry at the University of Kuopio.

Gilmore J. Sem began working for Thermo-Systems Inc. (later TSI Inc.) in 1967 as an aerosol instrument development engineer. He designed the commercial versions of the electrical aerosol analyzer, differential mobility analyzer, condensation particle counter, diffusion battery, and many other aerosol instruments. In 1978, he became technical manager of aerosol instruments, responsible for engineering and manufacturing and later added sales and marketing to his responsibilities. He was responsible for the profitable operation of the aerosol group until 2002, when he became director of market development for aerosol instruments, retiring in 2007. He was elected to the American Association of Aerosol Research (AAAR) board of directors in 1985, becoming secretary in 1988. He served on many AAAR committees and developed conference sessions on the history of aerosol instrumentation. He helped organize of the first three Symposia on the History of Aerosol Science. He was co-chairperson (with Dr. David Pui) of the 2006 International Aerosol Conference, St. Paul. He received the Benjamin Y. H. Liu Award from AAAR for his work with differential mobility particle sizing in 2003. He received the Honorary Member Award of GAeF, the German Association for Aerosol Research, in 2009. He became a Fellow of AAAR in 2008 and president of the organization in 2010.

Arthur Stuempfle is a senior scientist for OptiMetrics, Inc. (OMI). He holds graduate degrees in physics from Drexel University and The Johns Hopkins University. Prior to joining OMI, he held a variety of positions at the U.S. Army Edgewood Chemical Biological Center, Aberdeen Proving Ground, Maryland. He chaired an International Task Force Team on hazards to military forces from the deliberate/accidental release of industrial chemicals and served as the U.S. member of The Technical Cooperation Program International Action Groups regarding aerosol technology.

George M. Sverdrup, Ph.D., analyzed ACHEX data for his thesis (Sverdrup, 1977). He held a position at Battelle Memorial Institute, Columbus, Ohio, where he led research on environmental issues. Using ACHEX experience, he led a major study of alternative motor fuels in southern California from 1990–1994 involving about 20 organizations and a fleet of Federal Express trucks. This was followed by a major government-private study of the effects of sulphur in diesel fuel on emission control equipment providing a technical basis for EPA's regulations for low sulphur diesel fuels. Dr. Sverdrup now manages the hydrogen research program at the National Renewable Energy Laboratory, Golden, Colorado.

Shen Tian received his bachelor of science in environmental science and bachelor of arts in international relations from Peking University, Beijing, China. He received his master's degree in environmental science and management from Carnegie Mellon University in Pittsburgh, Pennsylvania. He is currently a graduate student at the Department of Civil and Environmental Engineering at the University of California–Davis. He has worked as an intern at Bayer Material Science in Pittsburgh and the California Energy Commission in Sacramento.

Chiu-sen Wang, Ph.D., an emeritus professor of public health at National Taiwan University (NTU), has taught courses in aerosol technology, first at Syracuse University and later at NTU. He is the founding president of the Taiwan Association for Aerosol Research (TAAR), the founding editor of the peer-reviewed journal *Aerosol and Air Quality Research*, and an honorary member of the Japan Association of Aerosol Science and Technology. From 2002 to 2006, he served as president of the International Aerosol Research Assembly. He received a Distinguished Achievement Award from TAAR and the 50th Anniversary Award from the Society of Powder Technology, Japan.

"This is an outstanding resource for everyone who is interested in aerosol research—ranging from a novice to an accomplished scholar. Historic and technical aspects described in the book are well balanced. Life stories of the pioneers of aerosol science, many whom I was privileged to know personally, are truly fascinating as they portray remarkable facets of their characters."

—Sergey Grinshpun

"Several of my favorites include a biography of Othmar Preining, a history of nanoaerosol measurements from the 1800s to the present, and three chapters related to California outdoor aerosol measurement experiments from 1969–1973. I could not begin any of those chapters without finishing it. It is fascinating to look back at the key decisions and important turning points in the direction of our science."

—Gilmore J. Sem

"One of the best features of this book is that it avoids overlap with the two earlier treatises. Consequently, it nicely complements our record of the history of aerosol science and technology. It is a book that should be on the shelf of any aerosol researcher who appreciates the contributions of our aerosol forefathers."

—E. James Davis

"Interesting and fun to read, this book goes a long way in bringing to life the scientific tributaries to our science, the wealth of creative ideas, and the people behind them. It also shows how far these pioneers of aerosol science went with so little in terms of equipment and technology."

—Gerhard Kasper

"Interesting insights into people and topical areas that have helped to shape modern aerosol science."

—Philip K. Hopke

RTI Press



The RTI Press mission is to disseminate information about RTI research, analytic tools, and technical expertise to a national and international audience. RTI Press publications are peer-reviewed by at least two independent substantive experts and one or more Press editors.

RTI International is an independent, nonprofit research organization dedicated to improving the human condition by turning knowledge into practice. RTI offers innovative research and technical services to governments and businesses worldwide in the areas of health and pharmaceuticals, education and training, surveys and statistics, advanced technology, international development, economic and social policy, energy and the environment, and laboratory testing and chemistry services.