



Harrold, T.J., Cepeda, R.A., & Beach, M.A. (2011). Long-term measurements of spectrum occupancy characteristics. In *2011 IEEE International Symposium on Dynamic Spectrum Access Networks (DySPAN). Aachen, Germany* (pp. 83 - 89). Institute of Electrical and Electronics Engineers (IEEE).
<https://doi.org/10.1109/DYSPAN.2011.5936272>

Peer reviewed version

Link to published version (if available):
[10.1109/DYSPAN.2011.5936272](https://doi.org/10.1109/DYSPAN.2011.5936272)

[Link to publication record in Explore Bristol Research](#)
PDF-document

University of Bristol - Explore Bristol Research

General rights

This document is made available in accordance with publisher policies. Please cite only the published version using the reference above. Full terms of use are available:
<http://www.bristol.ac.uk/red/research-policy/pure/user-guides/ebr-terms/>

Long-term Measurements of Spectrum Occupancy Characteristics

Timothy Harrold

University of Bristol/Toshiba Research Europe Ltd
Bristol, United Kingdom
Email: Tim.Harrold@bris.ac.uk

Rafael Cepeda

Toshiba Research Europe Ltd
Bristol, United Kingdom
Email: Rafael.Cepeda@toshiba-trel.com

Mark Beach

University of Bristol
Bristol, United Kingdom
Email: M.A.Beach@bris.ac.uk

Abstract—This paper describes the results from a series of long-term observations of spectrum occupancy in the range 300 MHz–4.9 GHz made at a single location. Over 6 months of data has been gathered from a measurement system that is designed to operate continuously, allowing a full picture of spectrum occupancy to be built up. The large amount of data captured permits analysis to identify the portions of spectrum that are occupied non-continuously (i.e. with a duty cycle of less than 100%); these channels might be most suitable for use by a cognitive radio (CR) system that is able to identify temporary spectrum holes and then exploit them. The aim of performing a comprehensive analysis of channel occupancy and its variability is to improve the potential for smart spectrum access by CR devices, by informing their choices concerning the particular portions of spectrum to scan, and how frequently. Results allow measurement channels to be categorised according to their duty cycle; spectrum with a duty cycle between 10% and 90% is considered to be particularly suitable and is found in the regions below 500 MHz and between 1 GHz and 1.2 GHz. A predictable pattern of time occupancy is discovered, caused by variable activity in the portions of spectrum allocated to cellular systems. The characteristics of the occupancy duty cycle according to the time of day is also investigated; some frequencies are shown to exhibit considerable variation of occupancy depending on the hour of observation. A subset of channels is selected for more detailed investigation including short-term variations in channel occupancy.

I. INTRODUCTION

One of the most widely recognised potential benefits of cognitive radio (CR) is that it could provide a mechanism for suitably enabled terminals to measure spectrum usage and re-use unoccupied channels on a dynamic basis. It has been proposed [1] that this functionality could permit a CR overlay to exist in the same radio environment as existing users, provided that suitable protection to their transmissions is guaranteed. This “smart” spectrum access, in which the CR overlay is interleaved with permanent users on a time or frequency basis, is expected to lead to an overall increase in the efficiency of use of spectrum.

Key to optimising this efficiency is the devolution of decisions about channel access to the individual radio terminals, whose situation means that they are able to understand the availability and suitability of spectrum in their location, as well as policies concerning which channels may

legally be accessed. Successful channel access, which entails communication between CR terminals without interference to other spectrum users, is therefore reliant on terminals having accurate and up to date knowledge of free spectrum in their locality [2]. Spectrum availability depends on the transmission profile of all users within the interference range of the CR terminals. Many systems are constantly present (such as broadcast transmissions and pilot transmissions from communication systems) but many are time varying. The overall spectrum availability is therefore constantly changing and CR systems could maximise use of the spectrum by using channels that have less than 100% time occupancy, provided that collisions with other time varying signals on the same channel are avoided.

Accurate channel sensing is the key capability to permit smart spectrum access; channel sensing performance can be optimised by incorporating knowledge based on information from previous spectrum scans. This work aims to demonstrate how the quality of information available to CR terminals can be maximised by building up, over the course of several months, a full picture about channel occupancy. A measurement system has been implemented to observe spectrum usage in the range 300 MHz–4.9 GHz from a site in Bristol, United Kingdom; to date continuous observations have been made over a period of more than 6 months. The aim of the measurements is to build up a large amount of information about spectrum occupancy, particularly focussing on time variability, considering both short and long scale variations. Of particular interest are the channels that are not continuously occupied and how the characteristics of their occupancy can be captured in a format that allows the likelihood of occupancy to be predicted, based on factors such as the time of day and day of the week.

This paper is organised as follows. Section II describes the background and motivation to the work, including information about similar measurement campaigns. Section III contains details of the measurement hardware implemented together with details about how the results were captured and processed. Section IV presents the results of the characteristics of channel occupancy and how this varies according to frequency. Finally, Section V has the overall conclusions of the paper.

II. BACKGROUND AND RELATED WORK

A. Channel availability

The occupancy of a channel as measured by a CR capable device at a particular location may vary in time, according to the profile of the transmitting source (or sources). One example is the regular interference caused by a rotating airport radar. Another example is the variation of office based transmissions (such as cordless telephones, wireless data networks and cellular telephones) in a business district during working hours compared to evenings and weekends. Long- and short-term propagation effects may also result in transmissions appearing and disappearing.

Such temporal variations in channel availability are of interest as they allow suitably equipped CR devices to re-use channels on a time interleaved basis. It is understood that certain portions of the spectrum are allocated to users but are only lightly used in both time and spatial domains (such as UK military allocated spectrum) and it has been proposed that these allocations could be re-used by a CR system [3].

B. Spectrum sensing

A CR device that senses channel occupancy requires expenditure of time and energy for every sensing activity; minimising this energy expenditure ensures efficiency of data transfer and maximises battery life for portable terminals. Additionally, a CR device engaged in sensing spectrum is unavailable to transmit or receive data. Limitations in sensing technology mean that devices are unable to sense multiple transmission bands simultaneously and so must arrange a schedule of frequencies to monitor in turn. Sensing strategy will therefore inevitably require compromises and it is desirable to optimise the sensing strategy in order to maximise the information gained and minimise time and energy expenditure. It has been proposed that decisions about which channels to sense can be made with prior knowledge about the occupancy statistics of the spectrum [4], [5], [6], [7]. Suitable historical spectrum occupancy knowledge could be obtained from previous spectrum scans, obtained by the terminal itself, or shared between a network of similar CR terminals. Some specific possible examples include:

- Discovering channels which are likely to be lightly used at particular times and days and prioritising them for future channel sensing.
- Removing channels that have previously been noted as being constantly occupied from the pool of channels that are to be sensed.
- Partitioning the amount of time allocated for the tasks of sensing and channel access according to the likely occupancy of the channel.
- Where the occupancy of a channel is found to be completely periodic; learning the pattern of occupancy such that the occurrence of gaps can be predicted and exploited for channel access.

The success of these techniques relies on the quality of the spectrum occupancy information available. Long-term mea-

surements (i.e. those lasting for a month or more) have two major advantages in this respect; firstly, they will sample the occupancy over a sufficient number of different times, spanning working days, special events, weekends and holidays, that will allow a picture of usage trends to be created. Secondly, the analysis of a large data set will allow more accurate models to be created. Provided that these requirements are met, models of spectrum occupancy can be developed, these models will capture variation according to the time of day. This will assist future research, allowing simulations to have a realistic picture of the existence and characteristics of primary users and allowing CR devices to learn more about the spectrum environment in which they operate. Other work has used models developed from occupancy measurements to develop models subsequently used to guide sensing strategy, the underlying data sets have duration 7 days [8], [9].

C. Spectrum activity measurements

Measurements of spectrum occupancy have been an important research topic in the field of CR, providing an insight into the amount and locations of spectrum that might be available to future CR deployments by assessing existing usage. Research work in this field has tended to concentrate on short-term measurement campaigns (e.g. for a few days maximum) and has therefore looked at the percentage of spectrum bandwidth occupied [10], [11], [12] and permanently available “whitespace” spectrum, rather than the temporal nature of channel occupancy. [13] identifies the need to study time occupancy and describes a series of measurements in the range 75 MHz–3 GHz together with percentage time occupancy figures for various bands of interest based on a 48 hour observation period. Similar investigations [14] have shown occupancy measurements taken in indoor and outdoor locations over a longer period (seven days), including spectral power plots and some investigation of temporal transmission duty cycle. Temporal characteristics of a number of frequency bands have also been investigated [15], [16].

There are few studies where spectrum measurements of duration greater than 7 days have been reported. Long-term measurements in the frequency range 30 MHz–6 GHz made from a permanent outdoor spectrum observatory in Chicago, USA are described in [17], the results concern long-term spectrum whitespace availability rather than performing temporal analysis of the activity measured. A study commissioned by the UK Regulator Ofcom [18] described results of 5 months’ worth of measurements in the range 10 MHz–5 GHz although the data is gathered from a moving vehicle and is intended to build up a picture of spectrum occupancy over a wide geographical area.

D. Contribution of this work

The work described in this paper is intended to fulfil the need for measurements that can identify which channels in the range 300 MHz–4.9 GHz have an occupancy characteristic that makes them suitable for cognitive re-use. Analysis of the patterns of occupancy will allow models for the occupancy



Fig. 1. Measurement antennas. The low band discone antenna is on the left, and the high band antenna can be seen on the right.

to be created. Whereas some of the other studies mentioned in Section II-C have also developed occupancy models, the long-term nature of the observations described in this work mean that sufficient information will be available to tune the models, by selecting parameters most appropriate to the time or day.

III. MEASUREMENTS

A. Location and situation

The measurements taken in this study were made at Merchant Venturers Building, Bristol, United Kingdom. The site is approximately 800m from the commercial centre of Bristol at location 51.455575N, 2.602214W. Two antenna positions are used; an outdoor position on the roof of the building approximately 30 m above street level and the other in an indoor position at a window overlooking the adjacent street. The ability to measure spectrum usage in two positions near simultaneously provides an understanding of the correlation of measurements between the two positions and also allows capture of additional data, particularly those from higher frequency indoor systems which the roof-mounted antennas may not detect.

B. Measurement system

The measurement system collects received power values using a spectrum analyser, under the control of a PC. The antennas used in the system are discone antennas, which have wideband frequency coverage and a vertically polarised radiation pattern which is omnidirectional in the azimuth plane. The required range of measurement frequencies exceeds the operating bandwidth of a single antenna and so two separate antennas are used in each of the two positions, covering the ranges 300 MHz–1 GHz and 1 GHz–4.9 GHz respectively. The antenna pattern of each discone antenna is similar to that of a dipole, and so the capability to receive direct transmissions from directly above and below is limited. However, as the indoor and outdoor antennas are positioned approximately in vertical alignment, between them they are able to provide enhanced coverage. The antennas in the outdoor position are shown in Figure 1.

A single channel spectrum analyser is used which must be able to measure the signal received by any one of the four

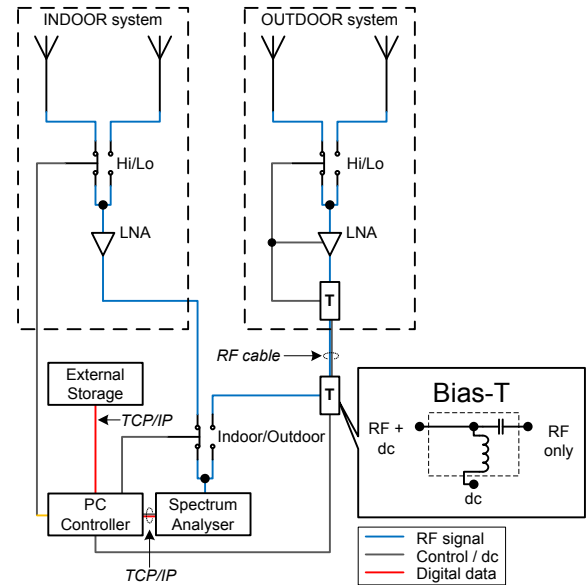

Fig. 2. Diagram of the Measurement System.

discone antennas. Three RF switches (under the control of the PC) are used to achieve this; one of them selects the antenna pair (indoor or outdoor position) in use, and each antenna pair has a switch to select either the high band or low band discone. This arrangement is shown in Figure 2.

The total spectrum observation from 300 MHz–4.9 GHz is achieved in 230 individual 20 MHz sweeps which are made from each measurement position (indoor/outdoor) in turn (in order to minimise the time between measuring the same spectrum portion on both the indoor and outdoor antennas). Various tradeoffs exist [19] between the spectrum analyser parameters and the speed of measurement; in particular a smaller resolution bandwidth results in a increased ability to detect signals above the instrument’s noise floor, but has the penalty of an increased measurement time. For these measurements, the spectrum analyser is set to a resolution bandwidth of 300 kHz with 40 kHz point spacing; the detector in use measures the average power. A complete observation comprises 115230 points for each antenna set, and takes approximately 6 minutes to complete, i.e. each individual frequency channel is sampled with a period of 6 minutes. Occasional reliability problems with the measurement equipment have occurred, however an uptime of around 80% is achieved. Example plots showing the range of signals received can be found in [20].

C. Calibration

The lengths of the RF cables between the antenna positions and the spectrum analyser necessitates the use of preamplifiers to counteract the losses encountered. The gains of these amplifiers are approximately 28dB and 12dB for the outdoor and indoor antenna positions respectively. The components of the measurement system, particularly the cables and amplifiers, have individual gains that vary with frequency, as does each antenna. This results in the system having a

TABLE I
MEASUREMENT SYSTEM GAIN.

Frequency (MHz)	Antenna Gain (dBi)		System Gain (dB)	
	Low Band	High Band	Indoor	Outdoor
300	3.2	-	-7.5	4.8
1000	-0.04	0.48	6.7	9.6
2000	-	1.2	6.5	-6.3
3000	-	2.4	3.8	-6.6
4000	-	0.4	1.6	-9.2
5000	-	-3.2	-4	-16

non-flat frequency response, meaning that the system has an increased or decreased sensitivity to signals received on particular frequencies.

The system gains and antenna gains for various frequencies are given in Table I. The system gain accounts for the sum of the gains of all the components in either the indoor or outdoor measurement system path, this was obtained by injecting a wideband signal of a known level in place of the antenna and measuring the signal received at the other end. The antenna gains were measured in an anechoic chamber in the azimuth plane of maximum radiation. Applying this combined correction for the system gain and antenna gain therefore corresponds to the theoretical power that would be measured were it to be possible to connect an isotropic antenna to the spectrum analyser using lossless cables.

D. Processing

Processing of the results comprises two stages; firstly signals appearing above the detection threshold are extracted, secondly these measurements are calibrated using the gain figures given in Section III-C. The detection threshold is defined as being a fixed value above the noise floor of the measurement system. The selection of this value has an impact on the number of signals detected; setting the value too low results in noise being incorrectly interpreted as signals, whereas setting it too high may result in weak signals being missed.

The noise floor of the measurement system is frequency variable and was obtained by averaging a number of measurement sweeps made with a 50Ω load in place of the antenna for each of the possible switch combinations. The system noise floor was found to be in the range -82.4–74.5 dBm across the band of interest, with a mean of -79.9 dBm. The samples of noise at each measurement frequency were not found to be normally distributed; a detection threshold of 5 dB above the noise floor was found to be sufficient to ensure that none of the noise samples were incorrectly interpreted as signals. This leads to a detection threshold in the range -77.4–69.5 dBm.

IV. RESULTS

A. Channel occupancy

The main metric used in this work is the channel's percentage time occupancy, T_{occ} . The time occupancy of a particular

frequency channel f over S_f samples is defined in Equation 1.

$$T_{occ,f} = \frac{1}{S_f} \sum_{t=1}^{S_f} \alpha_{t,f} \quad (1)$$

$\alpha_{t,f}$ is 1 if a signal on frequency channel f is discovered above the detection threshold at sample time t and 0 otherwise. In order to discover the factors that might affect the occupancy at any particular point in time, the mean of all the values of T_{occ} per channel was calculated in the 300 MHz–4900 MHz observation range for the indoor antenna position. The variation in mean T_{occ} for the 7 day period from midnight 11th August 2010–midnight 18th August 2010 is shown in Figure 3, approximately 5 hours of data was lost from about 4am on Friday morning. Channel occupancy clearly varies on 24 hour cycle, with less activity in the overnight periods (approximately midnight–6am) and a peak at around noon. There is also evidence of a weekly cycle; activity is lower on Saturday and Sunday; for the weekend days there appear to be distinct peaks around lunchtime and the early evening with a small nadir of activity in the afternoon. Other authors have also observed daily and weekly cycles in occupancy for the cellular bands [21], although an evening peak time was noted. For the period plotted, there is additional activity on Monday afternoon; further analysis of the data set would allow conclusions about whether this is a unique example, or whether similar patterns occur every Monday. Occupancy values are generally low (in the range 0.8–1.2%); it should be remembered that these values are derived from data from the indoor measurement system, which, due to its location, receives fewer signals than the outdoor position.

B. Temporally varying channels

1) *Categorisation of occupancy*: In order to categorise channels most suitable for cognitive radio re-use, channels are identified according to their time occupancy over the observation period:

- $T_{occ} > 90\%$ the channel is likely to be occupied continuously, e.g. by a broadcast transmitter.
- $10\% < T_{occ} < 90\%$ the channel is partially temporally occupied and may be suitable for CR use.
- $T_{occ} < 10\%$ the channel is likely to be permanently free.

2) *Identification of temporally varying channels*: The mean occupancy across the whole band (as shown in Figure 3) demonstrated periodic variation of channel activity; this phase of the analysis investigates the T_{occ} according to frequency band in order to discover which portions of spectrum have time varying occupancy.

The measured data during the period 19th May 2010–18th October 2010 has been analysed for percentage T_{occ} . Every 20 kHz frequency point has been investigated to determine activity on the channel over the whole observation period, leading to a percentage T_{occ} for each point. The individual frequency point T_{occ} s are then grouped into bins 50 MHz wide; the percentage of channels in the bin falling into the occupancy categories described in Section IV-B1 is calculated.

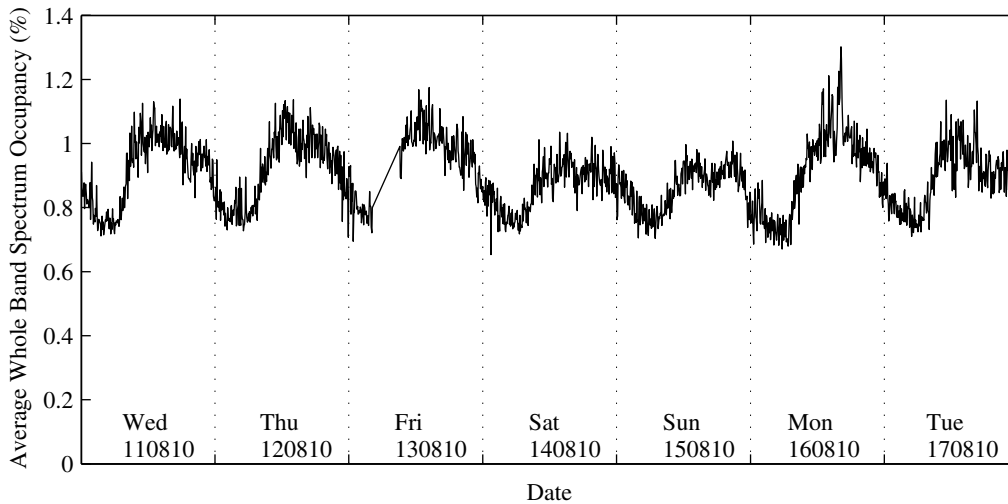

Fig. 3. Mean occupancy of the whole observed spectrum 11th August–18th August.

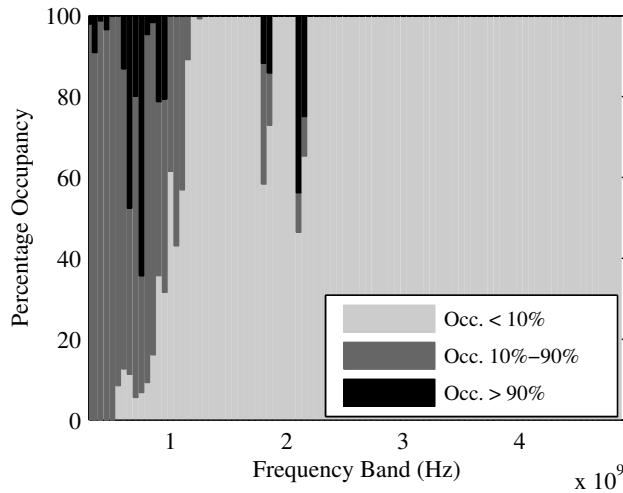

Fig. 4. Occupancy over the period 19th May–18th October 2010 (outdoor position).

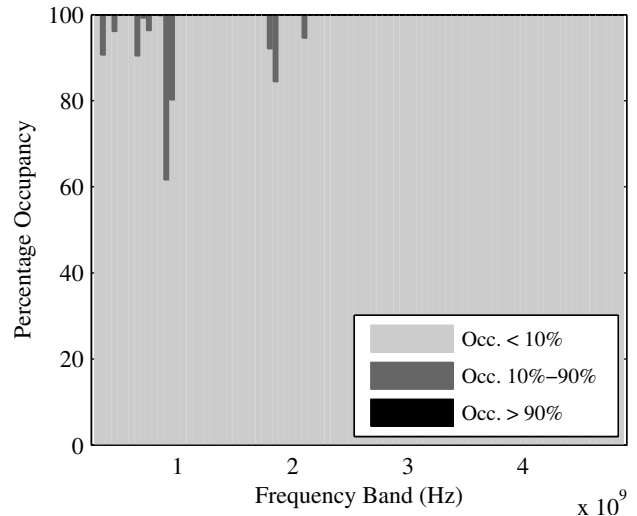

Fig. 5. Occupancy over the period 19th May–18th October 2010 (indoor position).

The results are shown in Figure 4 for the outdoor position and Figure 5 for the indoor position.

The outdoor antenna results show the channel occupancy more clearly. Referring to Figure 4, the results confirm that, over a period of around 5 months, the “always occupied” channels ($T_{occ} > 90\%$) are to be found in the broadcast television bands (470–862 MHz) and the spectrum allocated to cellular basestations in GSM 900/1800 MHz band and UMTS around 2 GHz [22]. There are large areas of spectrum notably above 2.5 GHz where the system failed to detect any transmissions. Of most interest are the spectrum regions which fall into the “partial temporal occupancy” category ($10\% < T_{occ} < 90\%$); analysis of the data gathered at the outdoor position reveals that about 13.8% of the spectrum measured falls into this category. A surprising finding is that there is a significant number of partially occupied channels in the TV broadcast band, where it would be assumed that

spectrum channels are either allocated to a broadcaster, or permanently vacant. It appears, however, that there are various distant TV transmitters visible only occasionally; propagation effects result in fluctuations in signal strength leading to non-continuous detection.

C. Hourly variation in occupancy

The T_{occ} for every channel for each hour of the day was measured over the period 19th May 2010–18th October 2010. The mean and standard deviation of the hourly occupancy is studied in order to establish which channels’ occupancy remain constant over each of the 24 hours in a day, and which have a more unpredictable occupancy (characterised by a higher standard deviation from the mean). Figure 6 shows the results for the spectrum range 300 MHz–2.5 GHz (the region above 2.5 GHz is excluded due to low levels of occupancy).

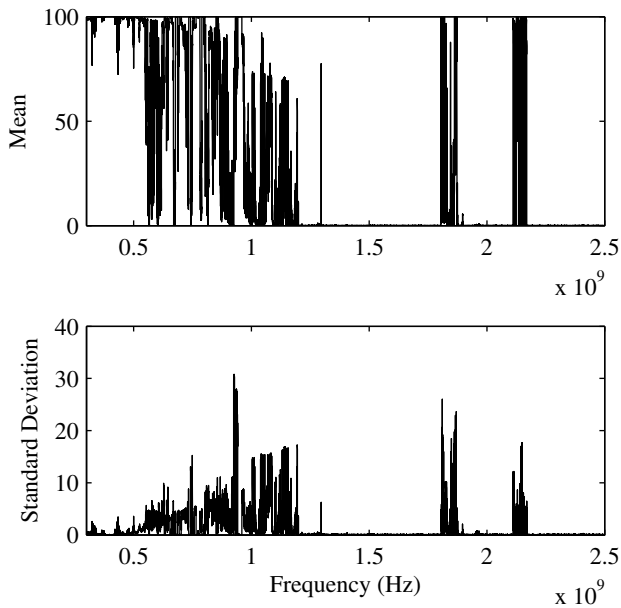

Fig. 6. Mean and standard deviation of the hourly occupancy per frequency channel

It can be seen that the regions of spectrum below 800 MHz (which were previously identified as being used heavily) have very little variation in their occupancy across the 24 hour cycle, evidenced by a low value for the standard deviation of T_{occ} . The highest variability is in the cellular bands with standard deviation in the range 20%–30%.

These statistics are helpful when it comes to understanding the predictability of spectrum occupancy. A channel which has a high mean and low standard deviation of T_{occ} is likely to be of limited value for opportunistic re-use as it will be consistently unavailable. By contrast, certain channels (particularly in the cellular bands) are seen to have medium mean and high standard deviation of T_{occ} , meaning that there are times of the day when lower occupancy could be exploited.

D. Transition time

The previous sections have concentrated on the occupancy percentage of various frequency points as measured over a long time period. The information that CR devices will need to improve the quality of their sensing performance will include the variability of spectrum occupancy. In order to extract information about variations in occupancy from the measurement data, the time characteristics of free to busy transitions for all the frequency channels have been investigated. It should be noted that the 6 minutes (approximately) sweep time means that system is only able to detect slow transitions in the channel.

For this analysis, the subset of channels above 1 GHz which have an occupancy in the range $10\% < T_{occ} < 90\%$ is selected. For the measurement period 19th May–18th October 2010, the time when each of the channels move from a “free” to a “busy” state is recorded. The mean of the time differences between these transitions is calculated; the results are plotted

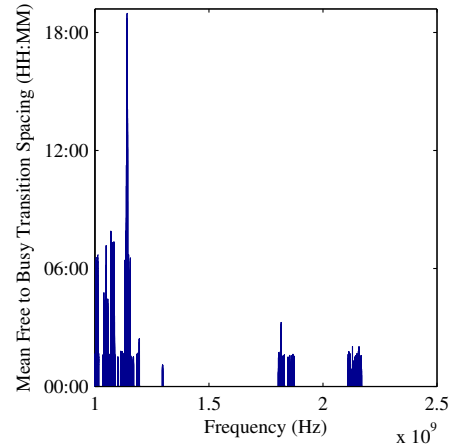

Fig. 7. Mean free to busy transition times by frequency measured over the period 19th May–18th October 2010.

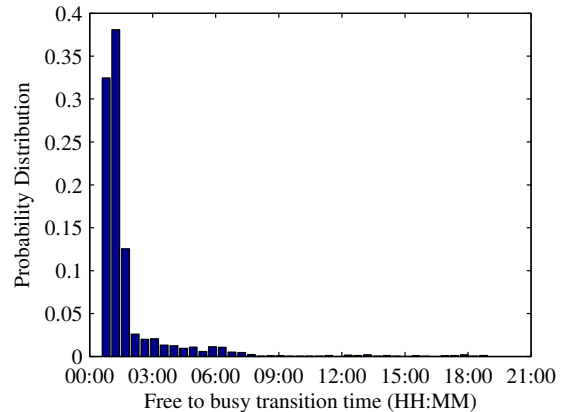

Fig. 8. Distribution of free to busy transition times measured over the period 19th May–18th October 2010.

in Figure 7. The distribution of all the mean transition times for the entire subset of channels is provided in Figure 8.

The results give some idea of the variability of channel availability for this subset of channels. A small number of channels have a large average transition time (around 18 hours) whereas the majority have transition times of well under an hour. Finer resolution of the transition times has not been attempted, due to the relatively infrequent sampling rate. If a CR were to have access to a model for the free to busy transitions times of a channel that it might wish to occupy, it would assist with determining how often the channel should be sensed for existing activity.

V. CONCLUSIONS

The work described in this paper covers a set of long-term observations of spectrum occupancy in the range 300 MHz–4.9 GHz and associated analysis. The main aims of the work have been to discover which channels might be suitable for CR use on a time interleaved basis, to discover how the availability of these channels varies according to the time of day and to

find out more about the short-term temporal variability. The results are expected to aid future CR algorithms for smart spectrum access; providing additional guidance for sensing strategies.

A measurement system has been deployed in order to gather spectrum observations continuously at a single site. Two antenna positions have been used; both an indoor and an outdoor location. 5 months' worth of data has been selected for analysis. Mean time and frequency occupancy figures have shown that occupancy varies periodically, with a strong 24 hour cycle being visible. A reduction in channel occupancy is also seen at the weekends. Analysis of the occupancy according to frequency has shown that the variations are due to higher levels of activity on the cellular band during the "busy" periods. It is therefore possible that a CR terminal could use time of day and weekday/weekend as a factor in deciding whether or not to sense particular frequency channels.

A channel suitability criterion based on a non-continuous time occupancy is defined; a subset of channels meeting this requirement is identified in the spectrum region above 1 GHz, comprising 2.3% of the total spectrum monitored. The subset of suitable cognitive channels has been analysed for short-term variations in channel occupancy by looking at the distribution of free to busy transitions on each channel, although the sampling time of around 6 minutes limits the conclusions that can be drawn. The majority of transition times are small, there are a few channels where significantly longer transition times are encountered; future sensing algorithms could make use of the information about transition times of a particular frequency to assist in deciding how frequently it should be monitored.

Future work will derive models to determine the probability of occupancy, based on the time of day. Measurements will favour sampling the channel subset on a more frequent basis (instead of performing comprehensive wideband sweeps) in order to improve the capability of the system to detect faster transitions in channel occupancy.

ACKNOWLEDGEMENT

This work is being carried out jointly by University of Bristol and Toshiba Research Europe Telecommunications Research Laboratory (TRL) under the Engineering and Physical Sciences Research Council (EPSRC) Knowledge Transfer Secondment scheme. Thanks are due to the directors of TRL for allowing the publication of this work and to Mr Ken Stevens for his invaluable contribution to the construction of the measurement system.

REFERENCES

- [1] J. Walko, "Cognitive radio," in *IEE Review*, vol. 51, no. 5, May 2005, pp. 34–37.
- [2] S. Haykin, "Cognitive radio: brain-empowered wireless communications," *Selected Areas in Communications, IEEE Journal on*, vol. 23, no. 2, pp. 201–220, Feb. 2005.
- [3] J. Bradford, T. Cook, D. Ramsbottom, and S. Jones, "Optimising usage of spectrum below 15GHz used for defence in the UK," in *Cognitive Radio and Software Defined Radios: Technologies and Techniques, 2008 IET Seminar on*, Sep. 2008, pp. 1–5.
- [4] H. Kim and K. Shin, "Efficient discovery of spectrum opportunities with MAC-layer sensing in cognitive radio networks," *Mobile Computing, IEEE Transactions on*, vol. 7, no. 5, pp. 533–545, May 2008.
- [5] J. Ma, X. Zhou, and G. Li, "Probability-based periodic spectrum sensing during secondary communication," in *Communications, IEEE Transactions on*, vol. 58, no. 4, Apr. 2010, pp. 1291–1301.
- [6] M. Wellens, A. de Baynast, and P. Mähönen, "Exploiting historical spectrum occupancy information for adaptive spectrum sensing," in *Wireless Communications and Networking Conference, 2008. WCNC 2008. IEEE*, 31 2008.
- [7] M. Wellens, J. Riihijärvi, and P. Mähönen, "Evaluation of adaptive MAC-layer sensing in realistic spectrum occupancy scenarios," in *New Frontiers in Dynamic Spectrum, 2010 IEEE Symposium on*, 2010, pp. 1–12.
- [8] M. Wellens and P. Mähönen, "Lessons learned from an extensive spectrum occupancy measurement campaign and a stochastic duty cycle model," *Springer Mobile Networks and Applications*, vol. 15, no. 3, pp. 461–474, Jun. 2010.
- [9] M. Wellens, A. de Baynast, and P. Mähönen, "Performance of dynamic spectrum access based on spectrum occupancy statistics," in *Communications, IET*, vol. 2, no. 6, Jul. 2008, pp. 772–782.
- [10] Spectrum reports. Shared Spectrum Company. [Online]. Available: <http://www.sharedspectrum.com/papers/spectrum-reports/>
- [11] V. Valenta, Z. Fedra, R. Maršálek, G. Baudoin, and M. Villegas, "Analysis of spectrum utilization in suburb environment; evaluation of potentials for cognitive radio," in *Ultra Modern Telecommunications Workshops, 2009. ICUMT '09. International Conference on*, Oct. 2009, pp. 1–6.
- [12] V. Valenta, R. Maršálek, G. Baudoin, M. Villegas, M. Suarez, and F. Robert, "Survey on spectrum utilization in Europe: Measurements, analyses and observations," in *Cognitive Radio Oriented Wireless Networks Communications (CROWNCOM), 2010 Proceedings of the Fifth International Conference on*, Jun. 2010, pp. 1–5.
- [13] M. López-Benítez, A. Umbert, and F. Casadevall, "Evaluation of spectrum occupancy in Spain for cognitive radio applications," in *Vehicular Technology Conference, 2009. VTC Spring 2009. IEEE 69th*, Apr. 2009, pp. 1–5.
- [14] M. Wellens, J. Wu, and P. Mähönen, "Evaluation of spectrum occupancy in indoor and outdoor scenario in the context of cognitive radio," in *Cognitive Radio Oriented Wireless Networks and Communications, 2007. CrownCom 2007. 2nd International Conference on*, Aug. 2007, pp. 420–427.
- [15] S. Pagadarai and A. Wyglinski, "A quantitative assessment of wireless spectrum measurements for dynamic spectrum access," in *Cognitive Radio Oriented Wireless Networks and Communications, 2009. CROWNCOM '09. 4th International Conference on*, 2009, pp. 1–5.
- [16] C. Ghosh, S. Pagadarai, D. Agrawal, and A. Wyglinski, "A framework for statistical wireless spectrum occupancy modeling," *Wireless Communications, IEEE Transactions on*, vol. 9, no. 1, pp. 38–44, 2010.
- [17] R. Bacchus, A. Fertner, C. Hood, and D. Roberson, "Long-term, wide-band spectral monitoring in support of dynamic spectrum access networks at the IIT spectrum observatory," in *New Frontiers in Dynamic Spectrum Access Networks, 2008. DySPAN 2008. 3rd IEEE Symposium on*, Oct. 2008, pp. 1–10.
- [18] "Capture of spectrum utilisation information using moving vehicles," CRFS Ltd, Tech. Rep. Ofcom Tender No: 32/2008, Mar. 2009. [Online]. Available: <http://stakeholders.ofcom.org.uk/binaries/research/technology-research/vehicles.pdf>
- [19] M. López-Benítez and F. Casadevall, "Methodological aspects of spectrum occupancy evaluation in the context of cognitive radio," in *European Wireless Conference, 2009. EW 2009*, May 2009, pp. 199–204.
- [20] T. Harrold, R. Cepeda, and M. Beach, "Temporal characteristics of spectrum occupancy based on long-term observations," in *Proceedings of COST 2100, Bologna, Italy*, no. TD(10)12066, Nov. 2010.
- [21] M. Wellens, J. Riihijärvi, and P. Mähönen, "Empirical time and frequency domain models of spectrum use," *Elsevier Journal on Physical Communication*, vol. 2, no. 2, 2009.
- [22] "United Kingdom frequency allocation table, issue no. 15," National Frequency Planning Group (UK), Tech. Rep., 2008. [Online]. Available: <http://stakeholders.ofcom.org.uk/binaries/spectrum/spectrum-policy-area/spectrum-management/UK-FAT-Table-2008/ukfat08.pdf>