

3-Dimensional Rigid Transformer Strings with Composite Topological Strings

Leo Vuyk,
Architect,
Rotterdam, the Netherlands.
LeoVuyk@Gmail.com

Abstract,

In particle physics it is an interesting challenge to postulate that the FORM and structure of elementary particles is the origin of different FUNCTIONS of these particles.

In this paper we present a possible solution based on complex 3-D ring shaped particles, which are equipped with three point like hinges and one splitting point, all four locations divided equally over the ring surface.

The 3-D ring itself is postulated to represent the “Virgin Mother” of all other particles and is coined Axion Higgs particle, supplied with the 3-hinges coded (OOO), which gives the particle the opportunity to transform after real mechanical collision with other particles into a different shape, with a different function.

Thus in this Quantum Function Follows Form theory, (Q-FFF) the Axion Higgs is interpreted as a massless transformer particle able to create the universe by transforming its shape after real mechanical collision and merge with other shaped particles into composite and compound knots.

Introduction,

It is assumed that the vacuum is seeded with massive numbers of massless Axion Higgs particles, all energetic oscillating inside a chiral vacuum lattice system and as such the origin and bearer of all energy in the universe.

If by a local energy excess, like the Schwarzschild horizon of a black hole, two Axion Higgs particles collide with enough opposite energy, it is assumed that at first an electron and positron emerges by the transformation of the two Axion Higgs particles.

Due to the propeller shape of the Fermions, these Fermions start to spin by a constant collision and scattering process with the Axion Higgs vacuum, changing Axion Higgs particles continuously into different forms of Photon/Gluons.

As a result, we found, that many “elementary” particles could not be elementary, but compound constructions or KNOTS of transformed Axion Higgs particles.

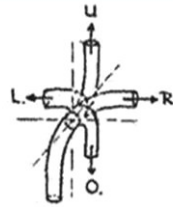
Even the Muon and Tau Lepton should be compound particles having the same shape as one of the different coloured “naked” Down- respectively Charm Quarks. (figure: 6) Thus, Muon- and Tau particles seem to be naked Quarks!

Alternative Standard Model of Quantum FFF Theory

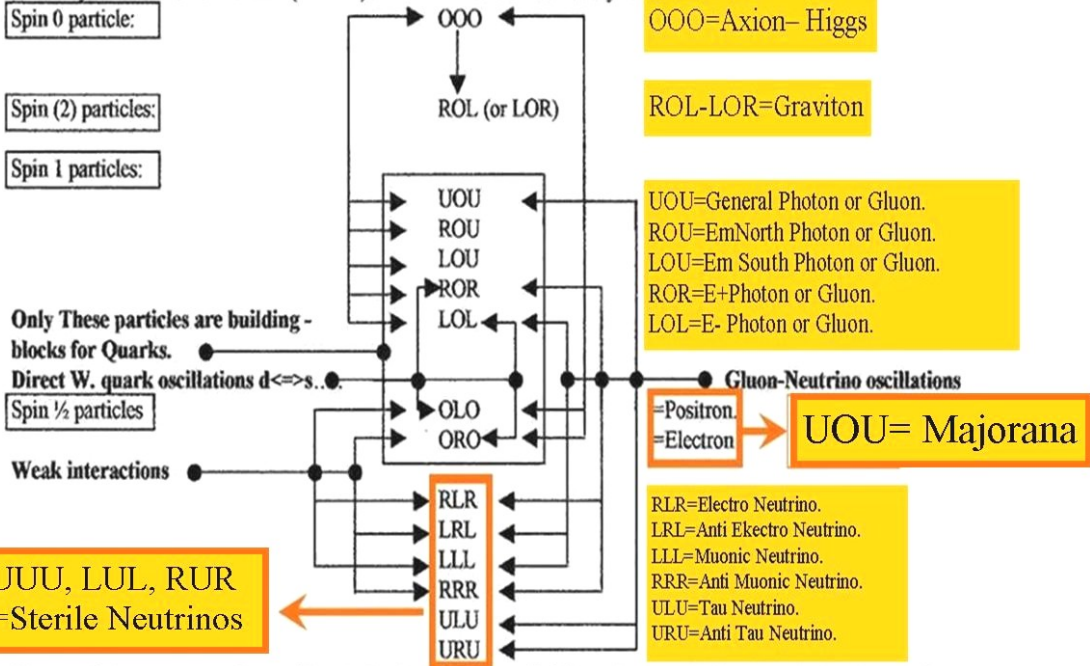
With ONE Axion-Higgs Mother particle

The Axion- Higgs Vacuum Field particle is coded OOO, representing three closed Rigid String hinges of the mother rigid ring, able to rotate in steps over 90 degrees into L,U and R: Left Up and Right,

Explanation of the codes:
 U= Up rotation (180 degrees)
 O= Unchanged circle.
 L= Left rotation (90 degrees)
 R= Right rotation (90 degrees)



Summary with oscillation routes: (↔) or the definite Graviton decay route (→)



Higgs particles are supposed to oscillate in Tandem along so called linear Vacuum Lattices, two by two in opposite directions, as the symmetrical opposite pistons of a boxer engine, as the origin of all energy, spin and mass effects. This enables the Tandem Higgs particles to change the form of their own Torus into an Electron and Positron pair at

Figure 1, 3D image of Basic Singular Particles;

ONE Axion Higgs boson (OOO), TWO basic single mirror symmetrical Fermions: the Electron and Positron (OLO and ORO), ONE Graviton (LOR), TWO sets of mirror symmetrical monopole Gluons/Photons (ROU-LOU, ROR-LOL) One symmetrical Gluon Photon (UOU).

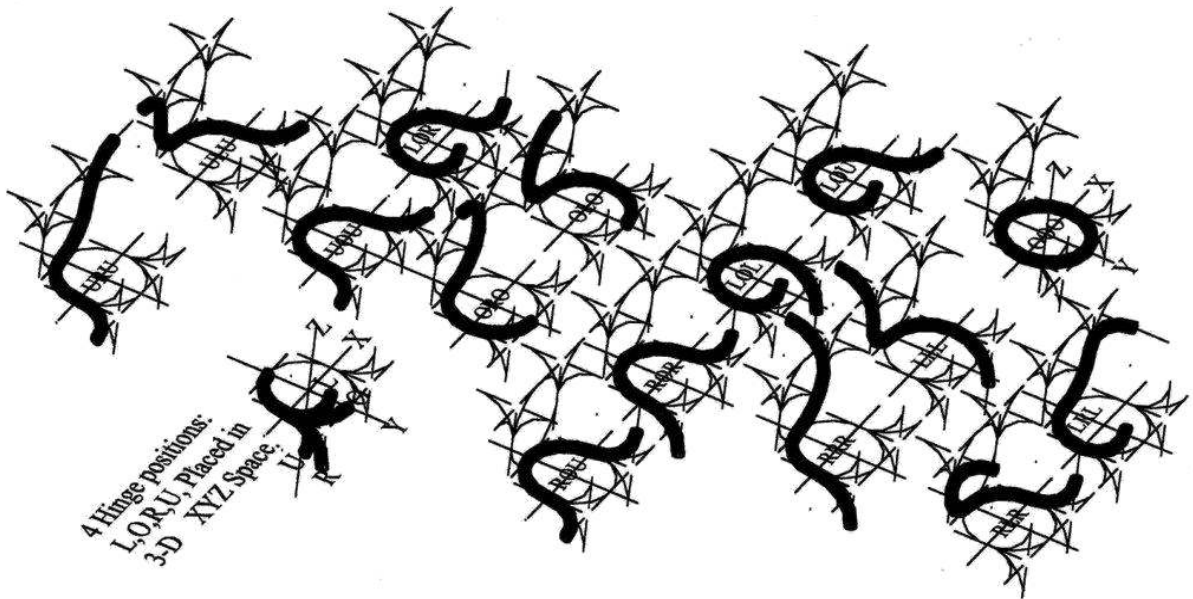


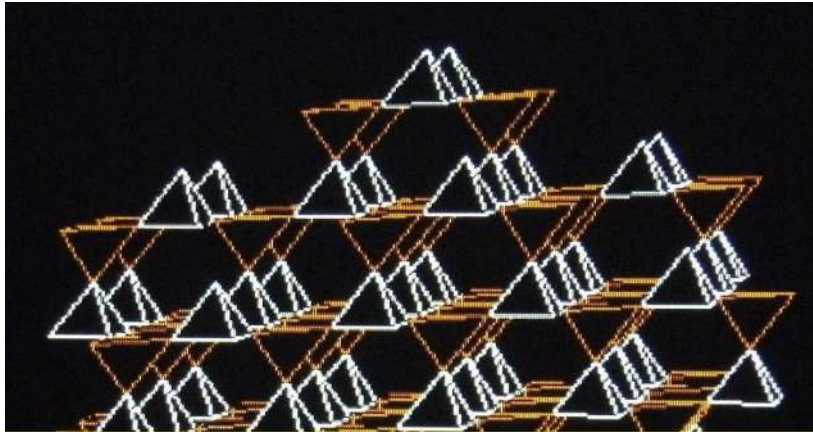
Figure 3, 3D image of all Singular particles including 3 sets of mirror symmetrical Neutrinos: RLR-LRL, RRR-LLL, URU-ULU.



Figure 4, 3D image of the Leptons: Electron, Positron, (singular) Muons and Tau particles (Compound particles).

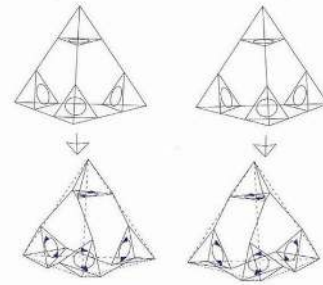


Figure 5, 3D-Image of all 36 Quarks: UP-DOWN-STRANGE-CHARM-BOTTOM-TOP.



Truncated tetrahedron space according to the Quantum-FFF model. Each tetrahedron lattice has a spiral shape based on three linear units

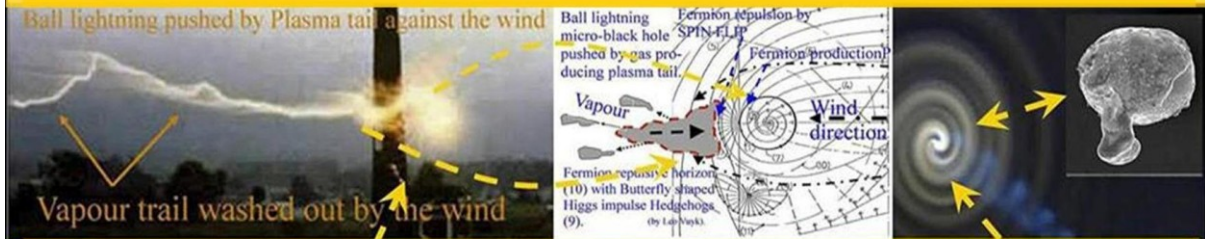
3-D image of TWO tetrahedron space fill units with chiral, left or right handed characteristics, the origin of our material universe and our opposite anti-matter universe.



Space fill unit with RIGHT hand rotation. Space fill unit with LEFT hand rotation.

Figure 6, The chiral vacuum Lattice in 3D.

Stable Micro Comets, Ball Lightning and WIMPs are the future solution for our CO2 problem, by electric vacuum energy production technology. http://vixra.org/author/leo_vuyk
 See: Artificial Ball Lightning production and exploitation device for Zero Point Electric Energy usage. <http://vixra.org/pdf/1108.0036v6.pdf> and <http://vixra.org/pdf/1404.0151v1.pdf>



Self propelled Ball Lightning-Micro Comets.

What is wrong with Physics?



Micro Comets (micro black holes)

- 1: Gravity is a dual Pressure Force.
- 2: The Vacuum has resistance for ALL motion.
- 3: Black Holes Attract and Repel ALL Fermions
- 4: The Raspberry Multiverse has 8 or 12 symmetric anti-copy universes, which is the origin of uncertainty, Human Consciousness and Inertia !

Figure 7, What is mainly wrong?

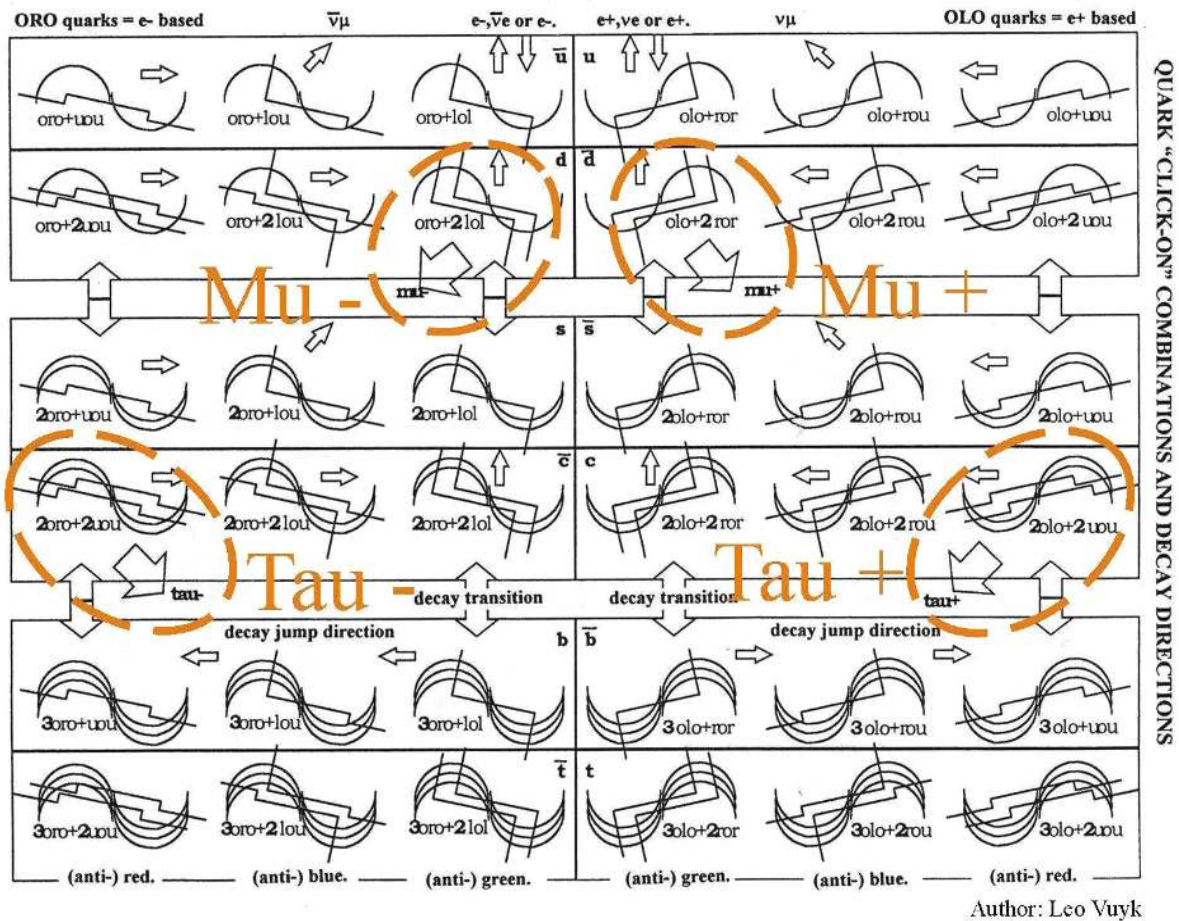


Figure 8, Simplified 2D image of Leptons and Quarks including indications for Decay routes indicated by arrows.

The Weak force, how change a d-quark (ORO+LLL+LRL) into an u-quark (OLO+ROR) in the case of Neutron-- Proton decay.

semi-leptonic processes

$$n \Rightarrow p + e^- + \bar{\nu}_e$$

$$ddu \Rightarrow duu + e^- + \bar{\nu}_e$$

The principle interaction is :

$$d \Rightarrow u + e^- + \bar{\nu}_e$$

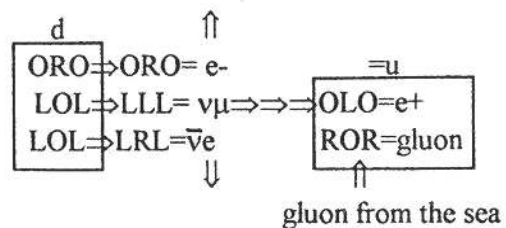


Figure 9, The WEAK force in action by a complex exchange of particles and without a clear sign of the Weak particle. Conclusion there is no need for a massive Weak particle in this system. The massless Axion Higgs particle, seems to do the job properly by transformation of two compound Gluon particles (LOL) attached to the electron (ORO): (LOL into LLL) and (LOL into LRL) . In succession, the (LLL) particle is changed into (OLO) a Positron, able to combine with a free Gluon (ROR) out of the SEA of Gluon plasma.

THE DECAY OF QUARKS AND LEPTONS

According to my model: elementary particles have a **sub-quantum structure**, caused by the postulate that a kind of Higgs particle is the **basic elementary particle**. (see the relation with the model page: 4)

Two Higgs particles can change form by collision into an electron and positron pair.(ORO+OLO)

Each Higgs particle can change form by collision with a quark or lepton into one of the **6 different possible types of photons:**

- 1: **The graviton** code: LOR (or ROL) can not "click-on" to e+ or e- particles to form quarks.
 - 2: **The "general" photon** code UOU. can "click-on" to e+ or e- particles, to form quarks for all "red, anti-red" (the colors are my own choice) quarks. The general photon has no quark confinement function, so is not a "real" gluon. **The 4 (gluon) photon types can also "click-on" to e+ or e- they are:**
 - 3: **Magnetic "north" photon** (in code) ROU. combining for all "positive/blue, anti-blue" quarks.
 - 4: **Magnetic "south" photon** LOU. combining for all "negative/blue, anti-blue" quarks
 - 5: **Electric + photon** ROR. combining for all "positive/green, anti-green" quarks.
 - 6: **Electric - photon** LOL. combining for all "negative/green, anti-green" quarks.
- Quarks** are "click-on" combinations of e- and e+s with 5 different types of photons: 4 gluon types and 1 general type. (so: quarks are not elementary)

Together with 1,2 or 3 electrons, 3 photon types can "click on" and combine into different **negative charged quarks**.
 The **electron**: ORO can combine with LOL, LOU (gluons) and UOU (general photon)
 Together with 1,2 or 3 positrons, 3 photon types can "click on" and combine into different **positive charged quarks**.
 The **positron**: OLO can combine with ROR, ROU (gluons) and UOU (general photon)

Higgs boson (in code) OOO

The H-bosons is responsible for:

A: all .photon/gluon production, as continuous collision product with all masscarrying particles.

(OOO+lepton/quark= photon/gluon+lepton/quark

B: spontaneous pair production (OOO+OOO=ORO+ OLO (e- and e+)),

| | | |
|------------------|----------|---|
| Z | =ORO+OLO | Z-boson (electron + positron can "click" together, without annihilating each other) |
| Wo, W+ and W- | | don't exist as particles. |
| e- | =ORO | electron. |
| e+ | =OLO | positron. |
| ve | =RLR | electr. Neutrino. |
| $\bar{\nu}_e$ | =LRL | anti-electr. Neutrino. |
| ν_μ | =LLL | muonic neutrino. |
| $\bar{\nu}_\mu$ | =RRR | anti- muonic neutrino. |
| ν_τ | =ULU | tau neutrino |
| $\bar{\nu}_\tau$ | =URU | anti- tau neutrino |

For quark click-on combinations: see page 25 (pp).

Quark "up-grading" due to subjoining of extra ORO's (or OLO's) (energy addition) and extra gluons, joining from the "sea" of gluons (energy addition)

$$e^- \rightarrow \bar{u} \rightarrow d \rightarrow s \rightarrow \bar{c} \rightarrow b \rightarrow \bar{t}$$

$$\rightarrow \text{ORO} \rightarrow 1 \text{ORO} \rightarrow 1 \text{ORO} \rightarrow 2 \text{ORO} \rightarrow 2 \text{ORO} \rightarrow 3 \text{ORO} \rightarrow 3 \text{ORO}.$$

$$1 \text{gluon} \rightarrow 2 \text{gluon} \rightarrow 1 \text{gluon} \rightarrow 2 \text{gluon} \rightarrow 1 \text{gluon} \rightarrow 2 \text{gluon}.$$

$$e^+ \rightarrow u \rightarrow \bar{d} \rightarrow \bar{s} \rightarrow c \rightarrow \bar{b} \rightarrow t$$

$$\rightarrow \text{OLO} \rightarrow 1 \text{OLO} \rightarrow 1 \text{OLO} \rightarrow 2 \text{OLO} \rightarrow 2 \text{OLO} \rightarrow 3 \text{OLO} \rightarrow 3 \text{OLO}.$$

$$1 \text{gluon} \rightarrow 2 \text{gluon} \rightarrow 1 \text{gluon} \rightarrow 2 \text{gluon} \rightarrow 1 \text{gluon} \rightarrow 2 \text{gluon}.$$

The **muon** is equivalent with the **naked (anti) green d(own)-quark**
 The **tau** is equivalent with the **naked (anti) red b(ottom)-quark**

Figure; 10, Decay of Quarks and Leptons.

The differences between:

e- and \bar{u} , is one gluon,
 \bar{u} and d, is one gluon,
d and s, is one gluon changed form into an e-
s and \bar{c} , is one gluon,
 \bar{c} and b, is one gluon changed form into an e-
b and \bar{t} , is one gluon .

Quark “down-grading or decay” is going down the energy ladder, “spitting out” e-, e+'s and gluons in their original form (unchanged) or changed into neutrino's.

Quark stability is originated by the sub-quantum structure of the quark
If the structure has

1: an A-symmetric form (such as the (anti-)blue u-,s- and b-quarks), the ability to spin, and the stability is minor to those with a symmetric form.

2: more components, this will lead to:decrease of stability and mass increase due to more protuberances (more vulnerability for Higgs impulses) resp. more production of gravitons)

Lifetimes and decay routes of quarks should be dependant of these rules, but we see interesting changes:

The preferred (anti-) red-blue- green sequences of the decay ladders are changing between the charm and the bottom quarks.

The differences in the sequences of charges related to the mass ladder is not clear. Further investigation is needed.

Systematic summary of basic quark decay modes.

e- and e+ \Rightarrow UOU = general photon (annihilation)

| | | | |
|---------------------------------------|--|---------------------------|--|
| $\bar{u} \Rightarrow e-, \bar{\nu}_e$ | $\begin{array}{ l} \text{ORO} \Rightarrow \text{ORO} = e- \\ \text{LOL} \Rightarrow \text{LRL} = \bar{\nu}_e \end{array}$ | $u \Rightarrow e+, \nu_e$ | $\begin{array}{ l} \text{OLO} \Rightarrow \text{OLO} = e+ \\ \text{ROR} \Rightarrow \text{RLR} = \nu_e \end{array}$ |
| $\bar{u} \Rightarrow e-$ | $\begin{array}{ l} \text{ORO} \Rightarrow \text{ORO} = e- \\ \text{LOL} \Rightarrow \text{gluon sea} \end{array}$ | $u \Rightarrow e+$ | $\begin{array}{ l} \text{OLO} \Rightarrow \text{OLO} = e+ \\ \text{ROR} \Rightarrow \text{gluon sea} \end{array}$ |
| $\bar{u} \Rightarrow \bar{\nu}_\mu$ | $\begin{array}{ l} \text{ORO} \Rightarrow \text{RRR} = \bar{\nu}_\mu \\ \text{LOL} \Rightarrow \text{gluon sea} \end{array}$ | $u \Rightarrow \nu_\mu$ | $\begin{array}{ l} \text{OLO} \Rightarrow \text{LLL} = \nu_\mu \\ \text{ROR} \Rightarrow \text{gluon sea} \end{array}$ |

(d (anti-)green is also: μ)

| | | | |
|--|--|--|--|
| $d \Rightarrow e-, \bar{\nu}_e, \nu_\mu$ | $\begin{array}{ l} \text{ORO} \Rightarrow \text{ORO} = e- \\ \text{LOL} \Rightarrow \text{LRL} = \bar{\nu}_e \\ \text{LOL} \Rightarrow \text{LLL} = \nu_\mu \end{array}$ | $\bar{d} \Rightarrow e+, \nu_e, \bar{\nu}_\mu$ | $\begin{array}{ l} \text{OLO} \Rightarrow \text{OLO} = e+ \\ \text{ROR} \Rightarrow \text{RLR} = \nu_e \\ \text{ROR} \Rightarrow \text{RRR} = \bar{\nu}_\mu \end{array}$ |
|--|--|--|--|

| | | | |
|-----------------------------------|--|-----------------------------------|--|
| $\pi^- \Rightarrow \mu-, \nu_\mu$ | $d = \mu-$ | $\pi^+ \Rightarrow \mu+, \nu_\mu$ | $\bar{d} = \mu$ |
| $d\bar{u}$ | $\begin{array}{ l} \bar{u} \text{ORO} \Rightarrow \text{RRR} = \bar{\nu}_\mu \\ \text{LOL} \Rightarrow \text{gluon sea} \end{array}$ | du | $\begin{array}{ l} u \text{OLO} \Rightarrow \text{LLL} = \nu_\mu \\ \text{ROR} \Rightarrow \text{gluon sea} \end{array}$ |

| | | | |
|---------------------------------|--|---------------------------------|--|
| $K^- \Rightarrow \mu-, \nu_\mu$ | $\bar{u} =$ | $K^+ \Rightarrow \mu+, \nu_\mu$ | $u =$ |
| $s\bar{u}$ | $\begin{array}{ l} \text{ORO} \Rightarrow \text{RRR} = \bar{\nu}_\mu \\ \text{LOL} \Rightarrow \text{gluon sea} \end{array}$ | $\bar{s}u$ | $\begin{array}{ l} \text{OLO} \Rightarrow \text{LLL} = \nu_\mu \\ \text{ROR} \Rightarrow \text{gluon sea} \end{array}$ |

| | | | |
|-------|---|-------------|---|
| $s =$ | $\begin{array}{ l} \text{ORO} \Rightarrow \text{ORO} \\ \text{ORO} \Rightarrow \text{LOL} \\ \text{LOL} \Rightarrow \text{LOL} \end{array} = \mu^-$ | $\bar{s} =$ | $\begin{array}{ l} \text{OLO} \Rightarrow \text{OLO} \\ \text{OLO} \Rightarrow \text{ROR} \\ \text{ROR} \Rightarrow \text{ROR} \end{array} = \mu^+$ |
|-------|---|-------------|---|

Figure 11, systematic Quark modeling.

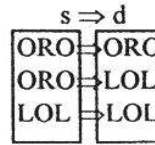
Three different kinds of Weak interactions.

Hydronic decays:

$$\Lambda_0 \Rightarrow \pi^- + p$$

$$uds \Rightarrow udd \Rightarrow \bar{u}d + uud$$

The principle interaction is:



$s \Rightarrow d$ and pair production (addition) of u and \bar{u} from the Higgs and gluon "sea"

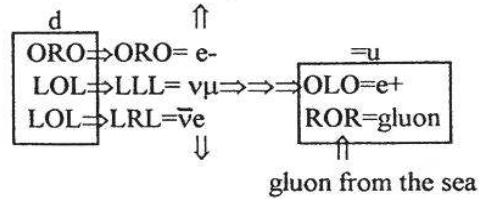
semi-leptonic processes

$$n \Rightarrow p + e^- + \bar{\nu}_e$$

$$ddu \Rightarrow duu + e^- + \bar{\nu}_e$$

The principle interaction is :

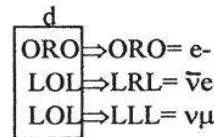
$$d \Rightarrow u + e^- + \bar{\nu}_e$$



leptonic processes

$$\mu^- \Rightarrow e^- + \bar{\nu}_e + \nu_\mu$$

$$d \Rightarrow e^- + \bar{\nu}_e + \nu_\mu$$



Some electromagnetic decays.

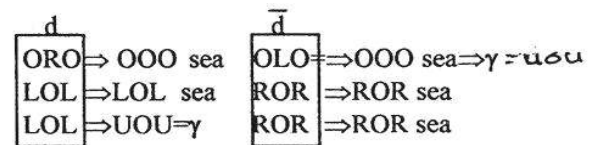
$$\pi_0 \Rightarrow \gamma + \gamma \quad \text{ORO+OLO anihilation} \Rightarrow 1x \gamma$$

$$u\bar{u} \Rightarrow 2 \gamma$$



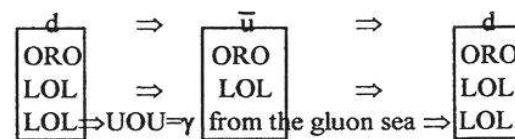
$$\eta_0 \Rightarrow 2\gamma \quad \text{ORO+OLO anihilation} \Rightarrow 1x \gamma$$

only: $\bar{d}d$ decays $\Rightarrow 2\gamma$
so first: $\bar{s}s \Rightarrow \bar{d}d$.



$$\Sigma_0 \Rightarrow \Lambda_0 + \gamma$$

$$uds \Rightarrow sdu + \gamma \quad d \Rightarrow \bar{u} \Rightarrow d$$



Some strong interactions.

$$\Lambda^{++} \Rightarrow p + \pi^+ : uuu \Rightarrow duu + u\bar{d}$$

↑———↑
d \bar{d} pair production from the Higgs and gluon sea

$$\Delta_0 \Rightarrow p + \pi^- : ddu \Rightarrow duu + d\bar{u}$$

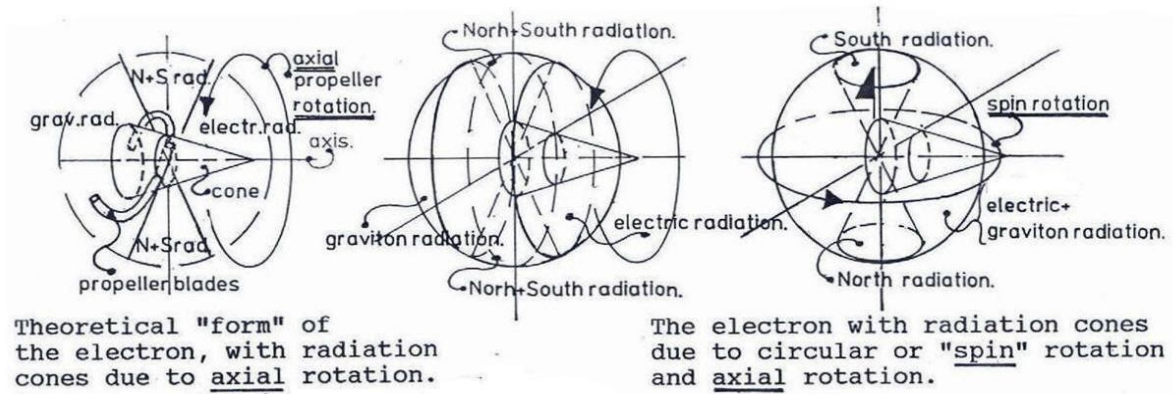
↑———↑
u \bar{u} pair production from the Higgs and gluon sea

$$\Delta_0 \Rightarrow n + \pi_0 : ddu \Rightarrow ddu + u\bar{u}$$

↑———↑
u \bar{u} pair production from the Higgs and gluon sea

Figure 12, Weak interactions.

The double spin of Fermions.



The "Eigen energy" distribution around the spinning Fermion propeller, is supposed to come in cone form. The Fermion spin and radiation is the product of a scattering process with oscillating Higgs vacuum particles. As a result, the Fermion has a double spin around two polar axes. This is supposed to be the origin of a dipole Magnetic field with North and South monopole photon radiation and the circular distribution of graviton and electric radiation. In addition it must be stated that all Fermions are entangled with their object /subject particle far away.

Figure 13, double spin of Fermion and Quark propellers.

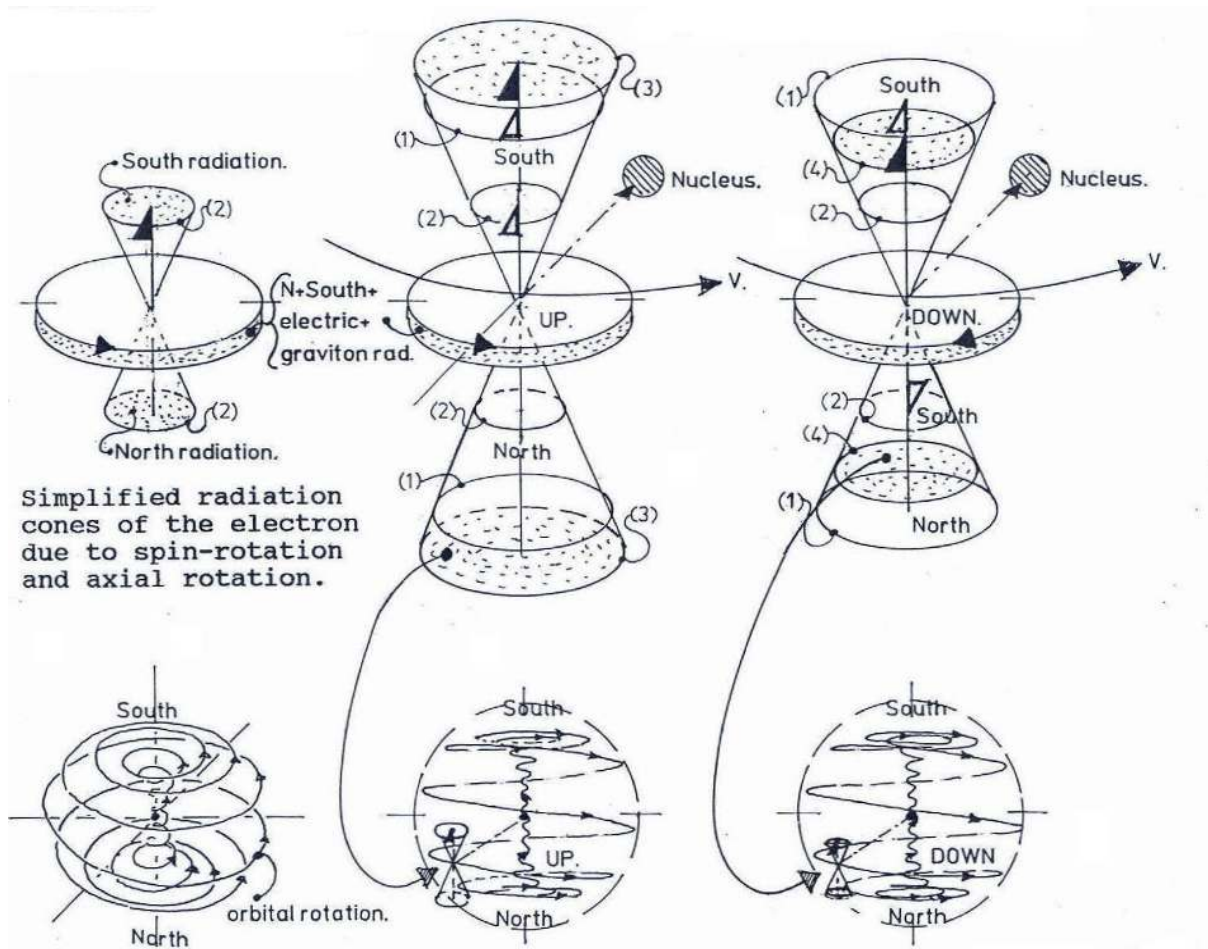


Figure 14, The difference between up and down Atoms.

Additional suggestion for the W^+ and Z particles.

The W particles could harbour one or two extra valence Electrons or Positrons to explain the recent so called Tevatron Bump at about 145 GeV, inside Fermilab's Tevatron collider.

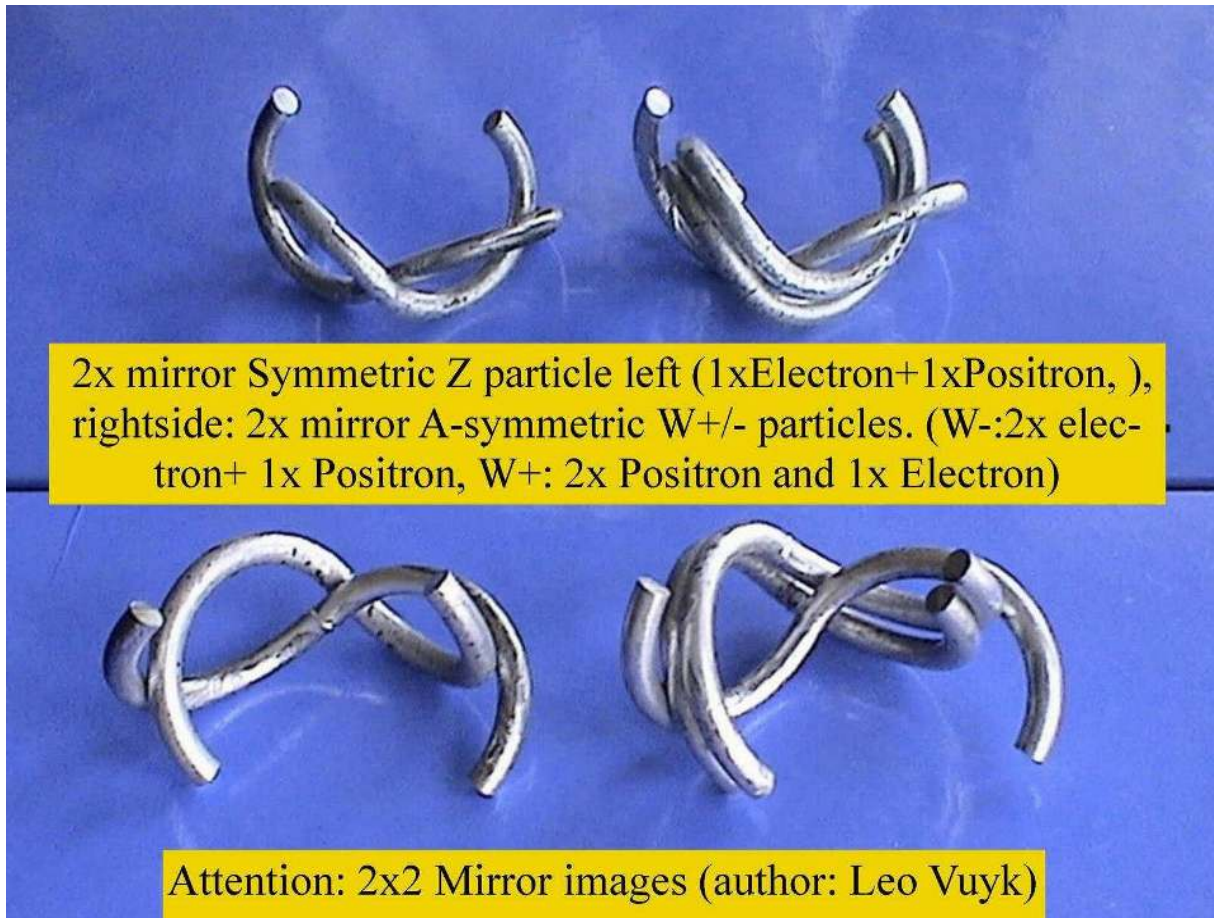


Figure 15 , W and Z compositions.

As we are able observe below in the Q-FFF model images, there is geometrical room for additional Gluons to the Top Quark of the 36 standard models to create a heavier Top Quark. Even additional electrons or positrons could be the origin of additional so called TOP Prime Quarks recently found at the Tevatron.

Quantum Function Follows Form Model

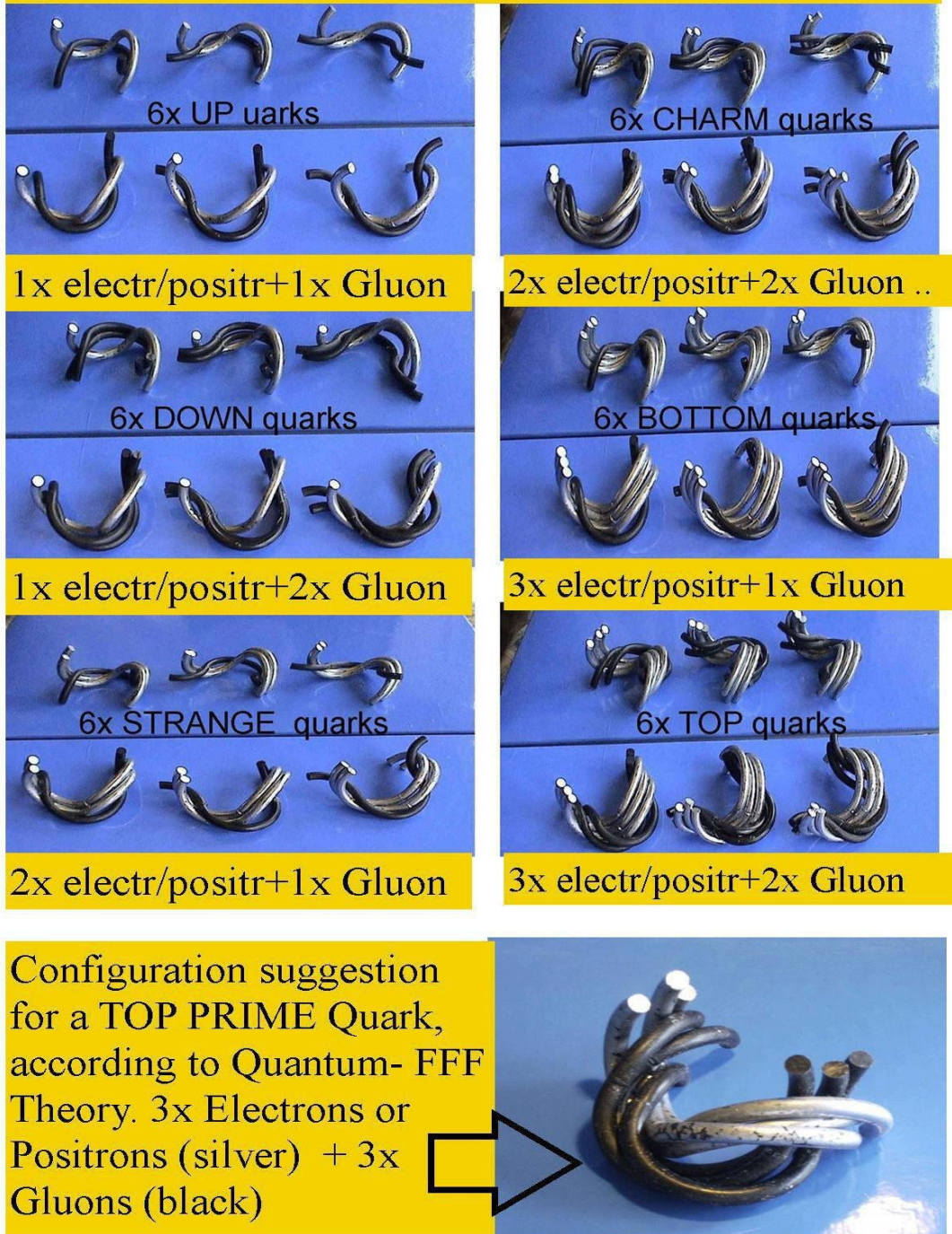


Figure 16, Configuration of composite Quarks.

The Axion Higgs Torus Particle (Macaroni shaped elements) The Axion Higgs Torus particle is designed as a real 3D Shape-changeable Particle, to model and mimic the sub-quantum structure of all known Particles described by the “standard model” and beyond the standard model, (monopoles, Gluons) to be able to explain even the most complex and weird particle decay processes like the Kaon decay. (See below and the Attached pages 1-6)

Only spinning particles gain mass by the production of gravitons out of the collision process with massless Axion Higgs particles

Decay examples:

Muon decay.

The Muon decaying compound “click-on” Particle (see Below) coded: (ORO,LOL,LOL). Is able to decay into three single parts: ORO+LRL+LLL. (changing one LOL into a LRL Particle (one hinge rotation over 90 degrees: R>L) and one LOL into a LLL Particle (one hinge rotation over 90 degrees: O>L).

These particles are called: the Electron(ORO), the anti-electro-neutrino (LRL) and the muonic neutrino (LLL).

Kaon decay.For normal Kaon plus decay, the main decay routes according to the literature are: (A: mu+, muonic neutrino)or (B: pi+, pi0)

The Kaon + Particle is coded: for the U-Quark:(OLO,ROR)and for the anti-S Quark: (OLO,OLO,ROR).

For the A route: it is proposed that the u-Quark (OLO,ROR)decays into (LLL,ROR) which Particle is supposed to disintegrate and produce the (LLL) muonic neutrino and one undetected Gluon (ROR) will disappear into the Gluonic “sea”.

The anti-s-Quark (OLO,OLO,ROR)will change into a positive muon (OLO,ROR,ROR).

For the B route: it is proposed that the U-Quark (OLO,ROR) does not decay and that the anti-S Quark also decays into (OLO,ROR,ROR) which is in combination with the U-Quark a positive pion+ Particle.

The pion-0 Particle coded: U, anti-U Quark: (OLO,ROR), and (ORO,LOL) are mirror symmetric and able to emerge directly from the vacuum as so called pair production results.

Rare Kaon–Plus decay.

A rare Kaon plus Particle decay: $K^+ \Rightarrow \pi^+, \nu, \bar{\nu}$, (pi + , neutrino anti-neutrino) is recently

discovered and now acknowledged by a Brookhaven
AGS experiment 949:see: <http://www.phy.bnl.gov/949/>

Interestingly this rare Kaon decay can easily be
derived from the “Axion Higgs Torus Particle”
system properties.

The most simple explanation by this Axion Higgs
Particle click-on system is to assume that the decay is the
same as route B mentioned before and in addition that the
Pion 0 Particle (OLO,ROR)+(ORO,LOL) decays into
two neutrinos.(OLO)=>(RLR) and (ORO)=> (LRL). The
(ROR) and (LOL) Gluons are supposed to “disappear
into the Gluonic “sea” as described above under route A.

Kaon Long/ Short decay.

It is proposed that the Kaon and anti Kaon Particles
(ds)are mixing with themselves and with the Eta (ss)
Particle by the continuous changing of one Gluon into
a Lepton to change the d Quark into an s Quark and
backwards a Lepton into a Gluon from s into a Quark.
(d<=> s)

At the same time it is proposed that the
backward changing d into s last longer due to the
slight chirality of the vacuum .

The angle of attack of the Tandem oscillating
Axion Higgs Particles to the Quarks, must be
slightly different. This is reason to propose that it is
the S, anti-S (Eta Particle) that is the reason for the
strange Kaon decay time-differences

Explanation: the Kaon 0 Particle coded as: d-Quark:
(ORO,LOL,LOL) anti-s Quark: (OLO,OLO,ROR)
will change into an Eta (s) Particle: s Quark:
(ORO,ORO,LOL) anti-s Quark: (OLO, OLO, ROR) by
the Direct Weak attack mechanism of the tandem vacuum
Particles to change three hinges of one compound Particle
at once (OLO <=> ROR, or ORO <=>LOL). Then after a
while, the intermediate (s anti-s) Eta Particle will be
changed into the anti-Kano-0, coded: S: (ORO,ORO,LOL)
anti-D:

(OLO,ROR,ROR,)

Thus it is assumed that the origin of this strange
Long and Short Kaon decay mechanism is to find in the
difference in transition speed for the LOL Gluon into the
ORO Electron (needed to change the d Quark into an s
Quark) which is supposed to be faster due to the chirality
of the vacuum than the transition speed to change the
OLO Positron into the ROR Gluon (needed to change
the anti-s Quark into an anti d Quark, to produce the anti
Kaon-0 Particle).

Special Weak Interactions:

The "Direct Weak attack mechanism by the tandem oscillating vacuum Particles" or "two Axion Higgs doublets".
Special Weak interactions are supposed to change all three Hinges at once without the aid of the Z-Particle, such as in Kaon 0,- Eta mixing processes (OLO \rightleftharpoons ROR or ORO \rightleftharpoons LOL described below).

Glueballs.

(for latest Glueball information see also;
http://arxiv.org/PS_cache/hep-ph/pdf/0209/0209339.pdf)

The shape of some Gluons makes it possible to suggest that these Particles are able to "click-on" to each other WITHOUT THE AID OF ELECTRON or POSITRONS and form so called Glueballs, found already 20 years ago in collider experiments.
Model experiments are pointing into the direction of 10x "bound state, click-on" possibilities for two Gluon Glueballs and also 8x Exotic "bound state, click-on" possibilities of Gluons with single Leptons (ORO and OLO).

10 different Knots with 2xGluon Bound States:

UOU+ROR, UOU+LOL.
UOU+LOU, UOU+ROU.

LOU+ROU 2x because there is also a second mirror image possible.

ROR+LOU, ROR+ROU.
LOL+LOU, LOL+ROU.

8x different Exotic Knots with Gluon-Lepton Bound States.

OLO+LOU, OLO+ROU.
OLO+LOL, OLO+UOU.

ORO+LOU, ORO+ROU,
ORO+ROR, ORO+UOU.

For comparison, see: 17 masses at
http://arxiv.org/PS_cache/hep-ph/pdf/0209/0209339.pdf
Page 11 figure 1, comparison between the Glueball spectrum and Knot energies. By: R. Buney.

2x different Knots with 3x Gluon bound states:

3x ROU or 3x LOU.

1x Knot with 4x Gluon bound states:

4x UOU.

This new description of elementary Particles, is based on the idea that Quarks are not single Particles but compound Particles (bound states) and able to be created out of the Axion Higgs vacuum at once as Particle anti-Particle (Quark) pairs, just like an Electron Positron pair and able to decay into smaller parts. (see Page 1)

Kitchen Table Models.

Based on real “kitchen table” model binding experiments, it is proposed that the 36 different Quarks of the “Standard model” are composed out of one, two or three Electrons, or Positrons and one or two Gluons, both kept together inside the Quark, by the special shape which these Axion Higgs Particles should have. All these forms are supposed to be derived by real shape transformation out of only one Particle, called the “Axion Higgs” Particle which should have a special Torus form.

The Torus form is supposed to be equally divided into FOUR rigid quarter parts, (like “Macaroni” tubes) each able to rotate axial relative to the neighbouring Macaroni tubes and change the shape of the original Axion Higgs Torus into more complex shapes.

It is assumed that the unification of Particles is based on a simple 90 degree axial “cutting-edge rotation” of the four quarters of the Axion Higgs Torus form.

This Toy system seems to be surprisingly a simple aid to mimic shapes for elementary Particles, exotic Particles like Glueballs and sub-quantum decay processes.

Axion Higgs (macaroni) Particle model description.

If we imagine a rubber Torus shaped Sealing Ring (say about 4 cm diameter and a thickness to ring diameter ratio of about 1: 7) which we cut in two halves, then we are able to make simple propeller forms out of it, with two different so called “Pitches”.

We are able to make propeller forms with a left handed Pitch, or with a right handed Pitch.

We can do so, by gluing the two halves together again after rotation of one half of the Torus over 90 degrees (left or right rotated), at one of the two cutting edges. (see page 2, 4,5 and 6)

At the same time, for more complex Particles we need

to cut the Torus into 4 equal quarters (macaroni parts), connected to each other by so called “Hinges”, which are proposed to be able to rotate axial in steps of 90 degrees.

For each Particle , there has to be only three Hinges which are coded by the mutual rotational displacement possibilities: O(=unchanged circle) ,U (=180 degree rotation), L (=90 degree Left hand rotation) and R (=90 degree Right hand rotation).

As a consequence, the most simple Particle shapes are the two “Pitched Propeller forms” described before, coded ORO and OLO., which we will call arbitrarily the Electron respectively the Positron.

As an other consequence, the Particle with three unchanged hinges is coded: (OOO), which is chosen to be the Axion Higgs-Particle.

A Particle with all three hinges with 90 degrees rotation to the Right relative to the neighbouring quarter part, is called (RRR) for three hinges with 90 degrees rotation left it is coded: (LLL) .

The Particle with three hinges rotated over 180 degrees is coded: (UUU).

However not all possible shapes are needed to mimic the standard model, so Particles with a middle hinge coded U : (XUX) are not used. The only Particles with U coded hinges are: UOU ULU URU LOU and ROU. (UOR and UOL are the same Particles as respectively ROU and LOU.)

Mechanistic particle transformation.

THE RING SHAPED Axion Higgs Particles coded(OOO) are supposed to oscillate in Tandem along so called linear Vacuum Lattices, two by two in opposite directions, as the symmetrical opposite pistons of a boxer engine, as the origin of all energy, spin and mass effects.

This enables the Tandem Axion Higgs Particles (doublets) to change the form of their own Torus into an Electron and Positron pair at the same time and to originate all other oscillations and interactions, as $d \leftrightarrow s$ and $c \leftrightarrow b$. It is proposed that Photon radiation is the result of mechanical change by collisions between Single Axion Higgs Particles and Quarks or Leptons.

There are 6 different shapes for Photons and 5 of them are supposed to act also as Gluons, because they are able to ”click –on” to a Positron or Electron and form Quarks, Muons or Tau Particles.

Weak interaction: The two-Axion Higgs doublets in collision with the Quark connected Gluons, are supposed to be able to change the symmetrical shape of three sorts of Gluons (UOU,ROR and LOL) into Neutrinos, respectively URU,ULU,RRR,RLR,LRL,LLL).

Z-Particles are so called Positroniums (compound Electron and Positron) able to catch neutrinos and form a compound temporary W Particle, which seem to be needed to be able to reshape the Neutrino into a Positron or Electron or even backwards.

As an example, in Neutron decay, the LOL (d-Quark: ORO+LOL+LOL) Gluon changes via a Muonic Neutrino LLL into a Positron OLO (u-Quark: OLO+ROR).(see page 3) With this Axion Higgs system, it is supposed that Axion Higgs

Particles are able to transfer Photonic geometrical information at a linear average speed of 7/4 the speed of Light. The expected transfer retardation at the vortexes of the Chiral Tetrahedron vacuum Lattice is included. This should enable the vacuum to mimic the isotropy of the speed of light.

See: <http://home.planet.nl/~vuyk0022/> see: “the Local Anti-Symmetrical Oscillating vacuum Frame” (LASOF)

Summary of the single shaped Particles.

The two simple propeller shaped Particles are coded:

ORO: the Electron.

OLO: the Positron.

Gluons.

There are in contrast with the standard model only 5 Gluons needed to satisfy the standard model colour differences of Quarks.

The Gluons are all 5 able to “click on to the Electron or Positron and form a compound Particles needed for all Quarks the Muon and Tau Particle . They are coded:

UOU, ROR, LOL, LOU, ROU.

Photons.

There are in contrast with the standard model : 6 different shapes for (Monopole) Photons, 5 of them have the same shape as the Gluons mentioned before, they are: .

UOU= Photon for visible and IR light.

ROR= electric + Photon

LOL= electric – Photon

LOU= magnetic South Photon

ROU= magnetic North Photon

.....

The Graviton ROL (or LOR)= is expected to be the Photon without “click-on” possibilities.

Because of the frequency overlap of gamma and x-ray radiation it could be possible that this radiation is not based on the so called General Photon UOU, but should be coded differently as LOO and ROO.

In that case there are 8 Photons in stead of 6.

Neutrinos.

Neutrinos are supposed to be NOT able to “click-on” with compound fermions as Gluons do.

In contrast Neutrinos are supposed to be originated as collision products out of the shape of one of the 5 Gluons or Electron or Positron by the standard Weak Z-Particle operation

Neutrinos with codes and origin Particles:

RRR: the anti-muon-neutrino. Possible origin

Particles: ROR, ORO

LLL: the muon-neutrino. LOL, OLO

RLR: the electro-neutrino. ROR, OLO

LRL: the anti-electro-neutrino. LOL, ORO

URU: the Tau-neutrino. UOU.

ULU: the anti-Tau-neutrino. UOU.

The Z-Particle.

The Z-Particle is supposed to be a very loose “click-on” compound combination of an Electron (ORO) and a Positron (OLO).

The W-Particle is not assumed to exist as a single Particle, it is assumed to be a Particle changing process, in combination with the “aiding” Z-Particle. The Z Particle is supposed to be a help by form changing processes of Standard Weak interactions (described above).

Quark generations.

The three different coloured Up-Quarks are coded:

ORO+LOL, or ORO+LOU, or ORO+UOU. (2 compound Particles)

Anti-Up-Quarks (three colours) are coded:

OLO+ROR, or OLO+ROU, or OLO+UOU. (2 compound Particles)

Down-Quarks (three colours) are coded:

ORO+2.LOL, or ORO+2.LOU, or ORO+2.UOU. (3 compound Particles)

anti-Down-Quarks (three colours) are coded:

OLO+2.ROR, or OLO+2.ROU, or OLO+2.UOU. (3 compound Particles)

The three different coloured Strange-Quarks are coded:

2.ORO+LOL, 2.ORO+LOU, or 2.ORO+UOU. (3 compound Particles)

Anti-Strange-Quarks (three colours) are coded:
2. OLO+ROR, 2.OLO+ROU, or 2.OLO+UOU. (3 compound
Particles .

Charm-Quarks (three colours) are coded:
2.ORO+2.LOL, 2.ORO+2.LOU, or 2.ORO+2.UOU. (4 compound
Particles)

anti-Charm-Quarks (three colours) are coded:
2.OLO+2.ROR, 2.OLO+2.ROU, or 2.OLO+2.UOU. (4 compound
Particles)

The three different coloured Bottom-Quarks are coded:

3.ORO+LOL, 3.ORO+LOU, or 3.ORO+UOU. (4 compound
Particles)

Anti-Bottom-Quarks (three colours) are coded:
3. OLO+ROR, 3.OLO+ROU, or 3.OLO+UOU. (4 compound
Particles)

Top-Quarks (three colours) are coded:
3.ORO+2.LOL, 3.ORO+2.LOU, or 3.ORO+2.UOU. (5 compound
Particles)

anti-Top-Quarks (three colours) are coded:
3.OLO+2.ROR, 3.OLO+2.ROU, or 3.OLO+2.UOU. (5 compound
Particles)

Compound Leptons: Muon Particles are coded: mu+: OLO+2ORO,
(=anti-d-Quark) mu-: ORO+2.LOL.(=d-Quark)
Tau Particles are coded: tau+: 2.OLO+2UOU, (=c-Quark).
tau-: 2ORO+2UOU.(=anti-c-Quark)

Counting Particles. I count: 6 Photons (Gluons included) , 6
single neutrinos, 2 single leptons and one single
Axion Higgs-Particle= 17 single Particles. +36
compound Quarks and one compound Z Particle =
54 different formed functional Particles if we
exclude exotic Particles like Glueballs etc.(see
below)

MATTER CREATION AND THE CHIRAL VACUUM.

A new reason for a dual-symmetrical smooth evaporation
of multiple anti-mirror universes in an alternative
Big Bang process, is based on the new system for
elementary Particles, described before and the
chirality of the Axion Higgs-Particle based
vacuum .

The chirality of the vacuum , should be responsible,
for our material universe, because it is assumed that

anti-matter is less stable than matter within the moment of creation in a chiral oscillating vacuum after the “semi-cold Axion Higgs particles evaporating Big Bang”.

Thus Matter in our universe, is supposed to be created without annihilation processes, direct out of the evaporated vacuum Axion Higgs-Particles.

At a result, the chirality of the vacuum should be responsible for the origin of strange CP violations found in the so called Kaon- O Short and Long decay.

=====

References:

Books:

1: The Physics of Rigid Transformer Strings. LuLu 2019.

2: The New God Particle and Free Will. Author: Leo Vuyk, LuLu publishers, 2008. ISBN number 978-1-4092-1031-3 <http://www.lulu.com/spotlight/LeoVuyk>

Quantum FFF Theory is also published in the form of POSTERS at the Flickr site:

<http://www.flickr.com/photos/93308747@N05/>

Numbered listing (below: latest) of Vixra essays by Leo Vuyk.

http://vixra.org/author/leo_vuyk

[129] [viXra:1911.0346](#) The Cyclic Undivided Raspberry Multiverse.

[128] [viXra:1909.0417](#) The Magic Fermion Repelling Stringy Fuzzball Black Hole, the Origin of a Cyclic Raspberry Multiverse.

[127] [viXra:1907.0250](#) The Conscious Readiness Potential Ratio Multiverse with Transactional Interpretation of J. Cramer.

[126] [viXra:1905.0244](#) EM Drive Thruster by Anti Maxwell Monopole Tubular Field Reduction Around a Conductor.

[125] [viXra:1905.0123](#) The Conscious Undivided Multiverse,

[124] [viXra:1904.0599](#) The Origin of Universal Structure: Herbig Haro -Electric Dark Matter Black Hole- Systems.

[123] [viXra:1903.0447](#) Black Hole Creation and Destruction of the Cyclic Conscious Multiverse.

[122] [viXra:1903.0347](#) Visualizing Subatomic Particles as Building Blocks of the Universe.

[121] [viXra:1903.0102](#) What Is Wrong With Physics?

- [120] viXra:1902.0349 The Electric Universe by Electric Dark Matter Big Bang Black Holes of Quantum FFF Theory.
- [119] viXra:1902.0201 Novel Ideas About Dark Matter and the SuSy Multiverse.
- [118] viXra:1901.0426 4x and 3x Interference for Stringy Bose Einstein Black Hole Production.
- [117] viXra:1812.0228 Equal Sized Rigid String Based New Black Holes do not Merge But, Form Herbig Haro Systems.
- [116] viXra:1812.0095 $E = not Mc^2$ in Massless Black Holes According to Quantum FFF Theory.
- [115] viXra:1811.0125 Testing Proposals for Human Free Will in the Raspberry Multiverse, Local Entanglement and M&M Lightspeed.
- [114] viXra:1811.0002 Big Bang Energy out of Nothing, or a Compressed Rigid String Nucleus
- [113] viXra:1809.0189 Apparent Violation of the Second Law, Around Black Hole Nuclei and Other Quantum Knots.
- [112] viXra:1807.0437 Preference for Dual Herbig Haro Black Hole Consumption by the Central MW Black Hole, Leaving Plasma Jets Behind.
- [111] viXra:1806.0368 A Fifth Force Vacuum Dipole Repeller, Needed to Create All Attraction Forces Even Around Black Holes in Quantum FFF Theory.
- [110] viXra:1806.0298 Expanding Earth, by Growing Water based Crashed Comet core.
- [109] viXra:1806.0068 Primordial Electric Dark Matter Black Holes Outside Galaxies Responsible for the Creation and Contraction of a Cyclic Multi-Universe.
- [108] viXra:1805.0541 Tidal Star Disruption Events (TDE) by Fermion Repelling Black Holes in Quantum FFF Theory.
- [107] viXra:1805.0307 Fulgurite Created by Lightning Bullet Also Known as Ball Lightning, According to Quantum FFF Theory.
- [106] viXra:1804.0138 Non Inertial Dark Matter Black Hole Galaxy Hierarchy According to Quantum FFF Theory.
- [105] viXra:1803.0100 submitted Free Will Readiness Potential Ratios, the Key for a Multiverse Number Calculation.
- [104] viXra:1803.0093 Skyrmion Interference Black Holes, Photonic Molecules, Ball Lightning, Micro Comets, Sprite-Fireballs and Sunspots According to Quantum FFF Theory.
- [103] viXra:1801.0121 Quantum FFF Theory, a Conscious String Theory with Different Vacuum Trajectories for Axion-Higgs Field/ Photons Respectively Fermions, Gluons and Bosons.
- [102] viXra:1711.0379 The Raspberry Shaped Multiverse, Pulsating Between Big Crunch and Big Bang, Based on Rigid Transformable Massless Axion Higgs Particles.
- [101] viXra:1711.0327 The Einstein Cross Lensing Effect Explained by the Quadruple Dark Matter Formation Process of Edge-on Spiral Galaxies, According to Quantum FFF Theory.
- [100] viXra:1711.0237 Higgs Particle Based SIMPs for Ancient and Future (Stone) Cutting Technology.
- [99] viXra:1711.0112 Higgs Quantum Knots is Dark Matter is Black Holes or: Higgs Dark Matter Black Holes.
- [98] viXra:1710.0257 Kilonova Merger Black Holes as the Origin of Dark Matter Black Hole Halo Population.
- [97] viXra:1710.0115 Grand Unification of 4 Forces According to the Quantum FFF Model by di-Monopole Repeller Rigid String Pressure.
- [96] viXra:1710.0050 Emergent Gravity by Dipole Repeller Rigid String Pressure the Origin of Quantum Gravity and Non Inertial Black Holes.
- [95] viXra:1710.0034 The New Physics Black Hole Nucleus: Gravity Without Inertial Mass Effects.
- [94] viXra:1709.0396 Dual Solar Anchor Black Holes or Herbig Haro Hotspots, the Origin of Quick Star Formation.
- [93] viXra:1709.0388 Splitting Dark Matter Black Hole Big Bang as the Origin of Ultra-Energetic-Cosmic-Rays-From Far-Away

- [92] viXra:1709.0216 Photonic Molecule based Higgs Photonic Knots of Different Masses the Origin of Future Lightsaber use?
- [91] viXra:1708.0296 The Origin of “Ultra Diffuse Galaxies” in Galaxy Cluster Centers.
- [90] viXra:1708.0170 Action Without Reaction Symmetry for em Space Propulsion Thruster Technology.
- [89] viXra:1708.0083 Dipole Repeller Gravity Effects at Different Universal Scales as the Origin of Large Scale and Local Quantum Gravity and Hubble Redshift.
- [88] viXra:1707.0224 The Magic of the New Electric Dark Matter Black Hole on Earth and Space.
- [87] viXra:1707.0189 Black Hole Nuclei as a Bunch of Rigid Transformable Higgs Strings Splitting by Relative Small Companion Mergers or Decreased Vacuum Pressure.
- [86] viXra:1706.0490 The Origin of “Dead” Galaxies.
- [85] viXra:1706.0420 Mass in Motion According to Quantum FFF Theory.
- [84] viXra:1706.0413 Magnetic Monopole Test to Demonstrate the Existence of a Anti Maxwell Dead Zone Around a Current in a Wire.
- [83] viXra:1705.0153 A Different Black Hole Horizon Interpretation Leading to Entropy Reduction and Violation of the Second Law.
- [82] viXra:1705.0026 The Magic of Life- and Matter Creating Self Propelled Electric Dark Matter Black Holes Guided by a Holographic Entangled Symmetric Multiverse System.
- [81] viXra:1704.0272 Interference Black Holes, Ball Lightning, Micro Comets, Sprite Fireballs and Sunspots According to Quantum FFF Theory.
- [80] viXra:1704.0150 The Origin of Life and the Need for a Rigid String Propeller Fermion Model Combined with a Chiral Vacuum Lattice and Micro Interference Black Holes
- [79] viXra:1704.0133 2. Signals for Retarded Single Big Bang Black Hole Nucleus Splitting and Pairing into Dual Black Hole Herbig Haro Systems
- [78] viXra:1704.0047 Bohmian Double Slit Interpretation by Dual Entangled Universes, and the Benjamin Libet Experiment.
- [77] viXra:1704.0003 A Testable CP Symmetric Multiverse Model by Extended Experiments, Done by the Late Benjamin Libet in 1964.
- [76] viXra:1702.0109 CP Symmetry Between Material and Anti Material Copy Universes Combined with Local- and Multi-Universal Cycle Time.
- [75] viXra:1702.0040 The Alternative Origin of Hubble Redshift : Vacuum Absorption by black holes as a Support for Quantum Dipole Repeller Gravity and a Contracting Universe.
- [74] viXra:1701.0633 Local and Multi-Universal Cycle Time According to Quantum FFF Theory. (FFF= Function Follows Form)
- [73] viXra:1612.0365 John S. Bell Was Right: “How to Teach Special Relativity” and Atomic Pear Shaped Contraction.
- [72] viXra:1612.0026 Democratic Free Will and Telepathy in the Instant Entangled
- [71] viXra:1611.0226 Galaxy Cluster Merging and Vacuum Absorption by black holes as a Support for Quantum Dipole Repeller Gravity and a Contracting Universe.
- [70] viXra:1611.0101 Observed Dual Higgs Mass 124-126 GeV and the Chirality of the Vacuum Lattice.
- [69] viXra:1611.0031 Rigid String Cosmology with a Massless Axion-Higgs Oscillating Photon Vacuum Lattice and Massive Quantum Knots.
- [68] viXra:1611.0005 Electric Dark Matter Black Holes in the Moon (Orientale Basin)
- [67] viXra:1609.0407 New Physics Elements in the Quantum Function Follows Form Model.
- [66] viXra:1608.0329 God Seems to Play Dice with Dual Entangled Pinball Machines in a Super symmetric (Susy) Multiverse
- [65] viXra:1607.0376 Axion-Higgs 3-Dimensional Rigid Transformable Strings and the Compound 650 GeV Z-Z Decay into Quarks/Lepto quarks.
- [64] viXra:1605.0257 Reaction Less Drive by Anti Maxwell Dead Zone Around a Wire.
- [63] viXra:1604.0372 Herbig Haro Hotspots or Bow shocks Are the Origin of Star Formation, not the Result as the Mainstream Suggest.
- [62] viXra:1604.0229 $E=ep$ in the Super symmetric Cyclic Multiverse and in the Lab

Without Strange Cats.

- [59] viXra:1505.0101 The Origin of Bok Globules and Molecular Clouds, Splitting and Pairing Electric Dark Matter Black Holes.
- [58] viXra:1503.0186 Primordial Dark Matter Black Holes Outside Galaxies Responsible for the Creation and Contraction of a Cyclic Universe? 22
- [57] viXra:1503.0097 Quantum FFF Theory, Poster News 4.2
- [56] viXra:1502.0086 Parity and Chirality as a Base for Quark-Gluon Plasma and Dust Creating Black Holes and the Beginning and End of Time..
- [55] viXra:1411.0039 Quantum FFF Theory, Poster News 2
- [54] viXra:1410.0039 Evidence for Dark Matter Black Hole Based Plasma, Dust and Ice Production Inside Comets Like 67P,C-G. and the Growing Earth.
- [53] viXra:1409.0164 The O'Connell Effect in Eclipsing Binaries Explained by Mass Related Light Speed Extinction Distances (Lasof) of Stars and Even Planets. (See also figure 29)
- [52] viXra:1407.0001 Evidence for Evaporating Dark Matter Particles in Silicon Fireballs.
- [51] viXra:1406.0076 Galaxy Formation and Evolution According to Quantum FFF Theory.
- [50] viXra:1406.0019 Quantum FFF Theory Proposals for Some Unsolved Physics Problems.
- [49] viXra:1405.0224 Dual Star Ejection in Open Star Clusters by the Central Star.
- [48] viXra:1404.0151 Future Free Energy of New Physics Ball Lightning Black Holes, the Origin of a Super Social Society or the Opposite?
- [47] viXra:1404.0002 Proposal for the Origin of Unexpected Large B-Modes Found in the Bicep2 Measurements.
- [46] viXra:1402.0132 Reconciliation of GR and QM by a New Gravity-Black Hole and Lightspeed Model Called Quantum- FFF Theory.
- [45] viXra:1402.0044 The Impossible Zero Point Electric Black Hole as the Origin of New Physics even for Comets like 67P,C-G.
- [44] viXra:1401.0115 Calabi Yau Shaped Double Fermion Spin States.
- [43] viXra:1401.0071 Democratic Free Will in the Instant Entangled Multiverse.
- [42] viXra:1312.0143 The Navel Cord Multiverse with Raspberry Shape, a Super Symmetric Entangled 12 Fold Bubble Universe.
- [41] viXra:1312.0076 Are Sunspots Made of Gravitating Dark Matter Black Holes?
- [40] viXra:1310.0101 The New Nuclear Magic Number (34) Explained by the Polar Coaxial Ring System of Quantum FFF Theory.
- [39] viXra:1310.0059 The Semi Relativistic Higgs Field Aether with Mass Related Lightspeed Adaptation.
- [38] viXra:1309.0081 New Physics by Table Top Experiments.
- [37] viXra:1308.0083 23 The Raspberry Shaped Super Symmetric Multiverse
- [36] viXra:1307.0068 Quantum Function Follows Form Theory, the Small Scale, Posters part 1.
- [35] viXra:1307.0067 Quantum Function Follows Form Theory, the Large Scale, Posters part 2.
- [34] viXra:1306.0218) Dark Matter UFO Dust Particles or Quantum Knots in the LHC at CERN ?
- 33, viXra:1306.0065 The Splitting Dark Matter- Black Hole- Big Bang and the Cyclic Multiverse.
- 32, viXra:1305.0140 Quantum FFF Theory Experiments, a Summary.
- 31, viXra:1305.0041 The Shnoll Effect Explained by Quantum FFF Theory.
- 30, viXra:1304.0022 The Self Organizing Universe in the Carina Nebula.
- 29, viXra:1303.0211 Hubble Redshift Combined with Universal Contraction is Possible.
- 28, viXra:1303.0053 Micro Birkeland Currents Between Two RF Generated Plasma Balls in the Laboratory.
- 27, viXra:1302.0172 Silicon Based Ball Lightning Globule Structures and Signs for Accumulation and Retarded Decrease of Tunneling Energy Bullets.
- 26, viXra:1301.0088 Two or Three Large Quasar Groups (LQGs) Located at the Start of Two or Three Lyman Alpha Systems and a Part of the Raspberry Multiverse?
- 25, viXra:1301.0050 Dwarf Galaxies and Their Relation with Dark Matter Based Galaxy Anchor Black Holes (Gabhs).

- 24, viXra:1210.0177 Instant Broglie Bohm Pilot Waves, the Origin of All Entanglement Effects in the Lab and Wavefunction Collapses in Our Universe as Related to Our Opposing Anti-Copy Universe(s) According to Quantum FFF Theory.
 - 23, viXra:1209.0092 New Dark Matter Black Holes and a New Dark Energy Higgs Field, Lead to a Bouncing CP Symmetrical Multiverse, and New Experiments.
 - 22, viXra:1209.0061 Birkeland Currents, Sunspots, Comets and Ball Lightning Originated by New Paradigm Dark Matter Black Holes.
 - 21, viXra:1209.0030 Majorana and Sterile Neutrino Solutions in the Quantum-FFF Model.
 - 20, viXra:1208.0031 Clumpy Dark Matter Around Dwarf Galaxies a Support for an Alternative Black Hole Theory According to the Quantum Function Follows Form Model.
 - 19, viXra:1202.0091 Earth Magnetic Monopole Array Field Interaction with Cyclotron – Synchrotron Electrons and Muon Conversion Used for Levitation Systems.
 - 18, viXra:1201.0092 Earth Magnetic Monopole Array Field Interaction with Cyclotron Electrons used for Levitation Systems.
 - 17, viXra:1112.0065 24 LHC Signals Between 121-130 GeV Interpreted with Quantum-FFF Theory
 - 16, viXra:1111.0096 Reconciliation of QM and GR and the Need for a Pulsating Entangled CPT Symmetric Raspberry Shaped Multiverse.
 - 15, viXra:1111.0061 Black Hole Horizon Curvature Dependent Balance Between Plasma Creation and e-e+ Annihilation in Quantum FFF Theory.
 - 14, viXra:1108.0036 Artificial Ball Lightning Production and Exploitation Device for Zero Point Electric Energy Usage.
 - 13, viXra:1108.0006 Mass in Motion in Quantum FFF Theory
 - 12, viXra:1104.0083 Quantum FFF Theory in Posters.
 - 11, viXra:1104.0044 Ball Lightning, Micro Comets, Sprite-Fireballs and X-Ray/gamma Flashes According to Quantum FFF Theory.
 - 10, viXra:1104.0002 Stellar Anchor Black Holes as the Remnants of Former Herbig Haro Objects
 - 9, viXra:1103.0097 ZPE Zero Point Energy Examples Around Black Holes.
 - 8, viXra:1103.0068 Function Follows Form, at the Quantum Scale and Beyond.
 - 7, viXra:1103.0024 Quantum Gravity and Electro Magnetic Forces in FFF Theory
 - 6, viXra:1103.0015 Wavefunction Collapse and Human Choice-Making Inside an Entangled Mirror Symmetrical Multiverse.
 - 5, viXra:1103.0011 An Alternative Black Hole, Provided with Entropy Decrease and Plasma Creation
 - 4, viXra:1103.0002 3- Dimensional String Based Alternative Particles Model
 - 3, viXra:1102.0056 Experiments to Determine the Mass Related Lightspeed Extinction Volume around massive objects.
 - 2, viXra:1102.0054 Atomic Nuclear Geometry Based on Magic Number Logic.
 - 1, viXra:1102.0052 Construction Principles for Chiral “atoms of Spacetime”
-
-

