

# A 5G mm-wave compact voltage-controlled oscillator in 0.25 $\mu\text{m}$ pHEMT technology

Abdelhafid Es-saqy<sup>1</sup>, Maryam Abata<sup>2</sup>, Mahmoud Mehdi<sup>3</sup>, Mohammed Fattah<sup>4</sup>, Said Mazer<sup>5</sup>,  
Moulhime El Bekkali<sup>6</sup>, Catherine Algani<sup>7</sup>

<sup>1,2,5,6</sup>Sidi Mohamed Ben Abdellah University, Fez, Morocco

<sup>3</sup>Lebanese University, Beirut, Lebanon

<sup>4</sup>My Ismail University, Meknes, Morocco

<sup>7</sup>Gustave Eiffel University, CNRS, Le Cnam, Paris, France

## Article Info

### Article history:

Received Apr 7, 2020

Revised Jun 8, 2020

Accepted Jun 28, 2020

### Keywords:

5G

Compact VCO

mm-Wave band

pHEMT transistor

pHEMT varactor

## ABSTRACT

A 5G mm-wave monolithic microwave integrated circuit (MMIC) voltage-controlled oscillator (VCO) is presented in this paper. It is designed on GaAs substrate and with 0.25  $\mu\text{m}$ -pHEMT technology from UMS foundry and it is based on pHEMT varactors in order to achieve a very small chip size. A 0dBm-output power over the entire tuning range from 27.67 GHz to 28.91 GHz, a phase noise of -96.274 dBc/Hz and -116.24 dBc/Hz at 1 and 10 MHz offset frequency from the carrier respectively are obtained on simulation. A power consumption of 111 mW is obtained for a chip size of 0.268 mm<sup>2</sup>. According to our knowledge, this circuit occupies the smallest surface area compared to pHEMTs oscillators published in the literature.

This is an open access article under the [CC BY-SA](https://creativecommons.org/licenses/by-sa/4.0/) license.



## Corresponding Author:

Abdelhafid Es-saqy

Artificial Intelligence, Data Sciences and Emerging Systems Laboratory

Sidi Mohamed Ben Abdellah University

Sidi Mhammed Belahssane, Oulad Aliane, Taounate, Morocco

Email: [essaqyabdelhafid@gmail.com](mailto:essaqyabdelhafid@gmail.com)

## 1. INTRODUCTION

As any new generation of mobile communication, 5G must offer better performance than previous generations. According to the International Telecommunication Union, 5G is expected to support very high download speeds (until 10 Gbit/s), and an extremely low latency time (about 1 ms) [1]. As the microwave frequency band is, practically, fully occupied, new frequency bands are required to meet the needs of 5G. In the millimeter-wave band, 26 GHz to 2 GHz frequencies are the most recommended by 5G actors [2].

Millimeter-wave frequencies offer huge capacity, allowing more transferred data through a particular channel in order to achieve multi-gigabit rates per second [3] and a very low latency time. Such advantages offer new opportunities for high-speed wireless Internet access, data and video streaming, and cable replacement. In return, it requires a reliable design process, a qualified foundry design kit based on rigorous modelling of passive and active components, and also predictable simulations in time and frequency domains that can handle highly non-linear integrated circuits.

Each communication system integrates local oscillators Figure 1 [4] and its own performance influences the performance of the entire system. Therefore, the design of a VCO for millimeter frequencies presents a great challenge for RF circuit designers [5]. For most VCOs published in the literature, the oscillation frequency tuning is obtained using varactors [6-10]. Due to the high level of varactor Amplitude-to-Phase

noise conversion [11], reference [12] presents a frequency tuning technique based on varactor-mounted GaAs pHEMT transistors in order to minimize the noise conversion and to reduce the size of the final circuit and its fabrication costs, too.

In this paper, we follow the approach of [12] using the PH25 process technology from UMS foundry. The circuit studied in this paper presents good performance in terms of phase noise (PN) level, output power and DC power consumption while occupying less than half of the area occupied by the structures proposed in [12-15]. This paper is organized as follows: in section 2, we present the VCO circuit as well as its layout. While the third section is dedicated to the results of post-layout simulation. Then these results are analyzed and compared with others from the literature in section 4. Finally, a conclusion is presented in the last section.

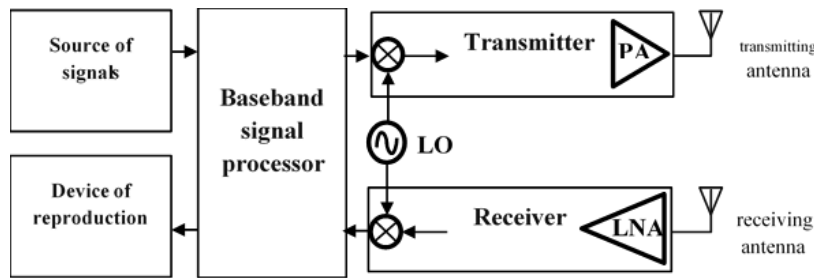

Figure 1. Simplified diagram of the transceiver system

## 2. VOLTAGE CONTROLLED OSCILLATOR CIRCUIT

The architecture of the proposed VCO is based on the Colpitts structure studied in the references [16-18] and the structure proposed by the authors in [12] as shown in Figure 2. The active part of this oscillator consists of two transistors pHEMT 1 and pHEMT 2: each one has 4 fingers and a gate length and width of 0.25  $\mu\text{m}$  and 20  $\mu\text{m}$ , respectively. A higher number of fingers increases the output power [19]. Each transistor is biased at the operation point ( $V_{DS}=2.2\text{ V}$ ,  $V_{GS} -0.6\text{ V}$ ) and the three inductors  $L_{d1}$ ,  $L_{d2}$  and  $L_g$  equals respectively to 0.15 nH, 0.15 nH and 0.1 nH. The performance of the circuit strongly depends on the bias conditions [20], for this reason the values of the bias voltages and inductors are chosen carefully. The resonant circuit of the VCO is based on two source-drain shorted transistors pHEMT 3 and pHEMT 4. Consequently, these two transistors act like varactors whose capacitance value is tuned by the voltage source  $V_{tune}$  applied to their gates.

The VCO circuit is based on passive components and pHEMT transistors of the PH25 process (United Monolithic Semiconductors foundry). The passive and active devices models fit well their performances, and they integrate parasitic behaviors. Therefore, in order to obtain the layout presented in Figure 3, a number of optimization and retro-simulation steps are required. In order to minimize any kind of asymmetry in the generated waveforms, and to avoid the introduction of additional noise, special attention has been focused on the layout symmetry [21].

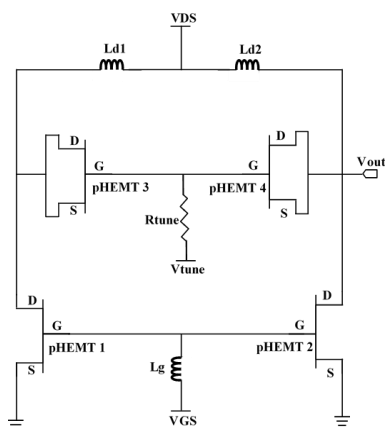

Figure 2. Voltage controlled oscillator circuit

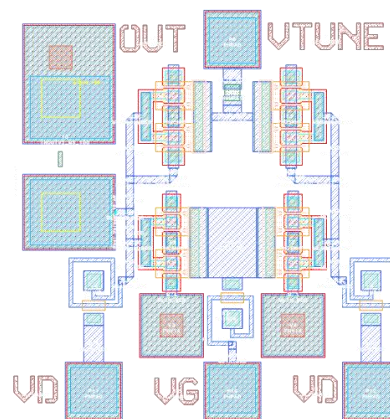

Figure 3. VCO layout

The circuit is implemented on GaAs substrate for a chip size circuit equal to  $0.268 \text{ mm}^2$  ( $540 \times 496 \text{ }\mu\text{m}$ ). The chip includes the oscillator circuit, RF access pad and three bias pads. While the chip size of the circuits presented in [8, 12, 15] are  $3.75 \text{ mm}^2$ ,  $0.515 \text{ mm}^2$  and  $0.5 \text{ mm}^2$  respectively. It is therefore a compact and reduced structure, compared to the structures published, recently, in the literature.

### 3. POST-LAYOUT SIMULATION

In order to ensure that the designed circuit will operate as expected, it is essential to carry out post-layout simulations that consider all the parasitics and undesirable effects related to the additional interconnection lines and parasitic aspects of the passive and active elements. For designing and optimizing an oscillator, the first step is to verify the oscillation stability of the circuit. The oscillator converges if the two Barkhausen conditions are satisfied, i.e., at the oscillation frequency, the loop gain is greater or equal to 1 and the phase is near zero [22, 23]. This can be easily verified by using the "OscTest" tool available in the ADS simulator. As we can observe in Figure 4 (a), at frequencies around 28 GHz, the reflexion coefficient magnitude is 1.001 and its phase is  $0.002^\circ$  on small signal simulation, therefore the Barkhausen conditions are well verified.

Large signal simulation with harmonic balance shows the power spectrum of the output signal  $V_{out}$  Figure 4(b), we can clearly see that the fundamental power is around 0 dBm, it is constant over the entire voltage tuning range of the VCO. The output powers of the first and second harmonics are  $-28.67 \text{ dBm}$  and  $-2.05 \text{ dBm}$  respectively, corresponding to 28dB rejection of the first harmonic and 22 dB rejection of the second harmonic. The oscillation frequency varies between 27.67 GHz and 28.91 GHz when varying the gate pHEMT1 and pHEMT2 voltages from 1.5 V to  $-4.1 \text{ V}$  Figure 5 (a). Consequently, the circuit has a frequency tuning range of 1.24 GHz, corresponding to a frequency sensitivity of  $221.4 \text{ MHz/V}$ . Figure 5 (b) shows the time domain of the output signal  $V_{out}$ , the signal shape is clearly sinusoidal (for  $V_{tune}=1.3 \text{ V}$ ). The phase noise simulation, presented in Figure 6, shows that phase noise are  $-96.274 \text{ dBc/Hz}$  and  $-116.27 \text{ dBc/Hz}$  at offset frequency 1 MHz and 10 MHz from the carrier, respectively.

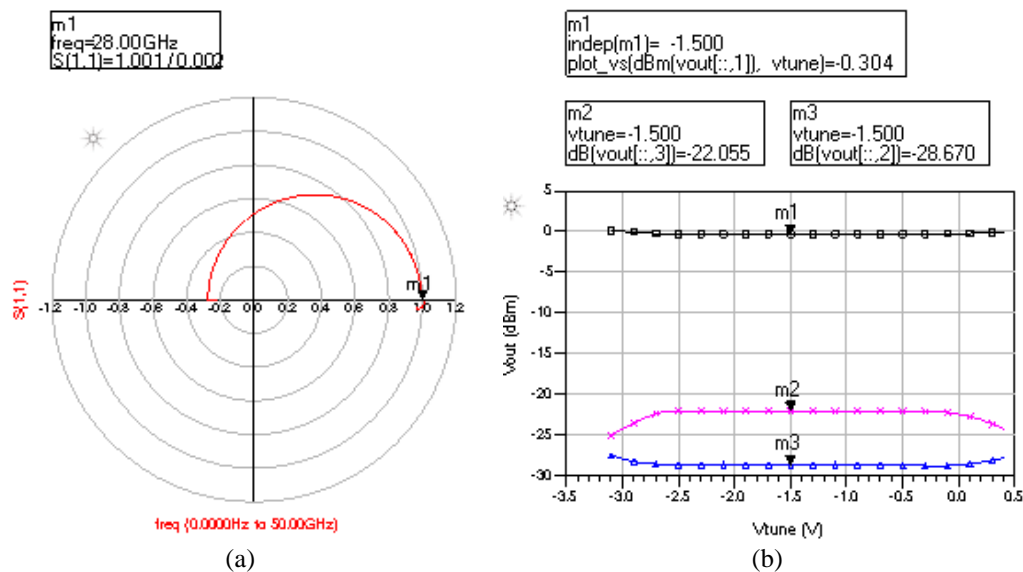

Figure 4. (a) Loop gain and, (b) power of the fondamental ( $\square$ -), first ( $\Delta$ -) and second ( $\times$ -) harmonic versus  $V_{tune}$

Nowdays, the energy consumption is an important consideration for wireless communication systems such as 5G [24]. The DC simulation indicates that the power consumption of our VCO circuit is very low, with a power of 111 mW maximum. Finally, to study the impact of the technology dispersion on the performance of the circuit proposed in this paper, we performed for a statistical "MONTE CARLO" analysis. Is shown in Figure 7 that for small variations of the circuit parameters, the output power varies slightly by a few decibels. In the worst case, the output power, of the fundamental harmonic, decreases to  $-3 \text{ dBm}$  while the rejection of the first and second harmonics remains higher than 21 dB and 16 dB respectively along the VCO frequency bandwidth and for the fifty iterations of the "MONTE CARLO" simulation.

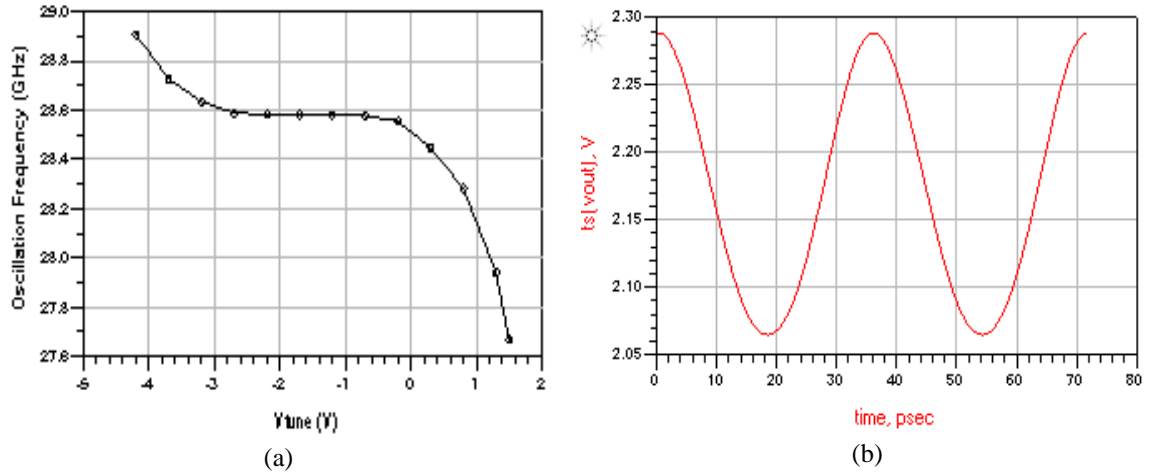

Figure 5. (a) Oscillation frequency versus Vtune and (b) time domain of the output signal for Vtune=1.3 V

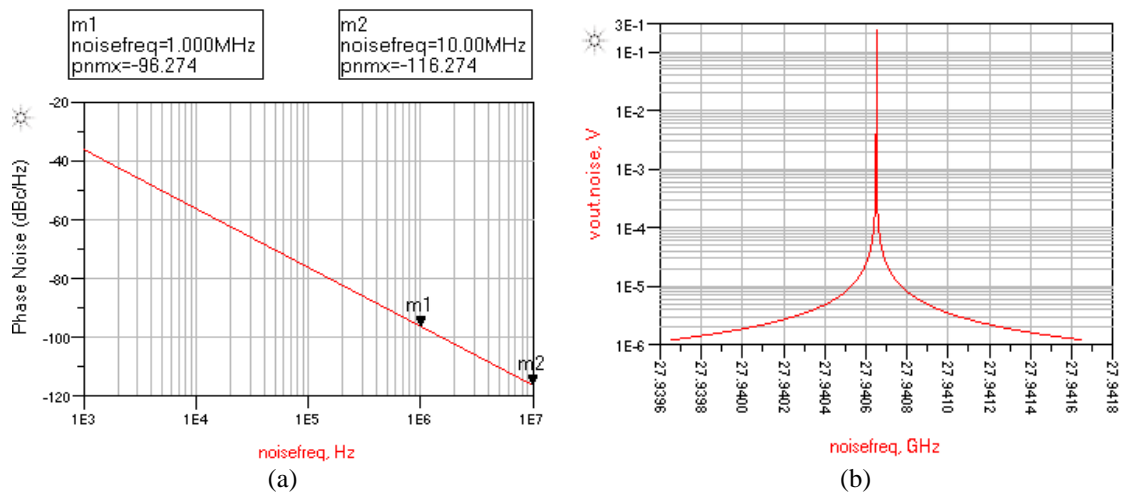

Figure 6. SSPN (a) and absolute noise spectrum, (b) for Vtune=1.3 V

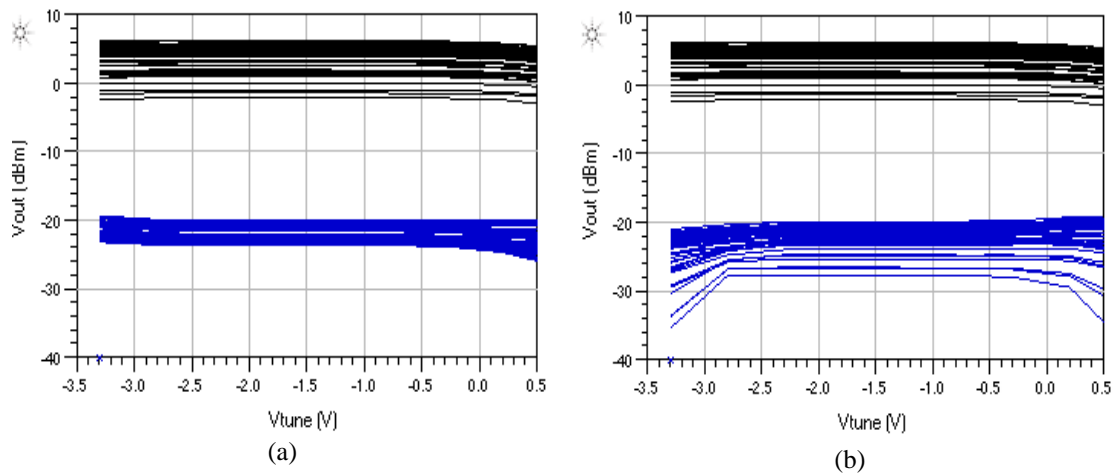

Figure 7. Monte carlo analysis: (a) the fundamental (black line) and the first harmonics (blue line), (b) the fundamental (black line) and the second harmonics (blue line)

#### 4. ANALYSIS AND DISCUSSIONS

VCO performances comparison depends on the intended application, while the oscillator specifications may vary from one application to another. But to get a general idea about the performance of an oscillator, designers use the Figure of Merit defined by the following equation [25, 26]:

$$\text{FoM} = L(f_0, \Delta f) + 10 \log(P_{\text{Consumption}}) - 20 \log\left(\frac{f_0}{\Delta f}\right) \quad (1)$$

where  $L(f_0, \Delta f)$  is the single sideband phase noise (SSPN) at  $\Delta f$  offset frequency,  $f_0$  is the oscillation frequency and, finally,  $P_{\text{Consumption}}$  is the DC power consumption of the circuit in mW.

In the Table 1, we have cited the performance of some voltage controlled oscillators, published in the literature. These oscillators operate in the mm-Wave frequency band and are dedicated to the wireless communication systems. We observe that the size of our circuit, designed using 0.25  $\mu\text{m}$  GaAs pHEMT, is very small compared to other pHEMT VCOs published in the literature, it also has an acceptable phase noise level and consumes a low electrical power.

Table 1. Performance of different VCOs

Ref.	Oscillation frequency (GHz)	Output power (dBm)	Phase noise (dBc/Hz) at 1 MHz	FoM (dBc/Hz)	Chip area (mm <sup>2</sup> )	Structure	Transistor
[8]	29.4	2.85	-98	-166.41	3.75	4 Colpitts VCO	0.13 $\mu\text{m}$ SiGe BiCMOS
[12]	27.7	9.75	-113.115	-181.06	0.515	Colpitts	0.15 $\mu\text{m}$ GaAs pHEMT
[14]	28	-	-93	-172	0.5	Differential VCO	0.13 $\mu\text{m}$ SiGe BiCMOS
[14]	38	-	-90	-171.7	0.5	Differential VCO	0.13 $\mu\text{m}$ SiGe BiCMOS
[15]	28.3	11.8	-102	-	0.5	Negative resistance	0.15 $\mu\text{m}$ GaAs pHEMT
[16]	28.2	1.63	-106.9	-155.78	-	Hartley	0.15 $\mu\text{m}$ GaAs pHEMT
This work	28.29	0	-96.274	-164.85	0.268	Colpitts	0.25 $\mu\text{m}$ GaAs pHEMT

#### 5. CONCLUSION

Provide a statement that what is expected, as stated in the "Introduction" chapter can ultimately result in "Results and Discussion" chapter, so there is compatibility. Moreover, it can also be added the prospect of the development of research results and application prospects of further studies into the next (based on result and discussion).

#### REFERENCES

- [1] J. G. Andrews, S. Buzzi, W. Choi, S. Hanly, A. Lozano, A. C. K. Soong, J. C. Zhang, "What Will 5G Be?," *IEEE Journal on Selected Areas in Communications*, vol. 32, no. 6, pp. 1065-1082, 2014.
- [2] Y. Niu, Y. Li D. Jin, L. Su, A. V. Vasilakos, "A survey of millimeter wave communications (mmWave) for 5G: opportunities and challenges," *Wireless Networks*, vol. 21, no. 8, pp. 2657-2676, 2015.
- [3] R. I. Bobby, K. Abdullah, A. Z. Jusoh, N. Parveen, and A. L. Asnawi, "A wireless precoding technique for millimetre-wave MIMO system based on SIC-MMSE," *TELKOMNIKA Telecommunication, Computing, Electronics and Control*, vol. 17, no. 6, pp. 2782-2789, 2019.
- [4] S. C. Bera, "Microwave Active Devices and Circuits for Communication," *Springer Lecture Notes in Electrical Engineering*, vol. 533, 2019.
- [5] A. Malki, L. E. Abdellaoui, J. Zbitou, A. Errkik, A. Tajmouati, and M. Latrach, "A Novel Design of Voltage Controlled Oscillator By using the Method of Negative Resistance," *International Journal of Electrical and Computer Engineering (IJECE)*, vol. 8, no. 6, pp. 4496-4504, 2018.
- [6] F. Herzel, G. Panic, J. Borngraber, and D. Kissinger, "An Integrated VCO with Frequency Tripler in SiGe BiCMOS with a 1-dB Bandwidth from 22 GHz to 32 GHz for Multiband 5G Wireless Networks," in *2019 12th German Microwave Conference (GeMiC)*, Stuttgart, Germany, 2019, pp. 99-102.
- [7] M. H. Kashani, R. Molavi, and S. Mirabbasi, "A 2.3-mW 26.3-GHz Gm-Boosted Differential Colpitts VCO With 20% Tuning Range in 65-nm CMOS," *IEEE Transactions on microwave theory and techniques*, vol. 67, no. 4, pp. 1556-1565, 2019.
- [8] G. Cheng, Z. Li, Z. Li, T. Han, M. Tian, "A 22-to-36.8 GHz low phase noise Colpitts VCO array in 0.13- $\mu\text{m}$  SiGe BiCMOS technology," *Microelectronics Journal*, vol. 88, pp. 79-87, 2019.
- [9] A. Siddique, T. S. Delwar, M. Kurbanov, and J. Y. Ryu, "Low-Power Low-Phase Noise VCO for 24 GHz Applications," *Microelectronics Journal*, vol. 97, pp. 1-23, 2020.
- [10] A. Es-saqy, M. Abata, M. Fattah, S. Mazer, M. Mehdi, M. El bekkali, "Study and Design of a MMIC Voltage Controlled Oscillator for 5G mm-wave band Applications," *International Journal of Advanced Trends in Computer Science and Engineering*, vol. 9, no. 2, pp. 2124-2129, 2020.

- [11] A. Es-Saqy, M. Abata, S. Mazer, M. Fattah, M. Mehdi, M. El Bekkali, C. Algani, "Very Low Phase Noise Voltage Controlled Oscillator for 5G mm-wave Communication Systems," *2020 1st International Conference on Innovative Research in Applied Science, Engineering and Technology (IRASET)*, Meknes, Morocco, 2020, pp. 1-4.
- [12] A. Es-Saqy, M. Abata, M. Mehdi, S. Mazer, M. Fattah, M. El Bekkali, C. Algani, "28 GHz Balanced pHEMT VCO with Low Phase Noise and High Output Power Performance for 5G mm-Wave Systems," *International Journal of Electrical and Computer Engineering (IJECE)*, vol. 10, no. 5, pp. 4623-4630, 2020.
- [13] L. Iotti, A. Mazzanti, and F. Svelto, "Insights Into Phase-Noise Scaling in Switch-Coupled Multi-Core LC VCOs for E-Band Adaptive Modulation Links," *IEEE Journal of Solid-State Circuits*, vol. 52, no. 7, pp. 1703-1718, 2017.
- [14] F. Ullah, Y. Liu, Z. Li, X. Wang, M. M. Sarfraz, and H. Zhang, "A Wideband Tunable Voltage Controlled Oscillator Supporting Non-harmonically-Related Multiple Frequency Bands for Future 5G Applications Using 0.13-um SiGe BiCMOS Technology," in *2018 IEEE 3rd International Conference on Integrated Circuits and Microsystems (ICICM)*, Shanghai, 2018, pp. 160-163.
- [15] B. Piernas, K. Nishikawa, T. Nakagawa, K. Araki, "A Compact and Low-Phase-Noise Ka-Band pHEMT-Based VCO," *IEEE Transactions On Microwave Theory And Techniques*, vol. 51, no. 3, pp. 778-783, 2003.
- [16] A. Es-Saqy, M. Abata, S. Mazer, I. Halkhams, M. Mehdi, and C. Algani, "Comparative Study Between Hartley and Colpitts VCO for 5G MM-Wave Band Applications," in *2019 7th Mediterranean Congress of Telecommunications (CMT)*, Fès, Morocco, 2019, pp. 1-4.
- [17] H. Hong, J. Jiang, X. Yuan, S. Ji, S. Keke, and G. Su, "A Low-Power High-Output-Efficiency Bipolar Colpitts VCO Using Base Inductive Feedback and Q-factor Enhancement for Analog Signal Acquisition," *IEICE Electronics Express*, vol. 17, no. 7, pp. 1-6, 2020.
- [18] R. Z. Nanfa'a, R. Tchitnga, P. H. Louodop Fotso, R. Kengne, F. C. Talla, B. Nana, F. B. Pelap, "Non periodic oscillations, bistability, coexistence of chaos and hyperchaos in the simplest resistorless Op-Amp based Colpitts oscillator," *Heliyon*, vol. 6, no. 2, pp. 1-12, 2020.
- [19] Y. Wen, S. Xiaowei, Q. Rong, Z. Yimen, "26GHz pHEMT VCO MMIC," *Microwave and Optical Technology Letters*, vol. 44, no. 6, pp. 550-552, 2005.
- [20] M. Ribate, R. Mandry, J. Zbitou, L. El Abdellaoui, A. Errkik, M. Latrach, "1.25GHz-3.3GHz broadband solid-state power amplifier for L and S bands applications," *International Journal of Electrical and Computer Engineering (IJECE)*, vol. 9, no. 5, pp. 3633-3641, 2019.
- [21] A. Hajimiri, T. H. LEE, "A General Theory of Phase Noise in Electrical Oscillators," *IEEE Journal of Solid-State Circuits*, vol. 33, no. 2, pp. 179-194, 1998.
- [22] Ulrich L. Rohde and Matthias Rudolph, "RF/Microwave Circuit Design for Wireless Applications," *John Wiley Sons*, pp. 716-847, 2013.
- [23] R. O. Ibrahim, S. M. Abd El-Azeem, S. M. El-Ghanam, and F. A. S. Soliman, "Studying the operation of MOSFET RC-phase shift oscillator under different environmental conditions," *Nuclear Engineering and Technology*, vol. 52, no. 8, pp. 1764-1770, 2020.
- [24] A. F. Hasan, S. A. Z. Murad, F. A. Bakar, and T. Z. A. Zulkifli, "A 28GHz high efficiency fully integrated 0.18  $\mu\text{m}$  combined CMOS power amplifier using power divider technique for 5G millimeter-wave applications," *Bulletin of Electrical Engineering and Informatics*, vol. 9, no. 2, pp. 644-651, 2020.
- [25] X. Wang, X.-W. Zhu, C. Yu, and W. Hong, "Compact and Low-Phase-Noise Oscillator Employing Multilayer Sixteenth-Mode Substrate-Integrated Waveguide Filter for 5G Applications," *IEEE Transactions on Components, Packaging and Manufacturing Technology*, vol. 9, no. 9, pp. 1863-1871, 2019.
- [26] M. A. Shehata, M. Keaveney, and R. B. Staszewski, "A 184.6dBc/Hz FoM 100kHz Flicker Phase Noise Corner 30-GHz Rotary Traveling-Wave Oscillator Using Distributed Stubs in 22nm FD-SOI," *IEEE Solid-State Circuits Letters*, vol. 2, no. 9, pp. 103-106, 2019.

## BIOGRAPHIES OF AUTHORS



**Abdelhafid Es-saqy**, was born in TISSA, Morocco, in January 1992. Received his Master degree in Microelectronics from faculty of sciences Dhar EL Mahraz Fez Morocco, in 2018. He is now Ph.D. student in Artificial Intelligence, Data Sciences and Emerging Systems Laboratory at the University of Sidi Mohamed Ben Abdellah Fez. His main research interest includes Mixers and Local Oscillators.



**Maryam Abata**, born in 1989 in Nador, Morocco, obtained Master's degree in 2012 at the National School of Applied Sciences. She received the Ph.D. in Telecommunications and Micro-waves devices from Sidi Mohamed Ben Abdellah University of Fez.



**Mahmoud Mehdi** was born in Beirut, Lebanon, in 1974. He received his Ph.D. in high frequency communication systems from the university of Paris Marne la Vallée, France 2005. He is an associate professor in the Physics Department of the Faculty of sciences at the Lebanese University, Beirut, Lebanon. His research interests include Monolithic Microwave Integrated Circuits (MMIC), Micro-Electro-Mechanical Systems (MEMS), Radiofrequency, Double Balanced and Distributed Mixers, Local Oscillator, TW Amplifiers, Optoelectronic Mixer for LIDAR system, Optical systems and design, and Photo-detectors. He is course leader in microwave devices for the Masters program in Electronics.



**Mohammed Fattah** received his Ph.D. in Telecommunications and CEM at the University of Sidi Mohamed Ben Abdellah (USMBA) Fez, Morocco, 2011. He is a professor in the Electrical Engineering Department of the High school of technology at the Moulay Ismail University (UMI), Meknes, Morocco and he is a responsible of the research team 'Intelligent Systems, Networks and Telecommunications', IMAGE laboratory, UMI



**Said Mazer**, born in 1978. He received the Ph.D. degree in electronics and signal processing from the University of Marne-La-Vallée, Champs-surMarne, France. He is currently a full Professor with the National School of Applied Sciences of Fez, Morocco. He is member of IASSE Laboratory, University of Sidi Mohamed Ben Abdellah Fez. His research interests include the development of microwave-photonics devices for radio-over fibre and wireless applications and he is also involved in network security.



**Moulhime El Bekkali**, holder of a doctorate in 1991 from the USTL University - Lille 1- France, he worked on antennas printed in X-band and their applications to microwave radar. Since 1992, he was a professor at the Graduate School of Technology, Fez (ESTF) and he was a member of the Transmission and Data Processing Laboratory (LTTI). In 1999, he received a second doctorate in electromagnetic compatibility from Sidi Mohamed Ben Abdellah University (USMBA). Since 2009, Pr. El Bekkali has been Vice-President of Research and Cooperation at the Sidi Mohamed Ben Abdellah University (USMBA) in Fez-Morocco until 2018. Currently, he is a professor at the National School of Applied Sciences (ENSAF) and member of the LIASSE laboratory at Sidi Mohamed Ben Abdellah University.



**Catherine Algani**, born in 1963. PhD in electronics at the University Pierre and Marie Curie (Paris VI). University professor at the National Conservatory of Arts and Crafts, CNAM-Paris. She is the responsible of the research team "communication systems" at ESYCOM laboratory.