

## A boot-strap estimator for joint flux and parameters online identification for vector controlled induction motor drives

Vicente Leite <sup>(1)</sup>, Rui Araújo <sup>(2)</sup>, Diamantino Freitas <sup>(3)</sup>

<sup>(1)</sup> INSTITUTO POLITÉCNICO DE BRAGANÇA - ESCOLA SUPERIOR DE  
TECNOLOGIA E DE GESTÃO

Campus de Sta. Apolónia - Apartado 134, 5301-857

Bragança, Portugal

Telephone n.º: 351-273-303158, fax n.º: 351-273-313051

avtl@ipb.pt

<sup>(2), (3)</sup> FACULDADE DE ENGENHARIA DA UNIVERSIDADE DO PORTO

Rua Dr. Roberto Frias s/n, 4200-465 Porto

Porto, Portugal

Telephone n.º: <sup>2)</sup> 351-22-5081808, <sup>3)</sup> 351-22-5081837; fax n.º: <sup>2,3)</sup> 351-22-5081443

<sup>(2)</sup> raraujo@fe.up.pt, <sup>(3)</sup> dfreitas@fe.up.pt

### Keywords

Induction motors, estimation techniques, variable speed drives, adaptive control.

### Abstract

This paper presents a new approach for joint rotor flux and electrical parameters on-line identification in vector controlled high-performance induction motor drives based on a boot-strap estimator that uses a reduced order extended Kalman filter for rotor flux components and rotor parameters estimation and a recursive prediction error method for stator parameters estimation. Within the prediction error method some approaches are used and compared that affect both the adaptation gain and the direction in which the updates of stator parameters are made. The induction motor model structures are described in the rotor reference frame in order to reduce the computational effort by using a higher sampling time interval.

### Introduction

In recent years, the availability of digital signal processors and the fast development of modern power electronics have contributed for the wide acceptance of the prevailing vector control in high-performance induction motor (IM) drives, and have made the correct estimation of rotor flux and system adaptation to the changing motor parameters feasible, which are the two major problems in the implementation of such industrial applications as referred in [1].

In the recent past, the estimation of the electrical parameters of the IM has been achieved by using, normally, a recursive least squares method approach based on a linear model structure usually obtained from the classical IM model, expressed in its  $dq$  components, by elimination of fluxes and rotor currents and furthermore, the flux was estimated separately from the parameters. Moreover, to do that the rotor speed should also be constant or slowly varying as, for instance, in [2]. As a result, this kind of linear models is not suitable for transient conditions and furthermore, they typically need the computation of the first derivative of the stator voltage besides the first and second derivatives of the stator current. On the other hand, the online simultaneous estimation of the main electrical parameters in steady-state, under normal operating conditions, is not feasible due to the lack of persistent excitation provided by the signals.

The recent trend is to implement a solution with joint online estimation of IM states and parameters as in [1] and [3-6]. However, the simultaneous estimation of both rotor flux components and all electrical parameters of a vector controlled induction motor, under normal operating conditions, for real-time applications, still remains a challenge. This work is a contribution for this purpose and uses the

extended Kalman filter (EKF) which is suitable for both steady-state and transient conditions and performs the joint state and parameter estimation of the nonlinear state-space model structure describing the IM. The main goal here is to achieve the estimation of flux and electrical parameters in real-time operation, with low computational effort, under normal operating conditions, and with an independent estimator for stator parameters based on a recursive prediction error method (RPEM). The objective is to adjust the identification procedure to the dynamic conditions of the machine, namely the stator parameters which can not be correctly estimated under steady-state conditions as shown in [5, 6]. With the boot-strap estimator presented in this paper the stator parameters can be separately estimated or updated whenever the dynamic conditions are suitable for this purpose. Some approaches are used and compared that affect both the adaptation gain and the direction in which the updates of stator parameters are made, within the RPEM, namely the Kalman filter, forgetting factor (recursive least squares), unnormalized gradient and normalized gradient approaches described in [7] and [8].

## Induction Motor Model

In the previous works [5, 6], the authors have shown that the joint estimation of rotor flux components and all the electrical parameters of a per-phase squirrel cage IM model described by the four parameters in [9], is feasible in real-time applications by using an EKF technique, with reduction of computational effort, based on a reduced order model in the rotor reference frame as shown below:

$$\begin{bmatrix} \dot{\Psi}_{rd}^r \\ \dot{\Psi}_{rq}^r \end{bmatrix} = \begin{bmatrix} -\tau_r^{-1} & 0 \\ 0 & -\tau_r^{-1} \end{bmatrix} \begin{bmatrix} \Psi_{rd}^r \\ \Psi_{rq}^r \end{bmatrix} + \begin{bmatrix} L_M \tau_r^{-1} & 0 \\ 0 & L_M \tau_r^{-1} \end{bmatrix} \begin{bmatrix} i_{sd}^r \\ i_{sq}^r \end{bmatrix} \quad (1)$$

$$u_{sd}^r(t) = -\tau_r^{-1} \Psi_{rd}^r(t) - \omega(t) \Psi_{rq}^r(t) + (R_s + L_M \tau_r^{-1}) i_{sd}^r(t) + L_s' (\dot{i}_{sd}^r - \omega(t) i_{sq}^r(t)) \quad (2)$$

Where:  $\Psi_{rd}^r(t) = \frac{L_m}{L_r} \phi_{rd}^r(t)$ ,  $\Psi_{rq}^r(t) = \frac{L_m}{L_r} \phi_{rq}^r(t)$ ,  $\tau_r = \frac{L_r}{R_r}$ ,  $L_s' = L_s - \frac{L_m^2}{L_r}$ , and  $L_M = \frac{L_m^2}{L_r}$

The simultaneous estimation of the four parameters requires some dynamic conditions for a correct identification of stator parameters [5, 6], namely,  $R_s$  and  $L_s'$ . In any case the estimation of these parameters remains hard, wherefore a new procedure is presented in the next section. Oppositely, the other two motor parameters,  $\tau_r$  and  $L_M$ , can be estimated whether in transient conditions or in steady state operation with a good robustness with respect to errors in the stator parameters [5]. According to this fact, a boot-strap estimator is proposed that enables the estimation of all parameters but separates the estimation of  $\tau_r$ ,  $L_M$  and the rotor flux components from the stator parameters. The state-space model structure formed by both equations in (1) and (2), respectively, the state and output equations, is used within the EKF algorithm for joint estimation of rotor parameters and rotor flux components, and a linear model is derived just from (2) as shown in the next section.

## The Boot-Strap Estimator

The proposed estimator consists of a first estimator that uses the EKF to find good estimates of the rotor parameters,  $\tau_r$  and  $L_M$ , and the two rotor flux components, followed by a recursive prediction error based estimator to obtain the remaining stator resistance,  $R_s$ , and stator transient inductance,  $L_s'$ , in a boot-strap manner. Thus, considering a specific instant,  $t_k$ , the EKF is used for estimation of the extended and scaled state vector  $\hat{x}$ , based on previous estimated values of stator parameters and then, a RPEM is used to estimate the parameter vector  $\hat{\theta}$ , which contains the other two parameters,  $R_s$  and  $L_s'$ . The state vector  $x$  and the parameter vector  $\theta$  are scaled by constants  $K_i$ 's, for numerical reasons, as follows:

$$\hat{x}(k, \hat{\theta}_{t_{k-1}}) = \begin{bmatrix} k_1 \Psi_{rd}^r(k) & k_2 \Psi_{rq}^r(k) & k_3 \tau^{-1}(k) & k_4 L_M(k) \end{bmatrix} = [\hat{x}_1(k) \quad \hat{x}_2(k) \quad \hat{x}_3(k) \quad \hat{x}_4(k)], \quad (3)$$

$$\widehat{\theta}(k) = \begin{bmatrix} k_5 R_s(k) & k_6 L'_s(k) \end{bmatrix} = \begin{bmatrix} \widehat{\theta}_1(k) & \widehat{\theta}_2(k) \end{bmatrix}. \quad (4)$$

For the EKF algorithm, the model structure is formed by a nonlinear discrete state-space 4<sup>th</sup>-order model obtained by discretization of state equation in (1) and the output equation in (2), as presented in [6], resulting the following time-discrete state-space model, where  $T_s$  is the sampling period:

$$\begin{bmatrix} \psi_{rd}^r(k+1) \\ \psi_{rq}^r(k+1) \end{bmatrix} = \begin{bmatrix} -T_s \tau_r^{-1} & 0 \\ 0 & -T_s \tau_r^{-1} \end{bmatrix} \begin{bmatrix} \psi_{rd}^r(k) \\ \psi_{rq}^r(k) \end{bmatrix} + \begin{bmatrix} T_s L_M \tau_r^{-1} & 0 \\ 0 & T_s L_M \tau_r^{-1} \end{bmatrix} \begin{bmatrix} i_{sd}^r(k) \\ i_{sq}^r(k) \end{bmatrix}, \quad (5)$$

$$u_{sd}^r(k) - \widehat{R}_s i_{sd}^r(k) - \widehat{L}'_s (\dot{i}_{sd}^r(t_k) - \omega(k) i_{sq}^r(k)) = -\tau_r^{-1} \psi_{rd}^r(k) - \omega(k) \psi_{rq}^r(k) + L_M \tau_r^{-1} i_{sd}^r(k). \quad (6)$$

As we can see, the state equation in(5) is independent of rotor speed and stator parameters. Moreover, the matrices are diagonal and, therefore, it becomes very simple to get higher order approximation in the discretization process. The rotor speed and stator parameters only appear in the output equation in (6) where the measured output is function of the stator parameters which are estimated by using the model structure described bellow. It should be noticed that this particularity happens only in the rotor reference frame. For the recursive prediction error based method, a linear regression model structure is used, which is derived from (2), taking into account that:

$$\dot{\psi}_{rd}^r = -\tau_r^{-1} \psi_{rd}^r + L_M \tau_r^{-1} i_{sd}^r. \quad (7)$$

Then we can write the linear regression model from (2) and (7) as follows:

$$u_{sd}^r(k) + \omega(k) \widehat{\psi}_{rq}^r(k) - \dot{\psi}_{rd}^r(k) = R_s(k) i_{sd}^r(k) + L'_s(k) (\dot{i}_{sd}^r(t_k) - \omega(k) i_{sq}^r(k)). \quad (8)$$

The equation above can then be rewritten using the general linear regression expression,

$$y(k, \widehat{x}) = \theta(k) u(k), \quad (9)$$

where:

$$y(k, \widehat{x}) = u_{sd}^r(k) + \omega(k) \widehat{\psi}_{rq}^r(k) - \dot{\psi}_{rd}^r(k), \text{ and} \quad (10)$$

$$\widehat{y}(k, \theta) = \theta(k) u(k) = \theta_1(k) u_1(k) + \theta_2(k) u_2(k) = R_s(k) i_{sd}^r(k) + L'_s(k) (\dot{i}_{sd}^r(t_k) - \omega(k) i_{sq}^r(k)). \quad (11)$$

Obviously, instead of the  $d$  equation described by (8) the  $q$  one could be selected but only one of them is needed. As we can verify the linear regression resulting from (10) and (11), described as a linear regression like in (9), does not depend on rotor parameters. However, it depends on rotor flux  $d$  (or  $q$ ) component first derivative but the “noise” in the flux, estimated by the EKF, can be tunable and even made negligible and no problems come from computing its derivative. The first derivatives in (10) and (11) are computed by the following general recursive filter in order to obtain better results than by using Euler’s formula,

$$\dot{x} = dx/dt|_{t=t_k} \approx \frac{1}{T_s} \sum_{i=0}^{n-1} C_i x(t_k - iT_s) \quad (12)$$

The weights  $C_i$  can be found in [10] which are determined after Taylor series expansion of the equation above to  $m+1$  terms, with  $m = \{1, 2, \dots, n\}$ ,  $m$  being the order of the filter and  $n$  the number of points. For system identification purposes, as in this case, an important aspect to have in account is the delay introduced by the filter. The delay must be the same as the one introduced by the Euler’s formula that is implicit in the discretization process of state equation in (1) if the linear terns of the Taylor’s development is adopted as in (5). For sampling frequencies lower than 5kHz, the set of coefficients  $[11 \ -18 \ 9 \ -2]/6$ , has produced the best results. This is an unusual discretization process. Indeed, this strategy presented by the authors in [5, 6] has proven to give better results when compared with the usual linear terms-based discretization of the full order state-space model and only after this the reduced order model formed by (5) and (6) is derived. Following this strategy, high order approximations can be easily used also in the discretization of (1) since its matrices are diagonal.

The proposed boot-strap estimator is similar to an adaptive state estimator for nonlinear systems described, in general terms, in [8] and applied here for joint state and parameter estimation. The set-up in fig. 1 is a very natural and simple way to achieve this objective. Besides the advantage of separating the estimation of  $\tau_r$ ,  $L_M$  and the rotor flux components from the stator parameters, by adapting the global estimator to the machine operating point or, in other words, to the information contained in the measured signals, it permits to overcome some of the disadvantages associated with the EKF, namely, a strong computational effort, eventually biased estimates, and not guaranteed convergence [8]. Furthermore, this can be a good alternative to the extended Luenberger observer suggested in [1] to solve the steady-state bias problem detected in the joint rotor flux and rotor time constant estimation, and an alternative to [3, 4], in terms of computational effort.

As far as the induction motor is concerned the main advantage of the boot-strap estimator is the autonomy between the simultaneous estimation of rotor flux components and rotor parameters by using the EKF and, on the other hand, the estimation of stator parameters by using a RPEM based approach for joint estimation of stator parameters as represented in fig. 2(a) or even two RPEMs for independent estimation of these two parameters as in fig. 2(b). The independence of the two or three algorithms, as represented in fig. 2(a) and (b), respectively, is really very important since the operating conditions of the induction motor required for a successful simultaneous estimation of all electrical parameters, are quite different for the four parameters.

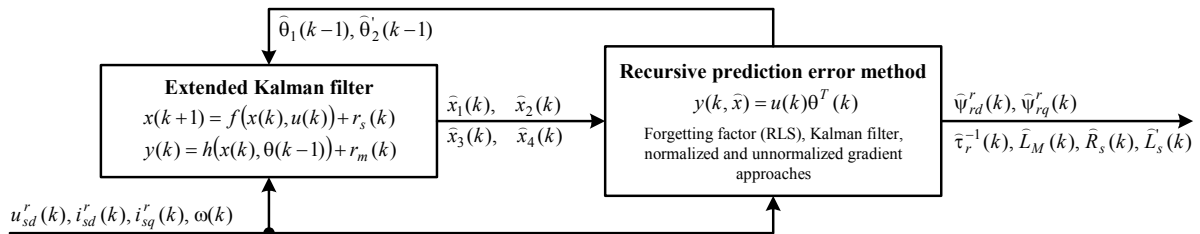

Figure 1: Boot-strap estimator with the model structures described in the rotor reference frame.

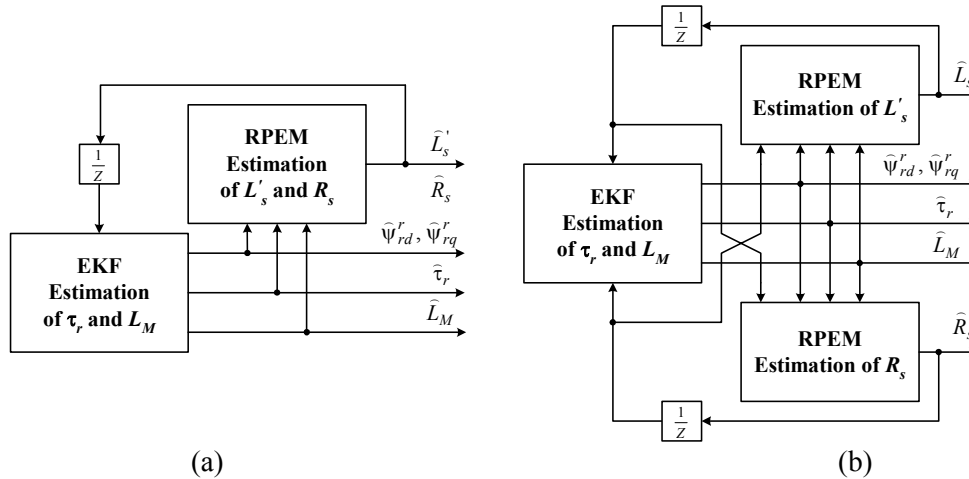

Figure 2: The both possibilities for stator parameters estimation using the boot-strap estimator.

In [5, 6] the authors have shown that both rotor parameters ( $\tau_r$  and  $L_M$ ) are well estimated even in steady-state operation and, due to this, they are proposed to be estimated together with rotor flux components in every iteration. Furthermore, stator transient inductance needs significant dynamic conditions which are different from the ones needed for stator resistance estimation.

By using the proposed boot-strap estimator, the estimation of stator parameters can be separated from flux and rotor parameters and can be enabled or disabled according to the dynamic conditions of the induction motor and this is very important to do and even mandatory. Moreover, the EKF based algorithm that estimates rotor flux and rotor parameters can update, at every iteration, the values of

stator parameters in its output equation, from time to time, or only when they are properly available by the respective RPEM algorithms since these can not be, necessarily, always working. Figures 1 and 2 represent the described identification procedure.

The recursive prediction error method, which is well described in the specialized literature like in [7, 8], can be summarized as follows where  $\psi(k+1)$  represents the gradient of the predicted output,  $\hat{y}$ , with respect to the parameter vector,  $\theta$  :

$$1. \psi(k+1) = \left. \frac{\partial \hat{y}(k, \theta)}{\partial \theta} \right|_{\theta = \hat{\theta}(k)} \quad (13a)$$

$$2. L(k+1) = P(k)\psi(k+1) \left[ \psi^T(k+1)P(k)\psi(k+1) + R_m \right]^{-1} \quad (13b)$$

$$3. \hat{\theta}(k+1) = \hat{\theta}(k) + L(k+1)(y(k+1) - \hat{y}(k+1)) \quad (13c)$$

$$4. P(k+1) = P(k) - L(k+1)\psi^T(k+1)P(k) + R_s \quad (13d)$$

5. Go to 1

The gain matrix  $L(k)$  that affects both the adaptation gain and the direction in which the updates of stator parameters are made, can be chosen following several approaches as referred in [7]. The results of the application of the Kalman filter, forgetting factor (recursive least squares), unnormalized gradient and normalized gradient approaches are presented and compared in the next section. The authors, in [11], have presented a similar methodology but with a different model structure for the stator parameters estimation which is performed in the stator reference frame, the sampling frequency being naturally higher.

## Simulation Results

The above-proposed boot-strap estimator has been developed in the *MATLAB* with *Simulink* environment and tested under a vector control scheme. Simulation conditions were selected to be as close as possible of the experimental ones. All simulation and experimental results shown in this paper were obtained with the configuration of fig. 2(a) and a square wave speed reference in the range of  $\pm 600$  rpm, in order to ensure persistent enough excitation of the stator transient inductance from the transient conditions.

Figure 3(a), below, shows the first 8 seconds of the rotor speed of a 2.2kW vector controlled induction motor which corresponds to the response to a square speed reference and fig. 3(b) shows the voltage and current  $d$  components in the rotor reference frame.

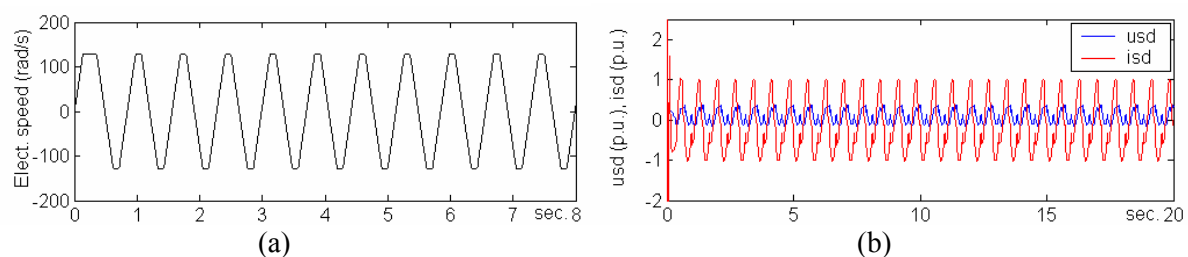

Figure 3: Simulated signals. (a) Electrical rotor speed generated by the vector control scheme (rad/s) and (b) stator voltage and current  $d$  components in the rotor reference frame (p.u.).

One of the main difficulties of any full parameter and flux estimator is the start-up procedure when no information is available beforehand about the electrical parameters. It is even not possible to do it, since we search for too much information as fluxes and parameters, based on just stator signals and rotor speed and, on the other hand, the model sensibility in relation to the stator parameters is low and strongly dependent of the dynamic conditions during the start-up and immediately after. Due to this, the authors devised a robust solution that is presented here. It is only supposed to have rough initial values of the electrical parameters for scaling the state vector  $x$  in (3) and parameter vector  $\theta$  in (4).

Many solutions can be used for this purpose. Some of them are very simple like the classical methods or other rough parameter estimations as in [3], based on nominal characteristics of the induction motor.

Within the boot-strap estimator itself, the only requirement with respect to initial values of the electrical parameters is related to the initialization of stator parameters. Since in full estimation the rotor flux components are jointly estimated with the electrical parameters, both algorithms hardly converge to correct values because of the lack of confidence in estimated flux components at the beginning and, on the other hand, the lack of sensibility of the induction motor model with respect to stator parameters without specific supply conditions. By this way, the EKF is started without any assumed knowledge of rotor parameters, but with initial seeds for stator parameters which are very simple to obtain in the case of stator resistance. Thus, 1 second after the EKF has been started, when the rotor parameters and flux are supposed to be close to its expected values, the RPEM algorithm(s) is(are) started with the rough estimates or even zero values, as used in the present paper, in the parameter vector  $\theta$ . One second later all parameters and flux components are supposed to be converging to their real values and the algorithms start working according to the proposed boot-strap manner. This start-up procedure has demonstrated to be much more robust when compared to the simultaneous starting of the estimation of all parameters and flux components. Another advantage is that it avoids convergence to wrong estimated parameters values even when fitting properly the estimated flux and simulated currents using the estimated parameters. Figure 4 shows the performance of the proposed boot-strap estimator for different initial seeds of stator parameters, used by the EKF.

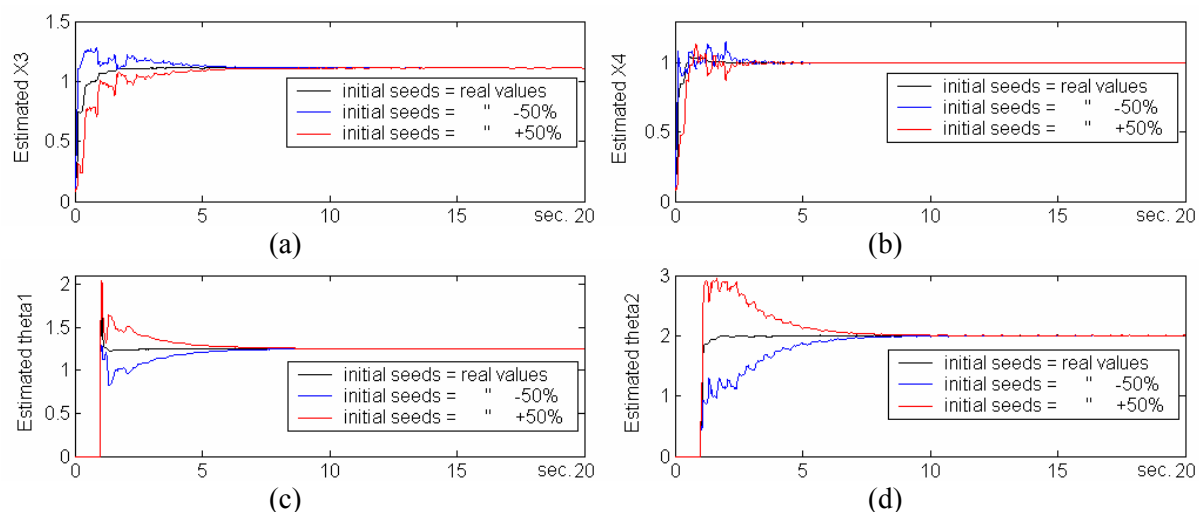

Figure 4: Performance of the proposed boot-strap estimator for different initial seeds of stator parameters used by the EKF. (a) estimated state  $x_3$  - inverse of scaled rotor time constant, (b) estimated state  $x_4$  - scaled magnetizing inductance, (c) estimated parameter  $\theta_1$  - scaled stator transient inductance, (d) estimated parameter  $\theta_2$  - scaled stator resistance.

These results prove the robustness of the proposed boot-strap estimator with respect to initial seeds of stator parameters in the EKF based algorithm, where three runs were performed with different initial seeds: In the first one the initial seeds were made equal to the parameters' real values and in the second and third ones they were made equal to 50% below and above of the real values, respectively.

The initial values used in the algorithms are now presented. For the EKF, the initial state, the state covariance matrix and the system and measurement noise covariance matrices were, respectively:

$$\begin{aligned}
 x(0) &= [0 \quad 0 \quad 0.1 \quad 0.1] \\
 P(0) &= \text{diag}[1e-5 \quad 1e-5 \quad 1e-5 \quad 1e-5] \\
 R_s &= \text{diag}[1e-8 \quad 1e-8 \quad 1e-8 \quad 1e-8] \\
 R_m &= 10
 \end{aligned}$$

The different approaches of the RPEM algorithm were initialized as follows:

*Kf* approach:

$$\begin{aligned}\theta(0) &= [0 \ 0] \\ P_{\theta}(0) &= \text{diag}[1e-3 \ 1e-3] \\ R_{s,\theta} &= \text{diag}[1e-9 \ 1e-7 + 1e-9e^{-t/8}] \\ R_{m,\theta} &= 1\end{aligned}$$

*ff* approach:

$$\begin{aligned}\theta(0) &= [0 \ 0] \\ P_{\theta}(0) &= \text{diag}[1e-3 \ 1e-3] \\ R_{s,\theta} &= 0 \\ R_{m,\theta} &= 0.95\end{aligned}$$

*un* approach:

$$\begin{aligned}\theta(0) &= [0 \ 0] \\ P_{\theta}(0) &= \text{diag}[1e-3 \ 1e-3] \\ L(t) &= (1e-5 + 5e-5e^{-t/8}) \times \psi(t)\end{aligned}$$

*ng* approach:

$$\begin{aligned}\theta(0) &= [0 \ 0] \\ P_{\theta}(0) &= \text{diag}[1e-3 \ 1e-3] \\ L(t) &= (1e-3 + 5e-3e^{-t/8}) \times \frac{\psi(t)}{\|\psi(t)\|^2}\end{aligned}$$

Where *kf*, *ff*, *ug*, *ng*, mean, respectively, Kalman filter, forgetting factor, unnormalized gradient and normalized gradient approaches. The exponential initialization of some matrices above serves to improve the rate of convergence of the respective parameters.

The scaling factors  $k_1$  to  $k_6$  used in (3) and (4) were, respectively, 1, 1, 0.2, 5, 0.5 and 100. Figure 5 shows the performance of the proposed boot-strap estimator for the different recursive prediction error based approaches. The initial seeds for stator parameters were its real values minus 50% and as we can see all approaches have a good performance with exception of the forgetting factor approach since its convergence time is too long.

The errors in all estimated parameters are less than 2%, excepting the ones obtained with the forgetting factor approach, and the simulated stator current matches the “measured” one (generated by the vector control scheme) using the online estimated parameters, as can be seen in fig. 6(a). Also the estimated flux waveform very closely matches the simulated one as shown in fig. 6(b).

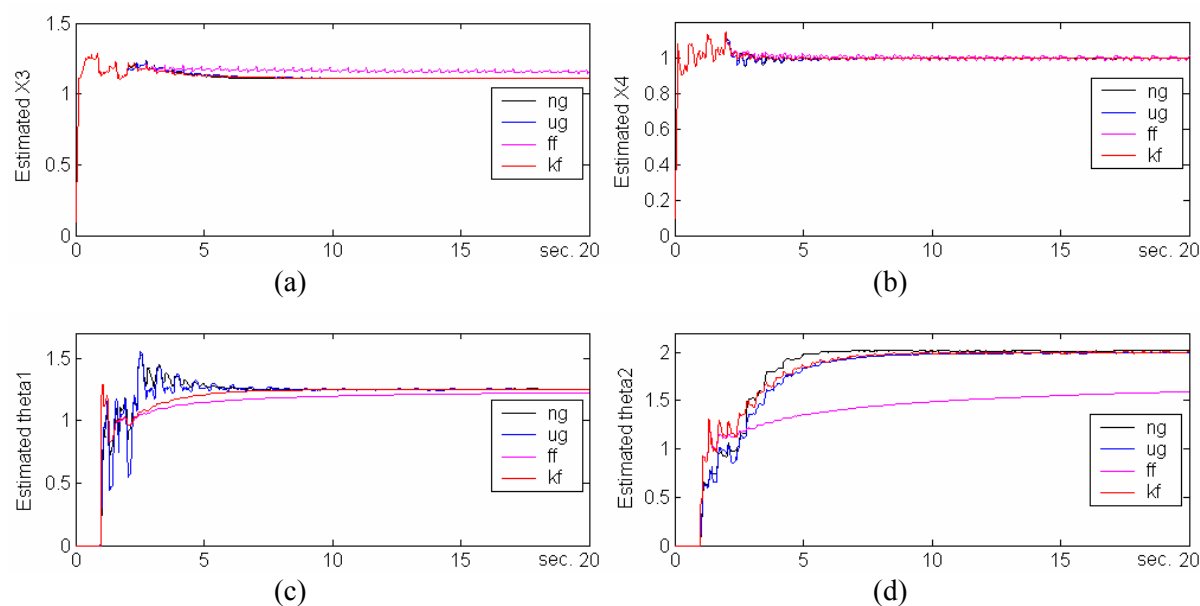

Figure 5: Performance of the proposed boot-strap estimator for the different recursive prediction error based approaches. Initial seeds:  $R_s(0)=R_s-50\%$  and  $L_s'(0)=L_s'-50\%$ . In the legend *ng*, *ug*, *ff*, *kf* have the same meaning above described. (a) to (d) as in previous figure.

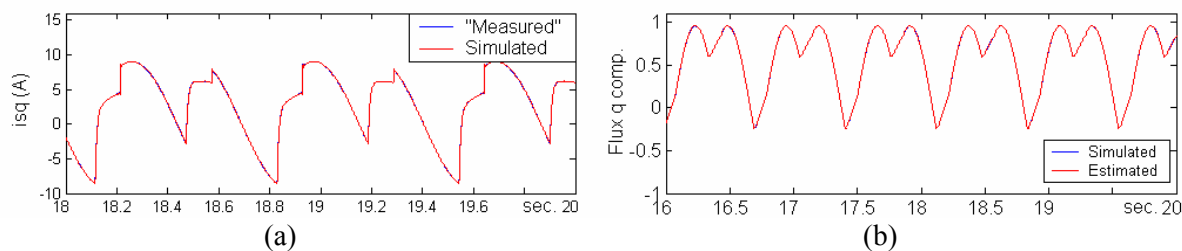

Figure 6: Performance of the proposed boot-strap estimator – validation of the estimated states and parameters. (a) generated stator current  $q$  component and the simulated one using the online estimated parameters and (b) simulated/generated and estimated rotor flux  $q$  component. All signals are in the rotor reference frame.

## Experimental Results

A practical experiment has been selected to demonstrate and validate the identification procedure. The experimental results have proven the feasibility and applicability of the boot-strap estimator presented in previous sections.

In this experiment the rotor-referred stator voltages, stator currents and angular speed were sampled at 2kHz. Elliptic fifth-order low-pass pre-filters with a 500Hz cutoff frequency have been used. Specific hardware was developed that has the signals available in the range of  $\pm 10V$  in both rotor and stator reference frames, by using the *AD2S100* analogue vector processor but only the stator-referred signals are used for this work.

The stator voltages and currents are acquired in the stator reference frame with a data acquisition system that consists of the *dSPACE* development system, *ACE Kit 1103*, based on the *DS1103 PPC* controller board, the *Real-Time Interface (RTI)* blockset for *Simulink* as well as experiment software (*ControlDesk*, *MLIB/MTRACE*). The stator-referred signals are then converted into the rotor reference frame, as shown in fig. 7(a), using the rotor position which is obtained via an incremental encoder and from which is computed the rotor speed shown in fig. 7(b). The *dSPACE* development platform was used for the real-time identification task and not for control.

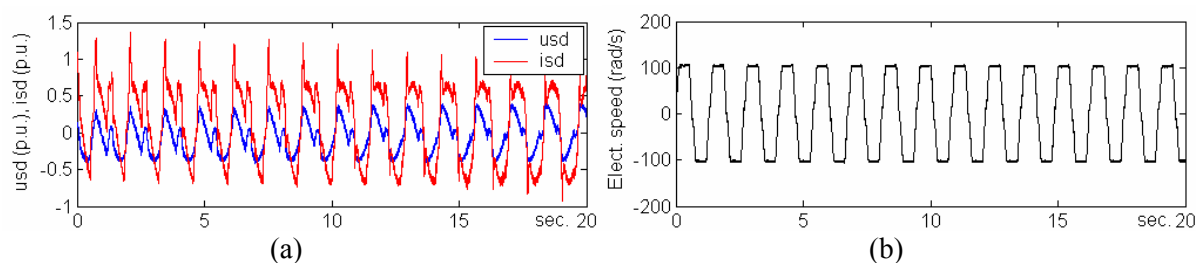

Fig.7: Measured signals. (a) Stator voltage and current  $d$  components in the rotor reference frame (p.u.) and (b) electrical rotor speed (rad/s).

Digital filters, with the same specifications as the analog ones, were used for filtering the computed rotor speed from rotor angle as well as electrical signals after being acquired. Unfortunately, both filters introduce delays. In order to synchronize all the signals, the rotor angle and filtered speed had to be suitably delayed.

A 2.2KW induction motor controlled by an industrial frequency converter from *ABB* has been used. The motor was loaded by a powder break which was programmed for 12Nm, about half of the nominal torque.

The vector control scheme developed by us in *Simulink* and used for simulation experiments and the one implemented by *ABB* are naturally different. On the other hand, the electrical parameters are not constants anymore. By tuning the system and noise covariance matrices diagonal values, the gains in the identification algorithms are adjusted in order to tract the respective electrical parameters



following close the instantaneous variations of the real parameters, or instead, tracking its mean values over the time. Therefore some non-similarities exist between the generated signals in Simulink and the ones generated by the *ABB* frequency converter and, consequently, the evolutions of the estimated parameters in these two phases of the work are a little bit different mainly visible in real-time monitoring.

The experimental results, presented in fig. 8, show the performance of the estimation of rotor flux components and rotor parameters by using the EKF and stator parameters estimation by using the recursive prediction error based on Kalman filter approach.

In order to guarantee the validity of the boot-strap methodology it is necessary to validate the identified induction motor model through some validation test to evaluate the performance of the algorithms. The validation test was based on the simulation of a modified induction motor model, with the online estimated parameters, by injection of the measured voltages and angular speed and subsequent comparison of simulated and measured stator current  $dq$  components.

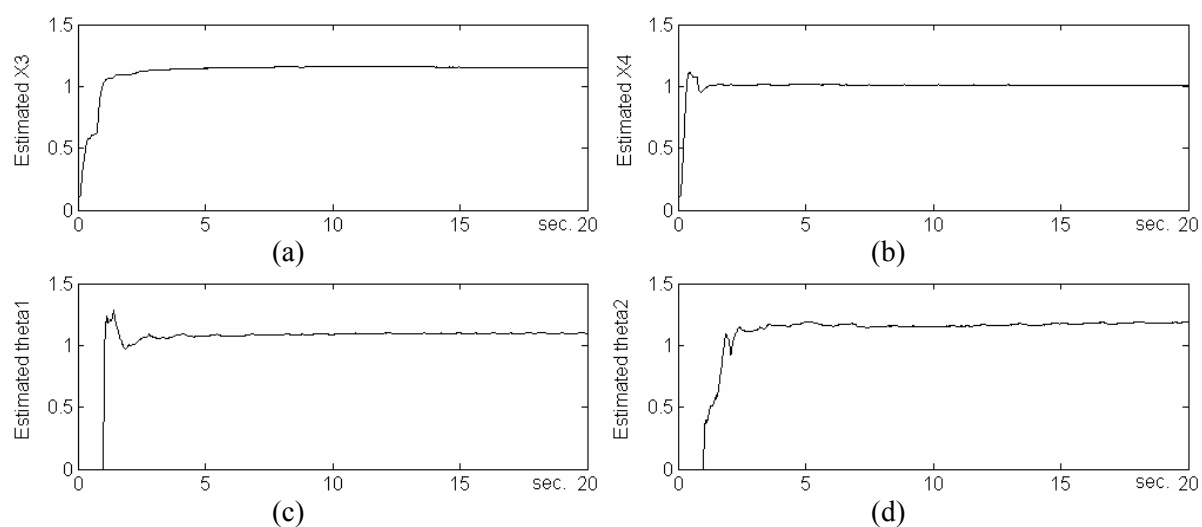

Fig. 8: Performance of the proposed boot-strap estimator with real data, using the EKF and the RPEM based on Kalman filter approach. Initial seeds:  $R_s(0)=2.5\Omega$  and  $L_s'(0)=15\text{mH}$ . (a) estimated state  $x_3$  - inverse of scaled rotor time constant, (b) estimated state  $x_4$  - scaled magnetizing inductance, (c) estimated parameter  $\theta_1$  - scaled stator transient inductance, (d) estimated parameter  $\theta_2$  - scaled stator resistance.

As can be seen, in fig. 9(a), the measured stator current  $q$  component, in the stator reference frame, and the same one, simulated with the parameters estimated by the above-proposed estimator, are very similar. Like the stator current, the estimated rotor flux, in the stator reference frame, closely match the same rotor flux simulated with the estimated parameters, as shown in fig. 9(b).

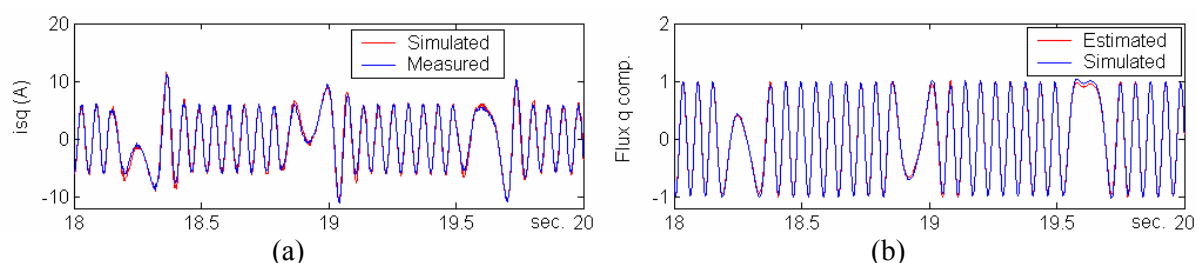

Fig. 9: Performance of the proposed boot-strap estimator with real data – validation of the estimated states and parameters. (a) Measured and simulated stator current  $q$  component, (b) simulated and estimated rotor flux  $q$  component. Simulated signals were obtained using the online estimated parameters All signals are in the stator reference frame.

## Conclusions

The boot-strap estimator introduced in this paper is proposed for joint online estimation of rotor flux and physical parameters of vector controlled induction motors with independent estimation of the stator parameters by a recursive prediction error based approach. It is not restricted to steady-state operation, being capable to operate in transient conditions and the possibility of enabling or disabling the stator parameter estimation becomes available, taking into account the momentary machine dynamics. The rotor reference frame is used and therefore the sampling frequency can be made lower than in the stator one. Due to this, together with the RPEM used for estimation of stator parameters and the reduced order model structure adopted for the EKF, the computational effort is reduced with respect to a full order EKF. Different approaches have been tested in the RPEM and the comparison shows that Kalman filter, normalized gradient and unnormalized gradient have a good performance, in the estimation of stator parameters which are the most difficult to be estimated. The main problem is not the numerical approach of the estimation method but the lack of persistence of the signals. Therefore the estimation should be adjusted to the dynamic conditions of the IM. By this way, rotor parameters and flux components are permanently estimated since they are correctly estimated in both transient and steady-state conditions, and stator parameters are estimated if the dynamic conditions are suitable for this purpose and the estimated values are updated within the EKF, or else estimation should be disabled, and values held. Simulation and experimental results have shown that the above-described start-up of the identification procedure is much more robust than starting the estimation of all parameters and fluxes simultaneously. Depending on the application itself, this kind of identification procedure can be adapted to the adaptive control law as a result of the flexibility and independency that becomes available between the states and parameters, being possible to choose other estimation configurations. Taking into account that the stator resistance has slow dynamics when compared with the others electrical parameters and can be measured or even estimated from time to time, then if its value is assumed to be known we can improve even more the robustness of the estimation of the other three parameters. The identification procedure that has just been presented in this paper can be applied for auto-tuning and adaptive direct field-oriented induction motor control.

## References

- [1] T. Du, P. Vas, F. Stronach, "Design and Application of Extended Observers for Joint State and Parameter Estimation in High-Performance AC Drives", *IEE Electr. Power Appl.*, vol. 142, n.º 2, pp. 71-78, March 1995.
- [2] J. Stepfan, M. Bodson, J. Chiasson "Real-Time Estimation of the Parameters and Fluxes of Induction Machines", *IEEE Trans. Ind. Appl.*, vol. 30, n.º 3, May/June 1994, pp. 746-759.
- [3] L. Loron, G. Laliberté, "Application of the Extended Kalman Filter to Parameters Estimation of Induction Motors", in *Proc. EPE*, Brighton, 1993 pp. 85-90.
- [4] J. W. Finch, D. J. Atkinson, P. P. Acarnley, "Full-Order Estimator for Induction Motor States and Parameters", *IEE Electr. Power Appl.*, vol. 145, n.º 3, pp. 169-179, May 1998.
- [5] V. Leite, R. Araújo, D. Freitas, "Flux and Parameters Identification of Vector-Controlled Induction Motor in the Rotor Reference Frame", in *Proc. AMC'02*, Maribor, Slovenia, July 4-5, 2002, pp. 263-268.
- [6] V. Leite, R. Araújo, D. Freitas, "A Real-time Estimator of Electrical Parameters for Vector Controlled Induction Motor using a Reduced Order Extended Kalman Filter", in *Proc. EPE-PEMC'02*, Cavtat & Dubrovnik, Croatia, September 9-11, 2002, paper T11-029.
- [7] L. Ljung, "System Identification, Theory for the User", Prentice Hall, 1999.
- [8] G. C. Goodwin, K. S. Sin, "Adaptive Filtering Prediction and Control", *Prentice-Hall*, 1984.
- [9] P. Vas, "Parameter Estimation, Condition Monitoring, and Diagnosis of Electrical Machines", *Oxford Science Publications*, 1993.
- [10] A. J. L. Harrison, D. P. Stoten, "Generalized Finite Difference Methods for Optimal Estimation of Derivatives in real-Time Control Problems", in *Proc. Instn Mech Engrs*, vol. 209, pp 67-78, 1995.
- [11] V. Leite, R. Araújo, D. Freitas, "A New Online Identification Methodology for Flux and Parameters Estimation of Vector Controlled Induction Motors", 2003 IEEE International Electric Machines and Drives Conference – IEMDC 2003, in press.