

A Cluster Based Architecture for Intersection Collision Avoidance Using Heterogeneous Networks

Lung-Chih Tung*, Jorge Mena*, Mario Gerla* and Christoph Sommer*[†]

* Department of Computer Science, University of California Los Angeles, USA

[†] Computer and Communication Systems, University of Innsbruck, Austria

{dragond, jmena, gerla}@cs.ucla.edu

christoph.sommer@uibk.ac.at

Abstract—With the popularity of wireless devices, the possibility of implementing vehicular safety applications has been studied for years in the context of vehicular ad-hoc networks. Dedicated Short Range Communication (DSRC) is designed to serve the needs of vehicular safety applications. However, DSRC does not offer good enough coverage and range around intersections in urban areas for certain applications such as intersection collision avoidance. Considering these drawbacks, LTE, an advanced cellular communication technology, is proposed as an alternative to DSRC. One problem is LTE bandwidth capability to support regularly transmitted cooperative awareness messages. In this paper, we propose a cluster based architecture using both Wi-Fi and LTE channels to accomplish this task. In our architecture, Wi-Fi peer to peer channels are used for cluster formation while LTE channels are used for transmitting Cooperative Awareness Messages (CAMs). A clustering algorithm specifically designed for intersection collision avoidance service is proposed in this paper. In addition, a channel allocation algorithm is applied to reduce the interference of Wi-Fi channels between different clusters. Simulations show that CAM traffic can be efficiently supported in this architecture.

Index Terms—LTE, Wi-Fi, cluster, VANET, Safety application.

I. INTRODUCTION

Intelligent Transportation Systems (ITS) are dedicated to improve transportation safety and mobility. ITS can be generally divided into intelligent infrastructure systems and intelligent vehicle systems. Intelligent infrastructure systems consist of the backbone management system such as a transportation management center, and communication points to vehicles such as Roadside Units (RSUs).

Conversely, intelligent vehicle systems, which we focus on in this paper, are formed by vehicles equipped with wireless communication technology. Data can be disseminated among vehicles and between vehicles and RSUs to achieve emergency handling and efficient transportation.

One technology designed for intelligent vehicle systems is Dedicated Short Range Communication (DSRC), for which the U.S. Federal Communications Commission (FCC) allocated 75 MHz of spectrum in the 5.9 GHz band for use by ITS vehicle safety and mobility applications. Every vehicle transmits small data packets called Cooperative Awareness Messages (CAMs) to each other, providing its state such as speed or location. In many DSRC based systems, such CAMs are envisioned to be transmitted no less than every 100 ms.

DSRC offers benefits such as low latency, high reliability and priority access for safety applications. The original DSRC plan included the deployment of a massive number of DSRC RSUs, thus creating an infrastructure that supports the vehicular DSRC radios. However, due to the cost, the RSU deployment has been indefinitely postponed. While the usage of on board peer to peer DSRC has been widely explored, an alternative, cellular networks, has also been studied.

As opposed to DSRC, communication via cellular networks is a centralized solution, in which the User Equipment (UE) of each vehicle connects to a base station and transmits CAMs. For an intersection collision avoidance service, when the base station receives a CAM from a UE, it forwards it to vehicles on other roads for them to identify the potential collisions. The advantage of this approach is that, for safety applications such as intersection collision avoidance, communications via cellular networks offer better connectivity in urban environments than DSRC since the line-of-sight transmission of the latter could be easily blocked by buildings around intersections [1], [2].

However, it is not clear if the current cellular network technology can accommodate the amount of traffic generated by CAMs. The state of art technology, LTE, offers as high as 50 Mbit/s uplink data rate and 100 Mbit/s downlink data rate. It can be operated on 1.4–20 MHz bandwidth.

For intersection collision avoidance, the amount of traffic generated by CAMs can be determined by a number of factors: the cell size, the number of intersection per cell, the number of vehicles per intersection per cell, the size of CAM, and the transmission interval. If adaptive beaconing is used, the number of CAMs generated can be dynamically reduced [3]–[5], which can still support safety applications if the system can quickly react to radio shadowing [6], yet decreasing the beacon interval below 10 Hz is commonly deemed unsafe. Assuming that a typical cell size of 5 km is used [7], and there are 10 intersections in a cell, 50 vehicles at each intersection, 5000 CAMs are generated per second if each vehicle transmits CAMs at 10 Hz.

For use by public safety applications, the FCC assigned the lower half of the 700 MHz Public Safety Band (763–768 MHz and 793–798 MHz) for broadband communications¹. Note that this band is shared by all public safety services.

¹<http://transition.fcc.gov/pshs/public-safety-spectrum/700-MHz/>

Currently there is no standard that specifies the bandwidth allocation for each service. It is unclear how much bandwidth will be used for vehicular safety services, and furthermore, how much will be used for intersection collision warning applications. The support of intersection collision avoidance demands a large amount of data traffic between UEs and base stations, which is not likely to be accepted by network operators.

In addition, extra traffic between UEs and base stations increases the effect of interference and thus decreases the delivery rate. The scheduler at the base station may also have difficulty to schedule transmissions within the tight delay bounds required for an intersection collision avoidance service.

To solve these problems, we propose a cluster based architecture for intersection collision avoidance service using both Wi-Fi and LTE technology. We choose IEEE 802.11b Wi-Fi instead of IEEE 802.11p because of its popularity and low cost, however, any short range communication technology can be applied to our architecture.

When approaching an intersection, the Wi-Fi interfaces are used to transmit beacons to form a cluster. The vehicle closest to the intersection becomes the cluster head and maintains the status of the cluster. Only the cluster head is allowed to transmit/receive CAMs to/from base stations through LTE interfaces. Our architecture allows CAMs to be transmitted efficiently within the cluster, without causing additional load on base stations, improving the delivery rate and keeping the packet delay at a satisfactory level.

The rest of the paper is organized as follows: in Section II, we briefly introduce related clustering algorithms and systems using more than one radio technology. We elaborate on our architecture and clustering algorithm in detail in Section III. A simulative performance evaluation of the proposed approach, and a comparison with related approaches, are described in Section IV, followed by the conclusions.

II. RELATED WORK

A. Clustering Algorithms

Many clustering algorithms have been proposed for routing and data dissemination in Vehicular Ad Hoc Networks (VANETs) [8]–[13]. These algorithms try to elect a cluster head who is responsible for transmitting data packets and organizing the cluster structure.

The cluster heads or gateways can be used as forwarding nodes to propagate data. This way, data can be forwarded in an efficient way without incurring much routing overhead and overloading the channel.

In general, two approaches can be used for cluster creation and organization:

- 1) Passive clustering [8], [9]. In this approach, data packets are piggybacked on control messages for cluster creation and organization. As passive clustering does not require explicit signaling or protocol specific messages for creating or maintaining clusters, the control overhead is significantly reduced.

- 2) Proactive clustering [10]–[14]: This approach is based on the regular transmission of HELLO messages by all nodes. The advantage is that, with the explicit control messages, the cluster can be created in a better way in terms of the cluster stability, but the protocol has to be carefully designed to avoid overloading the channel when node density is high.

Both passive and proactive clustering can use additional information such as speed, mobility, and location to improve the cluster formation process. For example, in [15], the authors proposed a moving zone clustering algorithm that predicts speed and computes a similarity score. The similarity score is used to identify nodes with similar mobility patterns for cluster creation. Using mobility information for cluster formation improves the stability of a cluster and thus generally achieves better performance.

B. Heterogeneous Architecture

In VANETs, due to the highly dynamic mobility pattern of nodes, network connectivity can be intermittent. Heterogeneous mobile wireless broadband access architectures can be used to increase the coverage of wireless communications. In addition, load balancing can be applied between the cellular network and the VANETs.

In [16], the authors proposed the MobTorrent framework. It makes use of a cellular network to establish a control channel, coordinating data transfer to roadside APs and mobile helpers to help vehicles make more efficient use of intermittent Wi-Fi contacts for data downloads.

The authors in [17] addressed the problem from the other end, addressing the issue of augmenting mobile 3G using Wi-Fi. The idea is to offload data on Wi-Fi whenever possible hence avoiding using the 3G link when Wi-Fi is available.

Integrated cellular network and VANETs can also facilitate the packet forwarding strategy. In [18], the authors propose a multi-network packet scheduling architecture to maximize the network throughput and keep latency and packet loss within the minimum requirements for vehicular network application classes. Different application classes are given different priority and mapped to different interfaces. The simulation shows better performance is achieved by using multi-network architecture.

In contrast to related work, we employ a novel heterogeneous system architecture for low-latency safety applications, for keeping network load local, and for reducing the overall amount of data exchanged.

III. CLUSTER BASED ARCHITECTURE

A. Assumptions

We assume each vehicle has both Wi-Fi and LTE interfaces installed or has mobile devices with these interfaces attached so that it can communicate to other vehicles through Wi-Fi and to base stations through LTE. Either the vehicle or the mobile device has GPS and a digital map providing information like location, speed, and road geometry.

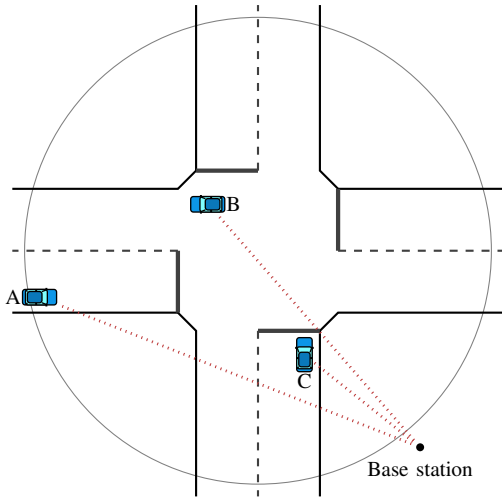

Fig. 1. Service region around an intersection. Vehicle A starts to send CAMs to the base station when entering the intersection's service region. Vehicles B and C keep sending CAMs while they are going through the intersection.

Road geometry information, in particular the location of intersections, is needed in our architecture so that each vehicle knows when it approaches an intersection.

We define a road segment to be the segment of road between two intersections. Each road segment/intersection is assigned an ID called road ID/intersection ID. This requires a minor modification to the digital map and can be done during the construction of the map.

For example, the TIGER map² record type 1 (RT1) and record type 2 (RT2) offered by U.S. Census Bureau can be used to construct a digital map with the required attributes. Records of type RT1 contain the information of a road, such as its name, its type, its direction, and its start and end points. Records of type RT2 contain the information of the middle points of a road.

B. Architecture Overview

In general, the intersection collision avoidance service works as follows: when a vehicle approaches an intersection, it starts sending CAMs to vehicles on other roads indicating its existence (Figure 1). If the vehicle is equipped with a Wi-Fi interface, CAMs can be transmitted by broadcasting. However, when node density is high, broadcasting could overload the channel. This is a common problem in VANETs because of heavy traffic during rush hour, for which the intersections are usually the bottlenecks.

If the vehicle is equipped with an LTE interface, the CAMs can be transmitted to a base station and then be forwarded to vehicles on other roads. This causes problems also because the CAM transmissions put heavy burden on the base station considering the fact that CAMs are transmitted every 100 ms. Excessive connections increase the possibility of interference and packet error rate. It also increases the packet delay due to resource depletion.

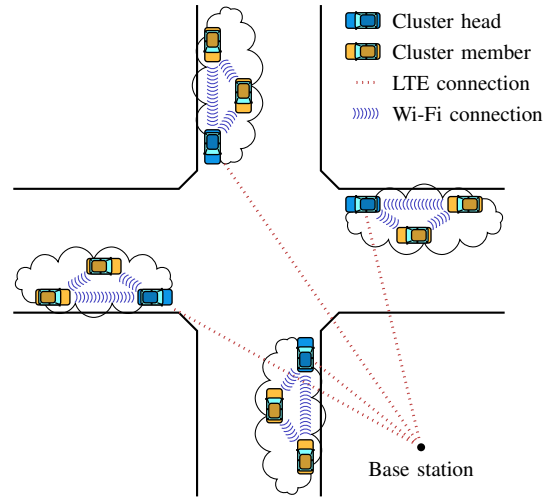

Fig. 2. Beacons are exchanged within clusters, CAMs between clusters.

In order to reduce the amount of traffic transmitted between UEs and base stations, a clustering algorithm is needed. Many clustering algorithms have been proposed for routing or data dissemination purposes in VANET domains. These clustering algorithms may not be suitable for an intersection collision avoidance service due to several reasons. First, to maintain the cluster structure, these algorithms usually require successive control messages exchanges between cluster members and cluster heads, such as join messages and leave messages. This results in substantial signaling overhead which threatens to negate their benefit for the considered application. Second, for intersection collision avoidance, the accuracy of the location of cluster members is very important. It is hard to keep the location information of each cluster members up to date. Since we are focusing on intersection collision avoidance service, a special clustering algorithm is needed for this purpose.

Due to these reasons, in this paper we propose a light weight cluster-based intersection collision avoidance service using both LTE and Wi-Fi interfaces. The idea of our clustering algorithm is that, since vehicles are typically moving in groups, it is reasonable to treat each such group as a cluster, and the cluster as a whole for intersection collision avoidance purposes. The vehicle closest to the intersection will be elected as the cluster head and is responsible for maintaining the cluster structure and exchanging CAMs via a base station. Vehicles on the same road that move in the same direction will be in the same cluster. CAMs contains the start and end position of the cluster on the road, which are used for collision avoidance. Our architecture does not require explicit join and leave control messages, as long as cluster members are within the range of the cluster.

For the intersection collision avoidance service, it is not necessary to maintain the cluster structure all the time. We define the *cluster region* to be the region in which vehicles send beacons for cluster formation. We define the intersection collision avoidance service region (abbreviated as *service region*) to be the region in which cluster heads send CAMs to base stations.

²<http://www.census.gov/geo/www/tiger/>

Cluster Head ID	Road ID	Intersection ID	Last Node ID	Start Position	End Position	Direction
32 bit	32 bit	32 bit	32 bit	128 bit	128 bit	1 bit

(a) The format of beacons broadcast by the cluster heads.

Cluster Head ID	Road ID	Direction	Start Position	End Position
32 bit	32 bit	1 bit	128 bit	128 bit

(b) The format of CAMs exchanged between clusters.

Fig. 3. Beacon and CAM format.

The cluster region should be larger than or at least equal to the service region because we want the clusters to be built before the cluster heads send CAMs to base stations. To avoid confusion, we refer to the packets transmitted within clusters through Wi-Fi interfaces only as *beacons*, and to the packets transmitted between cluster heads and base stations for intersection collision avoidance purposes as CAMs. The algorithm for transmitting beacons and CAMs can be summed up as follows.

- When a vehicle approaches an intersection, it first broadcasts beacons through its Wi-Fi interface to form a cluster.
- After the cluster is built, the cluster head sends CAMs to the base station.
- The base station will forward CAMs to cluster heads on other roads.
- The cluster heads receiving the platoon information sent from the base station will broadcast it through their Wi-Fi interfaces to their members.
- The cluster heads keep sending CAMs until the clusters pass the intersection.
- The cluster is dismissed then, meaning beacons and CAMs are no longer transmitted.

In this way, our algorithm allows CAMs to be transmitted efficiently and significantly reduces the load on the base station. Figure 2 illustrates the cluster structure at an intersection.

C. Clustering Algorithm

The details of our clustering algorithm can be described as follows. Each vehicle can be either a cluster head or a cluster member. When entering into the cluster region, each vehicle is initialized as the cluster head. The cluster head broadcasts beacons containing its cluster range (with start and end position initially set to its location), the ID of the road on which it is running, and its direction of travel (Figure 3). It keeps broadcasting beacons until its state changes to cluster member due to the discovery of a closer cluster head, or until the last member of the cluster passes the intersection. The latter requires the last cluster member to send an extra message when

it passes the intersection. Other vehicles receive the beacons allowing them to compare their location to the cluster range. If the receiver is closer to the intersection and it is a cluster head, it stores the location information in its member table, updating the end position of its platoon if necessary, and it keeps broadcasting beacons. The sender's state will be changed later when it receives the successive beacons broadcast by the new cluster head. If the receiver is a cluster member, it does nothing as it has been included in a cluster. Note that it may not be in the same cluster as the sender; however, it is not responsible for the correction of the sender's state. Only vehicles on the same road and moving in the same direction will process the beacon; otherwise the beacon will be discarded.

If the receiver's location is farther from the intersection than the sender and it is a cluster head, it changes its state to cluster member. After the cluster is built, the cluster member does not send beacons to the cluster head as long as it is within the cluster range. The only exception is the last cluster member, who will send back its location information to the cluster head after receiving the beacon. If the cluster head does not receive any such response from the last member, it will start to broadcast beacons with the second last member ID (according to its member table), repeating the process if no response is heard. Therefore, our clustering algorithm requires only the cluster head and the last cluster member to exchange message for cluster maintenance. If a cluster member does not receive beacons from its cluster head or any other cluster head closer to an intersection for a period of time, it sets its own state to cluster head to form a new cluster. For example, a cluster member slowing down to wait for red light, while its original cluster head passes the intersection, will create a new cluster. In this way, our clustering algorithm exchanges fewer messages to build and maintain a cluster.

D. CAM Delivery

The cluster head is responsible for transmitting CAMs to the base station. The CAM message includes the start location (the cluster head location) and the end location (the location of the farthest cluster member from the intersection) instead of transmitting the locations of every cluster member. After the base station receives the CAMs from the cluster heads, it stores the cluster information in its forwarding table, and forwards CAMs to cluster heads on other roads connecting to the same intersection. Each entry in the forwarding table contains the following information:

<Cluster Head ID, Road ID, Intersection ID,
Start location, End location, Timestamp>

The timestamp is used to remove an outdated entry a period of time after the base station stops receiving CAMs from the associated vehicle. The cluster heads receive the CAMs from the base station and broadcast them to their cluster members so that they can be aware of the clusters on other roads and identify potential collisions.

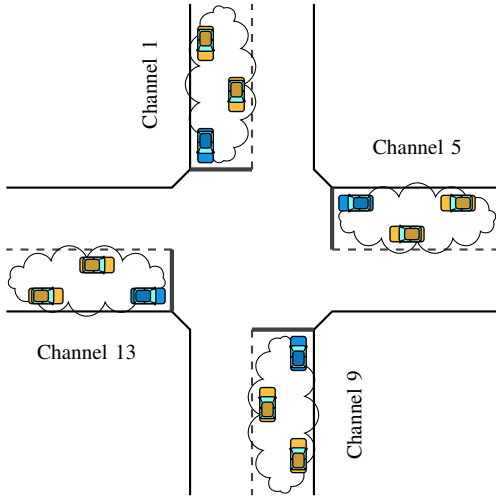

Fig. 4. Channel allocation scheme spreading different clusters across different channels to minimize interference.

E. Wi-Fi Channel Allocation Algorithm

In our architecture, vehicles broadcast beacons using Wi-Fi interfaces within clusters. In order to avoid interference between clusters on different roads, we design a Wi-Fi channel allocation algorithm. Our idea is to allocate Wi-Fi channels as far apart from each other as possible. With the aid of the digital map, the channels can be allocated based on the road information. Given the road topology, the number of channels needed is equal to the number of roads connecting to an intersection. The gap (in terms of channels) between each allocated channel can be calculated as follows:

$$\text{channel gap} = \frac{\text{total \# of channels}}{\# \text{ of roads} - 1}, \quad (1)$$

where the total number of channels is the number of available channels in Wi-Fi frequency band (which is 13). Therefore, for a 3-leg intersection, the gap is $13/(3 - 1) = 6.5 \approx 6$, resulting in channel 1, 7, and 13 selected. Similarly, for a 4-leg intersection, the gap is $13/(4 - 1) \approx 4$ and channel 1, 5, 9, 13 are selected.

The next step is to allocate the channels in a known order. This can be done by allocating channels to clusters in clockwise order, starting from the cluster in the north of the intersection. For example, for a 4-leg intersection, the cluster in the north of the intersection will be allocated channel 1, followed by the cluster in the east being allocated channel 5, followed by the cluster in the south being allocated channel 9, and the cluster in the west will be allocated channel 13 (illustrated in Figure 4). Since we assume each vehicle has road geometry information, each vehicle knows which channel it should use to communicate to other cluster members.

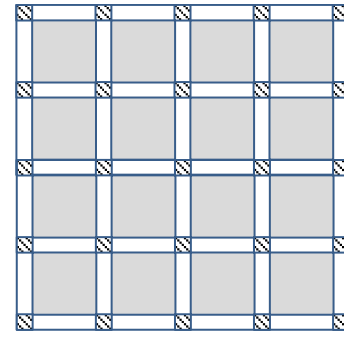

Fig. 5. The simulated road topology, a regular 5×5 grid of roads.

IV. PERFORMANCE EVALUATION

In this section, we evaluate the performance of our protocol by simulations. We conduct our simulations with the NS-3 network simulator³ (version 3.16). NS-3 has an LTE module which implements most functionality defined in the 3GPP specification. We created a grid road topology containing 25 intersections (shown in Figure 5). Each road segment is 500m long. The base station is installed in the center of the road topology. A remote server is connected to the PDN Gateway (PGW) for forwarding CAMs. We assume the server is connected to the PGW using a dedicated line. Therefore, the delay between the PGW and the remote server is set to 0 in our simulations.

We use VanetMobiSim⁴ as our vehicle traffic generator. The scenario we created is intersections regulated by traffic lights. Initially each vehicle is placed randomly in the layout with speed 0. It starts moving and increases its speed until it reaches the configured speed limit or until it approaches a car ahead of it. Considering the speed limit is 50 km/h, and typically a car is warned 3 s before collision, this results in about 42 m before arriving at the intersection center. In our simulations, we set the radius of the service region to 70 m for safety reasons, within which vehicles send CAMs to base station. The radius of the cluster region is set to 100 m within which vehicles send beacons to create clusters. The parameters are listed in Tables I and II.

³<http://www.nsnam.org/>

⁴<http://vanet.eurecom.fr/>

TABLE I
SIMULATION PARAMETERS

Simulation Parameter	Value
Simulated Area	2 km \times 2 km
Layout	Grid layout, 25 intersections
Service Region	70 m
Cluster Region	100 m
Road Segment Length	500 meters
Road Structure	Two way two lanes
Speed Limit	50 km/h
Simulation Time	60 s
Beacon Transmission Interval	100 ms
CAM Transmission Interval	100 ms

TABLE II
WI-FI AND LTE SETTINGS

Wi-Fi Parameter	Value
Protocol	IEEE 802.11b
Tx Power	16 dBm
Date Rate	11 Mbit/s
Transmission Range	100 m
Tx Gain	1 dB
Rx Gain	1 dB
Propagation Delay Model	Constant Speed Prop. Delay Model
LTE Parameter	Value
Base Station Tx Power	40 dBm
UE Tx Power	20 dBm
Bandwidth	5 MHz (25 RBs)
Scheduling Algorithm	Proportional Fair
Simulation Time	60 s

We compare the performance of three schemes:

- **WI-FI ONLY:** each vehicle has only a Wi-Fi interface. CAMs are broadcast through Wi-Fi.
- **LTE ONLY:** each vehicle has only an LTE interface. CAMs are transmitted through LTE interfaces and forwarded by the base station.
- **HETEROGENEOUS:** both Wi-Fi and LTE are used. Wi-Fi is used for cluster construction and maintenance. LTE is used for CAM transmission.

We use two metrics to evaluate the performance:

- **Delivery rate:** For collision avoidance service, an important goal is to reliably deliver the CAMs to the target vehicles. In the **WI-FI ONLY** and **LTE ONLY** schemes, the target vehicles should be all vehicles on roads other than that of the sender. In the **HETEROGENEOUS** scheme, the target vehicles are the cluster heads on other roads. We define the delivery rate as the ratio of the total number of received CAMs to the total number of expected recipients. The expected number of recipients is calculated by counting the number of vehicles or cluster heads on other roads each time a CAM is sent.
- **Packet delay:** the delay from the time the CAM is created to the time the CAM is received by a vehicle – either directly by broadcast or indirectly by forwarding via the base station.

As we can see in Figure 6, the delivery rate decreases as the number of nodes grows. For the **WI-FI ONLY** scheme, this indicates the channel has been saturated and collisions happen frequently. For the other two schemes, this is due to the fact that the radio resource is not sufficient to complete the transmission of CAMs as the number of the nodes grows. Most of the CAMs cannot be successfully received by the base station and the target receivers. In most cases the delivery rate of the **HETEROGENEOUS** scheme is much higher than the other two schemes.

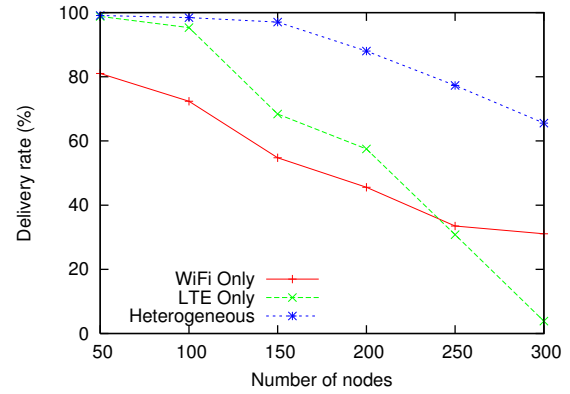

Fig. 6. Packet delivery rate is highest for the clustering scheme.

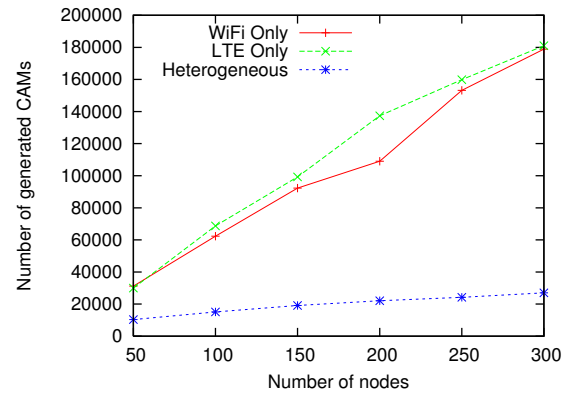

Fig. 7. The number of exchanged CAMs is reduced by clustering.

Additionally we can see the total number of CAMs transmitted in Figure 8. In the **WI-FI ONLY** and **LTE ONLY** schemes, the total number of CAMs transmitted increases linearly as the number of nodes grows, while that of the **HETEROGENEOUS** scheme just increases slightly due to the usage of the clustering algorithm. The number of generated CAMs is in proportional to the number of clusters created. Figures 6 and 8 show that our clustering algorithm effectively reduces the number of CAM transmissions and thus achieves much better delivery rate.

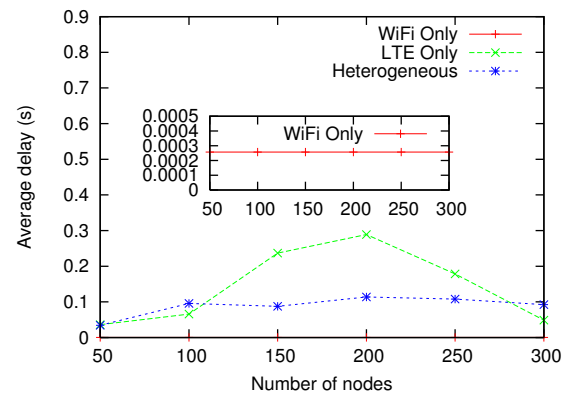

Fig. 8. Packet delays are acceptable for the clustering scheme.

As for the delay, we can see in Figure 7 that the delay of the WI-FI ONLY scheme is much less than in the other two schemes. This is not surprising because the direct transmission between two Wi-Fi nodes introduces much less delay factors. In the LTE ONLY and HETEROGENEOUS schemes, the CAMs have to go through the following process to be received by the intended receivers:

- 1) CAMs are transmitted to the base station.
- 2) CAMs are received by the base station in the order set by the scheduler.
- 3) CAMs go up the LTE protocol stack.
- 4) The server decides to whom to forward the CAMs.
- 5) CAMs go down the LTE protocol stack.
- 6) CAMs are scheduled for transmission.
- 7) CAMs are received by the target vehicles.

The delay of HETEROGENEOUS scheme is much less than that of LTE ONLY most of the time. Although the delay in HETEROGENEOUS scheme is longer than that in the WI-FI ONLY scheme, it is around 100 ms which is acceptable for our application.

In our simulations, the delay increases slightly when node density grows because the radio resource is not sufficient to schedule the transmission in time. A special scheduling algorithm may be needed to solve this problem.

V. CONCLUSIONS

In this paper, we propose a clustering architecture for intersection collision avoidance using Wi-Fi and LTE. Wi-Fi channels are used for in-cluster communication and LTE channels are used for exchanging Cooperative Awareness Messages (CAMs) between clusters. Our novel clustering algorithm is specifically designed for intersection collision avoidance service. It only requires signaling between the cluster head and the last cluster member for cluster creation and maintenance. Moreover, we propose a channel allocation algorithm to use different Wi-Fi channels for different clusters to avoid interference. The simulations show our heterogeneous architecture performs much better than other schemes in terms of the delivery rate.

Although our architecture significantly increases the delivery rate, it still needs to be improved. In addition, the delay is also very important. Our simulation shows that the average delay of our architecture meets the requirement of the safety application, but the delay bound has not been verified. A special scheduling algorithm may be needed for scheduling the delay-sensitive CAMs. We leave it as the future work.

REFERENCES

[1] J. Karedal, F. Tufvesson, T. Abbas, O. Klemp, A. Paier, L. Bernadó, and A. Molisch, "Radio Channel Measurements at Street Intersections for Vehicle-to-Vehicle Safety Applications," in *71st IEEE Vehicular Technology Conference (VTC2010-Spring)*. Taipei, Taiwan: IEEE, May 2010, pp. 1–5.

[2] E. Giordano, R. Frank, G. Pau, and M. Gerla, "CORNER: a Realistic Urban Propagation Model for VANET," in *7th IEEE/IFIP Conference on Wireless On demand Network Systems and Services (WONS 2010), Poster Session*. Kranjska Gora, Slovenia: IEEE, February 2010, pp. 57–60.

[3] R. K. Schmidt, T. Leinmüller, E. Schoch, F. Kargl, and G. Schäfer, "Exploration of adaptive beaconing for efficient intervehicle safety communication," *IEEE Network Magazine*, vol. 24, no. 1, pp. 14–19, January 2010.

[4] C. Sommer, O. K. Tonguz, and F. Dressler, "Traffic Information Systems: Efficient Message Dissemination via Adaptive Beaconing," *IEEE Communications Magazine*, vol. 49, no. 5, pp. 173–179, May 2011.

[5] C. Thaina, K. N. Nakorn, and K. Rojviboonchai, "A study of adaptive beacon transmission on Vehicular Ad-Hoc Networks," in *13th IEEE International Conference on Communication Technology (ICCT)*. Jinan, China: IEEE, September 2011, pp. 597–602.

[6] C. Sommer, S. Joerer, M. Segata, O. K. Tonguz, R. Lo Cigno, and F. Dressler, "How Shadowing Hurts Vehicular Communications and How Dynamic Beaconing Can Help," in *32nd IEEE Conference on Computer Communications (INFOCOM 2013), Mini-Conference*. Turin, Italy: IEEE, April 2013, pp. 110–114.

[7] S. Sesia, I. Toufik, and M. Baker, *LTE, The UMTS Long Term Evolution: From Theory to Practice*. Wiley Publishing, 2009.

[8] O. Kayis and T. Acarman, "Clustering Formation for Inter-Vehicle Communication," in *IEEE Intelligent Transportation Systems Conference (ITSC 2007)*. Seattle, WA: IEEE, October 2007.

[9] T. J. Kwon, M. Gerla, V. K. Varma, M. Barton, and T. R. Hsing, "Efficient Flooding with Passive Clustering – An Overhead-Free Selective Forward Mechanism for Ad Hoc Sensor Networks," *Proceedings of the IEEE*, vol. 91, no. 8, pp. 1210–1220, August 2003.

[10] T. Wang and G. Wang, "TIBCRPH: Traffic Infrastructure Based Cluster Routing Protocol with Handoff in VANET," in *Wireless and Optical Communications Conference (WOCC)*, Shanghai, China, May 2010.

[11] Y. Luo, W. Zhang, and Y. Hu, "A New Cluster Based Routing Protocol for VANET," in *Networks Security Wireless Communications and Trusted Computing (NSWCTC)*. Wuhan, China: IEEE, April 2010, pp. 502–504.

[12] T. Song, W. W. Xia, T. Song, and L.-f. Shen, "A cluster-based directional routing protocol in VANET," in *Communication Technology (ICCT)*. Nanjing: IEEE, November 2010, pp. 1172–1175.

[13] K. P. Naveen and K. Karuppanan, "Mobile cluster assisted routing for urban VANET," in *International Conference on Recent Trends in Information Technology (ICRTIT 2011)*. Chennai, India: IEEE, June 2011, pp. 296–300.

[14] Y. Lu, B. Zhou, L. Tung, M. Gerla, A. Ramesh, and L. Nagaraja, "Energy-Efficient Content Retrieval in Mobile Cloud," in *SIGCOMM 2013, Workshop on Mobile Cloud Computing (MCC)*, Hong Kong, China, August 2013.

[15] S. Gurung, D. Lin, A. Squicciarini, and O. Tonguz, "A moving zone based architecture for message dissemination in VANETs," in *8th International Conference on Network and service management (CNSM), Workshop on Systems Virtualization Management (SVM 2012)*. Las Vegas, NV: IEEE, October 2012, pp. 184–188.

[16] B. B. Chen and M. C. Chan, "MobTorrent: A Framework for Mobile Internet Access from Vehicles," in *28th IEEE Conference on Computer Communications (IEEE INFOCOM 2009)*. Rio de Janeiro, Brazil: IEEE, April 2009.

[17] A. Balasubramanian, R. Mahajan, and A. Venkataramani, "Augmenting mobile 3G using WiFi," in *8th International Conference on Mobile Systems, Applications and Services (ACM MobiSys 2010)*. San Francisco, CA: ACM, June 2010, pp. 209–222.

[18] R. I. Meneguette, E. R. M. Madeira, and L. F. Bittencourt, "Multi-network packet scheduling based on vehicular ad hoc network applications," in *8th International Conference on Network and service management (CNSM), Workshop on Systems Virtualization Management (SVM)*. Las Vegas, NV: IEEE, October 2012, pp. 214–218.