

Review Article

A Comprehensive Review: Computational Models for Obstructive Sleep Apnea Detection in Biomedical Applications

E. Smily JeyaJothi ¹, **J. Anitha** ², **Shalli Rani** ³ and **Basant Tiwari** ⁴

¹Department of Biomedical Instrumentation Engineering, Avinashilingam Institute for Home Science and Higher Education for Women, Coimbatore 641108, India

²Department of Electronics and Communication Engineering, Karunya Institute of Technology and Sciences, Coimbatore 641114, India

³Chitkara University Institute of Engineering and Technology, Chitkara University, Rajpura Punjab-140401, India

⁴Hawassa University, Shashemenē, SNNPRS, Ethiopia

Correspondence should be addressed to Shalli Rani; shallir79@gmail.com

Received 22 November 2021; Accepted 22 December 2021; Published 16 February 2022

Academic Editor: Yuvaraja Teekaraman

Copyright © 2022 E. Smily JeyaJothi et al. This is an open access article distributed under the Creative Commons Attribution License, which permits unrestricted use, distribution, and reproduction in any medium, provided the original work is properly cited.

Obstructive sleep apnea (OSA) is a sleep disorder characterized by periodic episodes of partial or complete upper airway obstruction caused by narrowing or collapse of the pharyngeal airway despite ongoing breathing efforts during sleep. Fall in the blood oxygen saturation and cortical arousals are prompted by this reduction in the airflow which lasts for at least 10 seconds. Impaired labor performance, debilitated quality of life, excessive daytime sleepiness, high snoring, and tiredness even after a whole night's sleep are the primary symptoms of OSA. In due course, the long-standing contributions of OSA culminate in hypertension, arrhythmia, cerebrovascular disease, and heart failure. The traditional diagnostic approach of OSA is the laboratory-based polysomnography (PSG) overnight sleep study, which is a tedious and labor-intensive process that exaggerates the discomfort to the patient. With the advent of computer-aided diagnosis (CAD), automatic detection of OSA has gained increasing interest among researchers in the area of sleep disorders as it influences both diagnostic and therapeutic decisions. The research literature on sleep apnea published during the last decade has been surveyed, focusing on the varied screening approaches accustomed to identifying OSA events and the developmental knowledge offered by multiple contributors from the software perspective. The current study presents an overview of the pathophysiology of OSA, the detection methods, physiological signals related to OSA, the different preprocessing, feature extraction, feature selection, and classification techniques employed for the detection and classification of OSA. Consequently, the research challenges and research gaps in the diagnosis of OSA are identified, critically analyzed, and presented in the best possible light.

1. Clinical Background

Sleep disorders on account of obstructive sleep apnea (OSA) count on specific disturbances of the normal functioning of the upper respiratory airway and are associated with sleep deprivation, fragmented sleep, and primary hypersomnia. Recurrent occurrences of partial or complete cessation of breath during sleep are the characteristics of OSA, and the literature estimates it to be one of the most common sleep disorders prevailing in 17% women and 34% men of the adult population. The initial symptoms are essence with

change in behavioural patterns that eventually lead to change in breathing patterns, insomnia, and may also trigger narcolepsy [1]. The duration of the involuntary and nocturnal respiratory pause varies based on the pathophysiology of the patient and usually extends from 10 seconds (reduction in airflow-hypopnea) to 2 minutes (complete cessation-apnea), with 20 to 40 seconds being the common duration. Disproportionate fat depositions in the pharyngeal muscles tend to constrict the upper air passage and account for the apneic events in OSA patients. The apnea-hypopnea episodes are usually accompanied by a drop in the blood

oxygen saturation which thereupon triggers the autonomic neural response leading to micro arousals with nocturnal choking and gasping for breath. Unrefreshing and fragmented sleep, tiredness, fatigue, and lack of energy are reported by 90% of the OSA patients. A larger fraction of OSA patients are asymptomatic and contribute to the fact that most of them are presently underdiagnosed. Repetitive episodes of apnea-hypopnea result in primary events like intermittent hypoxemia, micro arousals, and increased intrathoracic pressure, which further initiates a cascade of interacting processes that contribute to developmental origins of secondary disease manifestations and disease end points as depicted in Figure 1. Activation of sympathetic nervous system (SNS) is the major contributor to metabolic dysfunction and elevated blood pressure in OSA patients. Sleep apnea is a severe medical condition where the complications gear up cardiac problems, kidney and liver-related disorders, diabetes, and most importantly daytime fatigue [2, 3].

The standard diagnostic approach for sleep apnea is an overnight sleep study that is usually carried out in the sleep labs. It simultaneously records electrocardiography (ECG), electromyography (EMG), electroencephalography (EEG), electrooculography (EOG), oxygen saturation (SpO_2), abdominal and thoracic movement, body posture, snoring level, and other signals and visually analyzed by medical experts. Due to the limitation of sleep labs in hospitals and taking into account the intricacy of the above diagnostic technique, the procedure is quite expensive and cumbersome to use. A minimum of 22 lead wires are connected to the patient's body to acquire 12 different PSG signals, which makes the signal analysis part quite tricky and also cause discomfort to the patient [4, 5]. Apnea-Hypopnea Index (AHI) is used to analyze the severity of the disease, which is measured as the number of apneic episodes in the PSG recordings per hour of sleep, in comparison with the American Academy of Sleep Medicine (AASM). The frequency of apneic events for the detection of OSA is categorized as mild ($5 \leq AHI < 15$ e/h), moderate ($15 \leq AHI < 30$ e/h), or severe ($AHI \geq 30$ e/h) [6]. Considering the complexity based on the number and variability of signals involved, PSG recording and analysis is time consuming and involves the expertise of the clinician. The quality of analysis is ultimately reduced due to the accumulated fatigue throughout the review and due to the complexity of the work itself. In this regard, the development of automated systems, at least in part, PSG's analysis represents significant savings in time, money, and effort, greatly assisting physician work and increasing his time. Indeed, in the best case scenario of a fully capable and appropriately compliant PSG automated analysis, the use of diagnostic support tools will help the scorer to focus only on relevant real information (e.g., AHI). Indeed, in the end, the work of the physician can be reduced to a single task of testing and/or verifying the results of computer analysis [7].

This study is aimed at covering the diagnostic approaches in the field of OSA, which are to some extent supported by automated computer-assisted diagnostic procedures. With this objective, the paper addresses the following in detail:

- (i) Physiological signals associated with OSA detection
- (ii) Signal processing algorithms used for extraction of features that aid in apneic event detection
- (iii) Hardware devices that source the biological signals used for OSA detection
- (iv) Classifiers used for discrimination of normal and abnormal signals

The objective of this study is to reflect the current state of research in a variety of ways and computer-assisted diagnosis for OSA. The abstraction of literature analysis under this review is organized as follows. Section 2 confers about the various biological signals utilized in the study for the detection of OSA, a detailed study on various databases available for sleep apnea detection in Section 3. Section 4 discusses the preprocessing technique used in signal processing, including the details on signal decomposition and extraction of feature components from the signal in Section 5 and followed by feature selection in Section 6. Different classification techniques used for the classification of sleep apnea are discussed in Section 7 and followed by the summarization of other researchers' work highlighting the challenges faced and the future scope in Section 8, and Section 9 concludes the work of the study.

2. Physiological Signals for OSA Detection

The fundamental physiological signals that are employed in various approaches, for the screening of OSA, are discussed in the following session. Based on the inference from the survey, there have been few studies on novel OSA detection techniques, over the past two decades, with a limited set of signals analyzed during PSG procedure. Thus, ECG, PPG, SpO_2 , and audio signals have been used to assist in the diagnosis of sleep apnea.

2.1. Polysomnography. Polysomnography (PSG) is a multi-parametric examination that incorporates recording of several signals of neuro-physiological origin. Signals recorded from the head include EEG, EOG, and EMG. Other biophysiological signals included in the PSG are jaw movement, body position, snoring, respiratory movements, and oxygen saturation levels [8–10]. EEG signals are acquired using the fundamental 10-20 electrode system [11, 12]. Sleep is a combination of events that includes light sleep, deep sleep, and rapid eye movement (REM) sleep that occur in a cyclic manner, without conscious effort of the individual. The different sleep stages depend on the metabolic processes and function of sympathetic and para-sympathetic nervous system. The PSG recordings also include the horizontal EOG signal and submental chin EMG signal [13]. It is evident from the pie chart portrayed in Figure 2 that most of the researchers have made use of the PSG signal for OSA detection. The amount of data required for the detection of OSA is huge and has to be recorded when the person is asleep, on account of which the recording of PSG is done overnight. A sample of PSG signal with only five parametric signals is depicted in Figure 3.

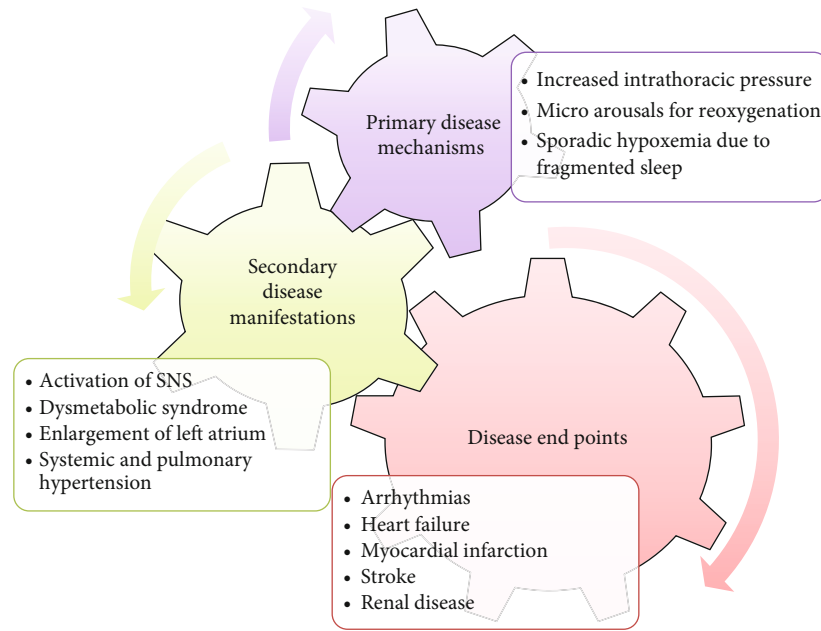

FIGURE 1: Obstructive sleep apnea and cardiovascular disease associations.

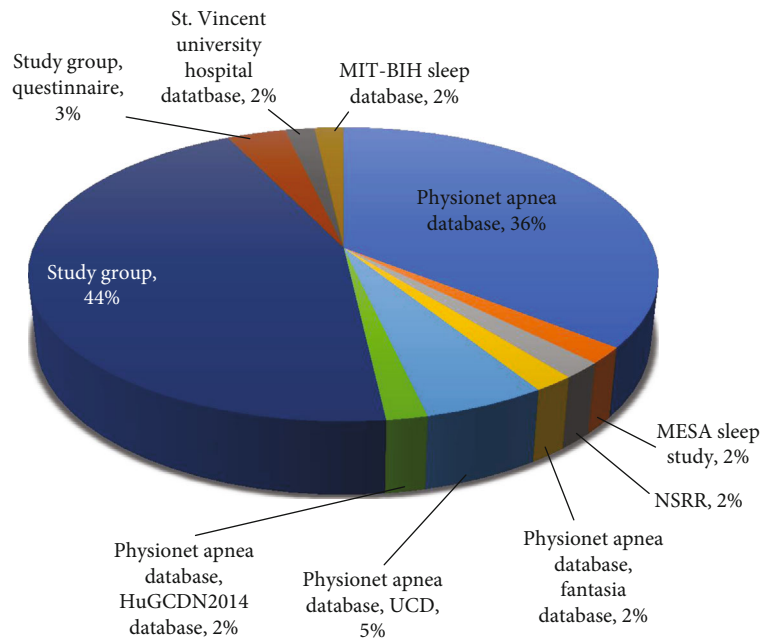

FIGURE 2: Signal sources used in the literature.

2.2. *Photoplethysmography.* For the measurement of respiratory and hemodynamic function, the best opted method is photoplethysmography (PPG). As an alternative to traditional arterial oxygen saturation, pulse photoplethysmography (PPG) signal has been proposed which indicates vasoconstriction changes. In the study by Grote and Zou, the suitability of this signal in monitoring the amplitude changes in airflow and oxygen saturation is tested and compared with other acquisition methods as well as the default apneic event detector. Peripheral arterial tone (PAT) technique

is widely used in monitoring the pulsatile changes in the arterial volume. Using PAT technology, a combined algorithm has been proposed by Varon et al. [14] to identify OSA, where the algorithm included the data from pulse wave attenuations, heart rate (HR) responses, and SpO₂ levels [15]. By carefully analyzing the PPG signal and identifying the morphological parameters from the shape of the waveform assist in extracting the details such as the duration of the apneic period, the number of recurrences, the variation in heart rate, and breathing rate. Basically, a PPG signal

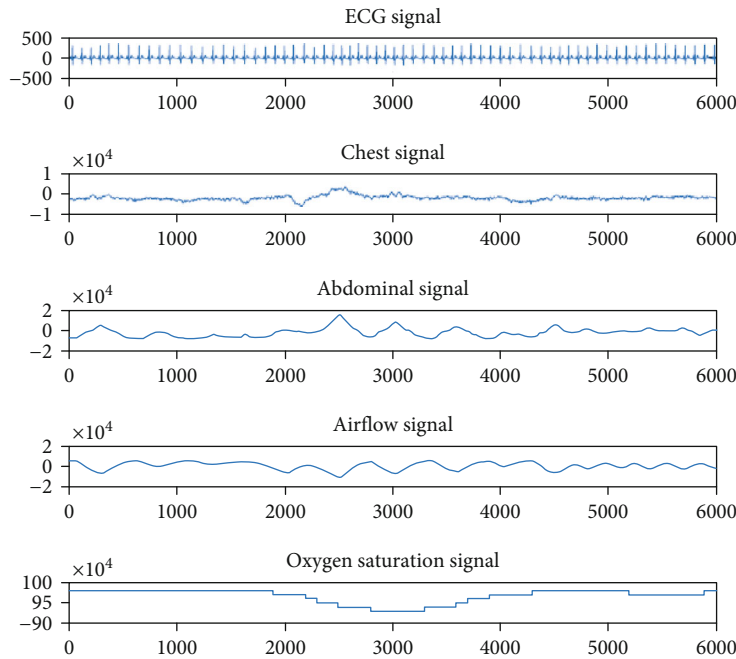

FIGURE 3: Polysomnography signal.

is obtained by illuminating the skin of either the thumb or fore finger and thereby measuring the changes in light absorption. The signal obtained is based on the transmission, absorption, and dispersion of light as it passes through the skin, the underlying tissues, and the blood. The PPG is obtained from a device which utilizes small light emitting diodes (red and near infrared band) transmitting light through the finger to a photodiode. The characteristic parameters extracted from the PPG signal are pulse wave amplitude in both systolic and diastolic, the pulse propagation time, and peak waveform in systolic and diastolic pulse wave. The absorption of light depends purely on the heart-beat, as the blood capillary in the finger contracts and expands with each pulsation of the heart. The signal traces the minimum absorption and the peak absorption of the light intensity, and it is clearly proportional to the cardiac pulse [16]. Most of the previously developed approaches using pulse oximetry signal for screening of OSA are based on percentage oxygen saturation measurement and have been proved to be less accurate as measurement of SpO_2 is less accurate at low values [17].

2.3. Electrocardiography. The OSA diagnostic approach based on the single-channel ECG recording provides a high diagnostic accuracy when compared to other physiological signals [12]. An easier way to monitor heart rate function is an ECG signal that can indicate the level of oxygen coming to the heart. RR interval and ECG-derived respiration (EDR) signals extracted from the ECG signal are employed for the detection of sleep apnea [18]. The ECG signals recorded in combination with PSG signals have gained interest among most of the researchers [19–21]. Of all the research articles compared, majority of the authors used ECG- and PSG-based signal for the detection and classification of OSA.

Motivation to use ECG signal preferred over other signals is due to the effortless acquisition of real-time signals and ample number of sophisticated hardware available to trace the electrical activity of the heart. These measurements have the potential to reduce the cost of diagnosis of OSA.

2.4. Oxygen Saturation (SpO_2). Many patients with obstructive sleep apnea (OSA) report a history of shortness of breath associated with hypopnea. Blood oxygen levels below 90% are considered hazardous and require immediate remedial actions. Considering the cost-effectiveness and ease to access, the extraction of SpO_2 signals is the best choice in the diagnosis of sleep apnea [13]. The oxygen saturation signals are obtained by using a simple pulse oximetry device, in case of real-time monitoring, or from publicly available databases like the PhysioNet Apnea-ECG database and University College Dublin (UCD) database. The Apnea-ECG database contains few recordings of SpO_2 [22]. Time domain and frequency domain oximetry features are extracted for OSA detection. The drop in the level of SpO_2 is measured through spectral analysis to identify the pattern of sleep apnea [23, 24].

2.5. Audio Signals. Investigating snore sounds can be the first step in testing for OSA as soft tissue structures and tone of voice influence the acoustic parameters. Audio signal analysis of snoring sounds can be distributed in a variety of ways, and contactless audio recordings are considered for the OSA severity measurement. Rosenwein et al. [25, 26] have developed an algorithm to identify the normal breathing pattern to that of abnormal breathing pattern based on acoustic signals, and the severity of OSA is estimated by in-home recordings compared with PSG recordings. Kalkbrenner et al. [27] have utilized a microphone to acquire the tracheal

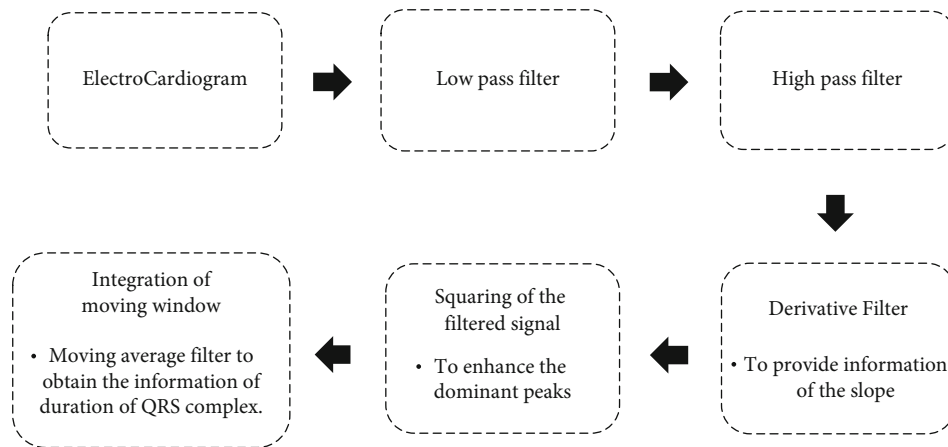

FIGURE 4: Illustration of Pan–Tompkins Algorithm [72].

sounds. The breathing sound is clear near the vicinity of the neck, and accordingly, this method paved way for the acquisition of pulse signals from the carotid arteries. The low amplitude signal due to shallow breathing of the patient is perfectly tapped with proper signal conditioning devices which reduce the noise and the aliasing effect of the signal. The tracheal sound well correlates with the respiratory sound and hence are deployed for the diagnosis of OSA. In 1980, researchers found that laryngeal sounds proved effective in sleep apnea diagnosis [28]. Recent development in the sleep apnea machine has tracheal sound sensors for the recording of respiratory sounds. This tracheal sound sensor incorporates acoustic sensors like that of electronic stethoscopes. In addition to the measurement of tracheal sounds, breathing, snoring, and intrathoracic pressure variations can also be detected if appropriate sensors are used. These acquired parameters are essential for the classification of stages of sleep apnea. The PneaVoX sensor is used for this purpose [29].

3. Signal Source

All the physiological signals employed for OSA detection contain essential information along with the prevalence of artifacts. These signals are either collected directly from hospitals with patient’s consent or taken from publicly available databases. This section discusses the databases that source apnea signals for the detection of sleep apnea.

3.1. PhysioNet Apnea-ECG Database. PhysioNet is a repository of open source medical research data that provides access to various biomedical signals for signal processing and analysis. Of course, a deeper understanding and analysis of the disease is an integral part of the diagnosis besides using appropriate data for accurate diagnosis. The PhysioNet Apnea database consists of 70 annotated night time ECG recordings. In sleep apnea, the diaphragm’s upper airway muscles and neural activation function are imbalanced and consequently result in arousal, where the brain receives an insufficient supply of oxygen, and hence, visual scoring of the breathing pattern is also taken into consideration. Thirty-five recordings are provided with annotations, eight

of which contain respiratory and O_2 saturation signals. [21]]. The potential benefit of using the PhysioNet database is that it allows for a broader challenge for analyzing biomedical signals, including indications like arrhythmias, neurological disorders, cardiovascular diseases, and aging [19]. The PhysioNet database is used along with the UCD repository signals. UCD database is taken from Dublin University Hospital [7, 30].

Along with ECG and EMG signals, tracheal sounds, and nasal airway sounds are also deployed for the diagnosis of sleep apnea [27, 29, 31–33]. Graphical images of PSG signals are also available and used for the analysis [34]. In the Multi-Ethnic Study of Atherosclerosis (MESA) study database, 24480 samples of nasal flow signals have been taken from 10 subjects along with the sleep questionnaire for effective diagnosis of sleep apnea [31].

3.2. Case Study (Sleep Study). Different case study approaches have been taken on board by the researchers. The diagnostic strategies used for all the acquired signals are relevant to PSG, nasal sounds, breathing movements, abdominal wall movements, chest wall movements, tracheal sounds, and diaphragm movements. These signals are recorded using various devices viz., a microphone, Home Sleep Apnea Testing (HSAT) machine, WatchPat system, and by using sensors for measuring the breathing pattern and accelerometer for recording the breathing movement. The subjects are categorized into several groups based on the BMI (body mass index), age, sex, pre-OSA conditions, sleep disorders, and psychological conditions, including narcolepsy. Table 1 summarizes the different sleep study approaches followed by various researchers. PSG signals contain ECG, EEG, EMG, nasal sounds, and breathing patterns [6, 21, 35]. Figure 2 portrays the distribution of the signal source used in the literature.

3.3. Other Modes of Signal Acquisition

3.3.1. Hardware Devices for Signal Acquisition. In many applications, sensors are used for the acquisition of physiological signals. These hardware set-ups have built-in amplifiers and filter circuits for efficient filtering and amplification of the signals. The sensors commonly used are accelerometer

TABLE 1: Summary of sleep study.

Ref. no.	Author and year	Sleep study	Signals/sample acquired
[4]	[4]	253 patients STOP-Bang Questionnaire	PSG
[5]	[5]	5114 patients STOP-Bang Questionnaire	PSG
[36]	[36]	320 patients	SpO2
[37]	[37]	WatchPat device STOP-Bang Questionnaire	SpO2, ECG
[38]	[38]	160 children	PSG, SpO2
[39]	[39]	188 patients	PSG
[31]	[31]	100 patients Sleep Questionnaire	Nasal flow signal
[40]	[40]	3 study groups, 2066 subjects BNSQ Questionnaire	PSG, SpO2
[41]	[42]	455 patients	PSG
[27]	[27]	Ten subjects	PSG
[43]	[43]	1970 signals	SpO2
[44]	[44]	28 patients	PSG
[45]	[45]	79 subjects	SpO2
[46]	[47]	Eight subjects	SpO2
[12]	[12]	33 patients	Snoring sound
[48]	[48]	HSAT device	PSG
[1]	[1]	3 sensors	PSG signals, respiratory sounds, respiratory-related movements
[49]	[49]	144 patients	PSG, venous blood sample
[50]	[50]	186 subjects	PSG, audio signals
[51]	[51]	Eight males and females	PSG
[52]	[13]	Ten patients	Breathing movement

sensors for measuring the breathing movement and diaphragm movement [53–55]. Pulse oximeters are used to measure the oxygen saturation level [38, 53]. Microphones are used to record the nasal and tracheal sounds [29, 31, 53]. PneaVoX sensor is made use to sense the acoustic sounds and suprasternal pressure [29]. In line with the development of laboratory systems, a growing interest over the years has been observed in the design of outpatient equipment which aids in home-based tests. Generally, documents relating to the certification of portable equipment for OSA diagnostics are also extensive, and previous reviews on this can be found [56, 57].

3.3.2. Acquisition Based on Questionnaires. The STOP-Bang Questionnaire is considered as the gold standard for sleep apnea diagnosis along with PSG recordings. The risk factors for OSA are divided into two parts: with the objective question (yes or no) [5]. The acronym for these STOP questions is as follows.

- S Do you *snore* loudly?
T Do you feel *tired*, even after a night sleep?
O The *observed* absence of breathing during sleep?
P Presence of high blood *pressure*

Demographic queries are included in the BANG questionnaire [58, 59]. For each of the questions presented,

“yes” is marked 1, and “no” is marked 0. The score ranges from 0 to 8 for men and 0 to 7 for women [5].

- B *Body mass index (BMI) over 35 kg/m²*
A *Age over 50 years*
N *Neck circumference over 40 cm*
G *Gender (male)*

Basic Nordic Sleep Questionnaire (BNSQ) provides a five-point scaling to determine sleep apnea. Habitual snoring is considered along with the stress level indicated by the person. The scaling range used for the sleep apnea detection is as follows [5, 60].

- I Never or less than once per month
II Less than once per week
III On 1-2 nights per week
IV On 3-5 nights per week
V Almost every night

4. Preprocessing and Decomposition

Filtering, windowing, and sampling are the most widely used preprocessing techniques. The above section has highlighted different signals that are used for the analysis of sleep apnea. Various filtering methods have been used for effective utilization of the signals for the later stages of signal processing

and thereby improve the efficiency of diagnosis. This section spotlights the preprocessing techniques used in the study.

Low pass filters and bandpass filters are the commonly used filtering techniques for removing spurious noise due to motion artifacts and interferences. The signals are usually sampled at a sampling rate of 200 Hz and segmented for further analysis. The windowing technique used to segment the waveforms is min by min or sec by sec [61–63]. The sample length/window size is chosen in accordance with the type of features to be extracted. The entropy function has been predominantly used for feature extraction [62]. Bandpass Chebyshev filter II is applied on the PhysioNet apnea database, in addition to the preprocessing stages viz., filtering, denoising, and segmentation of the signal. A weight calculation algorithm is utilized for noise removal, in which each segment is assigned a weight, and segmentation of the signal is carried out through the thresholding technique [64]. Song et al. [65] have used the Markov model for segmentation of ECG signals, from which, QRS wave and the RR interval are identified. A median filter and a windowing technique show better results for the min-by-min extraction of the signal [18, 66]. The wavelet transform (WT) translates the signal duration of the signal to represent the frequency of time combined as a set of wave coefficients. These wavelet coefficients can be used in a frequency-dependent manner to achieve various digital signal processing results. Wavelet transform decomposes the signal into a set of low frequency coefficients and high frequency coefficients [7, 67]. The advantage of using wavelet transform is due to the fact that the value of SNR is quite high, and the filtering effect is better with high precision [45, 68–70]. Tunable Q Wavelet transform (TQWT) has been used to analyze oscillatory signals which deals with three flexible parameters: Q factor, number of decomposition levels, and redundancy or sampling rate. The transfer functions used in TQWT are rational [7]. Nasal airflow signals obtained from 100 subjects are randomly selected, and the Haar Wavelet function is employed which is an orthogonal wavelet, and its transfer function is redundant. In the initial stages of decomposition, the signal appears to be square-shaped while in the later sections, segments of the signal are obtained [31, 71]. From these segments, statistical coefficients are extracted for further analysis [31]. Pan–Tompkins algorithm is the widely used technique for the efficient extraction of QRS complex from the ECG signal. QRS complex waveform occurs due to ventricular depolarization, which is represented as a spike waveform. Pan–Tompkins algorithm highlights the frequency variation, indicating the spikes, and uses a series of filters to highlight the common content of this rapid heartbeat and remove background noise in the signal [72]. The block diagram of the algorithm is illustrated in Figure 4.

Previous studies reveal that EDR signals and RR interval signal carry important information for OSA diagnosis. A median filter which is a nonlinear filter, where the output sample has been calculated from the median value of the input signal is utilized by [18, 65, 66, 73–75]. Along with the output from the Pan–Tompkins algorithm, local median filter responses are used to extract RR interval data from the ECG signal [75, 76]. Other preprocessing

techniques are also discussed in this study; however, they are more likely to be a stand-alone system. Few of such algorithms are discussed in detail.

- (a) Multistate General Gamma Cumulative Sum Scheme (CUSUM) [68]
 - (i) The amplitude of the extracted signals is investigated, and the gamma distribution is taken
 - (ii) Two assumptions are made based on homogeneity and likelihood
 - (iii) The cumulative sum of parameter shift in both the assumptions is considered, and the mean and variance of the signal are obtained
 - (iv) The main feature of CUSUM was to obtain a cumulative sum of the sample deviations
- (b) State-space reconstruction, heterogeneous recurrent analysis [77]
 - (i) Characterized by nonlinear function, $dx/dt = F(x, \theta)$, where F is nonlinear function and θ is the model parameter
 - (ii) State-space reconstruction is performed, and the signal is segmented
 - (iii) For iterative segmentation, a multidimensional indexing method is implemented
 - (iv) A categorical variable is assigned to each segment, and by identifying the similarity patterns, the heterogeneous recurrence is recognized
 - (v) This method is evaluated by Principal Component Analysis (PCA)

Several other signal processing techniques such as discrete wavelet transform (DWT), empirical mode decomposition (EMD) [78], variational mode decomposition (VMD), and empirical wavelet transform (EWT) for signal denoising and feature extraction have been considered. Of all the comparative methods used for filtering and windowing, simple bandpass filters are more preferred due to its efficiency in preserving information related to OSA, and WT gave a prominent result not only for denoising but also for the extraction of features [67].

5. Feature Extraction

This section summarizes the investigations on feature extraction and optimization for OSA detection. Time-domain, frequency-domain, nonlinear, and statistical features are considered more relevant in sleep apnea findings. After denoising, decomposition, and segmentation of the acquired signals, feature extraction plays a vital role in classifying signals. The features extracted based on the input signal viz., RR interval signals, ECG-derived respiration (EDR) signals, heart rate variability (HRV), oxygen saturation

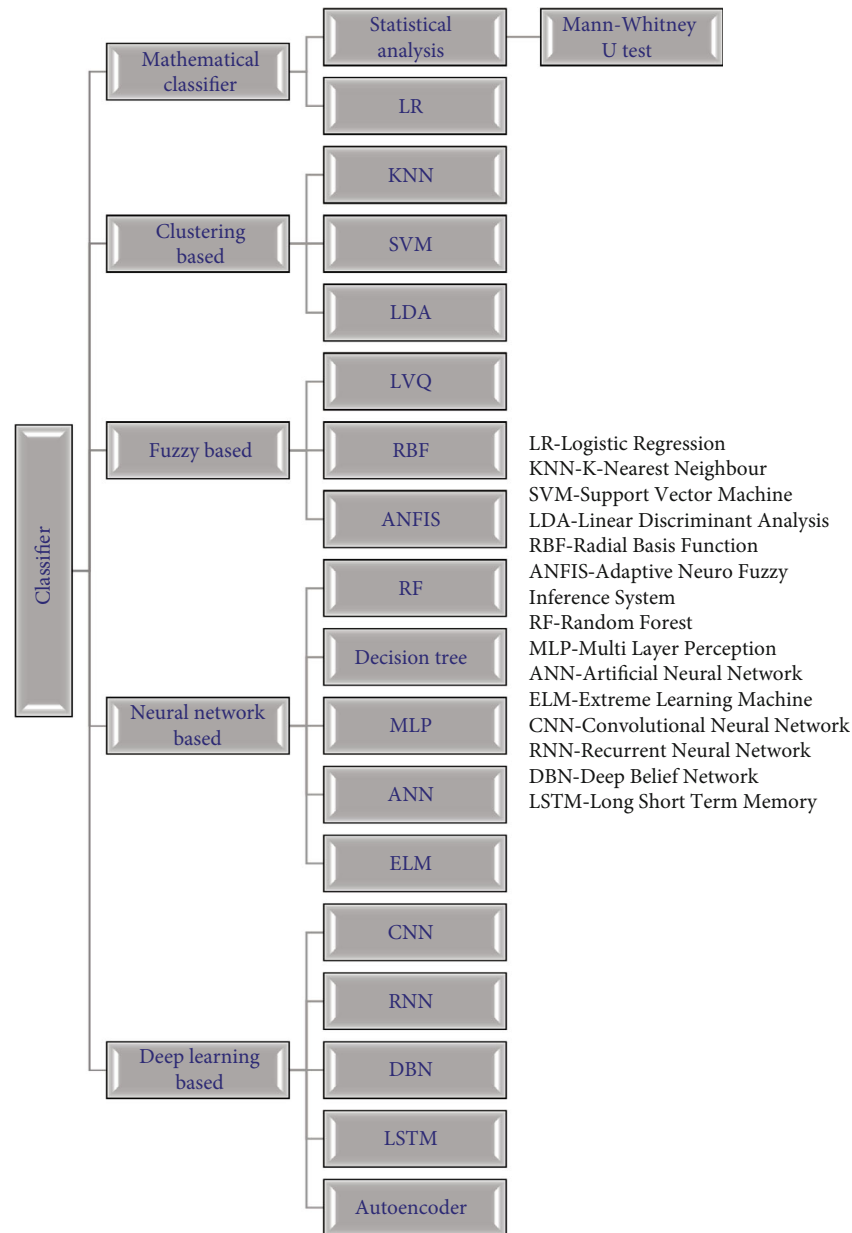

FIGURE 5: Summary of classifier models used in the study.

signal (SpO_2), blood gas or blood oxygen saturation (SaO_2), and autocorrelation function (ACF), are primarily extracted by a majority of authors. The time-domain features included in the study are (i) the difference in the root mean square of RR peak amplitude; (ii) the time interval between the former and latter HRV signal not exceeding 50 milliseconds; (iii) standard deviation of HRV signals; (iv) the mean, variance, and kurtosis of ECG signals; (v) mean of ECG signals, and (vi) variance coefficient [22, 79–86].

Most of the frequency domain features are extracted using WT, as WT uses a multiscale basis, and it is advantageous over Fourier transforms. The varying window size is taken for nonstationary signals, hence providing a better extraction of features [87, 88]. Statistical feature analysis is implemented to identify errors that are not identified during

the initial stages of signal processing. The attributes in the signal are identified using three tests, Kolmogorov–Smirnov test, t -test, and Mann–Whitney U test [5].

Empirical mode decomposition (EMD) and Bivariate are adopted to evaluate the output of EEG signals. EMD performance improved significantly when the number of samples decreased [89]. The segmental error analyzed in event-related potential (ERP) indicated the occurrence of apnea. The delta energy associated with the immune system and the regulation of homeostasis is due to the depletion of oxygen in the event of apnea. Using the Hilbert Huang Transform, there is a wave of force in low waves when apnea occurs. This can be linked to delta energy related to the immune system and the regulation of homeostasis. The EMD and Bivariate methods were compared to reflect the

TABLE 2: Summary of features extracted.

Input signal	Features extracted
SpO ₂	(i) Desaturation events
	(ii) Speed of decline of SpO ₂ concentration
	(iii) Time domain features such as regularity, variability, flexibility, and complexity
	(iv) ODI indices
	(v) Frequency domain features such as PSD
	(vi) Minimum and mean SpO ₂ values
ECG	(i) R-R intervals
	(ii) R-peak amplitudes
	(iii) EDR
	(iv) HRV features
	(v) Statistical features like mean, kurtosis, variance, and skewness
	(vi) Mean heart rate
Nasal, respiratory, tracheal, and abdominal	(i) Length of respiratory signals
	(ii) HRV
	(iii) Respiration rate variability
	(iv) Temporal and spectral characteristics of acoustic signals
	(v) Time-series features including mean, variance, minimum, maximum, and median values
	(vi) Minimum, maximum, average inspiration/expiration amplitudes, and durations of nasal airflow signal
EEG	(i) Demographic information–frequency, percentage of every sleep stage, time in bed, total sleep time, sleep efficiency, and total number of one-step transitions overnight
	(ii) Speech/voice analysis
Speech	(i) Time-domain and frequency-domain features

key features associated with apnea for analytical purposes [31]. In a study on nonlinear feature extraction methods, three parameters are extracted: (i) the length of the longest diagonal, (ii) recurrent points needed to construct the diagonal lines, and (iii) percentage of recurrent lines to shape the vertical lines [8]. Multidomain feature extraction utilizes a combination of feature extraction methods and signal processing algorithms. Comparing the feature extraction methods and the features extracted, RR series signal and HRV data are extracted from PSG signal and ECG waveforms, Oxygen-related features from SpO₂ and SaO₂ signals and the rest of the features are extracted using the above-mentioned feature extraction strategies.

Automatic data handling has been proposed to handle electrical impedance tomography (EIT) images. EIT measurement is done invasively for the measurement of the

upper airway during normal sleep. The upper airway closure signal is extracted as a feature along with statistical analysis. The features are analyzed by one-way analysis of variance (ANOVA) test, where the patients' features are displayed as a box and whisker plots and heat map clusters [87]. Mostafa et al. [47] extracted seven features from SpO₂ signal using genetic algorithm. Genetic algorithm shows prominent results in the feature extraction arena and in classification. The summaries of features extracted for sleep apnea detection using various physiological signals are tabulated in Table 2.

6. Feature Selection

The role of feature selection is to reduce the redundancy in data and to reduce the time required to train the network. However, due to the redundancy, the accuracy of the classifier could be increased. Hence, feature selection plays a significant role in the classification stage. Li et al. [8] employed a two-stage procedure for feature selection. Initially, statistical analysis is done followed by SVM selection. Another method of feature selection has been carried out by combining the weighted average of the histogram. The weighted histogram features are combined from the Gabor filter bank, and they are represented as a feature network. This work is signatored as feature concatenation [90]. Minu and Amithab [45] used a mutual information-based feature selection to avoid redundancy and to increase the relevance. The mathematical expression has been defined as the joint probability to that of the marginal probability.

In a peculiar feature selection technique proposed by García et al. [23], the partitions of signals that are counted to train that the network is split into two groups and are labelled as count_train and count_test. By this way, the dataset is partitioned to select the appropriate features required for apnea detection. The feature selection is done through two phases: in the initial stage, sequential forward feature selection method is adopted, and the features are ranked based on the number of times they have been included in the dataset. In the second stage, the selection method is repeated 250 times, and the error rate is calculated based on the feature set [91]. The step wise feature selection is done through Leave-One-Out Cross-Validation (LOOCV) where the insignificant features are ruled out, preventing the risk of incorrect deletion [18]. A total of fifteen features are selected, and the network is trained with $N = 4$ times, resulting in four error estimations, and successively eight most discriminating features are selected. A linear classifier is used for the feature selection process [38].

The relevant and nonredundant variables are dimensionally reduced using Fast Correlation-Based Filter (FCBF) technique. In the initial stage, log criterion is applied, followed by removal of redundant features. The symmetric uncertainty is calculated for each of the features by ranking using discriminant relevance (DR) method. Based on the rank obtained by them, the features are either selected or removed [36]. DR method is also used for feature ranking and selection. In this method, the discriminatory power of the model using all the features is compared with one feature

that is under study. Equation (1) defines the formula used to calculate DR.

$$DR_i = \frac{AUC_0 - AUC_i}{AUC_0 - (1/2)}. \quad (1)$$

7. Classification

Physiological signals often contain a great deal of information necessary for disease detection, though they contain noises and artifacts. In recent years, computer-aided diagnosis (CAD) for healthcare applications has been gaining advantage [92, 93]. Various machine learning and deep learning algorithms have been used for the detection and classification of sleep apnea. From Figure 5, it is evident that neural network-based classification is predominantly used for classification and identification of apneic events. Long short-term memory (LSTM) networks yielded a higher accuracy of 99% [61, 94, 95], followed by random forest (RF), support vector machine (SVM), K-nearest neighbor (KNN), Adaboost, linear regression (LR), and ANFIS classifier with accuracy around 97% [18, 45, 80, 96–98]. The average accuracy of other classifiers is around 95%. Most of the classifiers used data from the PhysioNet Apnea-ECG database [19, 21]. The accuracy varies depending on the feature extraction and the feature selection strategy.

7.1. Mathematical Classifier. The upper airway signal along with the closure of the eye lids is also considered for the sleep apnea detection. EIT data is collected from patients using swallowing maneuver. The PSG and the EIT signals are compared based on Bland-Altman plots and the Pearson correlation [87]. To identify the significant features representing the apnea, statistical analysis is done on the control groups. The most prominent test is Mann-Whitney U test (UMW), which is a nonparameter test similar to that of t -test. It is marked by the difference in the median of the ranked data representing individual groups. The performance of the network is analyzed on voice-based network [99], and statistical analysis is done using LR. In a logistic model, considering two predictors, x_1 and x_2 and the output variable Y , the linear relationship in mathematical form is given in

$$l = \log_b \frac{p}{1-p} = \beta_0 + \beta_1 x_1 + \beta_2 x_2. \quad (2)$$

Here, l are the odds in the classification, b is the base of \log , and β_i is the model parameter. p is the probability function and is given in

$$p_{ap} = \frac{1}{1 + e^{-(\beta_0 + \beta_1 x_{i1} + \dots + \beta_p x_{ip})}}. \quad (3)$$

Equation (2) gives the model description of LR. The advantage of LR is that it does not require multivariate assumption [39, 77, 100].

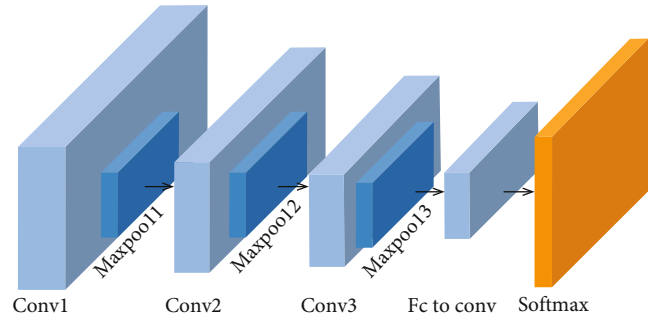

FIGURE 6: Basic architecture of CNN.

7.2. Clustering-Based Classifier. The clustering-based classifier that has been discussed in this study includes SVM, KNN, and LDA where the highly preferred classifier is support vector machine (SVM). The major purpose of classification is to indicate the category of the input signal to which it belongs to. SVM is a supervised learning method which is used for classification and regression challenges. The main advantage of using SVM is its effectiveness in identifying the number of dimensions when there is limited number of data samples or images [101]. AI-Ratrou and Hossen [102] used SVM along with fivefold wavelet decomposition using db1 filters for the classification of sleep apnea. By this method, 100% accuracy is obtained. Kumar and Kanhangad [90] have proposed a novel method to obtain single dimensional and phase descriptor (PD) model from ECG lead form. These PDs are extracted from Gabor filter responses and are fed to SVM. The type of SVM classifier used in this study is least square SVM. They are effective in the discrimination of normal and apneic signals with an accuracy of 93.31%. In the study that involved RR interval series for the classification of sleep apnea and using SVM as the classifier, the average accuracy achieved is 92.05%. The performance of SVM was compared with linear regression (LR), linear discriminant analysis (LDA), neural networks (NN), and K-nearest neighbors (KNN), of which SVM proves to be the best classifier [16, 65, 66, 68, 103]. Standard statistical features extracted have also proven to be effective in the classification of sleep apnea. Kumari et al. [96] have extracted only statistical mean from the signal and, using the SVM classifier, has achieved an accuracy of 98%, and the result is compared with KNN.

In the case study where HR signals are used for the classification purpose, the accuracy achieved is 82.12% using SVM [104], while heart rate variability signal extracted using wavelet decomposition claimed to have an accuracy, sensitivity, and specificity of 93.34%, 90%, and 100%, respectively [102]. In few cases, KNN outperformed SVM; by using the oxygen saturation signals as the input, KNN achieved a maximum accuracy of 93% and, in collaborative performance along with least square SVM, achieved an accuracy of 86% [17]. Another interesting classifier that is used by majority of the researchers is LDA. Linear combination of features that specifies an object is extracted using LDA, and it is used to separate two or more classes [105].

LDA basically is developed to overcome the limitations faced in LR. The advantage of using LDA is that samples

without class labels can be used under the LDA model. On the other hand, the problem faced with LDA is that it can only be used for binary classification and is not intended for multiclass classification. Hence, classification of stages of sleep apnea cannot be done using LDA. To overcome this problem, CNN is considered as the best option for the classification of stages of sleep apnea considering that the data available is sufficiently large. Benavides et al. [99] extracted features like signal-to-dis-periodicity ratio, a nasality measure, harmonic-to-noise ratio, jitter, difference between third and second formants on a specific vowel, duration of two of the sentences, and the percentage of silence in one of the sentences for classification of OSA using LDA. The accuracy achieved is 85%, and specificity is 75%. García et al. [23] extracted the time and frequency domain variables from blood oxygen saturation and used LDA for the classification. The classification accuracy obtained is 87% with sensitivity of 76% and specificity of 91%. In another study, González et al. [91] extracted heart rate variability signal and used three different algorithms viz., LR, LDA, and quadratic discriminant analysis (QDA) for the classification of OSA. LDA outperformed both the classifiers with an accuracy of 84.76%, sensitivity of 81.45%, and specificity of 86.82%.

The respiratory features extracted by phase space reconstruction (PSR) feature extraction method along with RR signals and heart rate signals are given to the classifier. Five different classification networks such as LD, KNN, SVM, ANN, and QD are used for the classification. The performance of the classifier is evaluated by cross-validation function and by training them independently. By using thirty extracted features, the accuracy, sensitivity, and specificity of the work are found to be 90.9%, 89.6%, and 91.8%, respectively [66].

7.3. Neural Network-Based Classifier. Random forest was grown with 18 features, of which five important features are selected with three different time intervals. It generates replications of data, and for each replicated data, the network is trained. Each node is split based upon the randomly chosen features. This work has been carried out for the purpose of “in-home detection of sleep apnea” [25]. The time domain, frequency domain, and time-frequency and the wavelet features are extracted from SpO₂ signals and are fed to artificial neural network (ANN) classifier. According to the thumb rule, the number of features required to train the network must be ten times larger than the weights of the network. The optimization of the network is performed using genetic algorithm (GA). The classification error has been reduced by implementing genetic algorithm. ANN model along with GA can yield better accuracy of 97.7% [47]. Extreme learning machine (ELM) is feed forward neural network that can be used for regression, classification, clustering, and feature learning. The input layer is randomly chosen, and the hidden parameters are set, and the output weights are determined analytically. The nonlinear activation function that is used along with ELM is sigmoid, sine, and hard limit. The proposed method using ELM and statistical feature extraction has shown an accuracy of 83.77% compared to the conventional method using wavelet features [106].

In another model designed for in-home monitoring of sleep apnea using the signals from pulse oximeter, the features are fed to Bayesian MLP-NN. The statistical analysis of the data is done using Kolmogorov-Smirnoff and Levene tests. The nonparametric Mann-Whitney U test is also done to identify the significant differences in the features [36]. The ANN along with the wavelet transforms is used for the detection of sleep apnea from EEG signals. The network has been configured to give three outputs referring to the condition of sleep apnea syndrome (SAS). Three different techniques are considered: Characteristic Part Analysis (CPA), Continual Characteristic Segment Analysis (CCSA), and Characteristic Segment Part Analysis (CSPA) [69].

7.4. Fuzzy-Based Classifier. Minu and Amitabh [45] used wavelet transform for the initial stages of signal processing, and ANFIS classifier is used for the classification of sleep apnea. Adaptive neuro-fuzzy inference system is a fuzzy model that which is been adapted for learning. The architecture of ANFIS consists of five layers/nodes. These nodes are referred as fixed nodes and adaptive nodes. The first and fourth layers have adaptive nodes, while second, third, and fifth layers have fixed nodes. ANFIS gives a better accuracy when compared to Adaboost classifier. The architecture of ANFIS is represented in Figure 6 where x and y represent the input and f represents the output. There are 5 distinct layers in the ANFIS architecture. Every node in the layer 1 is an adaptive node with an adaptive node function, and A1, A2, B1, and B2 are linguistic labels. Every node in layer 2 is a fixed node, labelled as M , whose output is the product of all the incoming signals. Each node output represents the firing strength of a rule. Every node in the third layer is a fixed node labelled as N , and it calculates the ratio of the firing strengths to the sum of all the rules firing strength. Every node in the fourth layer is an adaptive node with a node function. The single node in this layer is a fixed node labelled S , which computes the overall output. The overall output is the summation of all the incoming signals. The overall output is given in

$$\text{Overall Output} = O = \frac{\sum_i w_i f_i}{\sum_i w_i}, \quad (4)$$

where w_i corresponds to the weights or the output from each layer and f_i is the output from layer 4.

SVM along with Gaussian Radial Basis Function (RBF) kernel is employed for the classification of sleep apnea by selecting the features from LOOCV. The RBF kernel-based model is compared with the performance of Hidden Markov Model (HMM). The fuzziness in the fuzzy set is determined by membership function (MF), and the shapes of MF are significant as they affect the interference of the fuzzy system. These shapes might include triangular, trapezoidal, Gaussian, etc. The main condition satisfied by MFs is the value ranges between 0 and 1. Tahani et al. introduced Sugeno λ -measure technique for extraction of effective fuzzy measure. Mukherjee et al. [107] used ensembled network method and Choquet integral-based fuzzy fusion technique for the identification of sleep apnea. The network combines

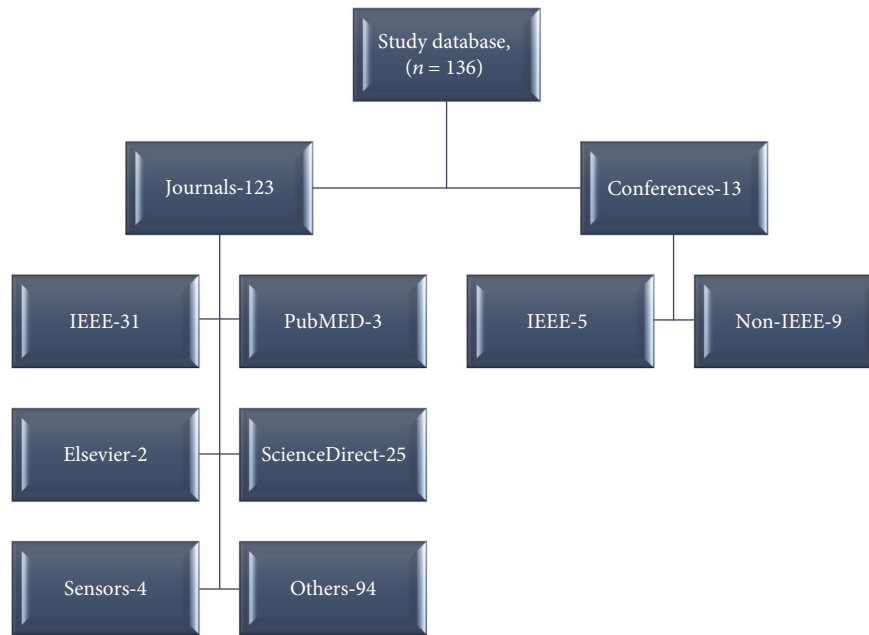

FIGURE 7: Articles reviewed on OSA detection over the period of 2014 to 2021.

the confidence values and all the possible combinations of data. For each classifier, individual weights are designed, called the fuzzy measures. The fuzzy measure is calculated using the entropy of the classifier's probability vector. The entropy value is subtracted from the maximum entropy value. The fuzzy measure is divided by the sum of total fuzzy measures. Hence, the fuzzy measure is evaluated based on the Sugeno λ -measure technique. The advantage of using fuzzy-based classifiers is that the computation power is saved, and they are often robust. They are not sensitive to the changing environments and often forget the rules (erroneous). They have less development time when compared to other conventional methods.

7.5. Deep Learning-Based Classifier. The major layers in CNN are convolutional layer, pooling layer, and fully connected layer. The layers of CNN are modified according to the input signals and the target. In addition to CNN, other deep learning models are recurrent neural network (RNN), auto encoder-based classifier, and deep generative models. Figure 6 shows the basic CNN architecture which consists of three main layers: the convolutional layer, the max pooling layer, and the SoftMax layer. The CNN is used for both feature extraction and classification, and few articles showcase the significance of CNN in segmentation also. Depending upon the size of the signal used for the analysis, dropout layer is introduced to reduce the problem of overfitting. The activation functions used are unique for the input signal and are based on the researchers. The most commonly used activation function is ReLU and SoftMax activation. However, the optimizer depends on the training accuracy of the network. Erdenebayar et al. [108] used deep belief network (DBN) to classify the sleep apnea using SpO₂ signals. It consists of three layers among which the first two layers are constructed using restricted Boltzmann machine (RBM), and

the final layer is SoftMax layer. Mostafa et al. (2017) have proposed an unsupervised auto encoder, where each of the stacks of RBM is used as auto encoder. The outputs obtained correspond to the input of the decoder. The unsupervised technique proved better results when compared to feature-based technique. Pathinarupothi et al. [94] used LSTM-RNN (long short-term memory recurrent neural network) for the diagnosis of sleep apnea from a single sensor technique. The proposed architecture has three layers: 30 input neurons, 34 memory blocks in the hidden layer, and two neurons in the output layer. Each memory block has memory units to store information over a long range of sequences.

Yildirim et al. [13] used a one-dimensional CNN network for the classification of sleep apnea, considering EEG and EOG signals. Similarly, Haidar et al. (2016) used statistical features for training CNN and SVM, of which CNN yielded an accuracy of 75% to that of SVM. In general, the comparison of machine learning to deep learning algorithms is not appreciated because deep learning always outperforms the former [13]. Mostafa et al. (2017), Pathinarupothi et al. [94], Leino et al. [43], and Yildirim et al. [13] used deep learning-based algorithms for the classification of sleep apnea. Table 3 summarizes the available performance metrics of the deep learning algorithms and other related algorithms used for the detection of sleep apnea. Cheng, Maowei et al. [109, 110] used recurrent neural network (RNN) for the detection of sleep apnea. The extracted features are fed as input to RNN, and this layer produces the output for the final detection of sleep apnea. The accuracy of RNN model is 97.80% at the 50th training epoch. The increase in the number of epochs has increased the accuracy of classification, but the accuracy of classification remains unchanged after 50 epochs.

The classification of sleep apnea is carried out by analyzing ECG signals, SpO₂ signals, PSG signals, nasal, and

TABLE 3: Deep learning networks.

Author and citation	Classifiers	Database (DB)	Signals	Acc.%	Sen. %	Spec.%	Others
Song et al. [18]	CNN-LSTM	Apnea-ECG DB	ECG	96.1	96.1	96.2	Recognition rate—94.39
Zhang et al. [112]	CNN-LSTM	Apnea-ECG DB	Lead II ECG	99.80	96.94	98.97	
Novak et al. (2018)	LSTM	Heart rate signals	HR	82.1	85.5	80.1	
Yin et al. [70]	CNN-LSTM	Apnea-ECG DB UCD DB	ECG	97.21 93.70	94.1 90.69	98.94 95.82	
	LSTM			87	84	91	
Shen et al. [113]	3-layer CNN	Snoring sound	Respiratory and tracheal sounds	85	82	81	
	5-layer CNN			82	83	84	
Morgan and Scofield [114]	CNN-LSTM	Apnea-ECG DB	ECG	85.58	—	88.26	Recall—84.43
Pinho et al. [104]	LSTM-RNN	MIT-BIH arrhythmia DB	Lead II ECG	99	—	—	AUC—0.98 Precision—99.2 Recall—92.9
Faust et al. [115]	LSTM	Apnea-ECG DB	ECG	99.80	99.85	99.73	
Pinho et al. [104]	Bi-LSTM	PSG and respiration signals	SpO ₂ , PSG, and respiratory signals		90.3	83.7	
	DNN			93.1	9.	94	
	1D-CNN			98.5	99	99	
Acharya et al. [116]	2D-CNN	Nocturnal ECG recordings	ECG	95.9	96	96	
	RNN			85.4	97	87	
	LSTM			98	98	98	
	GRU			99	99	99	
AI-Ratrou and Hossen [102]	LSTM	Sleep-heart-health-study-1 DB	ECG and HR	98	—	—	
Wu et al. [75]	1D-CNN	EEG and EOG signals	EEG, EOG	97.62	94.34	92.33	
Song et al. [18]	RNN	Measurements from eight healthy subjects (EMG signal)	EMG				
Zhai et al., 2017	CNN	NinaPro DB	EMG	83			
Acharya et al. [117]	CNN	Freiburg EEG DB	EEG	88.67			
Kalkbrenner et al. [27]	CNN	EEG and rs-fMRI measurements from the ECoG dataset [118]	EEG	—	—	—	Normal p value $1.85e-14$, p seizure value $4.64e-27$
Hassan [7]	CNN	37 subjects, 70 sessions	EEG				Area under the receiver operating characteristics: 82.78
Acharya et al. [116]	CNN	MIT-BIH arrhythmia DB	ECG	92.50	98.09	93.13	
Tran et al. [119]	LSTM, CNN	PhysioNet DB: Fantasia (normal) and St.-Petersburg Institute of Cardiology Technics (CAD)	ECG	99.85			
Hafezi et al. [111]	CNN	PhysioNet DB: Fantasia (normal) and St.-Petersburg	ECG	94.95 95.11	—	—	

TABLE 3: Continued.

Author and citation	Classifiers	Database (DB)	Signals	Acc.%	Sen.%	Spec.%	Others
Pourbabaee et al., 2017	CNN	Institute of Cardiology Technics (CAD) The PAF prediction challenge	Two-channel ECG				Precision—93.6
Rosenwein et al. [25]	Stacked denoising autoencoder	Fetal-ECG signal reconstruction	ECG	99.5	—	—	
Singh et al. [49]	CNN	EOG, EEG, ECG—6 subjects and 2 sessions each	EOG, EEG, ECG	93.8			
Shen et al. [113]	CNN	22 subjects and 22 sessions each	EOG	—	—	—	Mean correlation coefficient—0.73
Zhang et al. [112]	Feature extraction with DNN, classification by SVM	Apnea-ECG DB	ECG	84.7		94.5	Recall—68.8
Morales et al. [17]	DBN	Apnea-ECG DB	ECG	97.64	78.75	95.89	
Yin et al. [70]	LSTM-CNN	70 subjects	PSG	100	100	100	
Jifara et al. [51]	CNN-LSTM	Apnea-ECG DB	ECG	99.80	96.94	98.97	—
Chaw et al. [120]	CNN	50 patients—SpO ₂ values were obtained	SpO ₂	91.31			Loss rate -2.3 using cross-entropy cost function

tracheal sounds and by taking the AHI index. The cross validation of the acquired data is done using the databases. Deep learning-based network has proved efficient in the classification and detection of sleep apnea. The design of CNN architecture plays a vital role in achieving the accuracy of the network. Acharya et al. (2017) used ECG signals as the input and constructed a 9-layer CNN network and evaluated the performance with and without noise removal. Data augmentation performance has also been evaluated. The accuracy achieved is 94.03% with data augmentation and 89.07% with the original data. Chaw et al. (2019) designed a 10-layer CNN network to classify the SpO₂ signals for sleep apnea detection. The layers included are 2D-CNN, flatten layer, dense layer, and dropout layer. The proposed network is compared with different types of classification networks such as LDA, SVM, bagging rep tree, and ANN. The CNN is based on cross-entropy cost function-based network. The overall accuracy of the network is 91.38%.

Hafezi et al. [111] identified OSA by using tracheal and abdominal movements. The CNN model consists of seven layers with 128 hidden units in LSTM. The performance of the classifier is evaluated based on Pearson or Spearman's correlation coefficient, Bland-Altman Test, and Kruskal-Wallis one-way analysis of variance, to compare the values of AHI signals. The sensitivity, specificity, and accuracy of diagnosis are 81%, 87%, and 84%, respectively. Single-channel ECG lead signals are acquired and analyzed using CNN-LSTM network. The Kappa coefficient value of CNN was 0.89, to that of CNN-LSTM network was 0.92 [112].

Erdenebayar et al. [108] diagnosed sleep apnea by using four different deep learning architectures. Their performance has been evaluated based on sensitivity, specificity,

and accuracy. 1D-CNN exhibited an accuracy of 98.5%, 96.4%, and 96.3% for apnea, hypopnea, and AHI events. The accuracy of LSTM network is 97%, and significant difference is found in the performance of 1D-CNN and 2D-CNN. At least 20 iterations are required to achieve the maximum performance of LSTM and Gated Recurrent Unit (GRU) models. 1D-CNN and GRU models are preferred for the automatic detection of sleep apnea using time domain features. Table 3 gives the summary of deep learning networks used and the number of layers specified in the architecture. The performance metrics are compared in the best possible way to identify the best architecture in the diagnosis of OSA.

Ensemble networks are also utilized for OSA diagnosis, and the network techniques used are based on (i) majority voting, (ii) sum rule, (iii) Choquet integral based fuzzy fusion, and (iv) trainable MLP. Maximum accuracy of 85.58% is achieved using MLP technique. To the preexisting CNN model, the “flatten” layer is introduced to increase the diagnostic accuracy. The ensemble technique has two broad approaches, viz., for decision level fusion, only one decision is considered for each class, and for the score level fusion, for each model, all the prediction scores are considered. Data augmentation is done to increase the number of training samples. The trainable ensemble network using MLP has achieved precision of 84.80, recall of 84.43%, F1 score of 84.67%, and specificity of 88.26% [107].

7.6. Performance Metrics. The performance metrics that are used for the evaluation of the performance of the classifier are accuracy, sensitivity, and specificity. In addition to this, the mean absolute error (MAE) and the Pearson linear

correlation coefficient (CC) are also considered for the estimation of values of Apnea-Hypopnea Index (AHI) [34]. The other performance measure includes F1 measure, kappa, precision, and recall [31, 80, 121].

Accuracy refers to the closeness of the obtained result to that of the standard value. It has been calculated by measuring the true positives (TP), false positives (FP), true negatives (TN), and true positives (TP) using Equation (5). Sensitivity and specificity are calculated using Equation (6) and Equation (7), respectively. The recall can be calculated from Equation (8) and precision from Equation (9). F1 measure of F1 score can be derived from recall and precision. The best value for F1 score is 1, and the worst is 0. Equation (10) gives the formula to calculate F1 score. Kappa is generally calculated in ensemble networks. It is used to quantify the degree of agreement. It is expressed in Equation (11), where $\Pr(a)$ is the proportion when there is an agreement and $\Pr(e)$ is the proportion of units that is expected to be agreed.

$$\text{Accuracy} = \frac{TP + TN}{(TP + TN + FP + FN)} * 100, \quad (5)$$

$$\text{Sensitivity} = \frac{TP}{(TP + FN)} * 100, \quad (6)$$

$$\text{Specificity} = \frac{TN}{(TN + FP)} * 100, \quad (7)$$

$$\text{Recall} = \frac{TP}{TP + FP}, \quad (8)$$

$$\text{Precision} = \frac{TP}{TP + FN}, \quad (9)$$

$$\text{F1 measure} = 2 * \frac{\text{Precision} * \text{Recall}}{\text{Precision} + \text{Recall}}, \quad (10)$$

$$\text{Kappa} = \frac{\Pr(a) - \Pr(e)}{1 - \Pr(e)}, \quad (11)$$

$$\text{Recall} = \frac{TP}{TP + FP}.$$

Jung et al. [42] used real-time automatic detection of apnea using nocturnal pulse oximetry signals. The performance has been evaluated using accuracy, sensitivity, specificity, positive predictive value (PPV), negative predictive value (NPV), Cohen's Kappa coefficient, and ROC-AUC (area under the receiver operating characteristics curve). The AUC was calculated through true positive rates (TPR) versus false positive rates (FPR). The true positive rate is calculated in

$$\text{TPR} = \frac{TP}{TP + FN}. \quad (12)$$

The AUC is calculated by Equation (10).

$$\text{AUC} = \int \text{TPR} d(\text{FPR}). \quad (13)$$

8. Inferences from the Survey

All through the comprehensive literature review, the state-of-the-art technology used in signal acquisition, signal pre-processing, feature extraction, and classification techniques that influence the automated computer-aided diagnosis of the OSA has been elaborately discussed. The growing interest in the arena of sleep studies and their therapeutic measures has resulted in advances in computer-based analytical methods, contributing to the increase of the number of developments in the sleep sector over the period of 10 years. The objective of the survey is to encourage young researchers interested in the development of computer-aided diagnostic techniques of OSA. The term diagnosis has to be preferably denoted as the potentiality of the computer-based methods to expropriate the severity of OSA based on AHI index. The American Academy of Sleep Medicine has clearly stated that the diagnosis of OSA cannot be exclusively based on AHI index, rather would require additional systematic analysis based on the symptoms [79].

From the literature analysis, it is noted that the so-called CAD approaches are more focused on two significant aspects. One trend is aimed at reducing the time required in monitoring multiple parameters as in the case of PSG studies, which is performed overnight in an attended hospital environment [5]. On the other hand, the emergence of sophisticated signal processing algorithms and predictive classifiers has paved way for a break-through for automatic detection of OSA. Although reducing the number of signals to be monitored has a significance in terms of reduced costs, increased patient comfort, and reduced waiting lists, yet, manual analysis of still images as in the case of PSG is more complex and time consuming. For this purpose, automation of the screening process is more preferred.

Based on the analysis carried out in the previous sections, Figures 1–8 and Tables 1–3 deliberately present a quick summary of different methodologies covered. In particular, Tables 3 enlists the type of signals used, a number of signals used for the study, and the performance metrics of different classification approaches for reference and comparison purposes. It is well understood that usually validation results are significantly based on the database used, demographic details of the study group, number of subjects, number of signals used for training, etc., and on the type of validation metrics used. Changes that are made in the recording setup and changes in the criteria used for measuring the score or in the validation metrics make it demanding to carry out meaningful comparisons among the different methods.

After a collective analysis of the literature survey carried out in this work, majority of the authors have opted for dataset from PhysioNet Apnea-ECG database along with publicly available questionnaire. This is due to the difficulty in acquiring real-time data and availability of patients. While

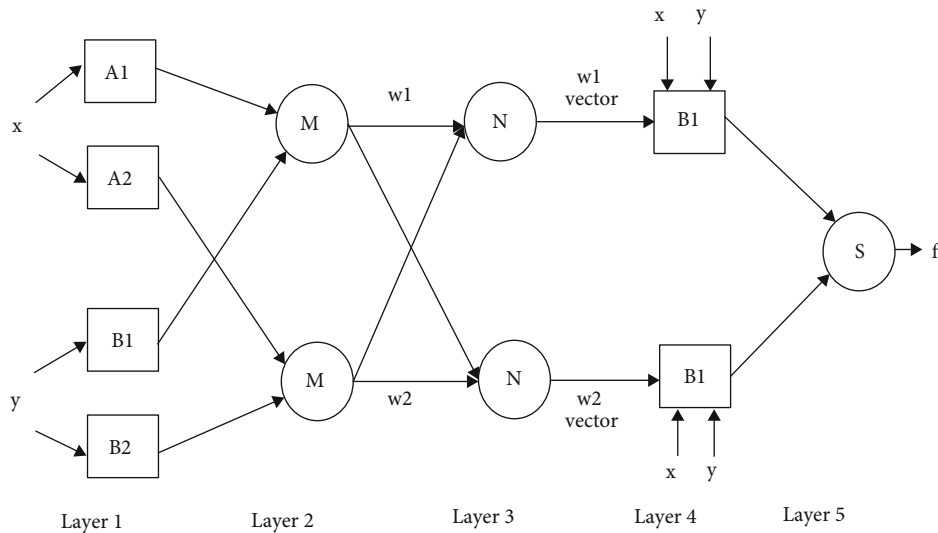

FIGURE 8: Architecture of ANFIS.

sleep study is conducted in hospitals, the major challenge faced is the ethical concern. Moreover, these data are always imposed with noise and artefacts. A proper noise removal method is needed to make the signal to be an effective one and also to make the signal camera ready for feature extraction and classification. Concerned with the next stage, few authors have decomposed the signal for faster analysis, where ECG waveform is normally segmented for every one-minute time duration. Pan-Tompkins algorithm is predominantly used by the researchers for obtaining the information of QRS complex in ECG waveform. Due to the high precision filtering, wavelet transforms are highly preferred.

All new technologies emerging today have their pros and cons. When compared with sleep apnea monitors, overnight acquisition of signals is a tedious task and also considered as a challenging one. The major advantage of using nocturnal polysomnography is it helps in the monitoring of the heart, lungs, brain, breathing pattern, leg, and arm movements. The disadvantage is that the patient gets hooked up with wires and sensors, which would cause lot of discomfort to the individuals, and most of the patients have to repeat the test again on account of improper sleep. In the feature extraction stage, RR interval signals are extracted mostly from ECG recordings. Not all the researchers preferred PSG recordings; a variety of signals are also used for the sleep apnea detection. When blood oxygen saturation or oxygen saturation signals are considered for the analysis, it yields an effective outcome, while the EEG recordings depicted artefacts; hence, a separate preprocessing unit needs to be installed for better acquisition of signals. During the recording of EEG, the signal gets disrupted if the patient suffered suffocation, muscle pains, or limb twitches and hence requires a surrogate technique to monitor each parameter separately [69, 122].

Most of the researchers failed to mention the methodology adapted to evaluate the segmentation and decomposition accuracy. With the increase in stress level of people and OSA becoming a significant health problem, the data available for the diagnosis or detection seems to be insuffi-

cient. Considering the cost for monitoring and the discomfort caused during the recording of PSG signals, many patients refuse to take up the procedure. With the availability of two main databases, the Sleep Apnea-ECG database and University of Dublin database (UCD) of sleep apnea, many researchers have presented a comparative study. Different sets of machine learning and deep learning algorithms are implemented using these databases. The future scope of work as quoted by majority of the researchers is that implementation of noninvasive, home-bound techniques is considered as a reliable technique for effective diagnosis of OSA [79, 123, 124]. With more than 130 research articles compared in this study, machine learning algorithms are more significantly used for OSA screening. The recent research papers from year 2020 acknowledge the emergence of deep learning methods for OSA detection, and they also outperform the machine learning techniques. Ensemble classifier also showed significant performance. CAD procedure is proved to show good results in the classification of stages of OSA as well as detection of OSA signals from that of normal signals. In few related events, the classifier has not been efficient enough to identify the hypopnea. The apnea and the normal signals are identified efficiently by CNN-LSTM network. The score transitions between each epoch are considered as a hideous process [112].

9. Conclusion

Throughout the sections discussed in the review, the detection of OSA is handled in a different way according to the researcher's point of view. In this paper, more than 136 research articles have been reviewed, focusing on the preprocessing, decomposition, feature extraction, and classification techniques. In the initial phase of analysis, different preprocessing techniques along with the signal decomposition are discussed. Median filtering and wavelet transform are highly preferred among the researchers for initial phase of signal processing. In the second phase of the analysis, different

feature extraction methods and the features extracted are discussed. Of the research articles published, the majority of the papers are focused on classification techniques.

Perhaps, for data acquisition, more than 70% of the researchers have utilized PhysioNet Apnea-ECG database. PSG signals and RR interval signals yield better diagnostic result. In the comparison of classification techniques, neural network-based classification has provided better accuracy. With increased number of data samples, deep learning and reinforcement learning have proved to be efficient. The selection of layers in the classifiers plays a greater role in achieving accuracy. Additionally, incorrect selection of hidden layers leads to poor approximations and overfitting [19]. For the futuristic analysis, the current approaches must be validated with real time data. More number of heterogeneous cases can be included, involving standard database and patient sample. In this way, meaningful results can be obtained thereby, improving the overall accuracy of the classification of OSA.

Abbreviations

ANN:	Artificial neural network
BNSQ:	Basic Nordic Sleep Questionnaire
CNN:	Convolutional neural network
DNN:	Deep neural network
DBN:	Deep belief network
ECG:	Electrocardiogram
EEG:	Electroencephalogram
EIT:	Electrical impedance tomography
ELM:	Extreme learning machine
EMD:	Empirical mode decomposition
EMG:	Electromyogram
EOG:	Electrooculography
HRV:	Heart rate variability
KNN:	K-nearest neighbor
LDA:	Linear discriminant analysis
LR:	Linear regression
LSTM:	Long short-term memory
PSD:	Power spectral density
PSG:	Polysomnography
QDA:	Quadratic discriminant analysis
RBM:	Restricted Boltzmann machine
SVM:	Support vector machine.

Conflicts of Interest

The authors declare that they have no conflicts of interest.

References

- [1] R. Rosenberg, M. Hirshkowitz, D. M. Rapoport, and M. Kryger, "The role of home sleep testing for evaluation of patients with excessive daytime sleepiness: focus on obstructive sleep apnea and narcolepsy," *Sleep Medicine*, vol. 56, pp. 80–89, 2019.
- [2] D. J. Gottlieb and N. M. Punjabi, "Diagnosis and management of obstructive sleep apnea a review," *Journal of American Medical Association*, vol. 323, no. 14, pp. 1389–1400, 2020.
- [3] *Article on Sleep Apnea* <http://mayoclinic.org/diseases-conditions/sleep-apnea/symptoms-causes/syc-20377631>.
- [4] D. Abdissa, "Prevalence of obstructive sleep apnea risk and associated factors among patients with type 2 diabetes mellitus on follow-up at Jimma Medical Center, Southwest Ethiopia," *Journal of Clinical & Translational Endocrinology*, vol. 21, no. 21, article 100234, 2020.
- [5] A. Wosiak and R. Kowalski, "Automated feature selection for obstructive sleep apnea syndrome diagnosis," *Procedia Computer Science*, vol. 176, pp. 1430–1439, 2020.
- [6] F. Mendonca, S. S. Mostafa, A. G. Ravelo-Garcia, F. Morgado-Dias, and T. Penzel, "A review of obstructive sleep apnea detection approaches," *IEEE Journal of Biomedical and Health Informatics*, vol. 23, pp. 825–837, 2019.
- [7] A. R. Hassan, "Computer-aided obstructive sleep apnea detection using normal inverse Gaussian parameters and adaptive boosting," *Biomedical Signal Processing and Control*, vol. 29, 2016.
- [8] X. Li, S. Ling, and S. Su, "A hybrid feature selection and extraction methods for sleep apnea detection using bio-signals," *Sensors*, vol. 20, no. 15, p. 4323, 2020.
- [9] A. Roebuck, V. Monasterio, E. Gederi et al., "A review of signal susedin sleep analysis," *Physiological Measurement*, vol. 35, pp. R1–R57, 2014.
- [10] M. Schipper, D. Álvarez-Estévez, K. Jellema, J. Verbraecken, S. Fulda, and R. M. Rijsman, "Sleep-related leg movements in obstructive sleep apnea: definitions, determinants, and clinical consequences," *Sleep Medicine*, vol. 75, pp. 131–140, 2020.
- [11] R. B. Berry, R. Brooks, C. E. Gamaldo, S. M. Harding, R. M. Lloyd, and C. L. Marcus, *The AASM Manual for the Scoring of Sleep and Associated Events: Rules, Terminology and Technical Specifications, Version 2.1*, American Academy of Sleep Medicine, Darien, CT, 2014.
- [12] T. Penzel, J. W. Kantelhardt, R. P. Bartsch et al., "Modulations of heart rate, ECG, and cardio-respiratory coupling observed in polysomnography," *Frontiers in Physiology*, vol. 25, no. 7, p. 460, 2016.
- [13] O. Yildirim, U. B. Baloglu, and U. R. Acharya, "A deep learning model for automated sleep stages classification using PSG signals," *International Journal of Environmental Research and Public Health*, vol. 16, no. 4, p. 599, 2019.
- [14] C. Varon, A. Caicedo, D. Testelmans, B. Buyse, and S. Van Huffel, "A novel algorithm for the automatic detection of sleep apnea from single-lead ECG," *IEEE Transactions on Biomedical Engineering*, vol. 62, no. 9, pp. 2269–2278, 2015.
- [15] L. Grote and D. Zou, "Chapter 167 - Pulse Wave Analysis During Sleep," in *Principles and Practice of Sleep Medicine (Sixth Edition)*, M. Kryger, T. Roth, and W. C. Dement, Eds., Elsevier, 2017.
- [16] E. Smily Jeya Jothi, J. Anitha, and D. Jude Hemanth, "An automatic screening approach for obstructive sleep apnea from photoplethysmograph using machine learning techniques," *TELKOMNIKA-Telecommunication Computing Electronics and Control*, vol. 19, no. 4, p. 1260, 2021.
- [17] J. F. Morales, C. Varon, M. Deviaene et al., "Sleep apnea-hypopnea syndrome classification in SpO2 signals using wavelet decomposition and phase space reconstruction," in *2017 IEEE 14th International Conference on Wearable and Implantable Body Sensor Networks (BSN)*, pp. 43–46, 2017.
- [18] C. Song, K. Liu, X. Zhang, L. Chen, and X. Xian, "An obstructive sleep apnea detection approach using a discriminative

- hidden Markov Model from ECG signals,” *IEEE Transactions on Biomedical Engineering*, vol. 63, no. 7, pp. 1532–1542, 2016.
- [19] A. L. Goldberger, L. A. Amaral, L. Glass et al., “PhysioBank, PhysioToolkit, and PhysioNet: components of a new research resource for complex physiologic signals,” *Circulation*, vol. 101, no. 23, pp. E215–E220, 2000.
- [20] H. Hilmisson, N. Lange, and S. Duntley, “Sleep apnea detection: accuracy of using automated ECG analysis compared to manually scored polysomnography (apnea hypopnea index),” *Sleep and Breathing*, vol. 23, no. 1, pp. 125–133, 2019.
- [21] T. Penzel, G. B. Moody, R. G. Mark, A. L. Goldberger, and J. H. Peter, “The apnea-ECG database,” *Computers in Cardiology*, vol. 27, 2000.
- [22] S. S. Mostafa, J. P. Carvalho, F. Morgado-Dias, and A. Ravelo-Garcia, “Optimization of sleep apnea detection using SpO₂ and ANN,” in *2017 XXVI International Conference on Information, Communication and Automation Technologies (ICAT)*, pp. 1–6, 2017.
- [23] A. G. García, J. Kraemer, J. L. Navarro-Mesa, and E. Hernandez-Pérez, “Oxygen saturation and RR intervals feature selection for sleep apnea detection,” *Entropy*, vol. 17, no. 5, pp. 2932–2957, 2015.
- [24] G. Ozdemir, H. Nasifoglu, and O. Eroğul, “A time-series approach to predict obstructive sleep apnea (OSA) Episodes,” in *Proceedings of the 2nd World Congress on Electrical Engineering and Computer Systems and Science*, 2016.
- [25] T. Rosenwein, E. Dafna, A. Tarasiuk, and Y. Zigel, “Breath-by-breath detection of apneic events for OSA severity estimation using non-contact audio recordings,” in *2015 37th Annual International Conference of the IEEE Engineering in Medicine and Biology Society (EMBC)*, pp. 7688–7691, 2015.
- [26] T. Praydas, B. Wongkittisuksa, and S. Tanthanuch, *Obstructive Sleep Apnea Severity Multiclass Classification Using Analysis of Snoring Sounds*, 2016.
- [27] C. Kalkbrenner, M. Eichenlaub, S. Rudiger et al., “Apnea, and heart rate detection from tracheal body sounds for the diagnosis of sleep-related breathing disorders,” *Medical & Biological Engineering & Computing*, vol. 56, pp. 671–681, 2018.
- [28] P. E. Krumpe and J. M. Cummiskey, “Use of laryngeal sound recordings to monitor apnea,” *The American Review of Respiratory Disease*, vol. 122, pp. 797–801, 1980.
- [29] T. Penzel and K. Sabil, “The use of tracheal sounds for the diagnosis of sleep apnoea,” *Breathe*, vol. 13, pp. e37–e45, 2017.
- [30] A. R. Hassan and M. A. Haque, “An expert system for automated identification of obstructive sleep apnea from single-lead ECG using random under sampling boosting,” *Neurocomputing*, vol. 235, pp. 122–130.
- [31] R. Haidar, I. Koprinska, and B. Jeffries, “Sleep apnea event detection from nasal airflow using convolutional neural networks,” in *Neural Information Processing*, pp. 819–827, 2017.
- [32] S. Saha, M. Kabir, N. Montazeri et al., “Portable diagnosis of sleep apnea with the validation of individual event detection,” *Sleep Medicine*, vol. 69, pp. 51–57, 2020.
- [33] A. Elwali and Z. Moussavi, “Obstructive sleep apnea screening and airway structure characterization during wakefulness using tracheal breathing sounds,” *Annals of Biomedical Engineering*, vol. 45, no. 3, pp. 839–850, 2017.
- [34] F. Espinoza-Cuadros, R. Fernández-Pozo, D. T. Toledano, J. D. Alcázar-Ramírez, E. López-Gonzalo, and L. A. Hernández-Gómez, “Speech signal and facial image processing for obstructive sleep apnea assessment,” *Computational and Mathematical Methods in Medicine*, vol. 2015, 13 pages, 2015.
- [35] H. Yue, Y. Lin, Y. Wu et al., “Deep learning for diagnosis and classification of obstructive sleep apnea: a nasal airflow-based multi-resolution residual network,” *Nature Science Sleep*, vol. 13, pp. 361–373, 2021.
- [36] D. Álvarez, “Automated analysis of unattended portable oximetry by means of Bayesian neural networks to assist in the diagnosis of sleep apnea,” in *2016 Global Medical Engineering Physics Exchanges/Pan American Health Care Exchanges (GMEPE/PAHCE)*, pp. 1–4, 2016.
- [37] D. I. Vanegas-Cadavid, P. E. Guzmán-Díaz, L. Ibatá-Bernal, P. A. Franco-Garrido, and Z. Valderrama-Barbosa, “Obstructive sleep apnea diagnosed by peripheral arterial tonometry in patients with cardiovascular disease,” *Revista Colombiana de Cardiología*, vol. 26, no. 5, pp. 249–255, 2019.
- [38] A. Garde, “Development of a screening tool for sleep disordered breathing in children using the phone oximeter TM,” *PLoS One*, vol. 9, 2014.
- [39] G. Gutiérrez-Tobal, D. Alvarez, J. Gomez-Pilar, F. del Campo, and R. Hornero, “Assessment of time and frequency domain entropies to detect sleep apnoea in heart rate variability recordings from men and women,” *Entropy*, vol. 17, pp. 123–141, 2015.
- [40] R. Huhta, K. Hirvonen, and M. Partinen, “Prevalence of sleep apnea and daytime sleepiness in professional truck drivers,” *Sleep Medicine*.
- [41] D. W. Jung, S. H. Hwang, J. G. Cho et al., “Real-time automatic apneic event detection using nocturnal pulse oximetry,” *IEEE Transactions on Biomedical Engineering*, vol. 65, no. 3, pp. 706–712, 2018.
- [42] D. W. Jung, S. H. Hwang, Y. J. Lee, D.-U. Jeong, and K. S. Park, “Apnea-hypopnea index prediction using electrocardiogram acquired during the sleep-onset period,” *IEEE transactions on biomedical engineering*, vol. 64, no. 2, pp. 295–301, 2017.
- [43] A. Leino, S. Nikkonen, S. Kainulainen et al., “Neural network analysis of nocturnal SpO₂ signal enables easy screening of sleep apnea in patients with acute cerebrovascular disease,” *Sleep Medicine*, vol. 79, 2021.
- [44] N. Michielli, U. R. Acharya, and F. Molinari, “Cascaded LSTM recurrent neural network for automated sleep stage classification using single-channel EEG signals,” *Computers in Biology and Medicine*, vol. 106, pp. 71–81, 2019.
- [45] M. Minu and A. M. Paul, “SAHS detection based on ANFIS using single-channel airflow signal,” *International Journal of Innovative Research in Science, Engineering and Technology*, vol. 5, no. 7, 2016.
- [46] D. K. MoonikaViigimae, K. Pilt, P. Pirn, H. Huhtala, and O. Polo, “QT interval variability index and QT interval duration during different sleep stages in patients with obstructive sleep apnea,” *Sleep Medicine*, vol. 37, pp. 160–167, 2017.
- [47] S. S. Mostafa, F. Mendonca, F. Morgado-Dias, and A. Ravelo-Garcia, “SpO₂ based sleep apnea detection using deep learning,” in *2017 IEEE 21st International Conference on Intelligent Engineering Systems (INES)*, 2017.
- [48] D. Remalli Rohan, S. Kumar, and S. R. Patri, “Various methods for identification of obstructive sleep apnea using

- electrocardiogram features,” *Journal of Scientific Research Institute of Science*, vol. 64, no. 1, pp. 169–277, 2020.
- [49] H. Singh, R. Tripathy, and R. Pachori, “Detection of sleep apnea from heartbeat interval and ECG-derived respiration signals using sliding mode singular spectrum analysis,” in *Digital Signal Processing*, Elsevier, 2020.
- [50] M. Soliński, J. Gierałtowski, and J. Żebrowski, “Modeling heart rate variability including the effect of sleep stages,” *Chaos*, vol. 26, no. 2, article 023101, 2016.
- [51] W. Jifara, F. Jiang, B. Zhang et al., “Hyperspectral image compression based on online learning spectral features dictionary,” *Multimedia Tools and Applications*, vol. 76, no. 23, pp. 25003–25014, 2017.
- [52] Ö. Yıldırım, U. B. Baloglu, and U. R. Acharya, “A deep convolutional neural network model for automated identification of abnormal EEG signals,” *Neural Computing and Applications*, vol. 32, no. 20, pp. 15857–15868, 2020.
- [53] M. Al-Mardini, F. Aloul, A. Sagahyoon, and L. Al-Husseini, “Classifying obstructive sleep apnea using smartphones,” *Journal of Biomedical Informatics*, vol. 52, pp. 251–259, 2014.
- [54] S. A. Pullano, I. Mahbub, M. G. Bianco et al., “Medical devices for pediatric apnea monitoring and therapy: past and new trends,” *IEEE Reviews in Biomedical Engineering*, vol. 10, pp. 199–212, 2017.
- [55] A. Yuzer, H. Sumbul, and K. Polat, “A novel wearable real-time sleep apnea detection system based on the acceleration sensor,” *IRBM*, vol. 41, 2020.
- [56] A. Franczak, I. Bil-Lula, G. Sawicki, M. Fenton, N. Ayas, and R. Skomro, “Matrix metalloproteinases as possible biomarkers of obstructive sleep apnea severity – a systematic review,” *Sleep Medicine Reviews*, vol. 46, 2019.
- [57] R. K. Pathinarupothi, J. Dhara Prathap, E. S. Rangan, E. A. Gopalakrishnan, R. Vinaykumar, and K. P. Soman, “Single Sensor Techniques for Sleep Apnea Diagnosis Using Deep Learning,” in *2017 IEEE International Conference on Healthcare Informatics (ICHI)*, pp. 524–529, 2017.
- [58] A. Romero-Corral, S. M. Caples, F. Lopez-Jimenez, and V. K. Somers, “Interactions between obesity and obstructive sleep apnea: implications for treatment,” *Chest*, vol. 137, no. 3, pp. 711–719, 2010.
- [59] M. Vukoja, D. Milicic, A. Bokan, I. Andrijevic, and I. Kopitovic, *Lung function in patients with obstructive sleep apnoea*, 2017.
- [60] M. Partinen and T. Gislason, “Basic Nordic Sleep Questionnaire (BNSQ): a quantitated measure of subjective sleep complaints,” *Journal of Sleep Research*, vol. 4, no. S1, pp. 150–155, 1995.
- [61] O. Faust, R. Barika, A. Shenfield, E. J. Ciaccio, and U. R. Acharya, “Accurate detection of sleep apnea with long short-term memory network based on RR interval signals,” *Knowledge-Based Systems*, vol. 212, p. 106591, 2021.
- [62] V. Tsouti, A. I. Kanaris, K. Tsoutis, and S. Chatzandroulis, “Development of an automated system for obstructive sleep apnea treatment based on machine learning and breath effort monitoring,” *Microelectronic Engineering*, vol. 231, article 111376, 2020.
- [63] O. Faust, U. R. Acharya, E. Ng, and H. Fujita, “A review of ECG-based diagnosis support systems for obstructive sleep apnea,” *Journal of Mechanics in Medicine and Biology*, vol. 16, no. 1, p. 1640004, 2016.
- [64] A. Zarei and B. Asl, “Performance evaluation of the spectral autocorrelation function and autoregressive models for automated sleep apnea detection using single-lead ECG signal,” *Computer Methods and Programs in Biomedicine*, vol. 195, article 105626, 2020.
- [65] L. Chen, X. Zhang, and C. Song, “An automatic screening approach for obstructive sleep apnea diagnosis based on single-lead electrocardiogram,” *IEEE Transactions on Automation Science and Engineering*, vol. 12, no. 1, pp. 106–115, 2015.
- [66] P. Janbakhshi and M. B. Shamsollahi, “Sleep apnea detection from single-lead ECG using features based on ECG-derived respiration (EDR) signals,” *IRBM*, vol. 39, 2018.
- [67] M. Sharma, M. Raval, and U. R. Acharya, “A new approach to identify obstructive sleep apnea using an optimal orthogonal wavelet filter bank with ECG signals,” *Informatics in Medicine Unlocked*, vol. 16, p. 100170, 2019.
- [68] L. Chen and X. Zhang, “State-based general gamma CUSUM for modeling heart rate variability using electrocardiography signals,” *IEEE Transactions on Automation Science and Engineering*, vol. 14, pp. 1–12, 2015.
- [69] J.-A. Jiang, R. Lin, R.-G. Lee, C.-L. Tseng, H.-K. Zhou, and C.-F. Chao, “A new approach for identifying sleep apnea syndrome using wavelet transform and neural networks,” *Biomed Eng Appl Basis Comm*, vol. 18, pp. 138–143, 2006.
- [70] Y. Yin, H. Yule, and P. Liu, “The research on denoising using wavelet transform,” *International Conference on Multimedia Technology*, vol. 2011, pp. 5177–5180, 2011.
- [71] G. Lindfield and J. Penny, “Chapter 8 - Analyzing Data Using Discrete Transforms,” in *Numerical Methods (Fourth Edition)*, G. Lindfield and J. Penny, Eds., pp. 383–431, Academic Press, 2019.
- [72] M. Nardelli, G. Valenza, A. Greco, A. Lanata, and E. P. Scilingo, “Recognizing emotions induced by affective sounds through heart rate variability,” *IEEE Transactions on Affective Computing*, vol. 6, no. 4, pp. 385–394, 2015.
- [73] C. S. S. S. Viswabhargav, R. K. Tripathy, and U. R. Acharya, “Automated detection of sleep apnea using sparse residual entropy features with various dictionaries extracted from heart rate and EDR signals,” *Computers in Biology and Medicine*, vol. 108, pp. 20–30, 2019.
- [74] R. Tripathy and U. R. Acharya, “Use of features from RR-time series and EEG signals for automated classification of sleep stages in deep neural network framework,” *Biocybernetics and Biomedical Engineering*, vol. 38, no. 4, pp. 890–902, 2018.
- [75] S. Wu, D. Liang, Q. Yang, and G.-Z. Liu, “Regularity of heart rate fluctuations analysis in obstructive sleep apnea patients using information-based similarity,” *Biomedical Signal Processing and Control*, vol. 65, article 102370, 2021.
- [76] H. Yoon, S. H. Hwang, J.-W. Choi, Y. J. Lee, D.-U. Jeong, and K. S. Park, “Slow-wave sleep estimation for healthy subjects and OSA patients using R-R intervals,” *IEEE journal of biomedical and health informatics*, vol. 22, no. 1, pp. 119–128, 2018.
- [77] C. Cheng, C. Kan, and H. Yang, “Heterogeneous recurrence analysis of heartbeat dynamics for the identification of sleep apnea events,” *Computers in Biology and Medicine*, vol. 75, pp. 10–18, 2016.
- [78] E. Smily Jeya Jothi and J. Anitha, “Screening of sleep apnea with decomposition of photoplethysmogram to extract

- respiratory rate,” in *IEEE sponsored International conference on Signal Processing and Communication (Scopus)*, 2017.
- [79] D. Álvarez-Estévez and V. Moret-Bonillo, “Computer-assisted diagnosis of the sleep apnea-hypopnea syndrome: a review,” *Sleep Disorders.*, vol. 2015, 2015.
- [80] C. Avcı and A. Akbaş, “Sleep apnea classification is based on respiration signals by using ensemble methods,” *Bio-medical materials and engineering.*, vol. 26, pp. S1703–S1710, 2015.
- [81] D. A. Dean, A. Goldberger, R. Mueller et al., “Scaling up scientific discovery in sleep medicine: the national sleep research resource,” *Sleep*, vol. 39, no. 5, pp. 1151–1164, 2016.
- [82] I. Mitiche, G. Morison, and B. G. Stewart, *Electrocardiogram-based feature extraction for machine learning classification of obstructive sleep apnea*, 2016.
- [83] B. M. Oussama, B. M. Hamed Saadi, and S. Zine-Eddine, “Extracting features from ECG and respiratory signals for automatic supervised classification of heartbeat using neural networks,” *Asian journal of information technology*, vol. 15, pp. 5–11, 2015.
- [84] R. Tripathy, “Application of intrinsic band function technique for automated detection of sleep apnea using HRV and EDR signals,” *Biocybernetics and Biomedical Engineering*, vol. 38, no. 1, pp. 136–144, 2018.
- [85] Z. Dong, X. Li, and W. Chen, “Frequency network analysis of heart rate variability for obstructive apnea patient detection,” *IEEE journal of biomedical and health informatics*, vol. 22, pp. 1895–1905, 2018.
- [86] G. Memis and M. Sert, “Multimodal classification of obstructive sleep apnea using feature level fusion,” in *2017 IEEE 11th International Conference on Semantic Computing (ICSC)*, pp. 85–88, 2017.
- [87] G. Ayoub, T. H. Dang, and T. I. Oh, “Feature extraction of upper airway dynamics during sleep apnea using electrical impedance tomography,” *Scientific Reports*, vol. 10, p. 1637, 2020.
- [88] W. Y. Leong, “Feature extraction and optimisation for sleep apnea,” in *2014 IEEE International Symposium on Robotics and Manufacturing Automation (ROMA)*, pp. 200–205, 2014.
- [89] E. Smily Jeya Jothi and J. Anitha, *Estimation of heart rate and respiratory rate from PPG signal for the detection of sleep apnea*, Springer Series: Lecture notes on data engineering and communication technologies, through ICAIAME, Turkey, 2019.
- [90] T. Sunil Kumar and V. Kanhangad, “Gabor filter-based one-dimensional local phase descriptors for obstructive sleep apnea detection using single-lead ECG,” *IEEE Sensor letter*, vol. 2, no. 1, pp. 1–4, 2018.
- [91] S. González, J. L. Navarro-Mesa, G. Juliá-Serdá, J. Kraemer, N. Wessel, and A. G. García, “Heart rate variability feature selection in the presence of sleep apnea: an expert system for the characterization and detection of the disorder,” *Computers in Biology and Medicine.*, vol. 91, pp. 47–58, 2017.
- [92] O. Faust, Y. Hagiwara, T. J. Hong, O. S. Lih, and U. R. Acharya, “Deep learning for healthcare applications based on physiological signals: a review,” *Computer Methods and Programs in Biomedicine*, vol. 161, pp. 1–13, 2018.
- [93] J. Schmidhuber, “Deep learning in neural networks: an overview,” *Neural Networks*, vol. 61, pp. 85–117, 2015.
- [94] R. K. Pathinarupothi, R. Vinaykumar, E. Rangan, E. Gopalakrishnan, and K. P. Soman, “Instantaneous heart rate as a robust feature for sleep apnea severity detection using deep learning,” *IEEE EMBS International Conference on Biomedical & Health Informatics (BHI)*, vol. 2017, pp. 293–296, 2017.
- [95] J. H. Tan, Y. Hagiwara, W. Pang et al., “Application of stacked convolutional and long short-term memory network for accurate identification of cad ECG signals,” *Computers in Biology and Medicine*, vol. 94, pp. 19–26, 2018.
- [96] C. Usha Kumari, K. Padmavathi Kora, K. Meenakshi, T. P. Swaraja, A. K. Panigrahy, and N. A. Vignesh, “Feature Extraction and Detection of Obstructive Sleep Apnea from Raw EEG Signal,” in *International Conference on Innovative Computing and Communications*, A. Khanna, D. Gupta, S. Bhattacharyya, V. Snasel, J. Platos, and A. Hassanien, Eds., vol. 1087, Advances in Intelligent Systems and Computing, Springer, Singapore, 2020.
- [97] O. H. TİMÜŞ and E. D. BOLAT, “k-NN-based classification of sleep apnea types using ECG,” *Turkish Journal of Electrical Engineering and Computer Sciences*, vol. 25, no. 4, pp. 3008–3023, 2017.
- [98] S. Q. Ali and A. Hossen, “Different neural networks approaches for identification of obstructive sleep apnea,” in *2018 IEEE Symposium on Computer Applications & Industrial Electronics (ISCAIE)*, IEEE, pp. 281–284, 2018.
- [99] A. Benavides, R. Pozo, D. Toledano et al., “Analysis of voice features related to obstructive sleep apnoea and their application in diagnosis support,” *Computer Speech & Language.*, vol. 28, 2013.
- [100] A. G. Ravelo-Garcia, U. Casanova-Blancas, S. Martin-Gonzalez, E. Hernandez-Perez, P. Q. Morales, and J. L. Navarro-Mesa, “An approach to the improvement of electrocardiogram-based sleep breathing pauses detection by means of permutation entropy of the heart rate variability,” in *3rd IEEE International Work-Conference on Bioinspired Intelligence*, pp. 82–85, 2014.
- [101] S. Arikkath and S. Manikandan, “Real-time classification of healthy and apnea subjects using ECG signals with variational mode decomposition,” *IEEE Sensors Journal.*, pp. 1–1, 2017.
- [102] S. AI-Ratrouf and A. Hossen, “Support vector machine of wavelet packet spectral features for identification of obstructive sleep apnea,” in *International conference on electrical and electronics engineering*, pp. 380–383, 2018.
- [103] G. Surrel, A. Amimifar, F. Rincon, S. Murali, and D. Antienza, “Online obstructive sleep apnea detection on medical wearable sensors,” *IEEE.*, vol. 12, no. 4, pp. 762–773, 2018.
- [104] A. Pinho, N. Pombo, B. Silva, K. Bousson, and N. Garcia, “Towards an accurate sleep apnea detection based on ECG signal: the quintessential of a wise feature selection,” *Applied Soft Computing.*, vol. 83, article 105568, 2019.
- [105] *Article by Jason Brownlee Ph D* <http://machinelearningmastery.com/linear-discriminant-analysis-for-machine-learning>.
- [106] A. R. Hassan, *Automatic Screening of Obstructive Sleep Apnea from Single-Lead Electrocardiogram*, 2015.
- [107] D. Mukherjee, K. Dhar, F. Schwenker, and R. Sarkar, “Ensemble of deep learning models for sleep apnea detection: an experimental study,” *Sensors*, vol. 21, no. 16, p. 5425, 2021.
- [108] U. Erdenebayar, Y. J. Kim, J.-U. Park, E. Y. Joo, and K.-J. Lee, “Deep learning approaches for automatic detection of sleep apnea events from an electrocardiogram,” *Computer Methods and Programs in Biomedicine*, vol. 180, p. 105001, 2019.

- [109] M. Cheng, W. J. Sori, F. Jiang, A. Khan, and S. Liu, "Recurrent neural network based classification of ECG signal features for obstruction of sleep apnea detection," in *2017 IEEE International Conference on Computational Science and Engineering (CSE) and IEEE International Conference on Embedded and Ubiquitous Computing (EUC)*, 2017.
- [110] M. Cheng, W. J. Sori, F. Jiang, A. Khan, and S. Liu, "Recurrent Neural Network-Based Classification of ECG Signal Features for Obstruction of Sleep Apnea Detection," in *Computational Science and Engineering (CSE) and Embedded and Ubiquitous Computing (EUC), 2017 IEEE International Conference on*, 2, pp. 199–202, IEEE, 2017.
- [111] M. Hafezi, N. Montazeri, S. Saha et al., "Sleep apnea severity estimation from tracheal movements using a deep learning model," *IEEE Access*, vol. 8, pp. 22641–22649, 2020.
- [112] J. Zhang, Z. Tang, J. Gao et al., "Automatic detection of obstructive sleep apnea events using a deep CNN-LSTM model," *Computational Intelligence and Neuroscience*, vol. 2021, Article ID 5594733, 2021.
- [113] S. C. FanlinShen, L. Zhu, K. Yue, W. Li, and L. Dai, "Detection of snore from OSAHS patients based on deep learning," *Journal of Healthcare Engineering*, vol. 2020, 2020.
- [114] D. P. Morgan and C. L. Scofield, "Signal Processing and Feature Extraction," in *Neural Networks and Speech Processing. The Springer International Series in Engineering and Computer Science (VLSI, Computer Architecture and Digital Signal Processing)*, vol 130, Springer, Boston, MA, 1991.
- [115] N. Banluesombatkul, T. Rakthanmanon, and T. Wilaiprasitporn, "Single channel ECG for obstructive sleep apnea severity detection using a deep learning approach," in *TENCON 2018 - 2018 IEEE Region 10 Conference*, pp. 2011–2016, 2018.
- [116] U. R. Acharya, S. L. Oh, Y. Hagiwara, J. H. Tan, and H. Adeli, "Deep convolutional neural network for the automated detection and diagnosis of seizure using EEG signals," *Computers in Biology and Medicine*, vol. 100, pp. 270–278, 2018.
- [117] U. R. Acharya, S. L. Oh, Y. Hagiwara et al., "A deep convolutional neural network model to classify heartbeats," *Computers in Biology and Medicine*, vol. 89, pp. 389–396, 2017.
- [118] B. Xia, Q. Li, J. Jia et al., "Electrooculogram Based Sleep Stage Classification Using Deep Belief Network," in *In Proceedings of the 2015 International Joint Conference on Neural Networks (IJCNN)*, pp. 1–5, Killarney, Ireland, 2015.
- [119] T. H. Tran, T. T. Nguyen, Z. M. Yuldashev, E. V. Sadykova, and M. T. Nguyen, "The method of smart monitoring and detection of sleep apnea of the patient out of the medical institution," *Procedia Computer Science*, vol. 150, pp. 397–402, 2019.
- [120] H. Azimi, P. Xi, M. Bouchard, R. Goubran, and F. Knoefel, "Machine learning-based automatic detection of central sleep apnea events from a pressure sensitive mat," *IEEE Access*, vol. 8, pp. 173428–173439, 2020.
- [121] R. Haidar, I. Koprinska, and B. Jeffries, "Sleep apnea event prediction using convolutional neural networks and Markov chains," in *In Proceedings of the 2020 International Joint Conference on Neural Networks (IJCNN)*, pp. 1–8, Glasgow, UK, 2020.
- [122] S. L. Oh, Y. Hagiwara, U. Raghavendra et al., "A Deep Learning Approach for Parkinson's Disease Diagnosis from EEG Signals," *Neural Computing and Applications*, vol. 32, no. 15, pp. 10927–10933, 2020.
- [123] N. Pombo, N. Garcia, and K. Bousson, "Classification techniques on computerized systems to predict and/or to detect apnea: a systematic review," *Computer Methods, and Programs in Biomedicine*, vol. 140, pp. 265–274, 2017.
- [124] C. Senaratna, J. Perret, C. Lodge et al., "Prevalence of obstructive sleep apnea in the general population: a systematic review," *Sleep Medicine Reviews*, vol. 34, 2017.