

NASA TM - 80165



3 1176 00156 5341

# NASA Technical Memorandum 80165

NASA-TM-80165 19800001897

A FLIGHT INVESTIGATION OF  
PERFORMANCE AND LOADS FOR A HELICOPTER WITH  
NLR-1T MAIN-ROTOR BLADE SECTIONS

**FOR REFERENCE**

**NOT TO BE TAKEN FROM THIS ROOM**

CHARLES E. K. MORRIS, JR.,  
ROBERT L. TOMAINE,  
DARIENE D. STEVENS

OCTOBER 1979

**LIBRARY COPY**

OCT 24 1979

LANGLEY RESEARCH CENTER  
LIBRARY, NASA  
HAMPTON, VIRGINIA

**NASA**  
National Aeronautics and  
Space Administration  
**Langley Research Center**  
Hampton, Virginia 23665

# A FLIGHT INVESTIGATION OF PERFORMANCE AND LOADS FOR A HELICOPTER WITH NLR-1T MAIN-ROTOR BLADE SECTIONS

by

Charles E. K. Morris, Jr., Robert L. Tomaine, and Dariene D. Stevens

## SUMMARY

A flight investigation has produced data on performance and rotor loads for a teetering-rotor, AH-1G helicopter that had used the NLR-1T airfoil on the main-rotor blades. Data for each test point describe simple flight-state parameters, control positions, rotor loads, power required and blade motion. The flight program was generally limited to level flight between 35 and 85 m/sec (68 and 165 knots) and to collective-fixed maneuvers at about 0.25 tip-speed ratio.

Rotor loads are reviewed in terms of peak-to-peak values and harmonic content. Peak-to-peak loads showed increases with increased airspeed. Basic trends for peak-to-peak loads were also determined for increases in maneuver load factor: beamwise values showed little increase, inboard chordwise loads increased and torsional loads decreased. The pattern of harmonic loading generally showed that the more significant components increased with increased airspeed. During maneuvers, increases in load factor had little effect on the pattern of harmonic loads for most data channels.

## INTRODUCTION

The appropriate utilization of advanced airfoils for helicopter blades should improve rotor performance and reduce rotor loads (ref. 1). A flight investigation was conducted to obtain data on advanced rotorcraft airfoils representing significantly different design technologies (refs. 2 and 3). The data included blade-section aerodynamics, performance, loads, flight-state parameters, and control settings.

This report presents loads and performance data from the first part of the rotorcraft-airfoil flight investigation described in reference 2. The first blade set for the teetering-hub main rotor was built with the NLR-1T airfoil section. This is a slightly truncated version of the NLR-1 airfoil of references 4 and 5. The geometry and structural dynamics of the blades for the AH-1G test vehicle were not optimized. The investigation objectives were primarily to obtain data on the airfoil operating in the rotor environment.

The test program for the NLR-1T blades utilized two digital data systems to acquire data during hover, level flight, and maneuvers. The fuselage data system, described in reference 6, provided data on simple flight-state

N80-10136 #

parameters, control positions, engine torque, fuel weight, and several other quantities. The rotor data system, described in reference 7, acquired data on rotor loads, blade angles, and airfoil pressure distributions at 0.9 blade radius. Test conditions included steady, level flight from about 35 to 85 m/sec (68 to 165 knots) collective-fixed turns and pull-ups, at approximately 0.25 advance ratio. Flight data for the same vehicle, flown with a set of standard production-configuration blades, are given in reference 6. Relevant data from a vehicle using instrumented main-rotor blades are contained in references 8 to 11.

Numerous sets of reduced data are presented without analysis. Each set of listed data contains concurrently measured values for all of the data parameters. Figures contain typical parameter histories and plots of basic test-point trends to assist in the interpretation and utilization of the data listings.

### SYMBOLS

Positive senses of some axes, angles and accelerations are presented in figure 1.

$A_{0f}$	main-rotor collective pitch angle at 0.75R, commanded at swashplate, deg
$A_{0s}$	main-rotor collective pitch angle at 0.75R, measured at blade grips, deg
$A_{0,tr}$	tail-rotor collective pitch angle, deg
$A_{1f}$	main-rotor lateral cyclic pitch angle, commanded at swashplate, deg
$A_{1s}$	main-rotor lateral cyclic pitch angle, measured at blade grip, deg
$a$	speed of sound, m/sec
$a_{1s}$	first harmonic of main-rotor longitudinal flapping with respect to the rotor mast, deg
$B_{1f}$	main-rotor longitudinal cyclic pitch angle, commanded at swashplate, deg
$B_{1s}$	main-rotor longitudinal cyclic pitch angle, measured at blade grip, deg
$b_{1s}$	first harmonic of main-rotor lateral flapping with respect to the rotor mast, deg
$C_L'$	vehicle load coefficient, $\frac{Wn_z}{\rho\pi R^2 (\Omega R)^2}$
$C_Q$	main-rotor mast torque coefficient, $\frac{Q}{\rho\pi R^3 (\Omega R)^2}$
$c$	airfoil chord, m

E	modulus of elasticity, $N/m^2$
$F_{db}$	drag-brace force, positive for tension, N
$F_{pl}$	pitch-link load, positive for compression, N
G	shear modulus, $N/m^2$
g	acceleration due to gravity, $9.81 \text{ m/sec}^2$
$h_p$	density altitude, m
$I_b$	blade-section beamwise area moment of inertia, $m^4$
$I_c$	blade-section chordwise area moment of inertia, $m^4$
$i_h$	horizontal-tail incidence angle, deg
J	torsional stiffness constant, $m^4$
$M_{bp}$	blade beamwise (flapwise) bending moment at "p" percent blade radius, positive for load applied upward, N-m
$M_{cp}$	blade chordwise (inplane) bending moment at "p" percent blade radius, positive for load applied rearward toward blade trailing edge, N-m
$M_h$	reference blade-tip Mach number, $\frac{\Omega R}{a}$
$M_{tp}$	blade torsional moment at "p" percent blade radius, positive for load applied upward at blade leading edge, N-m
$m_1$	data channel sensitivity, measured units/mV
N	number of rotor revolutions, initiated at $\psi = 0^\circ$
$n_x, n_y, n_z$	orthogonal set of load factors for aircraft center of gravity, g units
$P_f, q_f, r_f$	orthogonal set of fuselage angular rates, rad/sec
Q	main-rotor mast torque, N-m
r	radial distance to blade element, m
R	main-rotor radius, m
$T_b$	blade temperature, C

$T_{ce}$	canister electronics temperature, C
$t$	time, seconds
$V$	aircraft true airspeed or velocity, m/sec (knots)
$W$	aircraft gross weight, N
$X, Y, Z$	orthogonal set of aircraft body axes (see fig. 1)
$x$	airfoil abscissa, positive rearward from leading edge, m
$y$	airfoil ordinate, positive upward, m
$\alpha_f$	fuselage angle of attack, deg
$\beta_f$	fuselage angle of side-slip, deg
$\beta_s$	main-rotor, shaft-axis teeter angle, (where $\beta_s = a_0 - a_{1s} \cos \psi - b_{1s} \sin \psi \dots$ ) positive upward, deg
$\Delta_f$	change in data measurement due to temperature (see table V)
$\Delta m_2$	sensitivity of digitizing electronics, mV/counts - C
$\Delta P_0$	data increment due to sensor temperature, data units/C
$\Delta V_0$	adjustment to data-channel sensitivity for electronics temperature, mV/C
$\delta$	digital data-system measurements, counts
$\theta_f$	fuselage pitch attitude, deg
$\theta_s$	main-rotor shaft-axis blade pitch at $0.75R$ , (where $\theta_s = A_0 - A_{1s} \cos \psi - B_{1s} \sin \psi - \dots$ ), measured at blade grip, deg
$\mu$	tip-speed ratio, $V/(\Omega R)$
$\rho$	mass density of air, $kg/m^3$
$\phi_f$	fuselage roll attitude, deg
$\psi$	main-rotor blade azimuth angle, measured from downwind position in direction of rotor rotation, deg
$\Omega$	main-rotor rotational speed, rad/sec

Subscripts:

cg        center of gravity  
l         lower surface  
na        neutral axis  
u         upper surface

Bars over symbols denote mean values; circumflex marks ( $\hat{\quad}$ ) over symbols denote peak-to-peak amplitudes of oscillations for one rotor revolution.

## EQUIPMENT AND PROCEDURES

### Test Vehicle

The test vehicle was the modified AH-1G attack helicopter shown in the drawings of figure 2 and the photographs of figure 3. Specifications of the physical characteristics of that vehicle are given in table 1. In comparison to a standard AH-1G helicopter, the only significant external differences resulted from the use of experimental main-rotor blades, an instrumentation nose boom, a rotor-data canister mounted on top of the mast, and a stub antenna attached to the tail boom. The fuselage weapons-system assembly was replaced by a dummy chin turret and an instrumentation rack in the ammunition bay. The test vehicle differed from its configuration for reference 6 by the addition of the tail-boom antenna and the replacement of the rotor data system, main-rotor blades, and tail rotor (fig. 3(b)). The aircraft carried no wing stores.

The physical characteristics of the NLR-1T main-rotor blades are very similar to those of the other two experimental blade sets (ref. 2). These characteristics are given in tables I and II. Planform and section views of the blade are shown in figures 4 and 5, respectively. Compared to standard AH-1G blades, the NLR-1T blades had similar structural-dynamic properties and identical planform, twist and root-end fittings. Details of the structural design and some resulting physical characteristics are presented in appendix A.

The NLR-1T airfoil was analytically designed for use on a high-speed helicopter (refs. 4 and 5). An initial contour was developed with a computer program using hodograph-plane equations to obtain shock-free flow at the high-speed design point. The NLR-1 airfoil was developed further by modifying the initial shape to give good performance at hover conditions and to alleviate retreating-blade stall. The NLR-1T airfoil is simply the NLR-1 shape truncated at 99 percent of design chord to obtain a finite-thickness trailing edge. The coordinates are given in table III; wind-tunnel data and analyses are given in references 12 and 13. Key characteristics of the NLR-1T airfoil are a zero-lift, drag-divergence Mach number of about 0.84; a maximum lift coefficient of 1.1 at 0.4 Mach number; and a zero-lift, subsonic pitching-moment coefficient of about -0.01 to -0.02.

## Data System

The aircraft was equipped with two digital data systems. The Piloted Aircraft Data System (PADS) acquired data from fuselage-mounted sensors; the Special Rotor Blade Instrumentation (SRBI) system processed signals from rotor-mounted sensors. Both systems used pulse code modulation (PCM) in the multiplexer-digitizer electronics.

The PADS-PCM system, described fully in reference 6, recorded several types of data: aerodynamic flight state, inertial flight state, control positions, engine torque, rotor speed, blade azimuth, and fuel quantity. The electronics used a 10 bit word, parity included, and a multiplexed sampling rate of 80 times per second per channel. Specifications for each sensor are given in table IV.

The SRBI system of reference 7 was used for a variety of rotor data. The SRBI system multiplexed and digitized data on pitch-link and blade loads, mast torque, blade angles, blade-section pressures and data-system temperatures. The SRBI system had an 8-bit data word (with no parity) and sampled each of the 30 channels 1000 times per second. All of the data channels for loads and angles had a single-pole, constant-delay filter with 3-decibel attenuation frequency at 90 Hz. Further information on the individual channels and sensors is contained in tables V and VI, appendix B, and reference 7. The canister and some of the sensors are shown in the photographs of figure 6.

The SRBI system consisted of several different subassemblies. Digitization electronics for the load and angles data were located in the mast-mounted canister. The batteries, which gave power for about one hour of flight, were also mounted in the canister. During the first NLR-1T flights, a canister transmitter sent the data signal to a fuselage receiving antenna; subsequently, this transmission link was deactivated and a slipring assembly was substituted to conserve battery power. The data signal was recorded on the aircraft and transmitted from fuselage-mounted antennas to a ground station for safety-of-flight monitoring.

## Data Reduction

Each of the two, basic types of data, PADS-PCM and SRBI, required a separate data-reduction method. In reference 6, details of both the PADS-PCM data reduction and the resulting computer listing of corrected parameters for each test time are given. Results from SRBI data reduction describe parameters for one revolution at each selected time. SRBI data reduction requires inputs for the same time intervals from the program for PADS-PCM data reduction.

The SRBI data for loads and angles were first processed to correct for temperature and filter-lag effects. Next, a more accurate measure of rotor speed was obtained from the SRBI azimuth and time data. The new rotor speed was used to revise the calculation of PADS-PCM parameters effected by rotor speed (such as engine torque coefficient). The resulting changes were typically small. Flight records of blade loads and angles were processed to yield data decomposed into harmonics of rotor rotational frequency. Interactions between each strain-gauge bridge and several types of loads are indicated in table VI but were not

accounted for in the analysis since the full set of load components were not measured at each instrumented blade station. This simplified treatment is typical of flight-loads reports (refs. 8 and 14) since interactions are minimized during strain-gauge installation.

### Flight-Test Procedures

Flight tests were conducted to obtain data on the performance and rotor-loads characteristics of the test vehicle in straight and level flight and in maneuvers. Steady, level-flight speed sweeps were accomplished, usually in 5 m/sec (10 knot) increments, from about 35 to 85 m/sec (68 to 165 knots). Maneuvers were flown with a target tip-speed ratio of 0.25 and collective pitch set for trim at that speed. The symmetrical pull-ups and constant-air-speed, descending turns were flown with a range of normal-load factors up to 2.3. The tests also include representative periods of hover and of linear climb and descent.

Emphasis was placed on achieving well-controlled, standardized test-point conditions to allow direct comparison between data sets for the different experimental rotors. Operating rotor speed and longitudinal center of gravity were kept very close to the nominal values, and the external configuration of the aircraft was the same for the tests of all three experimental blade sets (ref. 2). Also, data were acquired only when air turbulence levels were acceptably low. Even though standardized track-and-balance procedures were followed, the rotor demonstrated relatively large sensitivity to changes in differential pitch, blade-sweep or trim-tab settings, indicating that track-and-balance variables could be important flight-test parameters.

### PRESENTATION OF RESULTS

Data on performance, rotor loads, flight state and control positions are presented in figures 7 through 27 and in the listings of appendix C. Table VII is a guide to the listings. Flight numbers and run numbers are used to identify the test points for all listings and some figures. The data figures are presented as follows:

	<u>Figures</u>
Level flight	
Typical data histories.....	7, 8
Application of harmonic analysis.....	9, 10
Survey of power-required data.....	11
Data set trends: two speed sweeps.....	12, 13
Rotor-load harmonics.....	14, 15
Maneuvering flight	
Descending turns	
Typical data histories .....	16 to 19
Rotor-load harmonics.....	20 to 22
Symmetrical pull-ups	
Typical data histories .....	23, 24
Rotor-load harmonics .....	25, 26
Maneuver-load trends .....	27



## DISCUSSION

The methods of data presentation and review in this report are influenced by two anticipated uses. First, this data is a source of experimental performance and loads data for correlation studies with computer models of helicopters. Second, this data can provide a detailed description of test-point conditions for concurrently measured airfoil data (such as that of ref. 2). The data review proceeds from straight-and-level test conditions, to descending turns, and then to symmetrical pull-ups.

Vehicle load coefficient  $C_L'$  is used as primary parameter for designating the aircraft load level experienced during maneuvers. This coefficient represents the combined influences of vehicle weight, vertical load factor, air density and rotor rotational speed: it provides a good measure of the inertial load reacted by the rotor and other aerodynamic surfaces. Reference 15 indicates that the stub wings and horizontal-tail surfaces can make significant contributions to vehicle lift and download. The data presented herein does not account for such effects, which could be a function of load factor, pitch rate, roll angle, and other parameters. In general, however, all conclusions based on variations in vehicle load coefficient also hold true for variations in load factor.

Rotor loads are discussed in terms of beamwise (flapwise), chordwise (inplane), and torsional loads. Pitch-link loads are referred to as torsional loads. The implications of interaction and simplified temperature-effects corrections are not considered herein. The mean values of some loads, particularly chordwise blade loads, appeared to experience some drift during flight. Some loads data were also affected by the need to maintain a large response range for safety-of-flight purposes, in such cases, the precision of increments is comparatively large.

### Level Flight

Test-point selection.- As in reference 6, test-point times for data reduction were chosen on the basis of steadiness, which was judged by reviewing records of data on flight-state, control position, rotor motion, and blade loads. The ideal test point is one achieved with fixed controls and, for level flight or steady maneuvers, a trimmed vehicle; it was achieved for symmetrical pull-ups when the body attitude matched that for level flight at the same air-speed. Low levels of air turbulence were required. Rotor-data histories presented as figures 7 and 8 are typical of a steady test point since the wave forms for each blade revolution appear to be highly repeatable.

Results of harmonic analyses also serve as indications of steadiness. An example of the degree to which harmonic curve-fits can replicate measured data is given in figure 9. The data of figure 10 allows a comparison of the dominant harmonic amplitudes for several times at one test-point condition. The indicated level of steadiness is typical for all level-flight results.

Powered-required data.- Figure 11 presents data on main-rotor torque required for each of the level-flight speed sweeps flown with the NLR-1T blades.

(The sets of data are plotted with offset scales and sequenced in the ascending order of average reference Mach number.) As indicated in reference 6, a detailed comparison between data sets requires adequate data on flight state, control positions and parameters such as air turbulence level.

Forward-flight effects.- Basic data for two level-flight speed sweeps are presented in figure 12. Some of the test points are also described in Appendix C. Most of the plots show good agreement between data for the two speed sweeps. The sweep with a reference Mach number of 0.70 did have higher values of several parameters: vehicle load and main-rotor torque coefficients (fig. 12(a)); main-rotor collective pitch angle (fig. 12(c) & (d)); and oscillatory inplane blade loads (fig. 12(g)). The same speed sweep also exhibited slightly lower torsional and beamwise oscillatory loads (fig. 12(e) and (g)). An anomalous incremental increase in oscillatory chordwise loads is shown in figure 12(f) at about  $\mu = 0.33$  for  $M_h = 0.69$ .

Several trends are evident in the load data of figure 12. First, in figure 12(e), the peak-to-peak loads for beamwise bending show a highly non-linear increase with tip-speed ratio only at the most inboard station. Most of the chordwise data in figure 12(f) show that peak-to-peak loads grow more rapidly when tip-speed ratio increases above approximately 0.3 (about 130 knots). Each type of data for both blade torsion at 45 percent rotor radius and pitch-link loads follows a basic trend (fig. 12(g)). The peak-to-peak loads develop a small region of possible data-curve inflection near a tip-speed ratio of 0.2; above that speed, peak-to-peak loads grow almost linearly. In addition, the mean value of the blade torsion or pitch-link loads grows more negative, due to larger leading-edge down moments, as tip-speed ratio increases.

Wave forms for several digital data channels are shown in figure 13. These data, and the data records of figures 7, 8, and 9, help to give some insight into the speed-sweep data of figure 12. They show that data descriptions in terms of mean and peak-to-peak amplitude values may neglect some potentially significant aspects of the wave forms (for example, see fig. 13 (c)). The use of harmonic analysis offers one means of conveniently reducing, listing, and reviewing large sets of data such that more detail is preserved.

Rotor-load harmonics.- The harmonic content of rotor loads for a representative series of level-flight conditions is shown in figure 14. For the beamwise loads, the first four harmonics appear to be the most significant. Inboard chordwise loads have significant contributions from the first three and, sometimes, the sixth harmonics. For chordwise loads at 80 percent rotor radius, significant contributions are observed for up to seven harmonics. The first harmonic dominates blade torsion and pitch-link loads at lower speeds; above 100 knots, the second harmonic also appears to be very significant.

A summary plot, figure 15, shows forward-flight effects on the harmonics of the blade loads at 45 percent rotor radius. Data are shown for the four harmonics having the largest amplitudes. (Note that energy content and the implications for fatigue damage are also frequency dependent.) The first two harmonics clearly dominate for beam and torsion loads. Chordwise load trends are quite different in that the first and third harmonics dominate the loads at higher tip-speed ratios.

## Maneuvering Flight

Descending turns.- A well-controlled descending turn is a steady maneuver executed so that airspeed and trim are maintained while altitude is lost. Figure 16 shows data, with different start times, taken during one test-point attempt. It may be seen that the wave forms match very well despite the adjustments to engine power.

Several other examples of typical rotor-data records show periodic wave forms for descending turns. Figure 17 presents some records for two turns; figure 18 presents a full set of rotor-loads records for a well-controlled turn. Figure 19 shows that increasing vehicle load coefficient (or load factor) can substantially alter the wave form.

The harmonic content of measured rotor loads for descending turns can be reviewed with the data of figures 20, 21, and 22. Representative results for left and right turns (figs. 20 and 21, respectively) show little or no effects due to increases in vehicle load coefficient. The most significant components are the same as for level flight; that is, the first four for beamwise loads, the first two harmonics for torsional loads and the first, third, and sixth for chordwise loads remain nearly constant. Summary data for the loads at 45 percent rotor radius are presented in figure 22. These data show that the only well defined trends are increases in first and third-harmonic chordwise loads and slight decreases in torsional loads with increasing vehicle load coefficient.

Symmetrical pull-ups.- Records of rotor data for symmetrical pull-ups are presented in figures 23 and 24. The transient nature of the maneuver is clearly indicated by the decrease in mast torque in figure 23 and the noticeable change in the steady state and peak-to-peak values for many of the load histories shown in figure 24.

Harmonic load data for six pull-ups are presented in figures 25 and 26. As in the turns, strong trends are not shown in the data of figure 25. The summary data for 45 percent rotor radius (fig. 26) show that the only clear trend is increased first-harmonic chordwise loads with increased vehicle load coefficient. The data of figures 23 and 24 indicate that somewhat different results could be obtained if criteria for test-point selection were more loosely interpreted.

Maneuver-load trends.- Some of the rotor-loads data for turns and pull-ups show common trends for variations in peak-to-peak loads with changes in vehicle load coefficient (fig. 27). The amplitudes of peak-to-peak bending moment for all the beam channels and the outboard chord channel remain virtually constant. Values for the drag-brace load and chord bending at 45 percent rotor radius show substantial increases with increases in vehicle load factor (fig. 27(b)). Except for a pull-up at extreme conditions, the values for blade torsion and pitch-link actually decrease (fig. 27(c)). This last trend agrees well with observer and pilot comments on decreases in vibration level with increases in load factor.

A review of the harmonic content of both types of maneuvers shows that, in most cases, the pattern of harmonic loads does not change significantly over the range of vehicle load coefficients (or load factors) achieved. Figures 22 and 26 help to show that for inboard chordwise loads, the first and, to a lesser degree, the third harmonics of the load do increase with increased vehicle load coefficient.

#### CONCLUDING REMARKS

A flight investigation has been conducted to acquire data on the performance, loads and airfoil aerodynamics of a teetering-rotor helicopter having the NLR-1T airfoil as the blade-section contour for the main-rotor. Data are presented on the variation of flight-state parameters, control positions, rotor loads, power required and blade motion during level-flight speed sweeps and maneuvers at approximately 0.25 tip-speed ratio.

Several trends were evident in the rotor loads data. Increases in airspeed in level flight increased peak-to-peak loads, particularly those inboard on the blade. Above 35 m/sec (68 knots), each type of load was characterized by the pattern of harmonic contributions to those loads: beamwise bending was dominated by the first four harmonic components; torsional loads by the first two harmonics; and inboard chordwise loads by the first, third, and sometimes, sixth harmonics. The magnitude of all of these components increased with increased airspeed. During the maneuvers, the relative pattern of harmonic components remained fairly constant with increases in load factor; the notable exception was the growth of first and third harmonics for inboard chordwise loads with increased severity of the maneuver. During maneuvers, the most significant changes in peak-to-peak loads with increased load factor were increases in inboard chordwise loads and decreases in torsional loads.

## APPENDIX A

### MAIN-ROTOR BLADE DESIGN

The structural design of the main-rotor blades was influenced by requirements for built-in instrumentation and maximum commonality between the new blade sets. As shown in figures 4 and 5, each new-airfoil blade had a thin metallic substructure. The spar assembly was formed by a spar with an H-shape cross-section, high-density aluminum honeycomb behind the spar, and an airfoil-contoured nose block in the front of the spar. Nose weights were secured inside the nose block. The whole substructure was formed by bonding together the spar, a lighter aluminum-honeycomb afterbody, an aluminum trailing-edge stiffener, and aluminum skins. Strain-gauge bridges and all instrumentations leads and terminals were bonded to the substructure. Doublers and standard grip plates were attached to the root end. Outboard of about 31 percent rotor radius, Nomex honeycomb was bonded on, trimmed, and covered with a fiberglass skin to obtain a close-tolerance contour of the NLR-1T airfoil. Cavity and cover-plate assemblies for pressure transducers were installed in the nose block and Nomex honeycomb of one blade at 90 percent rotor radius. On the blade-tip lower surface, a cover plate protected a cavity for pressure-data electronics (fig. 4). The use of cover plates and fairing compound restored the airfoil contour after the pressure-data system was installed.

Despite differences in fabrication histories and instrumentation installation, the two blades of the NLR-1T set were very close in structural and dynamic characteristics. One blade was instrumented with strain-gauge bridges and pressure transducers. The instrumented blade required more contour filling and handwork to meet contour tolerance criteria. Before paint or tip weights were added, the static centers of gravity lay at 24.9 percent chordwise station for both blades and at 54.4 and 54.0 percent spanwise station, respectively, for the blades with and without instrumentation. The instrumented blade weighed 1255 newtons; the other blade weighed 1242 newtons. The measured torsional natural frequencies of the instrumented and second blade were 15.5 and 15.9 Hz, respectively. Manufacturer's tests indicated that the frequencies of the first torsional mode and the second flapwise mode were coincidental near the normal operating tip speed.

## APPENDIX B

### SPECIAL ROTOR BLADE INSTRUMENTATION SYSTEM

#### Blade Angle Data

Three types of blade angles were measured. The pitch angle of the instrumented blade was measured as described in reference 6: a spring-loaded string-type potentiometer sensed the angle at the blade grip. Teeter angle was sensed on the first NLR-1T flights with the same linear slide-type potentiometer as described in reference 6; for all flight data reported here, it was sensed with the rotary potentiometer shown in figure 6(b). Fuselage-referenced azimuth angle of the instrumented blade was sensed by a 256 increment, digital shaft encoder mounted inside the canister support assembly. All of these systems were calibrated in place, on the aircraft.

#### Structural Loads Data

Strain-gauge bridges were used to measure loads in the mast and in both the pitch link and drag brace for the instrumented blade. Mast torque and pitch-link load were measured as described in reference 6. The drag brace (which connects the rear of the blade to the hub) was instrumented for axial loads with a temperature-compensated bridge (figure 6(c)) and was calibrated in tension.

Blade bending loads were measured by eight 350 ohm strain-gauge bridges. The bridges were bonded to the blade metallic substructure and, except for the most inboard bridge for flapwise bending, were covered by the Nomex honeycomb. Five flapwise bridges (at 17.4, 35.0, 44.9, 60.6, and 80.3 percent rotor radius), two chordwise bridges (at 44.9 and 80.3 percent rotor radius), and one torsional bridge (at 44.9 percent rotor radius) were active for SRBI. All three components of bending were measured together only at one spanwise station.

Calibration of the blade strain-gauge bridges was accomplished by hanging the blade from the root end and applying loads near the tip. Thus, the nominal zero-loading condition imposed no initial blade loads, other than spanwise, due to gravity. The blade root was bolted (at 15.5 percent rotor radius) to a fixture mounted at the top of a massive, vertical, loading stand. Loads were applied by a rectangular fixture that covered 0.3 m of the span at 92.6 percent blade radius. Flapwise and chordwise moments were produced by forces perpendicular and parallel, respectively, to the 15.5 percent rotor-radius station. Torsional moments were applied as pure moments at the loading block. The resulting data on bridge sensitivity and interactions are given in tables IV and V. Typical calibration data (fig. 28) show the effect of blade bending and some load misalignment under highly loaded conditions.

Temperature effects were also evaluated. Data on zero-load effects of temperature variation were obtained when the entire blade was stabilized at several temperatures between -10 C and 270 C. These results showed linear variations. Specifications for temperature compensation for strain-gauge bridges and cumulative experience indicated that temperature-induced shifts in sensitivity were negligible when compared to the zero change.

#### Temperature Data

Temperatures were sensed in the canister and in one of the pressure transducer cavities. Canister temperature was used to apply corrections to all load and angle channels which were digitized in the canister. The blade temperature was used to correct for the effects of changes in blade temperature on the blade bridges. Simplified data-reduction methods assumed that the Nomex and dead-air cells next to the metallic surface helped to insulate the blade and produce a fairly uniform internal temperature.

#### Preflight Calibrations

Calibrations were applied to strain-gauge channels with battery power after the battery had discharged enough to stabilize the voltage level. Calibrations were made in the form of shunt changes to the bridge circuits. Records were made for ambient loads and for two levels of bridge unbalance whose incremental change in voltage corresponded to known load levels. Calibration records were impressed on both the flight and ground-station tapes. This process calibrated the signal conditioning and checked bridge output for standard, ambient conditions.

## APPENIX C

### TEST-POINT DATA LISTINGS

The upper part of the page for each test point contains PADS-PCM data from fuselaged-mounted sensors. The information on test-point identification and data on flight-state, control position and other parameters are presented in the manner explained in reference 6.

The lower part of each page contains SRBI-system data on the rotor. Test-point identification is printed next to flight-condition parameters. Three temperatures are given: the value computed for ambient atmospheric conditions (AMB TEMP); blade temperature at 90 percent radius, upper surface, 60 percent chord (TEMP 60), and the temperature of the blade electronics in the canister (CAN TEMP). The latter two are listed in table V and reference 6 as  $T_b$  and  $T_{ce}$ , respectively. They were two temperatures used in SRBI data reduction. The mast-torque coefficient printed is the average value for the revolution. The total torque coefficient is the value obtained for engine power at equivalent main-rotor rotational speed. Both blade pitch (at 75 percent radius) and teeter angle of the instrumented blade are described by conventional mean and cyclic components based on harmonic analysis. Peak-to-peak values are added since, as noted in reference 6, data traces may be much more complex than a simple first-harmonic pattern.

Rotor loads are presented in terms of mean values, peak-to-peak values and the harmonic content for the first 12 harmonics of actual rotor rotational frequency. (The measured value of this frequency is also listed.) The harmonic representation uses a series of cosine terms, each with a phase delay. Using the labels from the listing, each load may be described as:

$$F(t) = (\text{MEAN}) + \sum_{n=1} ((\text{AMP})_n \cos(t - (\text{PHASE})_n))$$

where  $F$  is the load (a function of time), MEAN is the mean amplitude,  $n$  is number of the harmonic, AMP is the vector amplitude, and PHASE is the phase angle in degrees for that harmonic.



FLIGHT NO. 060 AIRCRAFT TOTAL WT = 35964. N LOADED CG X = 5.05 M = 198.6 IN  
 RUN NO. 6 8065. LB Y = -0.00 Z = -0.0  
 TIME 68740.80 (SEC) Z = 1.83 M = 71.9

AERODYNAMIC FLIGHT STATE

DYNAMIC PRES = 1.68 KPA = 39.3 PSF  
 STATIC PRES = 94.0 KPA = 1962. PSF  
 TOTAL TEMP = 266.1 DEG K = 478.9 DEG R  
 STATIC TEMP = 254.6 DEG K = 476.2 DEG R  
 T. AIRSPEED = 106.9 KT  
 A/C MACH NO = .169  
 BODY ALPHA\* = -2.4 DEG  
 BODY BETA = -1.2 DEG  
 DENSITY = 1.24 KG/M3 = .00240 SLUG/FT3  
 DENSITY ALT = -105. M = -343. FT  
 SONIC SPEED = 326.1 M/SEC = 1072. IPS  
 RATE OF CLIMB = -50. M/MIN = -163. FPM

INERTIAL FLIGHT STATE

AXIS	CG LIN VEL (M/S)	HUB LIN VEL (FPS)	CG LIN ACC (G)	HUB LIN ACC (G)	AXIS	ANG POS (DEG)	ANG RATES (RAD/SEC)	ANG ACC (RAD/SEC2)		
X	54.94	180.3	-0.053	54.94	180.2	-0.059	ROLL	-1.1	.004	.012
Y	-1.19	-3.9	.039	-1.18	-3.9	.041	PITCH	-3.2	.002	.029
Z	-2.26	-7.4	-0.957	-2.26	-7.4	-0.956	YAW	339.8	.009	-0.044

CONTRJL ANGLES

M.R. COLL = 9.3 DEG HORIZ FIN = 7.8 DEG  
 A1 = -0.3 DEG T.R. COLL = -0.3 DEG  
 B1 = 4.8 DEG PEVAL POS = -0.2 DEG

ROTOK PARAMETERS

SHAFT ALPHA = -2.4 DEG  
 CONTROL ALPHA = -7.2 DEG  
 HGVFR TIP MACH = .69  
 TIP MAX-MACH = .80  
 TIP MIN-MACH = .53  
 .9R MAX-MACH = .79  
 .9R MIN-MACH = .46  
 DELTA PSI = 1.2 DEG  
 ENGINE POWER = 418. KW = 560. HP  
 THRUST FACTR = .899E+07 N = .202E+07 LEI

NASA LANGLEY FLIGHT DATA AH-1G ---- ROTOK PERFORMANCE AND LOADS

FLIGHT NO. 60 NU = .241 TOTAL CG = .000203 AMB TEMP = -8.6 C = 16.54 F  
 RUN NO. 6 V = 106.9 KT MAST CG = .000193 TEMP U60 = 9.1 C = 48.40 F  
 TIME 68740.73 NZ = .956 G GMEGA = 34.010 RAD/SEC CAN TEMP = -3.0 C = 26.58 F  
 CLP = .00376 RPM/324 = 1.002

RJTK ANGLES

THETA 3/4 (DEG) A0 = 6.9 A1 = -0.6 B1 = 5.5 PEAK-TO-PEAK = 11.0  
 TEETER ANG (DEG) A0 = -0.8 A1 = -1.8 B1 = .0 PEAK-TO-PEAK = 3.7

ROTOK LOADS (AMP/PHASE)

	OKAG BRACE (N/LEG)	CHJRD .449 (N-M/DEG)	CHDRU .803 (N-M/DEG)	PITCH LINK (N/DEG)	TORSION .449 (N-M/DEG)
MEAN	4218G.	13555.	2098.	-2314.	-307.
HARMONIC-1	3821./ -21.5	1100./ -24.9	218./ -48.1	2327./ -33.0	366./ -50.6
2	187./ -46.8	91./ 4.0	55./ -29.7	1799./ -42.0	184./ -37.7
3	2064./ 44.7	594./ 39.6	63./ -42.0	407./ -23.1	83./ 21.5
4	639./ 67.3	344./ 62.9	11./ 82.8	333./ -84.1	56./ 64.7
5	126./ -85.6	136./ -40.4	39./ -24.2	137./ 31.0	25./ 71.7
6	915./ -37.6	683./ -40.2	139./ -46.6	63./ -65.8	10./ 18.6
7	201./ 9.4	111./ 43.2	49./ 8.2	87./ 46.7	8./ 15.6
8	265./ -12.5	164./ -19.7	72./ -13.9	42./ 2.2	4./ 9.2
9	48./ -61.3	93./ -58.1	26./ -51.3	47./ -74.0	7./ 79.9
10	96./ -43.2	154./ -22.6	90./ -15.2	38./ 53.9	2./ 53.9
11	23./ 59.0	63./ 77.4	9./ 25.2	24./ -21.2	8./ -16.2
12	142./ -30.3	85./ -51.0	37./ -65.7	17./ -66.2	3./ -77.0
PEAK-TU-PEAK	12061.	4383.	1078.	7350.	1017.
	BEAM .174 (N-M/DEG)	BEAM .350 (N-M/DEG)	BEAM .449 (N-M/DEG)	BEAM .606 (N-M/DEG)	BEAM .803 (N-M/DEG)
MEAN	-237.	72.	-51.	-289.	29.
HARMONIC-1	717./ -51.7	398./ -61.9	410./ -62.4	393./ -63.8	179./ -74.8
2	387./ -52.9	252./ -68.9	271./ -67.2	228./ -64.7	87./ -62.8
3	69./ 61.6	36./ 17.4	43./ 64.8	73./ -80.1	84./ -85.1
4	293./ 60.4	85./ 49.1	48./ 41.8	64./ 61.8	114./ 47.6
5	79./ -22.1	9./ -83.5	19./ 71.3	7./ 86.2	49./ 68.6
6	24./ 76.0	4./ 69.0	10./ -24.3	13./ 10.1	37./ -24.6
7	47./ 65.1	10./ 54.4	26./ 89.8	12./ -9.2	36./ -47.0
8	6./ -58.7	3./ 3.8	5./ -55.4	8./ -5.4	17./ 5.4
9	24./ -47.5	13./ -73.2	5./ -48.8	16./ -43.2	12./ -28.2
10	64./ 7.5	17./ 14.4	15./ 4.5	23./ 27.5	17./ 26.6
11	14./ -29.1	9./ -14.0	4./ -9.1	8./ -18.5	7./ 12.1
12	13./ -62.1	4./ 14.3	6./ -15.8	3./ 4.1	5./ -5.3
PEAK-TO-PEAK	2439.	1186.	1210.	1174.	752.

FLIGHT NO. 061 A/C CRAFT TOTAL WT = 34378. N LOADED CG X= 5.04 M = 198.4 M  
 RUN NO. 3 7729. LB Y= -0.00 = -0.0  
 TIME 57558.00 (SFC) Z= 1.84 = 72.4

AERODYNAMIC FLIGHT STATE

T. AIRSPEED= 70.8 KT  
 A/C MACH NO= .111

DYNAMIC PRES= .85 KPA = 17.7 PSF  
 STATIC PRES= 97.5 KPA = 7036. PSF  
 TOTAL TEMP= 267.0 DEG K = 480.7 DEG R  
 STATIC TEMP= 266.4 DEG K = 479.5 DEG R

BODY ALPHA= -.2 OFG  
 BODY BETA= 2.6 RFG

DENSITY= 1.28 KG/M3 = .00248 SLUG/FT3  
 DENSITY ALT= -420. M = -1379. FT  
 SONIC SPEED= 327.7 M/SEC = 1075. FPS  
 RATE OF CLIMB= -36. M/MIN = -119. FPM

INERTIAL FLIGHT STATE

AXIS	CG LIN VFL (M/S)	VFL (FIX)	CG LIN ACC (G)	HUB LIN VFL (M/S)	VFL (FPS)	HUB LIN ACC (G)	AXIS	ANG POS (DEG)	ANG RATES (RAD/SEC)	ANG ACC (RAD/SEC2)
X	36.38	119.4	-.031	36.39	119.4	-.035	ROLL	-0.0	.002	.001
Y	1.61	5.4	-.004	1.64	5.4	-.004	PITCH	-1.2	-.006	.022
Z	-0.14	-5	-1.006	-0.14	-5	-1.006	YAW	101.6	.003	-.015

CONTROL ANGLES

M.P. COLL= 7.5 OFG HORIZ FIN= 6.7 OFG  
 A1= -.7 DEG T.P. COIL= -.5 OEG  
 B1= 2.5 DEG PEDAL POS= -.6 OEG

ROTOR PARAMETER

SHAFT ALPHA= -.2 DEG  
 CONTROL ALPHA= -2.7 DEG  
 HOVER TIP MACH= .69  
 TIP PAX-MACH\* .80  
 TIP MIN-MACH\* .58  
 .9R MAX-MACH\* .73  
 .9R FIN-MACH= .51  
 DELTA PSI= -2.6 DEG  
 ENGINE POWER= 316. KW = 424. HP  
 THRUST FACTOR= .928E+07 N = .209E+07 LB

NASA LANGLEY FLIGHT DATA AH-1G ---- ROTOR PERFORMANCE AND LOADS

FLIGHT NO. 61 MU= .160 TOTAL CQ= .000149 AMB TEMP= -6.8 C = 19.81 F  
 RUN NO. 3 V= 70.8 KT MAST CQ= .000141 TEMP U60= 10.3 C = 50.62 F  
 TIME 52557.88 NZ= 1.006 G OMEGA= 34.022 RAD/SFC CAN TEMP= 2.8 C = 37.06 F  
 CLP= .00369 RPM/324= 1.003

ROTOR ANGLES

THETA 3/4 (DEG) A0= 7.0 A1= -.9 B1= 2.5 PEAK-TO-PEAK, 5.3  
 TEFTER ANG (DEG) A0= -.8 A1= -.6 B1= .3 PEAK-TO-PEAK' 1.5

ROTOR LOADS (AMP/PHASE)

DRAG BRACE (N/DEG) CHORD .449 (N-M/DEG) CHORD .803 (N-M/DEG) PITCH LINK (N/DEG) TORSION .449 (N-M/DEG)

	43407.	12770.	2049.	-1150.	-185.
MFAM HARMONIC-1	3831./ -4.9	996./ -9.8	186./ -34.5	1459./ -17.0	218./ -57.5
2	566./ -33.2	408./ -28.5	16./ -57.3	480./ -2.0	27./ 7.3
3	581./ 24.8	198./ 19.6	60./ -26.6	319./ 7.5	68./ 65.0
4	177./ -79.5	123./ 10.4	21./ -64.5	88./ -38.9	9./ -13.7
5	137./ 38.6	57./ 29.0	13./ -61.3	63./ 34.9	21./ -37.2
6	368./ 87.8	129./ 48.8	42./ 51.4	130./ -79.8	29./ -68.7
7	134./ -10.0	137./ -39.2	49./ -74.7	54./ 35.0	10./ -21.0
8	77./ -25.9	24./ -17.6	16./ 62.5	32./ 2.3	3./ -24.1
9	101./ -65.9	111./ -70.3	73./ -84.6	68./ 31.6	4./ -66.7
10	28./ -63.2	27./ -5.0	25./ -11.5	56./ -61.2	9./ -10.9
11	41./ -29.6	65./ 58.2	32./ 59.8	29./ -26.9	9./ 89.9
12	93./ 48.9	38./ 18.3	16./ 49.9	12./ 84.8	3./ -53.5
PEAK-TO-PEAK	7980.	2629.	904.	3871.	601.

	RFAM .174 (N-M/DEG)	BEAM .350 (N-M/DEG)	BEAM .449 (N-M/DEG)	BFAM .606 (N-M/DEG)	BEAM .803 (N-M/DEG)
MEAN HARMONIC-1	-148.	124.	-34.	-285.	53.
2	375./ -40.9	233./ -77.5	251./ -74.8	250./ -66.0	93./ -74.8
3	103./ -8.7	121./ -32.0	160./ -27.1	184./ -23.0	105./ -29.9
4	154./ -23.2	34./ .9	25./ 48.9	54./ -47.7	118./ -23.9
5	106./ -4.9	38./ -6.0	27./ -10.2	27./ 24.2	28./ 73.7
6	94./ -29.7	13./ 13.1	16./ -38.8	29./ -14.4	17./ 14.6
7	15./ 89.3	6./ -17.5	10./ -65.2	5./ 44.2	32./ -45.6
8	27./ -69.8	13./ -46.8	21./ -59.8	18./ 11.5	36./ 72.0
9	41./ -7.2	7./ 58.3	9./ 19.2	13./ -54.9	25./ -16.7
10	35./ 12.1	21./ 37.5	12./ .7	31./ 56.6	36./ 75.2
11	33./ 73.7	12./ -71.3	8./ 82.7	10./ -53.5	12./ -6.7
12	13./ 65.2	14./ -51.1	9./ -1.9	5./ -18.9	3./ 9.8
17	17./ -86.0	11./ -65.1	5./ 29.2	6./ -75.9	3./ 86.1
PEAK-TO-PEAK	1392.	633.	735.	887.	664.

NASA LANGLEY FLIGHT DATA AH-1G ---- PADS PCM DATA

FLIGHT NO. 061 AIRCRAFT TOTAL WT = 34381. N LOADED CG X = 5.04 M = 198.4 IN  
 RUN NO. 4 7730. LB Y = -.00 = -.0  
 TIME 57606.70 (SEC) Z = 1.84 = 72.4

AERODYNAMIC FLIGHT STATE

DYNAMIC PRES = 1.09 KPA = 22.8 PSF  
 STATIC PRES = 97.5 KPA = 2037. PSF  
 TOTAL TEMP = 267.1 DEG K = 480.8 DEG R  
 STATIC TEMP = 266.3 DEG K = 479.3 DEG R  
 T. AIRSPEED = 10.4 KT  
 A/C MACH NO = .126  
 BODY ALPHA = -.2 DEG DENSITY = 1.28 KG/M3 = .00248 SLUG/FT3  
 BODY BETA = 1.3 DEG DENSITY ALT = -429. M = -1409. FT  
 SONIC SPEED = 327.7 M/SEC = 1075. FPS  
 RATE OF CLIMB = -72. M/MIN = -237. FPM

INERTIAL FLIGHT STATE

AXIS	FG LIN VEL (M/S)	FG LIN VEL (FPS)	CG U N ACC (G)	HUB LIN VEL (M/S)	HUB LIN VEL (FPS)	HUB LIN ACC (G)	AXIS	ANG POS (DEG)	ANG RATES (RAD/SEC)	ANG ACC (RAD/SEC <sup>2</sup> )
X	41.35	135.7	-.040	41.33	135.6	-.038	ROLL	-.0	-.012	-.032
Y	.95	3.1	.004	.93	3.0	-.003	PITCH	-1.8	.009	-.009
Z	-.13	-.4	-1.030	-.13	-.4	-1.030	YAW	102.1	-.006	.024

CONTROL ANGLES  
 M.P. COLL = 7.8 DEG HORIZ FIN = 6.9 OFG  
 A1 = -6 DEG T.P. COLL = -.8 OEG  
 B1 = 3.0 OEG PEDAL POS = -.6 OEG

ROTOR PARAMETERS

SHAFT ALPHA = -.2 DEG  
 CONTROL ALPHA = -3.2 DEG  
 HOVER TIP MACH = .69  
 TIP MAX-MACH = .82 DELTA PSI = -1.3 OFG  
 TIP MIN-MACH = .57  
 .9R MAX-MACH = .75 ENGINE POWER = 330. KW = 443. HP  
 .9R MIN-MACH = .50 THRUST FACTOR = .930E+07 N = .209E+07 LB

NASA LANGLEY FLIGHT DATA AH-1G ---- ROTOR PERFORMANCE AND LOADS

FLIGHT NO. 61 MU = .181 TOTAL CO = .000155 AMB TEMP = -6.9 C = 19.63 F  
 RUN NO. 4 V = 80.4 KT MAST CQ = .000146 TEMP U60 = 10.5 C = 50.88 F  
 TIME 52606.55 NZ = 1.030 G OMEGA = 34.069 RAD/SEC CAN TEMP = 2.4 C = 36.37 F  
 CLP = .00376 RPM/324 = 1.004

ROTOR ANGLES  
 THETA 3/4 (DEG) A0 = 7.3 A1 = -.8 R1 = 3.1 PEAK-TO-PEAK" 6.3  
 TEETER ANG (DEG) A0 = -.8 A1 = -1.0 R1 = .3 PEAK-TO-PEAK\* 2.2

ROTOR LOADS (AMP/PHASE)	DRAG BRACE (N/DEG)	CHORD .449 (N-M/DEG)	CHORD .803 (N-M/DEG)	PITCH LINK (N/DEG)	TORSION .449 (N-M/DEG)
MEAN	43219.	12842.	2056.	-1259.	-205.
HARMONIC-1	3622./ -0.1	953./ -3.1	183./ -35.6	1595./ -24.8	254./ -57.6
2	703./ -7.6	370./ -13.6	8./ 32.3	654./ -10.9	46./ -15.4
3	1424./ 18.0	392./ 19.7	65./ -15.4	373./ -9	68./ 48.4
4	236./ -37.3	147./ 77.7	25./ 42.0	125./ 67.0	8./ 42.6
5	364./ 55.7	72./ 44.7	28./ 27.0	172./ 80.1	41./ -37.3
6	663./ -89.5	369./ 87.4	128./ 71.2	179./ 88.2	36./ -65.0
7	227./ -71.4	145./ -73.9	65./ -63.3	66./ -85.1	11./ -5.4
8	26./ -37.8	74./ 50.8	34./ 73.9	21./ -54.6	2./ -61.5
9	89./ 36.3	151./ -29.4	82./ -38.6	94./ 42.2	5./ -58.7
10	21./ -1.9	107./ -35.0	41./ -80.9	110./ -64.1	17./ -34.1
11	49./ 34.0	83./ -42.0	34./ -60.8	55./ -45.3	10./ -35.8
12	119./ -30.5	69./ -82.9	35./ -19.9	39./ 43.1	13./ -1.5
PFAK-TO-PFAK	9384.	3142.	961.	4128.	630.

	BEAM .174 (N-M/DEG)	BEAM .350 (N-M/DEG)	BEAM .449 (N-M/DEG)	BEAM .606 (N-M/DEG)	BEAM .803 (N-M/DEG)
MFAN	-132.	119.	-46.	-297.	54.
HARMONIC-1	417./ -42.5	283./ -70.3	313./ -57.3	299./ -35.5	119./ -74.9
2	117./ -31.5	119./ -43.1	158./ -33.3	173./ -29.7	93./ -42.5
3	199./ -22.7	71./ .9	44./ 24.1	42./ -48.6	84./ -32.7
3	199./ -22.7	71./ .9	44./ 24.1	42./ -48.6	84./ -32.7
4	80./ -72.4	23./ 85.5	3./ 49.1	29./ -87.1	54./ -39.5
5	153./ 24.9	16./ 25.4	27./ 19.5	39./ 13.8	7./ 82.2
6	54./ 14.9	5./ -87.9	21./ 5.7	21./ 20.2	64./ 22.0
7	66./ 35.3	17./ 23.4	27./ 29.2	4./ 31.9	37./ 10.8
8	30./ 71.6	3./ 84.3	8./ 30.4	8./ 7.1	13./ 53.6
9	51./ 25.7	26./ 44.8	16./ 39.9	28./ 74.7	21./ -71.1
10	80./ 64.9	28./ 87.1	22./ 55.5	37./ -86.0	35./ -75.2
11	20./ -26.3	7./ -66.6	5./ 16.7	10./ -57.5	8./ 82.6
12	64./ -23.0	17./ .3	16./ -34.2	17./ -2.0	11./ -2.2
PEAK-TO-OFK	1430.	752.	865.	909.	632.

NASA LANGLEY FLIGHT DATA AH-1G ---- PADS PCM DATA

FLIGHT NO. 061 AIRCRAFT TOTAL WT = 33080. N LOADED CG X= 5.04 M = 198.4 IN  
 RUN NO. 12 7639. LB Y= -.00 \* -.0  
 TIME 53383.87 (SFC) Z= 1.84 = 72.6

**AERODYNAMIC FLIGHT STATE**  
 T. AIRSPEED= 134.6 KT DYNAMIC PRES= 3.06 KPA \* 63.8 PSF  
 A/C MACH NO= .212 STATIC PRES= 96.4 KPA \* 2014. PSF  
 TOTAL TEMP= 268.4 DEG K = 483.2 REG R  
 STATIC TEMP= 266.1 DEG K = 478.9 REG R  
 BODY ALPHA= -4.6 DEG DENSITY= 1.26 KG/M3 = .00245 SLUG/FT3  
 BODY BETA= -.5 DEG DENSITY ALT= -317. M = -1040. FT  
 IONIC SPEED= 327.5 M/SEC \* 1075. FPS  
 RATE OF CLIMB= -90. M/MIN \* -294. FPM

**INERTIAL FLIGHT STATE**

AXIS	CG LIN VEL (M/S)	CG U N ACC (G)	HUB LIN VEL (M/S)	HUB LIN ACC (G)	AXIS	ANG POS (DEG)	ANG RATES (RAD/SEC)	ANG ACC (RAD/SEC2)	
X	60.02	226.4	-0.091	69.03	226.5	-0.092	ROLL -2.0	-0.002	.078
Y	-.61	-2.0	.043	-.61	-2.0	.059	PITCH -5.8	-0.002	.005
Z	-5.57	-18.3	-.992	-5.57	-18.3	-.992	YAW 21.9	.005	.025

**CONTROL ANGLFS**

MR CULL- 12.1 DEG HORIZ FIN= 9.2 OFG  
 A1= -4 DEG T.R. COLL= .4 OFG  
 B1= 7.2 DEG PEDAL POS= .5 DEG

**ROTOR PARAMETERS**

SHAFT ALPHA= -4.6 DEG  
 CONTROL ALPHA= -11.8 DEG  
 HOVER TIP MACH= .69  
 TIP MAX-MACH= .90  
 TIP MIN-MACH= .48  
 .9R MAX-MACH= .83  
 .9R MIN-MACH= .41  
 OELTA PSI= .5 DEG  
 ENGINE POWER= 622. KW = 834. HP  
 THRUST FACTOR, .909E+07 N = .204E+07 LB

NASA LANGLEY FLIGHT DATA AH-1G ---- ROTOR PERFORMANCE AND LOADS

FLIGHT NO. 61 MU\* .305 TOTAL CO\* .000300 AMB TEMP- -7.1 C = 19.23 F  
 RUN NO. 12 V= 134.6 KT MAST CO= .000293 TEMP U60= 12.1 C = 53.84 F  
 TIME 53313.69 NZ= .992 G OMEGA= 33.848 RAD/SEC CAN TEMP- -1.1 C = 30.07 F  
 CLP\* .00367 RPM/324= .998

**ROTOR ANGLES**

THFTA 314 (DEG) A0= 11.5 A1= -4 B1= 8.3 PEAK-TO-PEAK- 16.8  
 TFETER ANG (DEG) A0= -0.9 A1= -2.6 B1= -0.5 PEAK-TO-PEAK\* 5.4

**ROTOR LOADS (AMP/PHASE)**

	DRAG BRACE (N/DEG)	CHORD .449 (N-M/DEG)	CHORD .803 (N-M/DEG)	PITCH LINK (N/DEG)	TORSION .449 (N-M/DEG)
MEAN	36629.	13945.	1855.	-3295.	-457.
HARMONIC-1	4898./ -60.4	1538./ -62.7	374./ -72.5	3681./ -45.6	522./ -50.5
2	1224./ -81.6	424./ 62.4	111./ -10.1	3163./ -47.1	352./ -51.6
3	3760./ 29.2	1128./ 32.1	41./ 21.2	447./ -66.8	103./ -8.4
4	721./ 25.1	476./ 1.1	76./ -31.7	487./ 75.7	67./ 14.3
5	418./ 85.6	298./ -84.7	97./ -63.0	245./ 31.1	54./ 64.3
6	332./ -26.4	267./ -28.3	61./ .3	337./ 1.8	37./ 23.2
7	351./ 54.6	210./ 55.4	69./ 62.6	26./ 82.7	9./ -37.9
8	50./ .6	106./ -25.8	28./ -49.8	47./ -44.7	7./ -22.4
9	108./ -36.3	51./ 22.3	19./ 50.0	38./ -54.2	2./ -47.6
10	74./ 61.4	151./ 71.1	64./ 65.8	32./ 47.1	1./ -73.2
11	64./ 9.2	72./ -43.6	38./ -60.9	18./ -13.1	5./ -32.8
12	110./ -63.4	22./ 1.0	12./ 3.8	17./ -34.0	2./ 74.8
PEAK-TO-PEAK	17491.	5781.	1245.	12692.	1490.

RFAM .174 (N-M/DEG) BEAU .350 (N-M/DEG) BEAM .449 (N-M/DEG) BEAM .606 (N-M/DEG) BEAM .803 (N-M/DEG)

	RFAM .174 (N-M/DEG)	BEAU .350 (N-M/DEG)	BEAM .449 (N-M/DEG)	BEAM .606 (N-M/DEG)	BEAM .803 (N-M/DEG)
MEAN	46.	121.	-15.	-241.	-8.
HARMONIC-1	1371./ -67.7	605./ -66.5	600./ -64.9	539./ -68.0	235./ -87.1
2	593./ -52.0	374./ -86.4	383./ -89.1	310./ -85.6	117./ -63.0
3	410./ 25.6	21./ 87.4	73./ 38.7	197./ 51.0	222./ 50.1
4	411./ 27.6	119./ 5.0	61./ -16.5	77./ 22.8	148./ 2.4
5	119./ -32.3	3./ 28.3	32./ 7.2	9./ -22.3	71./ 15.6
6	66./ -41.4	11./ 12.8	24./ -46.7	17./ -85.2	44./ -59.0
7	29./ -21.9	8./ -16.8	15./ 24.0	10./ -67.0	35./ 71.5
8	28./ 24.1	3./ -11.6	15./ 55.4	8./ -85.9	26./ -73.5
9	14./ -15.9	6./ 11.7	8./ -69.7	8./ 88.2	14./ -47.7
10	37./ 56.6	10./ 70.3	8./ 43.3	11./ -87.8	8./ -63.7
11	9./ -82.0	5./ 79.7	5./ -18.8	6./ -76.1	4./ -51.7
12	26./ 89.7	7./ -68.1	10./ -80.7	10./ -70.1	7./ -45.8
PEAK-TO-PEAK	4564.	1807.	1725.	1619.	1156.

FLIGHT NO. 061 AIRCRAFT TOTAL WT \* 33774. N LOADED CG X# 5.04 M \* 198.3 IN  
 RUN NO. 14 7593. LB Y# -0.00 Z# -0.0  
 TIME 53718.24 (SEC) Z# 1.85 \* 72.7

**AERODYNAMIC FLIGHT STATE**

DYNAMIC PRES= 3.80 KPA \* 79.3 PSF  
 STATIC PRES= 95.8 KPA \* 2001. PSF  
 TOTAL TEMP= 268.6 DEG K \* 483.5 DEG R  
 STATIC TEMP= 265.7 DEG K \* 478.2 DEG R  
 T. AIRSPEED= 150.2 KT  
 A/C MACH NO= .236  
 BODY ALPHA= -6.2 DEG  
 BODY BETA= .6 DEG  
 DENSITY= 1.26 KG/M3 \* .00244 SLUG/FT3  
 DENSITY ALT= -263. M \* -862. FT  
 SONIC SPEED= 327.3 M/SEC \* 1074. FPS  
 RATE OF CLIMB= -31. M/MIN \* -103. FPM

**INERTIAL FLIGHT STATE**

AXIS	CG LIN VEL (M/S)	CG LIN VEL (FPS)	CG LIN ACC (G)	HUB LIN VEL (M/S)	HUB LIN VEL (FPS)	HUB LIN ACC (G)	AXIS	ANG POS (DEG)	ANG RATES (RAD/SEC)	ANG ACC (RAD/SEC <sup>2</sup> )
X	76.82	252.0	-.120	76.80	252.0	-.133	ROLL	-2.1	-.004	-.014
Y	.86	2.8	.028	.85	2.8	.025	PITCH	-6.6	.009	.062
Z	-8.36	-27.4	-.972	-8.36	-27.4	-.972	YAW	211.0	.002	.001

**CONTROL ANGLES**

M.R. COLL= 14.1 DEG  
 A1= -.6 DEG  
 B1= 8.3 DEG  
 HORIZ FIN= 10.1 DEG  
 T.R. COLL= 1.6 DEG  
 PEDAL POS= 1.9 DEG

**ROTOR PARAMETERS**

SHAFT ALPHA\* -6.2 DEG  
 CONTROL ALPHA\* -14.5 DEG  
 HOVER TIP MACH\* .70  
 TIP MAX-MACH= .93  
 TIP MIN-MACH= .46  
 .9R PAX-MACH= .86  
 .9R MIN-MACH= .39  
 OFLTA PSI\* -.6 DEG  
 ENGINE POWER= 775. KW \* 1039. HP  
 THRUST FACTOR\* .918E+07 N \* .206E+07 LB

NASA LANGLEY FLIGHT DATA AH-1G ---- ROTOR PERFORMANCE AND LOADS

FLIGHT NO. 61 MU= .338 TOTAL CO= .000367 AMB TEMP= -7.5 C \* 18.52 F  
 RUN NO. 14 V= 150.2 KT MAST CO= .000363 TEMP U60= 13.3 C \* 55.97 F  
 TIME 53718.12 NZ= .972 G OMEGA= 34.088 RAD/SEC CAN TEMP= -1.5 C \* 29.38 F  
 CLP= .00354 RPM/324= 1.005

**ROTOR ANGLES**

THETA 3/4 (DEG) A0= 13.4 A1= -.3 B1= 10.0 PEAK-TO-PEAK" 20.1  
 TEFTER ANG (DEG) A0= -.9 A1= -2.9 B1= -1.0 PEAK-TO-PEAK- 6.2

**ROTOR LOADS (AMP/PHASE)**

	CRAG BRACE (N/DEG)	CHORD .449 (N-M/DEG)	CHORD .803 (N-M/DEG)	PITCH LINK (N/DEG)	TORSION .449 (N-M/DEG)
MEAN	34171.	14587.	1660.	-4190.	-583.
HARMONIC-1	6573./ -74.5	2126./ -73.8	513./ -75.6	4567./ -50.1	625./ -53.7
2	1773./ 68.4	769./ 32.1	193./ -8.6	4124./ -46.4	441./ -54.9
3	5525./ 29.0	1688./ 31.8	70./ 52.1	469./ 80.2	123./ -12.5
4	997./ -24.6	681./ -36.7	143./ -59.2	565./ 61.2	81./ .4
5	600./ 77.8	353./ -76.1	145./ -68.4	109./ 31.9	29./ 86.8
6	144./ -65.7	122./ -84.5	53./ 88.3	330./ 2.0	41./ 2.2
7	569./ -4.5	355./ -5.7	101./ -10.6	99./ 40.9	23./ -2.2
8	232./ 85.7	134./ 71.2	39./ 63.2	26./ 88.2	4./ -65.9
9	62./ -53.3	64./ -3.5	19./ 16.5	48./ -78.1	5./ -71.1
10	41./ 11.2	139./ 1.1	72./ -20.3	97./ 88.9	12./ 80.3
11	69./ -37.2	152./ -31.9	89./ -43.5	35./ 8.2	1./ -89.0
12	45./ 43.0	46./ -32.3	23./ -27.8	23./ -66.1	3./ 22.3
PEAK-TO-PEAK	23843.	7752.	1718.	15735.	1869.

	BEAM .174 (N-M/DEG)	BEAM .350 (N-M/DEG)	BEAM .449 (N-M/DEG)	BEAM .606 (N-M/DEG)	BEAM .803 (N-M/DEG)
MEAN	270.	139.	-1.	-225.	-19.
HARMONIC-1	1888./ -73.9	720./ -70.8	690./ -68.2	626./ -70.4	290./ -89.4
2	794./ -48.3	444./ -89.9	449./ 84.0	353./ 83.4	114./ -80.6
3	703./ 15.4	43./ 24.2	89./ 31.0	261./ 34.8	311./ 32.3
4	463./ 19.2	128./ -5.8	63./ -33.5	82./ 25.2	135./ -5.2
5	134./ -40.6	12./ 70.5	30./ -24.2	18./ -11.3	61./ -27.5
6	98./ -80.2	12./ 14.7	28./ -70.1	23./ 71.8	35./ -75.1
7	60./ -62.4	14./ -71.7	21./ -39.0	7./ 29.5	37./ -3.2
8	30./ 7.5	2./ -59.0	13./ 31.0	9./ 76.5	25./ 74.1
9	27./ 73.8	7./ 25.7	9./ -67.0	14./ 69.2	14./ -86.1
10	51./ 52.3	28./ 69.4	14./ 44.3	29./ 81.8	24./ -81.8
11	24./ -70.6	4./ -53.4	8./ 54.7	7./ -67.2	4./ -16.7
17	20./ 37.7	4./ 5.3	0./ 8.9	5./ 63.7	2./ 67.2
PEAK-TO-PEAK	6273.	2114.	2020.	1894.	1403.

FLIGHT NO. 061 AIRCRAFT TOTAL WT = 32470. N LOAOEO CG X = 5.03 M = 198.2 IN  
 RUN NO. 268 7300. LB Y = -0.00 Z = -0.0  
 TIME 55556.20 (SEC) Z = 1.87 = 73.6

AERODYNAMIC FLIGHT STATE

DYNAMIC PRES- 0.00 KPA = 0.0 PSF  
 STATIC PRES- 101.9 KPA = 2129. PSF  
 TOTAL TEMP\* 270.0 DEG K = 485.9 DEG R  
 STATIC TEMP- 270.0 DEG K = 485.9 DEG R  
 BODY ALPHA- 10.1 DEG DENSITY\* 1.32 KG/M3 = .00255 SLUG/FT3  
 BODY BETA" -15.4 DEG DENSITY ALT = -750. M = -2461. FT  
 SONIC SPEED- 329.9 M/SEC = 1082. FPS  
 RATE OF CLIMB" 0. M/MIN = 0. FPM

INERTIAL FLIGHT STATE

AXIS	CG LIN VEL (M/S)	CG LIN ACC (G)	HUB LIN VEL (M/S)	HUB LIN ACC (G)	AXIS	ANG POS (DEG)	ANG RATES (RAD/SEC)	ANG ACC (RAD/SEC2)	
X	0.00	0.0	.004	0.00	0.0	.005	ROLL -0.8	.000	-0.006
Y	0.00	0.0	.015	0.00	0.0	.014	PITCH -0.0	.003	-0.005
Z	0.00	0.0	-0.996	0.00	0.0	-0.996	YAW 5.3	-0.006	.024

CONTROL ANGLES

MP. COLL = 9.2 DEG HORIZ FIN = 6.5 DEG  
 A1 = -2.1 DEG T.R. COLL = 6.5 DEG  
 B1 = .4 DEG PEDAL POS = 6.6 DEG

ROTOR PARAMETERS

HOVER TIP MACH = .69 SHAFT ALPHA = 0.0 DEG HUB HEIGHT = 3.2 R  
 CONTROL ALPHA = -0.4 DEG  
 TIP MAX-MACH = .69 DELTA PSI\* = 0.0 OEG  
 TIP MIN-MACH = .69  
 .9R MAX-MACH = .62  
 .9R MIN-MACH = .62 THRUST FACTOR = .957E+07 N • .215E+07 LB

NASA LANGLEY FLIGHT DATA AH-1G ---- ROTOR PERFORMANCE AND LOADS

FLIGHT NO. 61 MU-0.000 TOTAL CQ = .000234 AMB TEMP -3.2 C = 26.24 F  
 RUN NO. 268 V = 0.0 KT MAST CQ = .000216 TEMP U60 = 12.7 C = 54.82 F  
 TIME 55556.09 NZ = .996 G OMEGA- 34.021 RAD/SEC CAN TEMP = .9 C = 33.57 F  
 CLP = .00339 RPM/324 = 1.003

ROTOR ANGLES

THETA 3/41 (DEG) A0 = 8.1 A1 = -1.5 R1 = .2 PEAK-TO-PEAK\* 2.9  
 TEETER ANG (DEG) A0 = -1.0 A1 = .1 R1 = -.6 PEAK-TO-PEAK\*\* 1.3

ROTOR LOADS (AMP/PHASE)

DRAG BRACE (N/DEG) CHORO .449 CHORD .803 PITCH LINK (N/DEG) TORSION .449 (N-M/DEG)

	MEAN	3078./	18.3	13397./	12.5	1656./	10.7	-1833./	-81.4	-219./	19.1	39.4
HARMONIC-1												
2		1449./	72.5	476.1	75.8	83./	62.5	130./	-13.3	8./	12.5	
3		728./	-69.1	352./	-83.1	51./	-69.6	159./	-22.0	47.1	-78.8	
4		364./	82.6	125./	-63.7	22.1	7.5	60./	49.9	15./	-16.3	
5		348./	82.3	68./	-58.5	24./	-5.4	140./	-32.4	27./	-19.6	
6		275./	82.1	97./	-89.2	20./	-70.7	43./	-77.3	10./	73.6	
7		183./	51.6	102./	36.1	18./	65.1	13./	-24.2	6./	-78.7	
8		182./	-80.9	107./	-62.1	42./	-47.5	37./	-76.0	2./	45.6	
9		146./	71.8	34./	-30.9	13./	-26.4	18./	73.0	3./	-75.8	
10		125./	88.7	114.1	46.0	23./	37.2	15./	-60.3	2./	-82.4	
11		64./	-80.1	29.1	-86.5	24./	-2.7	12./	80.0	1./	-82.6	
12		88./	63.3	24./	2.5	18./	-42.4	5./	1.9	1.1	.6	
PEAK-TO-PEAK		9027.		3391.		685.		2287.		147.		

BEAM .174 (N-M/DEG) BEAM .350 (N-M/DEG) BEAM .449 (N-M/DEG) BEAM .606 (N-M/DEG) BEAM .803 (N-M/DEG)

	MEAN	-59./	242./	136./	-3./	-261./					
HARMONIC-1											
2		179./	34.7	33./	34.6	170./	19.3	235./	6.7		
3		103./	55.3	29./	25.7	34./	19.4	52./	21.8	76./	24.4
4		14./	-5.5	11./	-85.4	18./	-84.7	23./	85.0	23./	56.7
5		65./	-46.1	15./	-30.7	7./	-20.9	5./	-43.8	7./	-88.8
6		25./	-29.6	2./	71.6	2./	-12.0	5./	79.9	8./	61.1
7		36./	61.9	1./	63.3	8./	-85.2	5./	65.4	15./	-84.6
8		6./	-50.0	1./	32.1	3./	51.4	2./	15.4	3./	25.1
9		4./	59.8	3./	-3.4	2./	1.4	4./	44.1	2./	-73.9
10		7./	-.4	3./	56.8	3./	-22.6	3./	-50.1	2./	-44.8
11		5./	55.4	2./	-75.6	2./	-59.8	1./	2.7	2./	75.2
12		2./	28.0	2./	17.5	1./	16.7	3./	-82.5	1./	-2.9
PEAK-TO-PEAK		4./	-14.9	1./	-45.4	1./	43.4	2./	49.7	1./	-26.1
		651.		145.		204.		382.		497.	

FLIGHT NO. 062 AIRCRAFT TOTAL WT = 35710. N LOADED CG X = 5.04 M = 198.6 IN  
 RUN NO. 16 3028. LB Y = -0.00 = -0.0  
 TIME 68261.70 (SEC) Z = 1.83 = 71.9

AERODYNAMIC FLIGHT STATE

DYNAMIC PRES = 1.96 KPA = 41.0 PSF  
 STATIC PRES = 94.3 KPA = 1973. PSF  
 1. AIRSPEED = 109.3 KT TWTAL TEMP = 267.2 DEG K = 481.0 DEG R  
 A/C MACH NO = .172 STATIC TEMP = 265.7 DEG K = 478.2 DEG R  
 BODY ALPHA = -1.4 DFG DENSITY\* = 1.24 KG/M3 = .00240 SLUG/FT3  
 BODY BETA = -1.3 DEG DENSITY ALT = -103. M = -339. FT  
 SONIC SPEED = 327.3 M/SEC = 1074. FPS  
 RATE OF CLIMB = -21. M/MIN = -67. FPM

INERTIAL FLIGHT STATE

AXIS	CG LIN VEL (M/S)	CG LIN VEL (FPS)	CG LIN ACC (G)	HUB LIN VEL (M/S)	HUB LIN VEL (FPS)	HUB LIN ACC (G)	AXIS	ANG POS (DEG)	ANG RATES (RAD/SEC)	ANG ACC (RAD/SEC2)
A	26.17	184.3	-.046	56.16	184.2	-.040	ROLL	-.9	.011	.030
Y	-1.29	-4.2	.034	-1.27	-4.2	.041	PITCH	-2.0	.006	-.026
Z	-1.61	-5.3	-1.016	-1.61	-5.3	-1.016	YAW	272.2	.005	-.064

CONTROL ANGLES

M.R. CULL = 5.3 DEG  
 A1 = -.4 DEG  
 B1 = 5.8 DEG  
 HORIZ FIN = 8.3 DEG  
 T.R. COLL = .4 DEG  
 PEDAL POS = .4 DEG

ROTOR PARAMETERS

HUVER TIP MACH = .70 SHAFT ALPHA = -1.6 DEG  
 CONTROL ALPHA = -7.4 DEG  
 TIP MAX-MACH = .87 DELTA PSI = 1.3 DEG  
 TIP MIN-MACH = .52  
 .9R MAX-MACH = .80 ENGINE POWER = 426. KW = 572. HP  
 .9R MIN-MACH = .45 THRUST FACTOR = .907E+07 N = .204E+07 LB

NASA LANGLEY FLIGHT DATA AH-1G ---- ROTOR PERFORMANCE AND LOADS

FLIGHT NO. 062 MU = .246 TOTAL CQ = .000205 AMB TEMP = -7.5 C = 18.53 F  
 RUN NO. 16 V = 109.3 KT MAST CQ = .000194 TEMP U60 = 11.4 C = 52.47 F  
 TIME 68261.55 NZ = 1.018 6 OMEGA\* 34.091 RAD/SEC CAN TEMP = -1.8 C = 28.66 F  
 CLP = .00396 RPM/324 = 1.005

ROTOR ANGLES

THETA 3/4 (DEG) A0 = 9.1 A1 = -.5 B1 = 6.3 PEAK-TO-PEAK = 12.1  
 FEETER ANG (DEG) A2 = -1.1 A1 = -2.2 B1 = .0 PEAK-TO-PEAK = 4.3

ROTOR LOADS (AMP/PHASE)

	DRAG BRACE (N/DEG)	CHORD .449 (N-M/DEG)	CHORD .803 (N-M/DEG)	PITCH LINK (N/DEG)	TORSION .449 (N-M/DEG)
MEAN	42191.	13478.	2096.	-2178.	-297.
HARMONIC-1	3376./ -33.8	925./ -36.4	255./ -58.1	2321./ -34.9	376./ -50.7
2	814./ 24.1	171./ -2.1	51./ -54.7	2164./ -44.0	220./ -37.7
3	2017./ 37.7	533./ 38.5	28./ 3.7	334./ -8.0	89./ 21.5
4	415./ 50.0	261./ 50.6	23./ -32.2	490./ -86.4	58./ 64.6
5	118./ 72.6	43./ -31.5	54./ 1.9	237./ 35.0	37./ 57.3
6	456./ -50.3	388./ -58.8	52./ -65.9	150./ -27.5	11./ -39.7
7	403./ 87.7	324./ -71.0	61./ 85.9	96./ 65.2	15./ 73.0
6	173./ 15.4	91./ -20.3	49./ -6.5	89./ -34.0	8./ -46.7
9	9./ -55.3	104./ -75.4	23./ -70.7	62./ 80.1	5./ 36.9
10	80./ -70.8	162./ -45.5	78./ -51.3	54./ 61.0	10./ -73.3
11	46./ 42.6	76./ -15.4	43./ -13.2	30./ -3.0	8./ 34.8
12	46./ -9.7	28./ 61.9	26./ -17.9	15./ 56.5	5./ 31.3
PEAK-TO-PEAK	11236.	3869.	1010.	8364.	1104.

	BEAM .174 (N-M/DEG)	BEAM .350 (N-M/DEG)	BEAM .449 (N-M/DEG)	BEAM .606 (N-M/DEG)	BEAM .803 (N-M/DEG)
MEAN	-174.	97.	-47.	-275.	34.
HARMONIC-1	671./ -56.2	420./ -64.4	435./ -65.0	413./ -67.9	197./ -84.5
2	458./ -60.9	286./ -74.0	303./ -72.3	239./ -70.9	73./ -65.0
3	94./ 69.9	36./ 1.1	44./ 54.4	83./ 81.4	94./ 77.3
4	401./ 62.5	109./ 49.6	55./ 34.8	86./ 62.8	147./ 47.7
5	101./ 21.7	1./ -60.1	32./ 58.1	10./ 54.6	59./ 40.3
6	63./ -46.1	6./ -29.2	29./ -47.8	18./ -35.5	60./ -44.5
7	50./ 34.3	9./ 65.2	25./ 66.8	9./ -46.4	34./ -61.5
8	29./ -63.9	2./ 55.3	14./ -65.0	8./ -21.1	26./ -5.7
9	26./ 45.5	17./ 71.7	5./ 25.1	17./ -83.5	10./ -35.4
10	46./ 7.7	18./ 23.7	11./ -1.1	24./ 31.2	20./ 45.1
11	8./ 25.0	10./ -33.0	1./ 80.2	3./ -2	2./ 2.1
12	28./ -13.0	9./ -11.5	9./ -2.9	9./ -4.2	5./ 19.5
PEAK-TO-PEAK	2780.	1264.	1353.	1326.	857.

FLIGHT NO. 062 AIRCRAFT TOTAL WT = 35321. N LOADED CG X = 5.04 M = 196.6 IN  
 NUN Nil. 23 7941. LB Y = -.00 = -.0  
 TIME 68880.70 (SEC) Z = 1.83 = 72.1

AERODYNAMIC FLIGHT STATE  
 DYNAMIC PRES = 1.96 KPA = 41.0 PSF  
 STATIC PRES = 94.4 KPA = 1972. PSF  
 T. AIRSPEED = 109.2 KT TOTAL TEMP = 267.3 DEG K = 481.1 DEG R  
 A/C MACH NO = .172 STATIC TEMP = 265.7 DEG K = 478.2 DEG R  
 BODY ALPHA = .6 DEG DENSITY = 1.24 KG/M3 = .00240 SLUG/FT3  
 BODY BETA = 5.9 DEG DENSITY ALT = -111. M = -364. FT  
 SONIC SPEED = 327.3 M/SEC = 1074. FPS  
 RATE OF CLIMB = -381. M/MIN = -1252. FPM

INERTIAL FLIGHT STATE

AXIS	CG LIN VEL (M/S)	CG LIN VEL (FPS)	CG LIN ACC (G)	HUB LIN VEL (M/S)	HUB LIN VEL (FPS)	HUB LIN ACC (G)	AXIS	ANG POS (DEG)	ANG RATES (RAD/SEC)	ANG ACC (RAD/SEC2)
X	55.67	163.3	-.071	53.58	182.4	-.074	ROLL	45.0	-.004	.032
Y	5.75	18.9	-.054	5.74	18.8	-.051	PITCH	-1.8	.141	.016
Z	.62	2.0	-1.414	.62	2.0	-1.410	YAW	203.7	.124	-.004

CONTROL ANGLES  
 M.R. COLL = 9.3 DEG HORIZ FIN = 7.3 DEG  
 A1 = .0 DEG T.R. COLL = .6 DEG  
 B1 = 4.1 DEG PEDAL POS = .0 DEG

ROTOR PARAMETERS

HOVER TIP MACH = .70 SHAFT ALPHA = .6 DEG  
 CONTROL ALPHA = -3.4 DEG  
 TIP MAX-MACH = .87 DELTA PSI = -5.9 DEG  
 TIP MIN-MACH = .53  
 .9R MAX-MACH = .80 ENGINE POWER = 354. KW = 475. HP  
 .9R MIN-MACH = .4h THRUST FACTOR = .918E+07 N = .206E+07 LB

NASA LANGLEY FLIGHT DATA AH-1G ---- ROTOR PERFORMANCE AND LOADS

FLIGHT NU. 62 MU = .244 TOTAL CQ = .000167 AMB TEMP = -7.5 C = 18.57 F  
 RUN NO. 23 V = 109.7 KT VAST CQ = .000158 TEMP U60 = 11.4 C = 52.57 F  
 TIME 68880.55 NZ = 1.410 G UMGGA = 34.304 RAD/SEC CAN TEMP = -1.8 C = 28.68 F  
 CLF = .00540 RPM/324 = 1.011

ROTOR ANGLES THETA 3/4 (DEG) A0 = 8.7 A1 = .4 B1 = 4.2 PEAK-TO-PEAK b.8  
 TEETER ANG (DEG) A0 = -1.1 A1 = -.9 B1 = .9 PEAK-TO-PEAK\* 2.5

ROTOR LOADS (AMP/PHASE) DRAG BRACE (N/DEG) CHORD .449 (N-M/DEG) CHORD .803 (N-M/DEG) PITCH LINK (N/DEG) TORSION .449 (N-M/DEG)

MEAN HARMONIC	DRAG BRACE (N/DEG)	CHORD .449 (N-M/DEG)	CHORD .803 (N-M/DEG)	PITCH LINK (N/DEG)	TORSION .449 (N-M/DEG)
1	4115. / -10.5	13186. / -10.4	2233. / -70.4	-1753. / -43.8	-279. / -66.4
2	1466. / -46.4	593. / -56.2	13. / -75.6	1611. / -43.0	179. / -28.1
3	2289. / 13.2	655. / 18.0	59. / 1.4	324. / 10.9	78. / 15.9
4	555. / 15.6	297. / -4	02. / -28.7	426. / 78.9	71. / 28.5
5	574. / -74.1	92. / 49.0	38. / 21.4	107. / -57.2	30. / -63.5
6	1546.1 / -90.0	1064. / 83.9	222. / 81.1	181. / -17.0	48. / -7.5
7	214. / 36.7	42. / -73.7	44. / 71.1	88. / -31.4	9. / -12.0
8	30.1 / 79.6	38. / -35.5	24. / 41.9	50. / -73.1	3. / -19.2
9	102. / 18.9	130. / 42.9	35. / 5.1	142. / 18.1	9. / 66.9
10	111.1 / -54.4	20. / -73.6	50. / -75.2	95. / -72.3	11. / -61.6
11	56. / 67.3	39. / -2.8	35. / 48.3	26. / 9.1	8. / -74.1
12	123. / 43.1	91. / 51.4	47. / 12.5	27. / 77.3	7. / -13.6
PEAK-TO-PEAK	14982.	5635.	1266.	6611.	972.

MEAN HARMONIC	BEAM .174 (N-M/DEG)	BEAM .350 (N-M/DEG)	BEAM .449 (N-M/DEG)	BEAM .606 (N-M/DEG)	BEAM .803 (N-M/DEG)
1	187. / -42.2	100. / -73.2	-87. / -75.3	-367. / -78.8	170. / 86.2
2	478. / -62.6	424. / -87.4	458. / -85.9	288. / -88.4	127. / 74.7
3	85. / -66.2	60. / -21.2	62. / 18.2	97. / 52.9	109. / 57.9
4	363. / 31.9	108. / 16.5	60. / 2.9	81. / 26.2	159. / 8.1
5	142. / -81.2	20. / 83.1	26. / 9.1	30. / -71.1	66. / 45.1
6	126. / 55.3	13. / -1.9	8. / -42.7	12. / -24.0	49. / 65.4
7	96. / -18.5	14. / -18.7	43. / 3.3	22. / 57.1	86. / 41.7
8	42. / -36.0	15. / 30.0	11. / -46.4	21. / 66.9	36. / 76.5
9	84. / -3.8	49. / 18.0	25. / -1.3	50. / 34.2	46. / 49.3
10	61. / 75.9	26. / -83.4	19. / 75.2	37. / -79.3	32. / -74.9
11	9. / 70.9	10. / 46.0	9. / 57.6	3. / -47.0	8. / 42.1
12	62. / 14.6	18. / 22.7	17. / 3.4	13. / 22.7	2. / 70.4
PEAK-TO-PEAK	2289.	1301.	1493.	1420.	1062.



FLIGHT NO. 062 AIRCRAFT TOTAL WT = 35282. N LOADED CG X = 5.04 M = 198.6 IN  
 RUN NO. 24 7932. LB Y = -0.00 Z = 1.83  
 TIME 68939.10 (SEC)

AERODYNAMIC FLIGHT STATE

DYNAMIC PRES = 1.91 KPA = 39.8 PSF  
 STATIC PRES = 94.3 KPA = 1970. PSF  
 TOTAL TEMP = 267.3 DEG K = 481.1 DEG R  
 STATIC TEMP = 265.7 DEG K = 478.3 DEG R  
 T. AIRSPEED = 107.7 KT  
 A/C MACH NO = .169  
 DENSITY = 1.24 KG/M3 = .00240 SLUG/FT3  
 DENSITY ALT = -100. M = -329. FT  
 SONIC SPEED = 327.3 M/SEC = 1074. FPS  
 RATE OF CLIMB = -199. M/MIN = -652. FPM  
 BODY ALPHA = -.6 DEG  
 BODY BETA = 3.3 DEG

INERTIAL FLIGHT STATE

AXIS	CG LIN (M/S)	VEL (FPS)	CG LIN ACC (G)	HUB LIN VEL (M/S)	VEL (FPS)	HUB LIN ACC (G)	AXIS	ANG PUS (DEG)	ANG RATES (RAD/SEC)	ANG ACC (RAD/SEC2)
X	55.31	121.5	-.062	55.18	121.0	-.059	ROLL	33.0	.005	-.0008
Y	3.18	10.4	-.018	3.19	10.5	-.021	PITCH	-2.2	.063	-.016
Z	-0.62	-2.0	-1.236	-0.62	-2.0	-1.235	YAW	341.1	.095	.012

CONTROL ANGLES

M.R. COLL = 9.4 DEG  
 A1 = -2 DEG  
 B1 = 5.0 DEG  
 HORIZ FIN = 7.9 DEG  
 T.R. COLL = .7 DEG  
 PEDAL POS = .2 DEG

ROTOR PARAMETERS

SHAFT ALPHA = -.6 DEG  
 CONTROL ALPHA = -5.6 DEG  
 HOWER TIP MACH = .70  
 TIP MAX-MACH = .87  
 TIP MIN-MACH = .53  
 .9R MAX-MACH = .80  
 .9R MIN-MACH = .46  
 DELTA PSI = -3.3 DEG  
 ENGINE POWER = 412. KW = 552. HP  
 THRUST FACTOR = .909E+07 N = .204E+07 LB

NASA LANGLEY FLIGHT DATA AH-1G ---- ROTOR PERFORMANCE AND LOADS

FLIGHT NO. 62 MU = .242 TOTAL CG = .000197 AMB TEMP = -7.4 C = 18.63 F  
 RUN NO. 24 V = 107.7 KT MAST CG = .000183 TEMP U60 = 11.4 C = 52.45 F  
 TIME 66938.96 NZ = 1.235 G OMEGA = 34.159 RAD/SEC CAN TEMP = -1.8 C = 28.68 F  
 CLP = .00475 RPM/324 = 1.007

ROTOR ANGLES

THETA 314 (DEG) A0 = 8.9 A1 = .2 B1 = 5.0 PEAK-TO-PEAK = 10.2  
 TETHER ANG (DEG) A2 = -1.1 A3 = -1.4 B2 = .6 PEAK-TO-PEAK = 3.0

ROTOR LOADS (AMP/PHASE)

	DRAG BRACE (N/DEG)	CHORD .449 (N-M/DEG)	CHORD .803 (N-M/DEG)	PITCH LINK (N/DEG)	TORSION .449 (N-M/DEG)
MEAN	43075.	13399.	2133.	-1968.	-289.
HARMONIC-1	3932./ -22.0	990./ -24.3	259./ -58.5	2065./ -41.3	337./ -58.4
2	995./ -13.0	344./ -42.8	19./ -66.0	1785./ -47.0	187./ -35.9
3	2315./ 27.3	636./ 28.3	40./ -2.6	269./ -4.5	79./ 16.6
4	504./ 26.7	218./ 20.8	29./ -19.5	428./ 84.5	59./ 34.7
5	369./ 89.1	101./ 58.6	45./ 33.4	128./ -13.9	27./ 66.7
6	1079./ -69.9	767./ -76.3	162./ -81.2	81./ 21.3	23./ 18.4
7	242./ -85.6	267./ -84.1	37./ -81.6	60./ 23.7	14./ 39.1
8	55./ 9.0	47./ -51.1	13./ -50.2	54./ -67.0	7./ 73.8
9	164./ 60.4	85./ -84.0	27./ 60.8	86./ 40.4	1./ -6.8
10	91./ -39.0	61./ -20.3	47./ -42.8	69./ -35.1	8./ 9.9
11	61./ 27.7	108./ -28.6	47./ -57.9	11./ 29.6	6./ -9.1
12	126./ -84.6	55./ 51.6	43./ 57.1	28./ -15.4	1./ -75.3
PEAK-TO-PEAK	12306.	4755.	1014.	7077.	984.

	BEAM .174 (N-M/DEG)	BEAM .350 (N-M/DEG)	BEAM .449 (N-M/DEG)	BEAM .606 (N-M/DEG)	BEAM .803 (N-M/DEG)
MEAN	24.	95.	-77.	-326.	108.
HARMONIC-1	571./ -55.8	422./ -71.3	445./ -73.1	440./ -75.0	240./ -88.4
2	346./ -66.0	262./ -82.0	301./ -80.3	252./ -80.5	100./ 89.7
3	52./ -73.3	54./ -5.0	59./ 33.3	79./ 68.5	95./ 65.8
4	331./ 46.5	101./ 33.1	56./ 20.8	78./ 43.9	132./ 29.2
5	94./ -71.0	15./ 80.8	27./ 41.1	11./ -81.2	64./ 52.9
6	60./ 77.8	11./ 10.1	10./ 35.1	16./ -41.9	49./ -86.0
7	37./ -9.6	9./ 11.7	25./ 35.3	19./ -77.3	51./ 86.6
8	26./ -14.7	7./ 53.7	7./ -40.0	16./ -71.8	29./ -51.5
9	48./ 21.3	32./ 39.5	14./ 30.0	34./ 59.1	29./ 74.1
10	43./ -72.0	20./ -44.6	12./ -62.2	25./ -41.2	21./ -33.5
11	10./ 84.1	8./ 89.3	5./ -82.1	1./ 79.2	4./ 86.6
12	38./ 87.8	11./ 88.5	12./ -80.4	9./ -73.6	4./ -53.2
PEAK-TO-PEAK	2067.	1264.	1402.	1326.	925.

FLIGHT NO. 062 AIRCRAFT TOTAL WT = 35188. N LOAOEU CG X = 5.04 M = 198.5 IN  
 RUN NO. 26 7911. LB Y = -.00 = -.0  
 TIME 69103.20 (SEC) Z = 1.33 = 72.1

ATRODYNAMIC FLIGHT STATE

UYNAMIC PRES = 1.82 KPA = 38.0 PSF  
 STATIC PRES = 94.4 KPA = 1972. PSF  
 TOTAL TEMP = 267.2 DEG K = 480.9 DEG R  
 STATIC TEMP = 205.7 DEG K = 478.3 DEG R  
 T. AIRSPEED = 105.2 KT  
 A/C MACH NO = .165  
 BODY ALPHA = -2.1 DEG  
 BODY BETA = -1.5 DEG  
 DENSITY = 1.24 KG/M3 = .00240 SLUG/FT3  
 DENSITY ALT = -109. M = -358. FT  
 SONIC SPEED = 327.3 M/SEC = 1074. FPS  
 RATE OF CLIMB = 7. M/MIN = 22. FPM

INITIAL FLIGHT STATE

AXIS	CG LIN VEL (M/S)	CG LIN VEL (FPS)	CG LIN ACC (G)	HUB LIN VEL (M/S)	HUB LIN VEL (FPS)	HUB LIN ACC (G)	AXIS	ANG POS (DEG)	ANG RATES (RAD/SEC)	ANG ACC (RAD/SEC2)
X	54.07	177.4	-.054	54.06	177.4	-.052	ROLL	-2.1	.008	-.061
Y	-1.42	-4.7	.039	-1.40	-4.6	.027	PITCH	-2.0	.002	-.008
Z	-2.01	-6.6	-.993	-2.01	-6.6	-.993	YAW	270.9	.003	-.043

CONTROL ANGLES

M.R. COLL = 9.1 DEG  
 A1 = -.7 LEG  
 B1 = 5.3 DEG  
 HORIZ FIN = 8.0 DEG  
 T.R. CULL = .4 DEG  
 PEDAL POS = .4 OEG

ROTOR PARAMETERS

HOVER TIP MACH = .69  
 TIP MAX-MACH = .86  
 TIP MIN-MACH = .53  
 .9R MAX-MACH = .79  
 .9R MIN-MACH = .46  
 SHAFT ALPHA = -2.1 OEG  
 CONTROL ALPHA = -7.4 DEG  
 DELTA PSI = 1.5 DEG  
 ENGINE POWER = 428. KW = 575. HP  
 THRUST FACTOR = .904E+07 N = .203E+07 LB

NASA LANGLEY FLIGHT DATA AH-1G ---- ROTOR PERFORMANCE AND LOADS

FLIGHT NO. 62 MU = .237 TOTAL CQ = .000207 AMB TEMP = -7.4 C = 18.65 F  
 RUN NO. 26 V = 105.2 KT MAST CQ = .000198 TEMP U60 = 12.0 C = 53.59 F  
 TIME 69103.05 NZ = .993 C OMEGA = 34.032 RAD/SEC CAN TEMP = -1.8 C = 28.68 F  
 CLP = .00384 RPM/324 = 1.003

ROTOR ANGLES

THETA 314 (DEG) AO = 8.9 A1 = -.7 B1 = 5.5 PEAK-TO-PEAK = 11.3  
 TEETER ANG (DEG) AO = -1.1 A1 = -1.9 B1 = -.0 PEAK-TO-PEAK = 3.8

ROTOR LOADS (AMP/PHASE)

	DRAG BRACE (N/DEG)	CHORD .449 (N-M/DEG)	CHORD .803 (N-M/DEG)	PITCH LINK (N/DEG)	TORSION .449 (N-M/DEG)
MEAN	41867.	13640.	1950.	-2124.	-294.
HARMONIC-1	3622./ -16.8	989.1 -21.7	230./ -46.7	2256./ -32.9	355./ -49.8
2	489./ -36.7	138./ -65.7	50./ -29.1	1848./ -44.7	206./ -40.8
3	2160./ 43.6	605./ 41.7	53./ -13.7	398./ -19.7	83./ 22.2
4	458./ 70.7	243./ 63.3	36./ -66.3	344./ -86.4	56./ 67.5
5	20./ 36.4	97./ -59.7	30./ -.9	211./ 26.0	32./ 48.6
6	948./ -30.2	667./ -35.6	147./ -40.3	76./ -74.2	8./ 43.7
7	310./ 53.7	203./ 62.0	53./ 34.5	103./ 55.7	8./ 23.1
8	215./ 6.2	172./ 2.0	50./ 18.4	49./ -42.1	2./ -47.8
9	35./ -56.5	67./ -77.5	26./ -74.8	31./ 87.6	5./ 45.9
10	104./ -24.5	71./ -30.3	43./ .3	59./ 61.2	3./ 83.5
11	49./ -78.3	54./ 75.8	9./ -42.9	23./ -68.9	5./ 21.9
12	151./ -67.8	107./ -56.8	01./ -67.2	14./ -41.7	3./ 42.0
PEAK-TO-PEAK	12306.	4486.	1012.	7395.	1016.
	BEAM .174 (N-M/DEG)	BEAM .350 (N-M/DEG)	BEAM .449 (N-M/DEG)	BEAM .606 (N-M/DEG)	BEAM .803 (N-M/DEG)
MEAN	-217.	85.	-55.	-282.	41.
HARMONIC-1	674./ -51.2	392./ -62.9	409./ -63.3	391./ -65.1	174./ -78.8
2	359./ -54.0	246./ -71.1	265./ -69.4	214./ -67.3	72./ -60.2
3	68./ 57.9	42./ 22.8	48./ 57.3	75./ -86.9	91./ 89.0
4	279./ 58.9	84./ 47.1	46./ 38.0	61./ 61.7	112./ 42.2
5	87./ -23.6	9./ 62.7	18./ 54.7	7./ 86.4	51./ 54.0
6	23./ -69.3	5./ 34.4	2./ -44.0	13./ 25.2	22./ -34.1
7	53./ 60.5	12./ 60.7	29./ 79.3	8./ -29.6	38./ -65.8
8	14./ -61.4	3./ -8.6	5./ -72.5	4./ -13.0	18./ -24.5
9	18./ 74.2	16./ -88.5	4./ 90.0	14./ -72.7	14./ -63.7
10	49./ -.3	21./ 13.1	12./ 3.4	23./ 30.1	17./ 26.0
11	16./ 29.5	8./ -16.0	7./ 33.9	8./ -1.2	8./ 27.4
12	1./ 76.3	2./ -26.9	4./ 5.8	4./ 26.7	3./ 44.7
PEAK-TO-PEAK	2288.	1152.	1209.	1145.	743.

FLIGHT NO. 062 AIRCRAFT TOTAL WT = 35046. N LOADED CG X = 5.04 M = 198.5 IN  
 RUN NO. 30 7879. LB Y = -.00 Z = -.0  
 TIME 69369.90 (SEC) Z = 1.83 = 72.1

AERODYNAMIC FLIGHT STATE

DYNAMIC PRES = 1.80 KPA = 37.7 PSF  
 STATIC PRES = 94.3 KPA = 1970. PSF  
 TOTAL TEMP = 267.4 DEG K = 481.4 DEG R  
 STATIC TEMP = 266.0 DEG K = 478.8 DEG R  
 T. AIRSPEED = 104.8 KT  
 A/C MACH NO = .165  
 DENSITY = 1.24 KG/M3 = .00240 SLUG/FT3  
 DENSITY ALT = -87. M = -286. FT  
 SONIC SPEED = 327.5 M/SEC = 1074. FPS  
 RATE OF CLIMB = -373. M/MIN = -1225. FPM  
 6001 ALPHA = 5.1 DEG  
 BODY BETA = 4.6 DEG

INERTIAL FLIGHT STATE

AXIS	CG LIN VEL (M/S)	HUB LIN VEL (FPS)	CG LIN ACC (G)	HUB LIN ACC (G)	AXIS	ANG POS (DEG)	ANG RATES (RAD/SEC)	ANG ACC (RAD/SEC2)
X	53.54	175.7	-0.057	53.53	ROLL	1.8	.007	.002
Y	4.31	14.1	-0.048	4.32	PITCH	-1.4	0.06	-0.006
Z	4.81	15.8	-1.027	4.81	YAW	21.9	-0.024	.020

CONTROL ANGLES

M.R. COLL = 6.5 DEG HORIZ FIN = 7.5 OEG  
 A1 = .3 DEG T.K. COLL = .2 DEG  
 B1 = 4.5 DEG PEDAL POS = .5 DEG

ROTOR PARAMETERS

SHAFT ALPHA = 5.1 DEG  
 HOVER TIP MACH = .70 CONTROL ALPHA = .7 OEG  
 TIP PAX-MACH = .87 DELTA PSI = -4.6 OEG  
 TIP MIN-MACH = .54  
 .9R FAX-MACH = .80 ENGINE POWER = 206. KW = 276. HP  
 .9R MIN-MACH = .47 THRUST FACTOR = .916E+07 N = .206E+07 LB

NASA LANGLEY FLIGHT DATA AH-1G ---- ROTOR PERFORMANCE AND LOADS

FLIGHT NO. 62 MU = .236 TOTAL CW = .000098 AMB TEMP = -7.2 C = 19.11 F  
 RUN NO. 30 V = 104.8 KT MAST CW = .000086 TEMP U60 = 10.9 C = 51.57 F  
 TIME 69360.83 NZ = 1.027 G OMEGA = 34.136 RAD/SEC CAN TEMP = -1.8 C = 28.68 F  
 CLP = .00394 RPM/324 = 1.006

ROTOR ANGLES

THETA 3/4 (DEG) A0 = 6.0 A1 = .4 B1 = 4.4 PEAK-TO-PEAK = 8.7  
 TEETER ANG (DEG) A0 = -1.1 A1 = -1.8 B1 = .8 PEAK-TO-PEAK = 3.8

ROTOR LOADS (AMP/PHASE)

	DRAG BRACE (N/DEG)	CHORD .449 (N-M/DEG)	CHORD .803 (N-M/DEG)	PITCH LINK (N/DEG)	TORSION .449 (N-M/DEG)
MEAN	47463.	12576.	2420.	-858.	-187.
HARMONIC-1	1938./ -9	379./ 3.3	121./ -61.9	2388./ -42.9	362./ -66.5
2	1394./ -31.3	366./ -44.8	27./ -1.3	1561./ -63.7	158./ -52.3
3	2728./ -10.8	742./ -8.5	57./ -36.5	436./ -53.2	87./ -21.5
4	771./ 4.8	421./ -6.9	52./ -28.6	531./ 38.4	85./ 4.2
5	411./ -15.9	154./ 37.4	38./ 29.3	332./ -19.7	48./ 15.3
6	550./ 65.3	359./ 67.2	43./ -88.1	111./ -72.4	8./ -16.1
7	136./ 47.2	105./ 87.3	24./ 81.3	148./ -37.4	14./ -40.7
8	36./ 26.8	61./ 15.8	38./ 38.4	6./ -9.9	12./ -34.6
9	95./ 29.8	95./ -20.9	31./ 34.4	53./ -89.9	5./ -36.4
10	112./ -13.6	110./ 11.4	85./ 30.6	74./ 11.2	11./ 48.0
11	12./ 7.4	76./ 40.6	4./ 4.1	47./ 45.0	3./ -36.0
12	66./ -2.8	55./ -25.1	3./ 84.5	35./ 18.1	5./ 84.3
PEAK-TO-PEAK	10166.	3202.	864.	7880.	1002.
	BEAM .174 (N-M/DEG)	BEAM .350 (N-M/DEG)	BEAM .449 (N-M/DEG)	BEAM .605 (N-M/DEG)	BEAM .803 (N-M/DEG)
MEAN	-456.	7.	-139.	-352.	44.
HARMONIC-1	519./ -57.7	410./ -75.0	424./ -77.0	373./ -81.5	161./ 88.8
2	313./ -81.4	248./ 85.5	273./ 87.7	236./ -89.3	75./ 82.4
3	214./ 85.9	77./ -54.8	61./ -7.8	93./ 39.3	108./ 32.6
4	551./ .3	156./ -13.8	70./ -21.5	106./ -.8	178./ -8.1
5	228./ -60.5	13./ 76.3	37./ -19.3	30./ -56.8	42./ 16.3
6	39./ 86.0	10./ -71.0	35./ 71.8	19./ 65.9	83./ 77.0
7	125.1 73.6	24./ 85.6	36./ -85.2	5./ -72.0	26./ -6.3
8	55./ 76.0	15./ 87.2	11./ -74.0	21./ -83.5	28./ 86.5
9	33./ 76.2	28./ 82.5	9./ -85.8	40./ 89.9	47./ -84.0
10	45./ -60.6	16./ -30.9	9./ -52.7	24./ -49.1	22./ -53.9
11	19.1 46.2	12./ 29.2	2./ -69.4	8./ 26.7	3./ 20.4
12	45.1 -22.1	10./ 1.5	8./ -29.3	11./ -8.7	3./ 32.3
PEAK-TO-PEAK	2922.	1362.	1330.	1201.	963.

FLIGHT NO. 062 AIRCRAFT TOTAL WT = 34965. N LOADED CG X = 5.04 N = 198.5  
 RUN NO. 31 7861. LB Y = -.00 = -.0  
 TIME 69468.17 (SEC) Z = 1.83 = 72.2

AERODYNAMIC FLIGHT STATE

T. AIRSPEED- 109.8 KT DYNAMIC PRES = 1.99 KPA = 41.5 PSF  
 A/L MACH NO = .173 STATIC PRES = 94.8 KPA = 1979. PSF  
 TOTAL TEMP = 267.7 OEG K = 481.9 DEG R  
 STATIC TEMP = 266.2 DEG K = 479.1 OEG R  
 BODY ALPHA = -5.2 DEG DENSITY = 1.24 KG/M3 = .00241 SLUG/FT3  
 BODY BETA = -1.7 OEG DENSITY ALT = -130. M = -426. FT  
 SONIC SPEED = 327.6 M/SEC = 1075. FPS  
 RATE OF CLIMB = 298. M/MIN = 978. FPM

INERTIAL FLIGHT STATE

AXIS	CG LIN VEL (M/S)	CG LIN VEL (FPS)	CG LIN ACC (G)	HUB LIN VEL (M/S)	HUB LIN VEL (FPS)	HUB LIN ACC (G)	AXIS	ANG PUS (DEG)	ANG RATES (RAD/SEC)	ANG ACC (RAD/SEC2)
X	56.22	184.5	-.045	56.21	104.4	-.043	ROLL	-3.7	-.015	-.021
Y	-1.69	-5.6	.034	-1.72	-3.7	.029	PITCH	-.0	.007	-.009
Z	-5.10	-16.7	-1.007	-5.10	-16.7	-1.007	YAW	201.3	.002	.080

CONTROL ANGLES

M.F. COLL = 10.9 DEG HORIZ FIN = 8.7 DEG  
 A1 = -1.3 DEG T.R. CULL = .3 DEG  
 B1 = 1.3 DEG PEDAL POS = .6 DEG

ROTOR PARAMETERS

HOVER TIP MACH = .69 SHAFT ALPHA = -5.2 OEG  
 CONTROL ALPHA = -11.5 DEG  
 TIP MAX-MACH = .37 DELTA PSI = 1.8 DEG  
 TIP MIN-MACH = .52  
 .9R MAX-MACH = .60 ENGINE POWER = 581. KW = 780. HP  
 .9R MIN-MACH = .45 THRUST FACTOR = .901E+07 N = .203E+07 LE

NASA LANGLEY FLIGHT DATA AH-1G ---- ROTOR PERFORMANCE AND LOADS

FLIGHT NO. 62 MU = .248 TOTAL CG = .000282 AMB TEMP = -7.0 C = 19.41 F  
 RUN NO. 31 V = 109.4 KT MAST CG = .000269 TEMP U60 = 12.6 C = 54.61 F  
 TIME 69468.02 NZ = 1.007 G OMEGA = 33.977 RAD/SEC CAN TEMP = -1.5 C = 29.30 F  
 CLP = .00387 RPM/324 = 1.001

ROTOR ANGLES

THETA 314 (DEG) A0 = 10.3 A1 = -1.1 B1 = 6.7 PEAK-TO-PEAK = 13.0  
 TEETER ANG (DEG) A0 = -1.1 A1 = -2.5 B1 = -.4 PEAK-TO-PEAK = 5.2

ROTOR LOADS (AMP/PHASE)

	DRAG BRACE (N/DEG)	CHORD .449 (N-M/DEG)	CHORD .803 (N-M/DEG)	PITCH LINK (N/DEG)	TORSION .449 (N-M/DEG)
MEAN	39131.	14252.	1829.	-2695.	-364.
HARMONIC-1	4132./ -23.8	1198./ -27.0	267./ -49.8	2489./ -31.1	360./ -46.9
2	670./ -80.6	169./ 67.3	66./ -10.6	1780./ -46.9	215./ -46.0
3	2239./ 58.9	714./ 56.0	62./ 41.0	307./ -16.6	87./ 31.5
4	393./ 22.2	231./ 19.2	34./ -12.5	262./ 80.9	25./ 41.9
5	116./ 83.5	87./ 75.9	32./ 34.8	112./ -11.0	15./ 19.7
6	412./ 19.6	319./ 9.1	67./ 13.4	123./ -7.6	12./ 22.0
7	102./ 15.7	98./ 18.4	13./ 26.1	48./ 77.7	2./ 87.8
8	109./ 16.2	91./ -24.5	31./ -6.5	60./ -40.6	5./ -82.5
9	36./ 86.0	31./ -38.8	8./ 35.1	15./ -10.1	2./ -26.7
10	43./ -2.6	88./ 45.9	29./ 36.7	45./ 51.5	3./ 30.6
11	51./ -65.4	99./ 55.7	39./ 39.6	13./ 52.2	3./ 79.0
12	39./ 35.9	24./ -81.2	17./ -68.7	7./ 85.6	3./ -54.0
PEAK-TO-PEAK	13381.	4051.	797.	7276.	1031.
	BEAM .174 (N-M/DEG)	BEAM .350 (N-M/DEG)	BEAM .449 (N-M/DEG)	BEAM .606 (N-M/DEG)	BEAM .803 (N-M/DEG)
MEAN	-5.	129.	-20.	-261.	51.
HARMONIC-1	887./ -52.8	421./ -60.4	432./ -60.6	412./ -63.5	197./ -81.2
2	300./ -52.2	235./ -77.5	254./ -74.9	213./ -69.5	81./ -51.9
3	145./ 38.3	16./ 53.9	43./ 82.5	82./ -85.3	80./ -88.7
4	184./ 49.9	59./ 40.1	33./ 33.6	37./ 54.9	81./ 41.3
5	56./ -32.5	4./ 37.1	12./ 54.9	3./ 1.1	37./ 41.7
6	11./ 23.6	3./ -32.3	5./ -29.2	5./ -5.0	22./ -30.2
7	41./ 72.4	5./ 89.2	21./ -87.5	9./ -57.2	27./ -64.2
8	11./ -58.4	2./ 6.5	9./ -57.6	8./ -27.1	15./ -12.9
9	4./ 53.2	5./ -36.4	1./ -70.3	10./ -28.3	11./ -10.6
10	29./ 16.2	12./ 21.3	8./ 20.1	13./ 25.4	12./ 34.0
11	5./ 36.7	2./ -57.6	3./ 41.9	2./ 76.4	1./ -74.3
12	9./ 48.4	3./ -5.5	4./ 84.6	2./ 85.9	2./ -56.8
PEAK-TO-PEAK	2495.	1171.	1201.	1140.	703.

FLIGHT NO. 063 AIRCRAFT TOTAL WT = 34071. N LOADED CG X= 5.03 M = 198.0 I N  
 PUN NO. 1 7660. LB Y= -.00 Z= -.0  
 TIME 53710.30 (SEC) Z= 1.84 = 72.6

AERODYNAMIC FLIGHT STATE

COYNAPIC PRES= .64 KPA = 13.4 PSF  
 STATIC PRES= 80.8 KPA = 1687. PSF  
 TOTAL TAMP= 264.8 OEG K = 476.6 DEG R  
 STATIC TEMP= 264.2 DEG K = 475.5 DEG R  
 T. AIRSPEED= 67.5 KT  
 A/C MACH NO= .107  
 BODY ALPHA= .4 DEG DENSITY\* 1.07 KG/M3 = .00207 SLUG/FT3  
 BODY BETA= 5.1 DEG DENS INTY ALT= 1432. M = 4699. FT  
 SONIC SPEED\* 326.4 M/SEC = 1071. FPS  
 RATE OF CLIMB\* -70. M/MIN = -230. FPM

INERTIAL FLIGHT STATE

AXIS	IT. LIN VEL (M/S)	IT. LIN VEL (FPS)	CG LIN ACC (G)	HUB LIN VFL (M/S)	HUB LIN VFL (FPS)	HUB LIN ACC (G)	AXIS	ANG POS (DEG)	ANG RATES (RAD/SEC)	ANG ACC (RAD/SEC2)
X	34.60	113.5	-.036	34.60	113.5	-.036	ROLL	.0	.002	.014
Y	3.08	10.1	-.003	3.08	10.1	-.000	PITCH	-1.5	-.001	-.001
Z	.24	.8	-.982	.24	.8	-.982	YAW	353.4	.001	.016

CONTROL ANGLES

M.R. COLL= 7.4 DEG HORIZ FIN= 6.6 DEG  
 A1= -1.0 OEG T.R. COLL= .4 DEG  
 B1= 7.3 DEG PEDAL POS= .5 DEG

ROTOR PARAMETERS

HOVER TIP MACH= .70 SHAFT ALPHA= .4 DFG  
 CONTROL ALPHA\* -1.9 DEG  
 TIP MAX-MACH= .81 DELTA PSI\* -5.1 OEG  
 TIP MIN-MACH= .59  
 .9R HAY-MACH= .74 ENGINE POWER\* 283. KW = 380. HP  
 .9R PIN-MACH= .52 THRUST FACTOR\* .785E+07 N = .176E+07 LB

NASA LANGLEY FLIGHT DATA AH-1G ---- ROTOR PERFORMANCE AND LOADS

FLIGHT NO. 63 MU\* .151 TOTAL CO\* .000157 AMB TEMP\* -9.0 C = 15.83 F  
 PUN NO. 1 V\* 67.5 KT MAST CO\* .000150 TEMP U60= 9.2 C = 48.59 F  
 TIME 53718.15 NZ= .982 G OMEGA\* 34.197 RAD/SEC CAN TEMP= -.3 C = 31.47 F  
 CLP= .00423 RPM/324= 1.008

ROTOR AWGLFS THETA 314 (DEG) A0= 7.5 A1\* -1.0 B1= 2.0 PEAK-TO-PEAK\* 4.4  
 TEFTER ANG (DEG) A0= -.5 A1= .0 B1= .4 PEAK-TO-PEAK\*\* .8

ROTOR LOADS (AMP/PHASE) DRAG BQACE (N/DEG) CHORO .449 (N-M/DEG) CHORO .803 (N-M/DEG) PITCH LINK (N/DEG) TORSION .449 (N-M/DEG)

	DRAG BQACE (N/DEG)	CHORO .449 (N-M/DEG)	CHORO .803 (N-M/DEG)	PITCH LINK (N/DEG)	TORSION .449 (N-M/DEG)
MFAN	44596.	13839.	2238.	-932.	-121.
HARMONIC-1	3855./ -11.0	1148./ -18.5	187./ -44.5	1246./ -3.6	165./ -56.0
2	824./ -44.0	348./ -39.6	63./ -63.2	591./ 8.9	59./ 29.8
3	331./ 58.1	68./ 21.7	51./ -31.2	271./ 26.2	77./ 83.0
4	302./ 68.2	87./ 2.2	24./ -47.3	119./ -16.9	18./ 8.1
5	253./ 3.8	42./ 27.3	31./ -78.9	113./ -44.2	9./ 17.9
6	234./ 32.4	162./ 8.9	49./ -34.2	153./ 87.0	33./ -71.0
7	56./ 77.1	92./ 34.4	51./ 37.0	82./ 25.1	5./ 20.5
8	95./ -54.3	91./ -81.0	20./ 27.5	36./ .4	11./ -85.8
9	64./ 63.0	73./ -51.9	32./ -75.7	38./ 17.9	6./ 71.0
10	69./ .2	53./ 18.3	13./ 48.4	78./ 75.8	16./ -42.2
11	95./ -18.2	92./ 31.8	12./ -31.0	51./ -79.6	8./ 80.6
12	77./ 65.1	34./ -36.8	8./ -65.0	17./ -76.4	2./ 13.5
PEAK-TO-PEAK	8995.	3137.	957.	3383.	551.

	BEAM .174 (N-M/DEG)	BEAM .350 (N-M/DEG)	BEAM .449 (N-M/DEG)	BEAM .606 (N-M/DEG)	BEAM .803 (N-M/DEG)
MEAN	-169.	167.	52.	-184.	14.
HARMONIC-1	298./ -35.2	168./ -89.5	187./ -89.3	176./ -76.6	74./ -82.8
2	126./ 3.7	114./ -29.8	145./ -26.5	195./ -26.7	119./ -35.5
3	119./ -25.9	20./ -11.1	11./ 81.8	56./ -52.8	124./ -35.1
4	145./ -23.9	46./ -26.5	32./ -13.3	25./ -1.9	47./ 13.3
5	118./ -45.1	10./ 6.5	23./ -61.8	26./ -31.9	34./ -55.2
6	34./ 5.3	3./ -52.0	9./ -64.9	16./ -23.0	32./ 72.8
7	39./ 29.7	10./ 82.4	23./ 57.0	20./ -26.5	50./ 22.9
8	54./ -10.3	10./ 24.2	19./ -4.3	12./ 70.4	21./ -56.1
9	23./ 10.6	12./ 24.5	11./ -12.2	17./ 22.2	28./ 33.3
10	56./ 21.1	20./ 50.6	17./ 9.6	15./ 68.9	13./ 81.6
11	36./ 50.2	18./ 81.2	13./ 5.5	12./ 65.3	8./ 67.7
12	13./ 85.4	1./ 82.6	3./ -54.4	3./ -60.7	4./ -39.7
PEAK-TO-PEAK	1361.	500.	568.	759.	717.

FLIGHT NO. 063 AIRCRAFT TOTAL WT = 34048. N LOADED CG X= 5.03 M = 198.0 IN  
 RUN NO. 2 7655. LB Y= -.00 Z= -.0  
 TIME 53788.60 (SFC) Z= 1.85 = 72.6

AERODYNAMIC FLIGHT STATE

DYNAMIC PRES= .86 KPA = 17.9 PSF  
 STATIC PRES= 80.9 KPA = 1689. PSF  
 TOTAL TEMP= 765.1 DEG K = 477.1 DFG R  
 STATIC TEMP= 264.3 OEG K = 475.7 DEG R  
 T. AIRSPEED= 77.9 KT  
 A/C MACH NO= .123  
 BODY ALPHA= -.2 OFG DENSITY= 1.07 KG/M3 = .00207 SLUG/FT3  
 BODY BETA= 4.2 DEG DENSITY ALT= 1424. M = 4671. FT  
 SONIC SPEED\* 326.4 M/SEC = 1071. FPS  
 RATE OF CLIMB= -56. M/MIN = -183. FPM

INERTIAL FLIGHT STATE

AXIS	CG LIN VEL (M/S)	CG LIN VEL (FPS)	CG LIN ACC (G)	HUB LIN VEL (M/S)	HUB LIN VEL (FPS)	HUB LIN ACC (G)	AXIS	ANG POS (DEG)	ANG RATES (RAD/SEC)	ANG ACC (RAD/SEC2)
X	39.96	131.1	-.038	39.96	131.1	-.040	ROLL	.3	-.001	-.021
Y	2.96	9.7	-.011	2.96	9.7	-.016	PITCH	-1.5	.001	.008
Z	-.12	-.4	-.986	-.12	-.4	-.986	YAW	341.3	.000	-.014

CONTROL ANGLES

M.R. COLL= 7.7 DFG HORIZ FIN\* 6.9 DEG  
 A1= -.8 OEG T.R. COLL= .5 DEG  
 R1= 3.0 DEG PEDAL POS= .6 DEG

ROTOR PARAMETERS

HOVER TIP MACH= .70 SHAFT ALPHA= -.2 OEG  
 CONTROL ALPHA= -3.2 DEG  
 TTP WAX-MACH= .82 DELTA PSI= -4.2 DEG  
 TIP MIN-MACH= .58  
 .9R WAX-MACH= .75 ENGINE POWER= 293. KW = 393. HP  
 .9R MIN-MACH= .51 THRUST FACTOR= .786E+07 N = .177E+07 LB

NASA LANGLEY FLIGHT DATA AH-1G ---- ROTOR PERFORMANCE AND LOADS

FLIGHT NO. 63 MU= .175 TOTAL CQ= .000162 AMB TEMP\* -8.9 C = 16.03 F  
 V= 77.9 KT MAST CQ= .000154 TEMP U60= 9.4 C = 48.90 F  
 RUN NO. 2 NZ= .986 G OMEGA\* 34.164 RAD/SEC CAN TEMP= -3.3 C = 31.47 F  
 TIME 53798.49 CLP= .00425 RPM/324= 1.007

ROTOR ANGLES

THFTA 314 (DEG) A0= 7.7 A1= -.7 B1= 2.8 PEAK-TO-PEAK\* 5.9  
 TEFTER ANG (DEG) A0= -6 A1= -.3 B1= .4 PEAK-TO-PEAK= 1.0

ROTOR LOADS (AMP/PHASE)

DPAG BRACE (N/DEG) CHORD .449 (N-M/DEG) CHORD .803 (N-M/DEG) PITCH LINK (N/DEG) TORSION .449 (N-M/DEG)

	MEAN	44427.	14081.	2214.	-1055.	-137.				
HARMPNIC-1	3645./	-12.3	1014./	-19.6	159./	-46.7	1512./	-18.4	212./	-56.0
2	595./	-75.8	319./	-10.9	10./	79.8	514./	-16.9	31./	-15.4
3	852./	-5.2	305./	-16.6	47./	-47.3	356./	-4.1	79./	53.0
4	315./	80.0	230./	61.9	39./	-7.3	46./	52.0	7./	35.6
5	250./	17.8	51./	74.0	30./	-4.1	94./	83.5	44./	-47.6
6	398./	55.0	245./	45.1	63./	15.5	152./	56.9	38./	85.9
7	85./	30.9	141./	76.9	50./	88.3	35./	-55.7	9./	-45.1
8	36./	48.6	72./	-58.0	29./	75.1	22./	-21.0	9./	-85.5
9	106./	23.3	193./	75.3	86./	72.8	129./	-2.3	8./	62.4
10	79./	-71.0	89./	28.4	77./	8.2	30./	32.0	10./	71.3
11	53./	-36.7	70./	55.8	42./	20.4	29./	-3.4	11./	87.9
12	56./	-47.2	24./	.8	26./	50.0	7./	-59.9	12./	-64.4
PEAK-TO-PEAK	8465.		3396.		942.		4229.		651.	

	BEAM .174 (N-M/DEG)	BEAM .350 (N-M/DEG)	BEAM .449 (N-M/DEG)	BEAM .606 (N-M/DEG)	BEAM .803 (N-M/DEG)					
MFAN HARMONIC-1	-175.	163.	33.	-198.	16.					
2	387./	-43.5	231./	-80.1	242./	-78.3	233./	-71.1	95./	-83.2
3	99./	-18.7	103./	-41.5	147./	-31.5	166./	-32.5	94./	-41.0
4	156./	-43.9	44./	-21.8	22./	20.6	44./	-54.5	95./	-33.5
5	115./	52.7	40./	44.5	20./	4.5	42./	54.9	59./	-85.8
6	104./	-17.5	14./	-10.9	20./	-22.6	29./	-17.7	16./	48.9
7	36./	-76.6	6./	-25.3	18./	-69.3	7./	-30.3	49./	-27.9
8	41./	-13.8	15./	-21.3	20./	-31.0	11./	-9.6	25./	-76.2
9	27./	-63.2	4./	40.1	5./	51.5	13./	-46.6	27./	-2.9
10	73./	-21.8	36./	3.5	23./	-14.4	40./	21.5	35./	44.7
11	55./	-.5	16./	14.1	17./	-16.6	25./	19.6	27./	30.3
12	13./	19.3	8./	-49.8	5./	-5.3	7./	-7.6	8./	-22.4
PEAK-TO-PEAK	66./	82.1	22./	-78.0	13./	66.1	14./	-74.2	9./	-79.2
	1433.		660.		716.		823.		667.	

FLIGHT NO. 063 AIRCRAFT TOTAL WT = 34018. N LOADED CG X= 5.03 M = 198.0 IN  
 PUN NO. 3 7648. LR Y= -.00 Z= -.0  
 TIME 53849.40 (SFC) Z= 1.85 72.7

AERODYNAMIC FLIGHT STATF DYNAMIC PRES= 1.09 KPA = 22.8 PSF  
 STATIC PRES= 80.9 KPA = 1690. PSF  
 TOTAL TEMP= 265.4 DEG K = 477.7 DEG R  
 STATIC TEMP= 764.4 DEG K = 475.9 DEG R  
 T. AIRSPEED= 97.9 KT  
 A/C MACH NO= .130  
 BODY ALPHA\* -1.9 DFG DENSITY= 1.07 KG/M3 = .00207 SLUG/FT3  
 BODY BETA= 2.4 DFG DENSITY ALT= 1419. M = 4656. FT  
 SONIC SPEED= 326.5 M/SEC = 1071. FPS  
 RATE OF CLIMB= 5. M/MIN = 18. FPM

INERTIAL FLIGHT STATE

AXIS	CG LIN (M/S)	VFL (FPS)	CC LIN (G)	ACC (G)	HUB LIN (M/S)	VFL (FPS)	HUB LIN (G)	ACC (G)	AXIS	ANG POS (DEG)	ANG RATES (RAD/SEC)	ANG ACC (RAD/SEC2)
1	45.14	148.1	-.046		45.14	148.1	-.046		POLL	-4	.001	-.006
Y	1.90	6.2	.001		1.91	6.3	-.000		PITCH	-1.8	.001	.000
7	-1.51	-5.0	-.995		-1.51	-5.0	-.995		YAW	335.6	-.003	.013

CONTROL ANGLES M.R. COLL= 8.5 DEG HORIZ FIN= 7.2 DEG  
 A1= -.8 DEG T.R. COLL= .5 DFG  
 A1= 3.8 DEG PEDAL POS= .7 DEG

ROTOR PARAMETERS

SHAFT ALPHA= -1.9 DFG  
 HOVER TIP MACH\* .70 CONTROL ALPHA= -5.7 DFG  
 TIP FAX-MACH- .84 DELTA PSI= -2.4 DEG  
 TIP MIN-MACH\* .56  
 .9P MAX-MACH\* .77 ENGINE POWER= 350. KW = 470. HP  
 .9P WIN-MACH\* .40 THRUST FACTOR' .784E+07 N = .176E+07 LB

NASA LANGLEY FLIGHT DATA AH-1G ROTOR PERFORMANCE AND LOADS

FLIGHT NO. 63 MU= .197 TOTAL CQ= .000194 AMB TEMP= -8.8 C = 16.22 F  
 RUN NO. 3 V\* 87.9 KT MAST CQ= .000186 TEMP U60= 9.3 C = 48.67 F  
 TIME 53849.75 NZ= .995 G OMEGA= 34.158 RAD/SEC CAN TEMP= -.3 C = 31.47 F  
 CLP= .00428 RPM/324= 1.007

ROTOR ANGLES THETA 314 (DEG) A0= 8.6 A1= -7 B1= 3.7 PEAK-TO-PEAK\* 7.6  
 TEETER ANG (DFG) A0= -.6 A1= -7 B1= .2 PEAK-TO-PEAK- 1.5

ROTOR LOADS (AMP/PHASE) DRAG BRACE (N/DEG) CHORD .449 (N-M/DEG) CHORD .803 (N-M/DEG) PITCH LINK (N/DEG) TORSION .449 (N-M/DEG)

	MEAN	1	2	3	4	5	6	7	8	9	10	11	12	PEAK-TO-DFAK
HARMONIC-1	43218.	3774./ -17.5	1058./ -27.2	205./ -53.5	1673./ -21.2	632./ -39.1	51./ -44.7	14431.	2242.	-1435.	-178.	247./ -51.0		
2		294./ -46.5	167./ 15.4	2./ -15.3	632./ -39.1	51./ -44.7								
3		1353./ 25.7	448./ 14.7	67./ -15.4	345./ -6.4	58./ 42.8								
4		267./ -25.8	200./ -67.2	28./ 64.7	101./ 56.4	23./ 28.3								
5		500./ 87.2	146./ -88.5	35./ 59.0	232./ -84.6	38./ -28.8								
6		698./ -72.1	564./ -67.0	131./ -79.0	140./ -74.8	25./ -48.0								
7		306./ -75.4	263./ -83.4	60./ -74.0	93./ 76.2	11./ -24.8								
8		88./ 21.3	35./ 18.0	25./ 85.0	18./ 77.3	2./ -80.3								
9		39./ 78.6	95./ -50.6	35./ -33.0	67./ -37.8	3./ 87.9								
10		50./ 37.4	106./ -33.2	42./ -32.3	33./ 52.9	4./ -61.8								
11		74./ 87.8	60./ 86.9	20./ -88.3	32./ -31.6	2./ 56.3								
12		43./ -14.8	21./ -64.0	34./ -38.1	22./ -80.9	4./ 41.5								
PEAK-TO-DFAK		9524.	3954.	939.	4349.	563.								

	BEAM .174 (N-M/DEG)	REAM .350 (N-M/DEG)	BEAM .449 (N-M/DEG)	BEAM .606 (N-M/DEG)	BEAM .803 (N-M/DEG)
MEAN	-108.	178.	48.	-187.	12.
HARMONIC-1	500./ -46.4	273./ -69.8	291./ -67.5	279./ -67.5	115./ -84.2
2	112./ -44.6	84./ -53.3	112./ -40.4	135./ -37.0	84./ -40.6
3	119./ -6.5	61./ 21.1	48./ 41.3	38./ -56.0	73./ -39.0
4	115./ -64.4	30./ -69.9	6./ 42.3	31./ -72.4	58./ -35.8
5	157./ 54.2	18./ 30.0	12./ 55.3	31./ 24.6	14./ 29.1
6	57./ 73.2	1./ 62.0	10./ 25.8	18./ 42.6	40./ 37.0
7	63./ 27.2	10./ 42.8	25./ 16.6	10./ 24.3	42./ 19.4
8	61./ 48.7	10./ 88.0	15./ 41.4	12./ -42.0	16./ -15.4
9	26./ -51.9	19./ -47.3	9./ -36.9	16./ -42.3	18./ -57.8
10	48./ 24.9	13./ 71.6	15./ 54.2	14./ 80.4	13./ -83.8
11	10./ -87.6	8./ -41.4	4./ -57.8	7./ -27.1	7./ -70.3
12	19./ 9.6	6./ 33.5	7./ -4.8	8./ 1.4	7./ 11.3
PEAK-TO-PEAK	1373.	674.	765.	804.	500.

NASA LANGLEY FLIGHT DATA AH-1G ---- PADS PCM DATA

FLIGHT NO. 063 AIRCRAFT TOTAL WT = 33947. N LOADED CG X = 5.03 M = 198.0 IN  
 RUN NO. 4 7632. LB Y = -.00 Z = -.0  
 TIME 53917.20 (SEC) Z = 1.85 = 72.7

AERODYNAMIC FLIGHT STATE

T. AIRSPEED = 94.4 KT  
 A/C MACH NO = .149

BODY ALPHA = -1.9 DEG  
 BODY BETA = 1.4 OFG

DYNAMIC PRES- 1.26 KPA = 26.3 PSF  
 STATIC PRES- 80.9 KPA = 1690. PSF  
 TOTAL TEMP = 265.8 DEG K = 478.4 DEG R  
 STATIC TEMP- 264.6 OEG K = 476.3 DEG R

DENSITY- 1.07 KG/M3 = .00207 SLUG/FT3  
 DENSITY ALT = 1431. M = 4694. FT  
 SONIC SPEED- 326.6 M/SEC = 1072. FPS  
 RATE OF CLIME- -17. M/MIN = -57. FPM

INERTIAL FLIGHT STATE

AXIS	CG LIN VFL (M/S)	CG LIN VFL (FPS)	CG LIN ACC (G)	HUB LIN VFL (M/S)	HUB LIN VFL (FPS)	HUB LIN ACC (G)	AXIS	ANG POS (DEG)	ANG RATES (RAD/SEC)	ANG ACC (RAD/SEC2)
X	48.51	159.1	-.048	48.50	151.1	-.049	ROLL	-1.1	-.001	.024
Y	1.15	3.8	.002	1.15	3.8	.007	PITCH	-2.3	.001	.000
Z	-1.64	-5.4	-.964	-1.64	-5.4	-.964	YAW	312.0	-.001	.015

CONTROL ANGLE?

MR COLL = 8.5 OEG HORIZ FIN = 7.4 OFG  
 A1 = -.6 OEG T.R. COLL = .5 OEG  
 R1 = 4.3 OEG PEDAL POS = .6 DEG

ROTOR PARAMETERS

HOVER TIP MACH = .70 SHAFT ALPHA = -1.9 OEG  
 CONTROL ALPHA = -6.2 DEG  
 TIP MAX-MACH = .85 DELTA PSI = -1.4 DEG  
 TIP MIN-MACH = .55  
 .9R MAX-MACH = .78 ENGINE POWER = 352. KW = 472. HP  
 .9R MIN-MACH = .48 THRUST FACTOR = .782E+07 N = .176E+07 LB

NASA LANGLEY FLIGHT DATA AH-1G ---- ROTOR PERFORMANCE AND LOADS

FLIGHT NO. 63 MU = .212 TOTAL CO = .000196 AMB TEMP = -8.5 C = 16.63 F  
 RUN NO. 4 V = 94.4 KT MAST CO = .000189 TFMP U60 = 10.0 C = 49.99 F  
 TIME 53'397.07 NZ = .964 G OMEGA = 34.089 RAD/SEC CAN TEMP = -.7 C = 30.77 F  
 CLP = .00416 RPM/324 = 1.005

ROTOR ANGLES

THETA 3/4 (DEG) A0 = 8.7 A1 = -.6 B1 = 4.2 PEAK-TO-PEAK\* 8.5  
 FEETER ANG (REG) A0 = -6 A1 = -.9 B1 = .2 PEAK-TO-PEAK = 1.8

ROTOR LOADS (AMP/PHASE)

	DRAG BRACE (N/DEG)	CHORD .449 (N-M/DEG)	CHORD .803 (N-M/DEG)	PITCH LINK (N/DEG)	TORSION .449 (N-M/DEG)
MFAN HARMONIC-1	42936.	14756.	2094.	-1527.	-191.
2	3480./ -17.9	926./ -28.8	195./ -69.2	1848./ -24.4	287./ -49.8
3	82./ 50.0	47./ 55.6	45./ -6.2	1047./ -54.5	94./ -54.0
4	1900./ 36.4	557./ 35.5	60./ 27.4	332./ -7.0	46./ 32.9
5	456./ 10.7	196./ -9.3	39./ -36.9	245./ 63.6	37./ 44.3
6	415./ -77.0	107./ -83.0	44./ 72.1	187./ -53.6	33./ -9.8
7	714./ -72.0	537./ -69.8	118./ -71.5	29./ -80.4	12./ -25.5
8	161./ 71.0	59./ 82.4	38./ -61.6	31./ -38.2	4./ -17.3
9	114./ 28.5	9./ -2.2	28./ -48.3	14./ -30.3	8./ -89.7
10	52./ -23.8	54./ 14.5	39./ -19.9	76./ -69.4	2./ -46.5
11	55./ 88.7	125./ -23.9	49./ -16.2	33./ 72.3	6./ 75.4
12	88./ 86.1	13./ -33.1	10./ 48.7	26./ -54.2	4./ 54.5
PEAK-TO-PFAK	76./ 39.2	22./ -71.0	7./ 45.2	15./ -77.8	2./ 36.7
	10031.	3559.	782.	5556.	623.
	BFAM .174 (N-M/DEG)	BEAM .350 (N-M/DEG)	BEAM .449 (N-M/DEG)	BEAM .606 (N-M/DEG)	BEAM .803 (N-M/DEG)

MEAN

	DRAG BRACE (N/DEG)	CHORD .449 (N-M/DEG)	CHORD .803 (N-M/DEG)	PITCH LINK (N/DEG)	TORSION .449 (N-M/DEG)
HARMONIC-1	-178.	148.	30.	-201.	4.
2	529./ -46.9	293./ -65.6	317./ -65.1	303./ -66.1	128./ -81.0
3	171./ -65.4	111./ -72.4	128./ -61.4	128./ -54.8	58./ -47.4
4	99./ 20.9	71./ 28.8	55./ 43.9	49./ -86.8	62./ -72.6
5	145./ 13.5	38./ 9.1	23./ 39.4	23./ 15.0	68./ 10.9
6	103./ 77.0	17./ 45.1	2./ -76.1	18./ 31.5	36./ 56.4
7	48./ -80.4	7./ 18.8	4./ -35.9	13./ 21.5	15./ 13.9
8	9./ 38.5	3./ -14.7	10./ -71.3	6./ -26.1	20./ -17.2
9	43./ 70.4	9./ -88.8	9./ 48.7	8./ -43.4	12./ -5.4
10	41./ -77.7	26./ -71.5	8./ -84.7	28./ -56.2	27./ -55.7
11	28./ -10.0	8./ 14.1	5./ 2.2	13./ 36.6	5./ 21.7
12	9./ -44.6	6./ -16.4	3./ -1	8./ -20.1	6./ 22.0
PEAK-TO-PFAK	16./ 40.7	7./ 71.9	6./ 63.2	6./ 88.2	4./ 67.1
	1587.	748.	815.	807.	482.



FLIGHT NO. 061 AIRCRAFT TOTAL WT = 33869. N LOADED CG X= 5.03 M = 197.9 IN  
 RUN NO. 5 7614. LB Y= -0.00 Z= -0  
 TIME 54103.20 (SFC) Z= 1.85 = 72.7

AERODYNAMIC FLIGHT STATE DYNAMIC PRES= 1.54 KPA = 32.1 PSF  
 STATIC PRES= 80.1 KPA = 1672. PSF  
 T. AIRSPEED= 104.7 KT TOTAL TEMP= 265.8 OEG K = 478.5 DEG F  
 A/C MACH NO= .165 STATIC TEMP= 264.4 OEG K = 475.9 DEG F  
 BODY ALPHA= -2.7 DEG DENSITY= 1.06 KG/M3 = .00205 SLUG/FT3  
 BODY BETA= 1.9 OEG DENSITY ALT= 1528. M = 5014. FT  
 SONIC SPEFD= 326.5 M/SEC = 1071. FPS  
 RATE OF CLIMB= -15. M/MIN = -49. FPM

INERTIAL FLIGHT STATE

AXIS	CG LIN VEL (M/S)	CG LIN VEL (FPS)	CG LIN ACC (G)	HUB LIN VEL (M/S)	HUB LIN VEL (FPS)	HUB LIN ACC (G)	AXIS	ANG POS (DEG)	ANG RATES (RAD/SEC)	ANG ACC (RAD/SEC2)
X	53.76	176.4	-.055	53.76	176.4	-.054	ROLL	-1.5	-.000	-.029
Y	1.79	5.9	.000	1.79	5.9	-.006	PITCH	-3.0	.001	-.002
Z	-2.51	-8.2	-.973	-2.51	-8.2	-.973	YAW	193.8	-.003	-.006

CONTROL ANGLES H.R. COLL= 0.3 DEG HORIZ FIN= 7.8 DEG  
 A1= -.5 DEG T.R. COLL= 1.3 DEG  
 R1= 5.0 REG PEDAL POS= 1.4 DEG

ROTOR PARAMETERS

HOVER TIP MACH= .70 SHAFT ALPHA= -2.7 DEG  
 CONTROL ALPHA= -7.7 DEG  
 TIP MAX-MACH= .86 DELTA PSI= -1.9 DEG  
 TIP MIN-MACH= .53  
 .9P WAX-MACH= .79 ENGINE POWER= 398. KW = 534. HP  
 .9R MIN-MACH= .46 THRUST FACTOR= .772E+07 N = .174E+07 LB

NASA LANGLEY FLIGHT DATA AH-1G ---- ROTOR PERFORMANCE AND LOADS

FLIGHT NO. 63 MU= .236 TOTAL CQ= .000225 AM8 TEMP= -8.8 C = 16.19 F  
 RUN NO. 5 V= 104.7 KT MAST CQ= .000217 TEMP U60= 9.2 C = 48.63 F  
 TIME 54103.06 NZ= .973 G OMEGA\* 34.057 RADISEC CAN TEMP= -1.5 C = 29.38 F  
 CLP= .00424 RPM/324= 1.004

ROTOR ANGLES THETA 314 (DEG) A0= 9.5 A1= -.3 B1= 5.2 PEAK-TO-PEAK 10.5  
 TEETER ANG (DFG) A0= -.6 A1= -1.1 B1= .1 PEAK-TO-PEAK- 2.2

ROTOR LOADS (AMP/PHASE)	DRAG BRACE (N/DEG)	CHORD .449 (N-M/DEG)	CHORD .803 (N-M/DEG)	PITCH LINK (N/DEG)	TORSION .449 (N-M/DEG)
MEAN	41901.	14952.	2272.	-1878.	-232.
HARMONIC-1	3452./ -33.6	1076./ -42.6	284./ -60.5	2107./ -31.6	323./ -50.3
2	379./ -44.6	64./ -30.3	92./ -59.9	1690./ -60.3	174./ -57.8
3	1877./ 45.0	529./ 43.3	22./ 64.1	320./ -32.9	63./ 10.8
4	576./ 25.6	230./ 15.8	32./ -31.3	313./ 72.7	49./ 47.9
5	119./ -66.4	31./ -49.4	61./ -15.6	186./ -20.2	38./ 8.1
6	458./ 84.1	353./ 88.5	104./ 77.8	39./ -89.7	10./ 6.1
7	364./ 63.4	282./ 60.1	79./ 39.3	111./ 14.0	8./ -12.0
8	131./ 28.1	67./ 5.6	46./ -33.3	61./ -73.2	9./ -84.0
9	75./ 25.4	45./ 22.5	47./ -47.7	22./ 77.0	1./ -67.4
10	43./ -81.1	109./ 53.1	63./ 81.3	58./ 12.4	7./ 39.9
11	24./ 78.4	21./ -84.2	27./ -38.5	13./ -18.2	5./ 13.1
12	30./ -8.7	54./ 49.8	39./ 42.3	16./ -15.9	3./ 36.3
PFAK-TO-PEAK	11625.	4177.	1155.	6760.	863.

	BEAM .174 (N-M/DEG)	BEAM .350 (N-M/DEG)	BEAM .449 (N-M/DEG)	BEAM .606 (N-M/DEG)	BEAM .803 (N-M/DEG)
MEAN	-120.	155.	33.	-187.	-17.
HARMONIC-1	641./ -57.3	329./ -70.2	346./ -70.2	332./ -71.8	149./ -89.5
2	288./ -69.4	192./ -82.0	209./ -78.7	174./ -74.4	61./ -59.4
3	29./ 2.4	41./ 27.8	42./ 50.1	58./ 84.0	66./ 79.8
4	214./ 37.4	63./ 28.7	39./ 15.2	42./ 42.0	84./ 19.1
5	76./ -73.6	8./ 9.8	10./ 2.1	4./ -69.6	35./ 32.7
6	37./ 73.0	5./ -1.9	4./ -69.9	10./ 12.6	22./ -59.9
7	54./ 17.5	5./ 32.4	25./ 48.1	7./ 83.1	34./ 74.0
8	11./ -58.2	2./ 54.2	2./ -36.7	6./ 56.9	9./ -72.4
9	22./ 77.1	16./ 64.1	5./ 72.3	21./ 86.2	17./ 87.4
10	42./ -61.0	13./ -40.9	8./ -45.9	18./ -26.0	11./ -20.0
11	9./ 74.3	4./ -7.0	5./ 38.9	3./ -49.1	4./ -17.6
12	6./ 28.0	2./ 3.2	6./ 70.4	4./ 55.7	1./ -9.3
PEAK-TO-PEAK	1932.	949.	1027.	960.	586.

FLIGHT NO. 063 AIRCRAFT TOTAL WT = 33866. N LOADED CG X= 5.03 M = 197.9 I N  
 RUN NO. 6 7614. LB Y= -.00 Z= -.0  
 TIME 54157.80 (SEC) Z= 1.85 \* 77.7

AERODYNAMIC FLIGHT STATE

T. AIRSPEED- 114.2 KT DYNAMIC PRES= 1.84 KPA = 38.4 PSF  
 A/C MAC4 NO= .180 STATIC PRES= 80.2 KPA = 1675. PSF  
 TOTAL TEMP= 265.9 DEG K = 478.6 DEG F  
 STATIC TEMP= 264.2 DEG K = 475.5 DEG F  
 BODY ALPHA- -2.9 DEG DENSITY- 1.06 KG/M3 = .00205 SLUG/FT3  
 BODY BETA- 1.1 DEG DENSITY ALT= 1502. M = 4927. FT  
 SONIC SPEED- 326.4 M/SEC = 1071. FPS  
 RATE OF CLIMB- -10. M/MIN = -34. FPM

INERTIAL FLIGHT STATE

AXIS	CG LIN VFL (M/S) (FPS)	CG LIN ACC (G)	HUB LIN VEL (M/S) (FPS)	HUB LIN ACC (G)	AXIS	ANG POS (DEG)	ANG PATES (RAD/SFC)	ANG ACC (RAD/SEC2)		
X	58.67	192.5	-0.065	58.67	192.5	-0.064	ROLL	-0.7	.000	-0.003
Y	1.16	3.8	.007	1.16	3.8	.007	PITCH	-3.1	-0.000	-0.008
Z	-2.98	-9.8	-0.981	-2.98	-9.8	-0.982	YAW	189.1	.003	.007

CONTROL ANGLES

M.R. COLL= 9.8 DEG HORIZ FIN= 8.1 DEG  
 A1= -0.6 DEG T.R. COLL= 1.2 DEG  
 B1= 5.6 DEG PEDAL POS= 1.4 DEG

ROTOR PARAMETERS

SHAFT ALPHA= -2.9 DEG  
 HOVER TIP MACH= .70 CONTROL ALPHA= -8.5 DEG  
 TIP MAX-MACH= .88 DELTA PSI\* -1.1 DEG  
 TIP MIN-MACH= .52  
 .9R MAX-MACH= .81 ENGINE POWER\* 433. KW = 581. HP  
 .9R MIN-MACH= .45 THRUST FACTOR\* .772E+07 N = .174E+07 LB

NASA LANGLEY FLIGHT DATA AH-1G ---- ROTOR PERFORMANCE AND LOADS

FLIGHT NO. 63 MU= .257 TOTAL CO= .000245 AMB TEMP- -9.0 C = 15.81 F  
 PUN NO. 6 V= 114.2 KT MAST CO= .000235 TEMP U60= 10.0 C = 49.98 F  
 TIME 54157.65 NZ= .982 G OMEGA= 34.029 RAD/SEC CAN TEMP- -1.8 C = 28.68 F  
 CLP= .00427 RPM/324= 1.003

ROTOR ANGLES

THETA 3/4 (DEG) AO= 10.1 A1= -3 B1= 5.9 PEAK-TO-PEAK- 12.1  
 TEETEANG (DEG) A0= -6 A1= -1.2 B1= -0.0 PEAK-TO-PEAK= 2.5

ROTOR LOADS (AMP/PHASE)

DRAG BRACE (N/DEG) CHORD .449 (N-M/DEG) CHORD .803 (N-M/DEG) PITCH LINK (N/DEG) TORSION .449 (N-M/DEG)

	MEAN	HARMONIC-1	2	3	4	5	6	7	8	9	10	11	12	PEAK-TO-PEAK
DRAG BRACE	41157.	3652./ -40.9	312.1 -27.6	1934./ 36.1	452./ 17.8	159.1 44.9	422.1 67.7	233.1 47.5	123./ -48.5	23.1 -16.7	87./ 66.6	29.1 13.1	111.1 -43.9	12151.
CHORD .449	15119.	1128./ -47.3	45./ 3.9	540./ 36.9	209./ -7.4	124./ 85.0	261./ 70.4	168./ 68.3	67./ 82.1	156./ 17.8	218./ 36.4	25./ -34.4	31./ -19.8	4261.
CHORD .803	2108.	223./ -72.8	130./ -67.8	30./ -70.3	48./ -3.6	36./ -68.0	70./ 40.7	56./ 20.8	40./ 88.1	52./ 28.9	65./ 24.2	21./ -22.4	10./ 71.9	1006.
PITCH LINK	-2149.	2326./ -36.0	2103./ -56.7	309./ -45.4	325./ 74.9	224./ 2.9	94./ -23.0	37./ 31.5	60./ -49.0	57./ 17.0	27./ 6.6	9./ 46.3	16./ -1.0	7964.
TORSION .449	-271.	358./ -49.5	219./ -54.4	71./ 9.4	41./ 37.1	43./ 6.0	8./ 14.8	10./ -9.4	5./ -52.8	3./ 18.0	7./ 21.1	7./ -29.1	4./ 8.9	999.

REAM .174 (N-M/DEG) BEAM .350 (N-M/DEG) BEAM .449 (N-M/DEG) REAM .606 (N-M/DEG) REAM .803 (N-M/DEG)

	MEAN	HARMONIC-1	2	3	4	5	6	7	8	9	10	11	12	PEAK-TO-PEAK
REAM .174	-99.	768./ -59.9	378./ -63.6	122./ 31.8	187./ 34.4	53./ -30.4	12./ 73.0	28./ -65.0	31./ -40.6	33./ 22.6	25./ -71.7	11./ -87.8	19./ -82.7	2396.
BEAM .350	152.	391./ -68.7	238./ -82.1	24./ -10.9	59./ 21.8	5./ -45.1	3./ -1.7	10./ -39.1	5./ 52.3	17./ 30.8	12./ -47.8	6./ -67.4	9./ -47.0	1120.
BEAM .449	26.	397./ -69.9	258./ -80.1	41./ 53.2	41./ 13.7	22./ 41.8	10./ 79.7	21./ -85.5	13./ -58.8	7./ 31.5	7./ -37.9	2./ -35.4	6./ -87.9	1160.
REAM .606	-200.	366./ -72.9	223./ -76.0	88./ 73.5	42./ 38.8	5./ 62.9	10./ -89.4	12./ -64.7	12./ -67.9	18./ 67.9	18./ -21.7	4./ 44.2	4./ -89.3	1088.
REAM .803	-6.	176./ 88.7	83./ -61.0	90./ 64.3	95./ 23.1	62./ 27.0	30./ -87.9	37./ -68.5	24./ -40.7	14./ 76.8	17./ -17.3	3./ -76.3	4./ -41.9	723.

NASA LANGLEY FLIGHT DATA AH-1G ---- PADS PCM DATA

FLIGHT NO. 063 AIRCRAFT TOTAL WT = 33826. N LOADED CG X = 5.03 M = 197.9 IN  
 RUN NO. 7 7605. LB Y = -.00 Z = -.0  
 TIME 54725.70 (SEC) Z = 1.85 77.8

AERODYNAMIC FLIGHT STAT

T. AIRSPEED = 124.6 KT  
 A/C MACH NO = .197

BODY ALPHA = -3.0 DEG  
 BODY BETA = .9 DEG

DYNAMIC PRES- 2.19 KPA = 45.8 PSF  
 STATIC PRES = 80.4 KPA = 1678. PSF  
 TOTAL TEMP- 266.3 DEG K = 479.3 DEG R  
 STATIC TEMP- 264.2 DEG K = 475.6 OFG R  
 DENSITY = 1.06 KG/M3 = .00206 SLUG/FT3  
 DENSITY ALT = 1487. M = 4880. FT  
 SONIC SPEED = 326.4 M/SEC = 1071. FPS  
 RATE OF CLIMB - 48. M/MIN = -157. FPM

INERTIAL FLIGHT STATE

AXIS	CG LIN VEL (M/S)	CG LIN ACC (G)	HUB LIN VEL (M/S)	HUB LIN ACC (G)	AXIS	ANG POS (DEG)	ANG RATES (RAD/SEC)	ANG ACC (RAD/SEC2)	
X	64.01	210.0	-.073	64.00	210.0	-.071	ROLL -1.5	-.005	.010
Y	.94	3.2	.011	.95	3.1	.013	PITCH -3.8	.002	-.012
Z	-3.40	-11.2	-.992	-3.40	-11.2	-.992	YAW 187.7	.003	-.006

CONTROL ANGLES

MR. COLL = 10.5 OEG HORIZ FIN = 8.6 DEG  
 A1 = -.5 OEG T.R. COLL = 1.5 OFG  
 B1 = 6.3 OEG PEDAL POS = 1.6 DEG

ROTOR PARAMETERS

SHAFT ALPHA = -3.0 DEG  
 CONTROL ALPHA = -9.3 OEG  
 HOVER TIP MACH = .70  
 DELTA PSI = -.9 DEG  
 TIP MAX-MACH = .89  
 TIP MIN-MACH = .50  
 .9R MAX-MACH = .82  
 .9R MIN-MACH = .43  
 ENGINE POWER = 475. KW = 638. HP  
 THRUST FACTOR = .771E+07 N = .173E+07 LB

NASA LANGLEY FLIGHT DATA AH-1G ---- ROTOR PERFORMANCE AND LOADS

FLIGHT NO. 63 MU = .282 TOTAL CQ = .000270 AMB TEMP = -8.9 C = 15.96 F  
 V = 124.6 KT MAST CQ = .000262 TEMP U60 = 10.1 C = 50.18 F  
 RUN NO. 7 NZ = .992 G OMEGA = 33.949 RAD/SEC CAN TEMP = -1.8 C = 28.68 F  
 TIME 54225.61 CLP = .00433 RPM/324 = 1.001

ROTOR ANGLES

THETA 314 (DEG) A0 = 10.7 A1 = -.2 B1 = 6.7 PEAK-TO-PEAK- 13.4  
 TEETER ANG (DEG) A0 = -6 A1 = -1.5 B1 = -1.1 PEAK-TO-PEAK = 3.1

ROTOR LOADS (AMP/PHASE)

	DRAG BRACE (N/DEG)	CHORD .449 (N-M/DEG)	CHORD .803 (N-M/DEG)	PITCH LINK (N/DEG)	TORSION .449 (N-M/DEG)
MEAN	40132.	15284.	2078.	-2453.	-314.
HARMONIC-1	3719./ -46.8	1248./ -53.2	330./ -71.4	2632./ -41.1	396./ -50.4
2	256./ -43.2	39./ -62.6	101./ -48.2	2458./ -58.3	261./ -59.4
3	2431./ 22.5	702./ 20.0	23./ -49.0	351./ -61.2	75./ -3.1
4	604./ -2.3	350./ -29.2	56./ -67.1	345./ 64.9	51./ 15.1
5	369./ 45.5	229./ 66.5	24./ -86.7	281./ -3.5	47./ 4.3
6	495./ -74.6	318./ -66.3	46./ -69.8	145./ -32.4	11./ 1.8
7	204./ -5.9	88./ -15.5	23./ -73.0	88./ 1.2	8./ 3.3
8	49./ 66.2	42./ 48.1	24./ -58.8	72./ -71.2	7./ -54.2
9	160./ -65.2	250./ -29.3	68./ -28.9	59./ 14.6	2./ -43.9
10	68./ -6.7	47./ -4.9	13./ 21.0	57./ -7.0	10./ 7.3
11	96./ 65.7	91./ -8.2	44./ -20.4	42./ 39.3	6./ -38.9
12	115./ -78.0	69./ -48.2	30./ -88.9	10./ -61.0	2./ -27.8
PEAK-TO-PEAK	12680.	5196.	1330.	9412.	1115.
	REAM .174 (N-M/DEG)	BEAM .350 (N-M/DEG)	BEAM .449 (N-M/DEG)	BEAM .606 (N-M/DEG)	REAM .803 (N-M/DEG)
MEAN	-47.	156.	33.	-200.	-8.
HARMONIC-1	886./ -62.6	447./ -68.1	450./ -68.5	403./ -74.1	191./ 83.8
2	481./ -64.8	284./ -87.0	300./ -87.2	265./ -81.4	114./ -63.8
3	198./ 31.5	35./ -53.6	43./ 24.7	119./ 60.1	138./ 54.4
4	259./ 8.3	84./ -6.3	50./ -20.8	55./ 9.3	115./ -3.5
5	94./ -60.1	4./ 19.2	20./ 7.5	2./ -14.1	64./ 22.3
6	19./ -53.3	9./ 43.6	10./ -48.1	16./ -88.2	41./ -80.5
7	32./ 2.3	2./ 40.1	20./ 26.8	13./ 63.8	43./ 70.4
8	9./ 82.2	6./ 41.2	10./ 81.0	14./ 83.5	26./ -83.1
9	30./ 25.7	19./ 41.1	8./ 24.8	21./ 57.4	20./ 72.3
10	56./ -86.0	18./ -60.4	15./ -80.8	25./ -48.0	19./ -40.1
11	18./ 34.1	11./ 51.2	1./ -22.1	9./ 50.4	7./ 85.2
12	18./ 35.1	8./ 35.8	4./ 27.5	3./ 52.8	2./ 47.0
PEAK-TO-PEAK	2947.	1353.	1364.	1246.	912.

FLIGHT NO. 063 AIRCRAFT TOTAL WT = 33785. N LOADED CG X = 5.03 M = 197.9 IN  
 RUN NO. 8 7595. LB Y = -0.0 Z = -0.0  
 TIME 54338.20 (SEC) Z = 1.85 = 77.8

AERODYNAMIC FLIGHT STATF

DYNAMIC PRES = 2.54 KPA = 53.1 PSF  
 STATIC PRES = 80.4 KPA = 1678. PSF  
 TOTAL TEMP = 266.0 DEG K = 478.8 DFG R  
 STATIC TEMP = 263.7 OEG K = 474.6 DFG R  
 T. AIRSPEED = 134.0 KT  
 A/C MACH NO = .212  
 BODY ALPHA = -4.7 DEG  
 BODY BETA = .6 DEG  
 DENSITY = 1.06 KG/M3 = .00206 SLUG/FT3  
 DENSITY ALT = 1464. M = 4803. FT  
 SONIC SPEED = 326.1 M/SEC = 1070. FPS  
 RATE OF CLIMB = -37. M/MIN = -122. FPM

INERTIAL FLIGHT STATE

AXIS	CG LIN VEL (M/S)	CG LIN VEL (FPS)	CG LIN ACC (G)	HUB LIN VEL (M/S)	HUB LIN VEL (FPS)	HUB LIN ACC (G)	AXIS	ANG POS (DEG)	ANG RATES (RAD/SEC)	ANG ACC (RAD/SEC2)
X	68.72	225.5	-.084	68.73	225.5	-.084	ROLL	-.7	.002	-.058
Y	.75	2.4	.014	.75	2.5	.002	PITCH	-4.7	-.005	-.004
Z	-5.05	-16.6	-.967	-5.05	-16.6	-.967	YAW	340.6	-.003	.001

CONTROL AHGLES

M.R. COLL = 11.9 DEG  
 A1 = -.7 OEG  
 B1 = 7.2 DEG  
 HORIZ FIN = 9.1 DFG  
 T.R. COLL = 1.7 DEG  
 PEDAL POS = 1.8 OEG

ROTOR PARAMETERS

HOVER TIP MACH = .70  
 TIP MAX-MACH = .91  
 TIP MIN-MACH = .48  
 .OR MAX-MACH = .84  
 .9R MIN-MACH = .42  
 SHAFT ALPHA = -4.2 DEG  
 CONTROL ALPHA = -11.4 DFG  
 DELTA PSI = -.6 DEG  
 ENGINE POWER = 552. KW = 741. HP  
 THRUST FACTOR = .773E+07 N = .174E+07 LB

NASA LANGLEY FLIGHT DATA AH-1G ---- ROTOR PERFORMANCE AND LOADS

FLIGHT NO. 63 MU = .303 TOTAL CQ = .000313 AMB TEMP = -9.5 C = 14.92 F  
 RUN NO. 8 V = 134.0 KT MAST CQ = .000305 TEMP U60 = 10.2 C = 50.34 F  
 TIME 54338.05 NZ = .967 G OMEGA = 33.960 RAD/SEC CAN TEMP = -7.6 C = 27.28 F  
 CLP = .00420 RPM/324 = 1.001

ROTOR ANGLES

THETA 3/4 (DEG) A0 = 11.8 A1 = -.4 B1 = 7.9 PEAK-TO-PEAK\* 15.9  
 TEETER ANG (DEG) A0 = -.6 A1 = -1.9 B1 = -.5 PFAK-TO-PEAK = 4.0

ROTOR LOADS (AMP/PHASE)

DRAG BRACE (N/DEG) CHORD .449 (N-M/DEG) CHORD .803 (N-M/DEG) PITCH LINK (N/DEG) TORSION .449 (N-M/DEG)

	DRAG BRACE (N/DEG)	CHORD .449 (N-M/DEG)	CHORD .803 (N-M/DEG)	PITCH LINK (N/DEG)	TORSION .449 (N-M/DEG)
MEAN HARMONIC-1	38551.	15555.	2023.	-2986.	-380.
2	4536./ -58.0	1437./ -62.5	362./ -73.9	3105./ -45.1	453./ -50.7
3	727./ -60.2	82./ 50.8	99./ -34.2	2817./ -58.7	308./ -61.1
4	3195./ 33.9	942./ 33.0	40./ 21.1	330./ -62.8	75./ -9.3
5	693./ -8.8	416./ -24.7	81./ -42.2	361./ 66.5	50./ -2.2
6	416./ 56.8	238./ 69.0	55./ 89.4	269./ 5.7	55./ 23.8
7	299./ 89.1	226./ -66.4	35./ -55.7	193./ -13.8	19./ 11.3
8	263./ 64.8	177./ 63.8	64./ 57.7	39./ 15.2	7./ -73.0
9	185./ -81.0	194./ -75.3	48./ -81.7	71./ -62.5	6./ -55.0
10	74./ -79.1	178./ -12.5	64./ -10.2	27./ -29.8	5./ 12.0
11	109./ 22.3	331./ 33.8	129./ 31.7	23./ -1.0	2./ 71.5
12	59./ -79.4	53./ -36.5	12./ -55.2	39./ 11.9	7./ 13.4
PEAK-TO-PEAK	96./ 86.4	39./ -60.4	8./ 44.9	24./ -24.8	2./ -67.8
PEAK-TO-PEAK	16114.	5752.	1450.	10974.	1244.

BEAM .174 (N-M/DEG) BEAM .350 (N-M/DEG) BEAM .449 (N-M/DEG) BEAM .606 (N-M/DEG) BEAM .803 (N-M/DEG)

	BEAM .174 (N-M/DEG)	BEAM .350 (N-M/DEG)	BEAM .449 (N-M/DEG)	BEAM .606 (N-M/DEG)	BEAM .803 (N-M/DEG)
MEAN HARMONIC-1	5.	161.	49.	-176.	-29.
2	1130./ -67.7	501./ -69.1	502./ -68.1	451./ -71.7	214./ 84.1
3	514./ -64.6	315./ 88.6	328./ 86.8	275./ -88.5	122./ -64.3
4	283./ 15.2	5./ -22.8	66./ 45.9	162./ 53.3	177./ 51.1
5	281./ 13.5	91./ -7.5	53./ -24.7	59./ 13.2	129./ -9.1
6	104./ -52.1	4./ 79.1	23./ -.6	10./ -52.5	67./ 8.3
7	24./ -60.0	11./ 42.7	10./ -66.6	15./ 68.8	27./ -86.0
8	38./ 10.9	3./ 39.6	21./ 33.6	12./ 62.2	42./ 58.9
9	21./ 20.6	6./ .5	9./ 54.8	11./ 46.5	24./ 79.9
10	12./ -30.0	7./ 15.5	7./ -54.9	8./ 57.8	10./ -75.7
11	34./ -89.4	13./ -58.4	8./ -68.2	19./ -53.6	16./ -42.5
12	7./ -7.4	6./ 51.7	1./ -54.3	7./ 42.3	5./ 48.6
PEAK-TO-PEAK	22./ 16.2	7./ 64.1	6./ 41.4	5./ 74.7	4./ 64.2
PEAK-TO-PEAK	3570.	1522.	1485.	1374.	1001.

FLIGHT NO. 063 AIRCRAFT TOTAL UT = 33698. N LOADED CG X = 5.03 M = 197.9 IN  
 RUN NO. 10 7576. LB Y = -.00 = -.0  
 TIME 54541.60 (SEC) Z = 1.85 = 77.8

AERODYNAMIC FLIGHT STATE

DYNAMIC PRES\* 3.53 KPA = 73.8 PSF  
 STATIC PRES\* 79.8 KPA = 1668. PSF  
 TOTAL TEMP- 267.9 OEG K = 482.2 DFG R  
 STATIC TEMP\* 264.6 DEG K = 476.3 DFG R  
 T. AIRSPFFD= 158.3 KT  
 A/C MACH NO = .250  
 BODY ALPHA= -6.1 DEG DENSITY- 1.05 KG/M3 = .00204 SLUG/FT3  
 BODY BETA= -5 OEG DENSITY ALT= 1565. M = 5133. FT  
 SONIC SPEED- 326.6 M/SEC = 1072. FPS  
 RATE OF CLIMB= -116. M/MIN = -380. FPM

INERTIAL FLIGHT STATE

AXIS	CG U N VFL (M/S) (FPS)	CG LIN ACC (G)	HUB LIN VEL (M/S) (FPS)	HUB LIN ACC (G)	AXIS	ANG POS (DEG)	ANG PATES (RAD/SEC)	ANG ACC (RAD/SEC2)
X	80.99 265.7	-.119	80.98 265.7	-.121	ROLL	-1.1	-.005	-.048
Y	-.75 -2.5	.038	-.76 -2.5	.028	PITCH	-7.4	.002	.010
Z	-8.63 -28.3	-.971	-8.63 -28.3	-.971	YAW	337.7	.002	.015

CONTROL ANGLES

M.R. COLL= 14.8 DEG HORIZ FIN= 10.6 DEG  
 A1= -1.5 DEG T.R. COLL\* 2.3 OFG  
 B1= 1.1 OEG PEDAL POS- 2.5 DFG

ROTOR PARAMETERS

SHAH ALPHA= -6.1 DEG  
 HOVER TIP MACH- .70 CONTROL ALPHA- -15.1 OFG  
 TIP MAX-MACH= .95 DELTA PSI= .5 OEG  
 TIP MIN-MACH- .45  
 .9R MAX-MACH- .88 ENGINE POWER= 771. KW = 1034. HP  
 .9R MIN-MACH- .38 THRUST FACTOR- .771E+07 N = .173E+07 LB

NASA LANGLEY FLIGHT DATA AH-1G ---- ROTOR PERFORMANCE AND LOADS

FLIGHT NO. 63 MU= .356 TOTAL CQ = .000436 AMR TEMP = -8.5 C = 16.61 F  
 PUN NO. 10 V = 158.3 KT MAST CQ = .000423 TEMP U60 = 11.1 C = 51.94 F  
 TIME 54541.45 NZ = .971 G OMEGA = 34.084 RAD/SEC CAN TEMP = -3.0 C = 26.58 F  
 CLP = .00421 RPM/324 = 1.005

ROTOR ANGLES THETA 314 (DEG) A0 = 14.7 A1 = -1.1 B1 = 10.6 PEAK-TO-PEAK- 21.1  
 TEETER ANG (DEG) A0 = -.6 A1 = -2.4 B1 = -1.4 PFAK-TO-PEAK- 5.3

ROTOR LOADS (AMP/PHASE)	DRAG BRACE (N/DEG)	CHORD .449 (N-M/DEG)	CHORD .803 (N-M/DEG)	PITCH LINK (N/DEG)	TORSION .449 (N-M/DEG)
MEAN	34769.	16470.	1979.	-4293.	-555.
HARMONIC-1	7196./ -71.1	2367./ -71.3	538./ -81.0	4480./ -49.1	608./ -51.1
2	1327./ 65.6	557./ 15.6	179./ -17.9	4024./ -52.2	450./ -63.4
3	6082./ 39.0	1841./ 40.8	97./ 84.1	513./ 57.3	83./ -10.7
4	1176./ -12.5	758./ -27.3	129./ -35.3	457./ 62.9	73./ -11.6
5	786./ 64.6	487./ 84.8	127./ -79.8	137./ -27.1	22./ 44.7
6	328./ 22.2	148./ 7.0	42./ -38.4	269./ 16.2	30./ .1
7	457./ 9.7	292./ 2.4	101./ -3.3	56./ 55.1	22./ -.5
8	165./ -78.5	102./ 78.8	40./ 82.8	30./ 62.3	4./ 63.4
9	30./ 87.8	97./ 26.8	47./ 65.2	39./ -32.4	6./ -28.9
10	90./ -61.0	156./ 56.6	53./ 39.6	96./ 86.8	17./ -84.8
11	117./ -23.2	121./ 10.8	34./ -6.2	22./ -76.2	5./ -64.1
12	64./ -15.4	78./ 18.1	33./ 61.2	28./ 4.4	2./ 7.0
PEAK-TO-PFAK	25859.	8364.	1772.	15129.	1788.

	BEAM .174 (N-M/DEG)	BEAM .350 (N-M/DEG)	BEAM .449 (N-M/DEG)	BEAM .605 (N-M/DEG)	BEAM .803 (N-M/DEG)
MEAN	308.	182.	60.	-157.	-59.
HARMONIC-1	1940./ -70.8	664./ -69.2	622./ -67.1	562./ -69.2	287./ 87.7
2	742./ -48.2	414./ -88.1	419./ 85.8	331./ 86.9	118./ -64.1
3	314./ 13.2	31./ -27.0	117./ 40.9	288./ 35.2	334./ 30.6
4	348./ 17.4	102./ -10.8	59./ -35.9	59./ 18.6	118./ -18.0
5	143./ -53.0	6./ -21.7	26./ -14.7	17./ -16.9	57./ -8.4
6	75./ -59.9	8./ 2.6	26./ -66.5	21./ 74.7	40./ -64.6
7	81./ -34.1	11./ -38.3	25./ -13.9	9./ 32.4	44./ 19.1
8	13./ -3.7	4./ 46.3	9./ 50.1	5./ -61.5	18./ -87.8
9	4./ -78.4	7./ -4.3	7./ -76.5	12./ 61.2	13./ -88.2
10	46./ 58.4	15./ 72.4	13./ 44.2	21./ 83.0	20./ 88.7
11	16./ -82.3	3./ -5.6	7./ 48.9	1./ 61.1	1./ -45.4
12	21./ 22.2	6./ 44.9	5./ 43.2	5./ 74.3	4./ -84.0
PFAK-TO-PEAK	6229.	2007.	1874.	1757.	1434.

FLIGHT NO. 063 AIRCRAFT TOTAL WT = 33705. N LOADED CG X = 5.03 ■ = 197.9 IN  
 RUN NO. 9 7578. LB Y = -0.00 ■ = -0.0  
 TIME 54467.20 (SEC) Z = 1.85 ■ = 77.8

AERODYNAMIC FLIGHT STATE

DYNAMIC PRES = 3.02 KPA ■ = 63.0 PSF  
 STATIC PRES = 79.7 KPA = 1664. PSF  
 TOTAL TEMP = 267.0 OEG K = 480.5 DEG R  
 STATIC TEMP = 264.1 DEG K = 475.4 DEG R  
 T. AIRSPEED = 146.4 KT  
 A/C MACH NO = .231  
 DENSITY = 1.05 KG/M3 = .00204 SLUG/FT3  
 BODY ALPHA = -4.7 DEG DENSITY ALT = 1570. M = 5150. FT  
 BODY BETA = .8 DEG SONIC SPEED = 326.4 M/SEC = 1071. FPS  
 RATE OF CLIMB = -103. M/MIN = -339. FPM

INERTIAL FLIGHT STATE

AXIS	CG LIN (M/S)	VEL (FPS)	CG LIN ACC (G)	HUB LIN VEL (M/S)	VEL (FPS)	HUB LIN ACC (G)	AXIS	ANG PNS (DEG)	ANG QATFS (RAD/SFC)	ANG ACC (RAD/SEC2)
X	75.07	246.3	-.102	75.06	246.3	-.102	ROLL	-0.4	.000	.042
Y	1.12	3.7	.012	1.12	3.7	.021	PITCH	-6.1	.006	.000
Z	-6.22	-20.4	-1.004	-6.22	-20.4	-1.004	YAW	332.0	.004	-.020

CONTROL ANGLES

M.R. COLL = 13.0 OEG HORIZ FIN = 9.6 OEG  
 A1 = -7 DEG T.R. COLL = 2.7 OFG  
 B1 = 7.9 DEG PEDAL POS = 2.5 OFG

ROTOR PARAMETERS

SHAFT ALPHA\* -4.7 DEG  
 CONTROL ALPHA -12.7 DEG  
 HOVER TIP MACH = .70  
 TIP MAX-MACH\* .93  
 TIP MIN-MACH\* .47  
 .9R MAX-MACH- .86  
 .9R MIN-MACH = .40  
 DELTA PSI = -.9 DEG  
 ENGINE POWER\* 647. KW = 867. HP  
 THRUST FACTOR\* .777E+07 N = .173E+07 LB

NASA LAMGLFY FLIGHT DATA AH-1G ---- ROTOR PERFORMANCE AND LOADS

FLIGHT NO. 63 MU\* .330 TOTAL CQ = .000366 AMB TEMP = -1.0 C = 15.77 F  
 RUN NO. 9 V = 146.4 KT MAST CQ = .000353 TEMP U60 = 10.5 C = 50.94 F  
 TIME 54467.07 NZ = 1.004 G OMEGA = 34.081 RAD/SEC CAN TEMP = -3.0 C = 26.58 F  
 CLP = .00436 RPM/324 = 1.004

ROTOR ANGLES

THETA 314 (DEG) A0 = 13.0 A1 = -3 B1 = 8.9 PEAK-TO-PEAK- 17.9  
 TESTER ANG IOEGI A0 = -6 A1 = -1.8 B1 = -6 PFAK-TO-PEAK- 3.9

ROTOR LOADS (AMP/PHASE)

DRAG BRACE (N/DEG) CHORD .449 (N-M/DEG) CHORD .803 (N-M/DEG) PITCH LINK (N/DEG) TORSION .449 (N-M/DEG)

	MEAN	37239.	15942.	2036.	-3502.	-456.
HARMONIC-1	5775./ -64.3	1874./ -67.5	427./ -79.3	3785./ -48.9	528./ -52.6	
2	1078./ 62.6	400./ 2.3	160./ -31.9	3479./ -59.2	390./ -66.0	
3	4438./ 31.3	1334./ 33.4	53./ 62.7	343./ 83.2	79./ -17.6	
4	840./ -6.7	570./ -30.0	93./ -49.9	451./ 60.5	69./ -8.5	
5	500./ 55.4	352./ 81.4	100./ -74.5	140./ .4	31./ 54.6	
6	73./ 2.4	111./ 30.7	52./ 48.2	192./ -23.5	16./ -35.7	
7	91./ 46.0	78./ 76.1	51./ 44.1	8./ -76.1	15./ -40.7	
8	42./ -16.3	102./ -75.0	13./ -66.8	32./ -70.0	2./ 84.1	
9	30./ -22.4	141./ -6.0	47./ -11.6	57./ -69.1	4./ -67.2	
10	38./ 14.5	258./ 4.7	107./ 7.6	79./ 69.9	12./ 64.3	
11	113./ -62.0	88./ -64.8	59./ -78.8	22./ 5.2	2./ 61.7	
12	30./ -15.5	17./ 86.0	12./ 14.3	22./ -19.9	3./ 5.1	
PEAK-TO-PEAK	21110.	6975.	1348.	12900.	1573.	

BEAM .174 (N-M/DEG) BEAM .350 (N-M/DEG) BEAM .449 (N-M/DEG) BEAM .606 (N-M/DEG) BEAM .803 (N-M/DEG)

	MEAN	143.	167.	51.	-170.	-37.
HARMONIC-1	1487./ -70.1	590./ -70.3	574./ -68.9	520./ -71.7	255./ 84.3	
2	671./ -59.4	379./ 86.4	384./ 82.1	310./ 84.1	125./ -68.8	
3	469./ 7.2	16./ -28.9	91./ 41.0	224./ 39.2	251./ 35.7	
4	349./ 12.6	102./ -12.1	56./ -35.8	68./ 10.1	138./ -17.6	
5	111./ -56.5	1./ -80.6	30./ -17.1	15./ -30.1	70./ -13.2	
6	45./ -89.4	12./ 8.6	16./ -83.8	17./ 50.2	30./ 70.9	
7	37./ -26.2	7./ -13.4	17./ 6.4	11./ 47.5	38./ 32.7	
8	26./ 41.0	2./ -49.9	18./ 59.8	12./ 47.7	33./ 70.2	
9	20./ -65.5	15./ -36.2	12./ -72.3	13./ -9.6	10./ 43.7	
10	56./ 43.5	22./ 61.8	14./ 36.9	28./ 73.9	22./ 83.5	
11	14./ 85.7	6./ -21.7	4./ 1.9	5./ -2.2	4./ 20.6	
12	34./ 15.8	8./ 22.2	11./ 42.2	10./ 48.1	6./ 49.9	
PEAK-TO-PEAK	4789.	1781.	1713.	1612.	1238.	

NASA LANGLEY FLIGHT DATA AH-1G ---- PADS PCM DATA

FLIGHT NO. 063 AIRCRAFT TOTAL WT = 33627. N LOADED CG X = 5.03 M = 197.9 IN  
 RUN NO. 11 7560. LB Y = -.00 Z = -0.0  
 TIME 54648.80 (SEC) Z = 1.85 M = 77.9

AERODYNAMIC FLIGHT STATE

DYNAMIC PRES = 3.81 KPA = 79.5 PSF  
 STATIC PRES = 79.4 KPA = 1659. PSF  
 TOTAL TEMP = 267.7 OEG K = 481.9 DEG R  
 STATIC TEMP = 264.2 DEG K = 475.5 DEG R  
 T. AIRSPEED = 164.5 KT  
 A/C MACH NO = .259  
 BODY ALPHA = -6.5 DEG  
 BODY BETA = .8 DEG  
 DENSITY = 1.05 KG/M3 = .00203 SLUG/FT3  
 DENSITY ALT = 1598. M = 5244. FT  
 SONIC SPEED = 326.4 M/SEC = 1071. FPS  
 RATE OF CLIMB = -99. M/MIN = -326. FPM

INERTIAL FLIGHT STATE

AXIS	CG LIN VEL (M/S)	CG LIN VEL (FPS)	CG LIN ACC (G)	HUB LIN VEL (M/S)	HUB LIN VEL (FPS)	HUB LIN ACC (G)	AXIS	ANG POS (DEG)	ANG RATES (RAD/SEC)	ANG ACC (RAD/SEC2)
X	84.06	275.8	-.132	84.06	275.8	-.137	ROLL	.1	.007	-.114
Y	1.23	4.0	.007	1.24	4.1	-.017	PITCH	-7.6	.001	.022
Z	-9.51	-31.2	-.996	-9.51	-31.2	-.996	YAW	334.2	-.003	.011

CONTROL ANGLES

MR. COLL = 15.6 OEG HORIZ FIN = 10.9 OEG  
 A1 = -1.3 OEG T.R. COLL = 3.8 OEG  
 B1 = 9.4 OEG PEDAL POS = 3.9 DEG

ROTOR PARAMETERS

SHAFT ALPHA = -6.5 DEG  
 HOVER TIP MACH = .70 CONTROL ALPHA = -15.8 DEG  
 TIP MAX-MACH = .96 DELTA PSI = -.8 DEG  
 TIP MIN-MACH = .44  
 .9R MAX-MACH = .89 ENGINE POWER = 848. KW = 1138. HP  
 .9R MIN-MACH = .37 THRUST FACTOR = .768E+07 N = .173F+07 LB

NASA LANGLEY FLIGHT DATA AH-1G ---- ROTOR PERFORMANCE AND LOADS

FLIGHT NO. 63 MU = .370 TOTAL CQ = .000482 AMB TEMP = -9.0 C = 15.80 F  
 RUN NO. 11 V = 164.5 KT MAST CQ = .000466 TEMP U60 = 11.3 C = 52.29 F  
 TIME 54648.65 NZ = .996 G OMEGA = 34.072 RAD/SEC CAN TEMP = -3.0 C = 26.58 F  
 CLP = .00433 RPM/324 = 1.004

ROTOR ANGLES THETA 314 (DEG) A0 = 15.4 A1 = -.7 B1 = 11.7 PEAK-TO-PEAK\* 22.3  
 TEETER ANG (DEG) A0 = -.6 A1 = -2.4 B1 = -1.3 PEAK-TO-PEAK\* 5.2

ROTOR LOADS (AMP/PHASE) DRAG BRACE CHORD .449 CHORD .803 PITCH LINK TORSION .449  
 (N/DEG) (N-M/DEG) (N-M/DEG) (N-M/DEG) (N-M/DEG)

	33198.	16802.	1893.	-4505.	-597.
MEAN HARMONIC-1	7846./ -69.0	2533./ -69.6	590./ -82.2	4798./ -52.7	635./ -55.0
2	2143./ 35.7	992./ 10.9	243./ -13.6	4082./ -54.7	440./ -67.7
3	7208./ 30.2	2187./ 32.4	172./ 64.4	699./ 36.2	82./ -19.7
4	1267./ -36.2	790./ -44.9	139./ -53.5	356./ 37.0	84./ -25.2
5	572./ -44.4	343./ 82.4	120./ -71.8	293./ 66.0	46./ 53.3
6	311./ -33.8	260./ -51.4	121./ -74.3	178./ 40.3	19./ -6.1
7	583./ -25.5	397./ -30.0	123./ -27.1	64./ 26.5	32./ 7.6
8	162./ -89.2	53./ 72.6	25./ 66.0	58./ -36.7	9./ -27.9
9	59./ 51.1	105./ 42.2	63./ 49.0	22./ -22.0	7./ -16.0
10	66./ -62.3	133./ 28.0	57./ 7.0	116./ -74.6	21./ 80.9
11	96./ -15.0	181./ -1.9	79./ -18.3	21./ -54.6	3./ 2.1
12	54./ -25.7	37./ 10.7	18./ -57.8	6./ -47.0	2./ -63.1
PEAK-TO-PEAK	29486.	9464.	2098.	15506.	1923.

	BEAM .174 (N-M/DEG)	BEAM .350 (N-M/DEG)	BEAM .449 (N-M/DEG)	BEAM .606 (N-M/DEG)	BEAM .803 (N-M/DEG)
MEAN HARMONIC-1	512.	197.	63.	-151.	-61.
2	2197./ -72.7	721./ -72.1	667./ -70.1	607./ -71.8	323./ 86.7
3	807./ -43.7	420./ 88.9	429./ 81.3	343./ 81.0	129./ -71.6
4	821./ 4.4	32./ -41.9	137./ 28.3	333./ 24.2	383./ 20.6
5	338./ 4.4	104./ -22.3	60./ -48.1	52./ 10.7	104./ -33.5
6	160./ -83.4	8./ -6.0	24./ -50.6	21./ -23.5	49./ -48.6
7	14./ -76.7	8./ -22.7	17./ 86.6	19./ 47.6	23./ 66.1
8	89./ -47.5	8./ -46.3	29./ -23.6	14./ 17.3	49./ .3
9	16./ -21.5	1./ 59.9	8./ 55.1	3./ -77.3	22./ 73.1
10	2./ -34.3	14./ 23.1	4./ 67.9	21./ 39.7	21./ 70.5
11	58./ 76.9	26./ 81.4	11./ 72.1	31./ 85.9	30./ -79.5
12	27./ -55.3	9./ -17.8	5./ -87.7	6./ -53.6	8./ -22.4
PEAK-TO-PEAK	6824.	2149.	1976.	1880.	1494.

FLIGHT NO. 063 AIRCRAFT TOTAL WT = 33628. N LOADED OG X = 5.03 M = 197.9 IN  
 RUN NO. 11 7560. LB Y = -.00 Z = -.0  
 TIME 54649.20 (SEC) Z = 1.85 = 72.9

AERODYNAMIC FLIGHT STATE

T. AIRSPEED = 164.6 KT DYNAMIC PRES = 3.81 KPA = 79.6 PSF  
 A/C MACH NO = .260 STATIC PRES = 79.4 KPA = 1659. PSF  
 TOTAL TEMP\* 267.7 OEG K = 481.9 REG R  
 STATIC TEMP\* 264.2 OEG K = 475.5 DFG R  
 BODY ALPHA = -6.4 DEG DENSITY = 1.05 KG/M3 = .00203 SLUG/FT3  
 BODY BETA = .9 DEG DENSITY ALT = 1601. M = 5254. FT  
 SONIC SPEED = 326.4 M/SEC = 1071. FPS  
 RATE OF CLIMB = -93. M/MIN = -304. FPM

INERTIAL FLIGHT STATE

AXIS	CG LIN VEL (M/S)	CG LIN ACC (G)	HUB LIN VEL (M/S)	HUB LIN ACC (G)	AXIS	ANG POS (DEG)	ANG RATES (RAD/SEC)	ANG ACC (RAD/SEC2)	
X	84.11	276.0	-0.131	84.10	275.9	-0.132	ROLL -0	-0.001	.067
Y	1.35	4.4	.009	1.35	4.4	.023	PITCH -7.5	.007	.003
Z	-9.45	-31.0	-1.006	-9.45	-31.0	-1.006	YAW 334.2	-0.002	.011

CONTROL ANGLES M.R. COLL = 15.6 OEG HORIZ FIN = 11.1 DEG  
 A1 = -1.2 DEG T.R. COLL = 3.8 DEG  
 B1 = 9.6 DEG PEDAL POS = 3.9 OEG

ROTOR PARAMETERS

SHAFT ALPHA = -6.4 DEG  
 CONTROL ALPHA = -16.0 DEG  
 HOVER TIP MACH = .70  
 TIP MAX-MACH = .96  
 TIP MIN-MACH = .44  
 .9R MAX-MACH = .89  
 .9R MIN-MACH = .37  
 DELTA PSI = -.9 DEG  
 ENGINE POWER = 846. KW = 1135. HP  
 THRUST FACTOR = .768E+07 N = .173E+07 LB

NASA LANGLEY FLIGHT DATA AH-1G ---- ROTOR PERFORMANCE AND LOADS

FLIGHT NO. 63 MU = .370 TOTAL CQ = .000480 AMB TEMP = -9.0 C = 15.80 F  
 RUN NO. 11 V = 164.6 KT MAST CQ = .000465 TEMP U60 = 11.3 C = 52.26 F  
 TIME 54649.05 NZ = 1.006 G OMEGA = 34.096 RAD/SEC CAN TEMP = -3.0 C = 26.58 F  
 CLP = .00437 RPM/324 = 1.005

ROTOR ANGLES THETA 3/4 (DEG) A0 = 15.4 A1 = -.5 B1 = 11.2 PEAK-TO-PEAK- 22.6  
 TEETER ANG (DEG) A0 = -.6 A1 = -2.4 B1 = -1.1 PFAK-TO-PEAK\* 5.1

ROTOR LOADS (AMP/PHASE) DRAG BRACE (N/DEG) CHORD .449 (N-M/DEG) CHORD .803 (N-M/DEG) PITCH LINK (N/DEG) TORSION .449 (N-M/DEG)

	MEAN	33519.	16713.	1916.	-4556.	-597.
HARMONIC-1	7549./ -75.5	2452./ -75.7	568./ -86.3	4752./ -53.5	633./ -55.1	432./ -68.0
2	1699./ 51.1	763./ 16.9	195./ -15.0	4042./ -54.8	75./ -22.8	432./ -68.0
3	6862./ 31.6	2086./ 33.7	180./ 73.9	661./ 30.8	75./ -22.8	75./ -22.8
4	1381./ -38.9	804./ -44.9	143./ -58.2	401./ 45.6	79./ -20.6	79./ -20.6
5	785./ 34.3	369./ 70.5	136./ -83.6	253./ 71.8	37./ 54.5	37./ 54.5
6	584./ -33.9	392./ -43.3	144./ -61.8	158./ 36.1	23./ -27.7	23./ -27.7
7	612./ -16.2	393./ -20.5	122./ -17.2	87./ 25.4	35./ -3.0	35./ -3.0
8	153./ -87.8	82./ 56.5	22./ 26.2	58./ -38.6	8./ -19.6	8./ -19.6
9	29./ -58.7	47./ 29.9	23./ 25.7	40./ -43.9	8./ -72.1	8./ -72.1
10	63./ -42.9	64./ -13.7	46./ -51.8	111./ 83.8	20./ 72.5	20./ 72.5
11	93./ -37.8	118./ -10.7	62./ -40.2	22./ -44.2	4./ 2.4	4./ 2.4
12	14./ 84.2	63./ -9.6	16./ 27.3	10./ -25.1	3./ 87.7	3./ 87.7
PEAK-TO-PEAK	27708.	9108.	2126.	15431.	1894.	1894.

	BEAM .174 (N-M/DEG)	BEAM .350 (N-M/DEG)	BEAM .449 (N-M/DEG)	BEAM .606 (N-M/DEG)	BEAM .803 (N-M/DEG)
MEAN	469.	194.	64.	-150.	-64.
HARMONIC-1	2155./ -75.3	717./ -72.9	665./ -70.3	605./ -72.0	318./ 86.7
2	793./ -47.7	428./ 87.7	436./ 80.8	350./ 81.0	139./ -71.4
3	797./ 4.3	30./ -47.1	140./ 27.7	331./ 23.5	378./ 19.9
4	360./ 10.8	101./ -17.5	59./ -48.8	60./ 22.2	98./ -24.3
5	131./ -73.6	12./ 32.1	28./ -47.9	22./ -12.0	56./ -50.8
6	50./ 75.7	6./ -13.0	20./ 69.7	24./ 47.3	31./ 56.9
7	75./ -46.8	9./ -79.4	25./ -28.6	14./ 29.0	48./ -8.3
8	13./ 45.6	2./ 55.2	6./ 59.4	3./ 75.7	20./ 65.7
9	17./ 87.1	12./ 23.3	5./ 89.5	20./ 38.0	21./ 63.9
10	54./ 48.2	27./ 60.7	14./ 49.5	33./ 72.3	26./ -89.3
11	16./ -77.5	7./ -18.7	3./ -81.6	8./ -58.0	7./ 3.8
12	18./ -19.4	5./ -14.5	2./ 42.6	4./ -2.8	3./ 61.2
PEAK-TO-PEAK	6728.	2110.	1972.	1884.	1496.



FLIGHT NO. 063 AIRCRAFT TOTAL WT 33624. N LOADED CG X= 5.03 M 197.9 IN  
 RUN NO. 11 7559. LB Y= -.00 Z= -.0  
 TIME 54649.60 (SECS) Z= 1.85 M 77.9

AERODYNAMIC FLIGHT STATE

T. AIRSPEED- 164.4 KT  
 A/C MACH NO= .259

DYNAMIC PRES= 3.81 KPA = 79.5 PSF  
 STATIC PRES= 79.5 KPA = 1660. PSF  
 TOTAL TEMP= 267.7 DEG K = 481.8 DEG R  
 STATIC TEMP= 264.1 DEG K = 475.4 DEG R

BODY ALPHA= -6.3 OEG  
 BODY BETA= 1.0 REG

DENSITY\* 1.05 KG/M3 = .00203 SLUG/FT3  
 DENSITY ALT= 1594. M = 5229. FT  
 SONIC SPEED\* 326.3 M/SEC = 1071. FPS  
 RATE OF CLIMB- -90. M/MIN = -297. FPM

INERTIAL FLIGHT STATE

AXIS	CG LIN VEL (M/S)	CG LIN VEL (FPS)	CG LIN ACC (G)	HUB LIN VEL (M/S)	HUB LIN VEL (FPS)	HUB LIN ACC (G)	AXIS	ANG POS (DEG)	ANG RATES (RAD/SEC)	ANG ACC (RAD/SEC2)
X	84.07	275.8	-.129	84.06	275.8	-.133	ROLL	-.0	-.003	-.029
Y	1.42	4.7	.011	1.41	4.6	.005	PITCH	-7.4	.007	.017
Z	-9.33	-30.6	-1.013	-9.33	-30.6	-1.013	YAW	334.2	.005	-.020

CONTROL ANGLES

M.R. COLL= 15.6 OEG HORIZ FIN= 11.0 OEG  
 A1= -1.1 DEG T.R. COLL= 3.7 OEG  
 B1= 9.5 DEG PEDAL POS= 3.9 OEG

ROTOR PARAMETERS

SHAFT ALPHA\* -6.3 DEG  
 HOVER TIP MACH\* .70 CONTROL ALPHA= -15.8 DEG  
 TIP MAX-MACH= .96 DELTA PSI= -1.0 DEG  
 TIP MIN-MACH\* .44  
 .9R MAX-MACH\* .89 ENGINE POWER= 844. KW = 1132. HP  
 .9R MIN-MACH= .37 THRUST FACTOR\* .769E+07 N = .173E+07 LB

NASA LANGLEY FLIGHT DATA AH-1G ---- ROTOR PERFORMANCE AND LOADS

FLIGHT NO. 63 MU= .370 TOTAL CQ= .000479 AMR TFMP= -9.0 C = 15.72 F  
 RUN NO. 11 V= 164.4 KT MAST CQ= .000459 TEMP U60= 11.3 C = 52.25 F  
 TIME 54649.54 NZ= 1.013 G OMEGA\* 34.055 RAD/SEC CAN TFMP= -3.0 C = 26.58 F  
 CLP= .00441 RPM/324= 1.004

ROTOR ANGLES

THETA 3/4 (DEG) AO\* 15.4 A1= -5 R1= 11.3 PEAK-TO-PEAK= 22.6  
 TEETER ANG (DEG) AO= -4.6 A1= -2.4 B1= -1.1 PFAK-TO-PEAK= 5.0

ROTOR LOADS (AMP/PHASE)

	DRAG BRACE (N/DEG)	CHORD .449 (N-M/DEG)	CHORD .803 (N-M/DEG)	PITCH LINK (N/DEG)	TORSION .449 (N-M/DEG)
MEAN	33588.	16681.	1920.	-4536.	-593.
HARMONIC-1	8369./ -73.1	2680./ -73.0	605.1 -84.0	4860./ -53.1	638.1 -54.4
2	1776.1 32.6	909.1 5.0	247.1 -16.9	4095.1 -55.5	443.1 -68.9
3	6902./ 29.7	2072.1 31.9	164.1 73.9	665.1 34.6	83.1 -19.2
4	1187.1 -36.2	767.1 -45.4	127.1 -59.2	386.1 42.0	83./ -25.7
5	748./ 44.2	368.1 74.0	112.1 -86.2	260.1 67.2	38.1 43.0
6	409./ -15.8	292.1 -34.0	107.1 -65.6	193.1 4h.R	23./ 5.0
7	583.1 -22.9	388.1 -23.8	109.1 -16.6	84.1 2R.9	32.1 5.9
8	103.1 66.1	63.1 67.8	14.1 39.7	61.1 -39.2	6./ -26.6
9	29.1 42.7	117.1 16.1	66.1 35.2	45.1 -.2	8./ -32.2
10	12.1 67.7	87./ 14.4	45.1 -35.4	121.1 81.9	22./ 63.3
11	64.1 -36.6	139.1 -6.1	67./ -12.6	39.1 -80.2	3./ 52.3
12	59./ -67.1	56.1 -53.8	6.1 45.8	13./ 16.0	3./ 73.2
PEAK-TO-PEAK	29553.	9578.	2023.	15552.	1919.

	BEAM .174 (N-M/DEG)	BEAM .350 (N-M/DEG)	BEAM .449 (N-M/DEG)	BEAM .606 (N-M/DEG)	BEAM .803 (N-M/DEG)
MEAN	487.	198.	66.	-152.	-63.
HARMONIC-1	2240./ -74.3	727./ -72.4	671./ -70.0	607./ -77.3	317./ 85.5
2	845./ -46.4	434./ 88.8	438./ 81.1	348./ 81.9	135./ -67.3
3	815./ 3.0	33./ -46.3	139./ 27.6	332./ 23.2	380./ 19.3
4	346./ 7.2	104./ -20.7	60./ -47.4	56./ 16.4	98./ -30.5
5	150./ -80.6	10./ -10.4	24./ -48.4	22./ -23.8	50./ -46.4
6	21./ 81.6	7./ -28.5	21./ 77.1	21./ 43.7	26./ 58.7
7	78./ -52.5	6./ -62.1	22./ -21.6	12./ 25.3	45./ -4.9
8	13./ -12.9	5./ 54.4	8./ 42.5	1./ 33.1	20./ 67.4
9	9./ 81.8	9./ -10.6	8./ 74.4	16./ 23.0	15./ 61.1
10	61./ 52.0	24./ 68.1	11./ 47.5	30./ 72.9	28./ 89.6
11	29./ -83.0	5./ -35.5	5./ 47.1	5./ -77.7	5./ -36.2
12	20./ -52.5	6./ -21.3	1./ 7.0	3./ 15.1	1./ 43.7
PEAK-TO-PEAK	7010.	2147.	1976.	1880.	1472.

NASA LANGLEY FLIGHT DATA AH-1G ---- PADS PCM DATA

FLIGHT NO. 063 AIRCRAFT TOTAL WT = 33581. N LOADED CG X = 5.03 M = 197.9 IN  
 RUN NO. 12 7550. LB Y = -.00 Z = -.0  
 TIME 54693.20 (SEC) Z = 1.95 • 72.9

AERODYNAMIC FLIGHT STATE

T. AIRSPEED- 133.9 KT DYNAMIC PRES = 2.52 KPA = 52.7 PSF  
 A/C MACH NO = .211 STATIC PRES = 80.0 KPA = 1670. PSF  
 TOTAL TEMP\* 266.6 DEG K = 479.8 DEG R  
 STATIC TEMP- 264.2 DEG K = 475.6 DEG R  
 BODY ALPHA= 2.3 DEG DENSITY- 1.05 KG/M3 = .00205 SLUG/FT3  
 BODY BETA = 5.0 DEG DENSITY ALT = 1535. M = 5036. FT  
 SONIC SPEED\* 326.4 M/SEC = 1071. FPS  
 RATE OF CLIMB\* -377. M/MIN = -1236. FPM

INERTIAL FLIGHT STATE

AXIS	CG LIN VEL (M/S)	CG LIN VEL (FPS)	CG LIN ACC (G)	HUB LIN VEL (M/S)	HUB LIN VEL (FPS)	HUB LIN ACC (G)	AXIS	ANG POS (DEG)	ANG RATES (RAD/SEC)	ANG ACC (RAD/SEC2)
X	68.57	225.0	-.084	68.57	225.0	-.083	ROLL	2.9	-.011	-.013
Y	6.03	19.8	-.064	6.01	19.7	-.067	PITCH	-2.7	-.001	-.001
Z	2.72	8.9	-.984	2.72	8.9	-.984	YAW	372.4	-.007	-.007

CONTROL ANGLES

M.R. COLL = 7.9 DEG HDRIZ FIN = 8.4 DEG  
 A1 = .8 DEG T.R. COLL = 1.5 DEG  
 B1 = 6.1 DEG PEDAL POS = 1.6 DEG

ROTOR PARAMETERS

HOVER TIP MACH\* .71 SHAFT ALPHA = 2.3 DEG  
 CONTROL ALPHA\* -3.8 DEG  
 TIP MAX-MACH = .92 DELTA PSI = -5.0 DEG  
 TIP MIN-MACH = .50  
 .9R MAX-MACH = .85 ENGINE POWER = 290. KW = 389. HP  
 .9R MIN-MACH = .42 THRUST FACTOR = .791E+07 N = .178E+07 LB

NASA LANGLEY FLIGHT DATA AH-1G ---- ROTOR PERFORMANCE AND LOADS

FLIGHT NO. 63 MU = .298 TOTAL CQ = .000158 AMB TEMP = -8.9 C = 15.91 F  
 RUN NO. 12 V = 133.9 KT MAST CQ = .000150 TFMP U60 = 11.4 C = 52.49 F  
 TIME 54693.05 NZ = .984 G OMEGA = 34.459 RAD/SEC CAN TEMP = -3.0 C = 26.58 F  
 CLP = .00415 RPM/324 = 1.016

ROTOR ANGLES

THETA 314 (DEG) A0 = 8.2 A1 = 1.3 B1 = 6.2 PEAK-TO-PEAK- 13.2  
 TEETER ANG (DEG) A0 = -7 A1 = -1.9 B1 = .4 PFAK-TO-PEAK\* 4.0

ROTOR LOADS (AMP/PHASE)

	DRAG BRACE (N/DEG)	CHORD .449 (N-M/DEG)	CHORD .803 (N-M/DEG)	PITCH LINK (N/DEG)	TORSION .449 (N-M/DEG)
MEAN HARMONIC-1	45216.	14563.	2051.	-1582.	-261.
2	1139./ -53.1	340./ -60.9	186./ 71.8	2963./ -50.0	462./ -64.8
3	1336./ 80.7	338./ 55.8	54./ -39.5	3268./ -75.5	333./ -70.7
4	3453./ -21.2	990./ -18.0	21./ 69.7	436./ -69.6	78./ -45.1
5	954./ -59.6	607./ -73.7	78./ 73.4	562./ 17.2	123./ -44.9
6	736./ -21.9	374./ 13.2	142./ 48.5	394./ -10.2	81./ 27.4
7	47./ -4.0	104./ -35.5	77./ -20.3	209./ -88.5	28./ -63.8
8	141./ 3.8	145./ 12.0	82./ -8.8	24./ 42.4	9./ 75.4
9	137./ -55.2	157./ -27.4	33./ -69.2	176./ -12.2	6./ 35.9
10	96./ 48.3	100./ 77.5	20./ 46.3	133./ 35.4	13./ 65.2
11	43./ -9.4	238./ -86.0	80./ -87.5	77./ -2.9	12./ -1.6
12	96./ -75.7	178./ 75.3	81./ 62.9	66./ 53.2	20./ 53.0
PEAK-TO-PEAK	57./ -67.5	43./ -27.5	30./ -35.5	28./ -47.3	4./ -8.9
PEAK-TO-PEAK	10027.	3909.	1172.	12056.	1451.
	REAM .174 (N-M/DEG)	BEAM .350 (N-M/DEG)	BEAM .449 (N-M/DEG)	BEAM .606 (N-M/DFG)	REAM .803 (N-M/DEG)
MEAN HARMONIC-1	-436.	49.	-49.	-256.	-4.
2	754./ -67.0	508./ -77.0	525./ -77.2	457./ -81.3	199./ 71.1
3	580./ -84.9	341./ 69.1	351./ 66.5	296./ 68.0	126./ 88.3
4	372./ 20.1	72./ 70.4	64./ -29.1	174./ 14.9	216./ 23.1
5	540./ -38.9	159./ -59.1	79./ -74.3	97./ -45.0	220./ -61.8
6	202./ -80.4	7./ -49.3	48./ -66.2	27./ -89.9	94./ -51.1
7	97./ 18.5	13./ -80.9	34./ 22.3	26./ -13.7	76./ 3.4
8	75./ 61.3	6./ 51.7	24./ -75.6	23./ -28.6	68./ -31.3
9	80./ -33.5	4./ -58.4	27./ -14.5	30./ -16.2	69./ 3.6
10	85./ 20.9	36./ 50.5	28./ 36.9	26./ 71.5	13./ -41.7
11	50./ -41.9	28./ .6	14./ -84.7	37./ 16.3	34./ 34.5
12	19./ -8.2	10./ 49.6	12./ 89.2	11./ 34.4	6./ 51.7
PEAK-TO-PEAK	36./ 76.4	8./ 85.7	6./ 48.6	7./ 84.9	4./ 16.4
PEAK-TO-PEAK	3709.	1686.	1612.	1518.	1193.

FLIGHT NO, 063 AIRCRAFT TOTAL WT = 33377. N LOADED CG X= 5.03 M = 197.9 IN  
 RUN NO. 13 7504. LB Y= -.00 Z= -.0  
 TIME 54946.70 (SEC) Z= 1.86 M = 73.0

AERODYNAMIC FLIGHT STATE

DYNAMIC PRES= 2.74 KPA = 57.2 PSF  
 STATIC PRES= 79.1 KPA = 1651. PSF  
 TOTAL TEMP= 267.3 OEG K = 481.1 DEG P  
 STATIC TEMP= 264.7 DEG K = 476.4 DEG P  
 T. AIRSPEED= 140.3 KT  
 A/C MACH NO= .221  
 ROOY ALPHA= -4.5 DEG  
 BODY BETA= 1.3 OFG  
 DENSITY= 1.04 KG/M3 = .00202 SLUG/FT3  
 DENSITY ALT= 1667. M = 5469. FT  
 SONIC SPEED= 326.7 M/SEC = 1072. FPS  
 RATE OF CLIMB= -26. M/MIN = -84. FPM

INERTIAL FLIGHT STATE

AXIS	CG LIN VEL (M/S)	VEL (FPS)	OG LIN ACC (G)	HUB LIN VEL (M/S)	VEL (FPS)	HUB LIN ACC (G)	AXIS	ANG POS (DEG)	ANG RATES (RAD/SEC)	ANG ACC (RAD/SEC2)
X	71.95	236.1	-.093	71.95	236.1	-.093	ROLL	.0	.005	-.019
Y	1.67	5.5	.003	1.68	5.5	-.000	PITCH	-4.8	.001	.001
Z	-5.61	-18.4	-.976	-5.61	-18.4	-.976	YAW	179.3	-.006	-.010

CONTROL ANGLES

M.R. COLL= 12.4 DEG  
 A1= -.6 OEG  
 R1= 7.7 DEG  
 HORIZ FIN= 9.5 OEG  
 T.R. COLL= 2.8 DEG  
 PEDAL POS= 2.9 DEG

ROTOR PARAMETERS

HOVER TIP MACH= .70  
 TIP MAX-MACH= .92  
 TIP MIN-MACH= .48  
 .9R MAX-MACH= .85  
 .9R MIN-MACH= .41  
 SHAFT ALPHA= -4.5 OEG  
 CONTROL ALPHA= -12.2 DEG  
 DELTA PSI= -1.3 OEG  
 ENGINE POWER\*\* 598. KW \* 802. HP  
 THRUST FACTOR\* .766E+07 N = .172E+07 LB

NASA LANGLEY FLIGHT DATA AH-1G ---- ROTOR PERFORMANCE AND LOADS

FLIGHT NO. 63 MU= .315 TOTAL CQ= .000340 AMB TEMP= -8.5 C = 16.75 F  
 RUN NO. 13 V= 140.3 KT MAST CQ= .000328 TFMP U60= 11.7 C = 53.00 F  
 TIME 54946.55 NZ= .976 G OMEGA= 34.130 RAD/SEC CAM TEMP= -7.6 C = 27.28 F  
 CLP= .00423 RPM/324= 1.006

ROTOR ANGLES

THETA 314 (DEG) A0= 12.3 A1= -.1 B1= 8.5 PEAK-TO-PEAK= 17.1  
 TEETER ANG (DEG) A0= -.6 A1= -1.9 B1= -.6 PFAK-TO-PEAK\* 4.0

ROTOR LOADS (AMP/PHASE)

	DRAG BRACE (N/DEG)	CHORD .449 (N-M/DEG)	CHORD .803 (N-M/DEG)	PITCH LINK (N/DEG)	TORSION .449 (N-M/DEG)
MEAN	38386.	15755.	1953.	-3298.	-417.
HARMONIC-1	5090./ -70.6	1650./ -72.6	373./ 87.0	3466./ -47.5	491./ -52.6
2	496./ -85.8	199./ -3.7	117./ -48.5	3264./ -61.0	356./ -65.8
3	3757./ 26.7	1112./ 28.3	51./ -70.1	316./ -87.6	75./ -21.3
4	855./ -11.8	524./ -30.5	62./ -44.0	383./ 59.3	60./ -10.5
5	600./ 65.2	395./ 83.1	125./ 88.9	194./ 7.4	47./ 32.4
6	303./ 75.8	153./ -76.4	16./ -59.9	222./ -24.7	19./ -15.4
7	169./ -53.8	175./ -51.9	63./ -81.7	73./ -13.4	8./ -43.6
8	103./ 83.6	103./ -82.0	10./ 63.0	33./ -69.1	3./ -12.6
9	41./ -3.0	195./ -14.3	67./ -17.4	46./ -77.5	2./ 41.3
10	45./ -1.3	288./ 29.0	120./ 28.7	54./ 59.6	9./ 34.8
11	4./ 39.5	63./ -60.6	32./ -83.1	30./ -14.7	3./ 12.8
12	127./ -63.1	37./ 72.8	32./ 63.4	33./ -31.4	3./ 24.9
PEAK-TO-PEAK	18478.	6701.	1518.	11939.	1403.
	BEAM .174 (N-M/DEG)	BEAM .350 (N-M/DEG)	BEAM .449 (N-M/DEG)	BEAM .606 (N-M/DEG)	BEAM .803 (N-M/DEG)
MEAN	10.	156.	47.	-173.	-36.
HARMONIC-1	1319./ -72.2	542./ -71.4	529./ -70.2	481./ -77.9	231./ 84.9
-2	627./ -65.2	353./ 86.0	354./ 82.5	289./ 85.5	122./ -69.9
3	380./ 5.0	8./ -15.2	76./ 38.9	192./ 40.7	217./ 38.0
4	315./ 7.2	98./ -17.0	56./ -37.6	59./ 5.7	129./ -22.0
5	115./ -65.1	5./ -84.9	26./ -16.1	13./ -57.0	68./ -3.1
6	38./ -60.5	11./ 3.2	14./ -67.7	16./ 61.8	32./ 83.7
7	55./ -17.3	5./ -15.3	23./ 4.1	14./ 41.9	46./ 32.1
8	16./ 9.7	4./ -35.2	16./ 39.8	13./ 51.0	30./ 63.4
9	16./ -67.2	10./ -35.2	6./ -87.1	5./ -8.0	6./ 61.8
10	58./ 45.0	18./ 69.3	10./ 51.6	23./ 80.4	20./ 86.6
11	13./ -70.9	5./ -15.3	2./ 78.8	5./ -5.5	4./ 18.3
12	29./ 14.8	8./ 51.5	11./ 34.1	10./ 43.5	6./ 60.1
PEAK-TO-PEAK	4239.	1663.	1560.	1472.	1140.

FLIGHT NO. 063 AIRCRAFT TOTAL WT = 33344. N LOADED CG X = 5.03 M = 197.8 IN  
 RUN NO. 14 7496. LB Y = -0.00 = -0.0  
 TIME 55020.70 (SEC) Z = 1.86 = 73.1

AERODYNAMIC FLIGHT STATE

DYNAMIC PRES = 3.21 KPA = 67.0 PSF  
 STATIC PRES = 79.1 KPA = 1653. PSF  
 TOTAL TEMP = 267.4 DEG K = 481.4 DFG P  
 STATIC TEMP = 264.4 DEG K = 475.9 DFG R  
 T. AIRSPEED = 151.6 KT  
 A/C MACH NO = .239  
 BODY ALPHA = -5.8 DEG  
 BODY BETA = .7 DEG  
 DENSITY\* 1.04 KG/M3 = .00202 SLUG/FT3  
 DENSITY ALT = 1645. M = 5399. FT  
 SONIC SPEED\* 326.5 M/SEC = 1071. FPS  
 RATE OF CLIMB = -48. M/MIN = -156. FPM

INERTIAL FLIGHT STATE

AXIS	CG LIN VEL (M/S)	VEL (FPS)	CG LIN ACC (G)	HUB LIN VEL (M/S)	VEL (FPS)	HUB LIN ACC (G)	AXIS	ANG POS (DEG)	ANG RATES (RAD/SFC)	ANG ACC (RAD/SEC2)
X	77.57	254.5	-.106	77.56	254.5	-.107	ROLL	-.4	-.005	-.009
Y	.97	3.2	.015	.96	3.1	.013	PITCH	-6.4	.003	.003
Z	-7.85	-25.8	-.992	-7.85	-25.8	-.992	YAW	172.8	.000	.022

CONTROL ANGLES

M.R. COLL = 14.2 DEG  
 A1 = -.9 DEG  
 B1 = 8.6 DEG  
 HORIZ FIN = 10.2 DEG  
 T.R. COLL = 3.1 DEG  
 PEDAL POS = 3.3 DFG

ROTOR PARAMETERS

HOVER TIP MACH = .70  
 TIP MAX-MACH = .94  
 TIP MIN-MACH = .46  
 .9R MAX-MACH = .87  
 .9R MIN-MACH = .39  
 SHAFT ALPHA = -5.8 DFG  
 CONTROL ALPHA = -14.4 DFG  
 DELTA PSI = -.7 DFG  
 ENGINE POWER = 734. KW = 984. HP  
 THRUST FACTOR = .766E+07 N = .172E+07 LB

NASA LANGLEY FLIGHT DATA AH-1G ---- ROTOR PERFORMANCE AND LOADS

FLIGHT NO. #3 MU = .341 TOTAL CQ = .000418 AMB TEMP = -8.8 C = 16.24 F  
 RUN NO. 14 V = 151.6 KT MAST CQ = .000406 TEMP U60 = 12.3 C = 54.15 F  
 TIME 55020.60 NZ = .992 G DMEGA = 34.091 RAD/SEC CAN TEMP = -2.6 C = 27.28 F  
 CLP = .00430 RPM/324 = 1.005

ROTOR ANGLES THETA 314 (DEG) AO = 14.0 A1 = -.5 B1 = 10.0 PEAK-TO-PEAK- 19.9  
 TEETER ANG (DEG) AO = -.7 A1 = -2.1 B1 = -.9 PEAK-TO-PEAK = 4.5

ROTOR LOADS (AMP/PHASE) DRAG BRACE (N/DEG) CHORD .449 (N-M/DEG) CHORD .803 (N-M/DEG) PITCH LINK (N/DEG) TORSION .449 (N-M/DEG)

	35496.	16362.	1739.	-3964.	-510.
MEAN HARMONIC-1	7041./ -66.4	2290./ -66.7	479./ -83.3	4229./ -48.0	565./ -51.6
2	1655./ 50.9	633./ 11.3	181./ -27.9	3866./ -58.2	441./ -67.2
3	5403./ 34.4	1612./ 36.6	73./ -82.3	464./ 66.3	85./ -18.2
4	893./ -18.5	644./ -33.6	127./ -46.7	457./ 55.4	66./ -13.3
5	613./ 61.6	376./ 84.5	109./ -75.6	73./ -12.3	21./ 75.1
6	105./ 46.1	15./ 54.7	21./ -61.9	266./ -6.1	26./ -14.6
7	338./ -8.1	208./ -6.0	82./ -6.2	11./ 23.6	20./ -19.7
8	109./ -70.3	45./ 69.0	34./ 69.0	13./ -36.4	2./ 26.2
9	60./ -56.0	109./ 16.1	40./ 51.8	46./ -57.6	4./ -29.5
10	12./ 3.5	135./ 9.6	52./ -13.6	92./ 65.2	14./ 64.6
11	115./ -31.6	85./ -37.5	40./ -46.9	29./ -8.2	2./ 86.8
12	19./ -57.8	62./ 12.0	16./ -69.3	22./ -16.7	3./ 11.1
PEAK-TO-PEAK	24813.	7947.	1640.	14178.	1721.

	SEAM .174 (N-M/DEG)	BEAM .350 (N-M/DEG)	BEAM .449 (N-M/DEG)	BEAM .606 (N-M/DEG)	BEAM .803 (N-M/DEG)
MEAN HARMONIC-1	265.	185.	63.	-160.	-40.
2	1832./ -69.6	634./ -69.7	593./ -68.5	538./ -71.6	272./ 84.3
3	720./ -52.1	388./ 88.3	392./ 82.7	308./ 84.7	111./ -62.1
4	614./ 6.2	31./ -40.6	106./ 41.8	252./ 35.9	289./ 30.2
5	341./ 14.0	100./ -12.5	54./ -39.5	65./ 13.6	122./ -17.9
6	120./ -55.6	4./ -7.0	24./ -20.4	18./ -21.3	53./ -13.8
7	66./ -62.9	13./ -6.3	24./ -59.5	18./ 68.5	35./ -73.1
8	82./ -37.2	8./ -35.4	29./ -16.3	14./ 10.4	49./ 7.3
9	25./ -6.6	4./ -64.3	15./ 43.0	10./ 36.8	25./ 57.0
10	17./ -76.3	12./ -42.5	8./ -68.7	11./ -8	10./ 31.3
11	50./ 37.4	21./ 46.9	13./ 29.1	24./ 63.0	20./ 76.2
12	14./ -76.6	5./ -25.5	4./ 36.6	4./ -25.7	4./ -2.1
PEAK-TO-PEAK	5884.	1876.	1751.	1678.	1321.

FLIGHT NO. 063 AIRCRAFT TOTAL WT = 32935. N LOADED CG X= 5.02 M = 197.8 IN  
 RUN NO. 17 7404. LB Y= -0.00 Z= -0.0  
 TIME 55689.90 (SEC) Z= 1.86 \* 73.3

AERODYNAMIC FLIGHT STATE

OYNAMIC PRES= 1.82 KPA = 38.0 PSF  
 STATIC PRES= 85.8 KPA = 1792. PSF  
 TOTAL TEMP= 265.5 DEG K = 477.9 DEG R  
 STATIC TEMP= 263.9 DEG K = 475.0 DEG R  
 T. AIRSPEED= 109.9 KT  
 A/C MAC4 ND= .173  
 BODY ALPHA= -.8 DEG DENSITY\* 1.13 KG/M3 = .00220 SLUG/FT3  
 BODY BETA= 1.4 DEG DENSITY ALT= 808. M = 2649. FT  
 SONIC SPEED= 326.2 M/SEC = 1070. FPS  
 RATE OF CLIMB= -117. M/MIN = -383. FPM

INEQTIAL FLIGHT STATE

AXIS	CG LIN VEL (M/S)	CG LIN VEL (FPS)	CG LIN ACC (G)	HUB LIN VEL (M/S)	HUB LIN VEL (FPS)	HUB LIN ACC (G)	AXIS	ANG POS (DEG)	ANG RATFS (RAD/SEC)	ANG ACC (RAD/SEC2)
X	56.49	185.3	-.088	56.25	184.6	-.081	ROLL	-2.7	.007	.084
Y	1.38	4.5	.003	1.39	4.6	.020	PITCH	-2.9	.120	-.032
Z	-.83	-2.7	-1.279	-.83	-2.7	-1.276	YAW	191.1	.010	.101

CONTROL ANGLES M.P. COLL= 9.0 DEG HORIZ FIN\* 7.5 DEG  
 A1= -.3 DEG T.R. COLL= .2 DEG  
 B1= 4.2 DEG PEDAL POS= .4 DEG

ROTOR PARAMETERS

SHAFT ALPHA= -.8 DEG  
 CONTROL ALPHA= -5.1 DEG  
 HOVER TIP MACH\* .70  
 DELTA PSI= -1.4 DEG  
 TIP MAX-MACH= .87  
 TIP MIN-MACH\* .53  
 .9R MAX-MACH= .80  
 .9R MIN-MACH= .46  
 ENGINE POWER= 398. KW = 533. HP  
 THRUST FACTOR\* .836E+07 N = .188E+07 LB

NASA LANGLEY FLIGHT DATA AH-1G ---- ROTOR PERFORMANCE AND LOADS

FLIGHT NO. 63 MU= .246 TOTAL CQ= .000206 AMB TEMP= -9.3 C = 15.33 F  
 BUN NO. 17 V= 109.9 KT MAST CQ= .000191 TFMP U60= 10.1 C = 50.23 F  
 TIME 55689.82 NZ= 1.276 G OMEGA= 34.265 RAD/SEC CAN TEMP= -3.4 C = 25.88 F  
 CLP\* .00498 RPM/324= 1.010

ROTOR ANGLES THETA 314 (DEG) A0= 9.1 A1= -9 B1= 4.5 PFAK-TO-PEAK- 9.3  
 TEETER ANG (DEG) A0= -.7 A1= -9 B1= .6 PFAK-TO-PEAK= 2.2

ROTOR LOADS (AMP/PHASE) DRAG BRACE (N/DEG) CHORD .449 (N-M/DEG) CHORD .803 (N-M/DEG) PITCH LINK (N/DEG) TORSION .449 (N-M/DEG)

	MEAN	3899.1	-6.0	1049.1	-14.6	248.1	-56.3	1893.1	-36.9	323.1	-54.8
HARMONIC-1	3899.1	-6.0	1049.1	-14.6	248.1	-56.3	1893.1	-36.9	323.1	-54.8	
2	660.1	-27.2	275.1	-49.2	21.1	-1.3	1720.1	-37.3	178.1	-25.2	
3	2018.1	36.4	603.1	36.1	38.1	14.5	228.1	-6.7	60.1	29.7	
4	444.1	33.5	188.1	26.3	21.1	-48.7	363.1	-84.2	66.1	51.9	
5	259.1	-37.1	49.1	-2.7	24.1	53.9	88.1	-15.1	23.1	-64.0	
6	1126.1	-38.3	815.1	-43.8	161.1	-45.4	65.1	60.7	31.1	45.3	
7	151.1	-80.1	78.1	75.7	58.1	-72.1	36.1	.2	8.1	46.7	
8	41.1	-66.2	35.1	-21.9	12.1	-35.9	40.1	-46.2	9.1	82.7	
9	150.1	51.5	106.1	-83.9	59.1	-84.6	88.1	76.2	5.1	-24.0	
10	52.1	-31.4	74.1	-28.2	40.1	-41.8	62.1	-26.6	8.1	22.1	
11	103.1	-24.9	54.1	19.2	22.1	-12.2	10.1	-86.9	9.1	-2.0	
12	136.1	-52.0	50.1	-39.8	26.1	-72.9	29.1	23.6	5.1	-14.1	
PEAK-TO-PEAK	11606.		4397.		996.		6508.		925.		

	XEAM .174 (N-M/DEG)	BEAU .350 (N-M/DEG)	BEAM .449 (N-M/DEG)	REAM .606 (N-M/DEG)	REAM .803 (N-M/DEG)					
MEAN	97.	129.	-31.	-277.	80.					
HARMONIC-1	524.1	-46.4	379.1	-67.7	404.1	-69.2	404.1	-71.5	228.1	-86.9
2	327.1	-48.8	245.1	-72.5	286.1	-71.5	249.1	-73.1	105.1	-84.8
3	69.1	-82.7	52.1	-5.5	50.1	37.1	68.1	74.4	88.1	75.4
4	323.1	53.8	99.1	41.2	59.1	29.3	81.1	56.0	144.1	39.0
5	108.1	-40.8	16.1	-58.7	25.1	50.9	21.1	-33.7	58.1	75.5
6	69.1	-72.2	9.1	53.6	7.1	46.8	10.1	-14.2	53.1	-67.9
7	39.1	31.4	8.1	50.1	25.1	65.3	16.1	-51.0	61.1	-71.7
8	38.1	28.8	12.1	88.8	11.1	1.8	15.1	-45.8	30.1	-26.3
9	57.1	62.3	37.1	72.2	16.1	58.3	36.1	88.1	30.1	-71.5
10	43.1	-58.9	17.1	-36.6	12.1	-45.4	21.1	-11.4	22.1	-6.4
11	2.1	-68.5	8.1	-25.6	5.1	-18.6	1.1	81.8	5.1	-33.9
12	43.1	-52.6	15.1	-45.3	14.1	-74.1	11.1	-64.3	4.1	-19.0
PEAK-TO-PEAK	1929.		1187.		1281.		1274.		886.	

NASA LANGLEY FLIGHT DATA AH-1G ---- PADS PCM DATA

FLIGHT NO. 063 AIRCRAFT TOTAL WT = 32662. N LOADED CG X = 5.02 M = 197.7 IN  
 RUN NO. 24 7343. LB Y = -0.00 = -0.0  
 TIME 56055.20 (SEC) Z = 1.87 = 73.5

AERODYNAMIC FLIGHT STATE

T. AIRSPEED- 109.1 KT DYNAMIC PRES = 1.76 KPA = 36.6 PSF  
 A/C MACH NO\* .172 STATIC PRES = 84.6 KPA = 1767. PSF  
 TOTAL TEMP- 266.2 OEG K = 479.2 DEG R  
 STATIC TEMP- 264.6 OEG K = 476.3 OFG R  
 BODY ALPHA = -3.0 OEG DENSITY = 1.11 KG/M3 = .00216 SLUG/FT3  
 BODY BETA = 2.1 OEG DENSITY ALT = 983. M = 3224. FT  
 SONIC SPEED\* 326.7 M/SEC = 1072. FPS  
 RATE OF CLIMB\* 1. M/MIN = 2. FPM

INERTIAL FLIGHT STATE

AXIS	CG LIN VEL (M/S)	VEL (FPS)	CG LIN ACC (G)	HUB LIN VEL (M/S)	VEL (FPS)	HUB LIN ACC (G)	AXIS	ANG POS (DEG)	ANG RATES (RAD/SEC)	ANG ACC (RAD/SEC2)
X	56.00	183.7	-0.065	56.01	183.8	-0.063	ROLL	-0.4	-0.001	.017
Y	2.05	6.7	-0.002	2.05	6.7	.002	PITCH	-3.0	-0.006	-0.007
Z	-2.96	-9.7	-0.961	-2.96	-9.7	-0.962	YAW	346.9	.003	-0.011

CONTROL ANGLES

M.R. COLL = 9.0 DEG HORIZ FIN = 7.9 OEG  
 A1 = -0.5 DEG T.R. COLL = 1.2 OEG  
 B1 = 5.4 DEG PEDAL POS = 1.3 DEG

ROTOR PARAMETERS

HOVER TIP MACH = .70 SHAFT ALPHA = -3.0 DEG  
 CONTROL ALPHA = -8.4 OEG  
 TIP MAX-MACH = .87 DELTA PSI = -2.1 OEG  
 TIP MIN-MACH = .52  
 .9R MAX-MACH = .80 ENGINE POWER = 405. KW = 543. HP  
 .9R MIN-MACH = .45 THRUST FACTOR = .812E+07 N = .183E+07 LB

NASA LANGLEY FLIGHT DATA AH-1G ---- ROTOR PERFORMANCE AND LOADS

FLIGHT NO. 63 MU = .246 TOTAL CQ = .000218 AMB TFMP = -8.5 C = 16.67 F  
 RUN NO. 24 V = 109.1 KT MAST CQ = .000207 TEMP U60 = 10.6 C = 51.00 F  
 TIME 56055.13 NZ = .962 G OMEGA = 33.958 RAD/SEC CAN TEMP = -3.0 C = 26.58 F  
 CLP = .00385 RPM/324 = 1.001

ROTOR ANGLES

THETA 3/4 (DEG) A0 = 9.2 A1 = -1.1 B1 = 5.4 PEAK-TO-PEAK- 10.9  
 TEETER ANG (DEG) A0 = -0.7 A1 = -1.4 B1 = .1 PFAK-TO-PEAK-

ROTOR LOADS (AMP/PHASE)

	DRAG BRACE (N/DEG)	CHORO .449 (N-M/DEG)	CHORO .803 (N-M/DEG)	PITCH LINK (N/DEG)	TORSION .449 (N-M/DEG)
MEAN	41657.	14949.	2091.	-2000.	-267.
HARMONIC-1	3254./ -40.4	946./ -48.8	247./ -67.2	2277./ -37.0	361./ -53.4
2	360./ -52.9	57./ -69.2	40./ -50.7	1999./ -62.0	208./ -57.6
3	1651./ 29.8	487./ 31.1	27./ 17.5	384./ -49.5	67./ -7.5
4	531./ 6.7	238./ -2.4	18./ -37.9	364./ 63.7	53./ 35.0
5	154./ 44.3	100./ -89.0	43./ -59.2	249./ .8	40./ 10.2
6	350./ 67.7	250./ 73.1	39./ 50.2	123./ -53.5	8./ -32.0
7	343./ 26.7	223./ 34.9	52./ 16.0	105./ -0.3	9./ -11.1
8	89./ -16.9	59./ -59.7	27./ -63.7	78./ -77.2	8./ 80.3
9	70./ 5.1	84./ -15.7	24./ 4.4	36./ -4.2	4./ -31.3
10	45./ 14.1	197./ 30.3	76./ 35.2	49./ 18.2	4./ 17.7
11	17./ -18.9	37./ 56.7	14./ 50.7	33./ -86.0	10./ -44.9
12	27./ -78.1	38./ 89.4	23./ 54.9	13./ -35.7	5./ -54.4
PEAK-TO-PEAK	10555.	3737.	939.	7957.	1012.

	BEAM .174 (N-M/DEG)	BEAM .350 (N-M/DEG)	BEAM .449 (N-M/DEG)	BEAM .606 (N-M/DEG)	BEAM .803 (N-M/DEG)
MEAN	-260.	110.	-9.	-224.	-14.
HARMONIC-1	695./ -61.0	378./ -70.3	390./ -71.4	361./ -74.3	160./ 88.9
2	369./ -72.5	235./ -88.2	252./ -86.3	205./ -87.9	64./ -68.3
3	94./ 36.9	26./ -11.4	37./ 48.0	73./ 68.3	83./ 57.4
4	271./ 26.4	80./ 16.0	45./ 7.5	55./ 33.0	105./ 15.4
5	78./ -21.0	4./ -62.3	25./ 22.6	7./ 42.7	52./ 8.2
6	37./ -69.5	2./ -46.9	16./ -82.2	13./ -66.0	39./ -79.3
7	49./ 24.1	7./ 13.6	27./ 39.1	13./ -82.9	41./ 76.5
8	25./ 66.8	2./ -24.2	11./ 62.0	10./ -48.7	24./ -56.2
9	17./ -47.1	8./ 8.7	3./ -88.9	7./ 58.8	7./ -72.5
10	41./ -57.4	16./ -38.3	11./ -50.4	19./ -34.6	17./ -27.0
11	11./ 85.8	13./ 84.8	3./ -29.4	7./ 86.1	4./ -63.2
12	32./ 58.4	8./ -86.9	11./ 52.4	8./ 86.7	5./ -82.0
PEAK-TO-PEAK	2430.	1118.	1159.	1069.	688.

NASA LANGLEY FLIGHT DATA AH-1G ---- PADS PCM DATA

FLIGHT NO. 063 AIRCRAFT TOTAL WT = 32672. N LOAOEO CG X = 5.02 M = 197.7 IN  
 RUN NO. 27 7345. LB Y = -.00 M = -.0  
 TIME 56119.47 (SEC) Z = 1.87 M = 73.5

AERODYNAMIC FLIGHT STATF DYNAMIC PRES = 1.84 KPA = 38.4 PSF  
 STATIC PRES = 84.4 KPA = 1763. PSF  
 T. AIRSPEED = 111.6 KT TOTAL TEMP = 266.8 DEG K = 480.2 OFG R  
 A/C MACH NO = .176 STATIC TEMP = 265.2 DEG K = 477.3 OFG R  
 BODY ALPHA = -.4 OEG DENSITY = 1.11 KG/M3 = .00215 SLUG/FT3  
 BODY BETA = 2.3 OFG DENSITY ALT = 1025. M = 3362. FT  
 SONIC SPEED = 327.0 M/SEC = 1073. FPS  
 RATE OF CLIMB = -118. M/MIN = -387. FPM

INFRTIAL FLIGHT STATE

AXIS	CG LIN VEL (M/S)	CG LIN VEL (FPS)	CG LIN ACC (G)	HUB LIN VEL (M/S)	HUB LIN VEL (FPS)	HUB LIN ACC (G)	AXIS	ANG POS (DEG)	ANG RATES (RAD/SEC)	ANG ACC (RAD/SEC2)
X	57.36	188.2	-.082	57.17	187.6	-.080	ROLL	-.8	.005	-.003
Y	2.34	7.7	-.015	2.35	7.7	-.015	PITCH	-2.4	.094	-.010
Z	-.44	-1.4	-1.249	-.43	-1.4	-1.247	YAW	328.6	-.009	.068

CONTROL ANGLES M.R. COLL = 9.0 OEG HORIZ FIN = 7.6 OEG  
 A1 = -.3 DEG T.R. COLL = .9 OEG  
 B1 = 4.6 OEG PEDAL POS = 1.1 OEG

ROTOR PARAWETERS

HOVER TIP MACH = .70 SHAFT ALPHA = -.4 OEG  
 CONTROL ALPHA = -5.0 OEG  
 TIP MAX-MACH = .88 DELTA PSI = -2.4 OEG  
 TIP MIN-MACH = .52  
 .9R MAX-MACH = .81 ENGINE POWER = 383. KW = 514. HP  
 .9R MIN-MACH = .45 THRUST FACTOR = .821E+07 N = .185E+07 LB

NASA LANGLEY FLIGHT DATA AH-1G ---- ROTOR PERFORMANCE AND LOADS

FLIGHT NO. 63 MU = .250 TOTAL CQ = .000202 AMB TEMP = -R.0 C = 17.61 F  
 RUN NO. 27 V = 111.6 KT MAST CQ = .000189 TEMP U60 = 10.6 C = 50.99 F  
 TIME 56119.33 NZ = 1.247 G OMEGA = 34.277 RAD/SEC CAN TEMP = -3.0 C = 26.58 F  
 CLP = .00493 RPM/324 = 1.010

ROTOR ANGLES THETA 314 (DEG) A0 = 9.0 A1 = .0 B1 = 4.6 PEAK-TO-PEAK = 9.5  
 TEETER ANG (DEG) A0 = -.7 A1 = -.8 B1 = .5 PEAK-TO-PEAK = 1.8

ROTOR LOADS (AMP/PHASE)	DRAG BRACE (N/DEG)	CHORD .449 (N-M/DEG)	CHORO .803 (N-M/DEG)	PITCH LINK (N/DFG)	TORSION .449 (N-M/DEG)
MEAN	43553.	14904.	2174.	-1806.	-263.
HARMONIC-1	3236./ -18.0	874./ -27.8	254./ -63.3	1929./ -40.8	337./ -57.0
2	679./ -13.5	229./ -34.1	34./ -72.3	1848./ -47.1	182./ -35.7
3	1761./ 28.3	499./ 30.0	13./ 12.8	183./ -30.0	56./ 8.1
4	667./ 28.5	238./ 11.7	30./ -26.2	379./ 88.1	62./ 37.6
5	342./ -30.2	34./ 5.1	16./ 38.8	105./ -5.8	24./ -83.8
6	926./ -59.9	660./ -60.0	129./ -60.5	29./ -48.2	17./ 55.7
7	72./ 47.6	88./ -42.2	30./ 65.1	68./ 24.4	8./ 47.1
8	34./ -32.7	52./ -6.5	26./ 52.1	49./ -71.9	10./ 78.2
9	92./ 65.4	106./ 54.5	65./ 55.7	71./ 57.5	4./ 23.8
10	59./ 78.1	38./ 78.6	36./ 83.9	43./ -57.1	13./ 12.1
11	51./ -72.4	70./ 9.7	31./ 3.0	18./ -38.5	10./ -20.6
12	141./ -68.4	73./ -69.5	47./ 89.8	35./ 19.0	2./ -61.7
PEAK-TO-PEAK	9499.	3657.	939.	6866.	954.

	REAM .174 (N-M/DEG)	BEAM .350 (N-M/DEG)	BEAM .449 (N-M/DEG)	BEAM .606 (N-M/DEG)	REAM .803 (N-M/DEG)
MEAN	3.	115.	-39.	-285.	67.
HARMONIC-1	535./ -55.4	387./ -70.8	409./ -72.2	394./ -74.7	217./ -87.8
2	355./ -60.2	248./ -80.0	288./ -78.3	254./ -78.8	105./ -88.5
3	66./ 74.5	47./ -15.0	50./ 35.2	85./ 65.3	99./ 63.6
4	285./ 47.7	89./ 33.7	54./ 20.8	69./ 48.0	128./ 30.2
5	87./ -49.6	13./ -79.6	33./ 39.7	15./ -41.4	63./ 51.2
6	61./ 88.4	6./ 57.2	7./ 37.0	7./ -44.3	49./ -78.8
7	65./ 32.9	13./ 45.3	39./ 50.6	22./ -73.7	73./ -89.7
8	19./ 13.9	10./ -88.8	5./ -48.1	16./ -68.8	32./ -59.5
9	50./ 54.0	31./ 56.4	13./ 51.2	34./ 70.6	29./ 80.3
10	56./ 74.7	15./ -88.2	15./ 78.6	18./ -66.7	17./ -52.4
11	11./ 56.2	3./ -38.0	2./ 48.9	4./ 8.1	4./ -62.3
12	25./ -81.0	9./ -63.7	7./ 67.4	6./ -82.4	2./ -8.4
PEAK-TO-PEAK	1930.	1187.	1285.	1223.	866.

FLIGHT NO. 065 AIRCRAFT TOTAL WT = 34814. N LOADED CG X= 5.02 M = 197.7 IN  
 RUN NO. 1 7827. LB Y= -.00 = -.0  
 TIME 52878.50 (SEC) Z= 1.83 = 72.2

AERODYNAMIC FLIGHT STATE

T. AIRSPEED= 0.0 KT  
 A/C MACH NO= 0.000

BODY ALPHA= 19.5 DEG  
 BODY BETA= -9.7 DEG

DYNAMIC PRES= 0.00 KPA = 0.0 PSF  
 STATIC PRES= 102.7 KPA = 2146. PSF  
 TOTAL TEMP= 274.9 DEG K = 494.8 DEG R  
 STATIC TEMP= 274.9 DEG K = 494.8 DEG R  
 DENSITY= 1.30 KG/M3 = .00253 SLUG/FT3  
 DENSITY ALT= -641. M = -2102. FT  
 SONIC SPEED= 332.9 M/SEC = 1092. FPS  
 RATE OF CLIMB= 0. M/MIN = 0. FPM

INERTIAL FLIGHT STATE

AXIS	CG LIN VEL (M/S)	CG LIN VEL (FPS)	CG LIN ACC (G)	HUB LIN VEL (M/S)	HUB LIN VEL (FPS)	HUB LIN ACC (G)	AXIS	ANG POS (DEG)	ANG RATES (RAD/SEC)	ANG ACC (RAD/SEC 2)
X	0.00	0.0	-.009	0.00	0.0	-.010	ROLL	-2.5	-.014	-.013
Y	0.00	0.0	.050	0.00	0.0	.048	PITCH	-1.0	.019	.004
Z	0.00	0.0	-1.001	0.00	0.0	-1.001	YAW	276.4	.016	-.049

CONTROL ANGLES

M.R. COLL= 10.2 DEG HORIZ FIN= 6.0 DEG  
 A1= -2.9 DEG T.R. COLL= 7.2 DEG  
 B1= -1.5 DEG PEDAL POS= 7.3 DEG

ROTOR PARAMETERS

HOVER TIP MACH= .68 SHAFT ALPHA= 0.0 DEG HUE HEIGHT= 1.9 R  
 CONTROL ALPHA= 1.5 DEG  
 TIP NAX-MACH= .68 DELTA PSI= 0.0 DEG  
 TIP MIN-MACH= .58  
 .9R MAX-MACH= .62 THRUST FACTOR= .951E+07 N = .214E+07 LB  
 .9R MIN-MACH= .62

NASA LANGLEY FLIGHT DATA AH-1G ---- ROTOR PERFORMANCE AND LOADS

FLIGHT NO. 65 MU=0.000 TOTAL CQ= .000274 AMB TEMP= 1.7 C = 35.14 F  
 RUN NO. 1 V= 0.0 KT MAST CQ= .000267 TEMP U60= 17.4 C = 63.28 F  
 TIME 52878.38 NZ= 1.001 G OMEGA\* 34.058 RAD/SEC CAN TEMP= 25.7 C = 78.31 F  
 CLP= .00366 RPM/324= 1.004

ROTOR ANGLES

THETA 3/4 (DEG) A0= 8.5 A1= -2.0 B1= -.9 PEAK-TO-PEAK\* 4.5  
 TEETER ANG (DEG) A0= -.2 A1= .7 B1= -1.4 PEAK-TO-PEAK= 3.1

ROTOR LOADS (AMP/PHASE)

	DRAG BRACE (N/DEG)	CHORD .449 (N-M/DEG)	CHORD .803 (N-M/DEG)	PITCH LINK (N/DEG)	TORSION .449 (N-M/DEG)
MEAN HARMONIC-1	39039.	11222.	1162.	-2064.	-238.
2	1527./ 21.0	589./ 19.7	71./ 7.9	1075./ -52.8	35./ 61.0
3	808./ 88.2	269./ -84.1	71./ -82.4	368./ 33.8	45./ 67.6
4	460./ -30.9	106./ -44.7	14./ 75.0	153./ -83.8	43./ -30.5
5	324./ 86.3	214./ 77.5	44./ 25.6	115./ 37.0	26./ 85.7
6	499./ 54.8	286./ 38.1	90./ 15.6	196./ 78.3	39./ -46.2
7	745./ 31.5	474./ 24.5	127./ 13.6	135./ 82.2	18./ -90.0
8	141./ -29.4	211./ -71.2	62./ -64.6	105./ 66.3	6./ 79.1
9	187./ -63.9	67./ -47.0	9./ 11.3	8./ 23.2	6./ -49.8
10	74./ 1.8	160./ 87.5	74./ 85.8	25./ 61.4	6./ -54.3
11	54./ -63.5	89./ 59.8	40./ 41.1	92./ 33.7	13./ 66.4
12	127./ 88.5	82./ -72.3	12./ -74.7	15./ 18.1	10./ -88.3
PEAK-TO-PEAK	86./ 80.5	21./ 48.6	20./ 76.8	16./ -75.2	5./ 41.4
	5969.	2826.	672.	2840.	266.

BEAM .174 (N-M/DEG) BEAM .350 (N-M/DEG) BEAM .449 (N-M/DEG) BEAM .606 (N-M/DEG) BEAM .803 (N-M/DEG)

	BEAM .174 (N-M/DEG)	BEAM .350 (N-M/DEG)	BEAM .449 (N-M/DEG)	BEAM .606 (N-M/DEG)	BEAM .803 (N-M/DEG)
MEAN HARMONIC-1	66.	300.	166.	-17.	-199.
2	144./ 36.1	27./ -71.6	50./ 73.7	111./ 62.2	153./ 49.7
3	124./ 27.4	76./ 33.5	91./ 35.5	93./ 41.8	46./ 52.4
4	21./ 45.1	25./ 16.3	25./ 30.7	23./ 11.0	48./ 12.1
5	199./ 63.3	59./ 53.2	26./ 35.1	37./ -86.2	83./ -83.1
6	161./ 22.9	13./ 31.9	21./ 19.7	49./ 17.2	48./ -12.5
7	52./ 79.9	8./ -71.4	15./ 85.6	7./ 48.5	31./ 2.8
8	80./ 63.7	13./ 88.5	31./ 68.3	7./ 7.5	21./ 38.5
9	38./ 16.7	6./ 63.3	16./ 6.3	12./ -64.4	28./ -47.3
10	12./ -12.2	6./ 30.1	12./ -22.5	15./ 59.5	21./ 84.5
11	51./ -11.6	20./ 17.1	7./ -51.7	20./ 15.1	14./ 24.7
12	11./ -40.9	3./ -55.8	10./ -17.7	4./ 57.2	9./ 67.2
PEAK-TO-PEAK	11./ 19.7	2./ 20.8	10./ 17.3	9./ 13.0	9./ 24.1
	946.	319.	379.	479.	611.



NASA LANGLEY FLIGHT DATA AH-1G ---- PADS PCM OATA

FLIGHT NO. 065 AIRCRAFT TOTAL WT = 34481. N LOADED CG X = 5.02 M = 197.7 IN  
 RUN NO. 2 7752. LB Y = -0.00 = -0.0  
 TIME 53611.90 (SEC) Z = 1.84 = 72.4

AEROYDYNAMIC FLIGHT STATE

T. AIRSPEED = 106.9 KT  
 A/C MACH NO = .106

DYNAMIC PRES = 1.89 KPA = 39.4 PSF  
 STATIC PRES = 97.5 KPA = 2037. PSF  
 TOTAL TEMP = 275.0 OEG K = 494.9 DEG R  
 STATIC TEMP = 273.5 OEG K = 492.2 OEG R

BODY ALPHA = -2.3 DEG  
 BODY BETA = 1.3 OEG

DENSITY = 1.24 KG/M3 = .00241 SLUG/FT3  
 DENSITY ALT = -151. M = -494. FT  
 SONIC SPEED = 332.1 M/SEC = 1089. FPS  
 RATE OF CLIMB = -43. M/MIN = -142. FPM

INERTIAL FLIGHT STATE

AXIS	CG LIN (M/S)	VEL (FPS)	CG LIN ACC (G)	HUB LIN VEL (M/S)	VEL (FPS)	HUB LIN ACC (G)	AXIS	ANG POS (DEG)	ANG RATES (RAD/SEC)	ANG ACC (RAD/SEC2)
X	54.91	180.2	-.067	54.91	180.2	-.066	ROLL	-.7	-.004	-.021
Y	1.25	4.1	.001	1.24	4.1	-.003	PITCH	-3.1	-.001	-.005
Z	-2.24	-7.4	-.990	-2.24	-7.4	-.990	YAW	268.0	-.000	-.004

CONTROL ANGLES

M.R. COLL = 9.0 DEG HORIZ FIN = 7.6 OEG  
 A1 = -.4 DEG T.R. COLL = .7 OEG  
 B1 = 4.5 DEG PEDAL POS = .9 DEG

ROTOR PARAMETERS

HOVER TIP MACH = .69 SHAFT ALPHA = -2.3 DEG  
 CONTROL ALPHA = -6.8 OEG  
 TIP MAX-MACH = .85 DELTA PSI = -1.3 DEG  
 TAP MIN-MACH = .52  
 .9R MAX-MACH = .78 ENGINE POWER = 413. KW = 554. HP  
 .9R MIN-MACH = .45 THRUST FACTOR = .912E+07 N = .205E+07 LB

NASA LANGLEY FLIGHT DATA AH-1G ---- ROTOR PERFORMANCE AND LOADS

FLIGHT NO. 65 MU = .240 TOTAL CQ = .000197 AMB TEMP = .3 C = 32.56 F  
 RUN NO. 2 V = 106.9 KT MAST CQ = .000210 TEMP U60 = 19.0 C = 66.28 F  
 TIME 53611.75 NZ = .990 G OMEGA = 34.151 RAD/SEC CAN TEMP = 9.0 C = 48.25 F  
 CLP = .00371 RPM/324 = 1.007

ROTOR ANGLES

THETA 314 (DEG) A0 = 8.4 A1 = -.2 B1 = 4.8 PEAK-TO-PEAK = 10.0  
 TEETER ANG (DEG) A0 = -.5 A1 = -1.4 B1 = .1 PEAK-TO-PEAK = 2.7

ROTOR LOADS (AMP/PHASE)

	DRAG BRACE (N/DEG)	CHORD .449 (N-M/DEG)	CHORD .803 (N-M/DEG)	PITCH LINK (N/DEG)	TORSION .449 (N-M/DEG)
MEAN	41725.	11516.	1391.	-1963.	-279.
HARMONIC-1	3168./ -31.9	942./ -38.9	267./ -57.9	2332./ -38.5	374./ -54.6
2	360./ -1.6	52./ 17.0	40./ -43.9	1949./ -49.2	200./ -42.9
3	1771./ 29.6	511./ 27.3	48./ -1.6	396./ -29.8	72./ 7.5
4	663./ 28.7	383./ 24.2	41./ 3.4	432./ 75.5	76./ 42.9
5	40./ -45.9	47./ -48.7	31./ -29.5	184./ 13.6	37./ 38.6
6	984./ -70.2	719./ -71.2	151./ -82.1	116./ -20.9	4./ -74.4
7	214./ 74.1	191./ 75.2	31./ 34.3	92./ 12.7	10./ 20.2
8	232./ -33.7	145./ -59.5	46./ -55.9	68./ -71.6	7./ -80.3
9	72./ 3.7	73./ 18.1	20./ 20.5	55./ 58.0	6./ -11.1
10	86./ -85.5	220./ -61.3	90./ -62.1	33./ 3.6	5./ 76.5
11	59./ -13.3	57./ -41.9	24./ -34.3	19./ -71.4	6./ -24.2
12	126./ 57.3	32./ 83.3	40./ 59.8	18./ -18.5	1./ 48.3
PEAK-TO-PEAK	10687.	4103.	1030.	8043.	1049.
	BEAM .174 (N-M/DEG)	BEAM .350 (N-M/DEG)	BEAM .449 (N-M/DEG)	BEAM .606 (N-M/DEG)	BEAM .803 (N-M/DEG)
MEAN	-307.	49.	-66.	-322.	18.
HARMONIC-1	664./ -60.1	411./ -69.5	425./ -69.8	403./ -72.1	177./ -84.3
2	411./ -63.7	259./ -81.7	278./ -80.8	222./ -78.1	70./ -79.8
3	69./ 77.7	42./ -6.9	45./ 43.3	77./ 77.4	91./ 66.9
4	352./ 40.9	104./ 30.0	52./ 18.1	77./ 39.8	124./ 27.6
5	73./ -28.8	6./ 54.9	25./ 40.4	3./ 3.4	55./ 33.7
6	47./ 7.3	0./ 13.9	15./ -35.3	19./ -30.4	43./ -49.9
7	60./ 8.6	12./ 6.4	27./ 33.4	12./ -50.2	35./ 85.6
8	15./ 27.0	2./ -28.8	12./ 54.7	10./ -48.0	21./ -51.8
9	18./ 47.1	17./ 55.8	2./ 81.4	16./ 70.8	16./ 89.8
10	54./ -46.2	16./ -31.7	14./ -41.7	22./ -19.5	16./ -18.4
11	11./ -77.3	10./ -65.3	3./ -11.8	9./ -79.6	6./ -19.2
12	25./ 60.4	8./ -66.1	12./ -81.6	10./ -79.7	6./ -48.6
PEAK-TO-PEAK	2442.	1240.	1271.	1193.	792.

FLIGHT NO. 065 AIRCRAFT TOTAL WT = 34516. N LOAOEO CG X= 5.02 M = 197.7 IN  
 RUN NO. 11 7760. LB Y= -0.00 Z= -0.0  
 TIME 54154.17 (SEC) Z= 1.84 = 72.4

AERODYNAMIC FLIGHT STATE

DYNAMIC PRES= 1.99 KPA = 41.5 PSF  
 STATIC PRES= 97.5 KPA = 2036. PSF  
 TOTAL TEMP= 275.1 DEG K = 495.1 OEG R  
 STATIC TEMP= 273.5 DEG K = 492.3 DEG R  
 T. AIRSPEED= 109.7 KT  
 A/C MACH NO= .170  
 BODY ALPHA= .9 DEG DENSITY= 1.24 KG/M3 = .00241 SLUG/FT3  
 BODY BETA= .9 DEG DENSITY ALT= -144. M = -471. FT  
 SONIC SPEED= 332.1 M/SEC = 1089. FPS  
 RATE OF CLIMB= 116. M/MIN = 382. FPM

INERTIAL FLIGHT STATE

AXIS	OG LIN (M/S)	VEL (FPS)	OG LIN ACC (G)	HUB LIN (M/S)	VEL (FPS)	HUB LIN ACC (G)	AXIS	ANG POS (DEG)	ANG RATES (RAD/SEC)	ANG ACC (RAD/SEC2)
X	56.42	185.1	-0.085	56.29	184.7	-0.082	ROLL	-0.4	-0.003	-0.090
Y	.85	2.8	-0.009	.84	2.8	-0.027	PITCH	2.9	.062	-0.013
Z	.87	2.9	-1.287	.88	2.9	-1.286	YAW	244.2	-0.016	-0.013

CONTROL ANGLES

M.R. COLL= 8.9 OEG HORIZ FIN= 7.3 DEG  
 A1= -0.4 DEG T.R. COLL= .5 DEG  
 B1= 3.8 DEG PEDAL POS= .7 DEG

ROTOR PARAMETERS

HOVER TIP MACH= .69 SHAFT ALPHA= .9 OEG  
 CONTROL ALPHA= -2.9 DEG  
 TIP MAX-MACH= .86 DELTA PSI= -.9 DEG  
 TIP MIN-MACH= .52  
 .9R MAX-MACH= .79 ENGINE POWER= 358. KW = 480. HP  
 .9R MIN-MACH= .45 THRUST FACTOR= .918E+07 N = .206E+07 LB

NASA LANGLEY FLIGHT DATA AH-1G ---- ROTOR PERFORMANCE AND LOADS

FLIGHT NG. 65 MU= .245 TOTAL CQ= .000169 AM6 TEMP= .3 C = 32.61 F  
 RUN NO. 11 V= 109.7 KT MAST CQ= .000181 TEMP U60= 19.8 C = 67.63 F  
 TIME 54154.07 NZ= 1.286 G OMEGA= 34.298 RAD/SEC CAN TEMP= 7.9 C = 46.15 F  
 CLP= .00479 RPM/324= 1.011

ROTOR ANGLES

THETA 314 (DEG) A0= 8.0 A1= -.3 B1= 4.0 PEAK-TO-PEAK= 8.3  
 TEETER ANG (DEG) A0= -.5 A1= -.7 B1= .4 PEAK-TO-PEAK= 1.7

ROTOR LUAOS (AMP/PHASE)

	DRAG BRACE (N/DEG)	CHORD .449 (N-M/DEG)	CHORD .603 (N-M/DEG)	PITCH LINK (N/DEG)	TORSION .449 (N-M/DEG)
MEAN	43756.	11483.	1328.	-1643.	-267.
HARMONIC-1	3503./ -8.5	946./ -13.9	274./ -52.4	2043./ -36.9	350./ -55.7
2	747./ -42.5	261./ -58.1	22./ -5.1	1798./ -32.5	186./ -20.0
3	2058./ 33.8	549./ 34.3	37./ -20.6	310./ -15.5	58./ 22.1
4	632./ 37.0	433./ 22.6	65./ -2.3	491./ -38.3	88./ 47.0
5	391./ -34.7	119./ -22.0	13./ -67.6	165./ 8.7	40./ 87.6
6	1201./ -54.3	840./ -57.2	179./ -65.1	64./ -75.5	23./ 10.2
7	302./ 68.0	222./ 62.8	87./ 74.7	96./ -18.2	8./ 17.0
8	112./ 64.5	81./ 40.8	20./ 66.4	54./ -51.0	5./ 71.9
9	18./ -51.8	228./ 38.9	93./ 44.1	87./ 48.6	6./ -64.0
10	82./ 50.9	87./ 88.9	60./ -69.5	55./ -15.3	9./ -34.0
11	109./ -56.6	25./ 37.7	20./ -57.4	37./ -86.9	6./ 21.2
12	107./ -64.2	70./ -49.5	35./ -79.9	36./ -10.5	8./ -88.6
PEAK-TO-PEAK	10676.	4072.	1029.	7305.	987.

	BEAM .174 (N-M/DEG)	BEAM .350 (N-M/DEG)	BEAM .449 (N-M/DEG)	BEAM .606 (N-M/DEG)	BEAM .803 (N-M/DEG)
MEAN	-70.	38.	-106.	-396.	112.
HARMONIC-1	581./ -46.3	433./ -66.3	450./ -66.9	429./ -71.8	227./ -85.4
2	361./ -48.7	266./ -73.4	302./ -72.5	266./ -72.8	105./ -86.8
3	119./ -67.3	61./ -13.9	56./ 35.0	87./ 74.5	105./ 75.4
4	437./ 45.7	131./ 34.2	64./ 24.2	93./ 44.4	166./ 31.1
5	139./ -37.2	23./ -70.4	30./ 49.6	25./ -40.0	62./ 75.5
6	99./ 72.3	1./ 27.1	13./ 7.3	13./ -4.7	51./ -45.4
7	92./ -1.6	17./ -4.2	31./ 33.3	17./ -77.3	60./ 86.6
8	14./ 20.2	8./ 88.8	8./ -25.8	16./ -48.6	32./ -33.5
9	51./ 38.0	32./ 61.7	14./ 35.4	29./ 79.5	22./ -71.0
10	44./ -45.0	20./ -25.9	11./ -46.3	26./ -15.9	25./ -4.7
11	22./ -27.1	10./ -57.1	13./ -35.2	5./ -.4	9./ -45.1
12	69./ -89.0	19./ -75.9	16./ 79.8	13./ -75.5	5./ -46.7
PEAK-TO-PEAK	2476.	1380.	1442.	1343.	998.

NASA LANGLEY FLIGHT DATA AH-1G ---- PADS PCM DATA

FLIGHT NO. 065 AIRCRAFT TOTAL WT = 34112. N LOADED OG X= 5.02 M = 197.6 IN  
 RUN NO. 12 7639. LB Y= -0.00 = -0.0  
 TIME 54181.60 (SEC) Z= 1.84 = 72.6

AERODYNAMIC FLIGHT STATE

T. AIRSPEED= 109.9 KT DYNAMIC PRES= 2.00 KPA = 41.7 PSF  
 A/C MACH NO= .170 STATIC PRES= 97.6 KPA = 2038. PSF  
 TOTAL TEMP= 275.1 OEG K = 495.1 OEG R  
 STATIC TEMP= 273.5 DEG K = 492.3 OEG R  
 BODY ALPHA= 5.2 OEG DENSITY= 1.24 KG/M3 = .00241 SLUG/FT3  
 BUOY BETA= 2.5 DEG DENSITY ALT= -152. M = -498. FT  
 SONIC SPEED= 332.1 M/SEC = 1089. FPS  
 RATE OF CLIMB= 343. M/MIN = 1125. FPM

INERTIAL FLIGHT STATE

AXIS	OG LIN VEL (M/S)	OG LIN VEL (FPS)	OG LIN ACC (G)	HUB LIN VEL (M/S)	HUB LIN VEL (FPS)	HUB LIN ACC (G)	AXIS	ANG POS (DEG)	ANG RATES (RAD/SEC)	ANG ACC (RAD/SEC2)
X	56.26	184.6	-.121	55.92	183.5	-.119	ROLL	-0.7	-0.009	.030
Y	2.48	8.2	-.029	2.47	8.1	-.023	PITCH	11.0	.165	-.009
Z	5.13	16.6	-1.815	5.14	16.9	-1.810	YAW	244.8	.001	.020

CONTROL ANGLES

M.R. COLL= 8.8 DEG HORIZ FIN= 6.8 OEG  
 A1= -0.1 DEG T.R. COLL= 0.0 OEG  
 R1= 2.3 DEG PEDAL POS= 0.4 DEG

ROTOR PARAMETERS

HOVER TIP MACH\* .70 SHAFT ALPHA= 5.3 OEG  
 CONTROL ALPHA= 3.0 OEG  
 TIP MAX-MACH\* .87 DELTA PSI= -2.5 DEG  
 TIP MIN-MACH\* .53  
 .9R MAX-MACH\* .80 ENGINE POWER= 252. KW = 337. HP  
 .9R MIN-MACH\* .46 THRUST FACTOR= .947E+07 N = .213E+07 Ld

NASA LANGLEY FLIGHT DATA AH-1G ---- ROTOR PERFORMANCE AND LOADS

FLIGHT NO. 65 MU= .241 TOTAL CQ= .000112 AMB TEMP= .3 C = 32.60 F  
 RUN NO. 12 V= 109.9 KT MAST CQ= .000115 TEMP U60= 19.8 C = 67.64 F  
 TIME 54181.45 NZ= 1.810 G OMEGA\* 34.930 RAD/SEC CAN TEMP= 7.9 C = 46.15 F  
 CLP= .00643 RPM/324= 1.029

ROTOR ANGLES

THETA 314 (DEG) A0= 7.5 A1= -0.2 B1= 2.2 PEAK-TO-PEAK= 4.7  
 TETHER ANG (DEG) A0= -0.4 A1= 0.4 B1= 1.2 PEAK-TO-PEAK= 2.3

ROTOR LOADS (AMP/PHASE)

	DRAG BRACE (N/DEG)	CHORD .449 (N-M/DEG)	CHORD .803 (N-M/DEG)	PITCH LINK (N/DEG)	TORSION .449 (N-M/DEG)
MEAN	48509.	11111.	1424.	-1215.	-231.
HARMONIC-1	6561./ 3.4	1722./ 4.3	330./ -37.9	1733./ -30.9	295./ -60.6
2	985./ -39.5	582./ -51.3	38./ -84.0	808./ -18.3	98./ 7.5
3	2935./ 13.3	874./ 13.8	67./ -19.8	436./ 46.3	60./ 50.1
4	793./ 36.4	540./ 15.6	86./ -9.8	471./ 78.4	62./ 46.7
5	730./ -20.9	272./ -20.8	64./ -56.6	252./ -43.6	13./ 9.9
6	1426./ -32.5	982./ -37.0	204./ -31.3	199./ -1.4	43./ 31.2
7	298./ -39.4	195./ -17.4	81./ -58.7	126./ 10.3	18./ 62.9
8	101./ 69.6	105./ -59.7	58./ -72.7	5./ -80.0	12./ 53.6
9	98./ -30.4	61./ 65.8	52./ -89.1	102./ -39.7	7./ -10.0
10	75./ 36.6	158./ -55.8	87./ -59.1	79./ 35.4	4./ 3.9
11	91./ 18.3	41./ -86.4	10./ 31.6	51./ -69.6	7./ 9.7
12	117./ 70.9	31./ -13.9	10./ -69.0	6./ 25.8	5./ -74.0
PEAK-TO-PEAK	17525.	6896.	1249.	4870.	723.
	BEAM .174 (N-M/DEG)	BEAM .350 (N-M/DEG)	BEAM .449 (N-M/DEG)	BEAM .606 (N-M/DEG)	BEAM .803 (N-M/DEG)
MEAN	358.	73.	-109.	-465.	264.
HARMONIC-1	579./ -16.3	433./ -63.0	476./ -66.7	467./ -71.1	287./ 89.6
2	188./ -35.3	199./ -66.8	251./ -63.5	263./ -64.5	147./ -81.0
3	280./ -14.6	125./ -5.3	98./ 16.5	90./ 55.4	105./ 70.2
4	444./ 23.5	133./ 17.7	69./ 29.6	65./ 24.4	184./ 23.2
5	160./ -55.2	24./ -62.6	25./ 54.5	33./ -34.1	80./ 69.7
6	118./ -64.2	13./ 71.1	9./ 33.8	8./ 76.5	50./ -71.2
7	88./ 21.2	17./ 51.4	43./ 52.9	9./ 63.2	62./ -88.5
8	26./ -23.7	5./ -53.1	11./ 79.3	9./ -76.5	27./ -66.3
9	63./ -72.8	40./ -47.6	10./ -44.8	46./ -42.0	39./ -38.3
10	108./ -5.2	38./ 15.8	30./ 17.6	44./ 23.8	32./ 20.1
11	25./ 24.8	9./ 87.0	13./ 38.8	7./ 77.9	2./ 37.0
12	31./ -81.3	6./ -68.9	15./ -80.8	11./ -75.4	5./ -20.4
PEAK-TO-PEAK	2583.	1317.	1372.	1308.	1187.

NASA LANGLEY FLIGHT DATA AH-1G ---- PADS PCM DATA

FLIGHT NO. 065 AIRCRAFT TOTAL WT = 33889. N LOADED CG X = 5.02 M = 197.6 IN  
 RUN NO. 15 7619. LB Y = -.00 Z = -.0  
 TIME 54494.40 (SEC) Z = 1.85 M = 72.7

AERODYNAMIC FLIGHT STATE

T. AIRSPEED = 107.9 KT  
 A/C MACH NO = .167

DYNAMIC PRES- 1.69 KPA • 39.4 PSF  
 STATIC PRES = 95.5 KPA • 1995. PSF  
 TOTAL TEMP = 274.4 DEG K = 493.9 DEG R  
 STATIC TEMP = 272.9 DEG K = 491.2 DEG R

BODY ALPHA = -2.8 DEG  
 BODY BETA = 1.9 DEG

DENSITY = 1.22 KG/M3 = .00237 SLUG/FT3  
 DENSITY ALT\* 45. M = 147. FT  
 SONIC SPEED = 331.7 M/SEC = 1088. FPS  
 RATE OF CLIMB = -57. M/MIN = -188. FPM

INERTIAL FLIGHT STATE

AXIS	CG LIN VEL (M/S)	CG LIN VEL (FPS)	CG LIN ACC (G)	HUB LIN VEL (M/S)	HUB LIN VEL (FPS)	HUB LIN ACC (G)	AXIS	ANG POS (DEG)	ANG RATES (RAD/SEC)	ANG ACC (RAD/SEC2)
X	55.39	181.7	-.069	55.39	181.7	-.068	ROLL	-4	-.002	-.002
Y	1.80	5.9	-.010	1.79	5.9	-.011	PITCH	-3.8	-.000	-.008
Z	-2.74	-9.0	-.987	-2.74	-9.0	-.987	YAW	100.8	-.002	-.001

CONTROL ANGLES

MR COLL = 9.1 DEG HORIZ FIN = 7.7 OEG  
 A1 = -3 DEG T.R. COLL = 1.0 DEG  
 B1 = 4.7 DEG PEDAL POS = 1.1 DEG

ROTOR PARAMETERS

HOVER TIP MACH\* .69 SHAFT ALPHA = -2.8 OEG  
 CONTROL ALPHA = -7.5 DEG  
 TIP MAX-MACH = .85 DELTA PSI\* -1.9 OEG  
 TIP MIN-MACH = .52  
 .9R MAX-MACH = .79 ENGINE POWER = 408. KW = 547. HP  
 .9R MIN-MACH = .45 THRUST FACTOR\* .892E+07 N = .201E+07 LB

NASA LANGLEY FLIGHT DATA AH-1G ---- ROTOR PERFORMANCE AND LOADS

FLIGHT NO. 65 MU\* .243 TOTAL CQ = .000199 AMB TEMP = -3 C = 31.49 F  
 RUN NO. 15 V = 107.9 KT MAST CQ = .000215 TEMP U60 = 19.8 C = 67.61 F  
 TIME 54494.32 NZ = .987 G OMEGA = 34.071 RAD/SEC CAN TEMP\* 7.9 C = 46.15 F  
 CLP = .00372 RPM/324 = 1.004

ROTOR ANGLES

THETA 3/4 (DEG) A0 = 8.5 A1 = -.1 B1 = 5.0 PEAK-TO-PEAK = 10.0  
 TEETER ANG (DEG) A0 = -.5 A1 = -1.4 B1 = .1 PEAK-TO-PEAK = .2.7

ROTOR LOADS (AMP/PHASE)

	DRAG BRACE (N/DEG)	CHORD .449 (N-M/DEG)	CHORD .803 (N-M/DEG)	PITCH LINK (N/DEG)	TORSION .449 (N-M/DEG)
MEAN	41558.	11801.	1236.	-1995.	-281.
HARMONIC-1	3288./ -36.6	1029./ -45.6	297./ -62.7	2356./ -38.8	370./ -55.6
2	504./ 20.8	141./ 38.4	75./ -83.3	2014./ -52.6	201./ -49.6
3	1669./ 24.3	514./ 22.8	41./ -3.6	374./ -41.7	74./ 1.0
4	733./ 25.9	362./ 17.5	49./ -6	392./ 67.6	67./ 33.8
5	116./ 42.8	76./ 85.0	31./ -37.4	238./ 4.7	41./ 21.9
6	926./ -81.5	642./ -86.5	139./ 83.8	122./ -28.0	8./ 17.7
7	169./ 59.5	147./ 80.3	21./ 72.3	87./ 7.0	10./ -4.4
8	225./ -60.0	174./ -77.9	57./ -69.4	59./ -75.5	4./ 76.2
9	38./ -64.0	95./ 19.9	44./ 32.6	43./ 34.1	4./ 1.2
10	73./ 87.4	194./ 85.3	93./ -89.6	45./ 34.8	3./ 68.5
11	41./ -38.4	48./ -17.9	13./ 4.8	30./ -73.0	6./ -28.1
12	117./ 28.4	73./ -81.9	45./ 66.6	17./ -29.5	1./ 25.0
PEAK-TO-PEAK	11083.	4212.	1104.	8279.	1029.
	BEAM .174 (N-M/DEG)	BEAM .350 (N-M/DEG)	BEAM .449 (N-M/DEG)	BEAM .606 (N-M/DEG)	BEAM .803 (N-M/DEG)
MEAN	-374.	43.	-63.	-313.	19.
HARMONIC-1	701./ -62.6	411./ -70.4	425./ -70.8	394./ -73.3	174./ -87.3
2	411./ -68.3	256./ -84.1	273./ -83.5	218./ -81.0	66./ -75.5
3	79./ 59.3	36./ -16.7	41./ 38.2	77./ 69.2	90./ 61.4
4	311./ 32.1	94./ 19.2	50./ 8.8	61./ 32.3	112./ 15.8
5	86./ -30.5	5./ 37.5	27./ 28.5	2./ 7.6	57./ 19.3
6	33./ -8.6	3./ 22.0	13./ -51.8	15./ -52.5	36./ -62.7
7	53./ 1.7	11./ 9.8	28./ 31.5	12./ -68.4	38./ 72.5
8	13./ 45.5	2./ -83.6	12./ 58.9	9./ -63.3	22./ -62.6
9	23./ 32.1	17./ 35.4	3./ 16.5	19./ 51.9	15./ 73.9
10	51./ -64.8	20./ -39.0	13./ -46.3	21./ -34.6	16./ -22.6
11	3./ 49.4	11./ 77.8	2./ 66.0	6./ -82.1	5./ -66.1
12	32./ 61.6	8./ 68.5	10./ 68.2	10./ 74.8	7./ -82.5
PEAK-TO-PEAK	2511.	1238.	1270.	1135.	757.

FLIGHT NO. 065 AIRCRAFT TOTAL WT = 33889. N LOADED CG X = 5.02 M = 197.6 IN  
 RUN NO. 16 7619. LB Y = -.00 Z = -.0  
 TIME 54532.90 (SEC) Z = 1.85 M = 72.7

AERODYNAMIC FLIGHT STATE DYNAMIC PRES= 1.89 KPA = 39.4 PSF  
 STATIC PRES= 95.7 KPA = 1998. PSF  
 T. AIRSPEED\* 107.7 KT TOTAL TEMP= 274.3 DEG K = 493.8 OEG R  
 A/C MACH NO= .167 STATIC TEMP= 272.8 DEG K = 491.0 OEG R  
 BODY ALPHA= -.0 DEG DENSITY= 1.22 KG/M3 = .00237 SLUG/FT3  
 BODY BETA= -1.6 DEG DENSITY ALT= 24. M = 79. FT  
 SONIC SPEED= 331.6 M/SEC = 1088. FPS  
 RATE OF CLIMB= -147. M/MIN = -481. FPM

INERTIAL FLIGHT STATE

AXIS	CG LIN VEL (M/S)	CG LIN VEL (FPS)	CG LIN ACC (G)	HUB LIN VEL (M/S)	HUB LIN VEL (FPS)	HUB LIN ACC (G)	AXIS	ANG POS (DEG)	ANG RATES (RAD/SEC)	ANG ACC (RAD/SEC2)
X	55.40	181.8	-.078	55.26	181.3	-.073	ROLL	-34.2	-.010	.044
Y	-1.51	-5.0	.025	-1.52	-5.0	.036	PITCH	-1.7	.069	-.021
Z	-.03	-.1	-1.236	-.02	-.1	-1.235	YAW	4.7	-.103	-.002

CONTROL ANGLES M.R. COLL= 9.2 DEG HORIZ FIN= 7.3 OEG  
 AI\* = .5 DEG T.R. COLL= .6 DEG  
 B1= 3.8 OEG PEDAL POS= 1.2 OEG

ROTOR PARAMETERS HOVER TIP MACH= .69 SHAFT ALPHA= -.0 OEG  
 CONTROL ALPHA= -3.8 DEG  
 TIP MAX=MACH\* .86 DELTA PSI= 1.6 OEG  
 TIP MIN=MACH= .52  
 9 R MAX=MACH= .79 ENGINE POWER\* 376. KW = 504. HP  
 .9R MIN=MACH= .45 THRUST FACTOR\* .899E+07 N = .202E+07 LB

NASA LANGLEY FLIGHT DATA AH-1G ---- ROTOR PERFORMANCE AND LOADS

FLIGHT NO. 65 MU = .242 TOTAL CQ = .000182 AMB TEMP= -.4 C = 31.33 F  
 RUN NO. 16 V = 107.7 KT MAST CQ = .000197 TEMP U60= 19.8 C = 67.61 F  
 TIME 54532.83 NZ = 1.235 G OMEGA\* 34.181 RAD/SEC CAN TEMP\* 7.5 C = 45.45 F  
 CLP = .00462 RPM/324 = 1.007

ROTOR ANGLES THETA 3/4 (DEG) A0 = 8.2 A1 = -.7 B1 = 4.0 PEAK-TO-PEAK= 8.3  
 TEETER ANG (DEG) A0 = -.5 A1 = -.9 B1 = .4 PEAK-TO-PEAK\* 1.9

ROTOR LOADS (AMP/PHASE)	DRAG BRACE (N/DEG)	CHORD .449 (N-M/DEG)	CHORD .803 (N-M/DEG)	PITCH LINK (N/DEG)	TORSION .449 (N-M/DEG)
MEAN	43060.	11700.	1256.	-1742.	-264.
HARMONIC-1	4335./ -1.9	1186./ -11.1	296./ -42.9	1963./ -29.4	326./ -50.7
2	260./ -19.1	111./ -49.0	50./ -43.9	1680./ -25.2	173./ -17.4
3	2070./ 48.0	602./ 47.1	70./ 15.9	355./ -.6	61./ 37.3
4	545./ 45.1	337./ 43.0	47./ 3.5	429./ -73.8	72./ 63.8
5	404./ -25.9	96./ -41.0	28./ -77.9	114./ 26.6	33./ 89.0
6	996./ -31.8	711./ -33.0	148./ -41.2	46./ -43.7	22./ 29.5
7	191./ -88.6	82./ -88.4	49./ -75.5	60./ 43.4	11./ 77.8
8	26./ 82.9	77./ -69.6	24./ 74.3	47./ .2	7./ -69.9
9	32./ 11.0	91./ -74.4	53./ -53.7	81./ -78.5	3./ -34.8
10	32./ -34.4	188./ 7.5	90./ -1.3	57./ 49.8	6./ 65.7
11	122./ .5	50./ 42.3	15./ 34.7	45./ -8.6	7./ -81.9
12	106./ -16.8	16./ 35.3	19./ -6.3	27./ 36.3	2./ -48.2
PEAK-TO-PEAK	11206.	4099.	1204.	6816.	902.

	BEAM .174 (N-M/DEG)	BEAM .350 (N-M/DEG)	BEAM .449 (N-M/DEG)	BEAM .606 (N-M/DEG)	BEAM .803 (N-M/DEG)
MEAN	-146.	45.	-89.	-364.	94.
HARMONIC-1	580./ -36.7	401./ -61.2	426./ -63.6	416./ -67.1	225./ -83.1
2	341./ -40.7	240./ -65.4	272./ -66.0	226./ -65.4	83./ -79.7
3	86./ -40.4	61./ 13.3	59./ 53.0	76./ -79.5	94./ -84.2
4	347./ 62.1	110./ 51.1	59./ 41.0	77./ 59.7	138./ 47.9
5	99./ -39.2	19./ -69.1	23./ 77.6	15./ -39.4	65./ -83.4
6	86./ -90.0	3./ 1.8	10./ 26.1	15./ 18.4	51./ -20.2
7	36./ 30.8	7./ 32.5	20./ 90.0	16./ -11.5	47./ -33.8
8	36./ 63.6	6./ -70.7	9./ 29.8	9./ 11.9	29./ 25.9
9	39./ -88.2	27./ -79.8	11./ -80.7	26./ -54.0	20./ -29.1
10	49./ 16.4	22./ 39.5	16./ 22.7	28./ 42.9	24./ 48.2
11	11./ 73.8	13./ -18.6	6./ 23.7	3./ -65.1	3./ 8.2
12	34./ -17.2	13./ -13.1	13./ -29.5	10./ -15.5	5./ -9.1
PEAK-TO-PEAK	2224.	1213.	1319.	1210.	911.

NASA LANGLEY FLIGHT DATA AH-1G ---- PADS PCM DATA

FLIGHT NO. 065 AIRCRAFT TOTAL WT = 33711. N LOADED CG X= 5.02 M = 197.5 IN  
 RUN NO. 17 7579. LB Y= -.00 = -.0  
 TIME 54683.00 (SEC) Z= 1.85 = 72.8

AERODYNAMIC FLIGHT STATE DYNAMIC PRES= 1.94 KPA = 40.5 PSF  
 STATIC PRES= 95.7 KPA = 2000. PSF  
 TOTAL TEMP\* 274.2 DEG K = 493.6 OEG R  
 STATIC TEMP= 272.7 DEG K = 490.8 OEG R  
 T. AIRSPEED= 109.1 KT  
 A/C MACH NO= .169  
 BODY ALPHA= 1.5 OEG DENSITY= 1.22 KG/M3 = .00237 SLUG/FT3  
 BODY BETA= 2.4 DEG DENSITY ALT\* 15. M = 48. FT  
 SONIC SPEED= 331.6 M/SEC = 1088. FPS  
 RATE OF CLIMB= -205. M/MIN = -672. FPM

INERTIAL FLIGHT STATE

AXIS	CG LIN VEL (M/S)	CG LIN ACC (G)	HUB LIN VEL (M/S)	HUB LIN ACC (G)	AXIS	ANG POS (DEG)	ANG RATES (RAD/SEC)	ANG ACC (RAD/SEC <sup>2</sup> )		
X	56.07	183.9	-0.093	55.83	183.2	-0.092	ROLL	-41.9	-0.043	-0.002
Y	2.34	7.7	-0.023	2.26	7.4	-0.021	PITCH	-4.0	.115	-0.008
Z	1.45	4.8	-1.411	1.46	4.8	-1.408	YAW	283.7	-0.117	-0.008

CONTROL ANGLES M.R. COLL= 9.3 DEG HORIZ FIN= 6.8 DEG  
 A1= .0 OEG T.R. COLL= .8 DEG  
 B1= 2.7 DEG PEDAL POS= 1.5 DEG

ROTOR PARAMETERS

HOVER TIP MACH= .69 SHAFT ALPHA= 1.5 DEG  
 CONTROL ALPHA= -1.2 DEG  
 TIP MAX-MACH= .86 DELTA PSI\* -2.3 OEG  
 TIP MIN-MACH= .52  
 .9R MAX-MACH= .79 ENGINE POWER= 331. KW = 444. HP  
 .9R MIN-MACH= .45 THRUST FACTOR .904E+07 N = .203E+07 LB

NASA LANGLEY FLIGHT DATA AH-1G ---- ROTOR PERFORMANCE AND LOADS

FLIGHT NO. 65 MU= .244 TOTAL CQ= .000158 AMB TEMP= -.5 C = 31.15 F  
 RUN NO. 17 V= 109.1 KT MAST CQ= .000173 TEMP U60= 19.5 C = 67.13 F  
 TIME 54682.92 NZ= 1.408 G OMEGA= 34.280 RAD/SEC CAN TEMP= 7.1 C = 44.75 F  
 CLP= .00521 RPM/324= 1.010

ROTOR ANGLES THETA 314 (DEG) A0= 8.0 A1= -.1 B1= 3.3 PEAK-TO-PEAK\* 7.1  
 TEETER ANG (DEG) A0= -.5 A1= -.2 B1= .8 PEAK-TO-PEAK- 1.8

ROTOR LOADS (AMP/PHASE) DRAG BRACE CHORD .449 CHORD .803 PITCH LINK TORSION .449  
 (N/DEG) (N-M/DEG) (N-M/DEG) (N-M/DEG)

	MEAN	44557.	11533.	1385.	-1520.	-251.				
HARMONIC-1	4420./	-6.0	1128./	-12.4	256./	-50.6	1846./	-34.5	316./	-58.3
2	862./	-14.7	267./	-41.5	72./	-88.0	1660./	-32.2	175./	-19.9
3	1866./	15.8	555./	21.0	29./	-67.2	312./	2.5	54./	30.1
4	668./	32.2	400./	11.4	89./	1.7	453./	85.2	82./	40.0
5	533./	-34.0	170./	-35.9	31./	-34.5	139./	-15.6	41./	-88.9
6	1357./	-69.4	886./	-76.5	182./	-85.5	137./	-53.9	33./	-6.5
7	333./	76.1	247./	77.9	96./	67.2	97./	-28.4	8./	32.1
8	74./	65.5	88./	-87.7	35./	-87.9	41./	-33.7	5./	77.3
9	68./	85.3	153./	43.5	84./	44.5	99./	51.3	4./	-83.6
10	11./	-3	128./	74.7	75./	78.6	49./	-14.3	8./	-50.0
11	61./	-85.6	28./	-61.5	18./	2.5	34./	84.5	7./	-8.1
12	12./	-21.1	69./	-81.1	18./	-84.2	14./	-40.7	7./	53.0
PEAK-TO-PEAK	11735.		4593.		1116.		6814.		902.	

	BEAM .174 (N-M/DEG)	BEAM .350 (N-M/DEG)	BEAM .449 (N-M/DEG)	BEAM .606 (N-M/DEG)	BEAM .803 (N-M/DEG)					
MEAN	-10.	42.	-107.	-404.	142.					
HARMONIC-1	569./	-34.7	424./	-67.3	450./	-70.6	431./	-75.7	253./	87.1
2	329./	-52.8	246./	-77.7	281./	-77.2	253./	-78.2	97./	85.6
3	128./	-52.9	69./	-20.3	61./	18.0	84./	63.4	99./	68.9
4	391./	31.9	122./	20.0	65./	14.3	81./	29.9	164./	16.1
5	164./	-56.7	26./	-80.9	25./	30.2	33./	-56.7	69./	71.8
6	125./	74.2	5./	22.8	3./	76.8	12./	15.7	48./	-72.0
7	81./	-18.6	17./	-10.0	34./	23.0	17./	82.0	71./	74.9
8	30./	11.0	11./	79.5	8./	-28.5	21./	-68.0	39./	-55.8
9	59./	37.0	34./	55.9	15./	30.1	34./	74.8	33./	-79.4
10	57./	-72.2	20./	-32.5	12./	-61.7	29./	-24.5	24./	-27.4
11	20./	-62.5	10./	76.9	11./	-72.8	4./	-80.9	7./	82.0
12	56./	43.5	22./	68.3	14./	38.9	13./	67.2	4./	-79.7
PEAK-TO-PEAK	2543.		1350.		1418.		1286.		1014.	

FLIGHT NO. 065 AIRCRAFT TOTAL WT = 33702. N LOADED CG X = 5.02 M = 197.5 IN  
 RUN NO. 18 7577. LB Y = -.00 = -.0  
 TIME 54782.70 (SEC) Z = 1.85 = 72.8

AERODYNAMIC FLIGHT STATE DYNAMIC PRES = 1.93 KPA = 40.3 PSF  
 STATIC PRES = 95.9 KPA = 2002. PSF  
 T. AIRSPEED- 108.9 KT TOTAL TEMP = 274.4 DEG K = 493.9 DEG R  
 A/C MACH NO = .169 STATIC TEMP = 272.8 DEG K = 491.1 DEG R  
 BODY ALPHA = 3.9 DEG DENSITY = 1.22 KG/M3 = .00238 SLUG/FT3  
 BODY BETA = 3.2 DEG DENSITY ALT = 6. M = 20. FT  
 SONIC SPEED = 331.7 M/SEC = 1088. FPS  
 RATE OF CLIMB = -323. M/MIN = -1061. FPM

INERTIAL FLIGHT STATE

AXIS	CG LIN (M/S)	VEL (FPS)	CG LIN ACC (G)	HUB LIN VEL (M/S)	VEL (FPS)	HUB LIN ACC (G)	AXIS	ANG POS (DEG)	ANG RATES (RAD/SEC)	ANG ACC (RAD/SEC2)
X	55.80	183.1	-.110	55.43	181.9	-.105	ROLL	-48.0	-.033	.022
Y	3.15	10.3	-.041	3.09	10.1	-.031	PITCH	-5.4	.181	-.027
Z	3.77	12.4	-1.709	3.78	12.4	-1.702	YAW	39.4	-.137	-.037

CONTROL ANGLES M.R. COLL = 9.4 DEG HORIZ FIN = 6.6 DEG  
 A1 = .1 DEG T.R. COLL = .8 DEG  
 B1 = 2.1 DEG PEDAL POS = 1.7 DEG

ROTOR PARAMETERS

HOVER TIP MACH = .70 SHAFT ALPHA\* 3.9 DEG  
 CONTROL ALPHA\* 1.8 DEG  
 TIP MAX-MACH = .86 DELTA PSI = -3.2 DEG  
 TIP MIN-MACH = .53  
 .9R MAX-MACH = .80 ENGINE POWER = 275. KW = 369. HP  
 .9R MIN-MACH = .46 THRUST FACTOR = .921E+07 N = .207E+07 LB

NASA LANGLEY FLIGHT DATA AH-1G ---- ROTOR PERFORMANCE AND LOADS

FLIGHT NO. 65 MU = .241 TOTAL CQ = .000128 AMB TEMP = -.3 C = 31.40 F  
 RUN NO. 18 V = 108.9 KT MAST CQ = .000138 TEMP U60 = 19.7 C = 67.54 F  
 TIME 54782.64 NZ = 1.702 G OMEGA = 34.592 RAD/SEC CAN TEMP = 7.1 C = 44.75 F  
 CLP = .00619 RPM/324 = 1.020

ROTOR ANGLES THETA 314 (DEG) A0 = 7.9 A1 = -.3 B1 = 2.5 PEAK-TO-PEAK = 5.2  
 TEETER ANG (DEG) A0 = -.5 A1 = .1 B1 = 1.1 PEAK-TO-PEAK\* 2.2

ROTOR LOADS (AMP/PHASE) DRAG BRACE CHORD .449 CHORD .803 PITCH LINK TORSION .449  
 (N/DEG) (N-M/DEG) (N-M/DEG) (N-M/DEG)

	DRAG BRACE (N/DEG)	CHORD .449 (N-M/DEG)	CHORD .803 (N-M/DEG)	PITCH LINK (N/DEG)	TORSION .449 (N-M/DEG)
MEAN HARMONIC-1	47182.	11321.	1425.	-1349.	-242.
2	5898./ 3.5	1443./ 3.8	303./ -40.2	1564./ -29.9	284./ -62.6
3	1373./ -56.2	612./ -63.5	55./ -59.6	930./ -9.7	112./ 7.9
4	2569./ 14.8	784./ 15.9	69./ -15.9	344./ 28.0	63./ 43.2
5	722./ 15.4	487./ 8.1	96./ -19.7	395./ 88.1	68./ 35.8
6	651./ -52.1	239./ -51.6	57./ -75.3	144./ -50.7	20./ 86.3
7	1372./ -58.7	1003./ -63.2	215./ -62.9	232./ -28.7	48./ -5.1
8	434./ -79.2	185./ -56.5	95./ 84.5	110./ -9.7	14./ 38.4
9	146./ 63.2	43./ -80.4	41./ 57.0	30./ -41.8	10./ 44.7
10	62./ 68.1	104./ 52.2	67./ 58.2	109./ -81.5	10./ -34.7
11	73./ -74.4	336./ 86.7	164./ 80.3	91./ 1.0	12./ -30.2
12	154./ -60.6	21./ 49.9	44./ 43.5	33./ 79.6	8./ -18.1
PEAK-TO-PEAK	152./ -72.1	61./ -40.4	32./ -34.9	23./ 78.8	8./ 46.0
	17069.	6892.	1357.	4746.	713.

	BEAM .174 (N-M/DEG)	BEAM .350 (N-M/DEG)	BEAM .449 (N-M/DEG)	BEAM .606 (N-M/DEG)	BEAM .803 (N-M/DEG)
MEAN HARMONIC-1	232.	67.	-105.	-446.	236.
2	519./ -15.7	415./ -65.6	462./ -69.0	453./ -74.1	289./ 86.2
3	171./ -26.0	192./ -74.8	247./ -73.5	257./ -75.7	144./ 84.5
4	229./ -34.8	108./ -17.8	82./ 5.3	83./ 51.2	102./ 67.7
5	367./ 24.6	115./ 16.8	63./ 21.4	76./ 29.7	158./ 19.4
6	124./ -68.9	17./ -70.3	24./ 48.9	30./ -58.4	80./ 76.3
7	122./ 83.3	9./ -3.0	7./ -55.2	13./ 23.9	39./ -80.8
8	98./ 8.6	18./ 8.8	46./ 30.9	13./ 76.5	72./ 69.2
9	9./ -80.2	12./ -76.2	5./ 72.3	18./ -76.6	35./ -73.0
10	56./ 83.4	47./ -77.5	13./ -89.9	51./ -67.7	48./ -64.8
11	93./ -39.9	33./ -20.0	22./ -28.1	37./ -11.5	28./ -18.9
12	12./ -37.5	8./ 86.3	7./ -36.9	2./ -73.3	6./ 56.3
PEAK-TU-PEAK	49./ 49.2	10./ 57.1	17./ 36.9	11./ 47.1	2./ 65.5
	2419.	1240.	1375.	1307.	1169.

NASA LANGLEY FLIGHT DATA AH-1G ---- PADS PCM DATA

FLIGHT NO. 065 AIRCRAFT TOTAL WT = 33631. N LOADED CG X = 5.02 M = 197.5 IN  
 RUN NO. 19 7561. LB Y = -.00 M = -.0  
 TIME 54920.80 (SEC) Z = 1.85 M = 72.8

AERODYNAMIC FLIGHT STATE

T. AIRSPEED\* 107.1 KT  
 A/C MACH NO\* .166

DYNAMIC PRES = 1.86 KPA = 38.9 PSF  
 STATIC PRES = 95.5 KPA = 1994. PSF  
 TOTAL TEMP = 274.5 OEG K = 494.0 DEG R  
 STATIC TEMP = 273.0 OEG K = 491.3 DEG R

BODY ALPHA = -1.0 OEG  
 BODY BETA = 1.2 DEG

DENSITY = 1.22 KG/M3 = .00237 SLUG/FT3  
 DENSITY ALT = 53. M = 172. FT  
 SONIC SPEED = 331.8 M/SEC = 1088. FPS  
 RATE OF CLIMB = -41. M/MIN = -133. FPM

INERTIAL FLIGHT STATE

AXIS	CG LIN VEL (M/S)	CG LIN ACC (G)	HUB LIN VEL (M/S)	HUB LIN ACC (G)	AXIS	ANG POS (DEG)	ANG RATES (RAD/SEC)	ANG ACC (RAD/SEC2)		
X	55.10	180.8	-.076	54.97	180.3	-.081	ROLL	-33.4	-.026	.019
Y	1.17	3.8	-.006	1.12	3.7	-.003	PITCH	-2.2	.063	.012
Z	-.93	-3.1	-1.201	-.93	-3.3	-1.200	YAW	69.0	-.093	-.023

CONTROL ANGLES

M.R. COLL = 95 DEG  
 A1 = -2 DEG  
 B1 = 3.3 DEG  
 HORIZ FIN = 7.1 OEG  
 T.R. COLL = .9 OEG  
 PEDAL POS = 1.4 OEG

ROTOR PARAMETERS

HOVER TIP MACH = .69  
 TIP MAX-MACH = .85  
 TIP MIN-MACH = .52  
 .9R MAX-MACH = .78  
 .9R MIN-MACH = .45  
 SHAFT ALPHA = -1.0 OEG  
 CONTROL ALPHA = -4.3 DEG  
 DELTA PSI = -1.2 OEG  
 ENGINE POWER = 390. KW = 523. HP  
 THRUST FACTOR = .892E+07 N = .200E+07 LB

NASA LANGLEY FLIGHT DATA AH-1G ---- ROTOR PERFORMANCE AND LOADS

FLIGHT NO. 65 MU = .241 TOTAL CQ = .000190 AMB TEMP = -.2 C = 31.65 F  
 RUN NO. 19 V = 107.1 KT MAST CQ = .000206 TEMP U60 = 19.8 C = 67.70 F  
 TIME 54920.65 NZ = 1.200 G OMEGA = 34.098 RAD/SEC CAN TEMP = 7.1 C = 44.75 F  
 CLP = .00449 RPM/324 = 1.005

ROTOR ANGLES

THETA314 (DEG) A0 = 8.4 A1 = -.4 B1 = 4.1 PEAK-TO-PEAK\* 8.6  
 TEETER ANG (DEG) A0 = -.5 A1 = -.7 B1 = .4 PEAK-TO-PEAK\* 1.6

ROTOR LOADS (AMP/PHASE)

	DRAG BRACE (N/DEG)	CHORD .449 (N-M/DEG)	CHORD .803 (N-M/DEG)	PITCH LINK (N/DEG)	TORSION .449 (N-M/DEG)
MEAN HARMONIC-1	42574.	11876.	1244.	-1800.	-272.
2	3950./ -14.9	1077./ -24.5	289./ -51.7	2060./ -33.0	325./ -53.4
3	533./ -40.9	205./ -65.9	45./ -68.5	1758./ -39.9	190./ -35.2
4	1976./ 36.7	572./ 36.3	45./ -.5	342./ -21.8	62./ 16.4
5	670./ 30.2	363./ 20.8	51./ 2.9	408./ 87.5	66./ 49.1
6	228./ -37.0	47./ -72.2	14./ 33.4	158./ 14.2	45./ 55.0
7	1072./ -67.2	723./ -72.0	165./ -82.4	70./ -54.8	22./ -8.1
8	70./ -53.7	65./ -44.3	17./ -17.4	89./ 21.3	11./ 43.5
9	71./ 62.1	52./ 2.8	16./ -23.9	56./ -42.7	6./ 76.4
10	46./ 24.4	71./ 87.5	56./ 85.0	66./ 63.8	3./ 54.6
11	67./ -29.8	306./ -65.1	133./ -65.7	44./ 18.3	4./ 15.8
12	105./ -68.0	41./ -42.3	20./ -33.9	43./ -70.5	4./ 50.3
PEAK-TO-PEAK	111./ -54.6	52./ -12.0	24./ -61.0	16./ -30.8	2./ -71.6
	11191.	4471.	1222.	7179.	916.
	BEAM .174 (N-M/DEG)	BEAM .350 (N-M/DEG)	BEAM .449 (N-M/DEG)	BEAM .606 (N-M/DEG)	BEAM .803 (N-M/DEG)
MEAN HARMONIC-1	-172.	45.	-87.	-359.	87.
2	612./ -44.9	402./ -67.5	429./ -68.8	414./ -72.2	215./ -89.8
3	334./ -55.3	241./ -76.4	269./ -76.8	220./ -74.8	72./ -83.7
4	70./ -61.5	56./ .6	56./ 41.1	80./ 80.0	98./ 76.0
5	304./ 44.0	99./ 31.7	56./ 19.4	67./ 40.2	122./ 25.3
6	91./ -56.7	13./ 76.5	24./ 47.4	12./ -83.9	66./ 61.5
7	77./ 66.8	7./ -33.1	7./ 35.5	13./ -14.4	39./ -52.1
8	46./ 3.9	10./ 3.8	20./ 45.4	13./ -69.5	44./ -78.3
9	24./ 14.9	6./ 77.8	7./ -20.6	11./ -46.4	26./ -26.3
10	45./ 45.7	28./ 67.0	11./ 58.7	28./ 85.5	25./ -77.4
11	53./ -49.7	18./ -7.2	16./ -41.9	25./ -7.9	21./ -1.4
12	12./ 41.1	11./ -72.5	5./ -2.5	8./ 83.2	3./ -84.7
PEAK-TO-PEAK	34./ -85.9	13./ -76.6	11./ -81.9	10./ -77.4	6./ -76.8
	2208.	1228.	1315.	1208.	876.



FLIGHT NO. 065 AIRCRAFT TOTAL WT = 33591. N LOADED CG X= 5.02 M = 197.5 IN  
 RUN NO. 20 7552. LB Y= -.00 Z= 1.85  
 TIME 55001.60 (SEC)

AERODYNAMIC FLIGHT STATE

T. AIRSPEED" 109.0 KT  
 A/C MACH NO\* .169

BODY ALPHA- 2.0 OEG  
 BODY BETA= 1.3 OEG

DYNAMIC PRES= 1.94 KPA = 40.5 PSF  
 STATIC PRES= 96.0 KPA = 2005. PSF  
 TOTAL TEMP= 274.3 DEG K = 493.8 DEG R  
 STATIC TEMP= 272.8 OEG K = 491.0 DEG R

DENSITY- 1.23 KG/M3 = .00238 SLUG/FT3  
 DENSITY ALT= -9. M = -28. FT  
 SONIC SPEED= 331.6 M/SEC = 1088. FPS  
 RATE OF CLIMB\* -294. M/MIN = -965. FPM

INERTIAL FLIGHT STATE

AXIS	CG LIN VEL (M/S)	CG LIN VEL (FPS)	CG LIN ACC (G)	HUB LIN VEL (M/S)	HUB LIN VEL (FPS)	HUB LIN ACC (G)	AXIS	ANG PUS (DEG)	ANG RATES (RAD/SEC)	ANG ACC (RAD/SEC2)
X	56.03	183.8	-.107	55.74	182.9	-.105	ROLL	-48.7	-.047	-.021
Y	1.30	4.3	-.011	1.21	4.0	-.011	PITCH	-4.7	.142	-.014
Z	1.92	6.3	-1.503	1.93	6.3	-1.499	YAW	157.3	-.137	.002

CONTROL ANGLES

M.R. COLL= 9.4 OEG  
 A1= - DEG  
 B1= 24 DEG  
 HORIZ FIN= 6.7 OEG  
 T.R. COLL= .6 DEG  
 PEDAL POS= 1.5 OEG

ROTOR PARAMETERS

HOVER TIP MACH\* .69  
 TIP MAX-MACH" .86  
 TIP BIN-MACH= .52  
 .9R MAX-MACH= .79  
 .9R MIN-MACH\* .45  
 SHAFT ALPHA\* 2.0 OEG  
 CONTROL ALPHA- -.4 OEG  
 DELTA PSI= -1.2 DEG  
 ENGINE POWER= 329. KW = 441. HP  
 THRUST FACTOR= .913E+07 N = .205E+07 LB

NASA LANGLEY FLIGHT OATA AH-1G ---- ROTOR PERFORMANCE AND LOAOS

FLIGHT NO. 65 MU- .243 TOTAL CQ= .000155 AMB TEMP= -4 C = 31.30 F  
 RUN NO. 20 V= 109.0 KT MAST CQ= .000169 TEMP U60= 19.8 C = 67.58 F  
 TIME 55001.45 NZ= 1.499 G OMEGA- 34.418 RAD/SEC CAN TEMP= 7.1 C = 44.75 F  
 CLP= .00547 RPM/324= 1.014

ROTOR ANGLES

THETA 314 (DEG) A0= 8.1 A1= -5 B1= 2.9 PEAK-TO-PEAK- 6.4  
 TEETER ANG (DEG) A0= -5 A1= - DEG B1= .8 PEAK-TO-PEAK\* 1.8

ROTOR LOADS (AMP/PHASE)

	DRAG BRACE (N/DEG)	CHORD .449 (N-M/DEG)	CHORD .803 (N-M/DEG)	PITCH LINK (N/DEG)	TORSION .449 (N-M/DEG)
MEAN HARMONIC-1	45156.	11648.	1387.	-1527.	-261.
2	5314./ 1.4	1377./ -4.7	309./ -41.2	1754./ -30.5	303./ -57.7
3	558./ -33.3	286./ -54.7	11./ -12.0	1395./ -18.1	153./ -5.0
4	1995./ 26.1	563./ 21.8	38./ -24.8	381./ 16.1	55./ 47.7
5	578./ 46.8	358./ 29.5	58./ -5.7	429./ -83.0	74./ 52.8
6	605./ -33.5	192./ -42.8	53./ -77.9	90./ 5.4	41./ -66.9
7	1665./ -43.3	1134./ -47.2	245./ -48.7	173./ -19.4	45./ 14.2
8	452./ -75.0	257./ -43.7	116./ -79.4	136./ -.3	10./ 42.7
9	49./ 72.6	42./ -17.8	31./ -82.5	35./ -30.3	6./ 78.0
10	63./ .5	132./ 82.4	70./ 84.1	113./ -79.6	11./ -29.2
11	107./ -7.0	254./ -88.4	108./ -82.5	112./ 6.1	15./ -3.3
12	45./ -67.1	21./ -27.8	7./ 66.3	23./ 83.3	2./ 11.3
PEAK-TO-PEAK	56./ -24.3	34./ 4.4	20./ -50.3	2./ 20.6	7./ 87.8
	14607.	5877.	1294.	6206.	843.
	BEAM .174 (N-M/DEG)	BEAM .350 (N-M/DEG)	BEAM .449 (N-M/DEG)	BEAM .606 (N-M/DEG)	BEAM .803 (N-M/DEG)
MEAN HARMONIC-1	98.	54.	-109.	-424.	179.
2	606./ -25.2	426./ -63.7	459./ -67.6	439./ -73.3	266./ 86.5
3	293./ -38.7	225./ -71.7	264./ -70.7	258./ -71.9	115./ -89.9
4	155./ -39.4	80./ -12.0	63./ 24.6	84./ 69.7	102./ 76.9
5	377./ 41.2	120./ 31.1	61./ 30.9	77./ 36.6	161./ 25.4
6	149./ -43.6	26./ -65.4	27./ 51.4	31./ -36.9	70./ 87.4
7	128./ -85.4	8./ 27.3	7./ -21.4	13./ 49.9	39./ -65.3
8	116./ 22.2	21./ 30.8	51./ 48.2	21./ -89.2	84./ 87.7
9	26./ 36.7	10./ -73.4	8./ -25.1	23./ -43.1	40./ -37.9
10	73./ 77.5	41./ -83.4	17./ 67.5	46./ -66.0	44./ -50.2
11	77./ -43.0	29./ -6.8	17./ -23.2	37./ 2.3	29./ .0
12	12./ -38.0	10./ -69.4	7./ -27.7	5./ -65.2	7./ -83.7
PEAK-TO-PEAK	48./ 82.4	15./ -76.3	19./ 66.9	12./ -79.7	3./ -78.4
	2617.	1307.	1393.	1305.	1066.

FLIGHT NO. 065 AIRCRAFT TOTAL WT = 33480. N LOADED CG X= 5.02 M = 197.1 IN  
 RUN NO. 21 7527. LB Y= -0.00 : -0.0  
 TIME 55224.43 (SEC) Z= 1.85 : 72.9

AERODYNAMIC FLIGHT STATE

DYNAMIC PRES= 1.86 KPA \* 38.8 PSF  
 STATIC PRES= 95.2 KPA = 1988. PSF  
 TOTAL TEMP= 274.4 DEG K = 493.9 DEG R  
 STATIC TEMP= 272.9 DEG K = 491.2 DEG R  
 T. AIRSPEED\* 107.2 KT  
 A/C MACH NO- .166  
 BODY ALPHA- -2.4 DEG  
 BODY BETA= .9 OEG  
 DENSITY= 1.22 KG/M3 = .00236 SLUG/FT3  
 DENSITY ALT= 80. M = 263. FT  
 SONIC SPEED= 331.7 M/SEC = 1088. FPS  
 RATE OF CLIMB= -50. M/MIN = -163. FPM

INERTIAL FLIGHT STATE

AXIS	CG LIN VEL (M/S)	CG LIN VEL (FPS)	CG LIN ACC (G)	HUB LIN VEL (M/S)	HUB LIN VEL (FPS)	HUB LIN ACC (G)	AXIS	ANG POS (DEG)	ANG RATES (RAD/SEC)	ANG ACC (RAD/SEC2)
X	55.08	180.7	-.067	55.06	180.7	-.065	ROLL	-0.7	.006	-.002
Y	.90	2.9	-.000	.91	3.0	-.001	PITCH	-3.3	.008	-.010
Z	-2.31	-7.6	-.990	-2.31	-7.6	-.990	YAW	275.1	-.002	.014

CONTROL ANGLES

M.R. COLL= 9.3 DEG  
 A1= -0.1 OEG  
 B1= 4.3 DEG  
 HORIZ FIN= 7.5 OEG  
 T.R. COLL= .2 OEG  
 PEDAL POS= .3 DEG

ROTOR PARAMETERS

HOVER TIP MACH= .69  
 SHAFT ALPHA\* -2.4 DEG  
 CONTROL ALPHA= -6.7 DEG  
 TIP MAX-MACH= .85  
 TIP MIN-MACH= .52  
 .9R MAX-MACH\* a78  
 .9R MIN-MACH\* .45  
 DELTA PSI = -.9 OEG  
 ENGINE POWER= 397. KW = 532. HP  
 THRUST FACTOR= .887E+07 N = .199E+07 LB

NASA LANGLEY FLIGHT DATA AH-1G ---- ROTOR PERFORMANCE AND LOADS

FLIGHT NO. 65 MU= .241 TOTAL CQ= .000195 AMB TEMP= -0.3 C = 31.48 F  
 V= 107.2 KT MAST CQ= .000214 TEMP U60= 19.8 C = 67.59 F  
 RUN NO. 21 NZ= .990 G OMEGA= 34.062 RAD/SEC CAN TEMP\* 7.1 C = 44.75 F  
 TIME 55224.33 CLP= .00370 RPM/324= 1.004

ROTOR ANGLES

THETA 3/4 (DEG) A0= 8.3 A1= -0.3 B1= 5.0 PEAK-TO-PEAK- 10.4  
 TEETER ANG (DEG) A0= -0.6 A1= -1.5 B1= .0 PEAK-TO-PEAK- 2.9

ROTOR LOADS (AMP/PHASE)

	DRAG BRACE (N/DEG)	CHORO .449 (N-M/DEG)	CHORO .803 (N-M/DEG)	PITCH LINK (N/DEG)	TORSION .449 (N-M/DEG)
MEAN	41645.	12016.	1214.	-1941.	-272.
HARMONIC-1	2930./ -36.6	874./ -45.4	262./ -63.3	2290./ -37.4	370./ -54.5
2	237./ -40.6	48./ -30.5	68./ -63.9	1952./ -52.2	203./ -47.0
3	1735./ 33.5	530./ 34.3	45./ -2.7	371./ -34.6	69./ 2.4
4	747./ 24.2	324./ 20.1	41./ -6.4	409./ 73.4	68./ 43.2
5	173./ 32.5	95./ 82.4	29./ -48.4	214./ 8.2	35./ 25.9
6	877./ -71.0	625./ -73.4	136./ -78.1	108./ -30.0	5./ -53.3
7	221./ 66.7	137./ 67.3	24./ 69.2	89./ 24.6	8./ 19.1
8	196./ -49.9	135./ -71.0	47./ -64.2	73./ -55.9	7./ -80.7
9	31./ -27.0	122./ 36.4	56./ 36.5	55./ 35.0	4./ -13.0
10	80./ 64.2	274./ -80.3	116./ -85.0	31./ 38.5	4./ 70.7
11	58./ -44.8	43./ 75.7	5./ -48.0	37./ -75.2	6./ -19.4
12	47./ 75.0	101./ -68.9	43./ -87.2	18./ 28.0	1./ 5.7
PEAK-TO-PEAK	9601.	4268.	1158.	7909.	1026.
	BEAM .174 (N-M/DEG)	BEAM .350 (N-M/DEG)	BEAM .449 (N-M/DEG)	BEAM .606 (N-M/DEG)	BEAM .803 (N-M/DEG)
MEAN	-387.	37.	-73.	-324.	27.
HARMONIC-1	675./ -59.6	403./ -68.5	417./ -69.2	390./ -70.8	177./ -84.4
2	387./ -65.1	255./ -82.8	274./ -82.0	221./ -79.4	72./ -76.6
3	83./ 66.3	35./ -7.1	41./ 46.5	75./ 76.6	85./ 69.4
4	309./ 37.0	95./ 27.5	49./ 14.7	65./ 39.7	119./ 24.3
5	84./ -21.9	4./ 50.2	26./ 34.9	4./ 58.0	54./ 24.2
6	28./ -24.3	2./ 20.6	13./ -53.1	15./ -43.6	39./ -58.0
7	51./ 32.4	10./ 32.5	26./ 47.2	15./ -61.9	40./ -89.8
8	21./ 74.8	1./ -54.2	9./ 80.7	8./ -43.6	21./ -41.4
9	24./ 29.1	19./ 47.2	3./ 41.1	18./ 73.9	14./ -85.8
10	51./ -55.0	18./ -24.7	13./ -44.8	22./ -19.5	17./ -5.5
11	16./ 54.5	9./ -82.9	2./ -6.7	6./ 80.5	4./ -64.3
12	21./ 84.0	7./ -66.0	9./ 83.5	7./ -82.3	4./ -82.9
PEAK-TO-PEAK	2438.	1212.	1244.	1153.	756.

NASA LANGLEY FLIGHT DATA AH-1G ---- PADS PCM DATA

FLIGHT NO. 065 AIRCRAFT TOTAL WT = 33409. N LOADED CG X = 5.02 M = 197.5 IN  
 RUN NO. 22 7511. LB Y = -.00 Z = -.0  
 TIME 55276.70 (SEC) Z = 1.85 M = 73.0

AERODYNAMIC FLIGHT STATE

T. AIRSPEED- 107.4 KT  
 A/C MACH NU = .167

DYNAMIC PRES = 1.87 KPA = 39.0 PSF  
 STATIC PRES = 95.5 KPA = 1994. PSF  
 TOTAL TEMP\* 274.2 OEG K = 493.5 DEG R  
 STATIC TEMP = 272.7 DEG K = 490.8 OEG R

BODY ALPHA\* -2.2 OEG  
 BODY BETA = 2.8 DEG

DENSITY = 1.22 KG/M3 = .00237 SLUG/FT3  
 DENSITY ALT = 44. M = 144. FT  
 SONIC SPEED = 331.6 M/SEC = 1088. FPS  
 RATE OF CLIMB = -45. M/MIN = -149. FPM

INERTIAL FLIGHT STATE

AXIS	CG LIN VEL (M/S)	VEL (FPS)	CG LIN ACC (G)	HUB LIN VEL (M/S)	VEL (FPS)	HUB LIN ACC (G)	AXIS	ANG POS (DEG)	ANG RATES (RAD/SEC)	ANG ACC (RAD/SEC2)
X	55.12	180.8	-.080	55.03	180.5	-.082	ROLL	24.1	-.005	.013
Y	2.72	8.9	-.018	2.71	8.9	-.016	PITCH	-1.6	.043	.013
Z	-2.10	-6.9	-1.125	-2.10	-6.9	-1.125	YAW	45.8	.079	-.010

CONTROL ANGLES

M.R. COLL = 9.3 OEG  
 A1 = .1 DEG  
 B1 = 3.5 DAE  
 HORIZ FIN = 7.1 OEG  
 T.R. COLL = -.1 DEG  
 PEDAL POS = -.4 DEG

ROTOR PARAMETERS

HOVER TIP MACH = .69  
 SHAFT ALPHA\* -2.2 DEG  
 CONTROL ALPHA = -5.7 DEG  
 TIP MAX-MACH = .85  
 TIP MIN-MACH = .52  
 .9R MAX-MACH = .79  
 .9R MIN-MACH = .45  
 DELTA PSI = -2.8 OEG  
 ENGINE POWER- 378. KW = 507. HP  
 THRUST FACTOR = .895E+07 N = .201E+07 LB

NASA LANGLEY FLIGHT DATA AH-1G ---- ROTOR PERFORMANCE AND LOADS

FLIGHT NO. 65 MU = .241 TOTAL CQ = .000183 AMB TEMP- -.5 C = 31.11 F  
 RUN NO. 22 V 107.4 KT MAST CQ = .000200 TEMP U60 = 19.8 C = 67.58 F  
 TIME 55276.55 NZ = 1.125 G OMEGA = 34.152 RAD/SEC CAN TEMP = 7.1 C = 44.75 F  
 CLP = .00416 RPM/324 = 1.007

ROTOR ANGLES THETA 3/4 (DEG) A0 = 8.2 A1 = .0 B1 = 4.1 PEAK-TO-PEAK- 8.5  
 TEETER ANG (DEG) A0 = -.5 A1 = -.8 B1 = .4 PEAK-TO-PEAK = 1.8

ROTOR LOADS (AMP/PHASE) DRAG BRACE (N/DEG) CHORD .449 (N-M/DEG) CHORO .803 (N-M/DEG) PITCH LINK (N/DEG) TORSION .449 (N-M/DEG)

	42264.	11872.	1249.	-1795.	-265.
MEAN HARMONIC-1	3378./ -21.6	929./ -30.8	286./ -60.3	2142./ -39.7	347./ -58.2
2	733./ -42.0	230./ -54.2	37./ -86.6	1801./ -45.8	188./ -39.2
3	1882./ 24.8	535./ 22.6	53./ -15.6	373./ -34.7	67./ 3.8
4	631./ 15.3	319./ 8.6	41./ -33.0	394./ 73.0	77./ 35.2
5	166./ -45.8	20./ 52.7	28./ -7.5	143./ -3.7	23./ 43.8
6	1100./ -78.6	783./ -78.5	177./ -85.8	37./ -35.0	6./ -13.5
7	22./ 28.1	24./ 54.6	8./ 71.3	77./ -1.1	6./ -7.2
8	117./ -70.8	59./ -39.2	23./ -42.1	69./ -75.7	6./ 79.0
9	57./ -40.4	69./ 81.7	39./ 64.5	69./ 43.3	4./ 7.4
10	181./ -64.3	179./ -60.9	77./ -61.9	60./ 1.8	6./ 5.1
11	129./ 76.7	69./ -62.3	15./ -65.5	44./ 59.3	4./ 19.2
12	100./ -89.1	57./ -41.9	36./ -76.7	28./ -39.2	3./ 38.0
PEAK-TO-PEAK	10668.	4284.	1248.	7375.	974.

	BEAM .174 (N-M/DEG)	BEAM .350 (N-M/DEG)	BEAM .449 (N-M/DEG)	BEAM .606 (N-M/DEG)	BEAM .803 (N-M/DEG)
MEAN HARMONIC-1	-253.	33.	-91.	-353.	66.
2	583./ -54.7	406./ -71.3	429./ -72.2	412./ -74.4	209./ -87.7
3	342./ -60.9	247./ -82.4	276./ -82.6	230./ -81.9	82./ 85.8
4	83./ -85.5	49./ -15.7	47./ 34.5	77./ 72.0	95./ 67.4
5	326./ 32.0	100./ 24.0	54./ 10.8	73./ 34.5	125./ 20.1
6	69./ -58.3	12./ 76.4	25./ 34.3	6./ -60.2	54./ 39.9
7	49./ 24.4	1./ 6.6	10./ -50.8	16./ -46.0	45./ -65.8
8	40./ -18.3	10./ -14.0	22./ 24.5	14./ -64.2	39./ 88.2
9	4./ -36.8	7./ 62.5	4./ 72.3	11./ -73.7	24./ -56.2
10	33./ 39.8	29./ 43.2	11./ 55.0	32./ 57.7	25./ 75.2
11	55./ -68.7	20./ -50.9	17./ -68.4	25./ -40.7	19./ -26.0
12	16./ -23.2	8./ 65.0	7./ -51.4	7./ 29.2	3./ 20.6
PEAK-TO-PEAK	2223.	1236.	1294.	1248.	860.

FLIGHT NO. 065 AIRCRAFT TOTAL WT = 33222. N LOADED CG X= 5.01 M = 197.4 IN  
 RUN NO. 25 7469. LB Y= -0.00 = -0.0  
 TIME 55583.30 (SEC) Z= 1.86 = 73.1

AERODYNAMIC FLIGHT STATE

DYNAMIC PRES= 1.88 KPA = 39.3 PSF  
 STATIC PRES= 95.8 KPA = 2000. PSF  
 TOTAL TEMP= 274.5 OEG K = 494.1 DEG R  
 STATIC TEMP\* 273.0 DEG K = 491.3 DEG R  
 T. AIRSPEED\* 107.5 KT  
 A/C NACH NO= .167  
 BODY ALPHA= -.7 DEG DENSITY= 1.22 KG/M3 = .00237 SLUG/FT3  
 BODY BETA\* 2.1 OEG DENSITY ALT= 22. M = 72. FT  
 SONIC SPEED= 331.8 M/SEC = 1088. FPS  
 RATE OF CLIMB= -287. M/MIN = -943. FPM

INERTIAL FLIGHT STATE

AXIS	CG LIN VEL (M/S)	CG LIN VEL (FPS)	CG LIN ACC (G)	HUB LIN VEL (M/S)	HUB LIN VEL (FPS)	HUB LIN ACC (G)	AXIS	ANG POS (DEG)	AN6 RATES (RAD/SEC)	ANG ACC (RAD/SEC2)
X	55.28	181.4	-.106	55.03	180.5	-.113	ROLL	44.9	.030	.016
Y	2.05	6.7	-.013	2.11	6.9	-.013	PITCH	-4.0	.123	.029
Z	-.72	-2.4	-1.405	-.71	-2.3	-1.402	YAW	65.6	.129	-.027

CONTROL ANGLES

M.R. COLL= 9.5 DEG HORIZ FIN= 6.7 DEG  
 A1= .1 OEG T.R. COLL= -1.2 OEG  
 B1= 2.4 OEG PEDAL POS= -1.5 OEG

RUTJR PARAMETERS

SHAFT ALPHA= -.7 DEG  
 CONTROL ALPHA\* -3.2 DEG  
 HOVER TIP MACH\* .69  
 TIP MAX-MACH= .86 DELTA PSI= -2.2 DEG  
 TIP MIN-MACH= .52  
 .9R MAX-MACH= .79 ENGINE POWER= 315. KW = 423. HP  
 .9R MIN-MACH\* .45 THRUST FACTOR= .906E+07 N = .204E+07 LB

NASA LANGLEY FLIGHT DATA AH-1G ---- ROTOR PERFORMANCE AND LOADS

FLIGHT NO. 65 MU= .241 TOTAL CG= .000151 AMB TEMP= -0.2 C = 31.68 F  
 V= 107.5 KT MAST CG= .000167 TEMP U60= 19.8 C = 67.61 F  
 RUN NO. 25 NZ= 1.402 G OMEGA= 34.268 RAD/SEC CAN TEMP= 7.1 C = 44.75 F  
 TIME 55582.86 CLP= .00512 RPM/324= 1.010

ROTOR ANGLES

THETA314 (DEG) A0= 8.1 A1= -.2 B1= 3.0 PEAK-TO-PEAK\* 6.2  
 TEETER ANG (DEG) A0= -.6 A1= -.1 B1= .6 PEAK-TO-PEAK= 1.4

ROTOR LOADS (AMP/PHASE)

DRAG BRACE CHORO .449 CHORO .803 PITCH LINK TORSION .449  
 (N/DEG) (N-M/DEG) (N-M/DEG) (N-M/DEG)

	44206.	11518.	1360.	-1646.	-269.
MEAN HARMONIC-1	3927./ -9.6	1002./ -15.0	295./ -55.7	1820./ -42.2	328./ -62.4
2	702./ -17.4	317./ -38.4	37./ 74.9	1345./ -25.1	132./ -9.3
3	1892./ 31.2	569./ 28.7	41./ -27.4	293./ 17.6	67./ 30.6
4	653./ 37.6	383./ 23.0	60./ 4.8	401./ -76.2	68./ 55.1
5	553./ -51.3	223./ -53.7	58./ -74.0	109./ -68.1	18./ -57.2
6	1590./ -47.2	1146./ -52.5	245./ -55.9	189./ -31.6	42./ 8.2
7	438./ -79.2	221./ 87.0	105./ 87.5	67./ -5.9	8./ -6.1
8	83./ 88.0	107./ 78.5	40./ 88.6	70./ 15.2	3./ -2.1
9	43./ 29.3	259./ 59.0	113./ 57.7	141./ 76.3	9./ -47.5
10	64./ 73.7	289./ 84.6	133./ 88.8	101./ 24.5	7./ -24.3
11	61./ -47.3	73./ 23.4	43./ 43.8	66./ -57.5	4./ 59.4
12	100./ -54.3	60./ -35.5	23./ -43.1	5./ 83.7	7./ 80.4
PEAK-TO-PEAK	11735.	5135.	1322.	6084.	834.

BEAM .174 BEAM .350 BEAM .449 BEAM .606 BEAM .803  
 (N-M/DEG) (N-M/DEG) (N-M/DEG) (N-M/DEG) (N-M/DEG)

	-46.	46.	-109.	-404.	147.
MEAN HARMONIC-1	445./ -42.8	401./ -68.4	432./ -70.4	427./ -71.8	253./ -83.0
2	264./ -50.2	238./ -73.9	283./ -73.2	271./ -75.8	138./ 86.0
3	107./ -20.3	70./ -1.4	62./ 34.9	80./ 77.7	102./ 86.3
4	325./ 53.7	103./ 41.0	55./ 31.2	71./ 52.0	137./ 34.2
5	143./ -79.2	21./ -69.3	16./ 61.5	26./ -65.0	67./ 85.9
6	187./ 84.5	8./ 5.7	21./ -82.7	20./ 35.0	31./ -42.1
7	68./ 45.5	13./ 46.1	44./ 69.8	21./ -58.7	81./ -77.1
8	68./ 15.4	12./ 85.8	19./ -10.8	21./ -44.5	41./ -29.3
9	81./ 62.6	43./ 79.3	19./ 70.8	45./ -80.5	40./ -68.9
10	67./ -20.4	25./ 11.1	21./ -7.3	34./ 14.8	26./ 2.4
11	18./ 43.2	17./ -59.3	11./ 7.4	8./ -74.1	6./ -73.8
12	47./ 77.9	15./ -80.0	20./ 75.1	14./ -88.9	3./ -71.8
PEAK-TU-PEAK	2151.	1236.	1368.	1295.	997.

FLIGHT NO. 066 AIRCRAFT TOTAL WT = 36646. N LOADED CG X= 5.03 M = 198.1 IN  
 RUN NO. 1 8239. LB Y= -.00 = -.0  
 TIME 53130.80 (SEC) Z= 1.82 = 71.7

AERODYNAMIC FLIGHT STATE DYNAMIC PRES= 0.00 KPA = 0.0 PSF  
 STATIC PRES= 102.0 KPA = 2130. PSF  
 TOTAL TEMP= 275.3 DEG K = 495.6 OEG R  
 STATIC TEMP= 275.3 DEG K = 495.6 DEG R  
 T. AIRSPEED= 0.0 KT  
 A/C MACH NO= 0.000  
 BODY ALPHA= 6.0 OEG DENSITY= 1.29 KG/M3 = .00250 SLUG/FT3  
 BODY BETA= 7.5 OEG DENSITY ALT= -544. M = -1784. FT  
 SONIC SPEED= 333.2 M/SEC = 1093. FPS  
 RATE OF CLIMB= 0. M/MIN = 0. FPM

INERTIAL FLIGHT STATE

AXIS	CG LIN (M/S)	VEL (FPS)	CG LIN ACC (G)	HUB LIN VEL (M/S)	VEL (FPS)	HUB LIN ACC (G)	AXIS	ANG POS (DEG)	ANG RATES (RAD/SEC)	ANG ACC (RAD/SEC2)
X	0.00	0.0	-.035	0.03	0.0	-.050	ROLL	-1.8	-.002	-.004
Y	0.00	0.0	.039	0.00	0.0	.038	PITCH	-1.1	.003	.071
Z	0.00	0.0	-.981	0.00	0.0	-.980	YAW	244.2	-.005	.010

CONTROL ANGLES

M.R. COLL= 10.0 OEG HORIZ FIN\* 6.1 OEG  
 A1= -2.8 DEG T.R. COLL= 7.4 DEG  
 B1= -2.4 OEG PEDAL POS= 7.6 DEG

ROTOR PARAMETERS

HOVER TIP MACH= .68 SHAFT ALPHA= 0.0 OEG HUB HEIGHT= 1.9 R  
 CONTROL ALPHA\* 2.4 OEG  
 TIP MAX-MACH= .68 DELTA PSI\* 0.0 DEG  
 TIP MIN-MACH= .68  
 .9R MAX-MACH= .61 THRUST FACTOR\* .935E+07 N = .210E+07 LB  
 .9R MIN-MACH\* .61

NASA LANGLEY FLIGHT DATA AH-1G ---- ROTOR PERFORMANCE AND LOADS

FLIGHT NO. 66 MU=0.000 TOTAL CQ= .000290 AMB TEMP= 2.2 C = 35.95 F  
 V= 0.3 KT MAST CQ= .000280 TEMP U60= 16.4 C = 61.49 F  
 RUN NO. 1 NZ= .980 G OMEGA= 33.902 RAD/SEC CAN TEMP\* 21.5 C = 70.62 F  
 TIME 53130.65 CLP= .00392 RPM/324= .999

ROTOR ANGLES THETA 3/4 (DEG) A0= 8.6 A1= -1.9 B1= -2.2 PEAK-TO-PEAK= 6.0  
 TEETER ANG (DEG) A0= -4.4 A1= 1.5 B1= -2.0 PEAK-TO-PEAK= 4.9

ROTOR LOADS (AMP/PHASE) DRAG BRACE (N/DEG) CHORO .449 (N-M/DEG) CHORD .803 (N-M/DEG) PITCH LINK (N/DEG) TORSION .449 (N-M/DEG)

MEAN HARMONIC	1	2	3	4	5	6	7	8	9	10	11	12	PEAK-TO-PEAK
38055.	1412./	58.9	377./	82.0	45./	81.5	1311./	-31.8	43./	-27.8			
	871./	11.3	131./	3.7	25./	33.1	510./	83.6	73./	-76.4			
	1413./	51.9	362./	45.8	55./	16.4	188./	10.2	31./	35.9			
	361./	-7.9	291./	-46.0	60./	-88.6	152./	-69.6	44./	-65.6			
	367./	90.0	153./	86.5	88./	73.3	110./	42.8	32./	86.7			
	518./	26.9	331./	29.6	127./	29.9	63./	56.9	3./	-5.9			
	298./	3.9	261./	-15.9	88./	8.2	97./	-34.6	14./	26.9			
	80./	16.8	28./	-75.6	9./	31.9	47./	-42.6	14./	16.4			
	85./	-89.6	183./	-17.7	93./	-32.4	126./	-26.2	18./	13.4			
	42./	2.1	65./	-80.9	47./	85.1	151./	32.2	30./	38.9			
	119./	24.3	53./	42.1	9./	-55.0	64./	80.0	8./	-67.5			
	116./	86.0	38./	-88.6	30./	68.9	16./	-79.6	8./	-44.3			
PEAK-TU-PEAK	6479.		2728.		663.		3808.		353.				

MEAN HARMONIC	1	2	3	4	5	6	7	8	9	10	11	12	PEAK-TO-PEAK
206.	300./	62.2	70./	17.8	87./	-5.4	148./	-21.2	142./	-47.9			
	142./	40.3	63./	88.3	74./	-73.2	92./	-63.2	21./	-70.3			
	161./	-79.6	66./	-89.8	56./	74.2	37./	57.0	51./	-83.8			
	240./	-53.6	62./	-58.5	23./	-66.6	50./	-35.7	70./	4.7			
	77./	-63.1	15./	-62.1	7./	1.0	23./	-57.3	76./	81.2			
	51./	-23.0	9./	-25.9	11./	35.0	19./	-6.4	57./	43.5			
	77./	-78.9	18./	-44.0	29./	-61.3	21./	36.7	47./	76.9			
	37./	-45.3	13./	-22.8	19./	-31.8	10./	13.2	12./	59.0			
	63./	-40.9	37./	-33.5	27./	-45.7	41./	-22.8	35./	-3.1			
	90./	-4.8	38./	18.7	28./	-21.6	43./	24.8	36./	41.8			
	18./	47.0	13./	28.2	9./	-59.9	13./	44.1	13./	74.1			
	17./	-56.2	8./	-26.8	11./	-79.1	11./	-28.6	4./	15.3			
PEAK-TO-PEAK	1345.		395.		403.		616.		643.				

FLIGHT NO. 066 AIRCRAFT TOTAL WT = 36092. N LOADED CG X= 5.04 M = 198.5 IN  
 RUN NO. 3 8114. LB Y= -.00 Z= 71.8  
 TIME 53977.10 (SEC)

AERODYNAMIC FLIGHT STATE

T. AIRSPEED= 108.4 KT  
 A/C MACH ND= .169

DYNAMIC PRES= 1.86 KPA = 38.9 PSF  
 STATIC PRES= 92.2 KPA = 1925. PSF  
 TOTAL TEMP= 270.6 DEG K = 487.1 DEG R  
 STATIC TEMP= 269.1 DEG K = 484.3 DEG R

BODY ALPHA\* 1.8 DEG  
 BODY BETA\* .5 DEG

DENSITY= 1.19 KG/M3 = .00232 SLUG/FT3  
 DENSITY ALT= 269. M = 883. FT  
 SONIC SPEED= 329.4 M/SEC = 1081. FPS  
 RATE OF CLIMB= -279. M/MIN = -916. FPM

INERTIAL FLIGHT STATE

AXIS	CG LIN (M/S)	VEL (FPS)	CG LIN ACC (G)	HUB LIN VEL (M/S)	VEL (FPS)	HUB LIN ACC (G)	AXIS	ANG POS (DEG)	ANG RATES (RAD/SEC)	ANG ACC (RAD/SEC <sup>2</sup> )
X	55.72	182.8	-.069	55.48	182.0	-.065	ROLL	-44.3	.000	.000
Y	.46	1.5	.002	.46	1.5	.005	PITCH	-3.8	.115	-.018
Z	1.75	5.7	-1.344	1.75	5.7	-1.341	YAW	299.8	-.122	-.001

CONTROL ANGLES

M.R. COLL= 9.4 DEG HORIZ FIN= 7.6 DEG  
 A1= -.4 DEG T.R. COLL\* 1.5 DEG  
 B1= 43 DEG PEDAL POS= 24 DEG

ROTOR PARAMETERS

HOVER TIP MACH= .70 SHAFT ALPHA= 1.8 DEG  
 CONTROL ALPHA= -2.5 DEG  
 TIP MAX-MACH= .86 DELTA PSI= -.5 DEG  
 TIP MIN-MACH\* .53  
 .9R MAX-MACH\* .79 ENGINE POWER= 377. KW = 506. HP  
 .9R MIN-MACH= .46 THRUST FACTOR= .883E+07 N = .199E+07 LB

NASA LANGLEY FLIGHT DATA AH-1G ---- ROTOR PERFORMANCE AND LOADS

FLIGHT NO. 66 MU= .242 TOTAL CQ= .000185 AMB TEMP\* -4.1 C = 24.63 F  
 RUN NO. 3 V= 108.4 KT MAST CQ= .000191 TEMP U60= 15.0 C = 59.01 F  
 TIME 53976.95 NZ= 1.341 G OMEGA= 34.298 RAD/SEC CAN TEMP= 4.4 C = 39.86 F  
 CLP= .00543 RPM/324= 1.011

ROTOR ANGLES THETA 3/4 (DEG) A0= 8.8 A1= -.4 B1= 4.5 PEAK-TO-PEAK- 9.3  
 TEETER ANG (DEG) A0= -.7 A1= -1.0 B1= .6 PEAK-TO-PEAK- 2.4

ROTOR LOADS (AMP/PHASE) DRAG BRACE (N/DEG) CHORD .449 (N-M/DEG) CHORD .803 (N-M/DEG) PITCH LINK (N/DEG) TORSION .449 (N-M/DEG)

	MEAN	43988.	12718.	2305.	-1830.	-277.				
HARMONIC-1	4780./	1.6	1230./	2.2	279./	-47.9	1859./	-31.0	307./	-55.1
2	848./	-47.5	407./	-52.1	37./	5.9	1575./	-30.9	173./	-18.9
3	2400./	47.8	653./	48.7	38./	14.6	311./	24.9	78./	38.2
4	625./	28.3	282./	10.7	75./	-8.3	431./	-75.1	63./	50.2
5	542./	-48.8	97./	-62.6	52./	-71.5	105./	-35.0	34./	-74.1
6	1276./	-38.8	896./	-46.4	170./	-44.3	152./	20.1	42./	40.0
7	28./	-43.3	82./	-42.4	28./	-72.7	67./	33.5	14./	56.2
8	134./	-54.2	103./	-36.2	28./	-62.4	64./	-12.0	8./	63.1
9	110./	74.5	96./	74.5	51./	79.9	76./	78.2	8./	3.8
10	54./	-49.8	249./	-21.9	120./	-29.5	54./	46.7	4./	35.4
11	105./	-46.6	131./	14.9	30./	27.9	64./	-50.6	6./	49.7
12	85./	-71.4	97./	-3.2	25./	-45.7	23./	-2.8	6./	87.0
PEAK-TO-PEAK	14879.		5677.		1109.		6185.		899.	

	BEAM .174 (N-M/DEG)	BEAM .350 (N-M/DEG)	BEAM .449 (N-M/DEG)	BEAM .606 (N-M/DEG)	BEAM .803 (N-M/DEG)					
MEAN	188.	130.	-48.	-319.	131.					
HARMONIC-1	557./	-33.0	404./	-63.6	428./	-66.1	430./	-69.7	253./	-87.5
2	302./	-47.8	247./	-71.0	279./	-69.5	249./	-70.2	100./	-83.4
3	64./	-22.6	69./	11.6	62./	41.2	74./	79.3	90./	88.1
4	376./	60.4	117./	44.3	63./	31.1	85./	62.3	152./	42.8
5	162./	-54.2	28./	-64.6	19./	64.3	34./	-50.2	76./	-81.1
6	115./	-78.9	10./	43.9	3./	-11.3	13./	24.3	53./	-56.1
7	51./	39.1	7./	36.2	26./	77.2	18./	-46.5	62./	-62.0
8	60./	18.4	7./	-87.3	20./	12.7	14./	-6.6	36./	2.4
9	53./	58.2	29./	83.9	13./	65.3	29./	-71.5	27./	-45.2
10	46./	2.4	14./	24.9	14./	-1.1	23./	24.4	21./	13.1
11	12./	22.2	17./	-30.0	4./	-35.7	9./	-3.6	7./	-78.3
12	59./	-81.7	18./	-61.0	15./	85.1	11./	-82.8	4./	82.2
PEAK-TO-PEAK	2443.		1255.		1354.		1295.		946.	

NASA LANGLEY FLIGHT DATA AH-1G ---- PADS PCM OATA

FLIGHT NO. 066 AIRCRAFT TOTAL WT = 36063. N LOADED CG X= 5.04 M = 198.6 IN  
 RUN NO. 3 8108. LB Y= -.00 : -.0  
 TIME 53980.80 (SEC) Z= 1.82 : 71.8

AERODYNAMIC FLIGHT STATE

DYNAMIC PRES- 1.84 KPA = 38.3 PSF  
 STATIC PRES= 92.4 KPA = 1930. PSF  
 TOTAL TEMP' 270.7 OEG K = 487.2 OEG R  
 STATIC TEMP- 269.2 OEG K = 484.5 OEG R

T. AIRSPEED- 107.4 KT  
 A/C MACH NO= .168

BODY ALPHA- 2.6 OEG DENSITY- 1.20 KG/M3 = .00232 SLUG/FT3  
 BODY BETA- 1.4 OEG DENSITY ALT- 249. M = 816. FT  
 SONIC SPEED- 329.4 M/SEC = 1081. FPS  
 RATE OF CLIMB\* -223. M/MIN = -733. FPM

INERTIAL FLIGHT STATE

AXIS	CG LIN VEL (M/S)	CG LIN ACC (G)	HUB LIN VEL (M/S)	HUB LIN ACC (G)	AXIS	ANG POS (DEG)	ANG RATES (RAD/SEC)	ANG ACC (RAD/SEC2)	
X	55.18	181.0	-0.078	54.91	180.2	-0.079	ROLL -40.4	-0.006	-0.002
Y	1.39	4.6	-0.009	1.38	4.5	-0.005	PITCH -2.8	.132	.001
Z	2.47	8.1	-1.439	2.48	8.1	-1.435	YAW 266.4	-0.126	.002

CONTROL ANGLES

M.R. COLL= 9.4 OEG HORIZ FIN- 7.4 OEG  
 A1= -.4 DEG T.R. COLL= 1.6 DEG  
 B1= 3.8 OEG PEDAL POS= 2.4 OEG

ROTOR PARAMETERS

HOVER TIP MACH= .70 SHAFT ALPHA- 2.6 OEG  
 CONTROL ALPHA- -1.2 OEG

TIP MAX-MACH- .86 DELTA PSI- -1.4 DEG  
 TIP MIN-MACH= .53  
 .9R MAX-MACH\* .79 ENGINE POWER- 351. KW = 470. HP  
 .9R MIN-MACH\* .46 THRUST FACTOR- .889E+07 N = .200E+07 LB

NASA LANGLEY FLIGHT DATA AH-1G ---- ROTOR PERFORMANCE AND LOADS

FLIGHT NO. 66 MU- .240 TOTAL CQ= .000170 AMB TEMP- -4.0 C = 24.82 F  
 V= 107.4 KT MAST CQ= .000176 TEMP U60= 15.0 C = 59.05 F  
 RUN NO. 3 NZ= 1.435 G OMEGA- 34.374 RAD/SEC CAN TEMP- 4.4 C = 39.86 F  
 TIME 53980.65 CLP= .00578 RPM/324= 1.013

ROTOR ANGLES

THETA 314 (DEG) A0= 8.7 A1= -2 B1= 3.8 PEAK-TO-PEAK- 8.1  
 TEETER ANG (DEG) A0= -7 A1= -5 B1= .9 PEAK-TO-PEAK= 2.2

ROTOR LOADS (AMP/PHASE)

	DRAG BRACE (N/DEG)	CHORO .449 (N-M/DEG)	CHORO .803 (N-M/DEG)	PITCH LINK (N/DEG)	TORSION .449 (N-M/DEG)
MEAN HARMONIC-1	44844.	12674.	2326.	-1723.	-281.
2	5824./ -3.5	1509./ -4.6	322./ -44.7	1848./ -30.0	288./ -55.0
3	451./ -22.5	314./ -42.7	40./ -24.0	1297./ -30.3	146./ -9.3
4	2460./ 37.3	696./ 40.7	40./ 2.3	348./ 24.0	68./ 49.1
5	739./ 44.1	339./ 31.1	59./ -6.2	405./ -79.8	68./ 47.4
6	592./ -53.2	164./ -75.9	73./ -86.8	62./ -78.9	49./ -63.4
7	1463./ -58.1	1037./ -60.3	202./ -58.9	241./ 5.8	60./ 22.4
8	222./ 66.8	131./ 27.1	61./ 55.0	50./ 9.9	11./ 37.0
9	100./ -72.4	83./ -68.5	32./ 40.4	35./ 3.4	10./ 38.3
10	54./ -59.8	60./ -86.0	50./ -65.1	110./ -87.7	11./ -24.6
11	16./ 74.0	231./ -34.0	119./ -48.7	98./ 1.1	12./ 19.3
12	116./ -66.6	89./ -47.9	7./ -76.5	46./ -55.0	7./ 20.1
PEAK-TO-PEAK	6./ 83.8	85./ 29.4	27./ 34.3	27./ 27.2	6./ -82.5
	14879.	5748.	1320.	5821.	812.
	BEAM .174 (N-M/DEG)	BEAM .350 (N-M/DEG)	BEAM .449 (N-M/DEG)	BEAM .606 (N-M/DEG)	BEAM .803 (N-M/DEG)
MEAN HARMONIC-1	299.	140.	-48.	-337.	164.
2	626./ -28.6	405./ -63.6	434./ -66.6	429./ -70.8	256./ -89.6
3	280./ -46.4	229./ -70.4	266./ -68.5	250./ -70.7	115./ -85.0
4	126./ -3.8	83./ 10.6	69./ 37.6	83./ 72.6	98./ 83.5
5	384./ 52.2	117./ 39.6	58./ 34.0	81./ 53.6	155./ 37.1
6	156./ -65.3	26./ -69.6	16./ 70.0	34./ -51.4	79./ -83.1
7	127./ 89.0	16./ 45.9	6./ -20.6	15./ 27.1	47./ -62.6
8	53./ 34.4	12./ 31.5	29./ 61.2	14./ -50.0	59./ -74.3
9	48./ 11.5	7./ 82.8	16./ 9.1	16./ -34.0	31./ -13.5
10	65./ 65.5	31./ -83.9	16./ 66.8	34./ -62.0	30./ -41.9
11	85./ -25.2	28./ 1.4	23./ -18.9	34./ 5.0	31./ -1.0
12	2./ -11.6	15./ -53.9	6./ -21.9	7./ -29.4	8./ 77.0
PEAK-TO-PEAK	48./ 89.6	13./ -71.8	20./ 81.2	12./ -87.0	4./ -55.6
	2615.	1220.	1329.	1301.	1021.

FLIGHT NO. 066 AIRCRAFT TOTAL WT = 36092. N LOADED CG X = 5.04 M = 198.5 IN  
 RUN NO. 3 8114. LB Y = -.00 = -.0  
 TIME 53985.40 (SEC) Z = 1.82 = 71.8

AERODYNAMIC FLIGHT STATE

T. AIRSPEED- 103.0 KT  
 A/C MACH NO = .161

DYNAMIC PRES = 1.69 KPA = 35.3 PSF  
 STATIC PRES = 92.5 KPA = 1931. PSF  
 TOTAL TEMP- 270.6 OEG K = 487.1 OEG R  
 STATIC TEMP- 269.2 OEG K = 484.6 OEG R

BODY ALPHA\* .5 DEG  
 BODY BETA- .2 DEG

DENSITY- 1.20 KG/M3 = .00232 SLUG/FT3  
 DENSITY ALT = 244. M = 801. FT  
 SONIC SPEED = 329.5 M/SEC = 1081. FPS  
 RATE OF CLIMB- -186. M/MIN = -609. FPM

INERTIAL FLIGHT STATE

AXIS	CG LIN VEL (M/S)	VEL (FPS)	CG LIN ACC (G)	HUB LIN VEL (M/S)	VEL (FPS)	HUB LIN ACC (G)	AXIS	ANG POS (DEG)	ANG RATES (RAD/SEC)	ANG ACC (RAD/SEC 2)
X	53.00	173.9	-.060	52.77	173.1	-.060	ROLL	-46.3	-.008	.012
Y	.22	.7	.008	.21	.7	.014	PITCH	-3.2	.113	-.001
Z	.47	1.5	-1.260	.47	1.5	-1.257	YAW	233.4	-.120	-.036

CONTROL ANGLES

M.R. COLL = 9.4 OEG  
 A1 = -.7 OEG  
 B1 = 4.1 OEG  
 HORIZ FIN\* = 7.5 OEG  
 T.R. COLL = 1.7 OEG  
 PEDAL POS = 2.4 DEG

ROTOR PARAMETERS

HOVER TIP MACH = .69  
 TIP MAX-MACH = .85  
 TIP MIN-MACH = .53  
 .9R MAX-MACH = .78  
 .9R MIN-MACH = .46  
 SHAFT ALPHA = .5 OEG  
 CONTROL ALPHA = -3.6 DEG  
 DELTA PSI = -.2 OEG  
 ENGINE POWER = 393. KW = 527. HP  
 THRUST FACTOR\* = .878E+07 N = .197E+07 LB

NASA LANGLEY FLIGHT DATA AH-1G ---- ROTOR PERFORMANCE AND LOADS

FLIGHT NO. 66 MU = .232 TOTAL CQ = .000195 AMB TEMP = -3.9 C = 24.92 F  
 RUN NO. 3 V = 103.0 KT MAST CQ = .000204 TEMP U60 = 15.0 C = 58.99 F  
 TIME 53985.25 NZ = 1.257 G OMEGA = 34.097 RAD/SEC CAN TEMP = 4.4 C = 39.86 F  
 CLP = .00514 RPM/324 = 1.005

ROTOR ANGLES

THETA 3/4 (DEG) A0 = 8.9 A1 = -.6 B1 = 4.3 PEAK-TO-PEAK- 9.1  
 TEETER ANG (DEG) A0 = -.6 A1 = -1.0 B1 = .5 PEAK-TO-PEAK- 2.4

ROTOR LOADS (AMP/PHASE)

	DRAG BRACE (N/DEG)	CHORD .449 (N-M/DEG)	CHORO .803 (N-M/DEG)	PITCH LINK (N/DEG)	TORSION .449 (N-M/DEG)
MEAN	42898.	12825.	2315.	-1809.	-271.
HARMONIC-1	4783./ -4	1192./ -6.1	254./ -46.6	1743./ -26.5	280./ -53.2
2	633./ -34.9	308./ -52.8	22./ -18.9	1398./ -30.8	159./ -22.7
3	2547./ 49.2	728./ 51.1	54./ 28.0	391./ 22.1	76./ 45.9
4	618./ 34.9	323./ 20.6	65./ -1.8	374./ -81.0	50./ 51.5
5	526./ -73.6	150./ -74.3	69./ -82.3	130./ -70.5	30./ 54.8
6	1120./ -37.5	757./ -43.9	145./ -41.3	136./ 6.2	34./ 22.8
7	90./ -56.2	222./ -17.9	22./ -29.3	61./ -81.0	12./ 46.8
8	205./ -86.1	172./ -45.1	49./ -78.4	57./ 6.4	6./ 43.3
9	81./ -83.4	187./ -68.0	46./ 74.4	71./ -51.5	5./ -11.7
10	68./ -53.5	166./ -26.7	91./ -29.4	133./ 59.2	15./ -87.7
11	102./ -9.1	99./ -9.6	27./ 1.7	61./ -53.5	4./ -85.9
12	136./ 15.2	129./ 16.3	46./ -4.7	10./ 71.7	4./ 63.3
PEAK-TO-PEAK	15411.	5320.	1158.	5578.	841.

	BEAM .174 (N-M/DEG)	BEAM .350 (N-M/DEG)	BEAM .449 (N-M/DEG)	BEAM .606 (N-M/DEG)	BEAM .803 (N-M/DEG)
MEAN	158.	134.	-33.	-296.	110.
HARMONIC-1	548./ -30.0	369./ -62.6	407./ -64.0	420./ -67.6	241./ -85.7
2	256./ -47.9	212./ -69.1	228./ -67.8	196./ -67.0	75./ -83.1
3	105./ 25.1	81./ 29.5	62./ 46.1	70./ -84.5	89./ -81.5
4	269./ 59.1	85./ 45.9	43./ 33.9	51./ 66.5	98./ 46.3
5	156./ 84.2	25./ -88.2	14./ -45.0	26./ 84.2	84./ -82.1
6	111./ 87.4	12./ 22.2	4./ 75.7	17./ 36.8	35./ -43.1
7	71./ -60.2	11./ -50.3	37./ -55.3	19./ -19.4	62./ -29.7
8	53./ -6	6./ 79.0	17./ 5.6	18./ -6.3	35./ 7.6
9	47./ -57.1	32./ -37.4	19./ -42.8	41./ -28.1	39./ -20.3
10	106./ 7.0	39./ 37.3	32./ 13.8	41./ 34.4	30./ 33.6
11	7./ 73.1	13./ -62.4	5./ 38.0	6./ -47.1	2./ 47.3
12	14./ -66.2	4./ -21.6	12./ -76.3	5./ -60.8	3./ -74.4
PEAK-TO-PEAK	2136.	1089.	1230.	1187.	878.



NASA LANGLEY FLIGHT DATA AH-1G ---- PADS PCM DATA

FLIGHT NO. 066 AIRCRAFT TOTAL WT = 36018. N LOADED CG X = 5.04 M = 198.6 IN  
 RUN NO. 4 8098. LB Y = -.00 Z = 1.82  
 TIME 54092.70 (SEC) Z = 1.82 M = 71.8

AERODYNAMIC FLIGHT STATE

T. AIRSPEED' 108.4 KT  
 A/C MACH NO = .170

DYNAMIC PRES = 1.86 KPA = 38.8 PSF  
 STATIC PRES = 91.7 KPA = 1916. PSF  
 TOTAL TEMP = 270.5 DEG K = 486.8 DEG R  
 STATIC TEMP = 268.9 DEG K = 484.0 DEG R

BODY ALPHA = 6.6 DEG  
 BODY BETA = 4.2 DEG

DENSITY = 1.19 KG/M3 = .00231 SLUG/FT3  
 DENSITY ALT = 315. M = 1033. FT  
 SONIC SPEED = 329.3 M/SEC = 1080. FPS  
 RATE OF CLIMB = -660. M/MIN = -2164. FPM

INERTIAL FLIGHT STATE

AXIS	CG LIN VEL (M/S)	CG LIN VEL (FPS)	CG LIN ACC (G)	HUB LIN VEL (M/S)	HUB LIN VEL (FPS)	HUB LIN ACC (G)	AXIS	ANG POS (DEG)	ANG RATES (RAD/SEC)	ANG ACC (RAD/SEC2)
X	55.27	181.3	-.073	54.90	180.1	-.075	ROLL	-46.1	.002	-.045
Y	4.06	13.3	-.058	4.06	13.3	-.062	PITCH	-9.9	.180	.013
Z	6.40	21.0	-1.604	6.41	21.0	-1.597	YAW	149.1	-.140	-.025

CONTROL ANGLES

M.R. COLL = 8.4 DEG HORIZ FIN = 7.1 DEG  
 A1 = -.2 DEG T.R. COLL = 1.3 DEG  
 B1 = 3.3 DEG PEDAL POS = 2.4 DEG

ROTOR PARAMETERS

HOVER TIP MACH = .71 SHAFT ALPHA\* 6.7 DEG  
 CONTROL ALPHA\* 3.4 DEG  
 TIP MAX-MACH = .88 DELTA PSI = -4.2 DEG  
 TIP MIN-MACH = .54  
 .9R MAX-MACH = .80 ENGINE POWER = 214. KW = 287. HP  
 .9R MIN-MACH = .47 THRUST FACTOR = .906E+07 N = .204E+07 LB

NASA LANGLEY FLIGHT DATA AH-1G ---- ROTOR PERFORMANCE AND LOADS

FLIGHT NO. 66 MU = .239 TOTAL CQ = .000101 AMB TEMP = -4.2 C = 24.37 F  
 RUN NO. 4 V = 108.4 KT MAST CQ = .000102 TEMP U60 = 15.1 C = 59.14 F  
 TIME 54092.56 NZ = 1.597 G OMEGA\* 34.808 RAD/SEC CAN TEMP = 3.6 C = 38.46 F  
 CLP = .00631 RPM/324 = 1.026

ROTOR ANGLES

THETA 314 (DEG) A0 = 7.6 A1 = -.3 B1 = 3.2 PEAK-TO-PEAK- 6.8  
 TEETER ANG (DEG) A0 = -.6 A1 = -.6 B1 = .9 PEAK-TO-PEAK- 2.4

ROTOR LOADS (AMP/PHASE)

	DRAG BRACE (N/DEG)	CHORO .449 (N-M/DEG)	CHORO .803 (N-M/DEG)	PITCH LINK (N/DEG)	TORSION .449 (N-M/DEG)
MEAN	48642.	12462.	2460.	-1201.	-218.
HARMONIC-1	5332./ 6.1	1338./ 9.7	221./ -39.9	1550./ -27.3	278./ -66.2
2	1260./ -64.2	644./ -64.4	46./ 76.9	700./ -29.3	86./ -4.2
3	2751./ 14.4	759./ 15.7	47./ -12.2	354./ 24.6	61./ 31.3
4	774./ 10.0	448./ -13.3	96./ -25.2	447./ 73.4	58./ 30.0
5	535./ -49.9	115./ -49.9	42./ -74.2	279./ -54.3	31./ -5.0
6	1252./ -70.3	837./ -74.0	124./ -75.0	181./ -15.0	44./ .5
7	172./ 78.5	26./ -56.5	55./ -82.0	112./ -31.9	17./ 9.4
8	133./ 32.5	81./ 82.8	23./ 62.9	29./ -72.9	13./ 16.5
9	82./ -89.9	95./ -60.3	7./ 52.6	97./ -68.2	9./ -43.8
10	64./ -47.3	215./ 60.4	99./ 56.2	75./ 11.6	1./ -53.8
11	77./ -56.7	76./ -37.7	21./ 14.2	36./ 63.9	8./ -66.1
12	83./ -5.3	41./ -15.3	16./ 1.1	38./ 68.6	5./ 34.2
PEAK-TO-PEAK	16655.	6233.	1061.	4848.	652.
	BEAM .174 (N-M/DEG)	BEAM .350 (N-M/DEG)	BEAM .449 (N-M/DEG)	BEAM .606 (N-M/DEG)	BEAM .803 (N-M/DEG)
MEAN	282.	128.	-63.	-374.	217.
HARMONIC-1	513./ -14.8	402./ -66.0	439./ -69.3	433./ -75.4	274./ 84.9
2	124./ -46.5	182./ -81.0	231./ -77.4	247./ -78.2	139./ 83.4
3	243./ -34.5	105./ -19.6	84./ 3.3	83./ 46.5	103./ 59.3
4	372./ 14.0	109./ 3.9	59./ 7.6	74./ 18.5	156./ 9.9
5	163./ -76.5	21./ -75.7	21./ 29.9	31./ -59.4	70./ 67.6
6	88./ -86.7	11./ 60.1	9./ 45.9	8./ 4.3	55./ -89.0
7	86./ -11.1	14./ -8.6	37./ 16.6	9./ 73.1	57./ 64.4
8	13./ -65.7	8./ -89.3	7./ 29.5	11./ -89.1	28./ -78.4
9	53./ 85.5	41./ -82.9	14./ -73.0	49./ -67.0	47./ -61.4
10	92./ -37.4	32./ -22.3	28./ -26.3	39./ -13.7	29./ -14.5
11	20./ -3.5	10./ 75.8	11./ -9.6	9./ 49.1	2./ -87.8
12	36./ 50.9	7./ 85.7	13./ 29.7	11./ 60.7	5./ -83.5
PEAK-TO-PEAK	2446.	1207.	1278.	1272.	1150.

FLIGHT NO. 066 AIRCRAFT TOTAL WT \* 35799. N LOADED CG X= 5.05 M = 198.7 IN  
 RUN NO. 7 8048. LB Y= -1.00 Z= -0.0  
 TIME 54391.20 (SEC) Z= 1.83 71.9

AERODYNAMIC FLIGHT STATE

T. AIRSPEED\* 102.7 KT  
 A/C MACH NO= .161

BODY ALPHA\* 10.6 DEG  
 BODY BETA\* 9.1 DEG

DYNAMIC PRES= 1.68 KPA = 35.2 PSF  
 STATIC PRES= 92.7 KPA = 1936. PSF  
 TOTAL TEMP- 270.2 DEG K = 486.3 DEG R  
 STATIC TEMP- 268.8 DEG K = 483.8 DEG R

DENSITY- 1.20 KG/M3 \* .00233 SLUG/FT3  
 DENSITY ALT= 203. M = 666. FT  
 SONIC SPEED- 329.2 M/SEC = 1080. FPS  
 RATE OF CLIMB- -634. M/MIN = -2081. FPM

INERTIAL FLIGHT STATE

AXIS	CG LIN VEL (M/S) (FPS)	CG LIN ACC (G)	HUB LIN VEL (M/S) (FPS)	HUB LIN ACC (G)	AXIS	ANG POS (DEG)	ANG RATES (RAD/SEC)	ANG ACC (RAD/SEC2)
X	51.29 168.3	-.097	50.65 166.2	-.098	ROLL	-52.6	-.077	.031
Y	8.22 27.0	-.113	8.07 26.5	-.096	PITCH	-12.7	.312	-.007
Z	9.61 31.5	-2.263	9.62 31.6	-2.242	YAW	335.4	-.166	-.005

CONTROL ANGLES M.R. COLL= 9.8 DEG HORIZ FIN= 6.7 DEG  
 A1= .1 DEG T.R. COLL= 1.9 DEG  
 B1= 1.9 DEG PEDAL POS= 2.9 DEG

ROTOR PARAMETERS

HOVER TIP MACH- .71 SHAFT ALPHA\* 10.8 DEG  
 CONTROL ALPHA= 8.8 DEG  
 TIP MAX-MACH\* .87 DELTA PSI = -9.0 DEG  
 TIP MIN-MACH- .55  
 .9R MAX-MACH= .80 ENGINE POWER\* 175. KW = 234. HP  
 .9R MIN-MACH\* .48 THRUST FACTOR\* .935E+07 N = .210E+07 LB

NASA LANGLEY FLIGHT DATA AH-1G ---- ROTOR PERFORMANCE AND LOADS

FLIGHT NO. 66 MU= .224 TOTAL CQ= .000079 AMB TEMP- -4.4 C = 24.14 F  
 RUN NO. 7 V= 102.7 KT MAST CQ= .000079 TEMP U60= 15.0 C = 59.05 F  
 TIME 54391.05 NZ= 2.242 G OMEGA- 35.194 RAD/SEC. CAN TEMP= 2.8 C = 37.06 F  
 CLP= .00857 RPM/324= 1.037

ROTOR ANGLES THETA 314 (DEG) AO= 8.2 A1= -.3 B1= 1.9 PEAK-TO-PEAK- 4.0  
 TEETER ANG (DEG) AO= -.6 A1= .5 B1= 1.1 PEAK-TO-PEAK= 2.4

ROTOR LOADS (AMP/PHASE) DRAG BRACE CHORD .449 CHORD .803 PITCH LINK TORSION .449  
 (N/DEG) (N-M/DEG) (N-M/DEG) (N-M/DEG)

	MEAN	51566.	12592.	2495.	-1276.	-164.
HARMONIC-1	10095./ -1.5	3098./ 6.6	432./ -21.6	2476./ 9.8	204./ -43.0	
2	2546./ 44.3	1145./ 69.5	156./ 68.6	1155./ -41.1	185./ -26.6	
3	4538./ -6.7	1275./ -8.8	151./ -7.1	585./ 57.4	97./ -67.0	
4	605./ -53.5	312./ -63.2	65./ -79.2	457./ 32.4	45./ -70.8	
5	763./ 61.3	435./ -86.4	136./ 85.5	364./ 65.6	41./ -56.5	
6	1422./ 69.0	1029./ 58.4	238./ 50.1	288./ -41.7	87./ -19.5	
7	398./ 52.2	285./ 75.1	109./ 68.0	208./ -58.7	28./ -1.5	
8	73./ -57.0	31./ -89.8	21./ 73.7	10./ 41.1	15./ -8.7	
9	31./ -19.3	69./ -18.3	44./ -12.1	152./ 59.7	17./ -67.7	
10	38./ 73.2	110./ -49.4	36./ -65.4	163./ -41.3	24./ -44.6	
11	28./ 63.7	39./ 78.4	42./ -75.4	89./ 5.1	13./ 23.7	
12	78./ -88.2	59./ -6.8	38./ 55.0	27./ 21.9	6./ 74.7	
PEAK-TO-PEAK	28123.	10204.	1612.	7971.	1014.	

	BEAM .174 (N-M/DEG)	BEAM .350 (N-M/DEG)	BEAM .449 (N-M/DEG)	BEAM .606 (N-M/DEG)	BEAM .803 (N-M/DEG)
MEAN	905.	196.	-24.	-404.	392.
HARMONIC-1	922./ 4.0	365./ -72.1	436./ -79.1	497./ -81.0	352./ 75.5
2	166./ 77.6	140./ -79.2	204./ -75.1	245./ -71.6	162./ -82.7
3	393./ -31.2	172./ -23.2	139./ -17.0	101./ 2.5	90./ 29.9
4	210./ -29.9	51./ -20.5	28./ -1.5	13./ 21.2	63./ -21.4
5	213./ 11.2	29./ 23.6	25./ -79.8	35./ 22.8	75./ 59.2
6	195./ .9	11./ -20.5	30./ -27.4	40./ -23.5	71./ -70.5
7	123./ -70.6	22./ -49.6	40./ -39.7	5./ -38.3	36./ 17.7
8	55./ 39.7	7./ 71.0	3./ 57.3	6./ -44.0	6./ -69.7
9	88./ 40.4	52./ 64.1	21./ 41.1	53./ 71.4	39./ 75.3
10	102./ -87.8	40./ -64.7	23./ -83.0	39./ -50.7	21./ -30.3
11	45./ -42.4	16./ -35.7	13./ -32.7	17./ 3.7	14./ 46.1
12	28./ -66.6	7./ -58.0	12./ -61.3	10./ -37.5	4./ 44.0
PEAK-TO-PEAK	3373.	993.	1280.	1406.	1203.

NASA LANGLEY FLIGHT DATA AH-1G ---- PADS PCM DATA

FLIGHT NO. 066 AIRCRAFT TOTAL WT = 35727. N LOADED CG X= 5.05 M = 198.6 IN  
 RUN NO. 8 8032. LB Y= -0.00 = -0.0  
 TIME 54498.70 (SEC) Z= 1.83 = 71.9

AERODYNAMIC FLIGHT STATE

T. AIRSPEED\* 106.2 KT  
 A/C MACH NO= .166

DYNAMIC PRES= 1.80 KPA = 37.6 PSF  
 STATIC PRES= 92.5 KPA = 1932. PSF  
 TOTAL TEMP= 270.4 DEG K = 486.8 OEG R  
 STATIC TEMP= 269.0 DEG K = 484.2 OEG R

BODY ALPHA\* 14.0 DEG  
 BODY BETA\* 14.2 OEG

DENSITY\* 1.20 KG/M3 = .00233 SLUG/FT3  
 DENSITY ALT= 230. M = 755. FT  
 SONIC SPEED\* 329.3 M/SEC = 1080. FPS  
 RATE OF CLIMB\* -994. M/MIN = -3262. FPM

INERTIAL FLIGHT STATE

AXIS	CG LIN VEL (M/S)	CG LIN VEL (FPS)	CG LIN ACC (G)	HUB LIN VEL (M/S)	HUB LIN VEL (FPS)	HUB LIN ACC (G)	AXIS	ANG POS (DEG)	ANG RATES (RAD/SEC)	ANG ACC (RAD/SEC2)
X	51.51	169.0	-0.100	50.84	166.8	-0.108	ROLL	-51.6	-0.142	-0.016
Y	13.02	42.7	-0.208	12.74	41.8	-0.196	PITCH	-21.2	0.326	0.006
Z	12.82	42.1	-2.351	12.83	42.1	-2.325	YAW	99.1	-0.221	-0.043

CONTROL ANGLES

M.R. COLL= 8.3 OEG  
 A1= .1 OEG  
 B1= 1.6 DEG  
 HORIZ FIN= 6.5 OEG  
 T.R. COLL= 2.0 OEG  
 PEDAL POS= 3.5 OEG

ROTOR PARAMETERS

HOVER TIP MACH= .73  
 TIP MAX-MACH= .89  
 TIP MIN-MACH\* .56  
 .9R MAX-MACH- .82  
 .9R MIN-MACH\* .49  
 SHAFT ALPHA= 14.2 DEG  
 CONTROL ALPHA= 12.6 DEG  
 DELTA PSI= -14.1 OEG  
 ENGINE POWER 44. KW = 59. HP  
 THRUST FACTOR- .966E+07 N = .217E+07 LB

NASA LANGLEY FLIGHT DATA AH-1G ---- ROTOR PERFORMANCE AND LOADS

FLIGHT NO. 66 MU= .227 TOTAL CQ= .000019 AM8 TEMP- -4.2 C = 24.50 F  
 RUN NO. 8 V= 106.2 KT MAST CQ= .000009 TEMP U60= 14.9 C = 58.80 F  
 TIME 54498.55 NZ= 2.325 G OMEGA' 35.906 RAD/SEC CAN TEMP= 2.4 C = 36.37 F  
 CLP= .00856 RPM/324= 1.058

ROTOR ANGLES

THETA 314 (DEG) AO= 7.0 A1= -.4 B1= 1.3 PEAK-TO-PEAK= 2.6  
 TEETER ANG (DEG) AO= -.5 A1= .9 B1= .9 PEAK-TO-PEAK= 2.3

ROTOR LOADS (AMP/PHASE)

	DRAG BRACE (N/DEG)	CHORD .449 (N-M/DEG)	CHORD .803 (N-M/DEG)	PITCH LINK (N/DEG)	TORSION .449 (N-M/DEG)
MEAN HARMONIC-1	56934.	12291.	2740.	-639.	-117.
2	8398./ -11.7	2613./ -1.6	334./ -31.7	2680./ 8.0	206./ -50.6
3	2677./ 35.9	1271./ 52.7	145./ 51.3	831./ -39.2	160./ -32.6
4	3868./ -45.6	1091./ -46.3	132./ -64.9	542./ 25.4	128./ -76.0
5	742./ -65.5	561./ -76.2	108./ -79.2	675./ -7.7	46./ -44.9
6	535./ 2.7	289./ 51.6	83./ 28.8	283./ 14.9	25./ -49.1
7	1078./ 7.6	795./ -5.8	152./ -10.1	174./ 62.3	56./ -80.6
8	330./ -63.0	173./ 21.4	88./ .5	210./ 38.1	10./ -75.8
9	208./ 71.7	76./ 70.3	36./ -81.5	12./ 33.2	6./ -69.2
10	160./ 55.5	70./ -32.2	29./ 69.4	138./ 17.7	6./ -86.3
11	103./ -6.6	100./ 55.0	53./ 66.3	29./ 20.7	7./ -69.5
12	133./ 78.0	64./ 26.4	39./ -20.0	26./ 82.7	7./ 90.0
PEAK-TO-PEAK	84./ -25.6	94./ 88.1	10./ -49.4	10./ 52.9	5./ -17.7
	24071.	9276.	1607.	8475.	851.
	BEAM .174 (N-M/DEG)	BEAM .350 (N-M/DEG)	BEAM .449 (N-M/DEG)	BEAM .606 (N-M/DEG)	BEAM .803 (N-M/DEG)
MEAN HARMONIC-1	798.	152.	-67.	-442.	423.
2	838./ -.9	387./ -84.7	466./ 89.7	526./ 86.5	375./ 60.9
3	93./ 84.4	133./ 68.7	190./ 79.5	218./ 89.1	125./ 82.9
4	424./ -63.2	160./ -58.6	133./ -53.9	113./ -29.5	114./ -14.4
5	428./ -59.9	99./ -68.5	35./ -72.7	52./ -55.2	111./ -75.6
6	189./ -2.0	21./ 5.6	13./ 58.8	35./ 21.8	60./ 44.2
7	139./ -53.2	4./ -33.7	24./ -83.1	25./ -80.4	74./ 64.5
8	171./ 50.0	24./ 64.6	53./ 72.9	11./ -89.5	52./ -62.0
9	73./ 16.8	7./ 54.4	19./ 40.8	8./ -8.2	5./ 24.2
10	76./ -12.7	49./ 7.6	18./ 10.4	49./ 17.7	45./ 29.8
11	56./ -17.0	19./ .1	19./ -4.7	19./ 25.2	14./ 36.1
12	25./ 62.2	13./ 54.4	12./ 48.4	17./ 78.7	13./ -78.7
PEAK-TO-PEAK	28./ 62.0	2./ 56.6	12./ 44.5	11./ 56.7	9./ 71.3
	3229.	1087.	1281.	1359.	1344.

FLIGHT NO. 066 AIRCRAFT TOTAL WT = 35619. N LOADED CG X = 5.05 M = 198.6 IN  
 RUN NO. 10 8008. LB Y = -0.00 = -0.0  
 TIME 54664.40 (SEC) Z = 1.83 = 71.9

AERODYNAMIC FLIGHT STATE

T. AIRSPEED- 100.5 KT  
 A/C MACH NO = .157

BODY ALPHA- .8 DEG  
 BODY BETA = 1.9 DEG

DYNAMIC PRES- 1.63 KPA = 34.0 PSF  
 STATIC PRES- 93.5 KPA = 1953. PSF  
 TOTAL TEMP- 269.9 DEG K = 485.9 DEG R  
 STATIC TEMP = 268.6 DEG K = 483.5 DEG R  
 DENSITY- 1.21 KG/M3 = .00236 SLUG/FT3  
 DENSITY ALT- 100. M = 328. FT  
 SONIC SPEED = 329.1 M/SEC = 1080. FPS  
 RATE OF CLIMB- -754. M/MIN = -2472. FPM

INERTIAL FLIGHT STATE

AXIS	CG LIN (M/S)	VEL (FPS)	CG LIN (G)	ACC	HUB LIN (M/S)	VEL (FPS)	HUB LIN (G)	ACC	AXIS	ANG POS (DEG)	ANG RATES (RAD/SEC)	ANG ACC (RAD/SEC2)
X	51.67	169.5	-0.096		51.26	168.2	-0.112		ROLL	59.4	.056	.024
Y	1.76	58	-0.013		1.87	6.1	-0.015		PITCH	-12.0	.202	.068
Z	.74	2.4	-1.523		.75	2.5	-1.514		YAW	253.5	.161	.013

CONTROL ANGLES

M.R. COLL = 93 DEG  
 A1 = -0.2 DEG  
 B1 = 2.2 DEG  
 HORIZ FIN = 6.7 DEG  
 T.R. COLL = -1.1 DEG  
 PEDAL POS = -1.6 DEG

ROTOR PARAMETERS

HOVER TIP MACH = .70  
 TIP MAX-MACH = .86  
 TIP MIN-MACH = .54  
 .9R MAX-MACH = .79  
 .9R MIN-MACH = .47  
 SHAFT ALPHA = .8 DEG  
 CONTROL ALPHA = -1.3 DEG  
 DELTA PSI = -2.1 DEG  
 ENGINE POWER = 297. KW = 398. HP  
 THRUST FACTOR = .906E+07 N = .204E+07 LB

NASA LANGLEY FLIGHT DATA AH-1G ---- ROTOR PERFORMANCE AND LOADS

FLIGHT NO. 66 MU = .224 TOTAL CQ = .000141 AMB TEMP -4.6 C = 23.79 F  
 RUN NO. 10 V = 100.5 KT MAST CQ = .000151 TEMP U60 = 14.5 C = 58.03 F  
 TIME 54664.28 NZ = 1.514 G OMEGA\* 34.410 RAD/SEC CAN TEMP -2.4 C = 36.37 F  
 CLP = .00594 RPM/324 = 1.014

ROTOR ANGLES THETA 3/4 (DEG) A0 = 8.3 A1 = -0.3 B1 = 2.2 PEAK-TO-PEAK- 5.0  
 TEETER ANG (DEG) A0 = -0.7 A1 = -0.3 B1 = .9 PEAK-TO-PEAK- 2.0

ROTOR LOADS (AMP/PHASE) DRAG BRACE CHORD .449 CHORD .803 PITCH LINK TORSION .449  
 (N/DEG) (N-M/DEG) (N-M/DEG) (N-M/DEG)

	45374.	13159.	2343.	-1509.	-264.
MEAN HARMONIC-1	5511./ 9.5	1350./ 10.0	244./ -45.9	1249./ -39.8	255./ -69.7
2	787./ -23.9	511./ -35.8	30./ -39.8	525./ 39.1	102./ 56.0
3	2689./ 40.5	762./ 43.1	76./ 18.0	383./ 65.8	69./ 71.4
4	287./ 53.7	206./ 34.4	40./ -1.9	274./ -42.6	29./ 81.8
5	629./ -63.9	225./ -75.4	99./ -83.0	265./ 88.4	19./ 28.2
6	1951./ -19.9	1408./ -26.1	333./ -29.4	418./ 13.6	76./ 35.8
7	445./ -27.4	95./ 80.0	57./ -39.1	51./ -63.5	16./ 7.8
8	130./ -67.1	28./ 43.3	22./ 31.4	91./ 70.3	11./ 18.3
9	144./ 26.8	269./ -9.0	118./ -25.5	212./ -40.9	19./ 16.2
10	49./ 55.4	204./ -11.7	121./ -23.2	166./ 68.4	18./ 78.9
11	84./ 15.8	74./ 72.7	53./ -78.2	71./ -38.9	8./ -19.2
12	161./ -23.6	101./ -1.1	50./ -7.1	38./ 39.7	12./ -51.7
PEAK-TO-PEAK	18283.	6958.	1653.	4117.	767.

BEAM .174 BEAM .350 BEAM .449 BEAM .606 BEAM .803  
 (N-M/DEG) (N-M/DEG) (N-M/DEG) (N-M/DEG) (N-M/DEG)

	338.	136.	-59.	-371.	205.
MEAN HARMONIC-1	361./ -3.9	332./ -62.7	384./ -64.5	414./ -65.9	279./ -78.2
2	91./ 3.5	160./ -57.6	211./ -56.5	238./ -63.3	171./ -87.8
3	264./ 19.3	121./ 26.4	86./ 36.8	67./ 84.5	101./ -71.5
4	230./ 76.2	81./ 67.0	51./ 58.9	56./ 84.2	121./ 61.2
5	176./ 80.5	21./ -80.6	15./ -28.9	25./ -88.9	88./ -65.7
6	233./ -56.2	29./ 39.9	38./ -29.7	31./ 76.4	8./ 55.7
7	124./ -52.0	27./ -55.6	57./ -47.9	23./ -14.3	91./ -23.2
8	91./ 36.9	18./ -75.5	31./ 41.9	20./ -14.4	39./ 18.1
9	127./ -57.0	70./ -34.8	37./ -52.4	75./ -26.3	65./ -22.3
10	143./ 19.7	45./ 53.8	44./ 23.7	50./ 51.8	31./ 40.8
11	21./ -79.4	17./ -27.3	12./ 68.4	10./ -12.9	5./ -72.7
12	35./ -18.7	9./ -27.9	14./ -44.8	7./ 7.5	5./ -31.0
PEAK-TO-PEAK	2198.	967.	1179.	1278.	1048.

FLIGHT NO. 066 AIRCRAFT TOTAL WT = 35074. N LOADED CG X= 5.04 M = 198.6 IN  
 RUN NO. 18 7885. LB Y= -0.00 = -0.0  
 TIME 5S591.00 (SEC) Z= 1.83 = 72.1

AERODYNAMIC FLIGHT STATE

DYNAMIC PRES= 2.01 KPA = 41.9 PSF  
 STATIC PRES= 93.4 KPA = 1951. PSF  
 TOTAL TEMP= 270.7 OEG K = 487.3 OEG R  
 STATIC TEMP= 269.1 DEG K = 484.4 OEG R  
 T. AIRSPEED= 111.7 KT  
 A/C MACH NO= .175  
 DENSITY= 1.21 KG/M3 = .00235 SLUG/FT3  
 BODY ALPHA= 4.3 OEG DENSITY ALT= 135. M = 443. FT  
 BODY BETA= 2.5 OEG SONIC SPEED= 329.4 M/SEC = 1081. FPS  
 RATE OF CLIMB= -438. M/MIN = -1436. FPM

INERTIAL FLIGHT STATE

AXIS	OG LIN VEL (M/S)	OG LIN VEL (FPS)	CG LIN ACC (G)	HUB LIN VEL (M/S)	HUB LIN VEL (FPS)	HUB LIN ACC (G)	AXIS	ANG POS (DEG)	ANG RATES (RAD/SEC)	ANG ACC (RAD/SEC2)
X	57.26	187.9	-0.074	57.02	187.1	-0.071	ROLL	1.1	.005	-0.061
Y	2.55	8.4	-0.026	2.56	8.4	-0.038	PITCH	-2.9	.116	-0.014
Z	4.30	14.1	-1.448	4.31	14.1	-1.445	YAW	36.3	-0.004	-0.038

CONTROL ANGLES

M.R. COLL= 86 OEG HORIZ FIN= 7.4 OEG  
 A1= .1 OEG T.R. COLL= .5 DEG  
 B1= 3.8 OEG PEDAL POS= .7 OEG

ROTOR PARAMETERS

HOVER TIP MACH= .70 SHAFT ALPHA= 4.3 OEG  
 CONTROL ALPHA= .5 DEG  
 TIP MAX-MACH= .87 DELTA PSI= -2.6 OEG  
 TIP MIN-MACH= .52  
 .9R MAX-MACH= .80 ENGINE POWER= 297. KW = 399. HP  
 .9R MIN-MACH= .46 THRUST FACTOR= .906E+07 N = .204E+07 LB

NASA LANGLEY FLIGHT DATA AH-1G ---- ROTOR PERFORMANCE AND LOADS

FLIGHT NO. 66 MU= .248 TOTAL CQ= .000140 AM8 TEMP= -4.1 C = 24.70 F  
 RUN NO. 18 V= 111.7 KT MAST CQ= .000138 TEMP U60= 14.2 C = 57.52 F  
 TIME 55590.86 NZ= 1.445 G OMEGA\* 34.591 RAD/SEC CAN TEMP= 2.0 C = 35.67 F  
 CLP= .00552 RPM/324= 1.019

ROTOR ANGLES

THETA 3/4 (DEG) A0= 7.6 A1= .1 B1= 4.0 PEAK-TO-PEAK= 8.0  
 TEETER ANG (DEG) A0= -0.8 A1= -1.0 B1= .9 PEAK-TO-PEAK= 2.7

ROTOR LOADS (AMP/PHASE)

	DRAG BRACE (N/DEG)	CHORO .449 (N-M/DEG)	CHORO .803 (N-M/DEG)	PITCH LINK (N/DEG)	TORSION .449 (N-M/DEG)
MEAN	46950.	13431.	2323.	-1526.	-274.
HARMONIC-1	4605./ 5.8	1210./ 3.3	258./ -45.6	1962./ -41.0	331./ -63.3
2	608./ -69.1	338./ -81.3	30./ -14.1	1257./ -41.8	137./ -15.8
3	2398./ 9.0	671./ 18.5	42./ -27.4	235./ 8.8	53./ 21.1
4	656./ 43.1	342./ 26.8	49./ -34.8	364./ 75.7	63./ 35.2
5	561./ -14.4	158./ -2.0	15./ -43.1	78./ -7.6	41./ -43.5
6	1107./ -53.3	766./ -60.0	147./ -56.9	163./ 37.0	35./ 38.0
7	274./ -68.8	65./ 75.8	75./ 87.4	115./ 10.6	10./ 41.5
8	99./ 36.9	86./ 7.1	40./ 61.5	24./ 79.0	10./ 32.1
9	55./ -12.6	47./ -82.9	40./ -79.6	110./ -68.6	11./ -17.4
10	60./ 38.3	276./ 78.2	123./ 78.9	98./ 15.2	10./ -8.4
11	108./ 78.0	64./ 38.5	23./ .9	33./ 40.1	8./ -9.2
12	82./ -55.1	25./ -75.0	8./ -36.0	20./ -56.7	2./ 81.5
PEAK-TO-PEAK	13786.	4994.	1163.	6293.	862.
	BEAM .174 (N-M/DEG)	BEAM .350 (N-M/DEG)	BEAM .449 (N-M/DEG)	BEAM .606 (N-M/DEG)	BEAM .803 (N-M/DEG)
MEAN	134.	98.	-91.	-387.	174.
HARMONIC-1	532./ -36.1	445./ -66.4	471./ -69.1	444./ -74.3	251./ -89.5
2	277./ -57.0	249./ -82.6	291./ -80.4	302./ -79.6	160./ 88.9
3	168./ -68.7	78./ -32.8	65./ 3.4	91./ 57.4	112./ 63.1
4	403./ 27.3	118./ 14.9	58./ 13.9	95./ 27.5	182./ 19.0
5	153./ -36.9	17./ -47.0	32./ 25.6	33./ -30.1	58./ 63.6
6	84./ -57.2	12./ -86.2	20./ 40.0	4./ -41.3	60./ 88.3
7	113./ 7.3	15./ 20.7	46./ 39.6	19./ 71.3	81./ 74.5
8	31./ -46.8	9./ -70.2	8./ 34.0	20./ -69.7	42./ -77.6
9	64./ -87.4	46./ -75.0	15./ -82.4	58./ -62.1	58./ -56.2
10	64./ -34.3	25./ -18.5	13./ -19.4	36./ -6.5	27./ -5.5
11	18./ -7.3	1./ -9.0	6./ -19.9	7./ 7.4	5./ -47.2
12	40./ 30.8	7./ 36.4	13./ 36.4	8./ 35.5	2./ 28.0
PEAK-TO-PEAK	2570.	1415.	1425.	1411.	1151.

FLIGHT NO. 066 AIRCRAFT TOTAL WT = 34997. N LOADED CG X = 5.04 M = 198.6 IN  
 RUN NO. 19 7866. LB Y = -.00 Z = 1.83  
 TIME 55612.20 (SEC)

AERODYNAMIC FLIGHT STATE

T. AIRSPEED\* 111.7 KT  
 A/C MACH NO\* .175

BODY ALPHA\* 5.4 DEG  
 BODY BETA\* 6.1 DEG

DYNAMIC PRES = 2.01 KPA = 42.1 PSF  
 STATIC PRES = 93.7 KPA = 1957. PSF  
 TOTAL TEMP\* 270.8 DEG K = 487.4 DEG R  
 STATIC TEMP- 269.1 DEG K = 484.4 DEG R  
 DENSITY- 1.21 KG/M3 = .00235 SLUG/FT3  
 DENSITY ALT = 105. M = 345. FT  
 SONIC SPEED- 329.4 M/SEC = 1081. FPS  
 RATE OF CLIMB- -468. M/MIN = -1535. FPM

INERTIAL FLIGHT STATE

AXIS	CG LIN VEL (M/S)	CG LIN ACC (G)	HUB LIN VEL (M/S)	HUB LIN ACC (G)	AXIS	ANG POS (DEG)	ANG RATES (RAD/SEC)	ANG ACC (RAD/SEC2)
X	56.91	186.7	-0.127	56.40	ROLL	.7	0.01	-0.004
Y	6.04	19.8	-0.083	6.04	PITCH	-2.4	.250	.231
Z	5.35	17.5	-1.835	5.36	YAW	113.9	-0.007	.001

CONTROL ANGLES

M.R. COLL = 8.5 DEG  
 A1 = .0 DEG  
 B1 = 1.3 DEG  
 HORIZ FIN = 6.5 DEG  
 T.R. COLL = .8 DEG  
 PEDAL POS = 1.2 DEG

ROTOR PARAMETERS

HOVER TIP MACH = .70  
 SHAFT ALPHA = 5.4 DEG  
 CONTROL ALPHA = 4.2 DEG  
 TIP MAX-MACH = .88  
 TIP MIN-MACH = .53  
 .9R MAX-MACH = .81  
 .9R MIN-MACH = .46  
 DELTA PSI = -6.1 OEG  
 ENGINE POWER = 277. KW = 372. HP  
 THRUST FACTOR = .917E+07 N = .206E+07 LB

NASA LANGLEY FLIGHT DATA AH-1G ---- ROTOR PERFORMANCE AND LOADS

FLIGHT NO. 66 MU = .246 TOTAL CQ = .000128 AMB TEMP = -4.0 C = 24.76 F  
 RUN NO. 19 V = 111.7 KT MAST CQ = .000117 TEMP U60 = 14.5 C = 58.11 F  
 TIME 55612.06 NZ = 1.821 G OMEGA = 34.914 RAD/SEC CAN TEMP = 2.0 C = 35.67 F  
 CLP = .00684 RPM/324 = 1.029

ROTOR ANGLES

THETA 314 (DEG)  
 TEETER ANG (DEG)  
 A0 = 7.2 A1 = -.2 B1 = 1.3 PEAK-TO-PEAK 2.6  
 A0 = -.8 A1 = .8 B1 = 1.0 PEAK-TO-PEAK- 2.2

ROTOR LOADS (AMP/PHASE)

	DRAG BRACE (N/DEG)	CHORD .449 (N-M/DEG)	CHORD .803 (N-M/DEG)	PITCH LINK (N/DEG)	TORSION .449 (N-M/DEG)
MEAN	49259.	13330.	2336.	-1055.	-231.
HARMONIC-1	5929./ 4.1	1568./ 5.8	266./ -53.2	1324./ -32.8	265./ -72.4
2	1058./ -61.2	672./ -69.4	75./ -74.7	194./ 50.7	40./ 53.3
3	3225./ -9.9	886./ -5.3	76./ -29.4	393./ 24.7	47./ 53.6
4	611./ 12.6	312./ -8.3	45./ -55.9	358./ 43.0	51./ 18.5
5	425./ -56.0	192./ -47.0	45./ 74.3	193./ -54.2	24./ 5.7
6	1614./ -70.0	1058./ -74.5	230./ -75.3	190./ -28.8	42./ -3.5
7	101./ 54.6	39./ -28.1	48./ -79.0	158./ -11.3	12./ 18.2
8	104./ -23.9	63./ -53.4	16./ -76.2	55./ 68.3	10./ 14.9
9	91./ -60.5	160./ 82.7	31./ 79.3	78./ -87.1	7./ -39.5
10	34./ 45.1	137./ 44.8	71./ 53.6	134./ 1.6	10./ -6.2
11	61./ 48.6	63./ -7.8	21./ 20.0	85./ 36.9	8./ 80.0
12	77./ 7.2	44./ 12.5	18./ 39.9	52./ 76.3	5./ 64.9
PEAK-TO-PEAK	16968.	7138.	1252.	3631.	676.
	BEAM .174 (N-M/DEG)	BEAM .350 (N-M/DEG)	BEAM .449 (N-M/DEG)	BEAM .606 (N-M/DEG)	BEAM .803 (N-M/DEG)
MEAN	548.	125.	-99.	-433.	294.
HARMONIC-1	449./ -7.4	421./ -69.0	473./ -72.2	490./ -76.1	314./ 84.1
2	49./ -64.5	163./ -86.6	229./ -81.1	261./ -80.9	182./ 85.0
3	366./ -31.7	146./ -28.4	109./ -7.2	91./ 39.4	116./ 57.6
4	380./ -8.6	111./ -17.4	64./ -4.3	70./ -13.6	172./ -9.8
5	91./ 86.4	16./ -82.7	22./ 13.3	24./ -51.8	75./ 40.4
6	118./ 66.2	4./ 37.6	6./ -82.4	6./ 76.9	33./ 72.8
7	115./ -4.9	20./ 14.6	51./ 16.5	12./ 36.3	70./ 51.3
8	22./ -15.0	5./ 67.3	15./ 9.0	13./ 72.0	30./ 77.2
9	57./ 67.4	44./ 78.0	19./ 89.5	49./ -88.2	46./ -81.4
10	112./ -62.5	37./ -38.0	35./ -55.4	46./ -34.5	34./ -29.6
11	45./ .5	19./ 35.8	14./ -20.1	15./ 19.4	7./ 45.6
12	50./ 56.1	12./ 57.9	14./ 34.2	13./ 55.3	9./ 88.4
PEAK-TO-PEAK	2145.	1226.	1345.	1336.	1265.

FLIGHT NO. 066 AIKCRAFT TOTAL WT = 34995. N LOADED CG X= 5.04 M = 198.6 IN  
 RUN NO. 19 7868. LB Y= -.00 Z = -.0  
 TIME 55613.10 (SEC) Z= 1.83 \* = 72.1

AERODYNAMIC FLIGHT STATE

CYNAMIC PRES= 1.84 KPA \* 38.5 PSF  
 STATIC PRES= 93.7 KPA \* 1958. PSF  
 TOTAL TEMP\* 270.3 DEG K = 486.6 DEG R  
 STATIC TEMP= 268.8 OEG K = 483.9 DEG R  
 T. AIRSPEED\* 106.8 KT  
 A/C MACH NO\* .167  
 BODY ALPHA= 11.4 DEG DENSITY= 1.22 KG/M3 = .00236 SLUG/FT3  
 BODY BETA= 6.9 DEG DENSITY ALT= 86. M = 283. FT  
 SONIC SPEED= 329.2 M/SEC = 1080. FPS  
 RATE OF CLIMB= 52. M/MIN = 170. FPM

INERTIAL FLIGHT STATE

AXIS	CG LIN VEL (M/S)	CG LIN VEL (FPS)	CG LIN ACC (G)	HUB LIN VEL (M/S)	HUB LIN VEL (FPS)	HUB LIN ACC (G)	AXIS	ANG PUS (DEG)	ANG RATES (RAD/SEC)	ANG ACC (RAD/SEC2)
X	53.45	175.4	-.110	52.84	173.4	-.110	ROLL	.7	-.001	-.057
Y	6.53	21.4	-.100	6.53	21.4	-.111	PITCH	12.4	.298	.001
Z	10.82	35.5	-2.269	10.84	35.6	-2.250	YAW	113.7	-.024	-.024

CONTROL ANGLES

M.R. COLL= 8.5 OEG HORIZ FIN\* 6.6 DEG  
 A1= .3 DEG T.R. COLL= .8 DEG  
 B1= 1.8 OEG PEDAL POS= 1.1 DEG

ROTOR PARAMETERS

HOVER TIP MACH= .72 SHAFT ALPHA= 11.6 OEG  
 CONTROL ALPHA= 9.8 OEG  
 TIP MAX-MACH= .88 DELTA PSI= -7.0 DEG  
 TIP MIN-MACH= .55  
 .9R MAX-MACH\* .81 ENGINE POWER\* 124. KW = 166. HP  
 .9R MIN-MACH= .48 THRUST FACTOR\* .955E+07 N = .215E+07 LB

NASA LANGLEY FLIGHT DATA AH-1G ---- ROTOR PERFORMANCE AND LOADS

FLIGHT NO. 66 MU= .230 TOTAL CQ= .000053 AM8 TEMP= -4.3 C = 24.25 F  
 RUN NO. 19 V= 106.8 KT MAST CQ= .000044 TEMP U60= 14.6 C = 58.26 F  
 TIME 55612.96 NZ= 2.250 G OMEGA= 35.638 RAD/SEC CAN TEMP= 2.0 C = 35.67 F  
 CLP\* .0081C RPM/324= 1.053

ROTOR ANGLES

THETA 3/4 (DEG) A0= 7.2 A1= -.2 B1= 1.7 PEAK-TO-PEAK= 3.3  
 TEETER ANG (DEG) A0= -6 A1= .5 B1= .9 PEAK-TO-PEAK= 1.9

ROTOR LOADS (AMP/PHASE)

	DRAG BRACE (N/DEG)	CHORD .449 (N-M/DEG)	CHORD .803 (N-M/DEG)	PITCH LINK (N/DEG)	TORSION .449 (N-M/DEG)
MEAN	54426.	12862.	2479.	-1118.	-160.
HARMONIC-1	7800./ 3.0	2447./ 11.9	322./ -26.6	2728./ 5.1	238./ -42.2
2	1749./ 57.6	1050./ 85.6	121./ 87.7	1205./ -30.1	165./ -24.2
3	3980./ -2.0	1139./ -2.0	139./ -9.5	305./ 32.5	68./ -35.5
4	451./ 8.3	343./ -22.3	43./ -54.1	479./ 23.5	42./ -38.6
5	541./ -79.3	355./ -53.1	100./ -62.6	288./ -67.7	48./ -41.1
6	838./ -84.7	579./ 83.4	98./ 74.6	234./ 7.6	62./ 5.0
7	113./ 64.9	175./ -53.6	83./ -73.5	172./ 7.6	25./ -9.5
8	74./ -23.5	70./ 1.1	22./ 77.9	49./ 70.1	15./ -16.1
9	17./ -77.8	42./ 78.4	12./ -47.6	87./ -1.8	10./ 8.1
10	60./ 81.5	95./ 18.6	50./ 26.8	124./ 7.4	10./ 37.5
11	44./ -50.9	66./ -28.3	36./ -30.1	74./ 48.7	7./ 71.9
12	67./ 78.1	57./ 49.2	26./ 56.1	39./ -75.1	8./ 59.0
PEAK-TO-PEAK	21210.	8331.	1310.	7384.	974.

	BEAM .174 (N-M/DEG)	BEAM .350 (N-M/DEG)	BEAM .449 (N-M/DEG)	BEAM .606 (N-M/DEG)	BEAM .803 (N-M/DEG)
MEAN	754.	155.	-64.	-431.	399.
HARMONIC-1	704./ 4.6	390./ -70.7	462./ -74.1	519./ -76.1	334./ 81.5
2	100./ -65.7	146./ -80.1	213./ -71.3	264./ -66.5	190./ -73.8
3	418./ -27.4	158./ -16.4	126./ -4.5	99./ 30.9	106./ 66.9
4	420./ -13.4	99./ -9.4	47./ -1.3	54./ -5.9	151./ -16.3
5	190./ 71.8	30./ 62.4	19./ 88.3	37./ 86.9	62./ 86.2
6	132./ 53.8	7./ 27.9	4./ -75.2	17./ 31.2	58./ -67.8
7	96./ -4.5	15./ 18.5	38./ 31.8	13./ 81.7	67./ 81.3
8	34./ -70.7	6./ 85.2	6./ 40.6	8./ 54.2	24./ 88.3
9	56./ -72.6	31./ -46.9	9./ -50.1	29./ -26.5	29./ -24.6
10	79./ -46.3	30./ -24.5	22./ -27.9	31./ -7.4	21./ -2.9
11	30./ -5	13./ 30.6	11./ 31.1	17./ 45.7	10./ 80.6
12	18./ 1.4	6./ 50.9	14./ 20.3	8./ 33.9	5./ 43.6
PEAK-TO-PEAK	2869.	1108.	1304.	1315.	1202.

NASA LANGLEY FLIGHT DATA AH-1G ---- PADS PCM DATA

FLIGHT NO. 066 AIRCRAFT TOTAL WT = 34994. N LOADED CG X = 5.04 M = 198.6 IN  
 RUN NO. 19 7867. LB Y = -.00 = -.0  
 TIME 55613.60 (SEC) Z = 1.83 = 72.1

AERODYNAMIC FLIGHT STATE

I. AIRSPEED- 101.6 KT  
 A/C MACH NO = .159

DYNAMIC PRES = 1.67 KPA = 34.8 PSF  
 STATIC PRES = 93.7 KPA = 1957. PSF  
 TOTAL TEMP = 270.3 DEG K = 486.5 DEG R  
 STATIC TEMP = 268.9 DEG K = 484.1 DEG R

BODY ALPHA' 14.0 DEG  
 BODY BETA- 7.0 DEG

DENSITY- 1.21 KG/M3 = .00236 SLUG/FT3  
 DENSITY ALT = 92. M = 303. FT  
 SONIC SPEED = 329.3 M/SEC = 1080. FPS  
 RATE OF CLIMB = 316. M/MIN = 1035. FPM

INERTIAL FLIGHT STATE

AXIS	CG LIN (M/S)	VEL (FPS)	CG LIN ACC (G)	HUB LIN VEL (M/S)	VEL (FPS)	HUB LIN ACC (G)	AXIS	ANG POS (DEG)	ANG RATES (RAD/SEC)	ANG ACC (RAD/SEC2)
X	50.36	165.2	.034	49.95	163.9	.152	ROLL	.7	.046	.337
Y	6.36	20.9	-.061	6.46	21.2	.012	PITCH	19.9	.195	-.562
Z	12.57	41.2	-2.003	12.58	41.3	-1.996	YAW	113.9	-.054	-.111

CONTROL ANGLES

MR. COLL = 8.9 DEG HORIZ FIN\* 8.6 DEG  
 A1 = 1.6 DEG T.R. COLL = .5 DEG  
 B1 = 6.3 DEG PEDAL POS = 1.1 DEG

ROTOR PARAMETERS

HOVER TIP MACH = .72 SHAFT ALPHA = 14.1 DEG  
 CONTROL ALPHA = 7.9 DEG  
 TIP MAX-MACH = .88 DELTA PSI = -7.4 DEG  
 TIP MIN-MACH = .56  
 .9R MAX-MACH = .81 ENGINE POWER = 95. KW = 128. HP  
 .9R MIN-MACH = .49 THRUST FACTOR = .971E+07 N = .218E+07 LB

NASA LANGLEY FLIGHT DATA AH-1G ---- ROTOR PERFORMANCE AND LOADS

FLIGHT NO. 66 MU = .219 TOTAL CQ = .000041 AMB TEMP = -4.2 C = 24.36 F  
 V = 101.6 KT MAST CQ = .000034 TEMP U60 = 14.4 C = 57.90 F  
 RUN NO. 19 NZ = 1.996 G OMEGA = 35.618 RAD/SEC CAN TEMP = 2.0 C = 35.67 F  
 TIME 55613.49 CLP = .00716 RPM/324 = 1.050

ROTOR ANGLES THETA 3/4 (DEG) A0 = 7.7 A1 = 1.9 B1 = 5.6 PEAK-TO-PEAK = 11.9  
 TEETER ANG (DEG) A0 = -.6 A1 = -2.4 B1 = 1.6 PEAK-TO-PEAK = 5.8

ROTOR LOADS (AMP/PHASE) DRAG BRACE CHORD .449 CHORD .803 PITCH LINK TORSION .449  
 (N/DEG) (N-M/DEG) (N-M/DEG) (N-M/DEG)

	55004.	12525.	2607.	-1630.	-239.
MEAN HAPMONIC-1	5825./ -17.1	1784./ -3	262./ -41.0	2900./ -22.1	324./ -57.3
2	3308./ 69.8	1521./ 80.5	102./ 78.3	1418./ 3.7	167./ 14.6
3	3341./ -13.9	881./ -19.2	34./ -12.9	98./ -34.7	48./ -71.4
4	1157./ -61.7	542./ -70.9	160./ 84.7	682./ 37.7	99./ -66.5
5	398./ 58.8	163./ 80.1	54./ 67.3	246./ -64.1	76./ -10.9
6	710./ -29.8	466./ -27.0	101./ -48.1	282./ -60.8	41./ -29.1
7	345./ 89.0	43./ 48.1	31./ 77.6	149./ -86.8	13./ 32.3
8	127./ 35.4	88./ 85.7	6./ 72.1	60./ 68.6	17./ 64.4
9	79./ 28.1	250./ -48.7	102./ -38.8	85./ -89.8	19./ 57.8
10	37./ -29.1	69./ 44.9	29./ -88.7	38./ -61.7	15./ 34.8
11	20./ 63.1	31./ -46.6	28./ 46.8	32./ -57.0	10./ 54.8
12	53./ 60.2	44./ 32.6	7./ -87.3	36./ -25.5	11./ 63.1
PEAK-TO-PEAK	19619.	6956.	1164.	8473.	1094.

	BEAM .174 (N-M/DEG)	BEAM .350 (N-M/DEG)	BEAM .449 (N-M/DEG)	BEAM .606 (N-M/DEG)	BEAM .803 (N-M/DEG)
MEAN HARMONIC-1	351.	130.	-58.	-385.	273.
2	553./ -28.8	355./ -74.7	427./ -76.0	469./ -75.7	248./ -77.3
3	205./ -27.2	219./ 75.9	273./ -88.7	313./ -77.8	207./ -77.2
4	223./ -48.8	123./ -34.7	92./ -32.8	45./ -33.9	27./ -36.3
5	423./ -6.9	100./ -17.6	35./ -25.5	95./ 25.3	153./ 24.1
6	73./ -28.4	10./ -21.1	9./ -75.7	22./ 17.8	49./ 58.4
7	70./ -85.4	25./ -65.5	12./ 6.3	21./ -79.7	44./ 54.0
8	75./ 75.9	36./ 77.1	41./ 78.3	5./ 61.8	41./ 88.4
9	60./ 31.3	26./ 72.4	18./ 70.2	8./ -15.3	9./ 32.5
10	16./ -38.3	37./ 77.6	10./ 82.5	26./ -88.3	19./ 89.0
11	10./ 11.0	24./ 71.6	10./ -79.1	12./ -75.8	3./ 21.1
12	19./ 68.4	13./ 87.5	6./ -82.7	5./ -3	8./ 61.8
PEAK-TO-PEAK	2694.	1113.	1320.	1429.	949.



NASA LANGLEY FLIGHT DATA AH-1G ---- PADS PCM DATA

FLIGHT NO. 066 AIRCRAFT TOTAL WT = 34953. N LOADED CG X= 5.04 M = 198.5 IN  
 RUN NO. 20 7858. LB Y= -.00 Z= -.0  
 TIME 55729.10 (SEC) Z= 1.83 . = 72.1

AERODYNAMIC FLIGHT STATE

T. AIRSPEED' 108.5 KT  
 A/C MACH NO= .170

DYNAMIC PRES= 1.89 KPA = 39.5 PSF  
 STATIC PRES= 93.4 KPA = 1950. PSF  
 TOTAL TEMP= 270.9 DEG K = 487.7 DEG R  
 STATIC TEMP= 269.4 DEG K = 484.9 DEG R

BODY ALPHA= 4.8 DEG  
 BODY BETA' 3.1 DEG

DENSITY- 1.21 KG/M3 = .00234 SLUG/FT3  
 DENSITY ALT= 150. M 492. FT  
 SONIC SPEED- 329.6 M/SEC = 1081. FPS  
 RATE OF CLIMB= -447. M/MIN = -1465. FPM

INERTIAL FLIGHT STATE

AXIS	CG LIN VEL (M/S)	CG LIN VEL (FPS)	CG LIN ACC (G)	HUB LIN VEL (M/S)	HUB LIN VEL (FPS)	HUB LIN ACC (G)	AXIS	ANG POS (DEG)	ANG RATES (RAD/SEC)	ANG ACC (RAD/SEC <sup>2</sup> )
X	55.56	182.3	-.075	55.30	181.4	-.073	ROLL	-4	-.003	.054
Y	3.01	9.9	-.037	3.00	9.9	-.025	PITCH	-2.9	.128	-.005
Z	4.63	15.2	-1.551	4.63	15.2	-1.548	YAW	209.6	-.021	-.025

CONTROL ANGLES

M.R. COLL= 6.6 DEG HORIZ FIN= 7.3 DEG  
 A1= -.1 DEG T.R. CULL= .8 DEG  
 B1= 3.6 DEG PEDAL POS= 1.5 DEG

ROTOR PARAMETERS

SHAFT ALPHA= 4.8 DEG  
 CONTROL ALPHA= 1.2 DEG  
 HOVER TIP MACH= .70  
 DELTA PSI= -3.1 DEG  
 TIP MAX-MACH= .87  
 TIP MIN-MACH= .53  
 9 R MAX-MACH= .80  
 .9R MIN-MACH= .46  
 ENGINE POWER= 294. KW = 395. HP  
 THRUST FACTOR= .909E+07 N = .204E+07 LB

NASA LANGLEY FLIGHT DATA AH-1G ---- ROTOR PERFORMANCE AND LOADS

FLIGHT NO. 66 MU= .240 TOTAL CO= .000138 AMB TEMP= -3.8 C = 25.24 F  
 RUN NO. 20 V= 108.5 KT MAST CO= .000133 TEMP U60= 14.2 C = 57.50 F  
 TIME 55728.98 NZ= 1.548 G OMEGA\* 34.682 RAD/SEC CAN TEMP' 2.4 C = 36.37 F  
 CLP= .00588 RPM/324= 1.022

ROTOR ANGLES

THETA 3/4 (DEG) A0= 7.7 A1= -.1 B1= 3.8 PEAK-TO-PEAK\* 7.8  
 TEETER ANG (DEG) A0= -.8 A1= -.8 B1= .9 PEAK-TO-PEAK= 2.5

ROTOR LOADS (AMP/PHASE)

	DRAG BRACE (N/DEG)	CHORD .449 (N-M/DEG)	CHORD .803 (N-M/DEG)	PITCH LINK (N/DEG)	TORSION .449 (N-M/DEG)
MEAN	47533.	13530.	2319.	-1483.	-269.
HARMONIC-1	5076./ 3.6	1363./ 1.7	276./ -42.7	1910./ -33.9	311./ -61.4
2	1068./ -89.1	533./ -80.0	43./ 25.5	1097./ -37.5	123./ -11.1
3	2604./ 18.0	764./ 26.4	44./ 2.0	299./ 16.6	56./ 29.8
4	760./ 12.8	492./ 3.4	97./ -38.1	465./ 77.3	66./ 37.5
5	635./ -41.4	194./ -31.0	52./ -68.5	139./ -39.1	27./ -72.6
6	1287./ -58.2	905./ -62.1	186./ -64.7	187./ 4.6	41./ 14.0
7	285./ -86.4	93./ -87.3	73./ 88.6	125./ -6.4	15./ 24.8
8	170./ 30.1	124./ 19.7	33./ 51.2	17./ 67.1	11./ 22.1
9	70./ 6.9	84./ 46.8	41./ 60.5	133./ -62.6	13./ -44.5
10	35./ -45.0	340./ 77.6	151./ 82.9	100./ 21.3	8./ -24.9
11	80./ -76.5	45./ 4.2	17./ -54.6	50./ 83.1	7./ -26.7
12	49./ -43.7	40./ -39.6	14./ -11.3	14./ -26.0	2./ 43.2
PEAK-TO-PEAK	15221.	6032.	1164.	5812.	779.
	BEAM .174 (N-M/DEG)	BEAM .350 (N-M/DEG)	BEAM .449 (N-M/DEG)	BEAM .606 (N-M/DEG)	BEAM .803 (N-M/DEG)
MEAN	237.	112.	-86.	-384.	194.
HARMONIC-1	585./ -28.9	431./ -66.0	456./ -69.4	442./ -73.9	252./ 88.2
2	231./ -47.3	221./ -79.1	268./ -75.9	274./ -76.1	142./ -89.2
3	182./ -44.5	91./ -21.1	70./ 6.7	77./ 52.1	97./ 60.4
4	443./ 26.2	125./ 16.5	57./ 16.9	97./ 33.9	179./ 23.9
5	149./ -52.5	20./ -51.6	22./ 32.5	32./ -41.3	64./ 81.7
6	71./ -82.2	8./ 55.6	11./ 49.3	9./ -17.5	57./ -80.6
7	102./ -8.6	17./ -10.7	41./ 23.4	15./ 75.6	62./ 67.7
8	24./ -73.1	15./ -67.7	5./ 5.0	19./ -66.2	32./ -71.2
9	64./ -79.7	46./ -72.7	12./ -76.0	51./ -58.7	47./ -52.1
10	84./ -21.2	29./ -8.0	21./ -7.6	37./ 5.1	28./ 5.2
11	14./ 29.6	6./ -77.1	6./ 52.3	10./ 79.6	4./ -40.1
12	37./ 43.8	7./ 46.0	18./ 33.4	12./ 52.7	5./ 80.4
PEAK-TU-PEAK	2655.	1339.	1376.	1355.	1151.

NASA LANGLEY FLIGHT DATA AH-1G ---- PADS PCM DATA

FLIGHT NO. 066 AIRCRAFT TOTAL WT = 34912. N LOADED CG X = 5.04 M = 198.5 IN  
 RUN NO. 22 7849. LB Y = -0.00 Z = -0.0  
 TIME 55799.85 (SEC) Z = 1.83 M = 72.1

AERODYNAMIC FLIGHT STATE

DYNAMIC PRES = 2.04 KPA = 42.6 PSF  
 STATIC PRES = 93.9 KPA = 1960. PSF  
 TOTAL TEMP = 271.5 DEG K = 488.7 DEG F  
 STATIC TEMP = 269.8 DEG K = 485.7 DEG F  
 T. AIRSPEED = 112.5 KT  
 A/C MACH NO = .176  
 BODY ALPHA = 8.6 DEG  
 BODY BETA = 4.3 DEG  
 DENSITY\* 1.21 KG/M3 = .00235 SLUG/FT3  
 DENSITY ALT = 113. M = 371. FT  
 SONIC SPEED\* 329.9 M/SEC = 1082. FPS  
 RATE OF CLIMB = -663. M/MIN = -7,177. FPM

INEQUAL FLIGHT STATE

AXIS	CG LIN VFL (M/S)	VFL (FPS)	CG LIN ACC (G)	HUB LIN VEL (M/S)	VEL (FPS)	HUB LIN ACC (G)	AXIS	ANG POS (DFG)	ANG RATES (RAD/SEC)	ANG ACC (RAD/SEC2)
X	57.05	187.2	-.093	56.48	185.3	-.073	ROLL	-.5	.014	-.092
Y	4.33	14.2	-.058	4.37	14.3	-.077	PITCH	-2.5	.282	-.095
Z	8.55	28.4	-2.070	8.66	28.4	-2.053	YAW	271.5	.002	-.036

CONTROL ANGLES

M.R. COLL = 8.7 DEG  
 A1 = .2 DEG  
 R1 = 2.5 DEG  
 HORIZ FIN = 6.9 DEG  
 T.R. COLL = .8 DEG  
 PEDAL POS = 1.6 DEG

ROTOR PARAMETERS

SHAFT ALPHA = 8.7 DEG  
 CONTROL ALPHA = 6.2 DEG  
 HOVER TIP MACH = .71  
 TIP MAX-MACH = .88  
 TIP MIN-MACH = .53  
 .9R MAX-MACH = .81  
 .9R MIN-MACH = .46  
 DELTA PSI = -4.4 DEG  
 ENGINE POWER = 242. KW = 375. HP  
 THRUST FACTOR = .930E+07 N = .209F+07 LB

NASA LANGLEY FLIGHT DATA AH-1G ---- ROTOR PERFORMANCE AND LOADS

FLIGHT NO. 66 MU = .245 TOTAL CQ = .000108 AMB TEMP = -3.3 C = 26.05 F  
 RUN NO. 22 V = 112.5 KT MAST CQ = .000087 TEMP U60 = 14.5 C = 58.16 F  
 TIME 55799.77 NZ = 2.053 G OMEGA = 35.279 RAD/SEC CAN TEMP = 2.8 C = 37.06 F  
 CLP = .00754 RPM/324 = 1.040

ROTOR ANGLES

THETA 314 (DEG) A0 = 7.1 A1 = -.2 B1 = 2.1 PEAK-TO-PEAK = 4.2  
 TEETER ANG (DEG) A0 = -.7 A1 = -.2 B1 = 1.0 PEAK-TO-PEAK = 2.3

ROTOR LOADS (AMP/PHASE)

DRAG BRACE (N/DEG) CHORD .449 (N-M/DEG) CHORD .803 (N-M/DEG) PITCH LINK (N/DEG) TORSION .449 (N-M/DEG)

	DRAG BRACE (N/DEG)	CHORD .449 (N-M/DEG)	CHORD .803 (N-M/DEG)	PITCH LINK (N/DEG)	TORSION .449 (N-M/DEG)
MEAN	51742.	13135.	2372.	-1261.	-221.
HARMONIC-1	7358./ 15.7	2146./ 26.5	236./ -18.5	1890./ .2	239./ -64.9
2	1812./ -78.1	1028./ -72.2	89./ -56.6	749./ -19.5	81./ -10.8
3	3854./ 5.0	1124./ 3.9	128./ -17.9	228./ -4.3	14./ 46.0
4	459./ 30.3	238./ -6.9	21./ -81.3	344./ 28.0	63./ -6
5	512./ -54.6	227./ -38.7	69./ -63.5	312./ -59.4	31./ -16.6
6	1357./ -59.9	949./ -61.3	197./ -61.8	269./ 53.8	55./ 47.3
7	235./ -70.6	99./ -65.3	76./ -69.0	166./ 10.8	9./ 14.9
8	174./ 69.8	134./ 50.5	41./ 68.4	84./ -72.7	12./ 87.6
9	39./ -31.1	211./ -31.0	40./ -23.0	40./ -7.8	5./ 65.8
10	78./ -70.7	79./ 69.1	61./ 75.8	97./ 4.8	5./ -16.4
11	130./ -34.3	23./ -2.3	11./ 81.3	86./ 55.3	7./ -60.6
12	67./ -73.3	62./ -86.1	13./ 61.0	49./ -77.4	8./ -66.8
PEAK-TO-PEAK	21756.	8021.	1145.	4724.	753.

BEAM .174 (N-M/DEG) BEAM .350 (N-M/DEG) BEAM .449 (N-M/DEG) BEAM .606 (N-M/DEG) BEAM .803 (N-M/DEG)

	BEAM .174 (N-M/DEG)	BEAM .350 (N-M/DEG)	BEAM .449 (N-M/DEG)	BEAM .606 (N-M/DEG)	BEAM .803 (N-M/DEG)
MEAN	647.	135.	-86.	-429.	348.
HARMONIC-1	608./ 14.6	414./ -62.2	485./ -67.4	537./ -69.8	355./ 89.7
2	99./ -8.9	167./ 88.1	240./ -79.4	268./ -77.4	194./ -88.5
3	381./ -32.0	142./ -21.0	108./ 3.5	91./ 50.7	116./ 73.5
4	413./ -12.1	111./ -14.3	53./ 6.4	82./ -12.4	199./ -4.2
5	130./ 81.5	20./ 83.7	15./ 70.2	25./ -67.1	79./ 49.1
6	75./ 64.7	13./ 76.1	18./ -68.9	14./ 73.9	61./ -77.5
7	95./ 35.5	16./ 46.4	48./ 58.2	4./ -75.5	65./ -85.7
8	22./ 82.5	5./ 31.0	15./ 72.6	4./ -35.5	28./ -51.0
9	20./ -69.4	27./ -56.4	5./ -67.8	34./ -39.0	38./ -35.4
10	92./ -40.0	33./ -39.4	26./ -38.5	40./ -27.3	34./ -25.9
11	32./ 32.8	9./ 56.2	12./ 33.8	12./ 47.6	6./ 4.9
12	53./ 82.3	9./ -50.6	16./ 55.4	11./ 82.9	2./ 74.5
PEAK-TO-PEAK	2235.	1195.	1345.	1337.	1353.

FLIGHT NO. 066 AIRCRAFT TOTAL WT \* 34902. N LOADED CG X- 5.04 M \* 198.5 IN  
 RUN NO. 72 7847. LB Y\* -.00 \* -O  
 TIME 55790.52 (SEC) Z\* 1.83 \* 72.1

**AERODYNAMIC FLIGHT STATE**  
 DYNAMIC PRES\* 1.92 KPA \* 40.2 PSF  
 T. AIRSPEED- 109.2 KT STATIC PRES\* 93.9 KPA \* 1962. PSF  
 A/C MACH NO- .170 TOTAL TEMP- 271.3 OEG K \* 488.3 DEG P  
 STATIC TEMP- 269.7 DEG K \* 485.5 DFG P  
 BODY ALPHA\* 11.6 OEG DENSITY- 1.21 KG/M3 \* .00236 SLUG/FT3  
 BODY BETA\* 4.3 OEG DENSITY ALT\* 101. M \* 331. FT  
 SONIC SPEED\* 329.8 M/SEC \* 1082. FPS  
 RATE OF CLIMB\* -238. M/MIN \* -780. FPM

**INERTIAL FLIGHT STATE**

AXIS	CG LIN VEL (M/S)	CG LIN VEL (FPS)	CG LIN ACC (G)	HUB LIN VEL (M/S)	HUB LIN VEL (FPS)	HUB LIN ACC (G)	AXIS	ANG PO? (DEG)	ANG RATES (RAD/SEC)	ANG ACC (RAD/SEC?)
X	54.88	180.1	-.121	54.33	178.2	-.117	ROLL	-.7	-.032	-.160
Y	4.19	13.8	-.062	4.13	13.5	-.094	PITCH	7.5	.271	-.020
Z	11.27	37.0	-2.296	11.28	37.0	-2.280	YAW	270.9	-.023	-.054

**CONTROL ANGLES**  
 MR. COLL\* 8.6 OEG HORIZ FIN\* 6.8 OEG  
 A1\* .5 DEG T.R. COLL\* .8 OEG  
 B1\* 2.1 DEG PEDAL POS\* 1.7 DEG

**ROTOR PARAMETERS**

HOVER TIP MACH= .72 SHAFT ALPHA\* 11.7 DEG  
 CONTROL ALPHA\* 9.6 OEG  
 TIP MAX-MACH\* .89 DELTA PSI\* -4.3 DEG  
 TIP MIN-MACH\* .55  
 .9R MAX-MACH- .82 ENGINE POWER- 126. KW \* 169. HP  
 .9R MIN-MACH- .48 THRUST FACTOR- .959E+07 N \* .216F+07 LB

NASA LANGLEY FLIGHT DATA AH-1G ---- ROTOR PERFORMANCE AND LOADS

FLIGHT NO. 66 MU- .235 TOTAL CO\* .000054 AMR TEMP- -3.4 C \* 25.81 F  
 RUN NO. 22 V\* 109.2 KT MAST CO\* .000043 TEMP U60= 14.5 C \* 58.13 F  
 TIME 55790.37 NZ\* 2.280 G OMEGA\* 35.687 RAD/SEC CAN TEMP= 2.8 C = 37.06 F  
 CLP\* .00816 RPM/324= 1.052

**ROTOR ANGLES**  
 THETA 314 (DEG) AO\* 7.0 A1\* -.3 B1\* 1.8 PFAK-TO-PEAK- 3.7  
 TEETER ANG (DEG) AO\* -.6 A1\* .7 B1\* 1.0 PEAK-TO-PEAK- 2.3

ROTOR LOADS (AMP/PHASE)	DRAG BRACE (N/DEG)	CHORD .449 (N-M/DEG)	CHORD .803 (N-M/DEG)	PITCH LINK (N/DEG)	TORSION .449 (N-M/DEG)
MEAN	54277.	12916.	2468.	-1166.	-175.
HARMONIC-1	8850./ -0.9	2730./ 9.4	377./ -24.4	3184./ 10.3	282./ -28.3
2	2338./ 44.9	1131./ 75.3	122./ 60.3	945./ 11.2	163./ 17.1
3	3690./ 6.8	1138./ 4.0	128./ -8.1	250./ 17.8	40./ -29.2
4	568./ 17.8	326./ -14.8	39./ -11.8	378./ 53.3	74./ -19.0
5	418./ -47.9	270./ -12.4	87./ -31.3	292./ -19.9	66./ 27.6
6	721./ -38.8	430./ -49.8	46./ -26.7	160./ 28.6	45./ 39.1
7	36./ 42.1	32./ 4.8	51./ -44.8	178./ 20.6	20./ 51.5
8	107./ -29.8	100./ -15.6	22./ 54.4	39./ 88.5	19./ 71.3
9	104./ -34.7	74./ 81.2	30./ 10.0	115./ 19.7	18./ 82.1
10	116./ -69.4	60./ 72.2	49./ -84.1	108./ 71.4	18./ -43.7
11	63./ 26.2	92./ 15.9	27./ 37.0	51./ -73.4	14./ 32.6
12	77./ -27.9	39./ 11.6	17./ -64.4	29./ -51.1	6./ -50.8
PEAK-TO-PEAK	21225.	8241.	1218.	7752.	1021.
	REAM .174 (N-M/DEG)	BEAM .350 (N-M/DEG)	BEAM .449 (N-M/DEG)	BEAM .606 (N-M/DEG)	REAM .803 (N-M/DEG)
MEAN	723.	142.	-79.	-426.	381.
HARMONIC-1	834./ 1.6	435./ -62.4	503./ -68.6	553./ -71.0	335./ 85.9
7	24./ 79.8	174./ -75.5	248./ -64.4	284./ -58.5	184./ -56.6
3	383./ -27.7	134./ -12.9	117./ 9.6	127./ 43.4	115./ 63.9
4	331./ -13.9	81./ -12.1	37./ 7.6	46./ -34.7	133./ -18.7
5	169./ 86.7	31./ 82.7	25./ -78.2	30./ -68.2	67./ -89.9
6	68./ 52.7	13./ 84.0	29./ -66.9	9./ 4.3	85./ -52.7
7	93./ -14.8	11./ 10.6	29./ 37.0	9./ -79.6	47./ -75.7
8	68./ -58.6	8./ -30.2	11./ -6.9	1./ -81.5	14./ -24.3
9	60./ -40.6	32./ -15.8	14./ -18.0	33./ 1.5	35./ 10.0
10	73./ -6.8	23./ 21.5	22./ 2.8	26./ 34.6	20./ 35.2
11	44./ 15.4	14./ 53.7	21./ 26.2	16./ 52.5	10./ 54.9
12	11./ 49.5	9./ -63.5	14./ 24.5	7./ 88.3	3./ 81.9
PEAK-TO-PEAK	2559.	1219.	1426.	1469.	1134.

FLIGHT NO. 066 AIRCRAFT TOTAL WT = 34792. N LOADED CG X = 5.04 M = 198.5 IN  
 RUN NO. 24 7822. LB Y = -0.00 Z = 1.83  
 TIME 56008.60 (SEC)

AERODYNAMIC FLIGHT STATE

T. AIRSPEED = 115.8 KT  
 A/C MACH NO = .181

BODY ALPHA\* 8.3 DEG  
 BODY BETA\* 1.4 DEG

DYNAMIC PRES = 2.14 KPA = 44.6 PSF  
 STATIC PRES = 92.2 KPA = 1927. PSF  
 TOTAL TEMP = 270.5 DEG K = 486.9 DEG R  
 STATIC TEMP = 268.7 DEG K = 483.7 DEG R  
 DENSITY\* 1.20 KG/M3 = .00232 SLUG/FT3  
 DENSITY ALT = 249. M = 818. FT  
 SONIC SPEED = 329.2 M/SEC = 1080. FPS  
 RATE OF CLIMB = -702. M/MIN = -2302. FPM

INERTIAL FLIGHT STATE

AXIS	CG LIN VEL (M/S)	CG LIN VEL (FPS)	CG LIN ACC (G)	HUB LIN VEL (M/S)	HUB LIN VEL (FPS)	HUB LIN ACC (G)	AXIS	ANG POS (DEG)	ANG RATES (RAD/SEC)	ANG ACC (RAD/SEC2)
X	58.94	193.4	-.132	58.44	191.7	-.134	ROLL	-2.0	-.008	-.028
Y	1.44	4.7	-.016	1.43	4.7	-.022	PITCH	-3.1	.241	.009
Z	8.58	28.2	-2.144	8.59	28.2	-2.132	YAW	188.4	-.006	.024

CONTROL ANGLES

MR COLL = 9.2 DEG  
 A1 = .3 DEG  
 B1 = 2.3 DEG  
 HORIZ FIN = 6.8 DEG  
 T.R. COLL = .3 DEG  
 PEDAL POS = 1.2 DEG

ROTOR PARAMETERS

HOVER TIP MACH = .71  
 SHAFT ALPHA = 8.4 DEG  
 CONTROL ALPHA\* = 6.1 DEG  
 TIP MAX-MACH = .89  
 TIP MIN-MACH = .53  
 .9R MAX-MACH\* = .82  
 .9R MIN-MACH\* = .46  
 DELTA PSI = -1.4 DEG  
 ENGINE POWER = 249. KW = 334. HP  
 THRUST FACTOR\* = .921E+07 N = .207E+07 LB

NASA LANGLEY FLIGHT DATA AH-1G ---- ROTOR PERFORMANCE AND LOADS

FLIGHT NO. 66 MU = 1252  
 RUN NO. 24 V = 115.8 KT TOTAL CG = .000113  
 TIME 56008.49 NZ = 2.132 G OMEGA = 35.219 RAD/SEC  
 CLP = .00791 RPM/324 = 1.038  
 AMB TEMP = -4.4 C = 24.04 F  
 TEMP U60 = 14.3 C = 57.71 F  
 CAN TEMP = 2.4 C = 36.37 F

ROTOR ANGLES

THETA 314 (DEG)  
 TEETER ANG (DEG)  
 A0 = 7.7 A1 = -.3 B1 = 2.0 PEAK-TO-PEAK = 4.0  
 A2 = -.7 A3 = .6 B2 = 1.1 PEAK-TO-PEAK\* = 2.3

ROTOR LOADS (AMP/PHASE)

DRAG BRACE (N/DEG) CHORD .449 (N-M/DEG) CHORD .803 (N-M/DEG) PITCH LINK (N/DEG) TORSION .449 (N-M/DEG)

	DRAG BRACE (N/DEG)	CHORD .449 (N-M/DEG)	CHORD .803 (N-M/DEG)	PITCH LINK (N/DEG)	TORSION .449 (N-M/DEG)
MEAN	51694.	13048.	2360.	-1460.	-238.
HARMONIC-1	7758./ 5.2	2287./ 16.0	363./ -28.5	2543./ 5.9	266./ -35.9
2	1722./ 69.2	891./ -87.8	80./ -88.5	820./ 32.5	140./ 32.7
3	3368./ 17.2	1024./ 17.8	92./ 11.7	228./ 11.1	18./ -85.1
4	649./ 8.8	377./ -14.5	58./ 89.7	226./ 30.8	71./ -12.8
5	799./ -17.1	355./ -10.2	82./ -12.3	316./ -.2	51./ 34.5
6	966./ -7.8	629./ -12.5	118./ -1.3	307./ -87.0	49./ -72.2
7	158./ -8.3	55./ 55.7	71./ -22.5	161./ 44.5	14./ -46.3
8	53./ 69.4	43./ 34.2	37./ -26.8	64./ -45.3	15./ -67.1
9	49./ -23.7	94./ -67.9	31./ 5.5	41./ 4.7	4./ -67.5
10	63./ 28.0	27./ 21.1	46./ 19.2	109./ 74.3	6./ 62.9
11	82./ -7.5	43./ -45.8	27./ -6.7	95./ -77.4	10./ -79.1
12	97./ 23.6	65./ 43.6	3./ -33.7	28./ 2.9	10./ -58.4
PEAK-TO-PEAK	19626.	7672.	1253.	6514.	912.

BEAM .174 (N-M/DEG) BEAM .350 (N-M/DEG) BEAM .449 (N-M/DEG) BEAM .606 (N-M/DEG) BEAM .803 (N-M/DEG)

	BEAM .174 (N-M/DEG)	BEAM .350 (N-M/DEG)	BEAM .449 (N-M/DEG)	BEAM .606 (N-M/DEG)	BEAM .803 (N-M/DEG)
MEAN	704.	143.	-82.	-408.	341.
HARMONIC-1	761./ 4.7	459./ -53.8	523./ -60.8	582./ -65.2	371./ -89.0
2	119./ 76.0	211./ -87.5	277./ -74.0	288./ -66.5	174./ -65.1
3	313./ -27.5	130./ -21.1	102./ 10.0	99./ 55.8	96./ 75.1
4	360./ -18.6	98./ -25.4	49./ 3.2	70./ -28.2	182./ -5.9
5	106./ -74.9	23./ -65.9	11./ -80.9	28./ -47.6	78./ 69.2
6	21./ -79.4	15./ -57.7	31./ -44.0	8./ 88.2	85./ -49.0
7	81./ 41.4	8./ -85.5	35./ 88.9	7./ -44.2	64./ -53.4
8	4./ 81.7	8./ 66.9	11./ -57.2	11./ -26.5	38./ -25.7
9	31./ -55.3	34./ -42.5	8./ -79.2	44./ -27.5	48./ -18.0
10	82./ 15.4	26./ 19.9	17./ 11.5	34./ 23.7	29./ 22.6
11	61./ 49.4	13./ 84.1	18./ 54.3	18./ 64.8	12./ 39.7
12	43./ -43.2	7./ -21.9	14./ -70.5	8./ -62.9	1./ -5.8
PEAK-TO-PEAK	2417.	1325.	1477.	1436.	1298.

NASA LANGLEY FLIGHT DATA AH-1G ---- PADS PCM DATA

FLIGHT NO. 066 AIRCRAFT TOTAL WT = 34771. N LOADED CG X= 5.04 ti = 198.5 IN  
 RUN NO. 24 7817. LB Y= -.00 = -.0  
 TIME 56009.50 (SEC) Z= 1.83 = 72.2

AERODYNAMIC FLIGHT STATE DYNAMIC PRES= 1.96 KPA = 41.0 PSF  
 STATIC PRES= 92.3 KPA = 1929. PSF  
 TOTAL TEMP\* 270.2 OEG K = 486.3 OEG R  
 A/C MACH NO= .174 STATIC TEMP= 268.5 OEG K = 483.4 OEG R  
 BODY ALPHA= 10.9 OEG DENSITY- 1.20 KG/M3 = .00233 SLUG/FT3  
 BODY BETA= 1.3 DEG DENSITY ALT= 231. M = 759. FT  
 SONIC SPEED= 329.1 M/SEC = 1080. FPS  
 RATE OF CLIMB- -131. M/MIN = -428. FPM

INERTIAL FLIGHT STATE

AXIS	CG LIN VEL (M/S)	CG LIN ACC (G)	HUB LIN VEL (M/S)	HUB LIN ACC (G)	AXIS	ANG POS (DEG)	ANG RATES (RAD/SEC)	ANG ACC (RAD/SEC2)	
X	56.03	183.8	-.113	55.60	182.4	-.118	ROLL -1.8	.019	-.012
Y	1.31	4.3	-.016	1.35	4.4	-.018	PITCH 8.6	.208	.028
I	10.76	35.3	-2.206	10.77	35.3	-2.197	YAW 188.0	-.010	-.003

CUKTR0L ANGLES M.R. COLL= 9.2 DEG HORIZ FIN\* 7.1 OEG  
 A1= .6 DEG T.R. COLL= -.1 OEG  
 B1= 3.2 OEG PEDAL POS= 1.0 OEG

ROTOR PARAMETERS

HOVER TIP MACH= .72 SHAFT ALPHA' 11.0 OEG  
 CONTROL ALPHA= 7.8 OEG  
 TIP MAX-MACH- .89 DELTA PSI\* -1.4 OEG  
 TIP MIN-MACH\* .55  
 .9R MAX-MACH- .82 ENGINE POWER= 150. KW = 201. HP  
 .9R MIN-MACH- .47 THRUST FACTOR\* .945E+07 N = .213E+07 LB

NASA LANGLEY FLIGHT DATA AH-1G ---- ROTOR PERFORMANCE AND LOADS

FLIGHT NO. 66 MU= .240 TOTAL CQ= .000066 AMB TEMP= -4.6 C = 23.72 F  
 V 110.9 KT MAST CQ= .000054 TEMP U60= 14.2 C = 57.64 F  
 RUN NO. 24 NZ= 2.197 G OMEGA= 35.477 RAD/SEC CAN TEMP= 2.4 C = 36.37 F  
 TIME 56009.38 CLP= .00801 RPM/324= 1.046

ROTOR ANGLES THETA 3/4 (DEG) AO= 7.9 A1= -.2 B1= 3.5 PEAK-TO-PEAK- 7.0  
 TEETER ANG (DEG) AO= -.7 A1= .0 B1= 1.0 PEAK-TO-PEAK- 2.0

ROTOR LOAOS (AMP/PHASE) DRAG BRACE CHORD .449 CHORD .803 PITCH LINK TORSION .449  
 (N/DEG) (N-M/DEG) (N-M/DEG) (N-M/DEG)

	53212.	12885.	2453.	-1519.	-222.
MEAN HARMONIC-1	9701./	3047./	498./	3895./	362./
2	3289./	1268./	152./	1290./	212./
3	4163./	1326./	155./	269./	29./
4	670./	405./	60./	173./	84./
5	599./	207./	65./	578./	101./
6	852./	540./	81./	377./	65./
7	217./	290./	137./	249./	31./
8	163./	63./	85./	85./	12./
9	93./	38./	57./	81./	17./
10	178./	212./	33./	110./	18./
11	96./	111./	23./	32./	14./
12	75./	84./	40./	40./	5./
PEAK-TO-PEAK	23870.	9666.	1689.	9686.	1311.

	BEAM .174 (N-M/DEG)	BEAM .350 (N-M/DEG)	BEAM .449 (N-M/DEG)	BEAM .606 (N-M/DEG)	BEAM .803 (N-M/DEG)
MEAN HARMONIC-1	653.	153.	-60.	-380.	331.
2	1034./	466./	514./	563./	312./
3	89./	190./	261./	299./	206./
4	256./	111./	110./	133./	110./
5	240./	64./	42./	35./	139./
6	200./	38./	23./	43./	57./
7	43./	24./	51./	4./	113./
8	99./	9./	40./	13./	68./
9	29./	4./	11./	2./	20./
10	37./	26./	10./	30./	39./
11	90./	36./	32./	41./	37./
12	18./	10./	16./	10./	5./
PEAK-TO-PEAK	2785.	1313.	1474.	1556.	1031.

## REFERENCES

1. Paglino, Vincent M.; and Clark, David R.: A Study of the Potential Benefits of Advanced Airfoils for Helicopter Applications. Paper presented at Am. Helicopter Symposium on Helicopter Aero. Efficiency, Hartford, CN, March 1975.
2. Morris, Charles E. K., Jr.: Rotor-Airfoil Flight Investigation: Preliminary Results. Preprint 78-5, 34th Annual Nat. Forum of the Am. Helicopter Soc., May 1978.
3. Morris, Charles E. K., Jr.: A Flight Investigation of Rotor Airfoils. Paper No. 10, Advanced Technology Airfoil Research, Vol. II, NASA CP 2046, March 1978, pp 141-154.
4. Kemp, Larry D.: An Analytical Study for the Design of Advanced Rotor Airfoils. NASA CR-112297, 1973.
5. Sloof, J. W.; Wortmann, F. X.; and Duhon, J. M.: The Development of Transonic Airfoils for Helicopters. Preprint 901, 31st Annual Nat. Forum of the Am. Helicopter Soc., May 1975.
6. Morris, Charles E. K., Jr.: A Flight Investigation of Basic Performance Characteristics of a Teetering-Rotor Attack Helicopter. NASA TM 80112, 1979.
7. Knight, Vernie H.; Haywood, William S., Jr.; and Williams, Milton L.: A Rotor-Mounted Digital Instrumentation System for Helicopter Blade Flight Research Measurements. NASA TP 1146, 1978.
8. Shockey, G. A.; Williamson, J. W.; and Cox, C. R.: Helicopter Aerodynamics and Structural Loads Survey. Preprint 1060, 32nd Annual Nat. Forum of the Am. Helicopter Soc., May 1976.
9. Shockey, Gerald A.; Williamson, Joe W.; and Cox, Charles R.: AH-1G Helicopter Aerodynamic and Structural Loads Survey. USAAMRDL TR-76-39, 1977.
10. Cox, C. R.: Helicopter Rotor Aerodynamic and Aeroacoustic Environments. Preprint 77-1338. 4th Aeroacoustic Conference of the AIAA. Oct. 1977.
11. Van Gaasbeek, James R.; and Austin, Edward E.: Digital Simulation of the Operational Loads Survey Flight Tests. Preprint 78-58, 34th Annual Nat. Forum of the Am. Helicopter Soc., May 1978.
12. Noonan, Kevin W.; and Bingham, Gene J.: Two-Dimensional Aerodynamic Characteristics of Several Rotorcraft Airfoils at Mach Numbers from 0.35 to 0.90. NASA TM X-73990, 1977.
13. Dadone, Leo: Two-Dimensional Wind-Tunnel Test of an Oscillating Rotor Airfoil. Vols. I and II. NASA CR-2914 and CR-2915, 1977.

14. Pruyn, Richard R.: In-Flight Measurement of Rotor Blade Airloads, Bending Moments, and Motions, Together with Rotor Shaft Loads and Fuselage Vibration, on a Tandem Rotor Helicopter. Vol. IV, Summary and Evaluation of Results. USAAVLABS TR 67-9D, May 1967.
15. Livingston, C. L.; and Murphy, M. R.: Flying Qualities Considerations in the Design and Development of the Huey Cobra. J. Am. Helicopter Soc., vol. 14, no. 1, Jan. 1969, pp. 49-66.

TABLE I.- BASIC AIRCRAFT CHARACTERISTICS

Empty weight, N (lb.) . . . . .	28,130 (6323)
Fuel capacity, N (lb.) . . . . .	7,250 (1630)
Powerplant . . . . .	Lycoming T53-L-13B
Nominal transmission limit at 100% rpm, kw (hp) . . . . .	820 (1100)

Wing:

Airfoil

Root . . . . .	NACA 0030
Tip . . . . .	NACA 0024
Semi-span (panel only), m (ft) . . . . .	1.09 (3.56)
Area (panels only), m <sup>2</sup> (ft <sup>2</sup> ) . . . . .	1.63 (17.6)
Chord:	
Root, m (ft) . . . . .	0.88 (2.89)
Tip, m (ft) . . . . .	0.62 (2.04)
Incidence angle (chord line), deg . . . . .	14.0
Leading-edge sweep, deg . . . . .	15.2
Dihedral angle, deg . . . . .	0.0

Horizontal tail:

Airfoil . . . . .	inverted Clark Y
Semi-span (panel only), m (ft) . . . . .	0.78 (2.54)
Area (panels only), m <sup>2</sup> (ft <sup>2</sup> ) . . . . .	0.95 (10.2)
Chord:	
Root, m (ft) . . . . .	0.75 (2.45)
Tip, m (ft) . . . . .	0.54 (1.78)
Leading-edge sweep, deg . . . . .	19.9
Dihedral angle, deg . . . . .	0.0

Vertical tail:

Airfoil	
Root . . . . .	cambered, 14% thick
Tip . . . . .	cambered, 15% thick
Span (above tail boom), m (ft) . . . . .	1.64 (5.38)
Area, m <sup>2</sup> (ft <sup>2</sup> ) . . . . .	1.73 (18.6)
Chord:	
Root, m (ft) . . . . .	1.42 (4.67)
Tip, m (ft) . . . . .	.69 (2.25)
Leading-edge sweep, deg . . . . .	50.0
Twist, deg . . . . .	nonlinear



TABLE I.- Concluded

Main rotor:

Number of blades . . . . .	2
Airfoil . . . . .	NLR-1T
Radius (R), m (ft) . . . . .	6.706 (22.0)
Chord, m (ft) . . . . .	0.686 (2.25)
Taper . . . . .	1:1
Solidity . . . . .	0.0651
Twist, deg . . . . .	-10/R
Flapwise inertia, kg-m <sup>2</sup> (slug-ft <sup>2</sup> ) . . . . .	2120 (1560)
Lock number . . . . .	5.05
Nominal tip speed, m/sec (ft/sec) . . . . .	227.5 (746.6)
Hub precone angle, deg . . . . .	2.75
Pitch-flap coupling ( $\delta_3$ ), deg . . . . .	0.0
Blade pitch range at .75 R, deg . . . . .	-12.3, +39.6
Trim tab -	
Width, m (ft) . . . . .	0.191 (0.75)
Overhang length, m (ft) . . . . .	0.042 (0.138)
In-board edge . . . . .	0.761 R

Tail rotor:

Number of blades . . . . .	2
Airfoil . . . . .	NACA 0018
.25 tail-rotor radius . . . . .	cambered, 8% thick
tip . . . . .	
Radius . . . . .	1.295 (4.25)
Chord, m (ft) . . . . .	0.292 (0.96)
Taper . . . . .	1:1
Solidity . . . . .	0.144
Twist, deg . . . . .	0.0
Equivalent root cut-out . . . . .	35
Nominal tip speed, m/sec (ft/sec) . . . . .	227.5 (746.4)
Blade pitch range, deg <sup>3</sup> . . . . .	-14.7, +15.3
Hub precone angle, deg . . . . .	10
Pitch-flap coupling ( $\delta_3$ ), deg . . . . .	30 <sup>0</sup>

TABLE II.- SPANWISE DISTRIBUTION OF BLADE DESIGN PROPERTIES

Segment No.	r/R	$EI_b \times 10^{-4}$ N-m <sup>2</sup>	$EI_c \times 10^{-6}$ N-m <sup>2</sup>	Weight Meter N/m	$GJ \times 10^{-4}$ N-m <sup>2</sup>	$x_{cg}$ cm	$y_{cg}$ cm	$x_{na}$ cm	$y_{na}$ cm
1*	.025	4.28	8.90	819	10.3	19.4	.635	17.1	.635
2*	.075	3.64	5.48	1269	10.3	24.2	.635	17.1	.635
3*	.125	102.2	5.02	996	10.3	26.3	.635	17.1	.635
4	.175	73.5	16.65	805	19.8	21.1	.144	19.7	.584
5	.225	20.8	13.99	208	21.2	18.1	.575	16.7	.586
6	.275	12.2	12.74	170	11.7	18.5	.558	16.9	.569
7	.325	9.11	12.80	163	8.99	20.0	.555	17.2	.557
8	.375	8.94	12.02	162	7.94	19.9	.556	16.7	.554
9	.425	8.66	11.15	168	7.13	18.4	.546	15.8	.550
10	.475	8.38	10.46	188	6.30	16.3	.522	14.8	.540
11	.525	8.04	9.70	184	5.54	16.0	.518	14.2	.534
12	.575	7.71	8.94	180	5.40	15.6	.513	13.7	.528
13	.625	7.37	8.18	177	5.40	15.3	.509	13.2	.521
14	.675	7.32	7.43	173	5.40	15.0	.504	12.6	.515
15	.725	6.68	7.03	169	5.40	14.8	.498	12.3	.507
16	.775	6.30	7.06	170	5.40	14.6	.489	12.1	.493
17	.825	6.00	7.37	213	5.40	12.3	.462	10.7	.468
18	.875	6.00	7.37	213	5.40	12.3	.462	10.7	.468
19	.925	6.00	7.37	213	5.40	12.3	.462	10.7	.468
20	.975	5.95	7.22	190	5.40	13.4	.472	11.4	.475

\* hub segments

TABLE III.- COORDINATES OF NLR-1T AIRFOIL

$x/c$	$y_u/c$	$y_l/c$
0.00	0.00	0.00
.00259	.00704	-.00512
.00974	.01524	-.00867
.02185	.02296	-.01180
.03796	.02972	-.01465
.05675	.03588	-.01713
.07753	.04098	-.01929
.09845	.04469	-.02112
.12341	.04741	-.02299
.15412	.04986	-.02494
.18767	.05188	-.02671
.22313	.05345	-.02821
.26054	.05459	-.02944
.29979	.05531	-.03040
.34064	.05565	-.03104
.38269	.05560	-.03142
.42528	.05518	-.03150
.46849	.05438	-.03132
.51162	.05323	-.03080
.55383	.05175	-.02992
.59596	.04992	-.02867
.63728	.04774	-.02734
.67732	.04524	-.02580
.71079	.04291	-.02432
.73905	.04017	-.02305
.76946	.03644	-.02164
.80263	.03140	-.01996
.84055	.02533	-.01794
.87846	.01901	-.01571
.90845	.01421	-.01364
.93589	.01020	-.01087
.96199	.00651	-.00711
1.00000	.00104	-.00104

TABLE IV.- PADS-PCM DATA SYSTEM CHARACTERISTICS

Parameter	System Accuracy (a)	Digital Channel Precision	Filter (b) Frequency
<b>Aerodynamic Flight State:</b>			
dynamic pressure - regular	70 Pa	14 Pa	1 Hz
- sensitive	14 Pa	3 Pa	—
static pressure - regular	500 Pa	200 Pa	—
- sensitive	70 Pa	40 Pa	—
angle of attack	.1 <sup>o</sup>	.18 <sup>o</sup>	10 Hz
angle of sideslip	.1 <sup>o</sup>	.18 <sup>o</sup>	10 Hz
total temperature	.06 <sup>o</sup> C	.1 <sup>o</sup> C	—
<b>Inertial Flight State:</b>			
roll attitude	.5 <sup>o</sup>	.36 <sup>o</sup>	—
pitch attitude	.5 <sup>o</sup>	.18 <sup>o</sup>	—
heading	3.0 <sup>o</sup>	.72 <sup>o</sup>	—
angular rates	.01 rad/sec	.044 rad/sec	10 Hz
longitudinal acceleration	.001 g	.004 g	10 Hz
lateral acceleration	.001 g	.003 g	10 Hz
normal acceleration	.005 g	.009 g	10 Hz
<b>Control Positions:</b>			
lateral servo	.1 <sup>o</sup>	.04 <sup>o</sup>	10 Hz
longitudinal servo	.1 <sup>o</sup>	.07 <sup>o</sup>	10 Hz
collective servo	.1 <sup>o</sup>	.05 <sup>o</sup>	10 Hz
horizontal fin	.1 <sup>o</sup>	.02 <sup>o</sup>	10 Hz
pedal position	.16 <sup>o</sup>	.07 <sup>o</sup>	10 Hz
tail-rotor collective	.1 <sup>o</sup>	.07 <sup>o</sup>	10 Hz
<b>Rotor/Engine Parameters:</b>			
main-rotor speed - regular	.5%	.23%	—
-sensitive	.1%	.05%	—
main-rotor azimuth	1 <sup>o</sup>	22.5 <sup>o</sup>	—
engine torque pressure	3 kPa	1.3 Pa	—
fuel quantity	60	40	—

Notes: a - accuracy of analog signal before digitization

b - frequency at 3 db roll-off for constant delay, 4 pole Bessel Filters

TABLE V.- CHARACTERISTICS OF ROTOR-DPTA SENSORS AND CHANNELS

Parameter	Analog system accuracy	Digital channel precision	(a)	Data reduction parameters (b)			
			Maximum final-data error	$m_1$ (1/mV)	$\Delta m_2 \times 10^7$ (mV/count-C)	$\Delta V_0$ (mV/C)	$\Delta P_0$ (N/C)
$\beta_s$	.1°	.11 <sup>Å</sup>	.3°	.92°	745.	-.005	-
$\theta_s$	.1°	.23°	.8°	.45°	780.	-.0031	-
$\psi$	-	1.41°	.3°	-	-	-	-
$F_{db}$	70 N	546. N	.44 kN-m	284 N	509.	-.009	-
$F_{p1}$	36 N	123.4 N	.47 kN	56.9 N	431.	-.005	-
$M_{b17}$	-	73.4 N-m	.28 kN-m	1081 N-m	529.	-.006	25.8
$M_{b35}$	-	25.1 N-m	.10 kN-m	598 N-m	698.	-.005	11.2
$M_{b45}$	-	25.4 N-m	.10 kN-m	374 N-m	572.	-.0068	8.3
$M_{b61}$	-	19.4 N-m	.07 kN-m	354 N-m	396.	-.0046	13.2
$M_{b80}$	-	17.5 N-m	.07 kN-m	-208 N-m	666.	-.010	16.5
$M_{c45}$	-	149. N-m	.55 kN-m	3460 N-m	333.	-.003	79.1
$M_{c80}$	-	74.6 N-m	1.07 kN-m	-4200 N-m	149.	-.0017	220.
$M_{t45}$	-	14.8 N-m	.06 kN-m	547 N-m	215.	-.0023	0.7
$Q$	112 N-m	158. N-m	.60 kN-m	1440 N-m	941.	-.0135	-
$T_b$	-	.40° C	1.0° C	-	-	-	-
$T_{ce}$	-	.39° C	1.0° C	-	-	-	-

Notes: (a) conservative accuracy bound for absolute value of single digital-data value  
 (b) constants used in the data-reduction equations of reference 6

$$f = (m_1 (\Delta m_2 + \Delta V_0)) \Delta T_{ce} + \Delta P_0 \Delta T_b$$

TABLE VI.- LINEARIZED STATIC INTERACTIONS FOR BLADE STRAIN-GAUGE BRIDGES

Type of input load	Level of input load (a) (kN-m)	Type of output load (b)	$\frac{\text{Indicated output}}{\text{Actual input}}$
Beamwise	4.3	M <sub>c45</sub>	0.14
	1.1	M <sub>c80</sub>	-0.30
	4.3	M <sub>t45</sub>	0.01
Chordwise	15.7	M <sub>b17</sub>	0.20 (c)
	12.0	M <sub>b35</sub>	0.14
	10.0	M <sub>b45</sub>	0.07
	6.7	M <sub>b61</sub>	0.03
Torsion	1.0	M <sub>b17</sub>	0.09
		M <sub>b35</sub>	0.08
		M <sub>b45</sub>	0.04
		M <sub>b61</sub>	0.04
		M <sub>b80</sub>	0.01
		M <sub>c45</sub>	0.44
		M <sub>c80</sub>	0.09

Note: (a) equivalent load at same spanwise station as indicated output bridge  
 (b) uncited output channels have negligible cross-talk  
 (c) all beamwise values conservative at higher input loads

TABLE VII.- TEST POINT/TEST CONDITION CATALOG

Flight condition	Test Point (Flight no.-run no.)	$\mu$	V (knots)	$C_L'$
Hover	61 - 26B	0	0	0.0034
	65 - 1	0	0	0.0037
	66 - 1	0	0	0.0039
Level flight	60 - 6	0.241	107	0.0038
	61 - 3	.160	71	0.0037
	4	.181	80	0.0038
	12	.305	135	0.0037
	14	.338	150	0.0035
	62 - 16	.246	109	0.0040
	26	.237	105	0.0038
	63 - 1	.151	68	0.0042
	2	.175	78	0.0043
	3	.197	88	0.0043
	4	.212	94	0.0042
	5	.236	105	0.0042
	6	.257	114	0.0043
	7	.282	125	0.0043
	8	.303	134	0.0042
	9	.330	146	0.0044
	10	.356	158	0.0042
	11*	.370	165	0.0044
	13	.315	140	0.0042
	14	.341	152	0.0043
	24	.246	109	0.0039
65 - 2	.240	107	0.0037	
15	.243	108	0.0037	
21	.241	107	0.0037	
Climb	62 - 31	.248	110	0.0039
	63 - 12	.298	134	0.0042
Descent	62 - 30	.236	105	0.0039
Right turn	62 - 23	.244	109	0.0054
	24	.242	108	0.0048
	65 - 22	.241	107	0.0042
	25	.241	108	0.0051

\*Multiple data sets

TABLE VII.- TEST POINT/TEST CONDITION CATALOG (Concluded)

Flight condition	Test Point (Flight no.-run no.)	$\mu$	V (knots)	$C_L'$
Left turn	65 - 16	.242	108	0.0047
	17	.244	109	0.0052
	18	.241	109	0.0062
	19	.241	107	0.0045
	20	.243	109	0.0055
	66 - 3*	.242	108	0.0054
	4	.239	108	0.0063
	7	.224	103	0.0086
	8	.227	106	0.0086
	10	.224	101	0.0059
	Pull-up	63 - 17	.246	110
27		.250	112	0.0050
65 - 11		.245	110	0.0048
12		.241	110	0.0064
66 - 18		.248	112	0.0055
19*		.246	112	0.0068
20		.240	109	0.0059
22*		.245	113	0.0075
24*		.252	116	0.0079

\* Multiple data sets



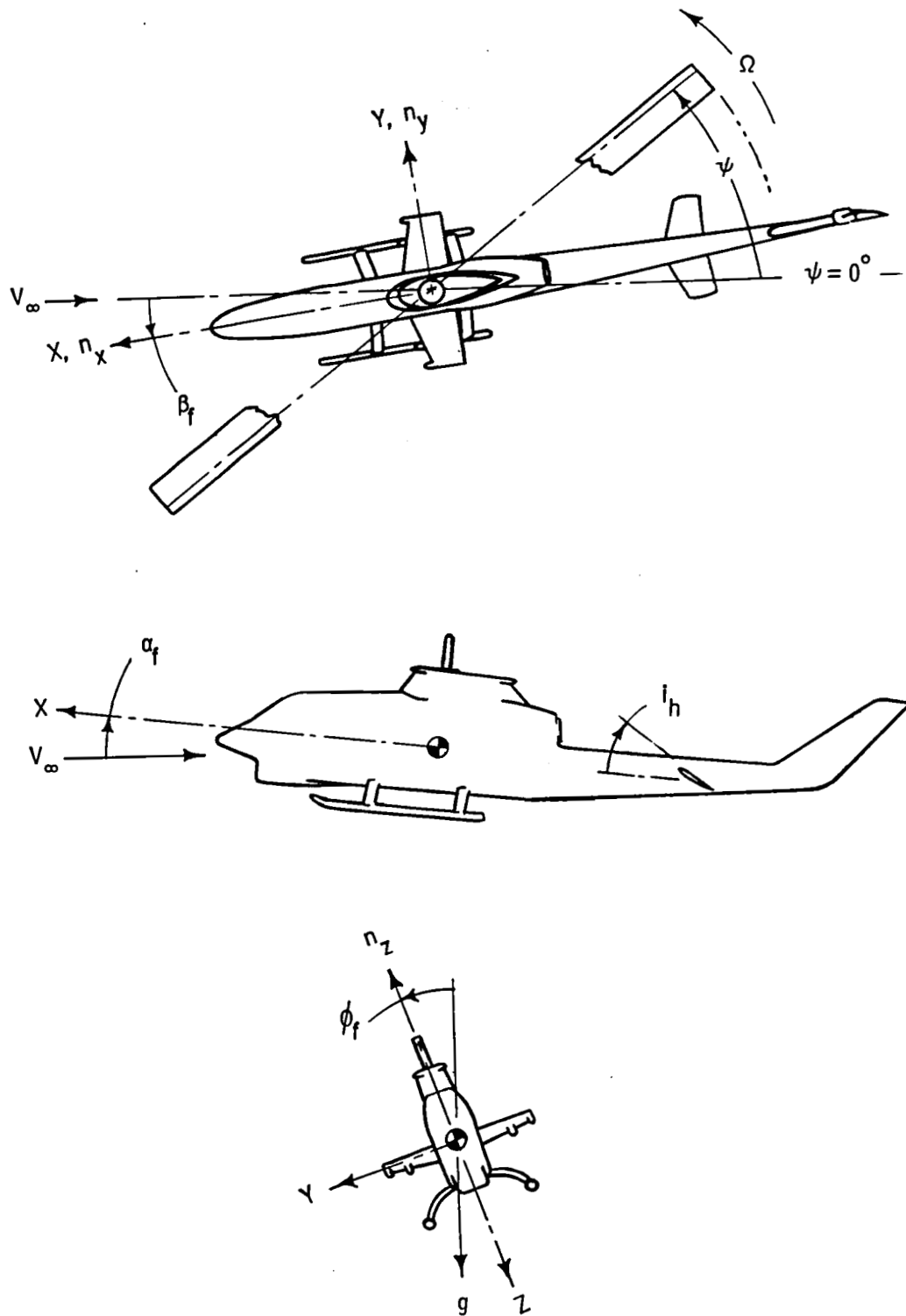

Figure 1. - Aircraft schematic and conventions used to define senses of axes, angles and accelerations.

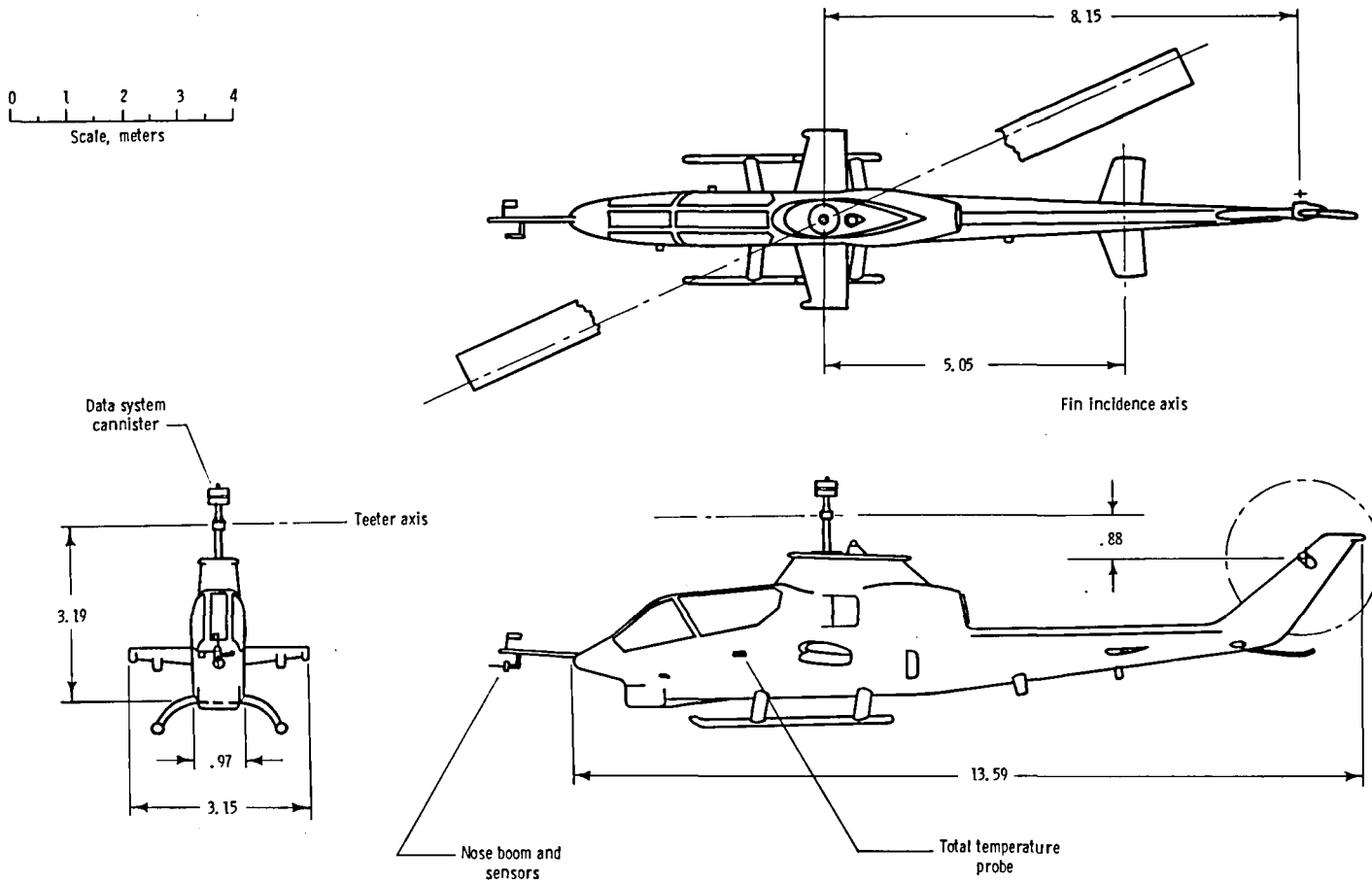

Figure 2. - Three-view scale drawing of aircraft. All dimensions are given in meters.



(a) vehicle in flight



(b) tail rotor

Figure 3. - Flight-test vehicle.

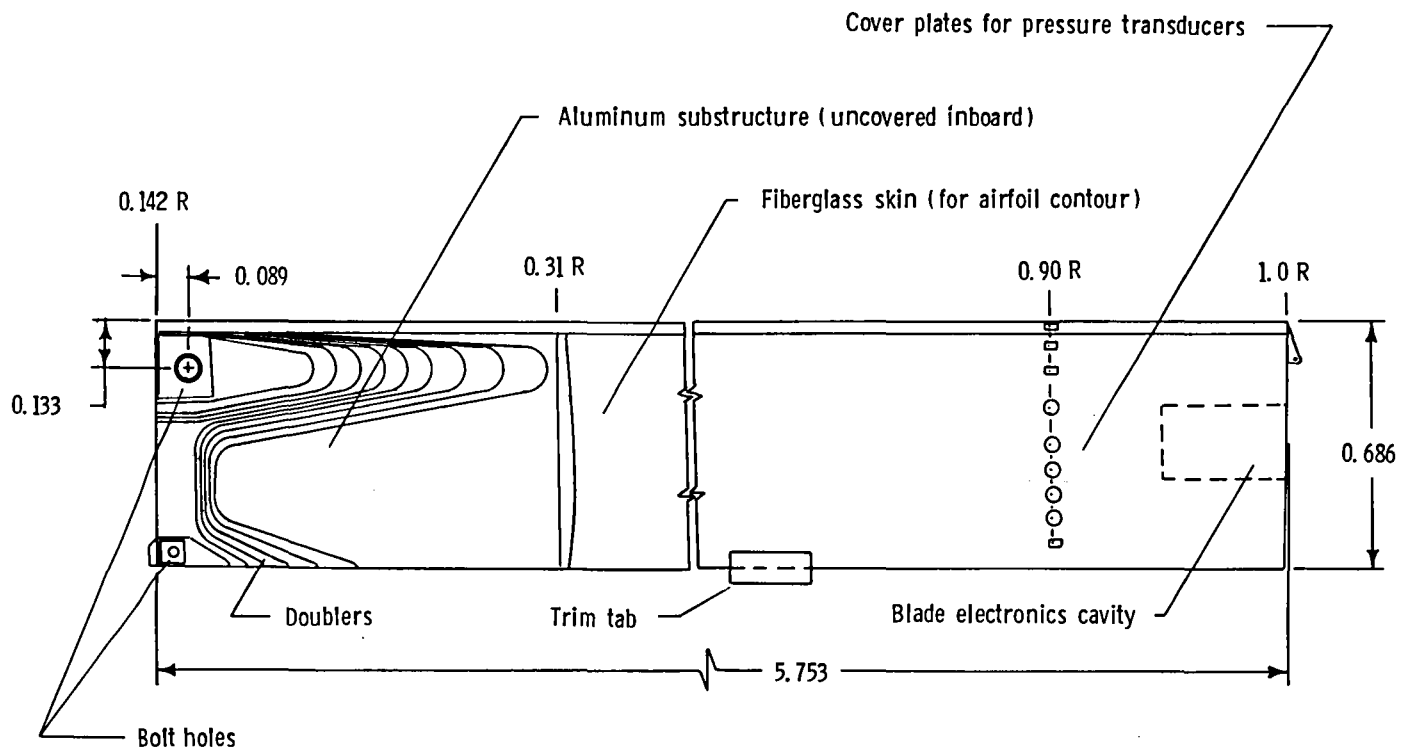

Figure 4. - Planform of main-rotor blade. Dimensions given in meters.

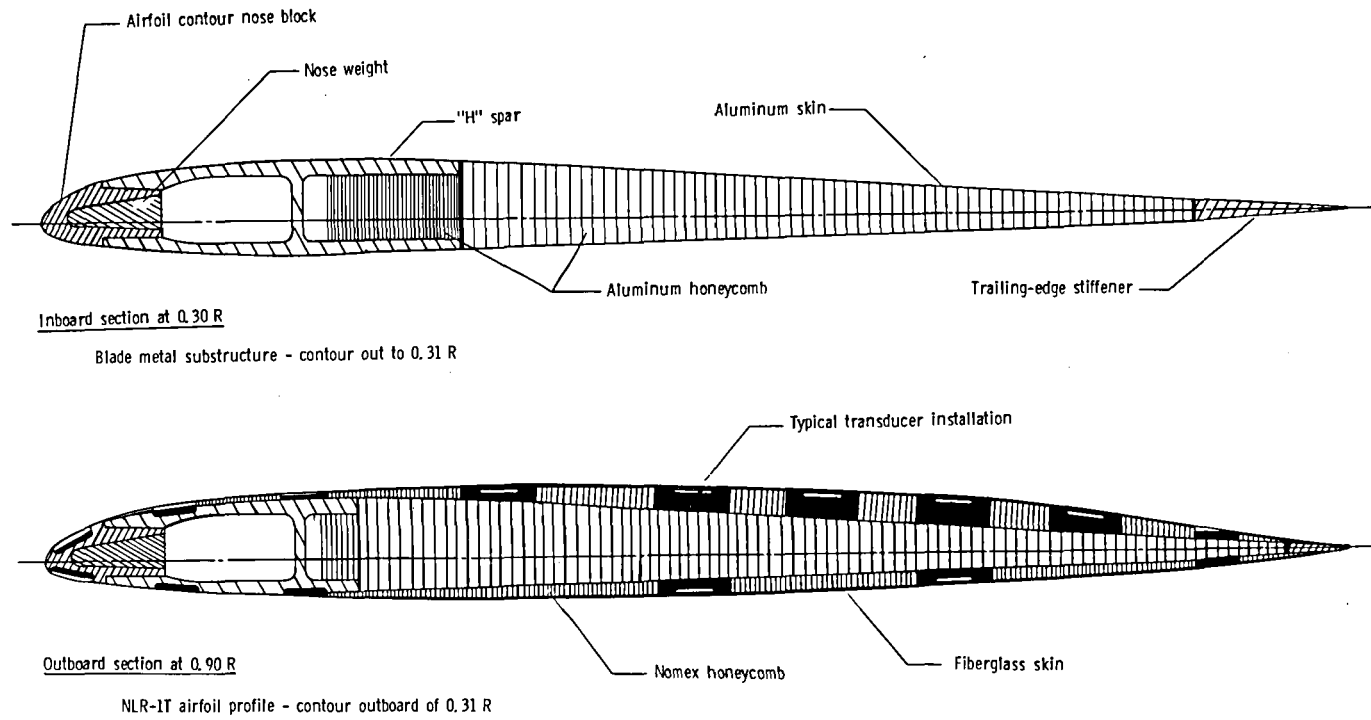
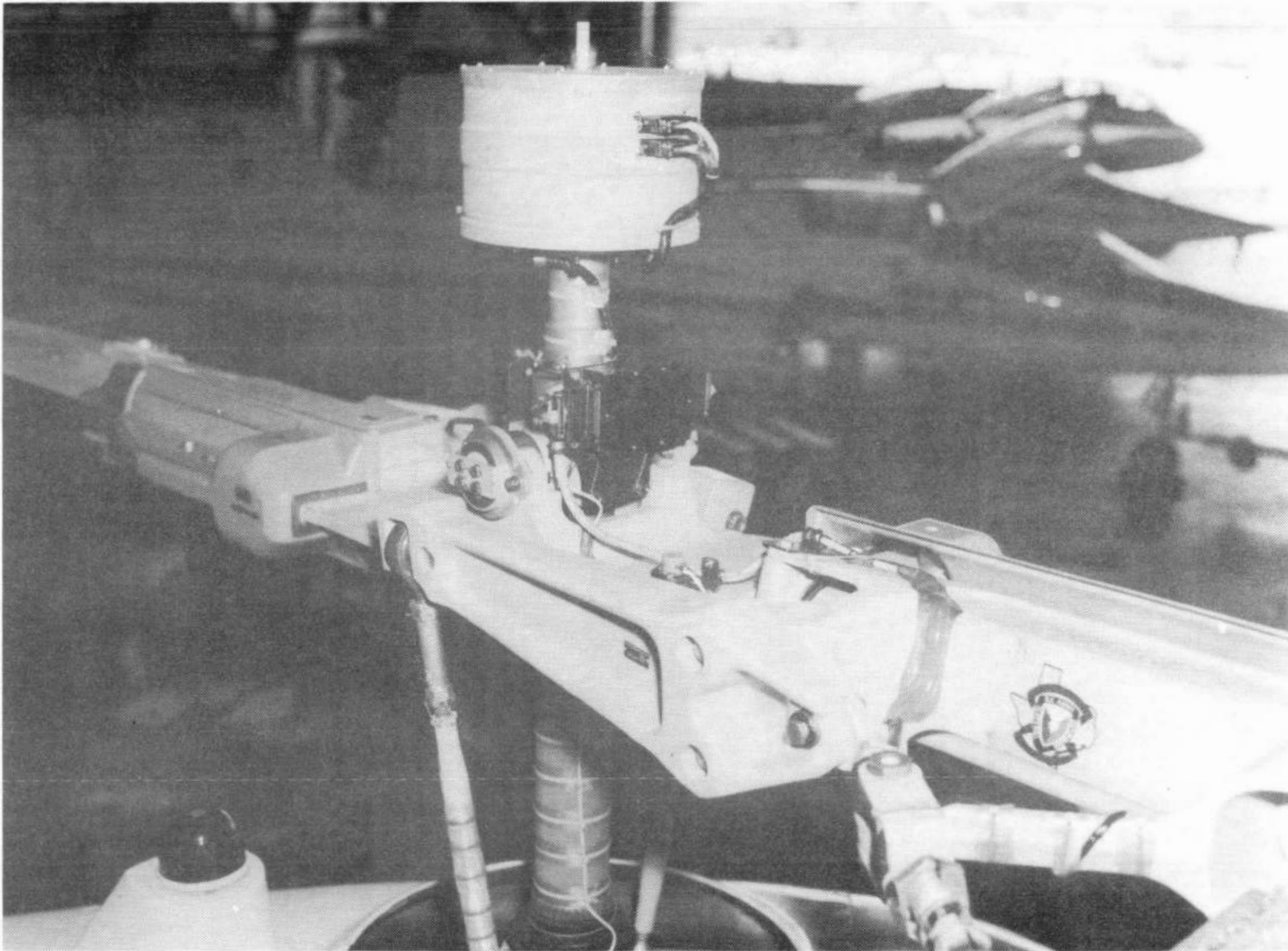
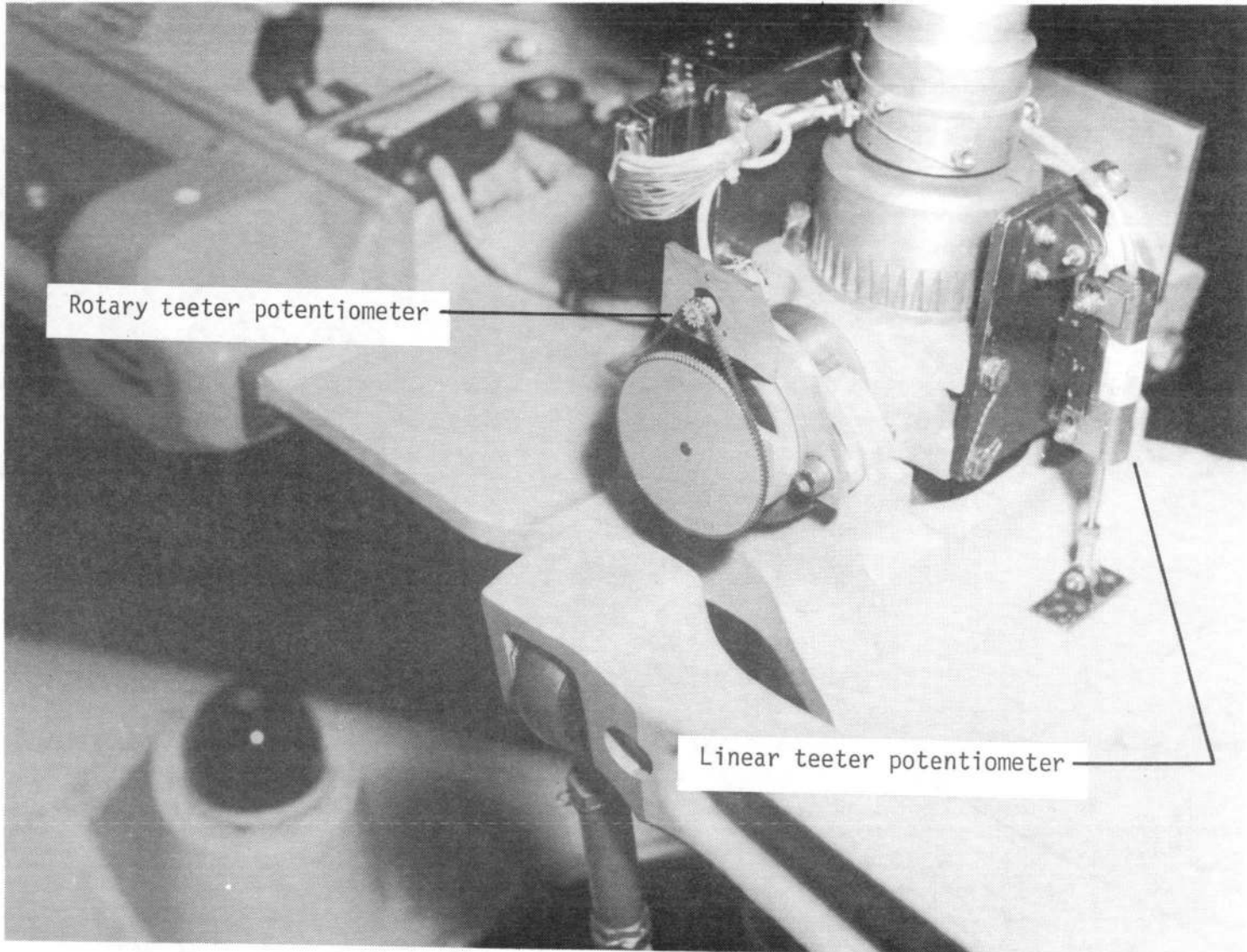

Figure 5. - Cross-section drawings of NLR-1T rotor blades.



(a) SRBI canister and system secured for flight.

Figure 6. - Rotor instrumentation.



(b) Rotor teeter sensors.

Figure 6. - Continued

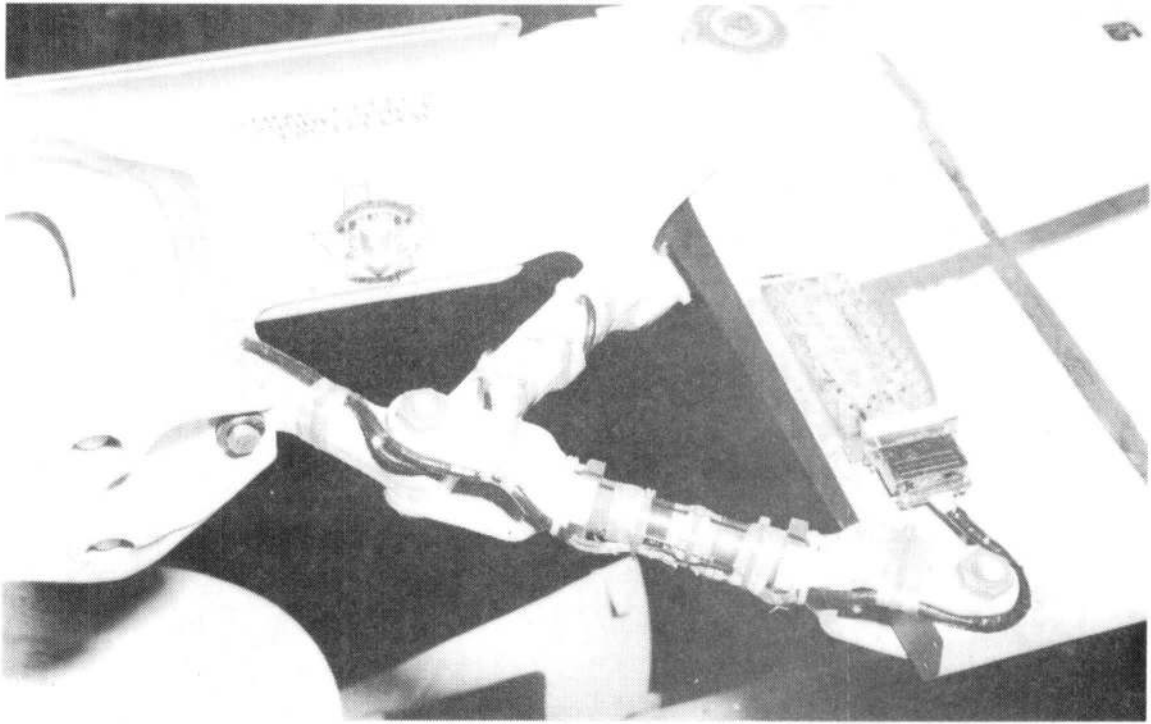

(c) blade root: upper surface.

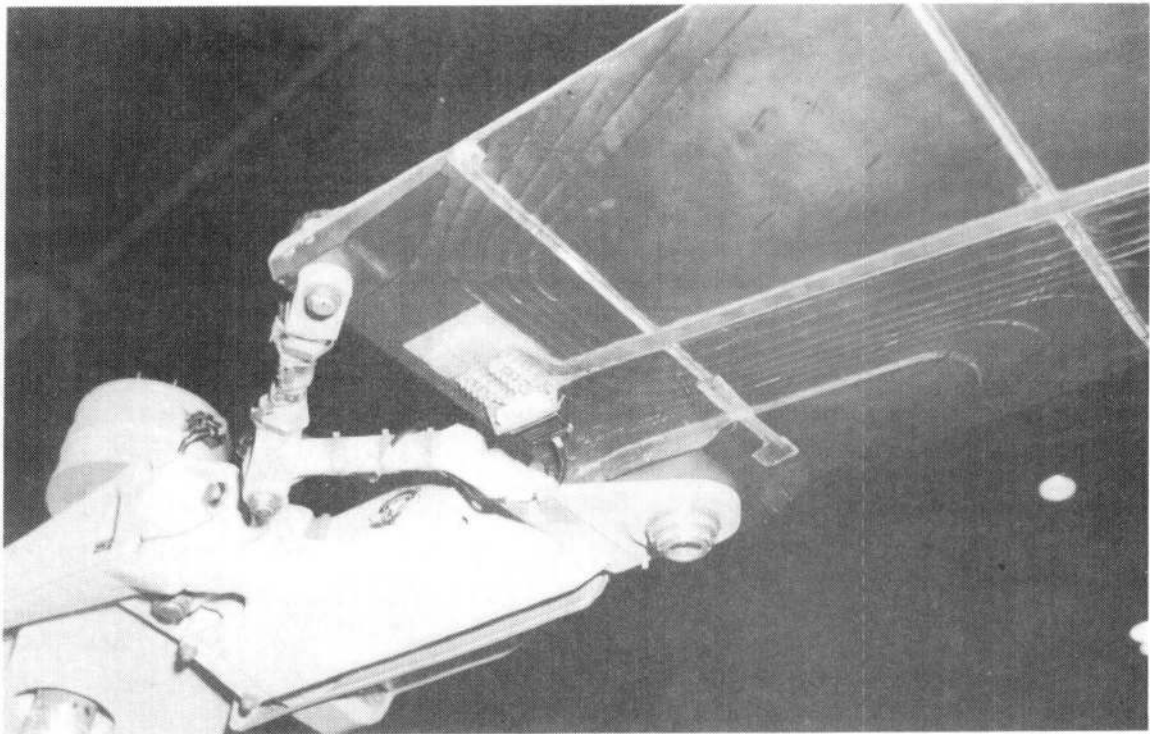

(d) blade root: lower surface.

Figure 6. - Concluded.



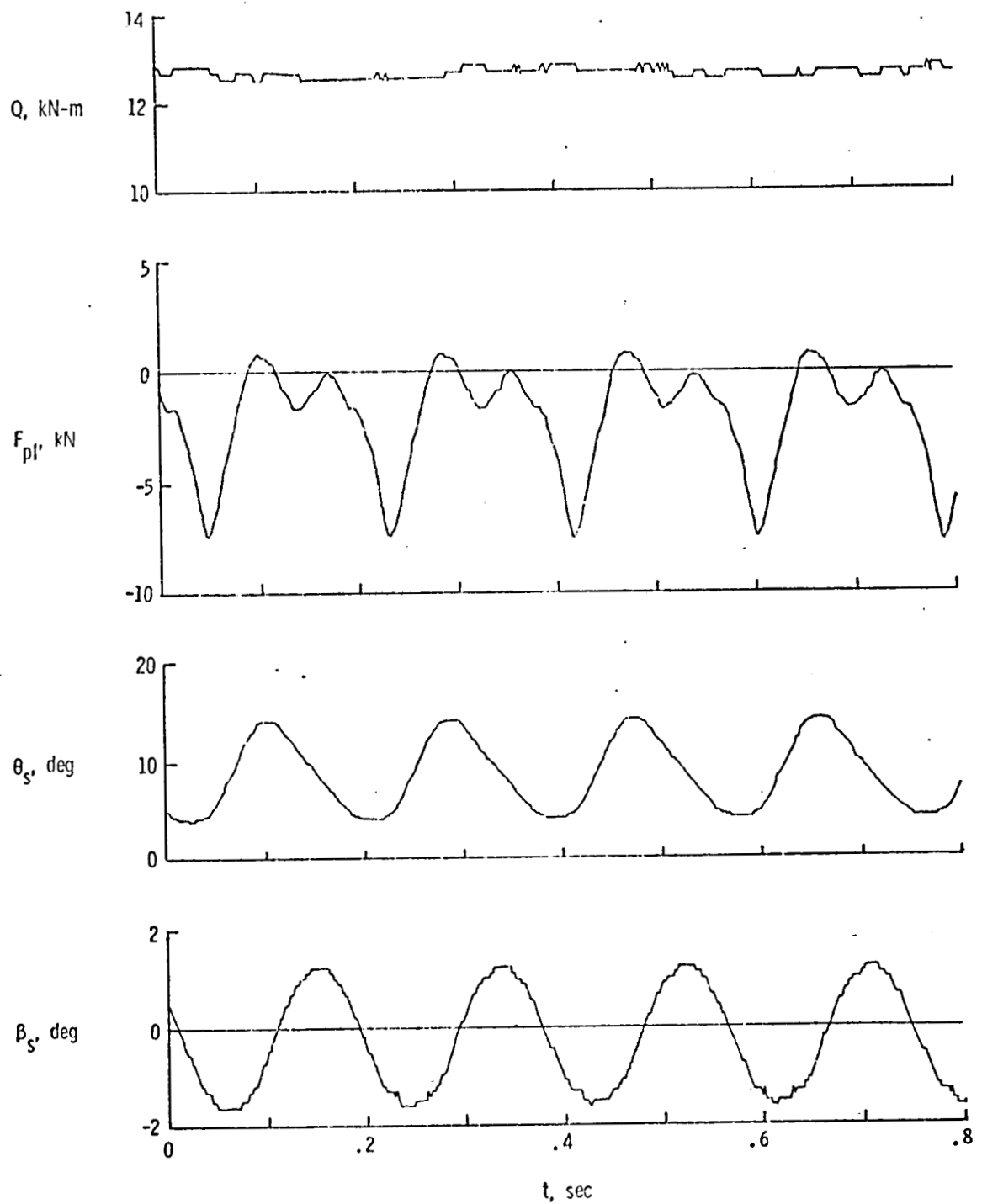
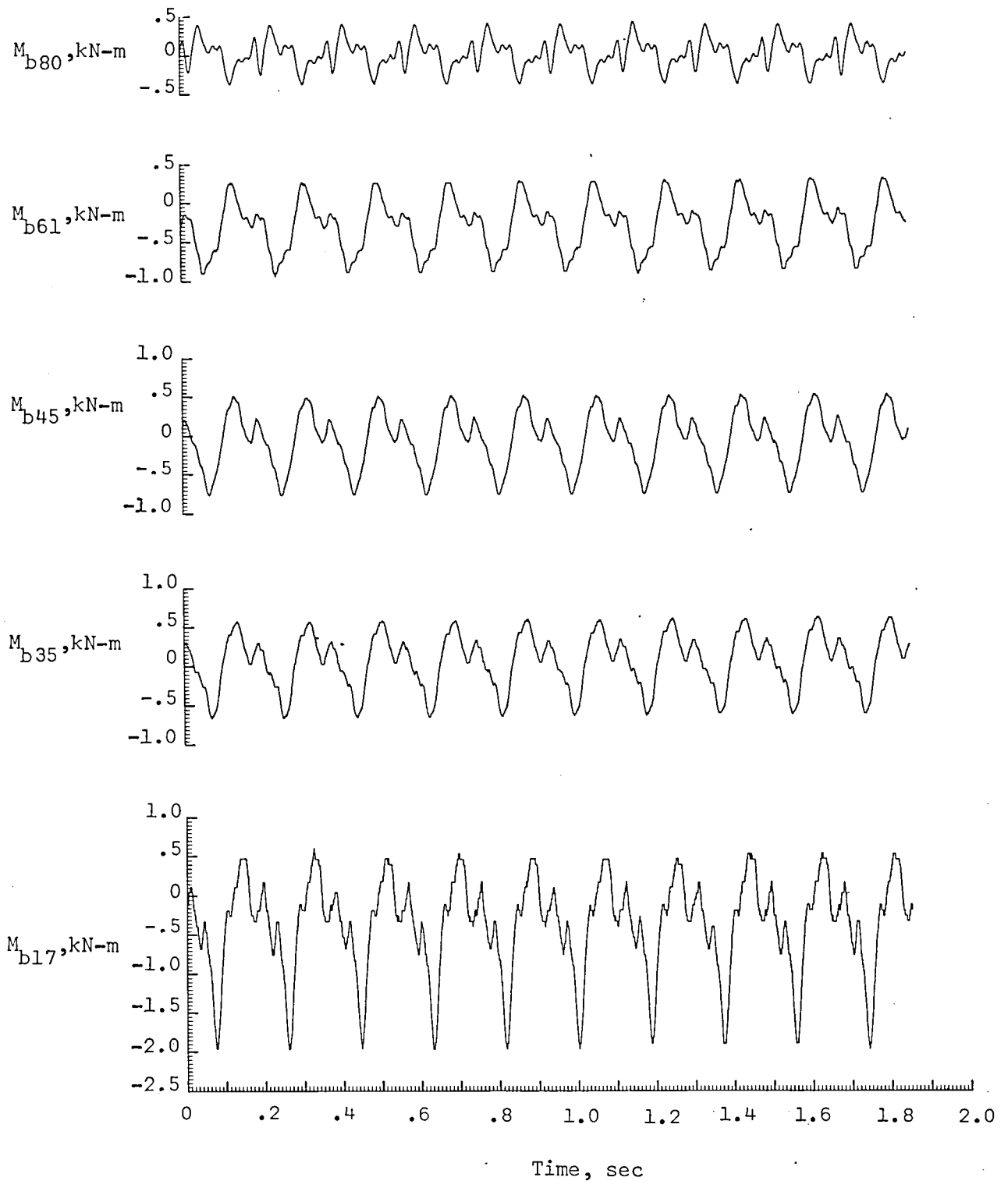
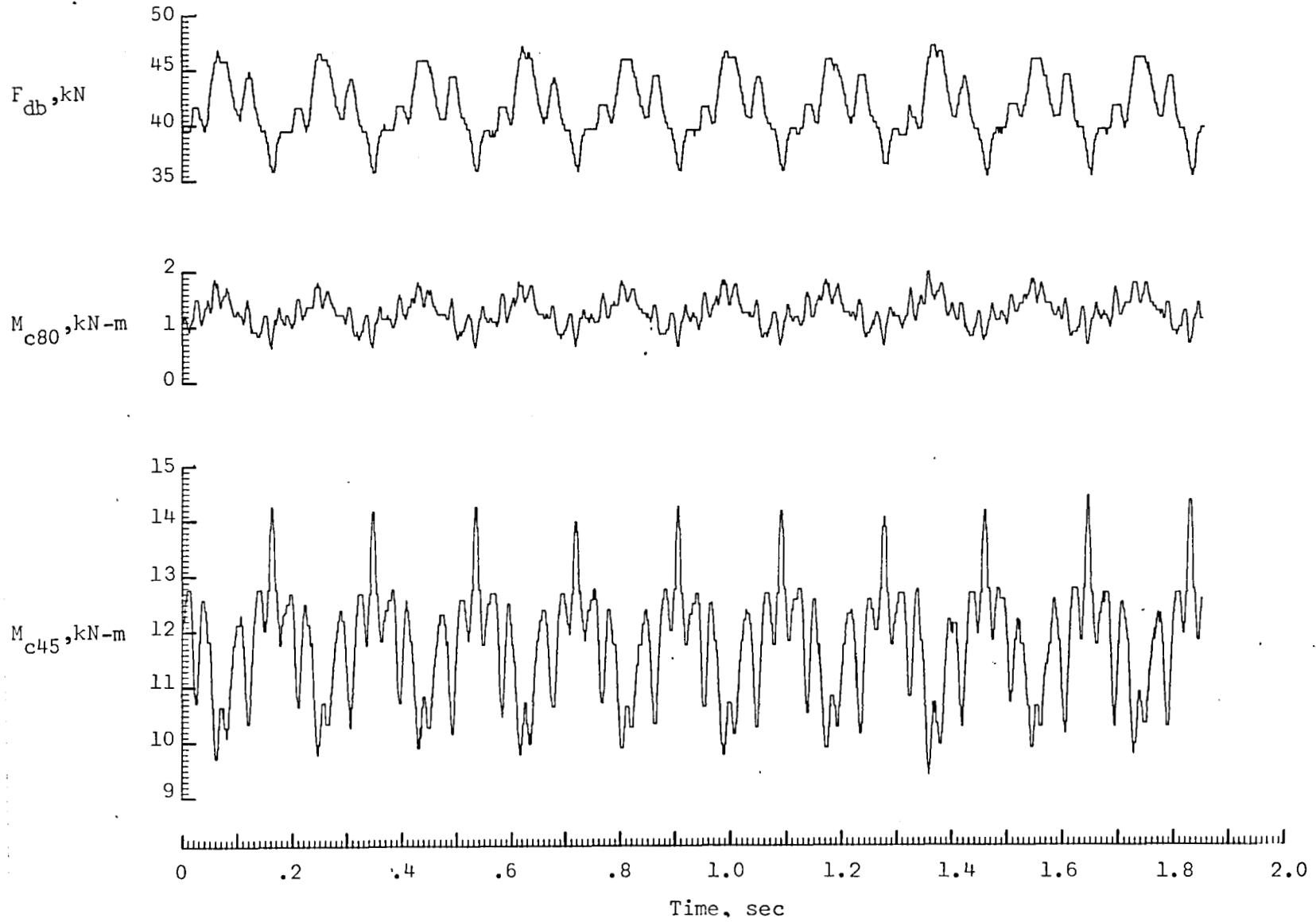

Figure 7. - Typical rotor-data histories for level-flight test point (Flight 65, run 15 of Appendix C).  $\bar{\mu} = 0.24$ ;  $C_L' = 0.0038$ .



(a) Beamwise loads.

Figure 8. - Rotor-load histories for typical level-flight test condition (Flight 65, run 15 of Appendix C).  $\mu = 0.24$ ;  $C_L' = 0.0038$ .



(b) chordwise loads.

Figure 8. - Continued

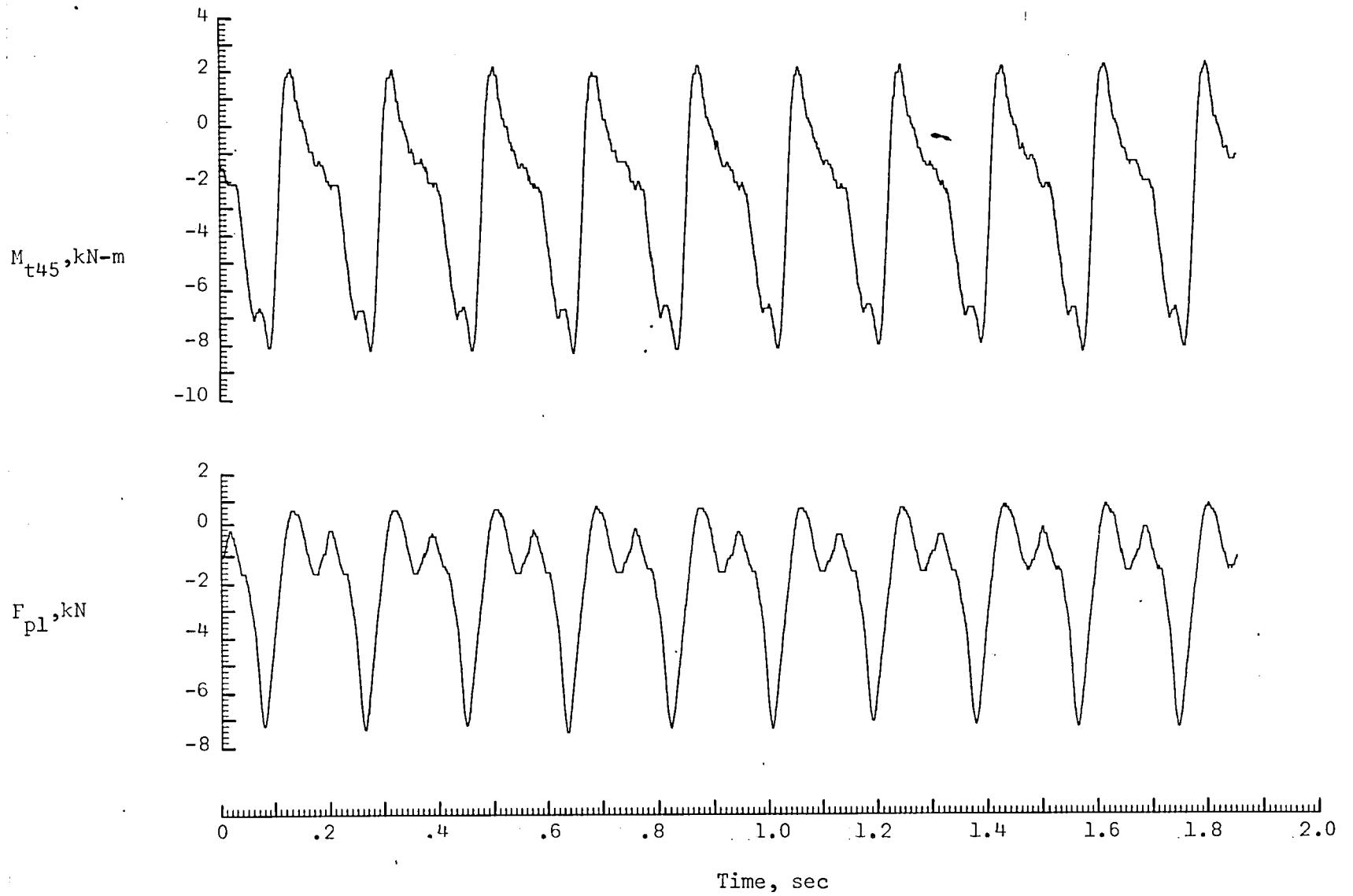

(c) Torsional loads.

Figure 8. - Concluded.

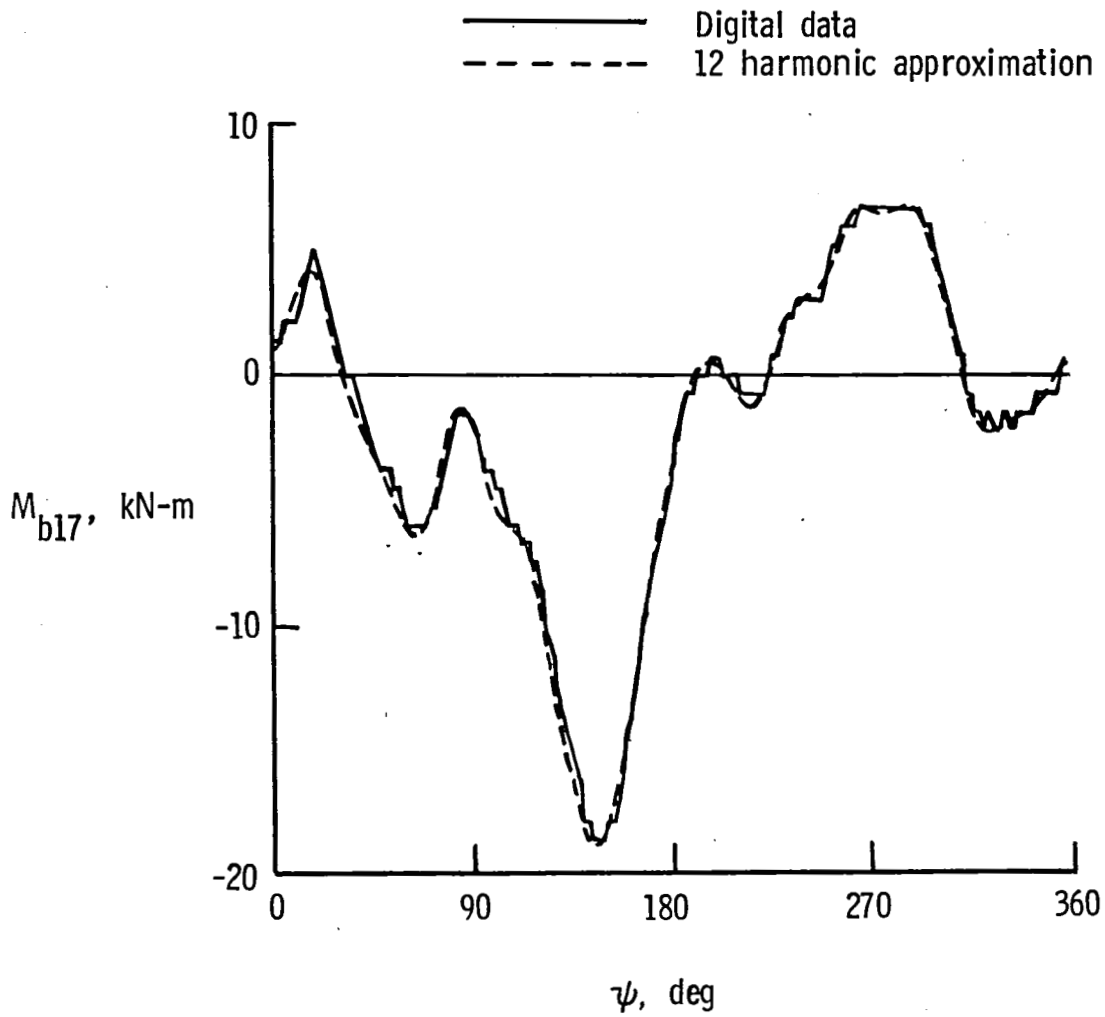

(a) Beamwise bending at 0.17R.

Figure 9. - Comparison of measured and curve-fit loads data for a typical level-flight condition.  $\mu = 0.24$ ,  $C_L' = 0.0036$ ,  $M_h = 0.69$ .

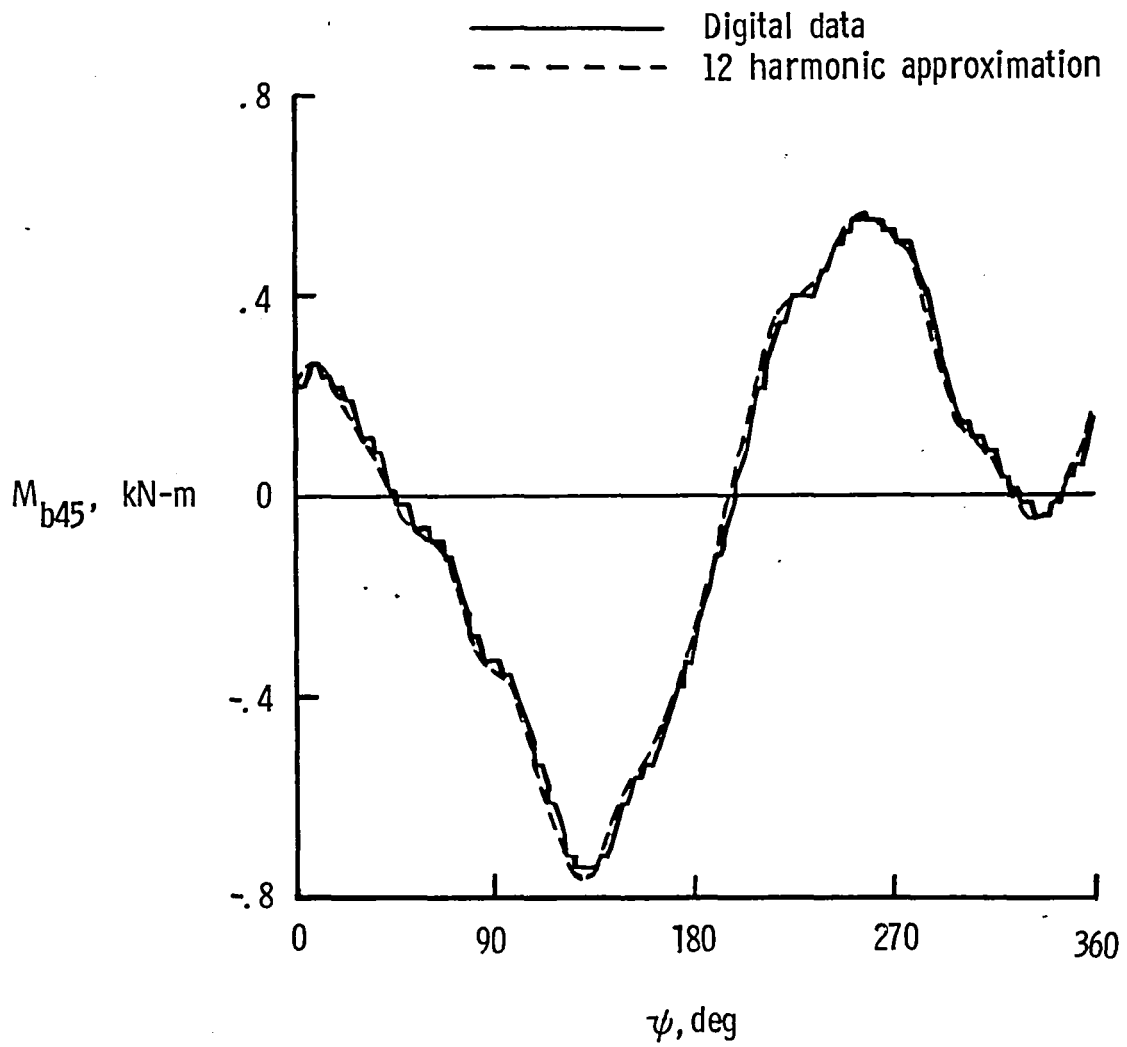

(b) beamwise bending at 0.45R.

Figure 9. - Continued

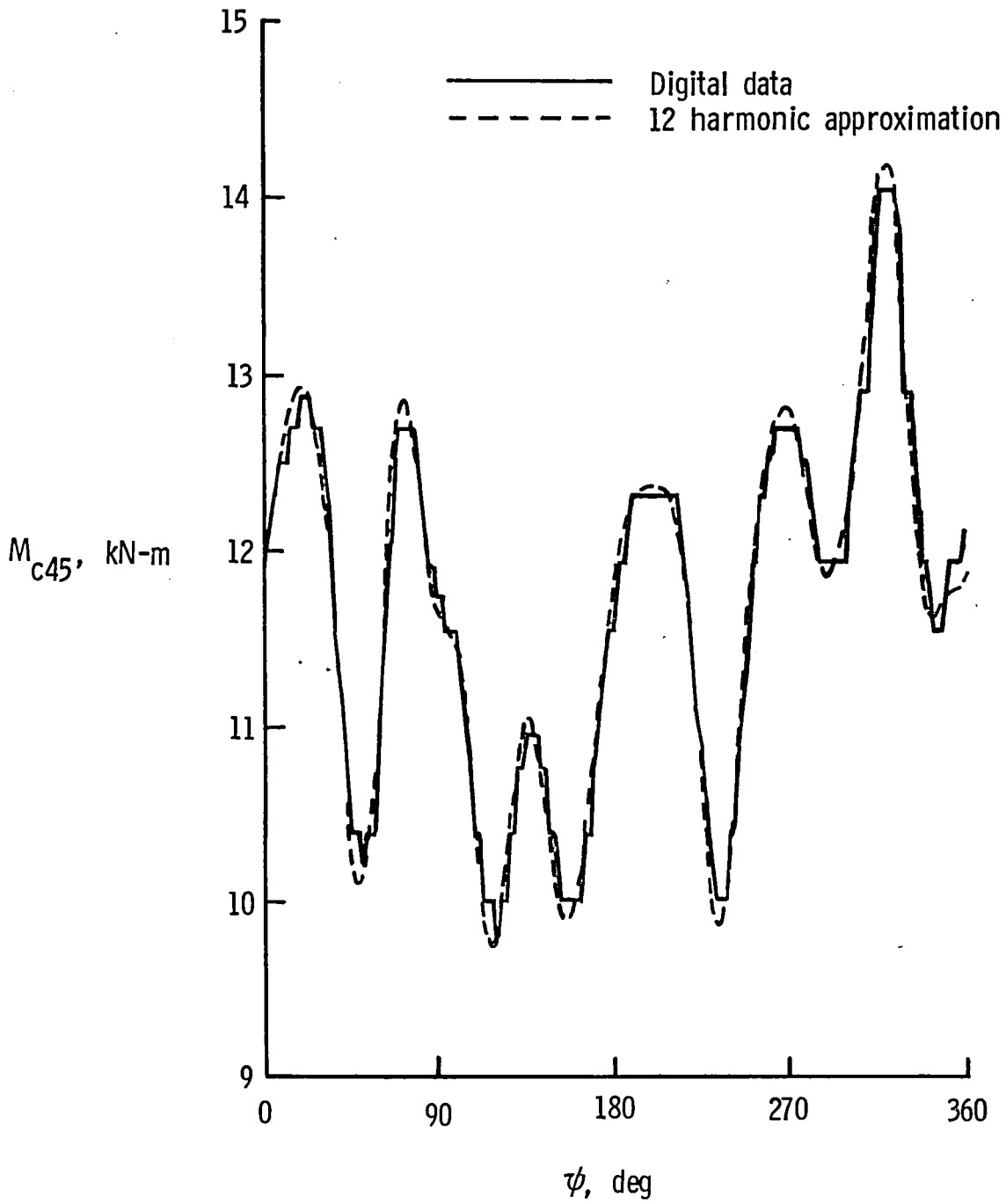

(c) chordwise bending at 0.45R.

Figure 9. - Continued

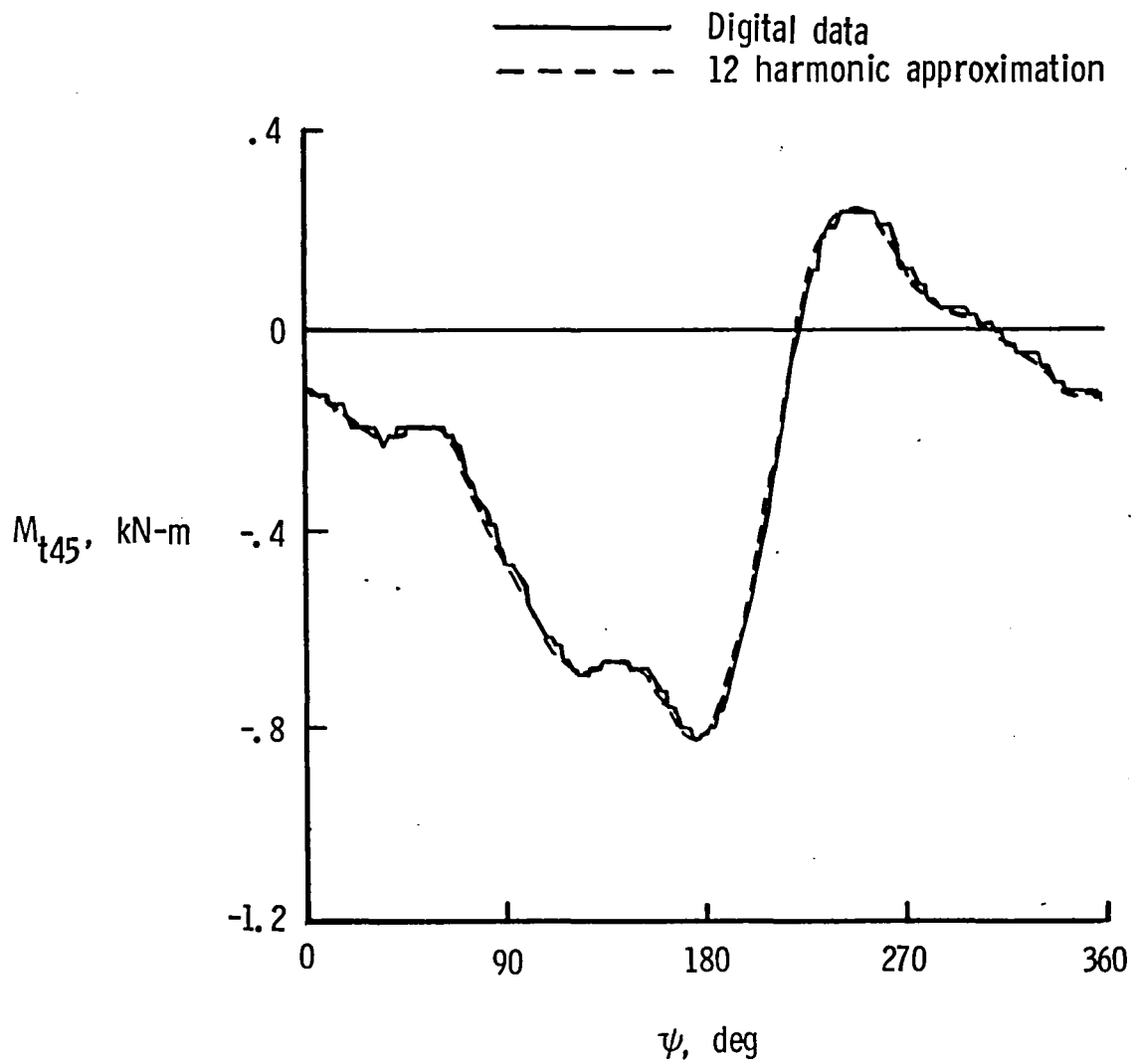

(d) Torsional load at 0.45R.

Figure 9. - Concluded.



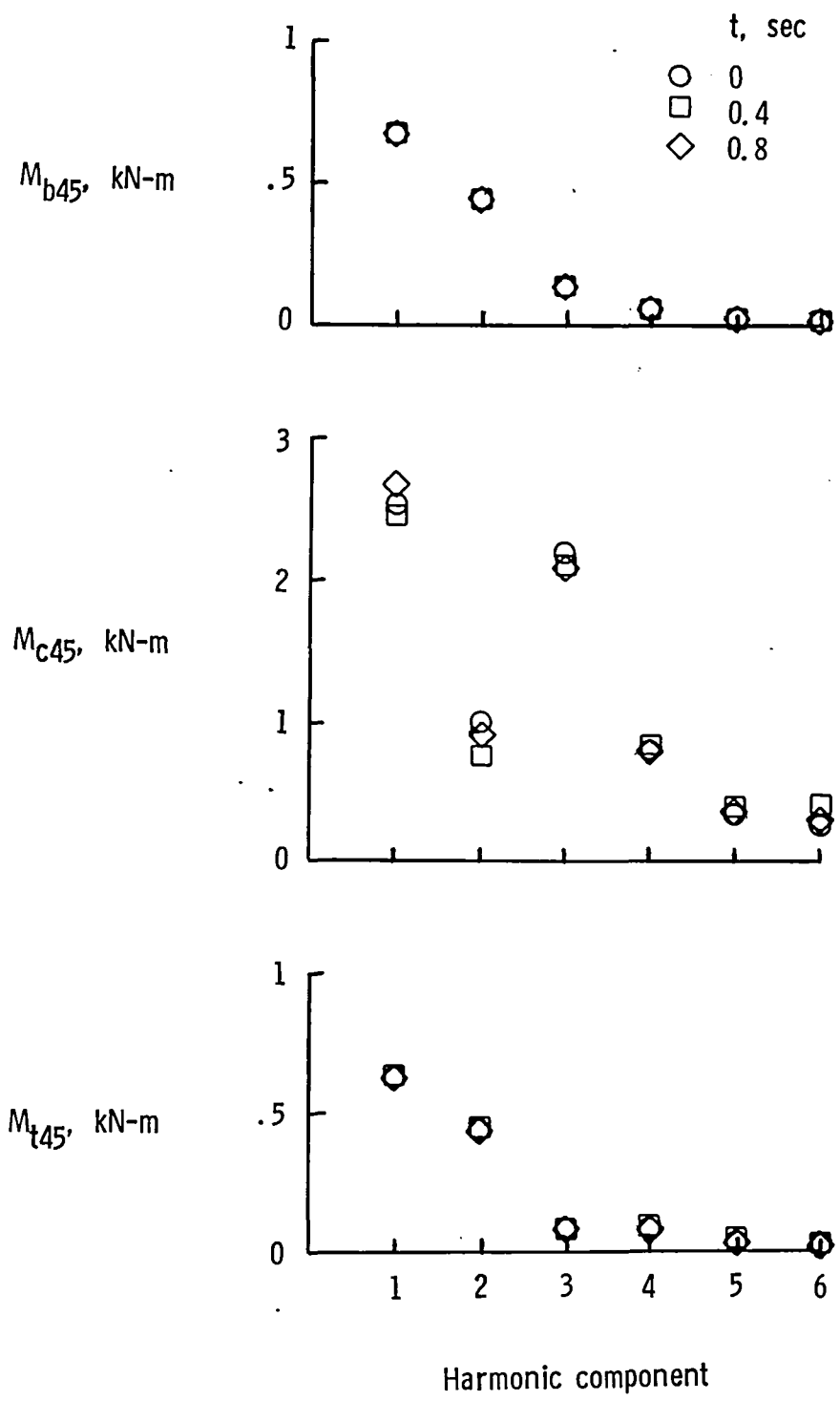

Figure 10. - Comparison of harmonic content of blade loads for several revolutions at the same level-flight test condition (Flight 63, run 11 of Appendix C).  $\mu = 0.37$ ;  $C_L = 0.0044$

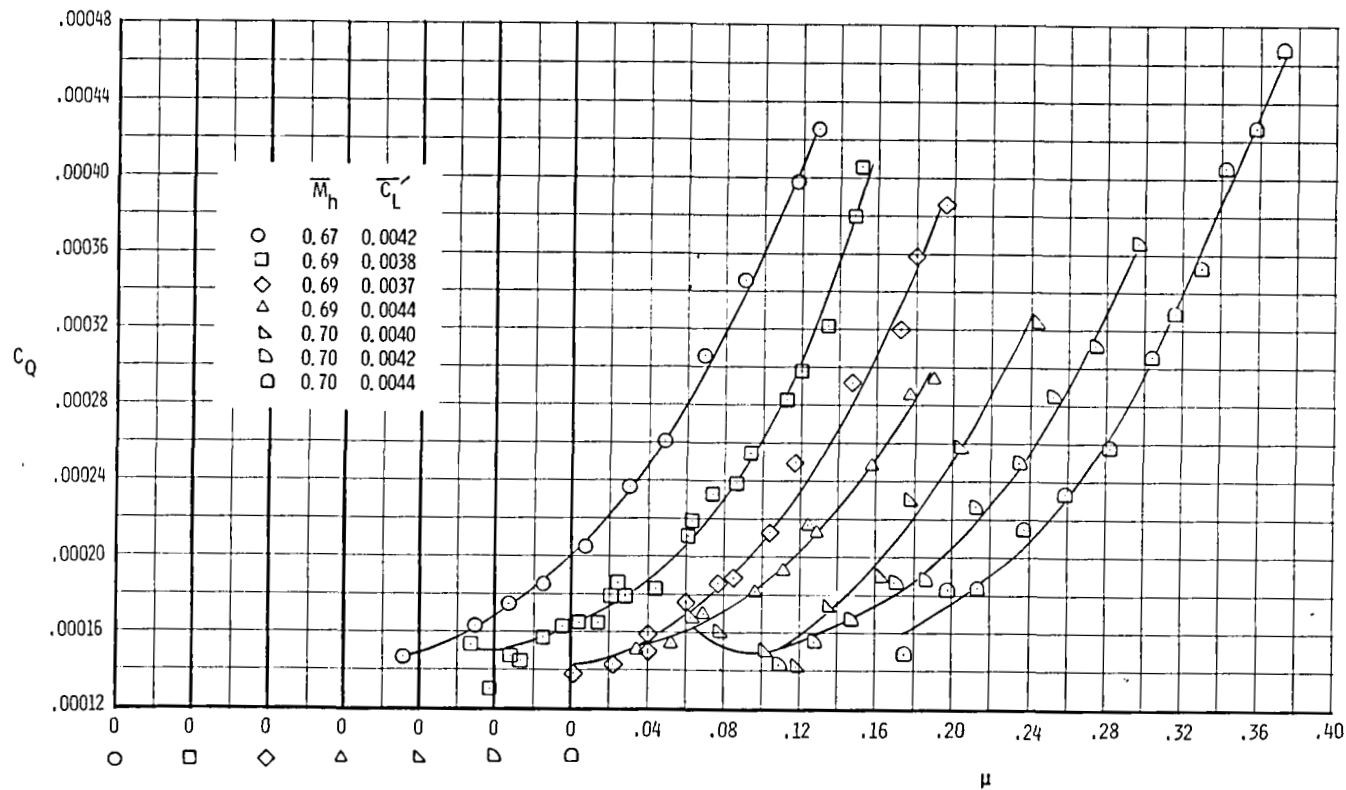
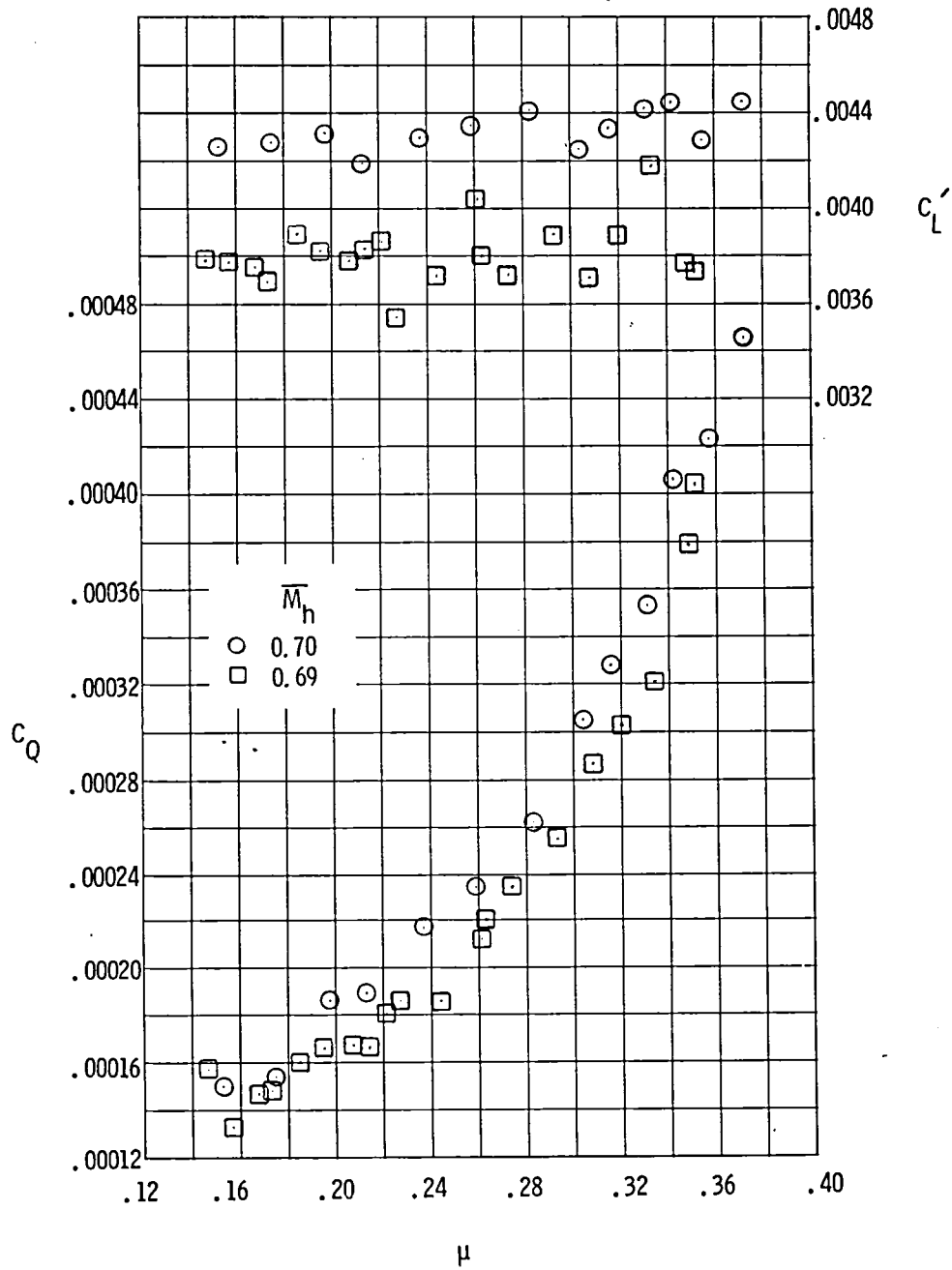
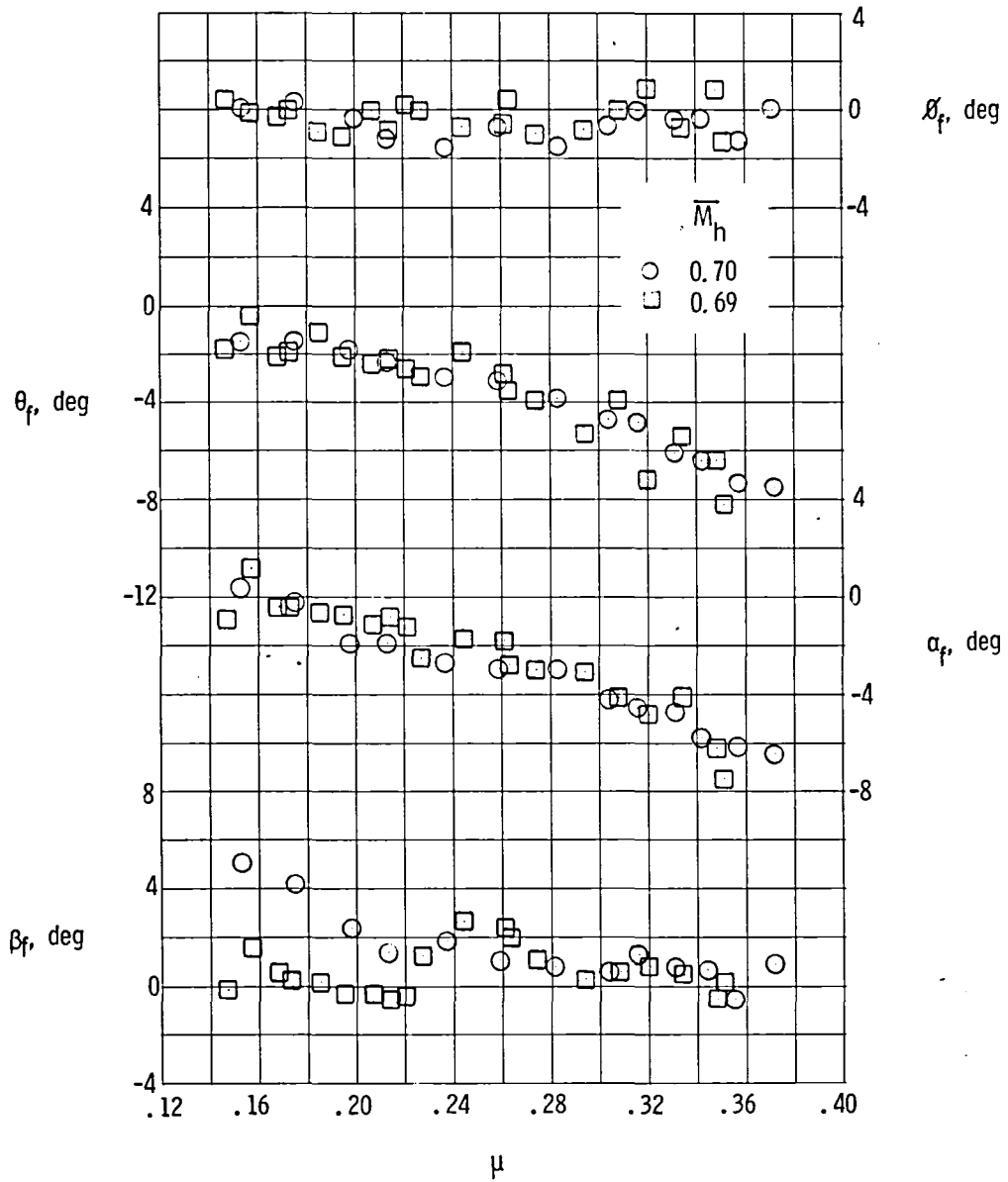

Figure 11. - Variation of power required with tip-speed ratio for a series of test conditions.  
 $\Omega = 33.9$  rad/sec. (324 rpm).



(a) vehicle load and mast torque coefficients.

Figure 12. - Flight data for two level-flight speed sweeps.



(b) Aircraft attitude.

Figure 12. - Continued

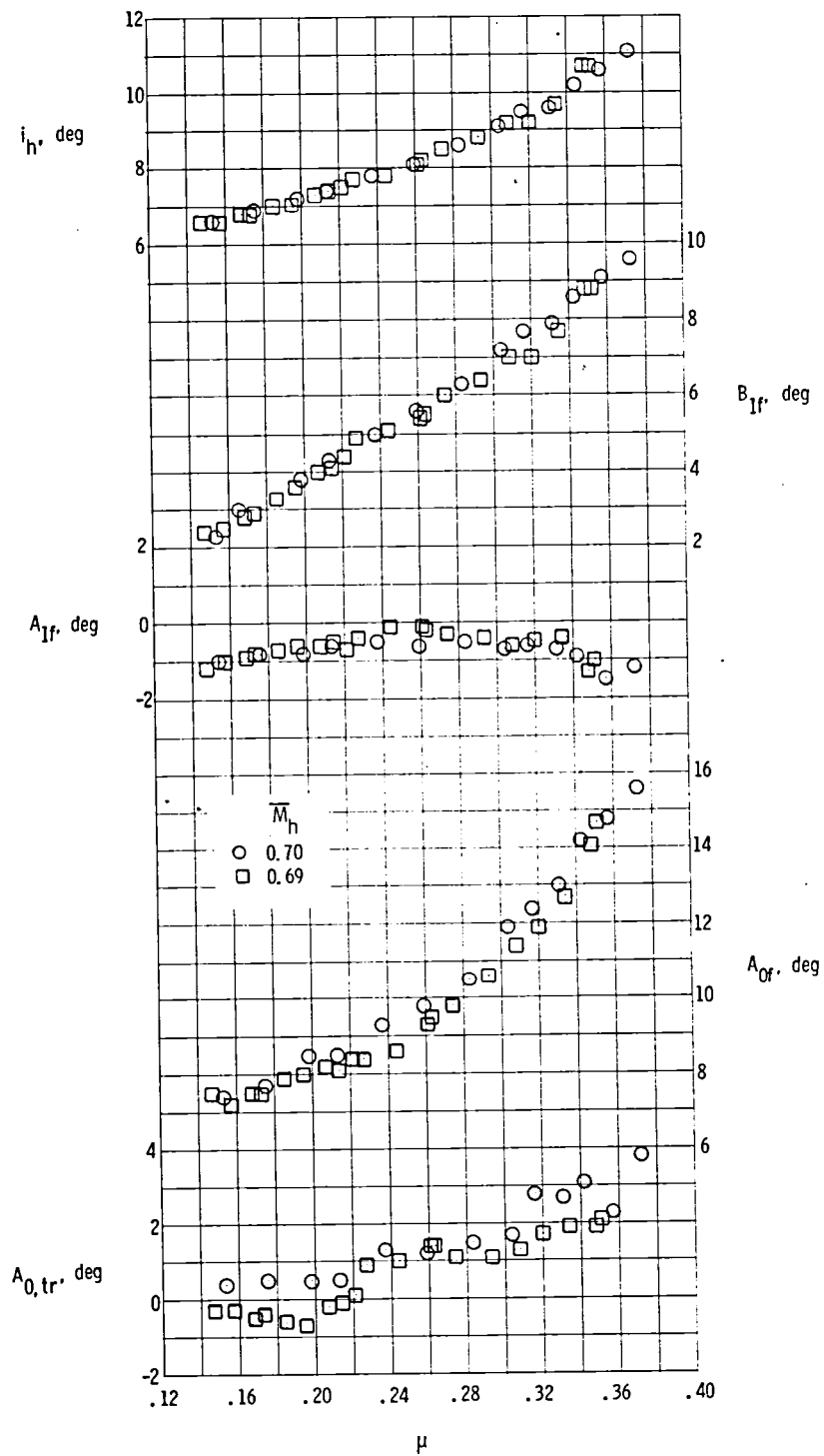

(c) Aircraft control positions.

Figure 12. - Continued

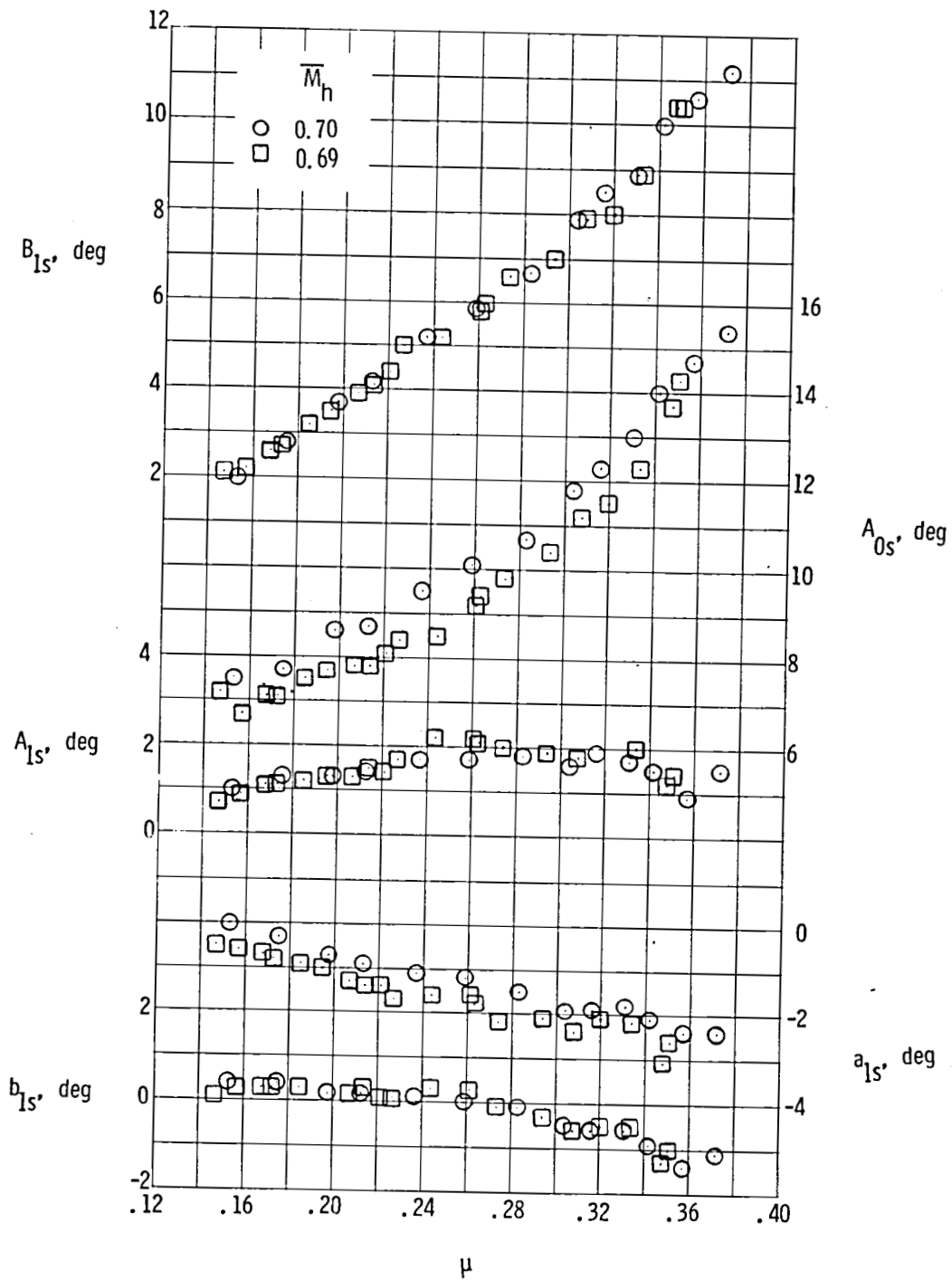

(d) Rotor-blade pitch and teeter angles.

Figure 12. - Continued

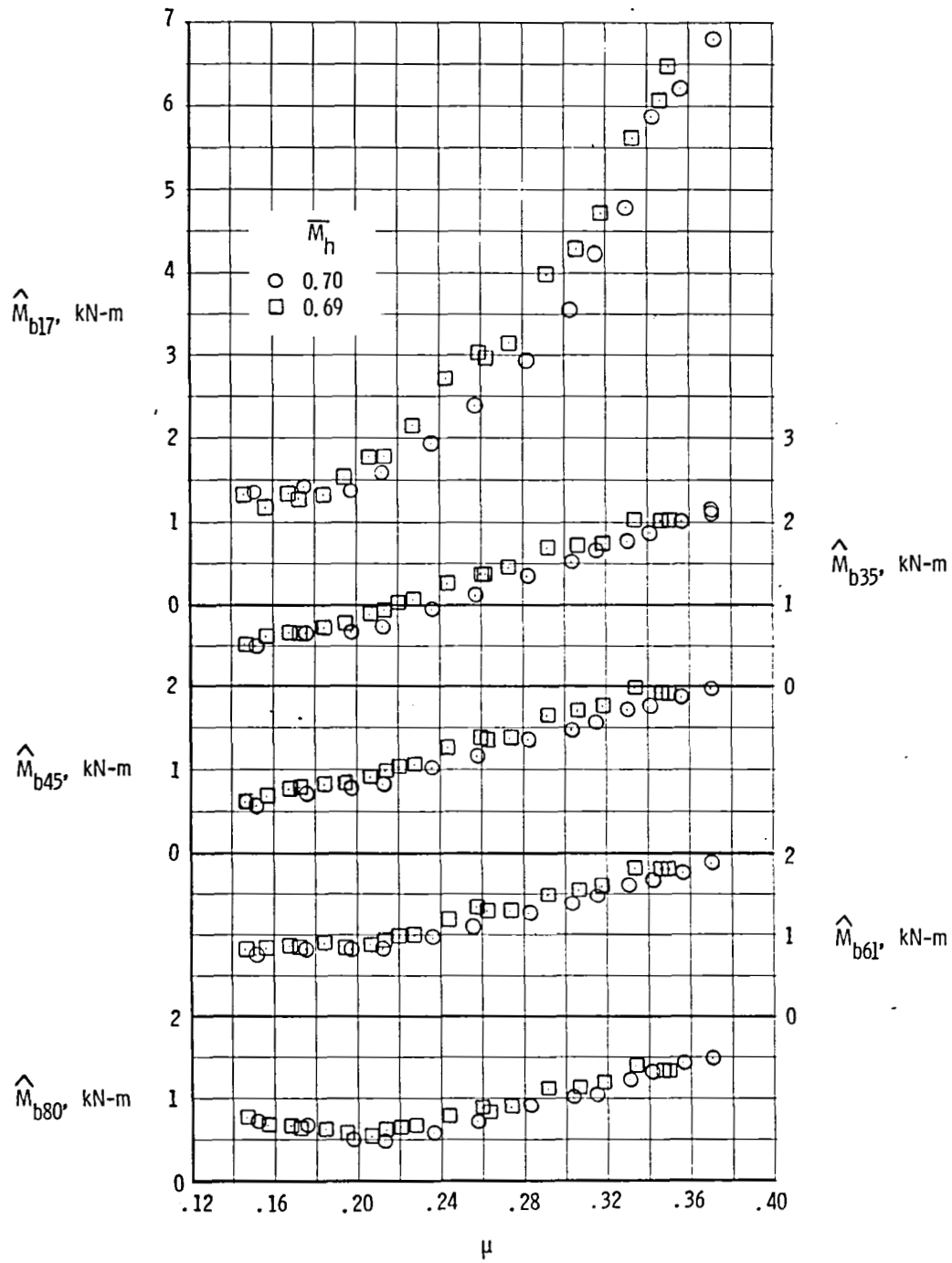

(e) Beamwise peak-to-peak rotor loads.

Figure 12. - Continued

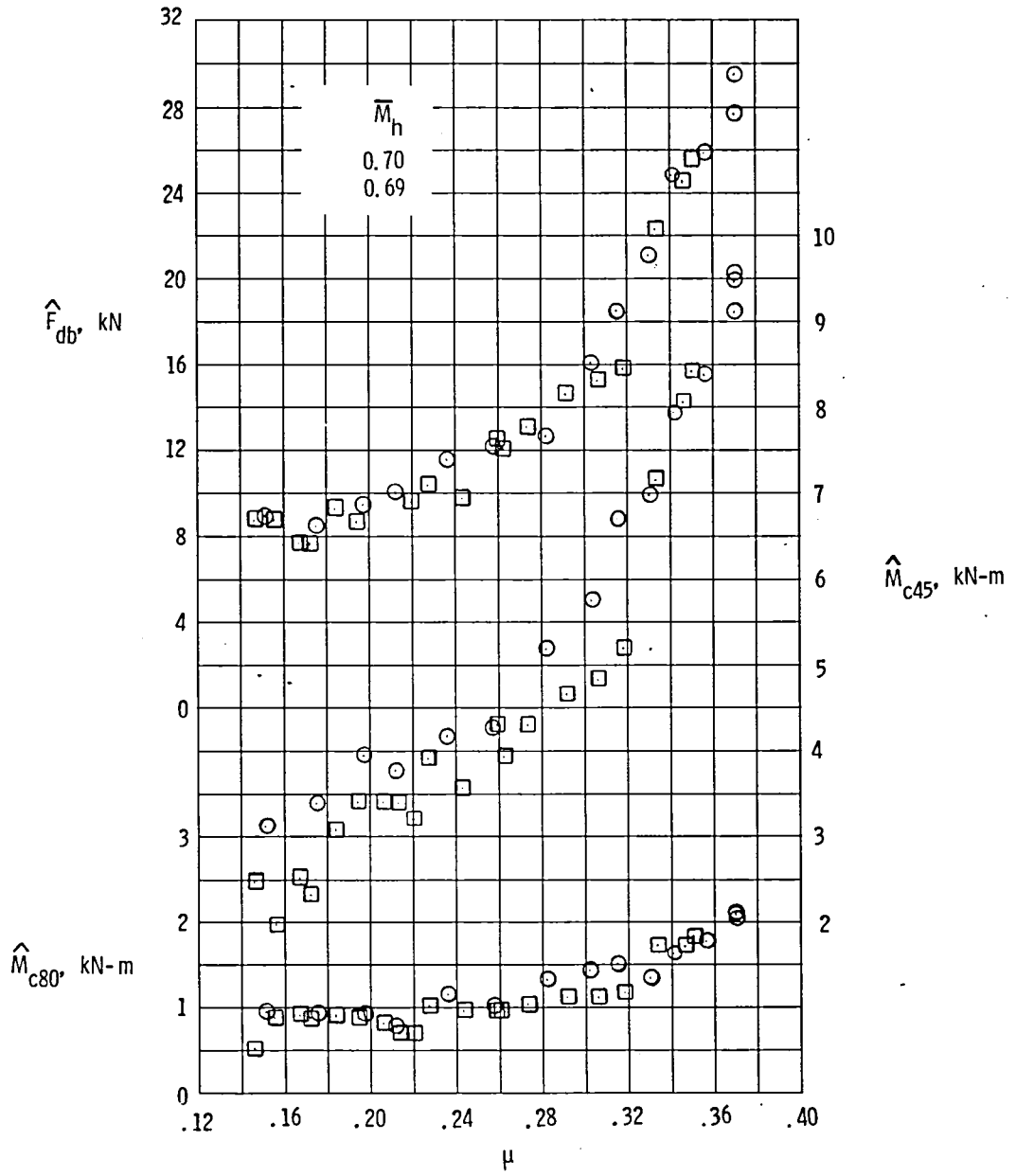

(f) Chordwise peak-to-peak rotor loads.

Figure 12. - Continued



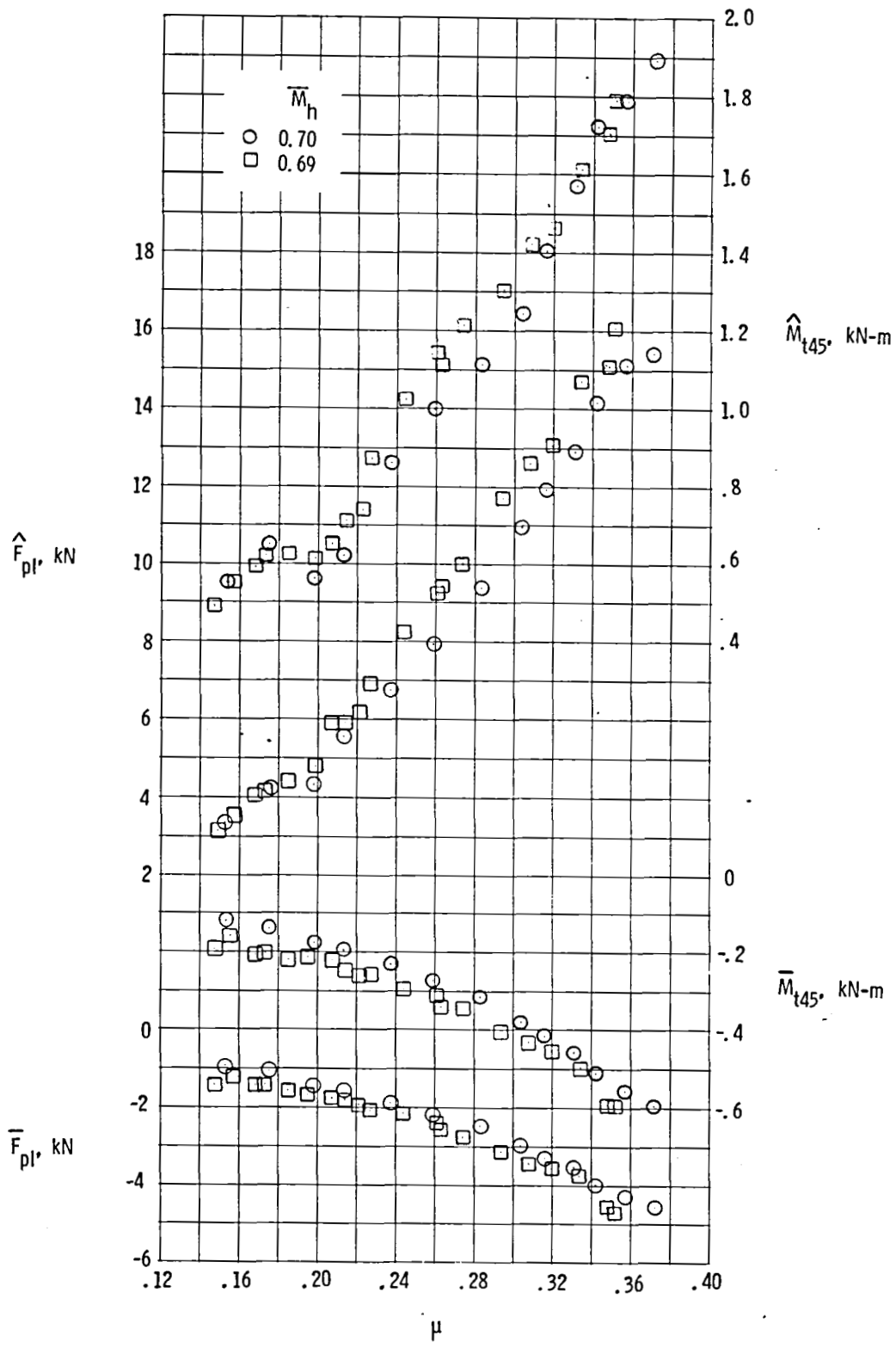

(g) Blade torsion and pitch-link loads.

Figure 12. - Concluded.

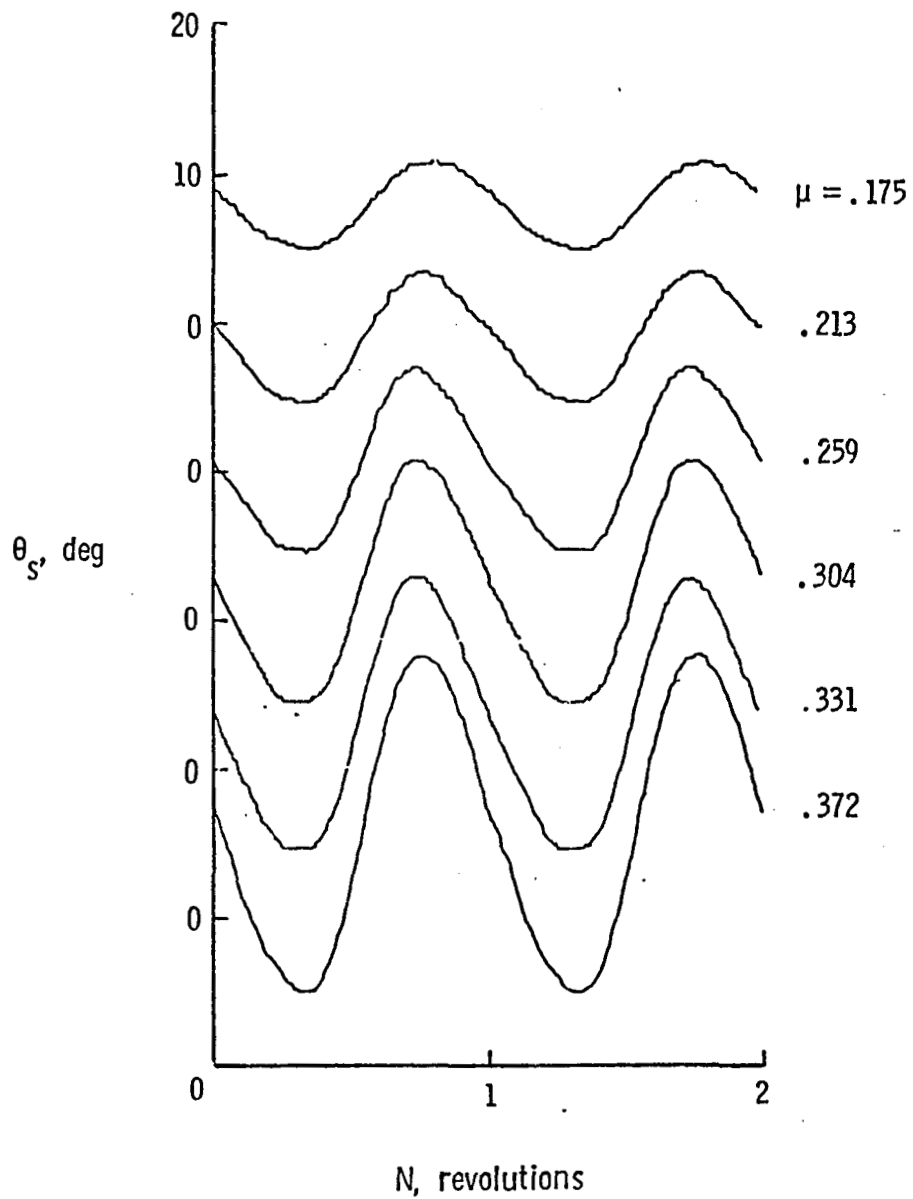

(a) Blade pitch angle.

Figure 13. - Rotor-data histories for a series of tip-speed ratios in level flight (Flight 63 of Appendix C).

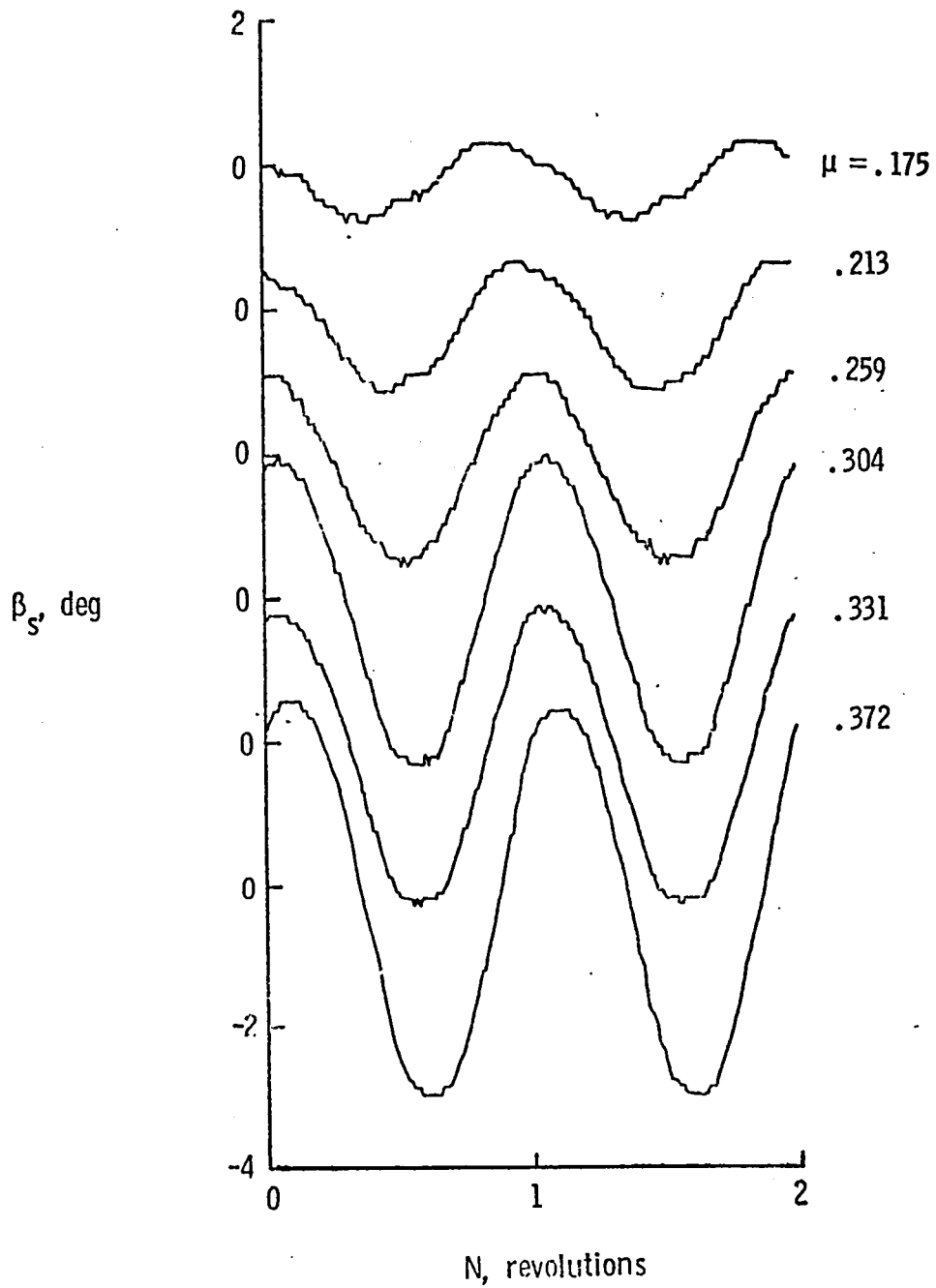

(b) Teeter angle.

Figure 13. - Continued

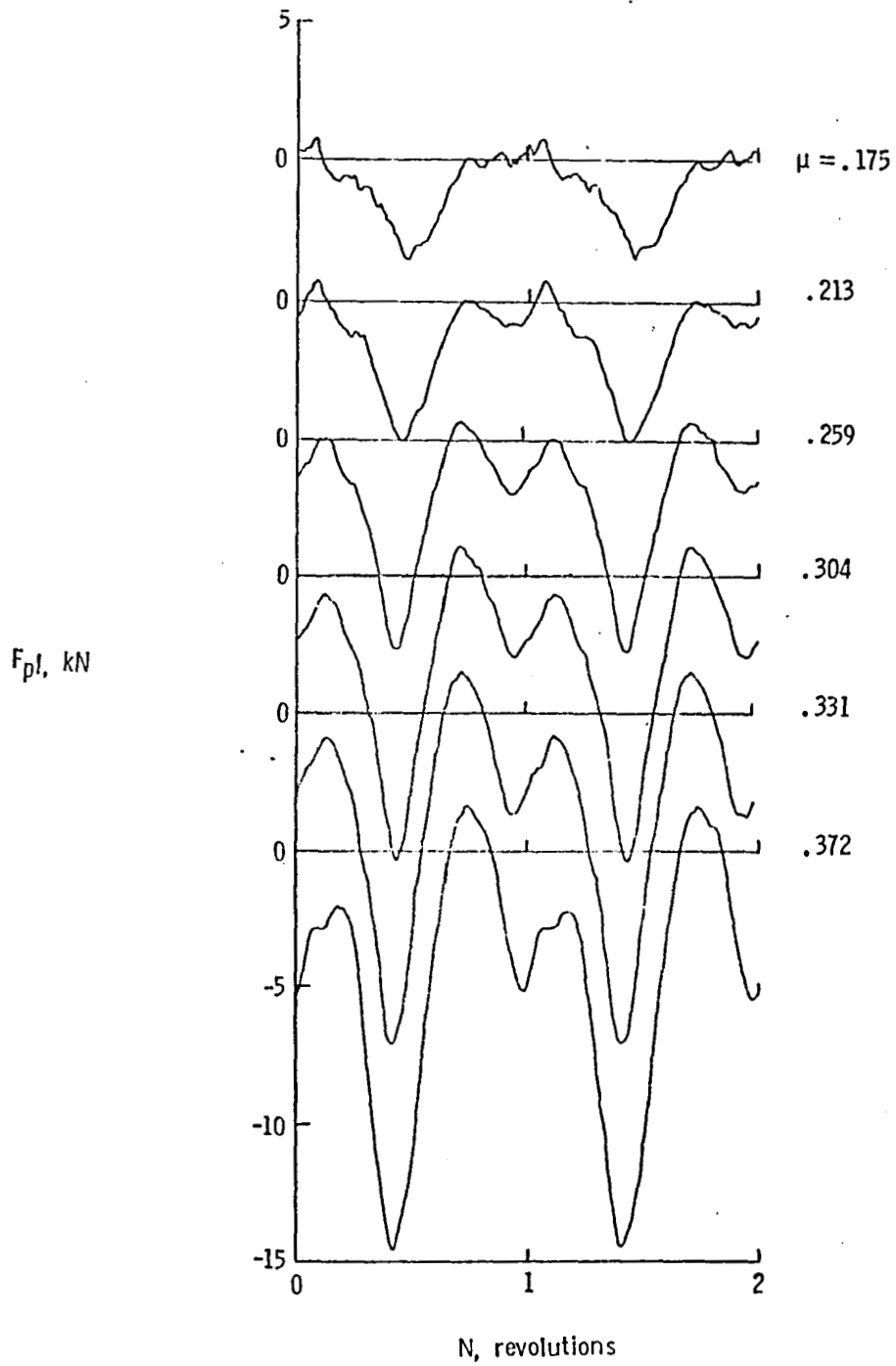

(c) Pitch-link load

Figure 13. - Concluded.

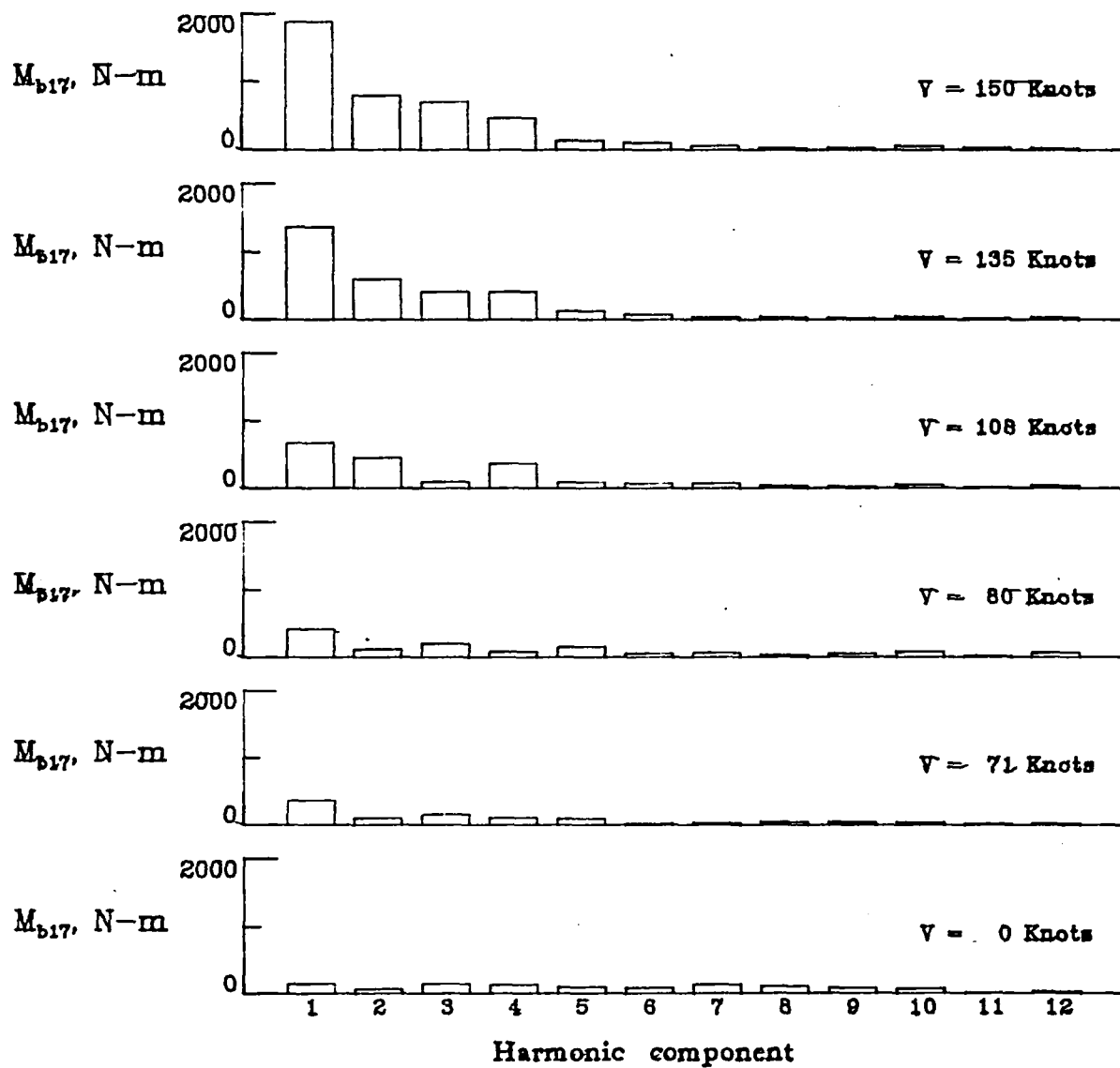

(a)  $M_{b17}$

Figure 14. - Harmonic content of rotor loads for level flight.  
 $\mu = 0.0037$ .

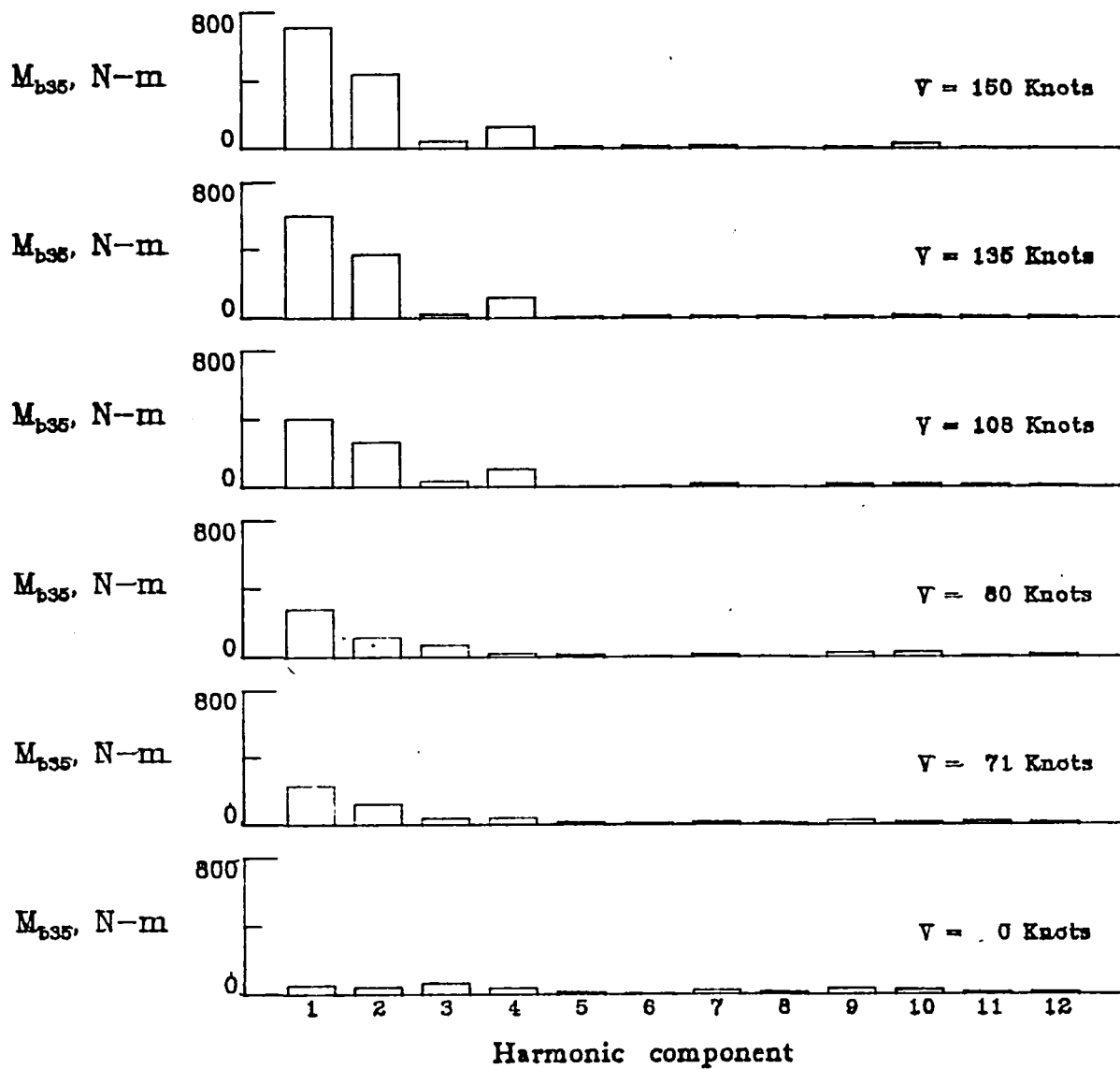

(b)  $M_{b35}$

Figure 14. - Continued.

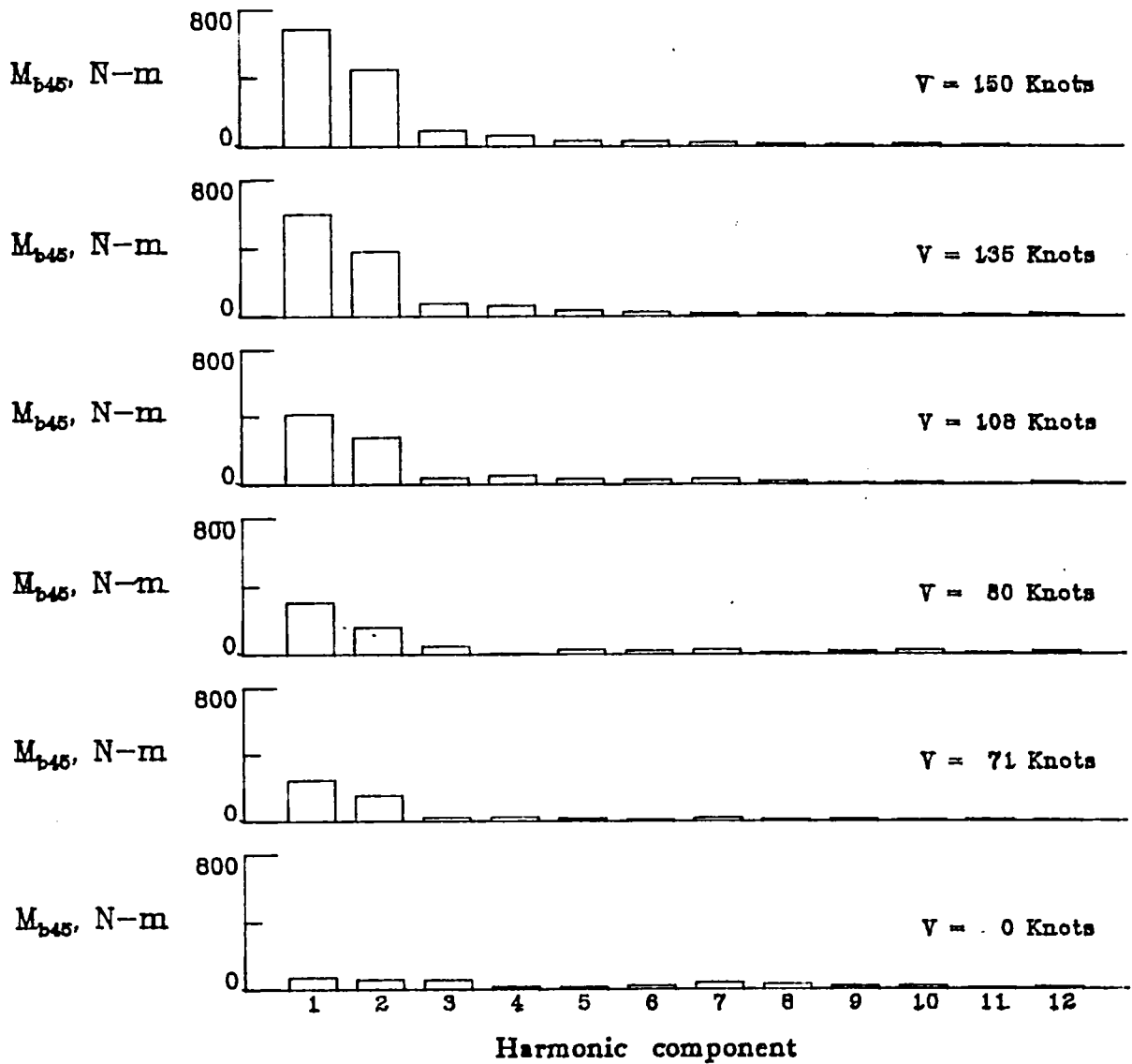

(c)  $M_{b45}$

Figure 14. - Continued.

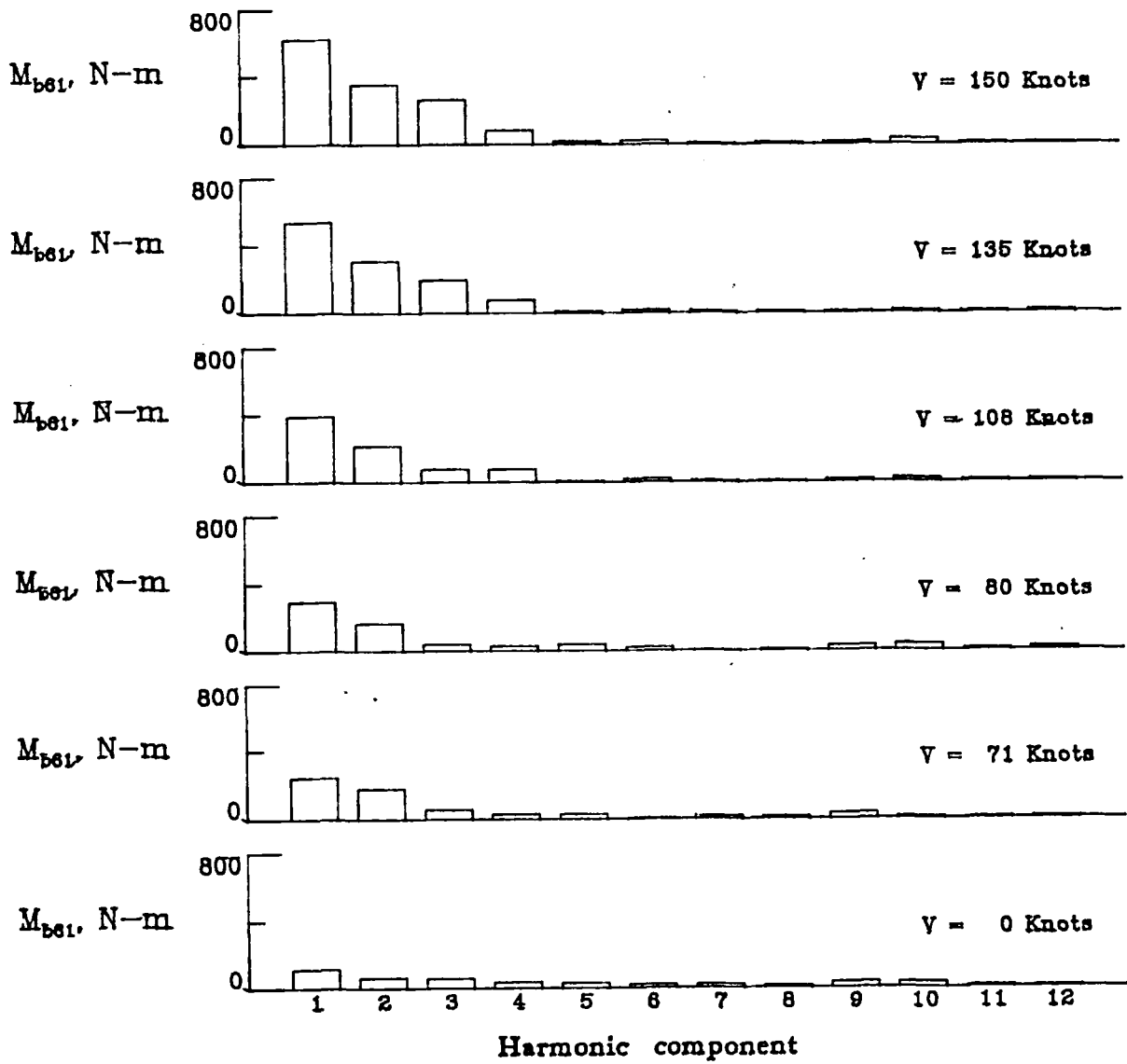

(d)  $M_{b61}$

Figure 14. - Continued.



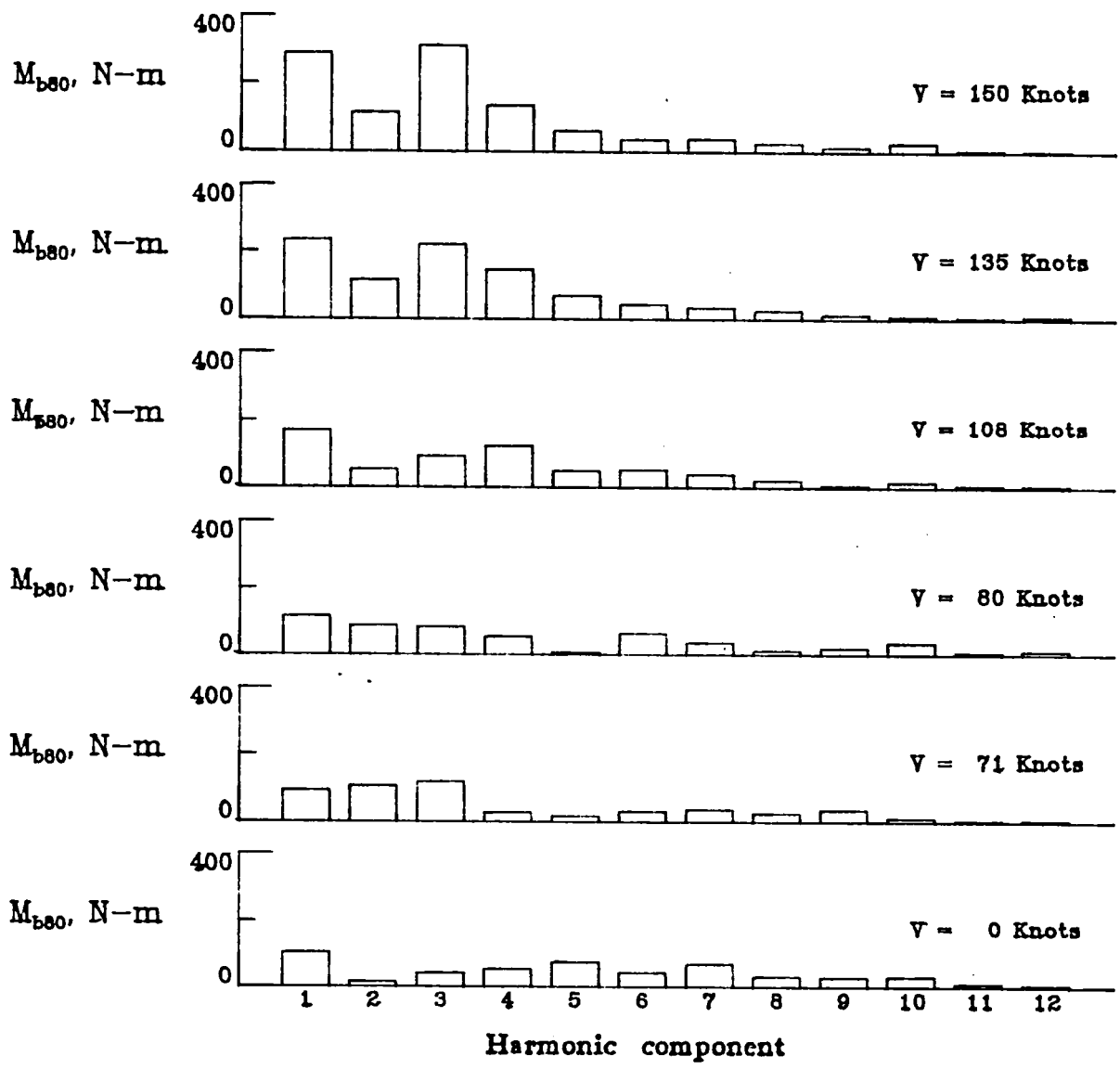

(e)  $M_{b80}$

Figure 14. - Continued.

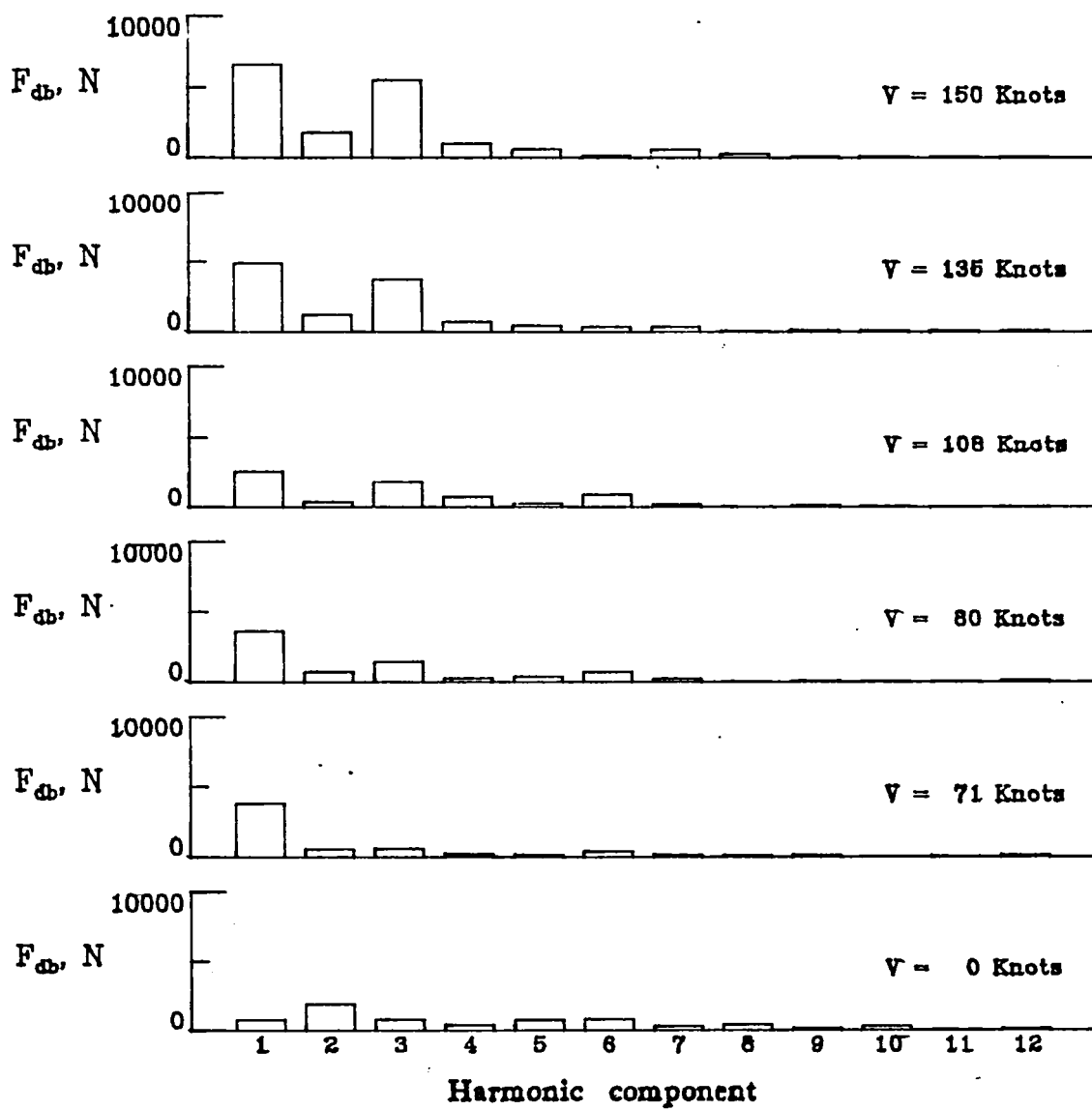

(f)  $F_{db}$

Figure 14. - Continued.

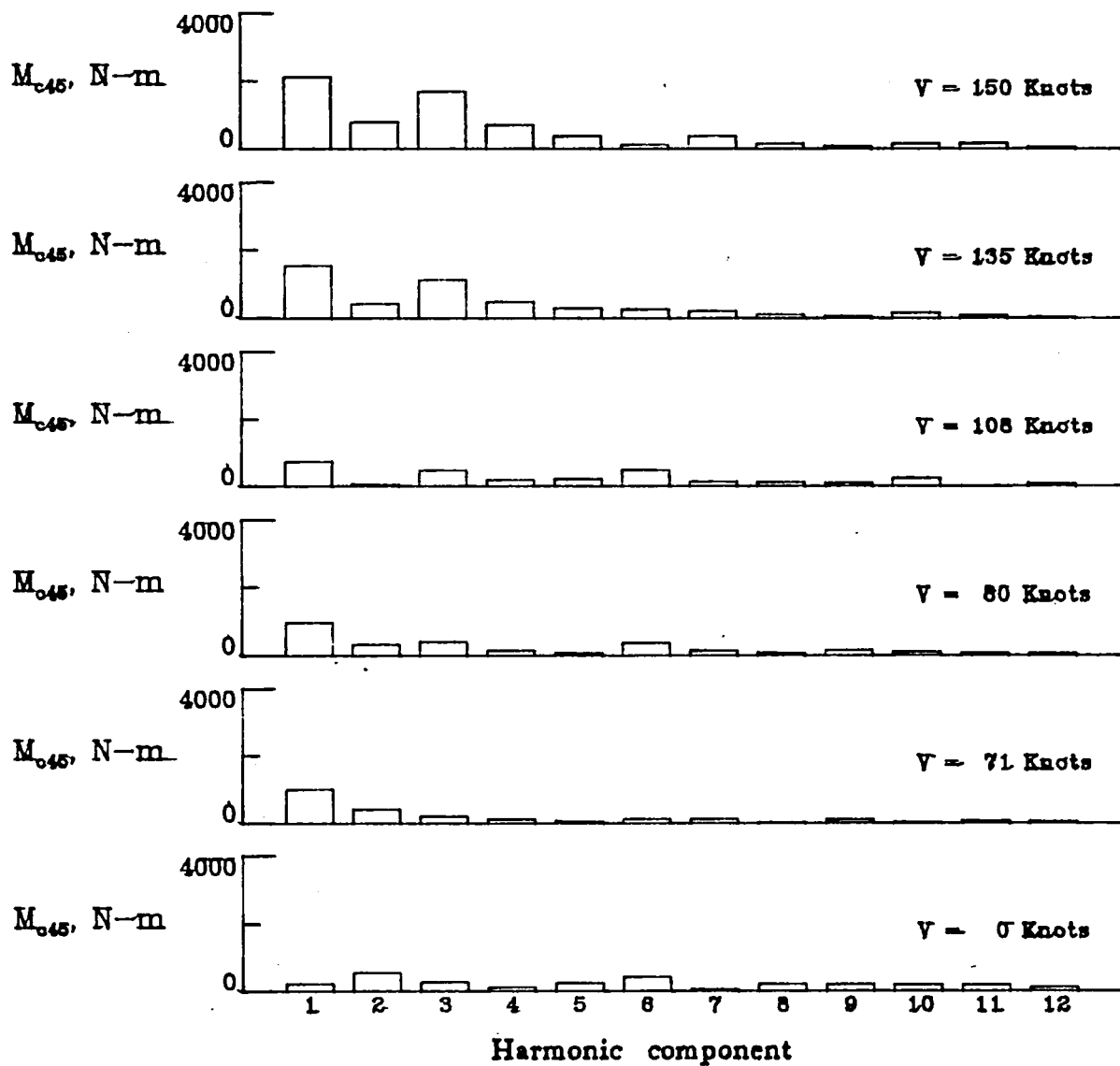

(g)  $M_{c45}$

Figure 14. - Continued.

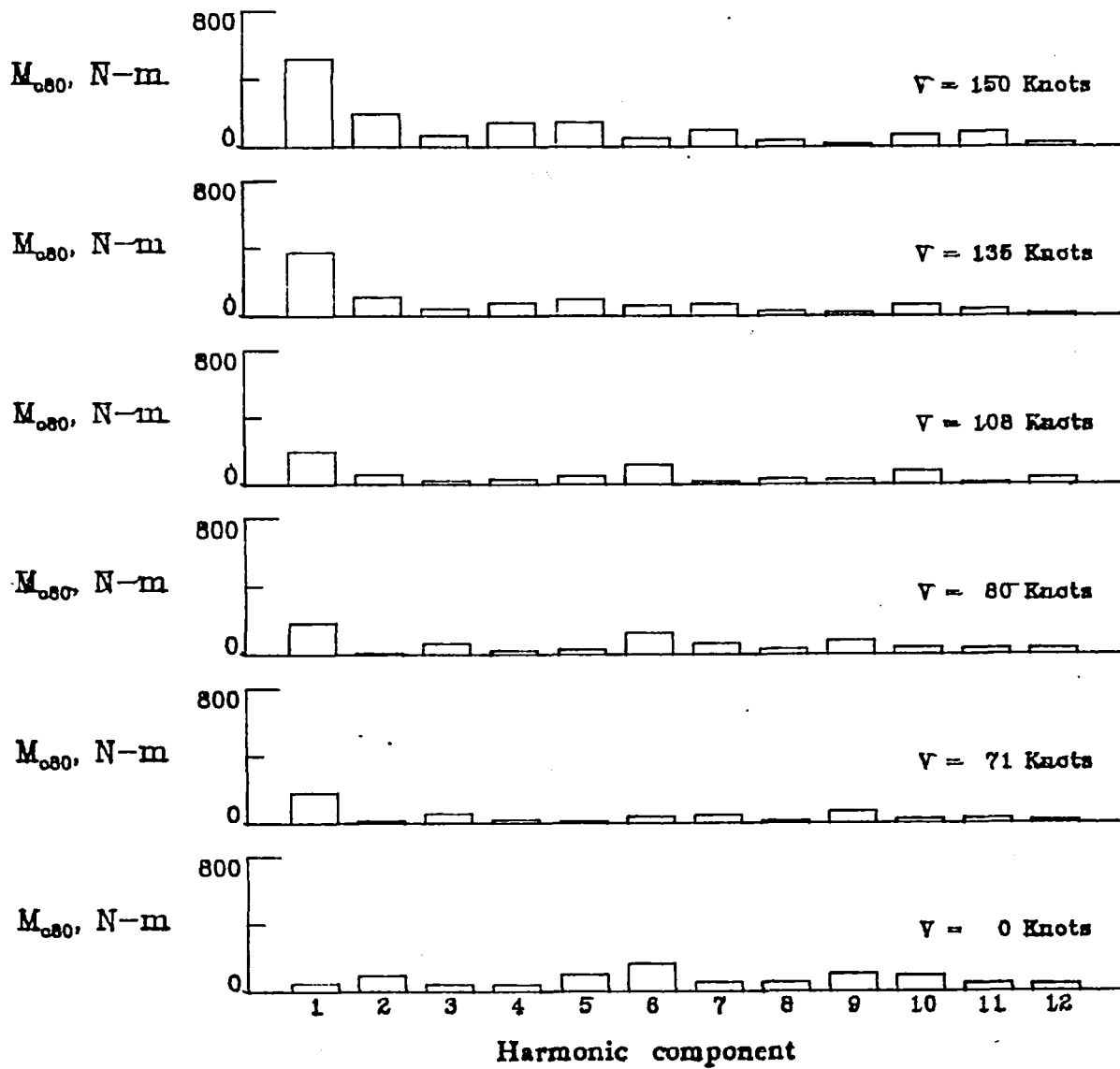

(h)  $M_{c80}$

Figure 14. - Continued.

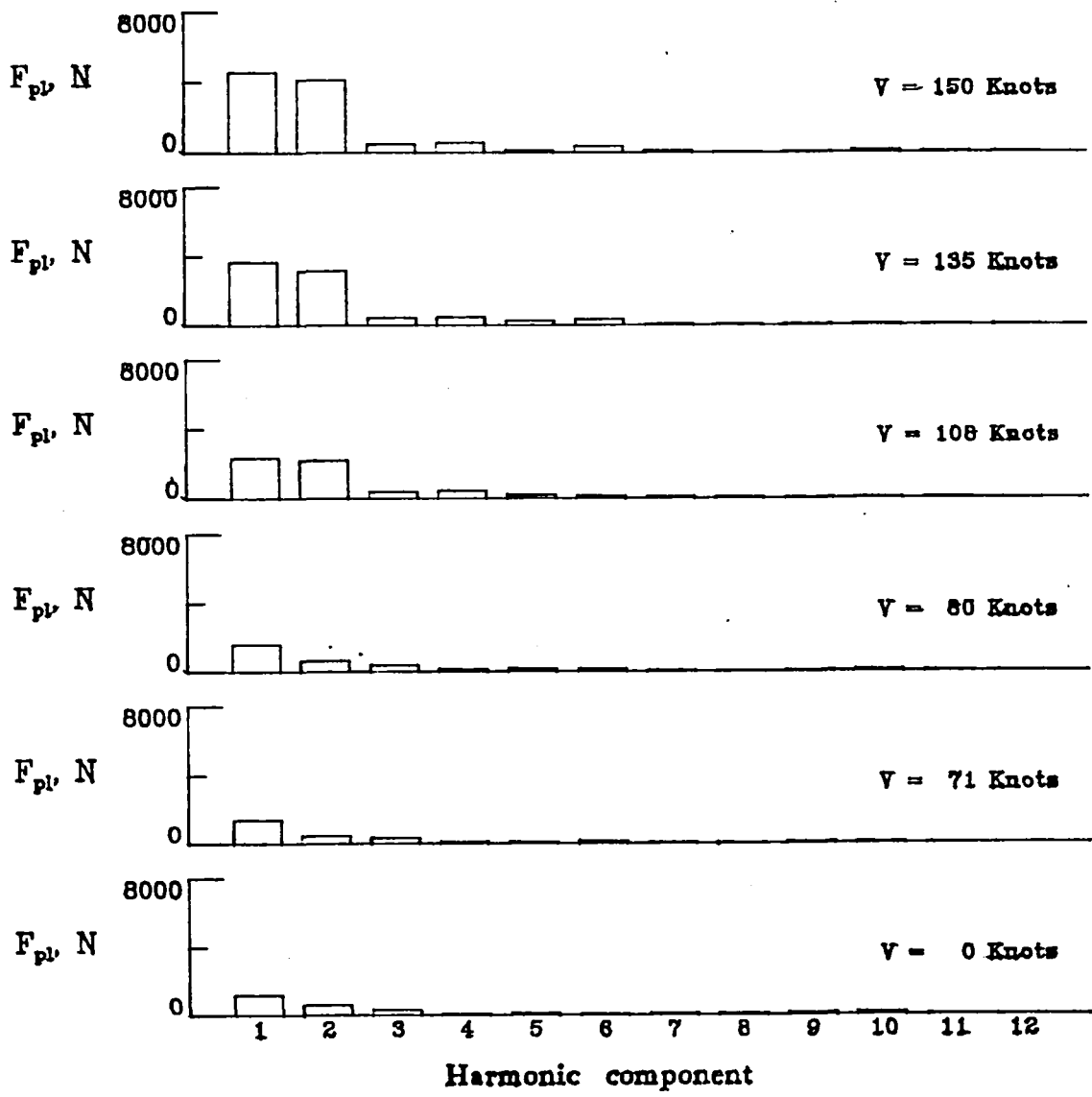

(i)  $F_{pl}$

Figure 14. - Continued.

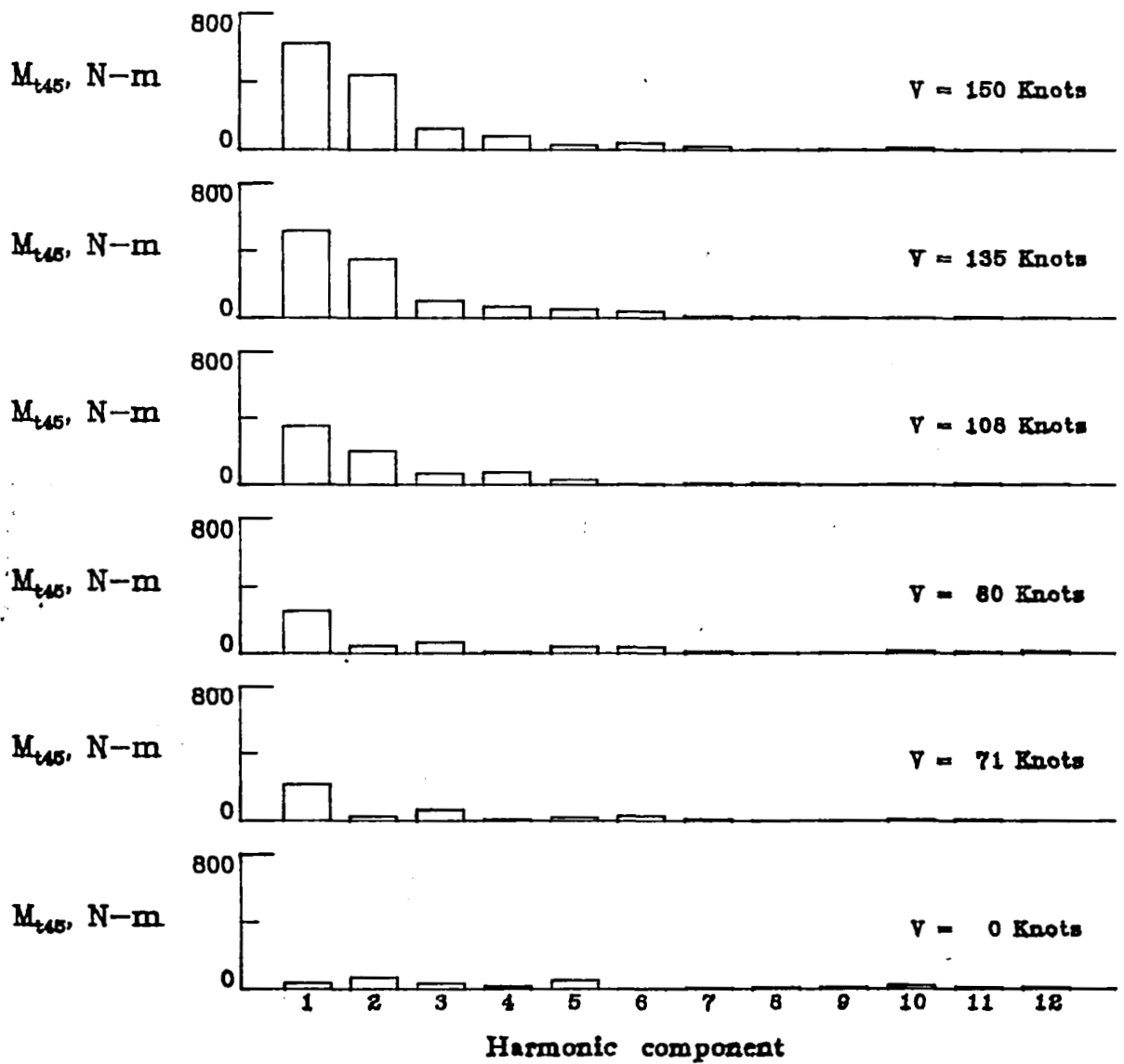

(j)  $M_{t45}$

Figure 14. - Concluded.

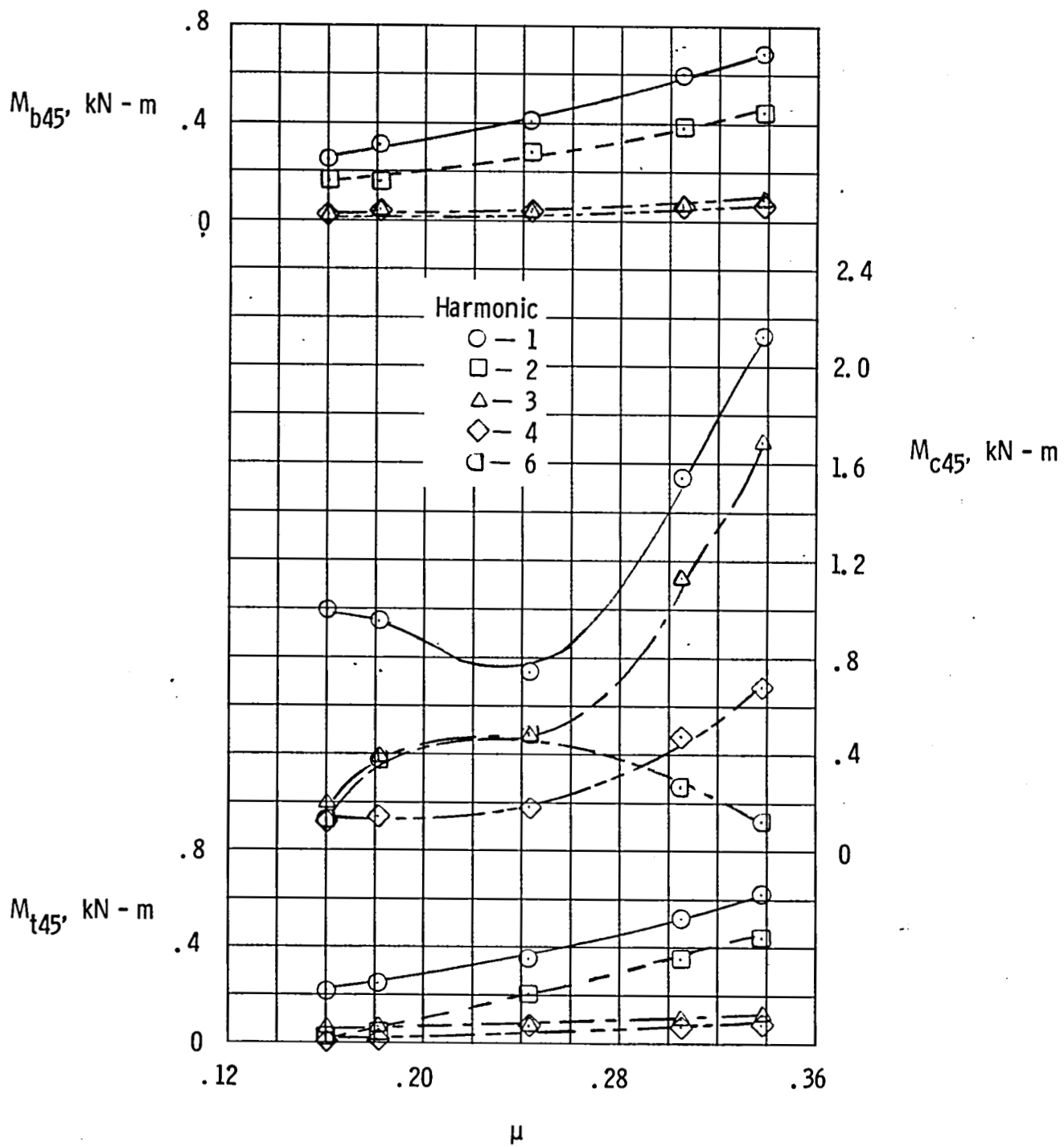

Figure 15. - Effect of tip-speed ratio on primary harmonic-load components at 0.45R.

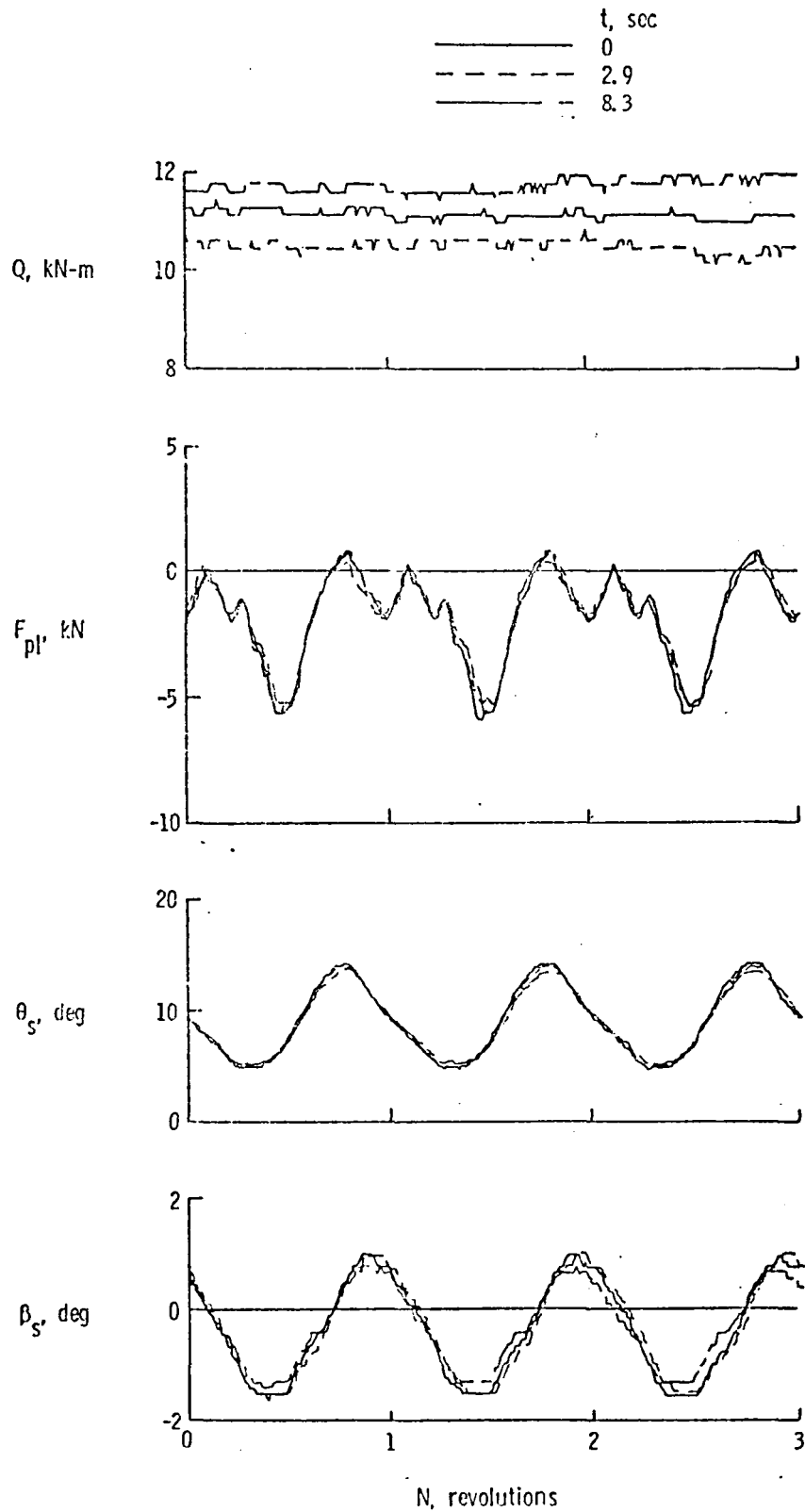
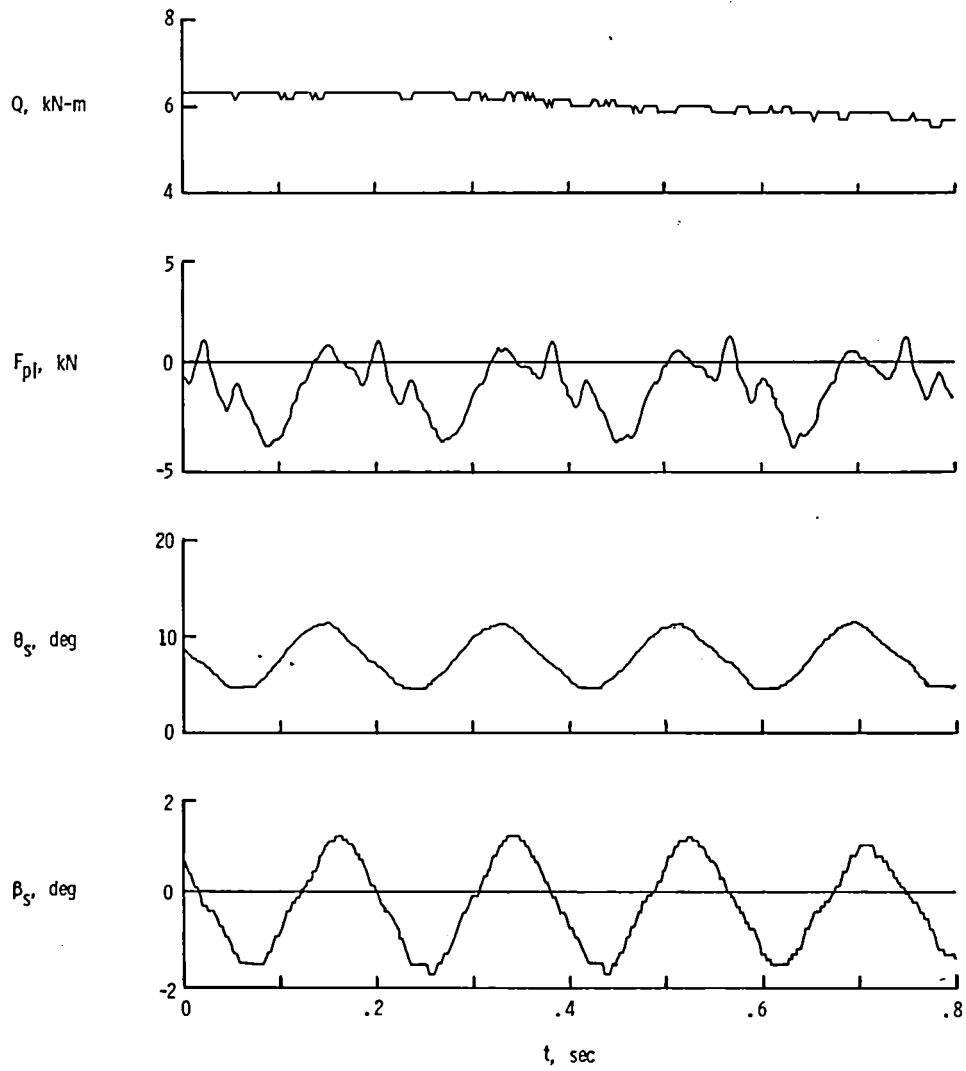

Figure 16. - Comparison of rotor-data histories for several segments of a descending left turn (Flight 63, run 3 of Appendix C).  
 $\mu = 0.24$ ;  $C_L^i = 0.0056$ .





(a)  $\mu = 0.24$ ,  $C_L' = 0.0064$  (Flight 66, run 4 of Appendix C).

Figure 17. - Typical rotor-data histories for descending left turns.

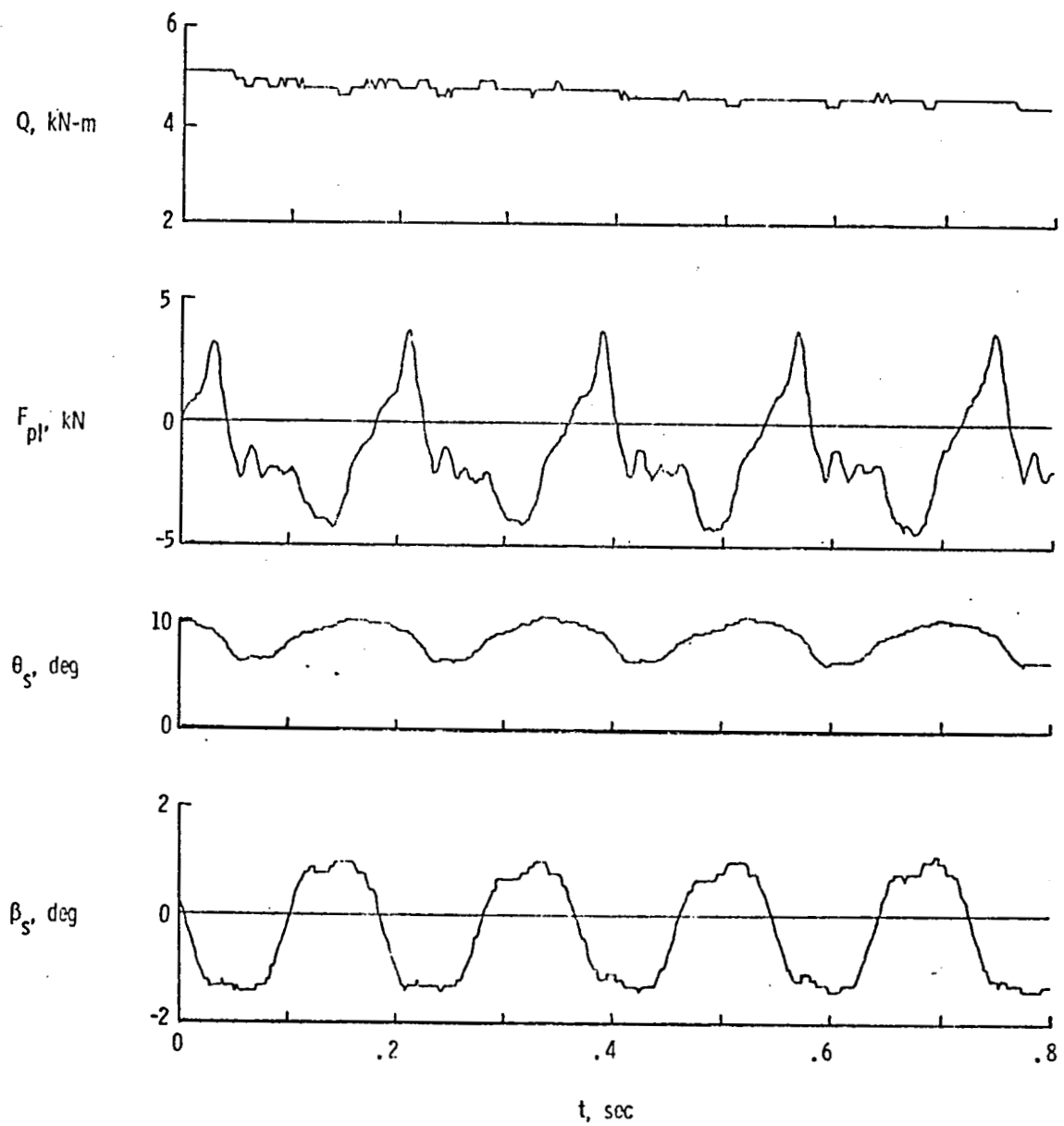

(b)  $\mu = 0.23, C_L' = 0.0087$  (Flight 66, run 7 of Appendix C).

Figure 17. - Concluded.

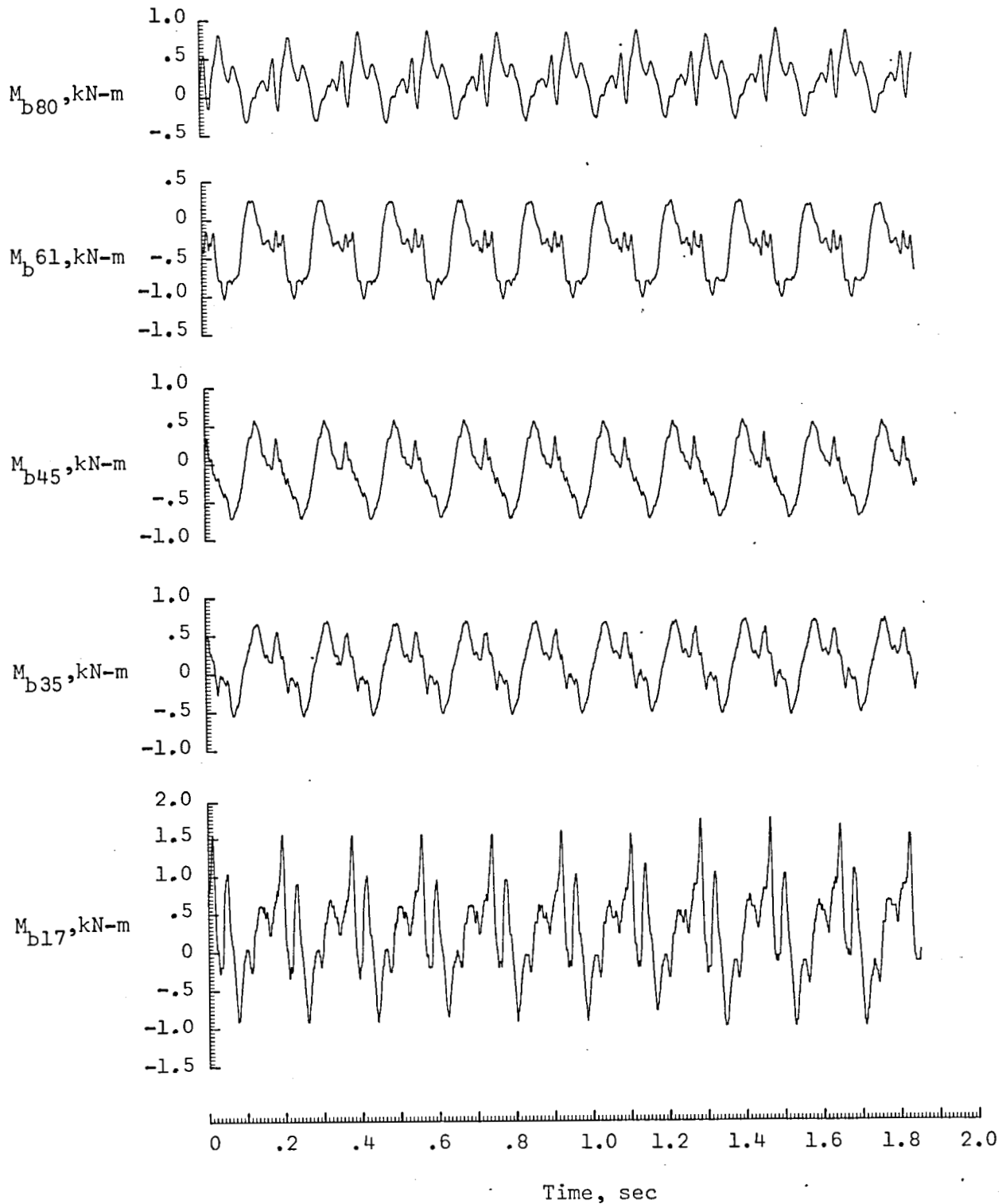

(a) Beamwise loads.

Figure 18. - Rotor-load histories for typical descending left turn (Flight 66, run 4 of Appendix C)  $\mu = 0.24$ ;  $C_L' = 0.0064$ .

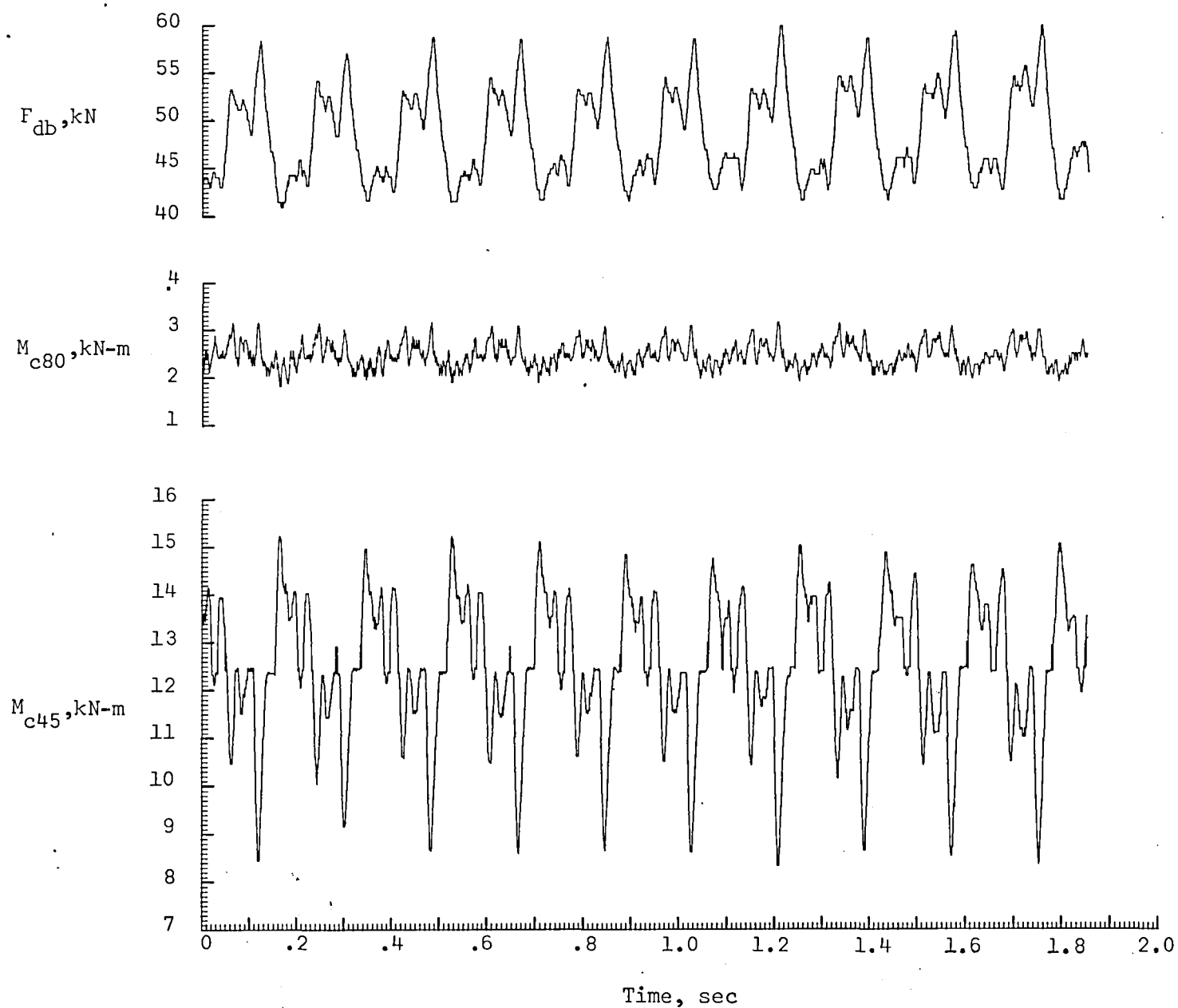

(b) Chordwise loads  
 Figure 18. - Continued

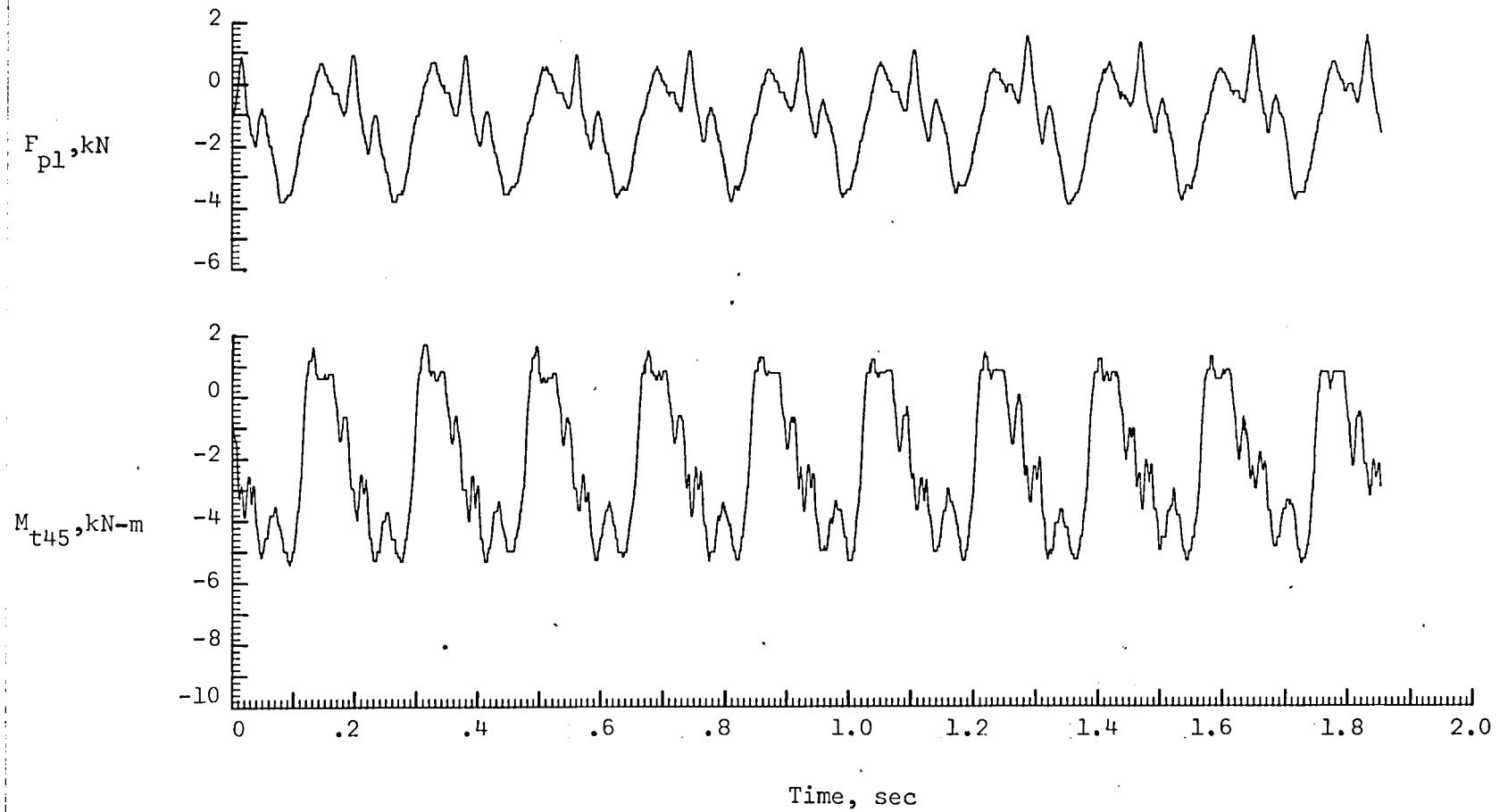

(c) Torsional loads

Figure 18. - Concluded.

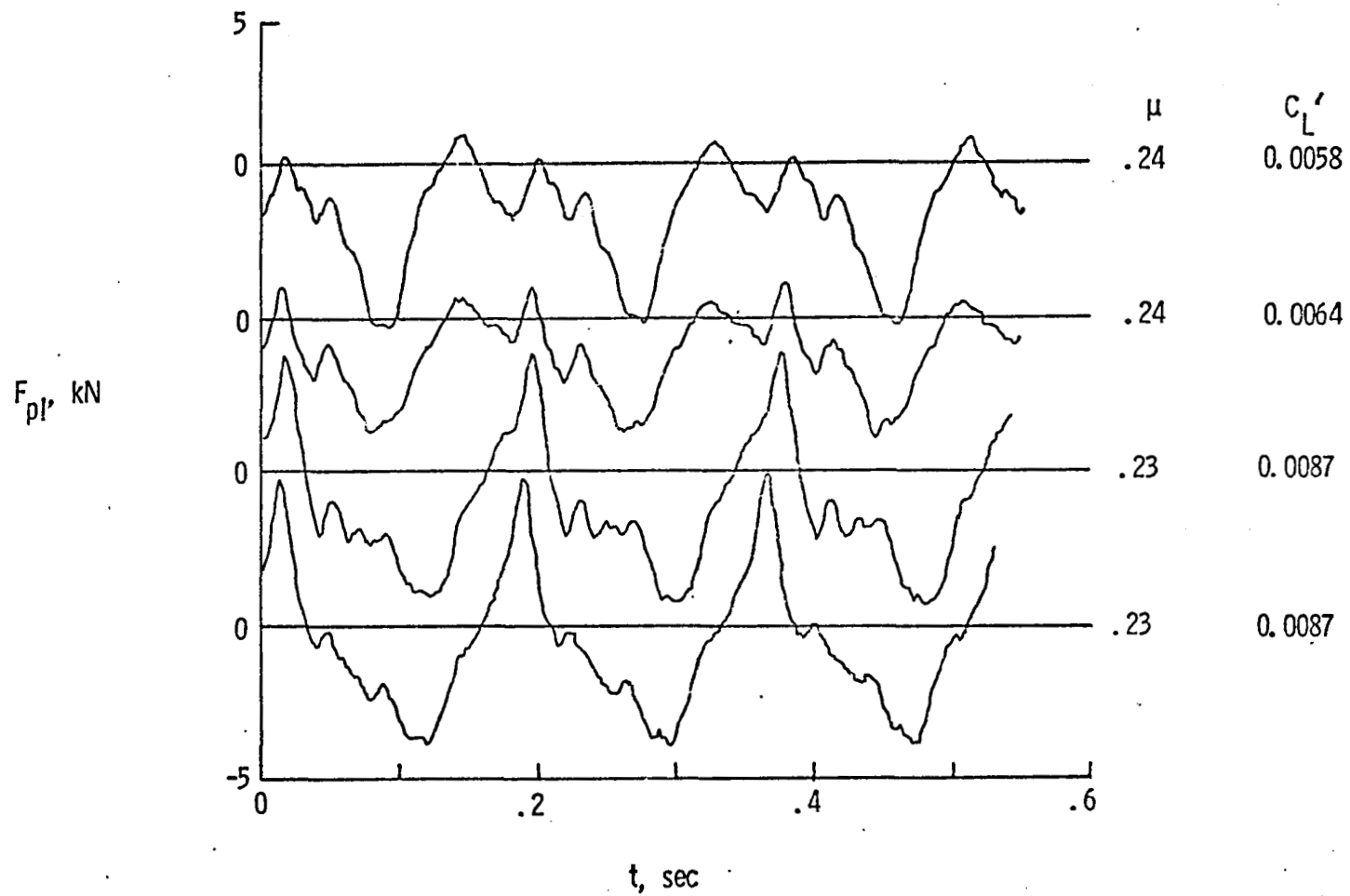
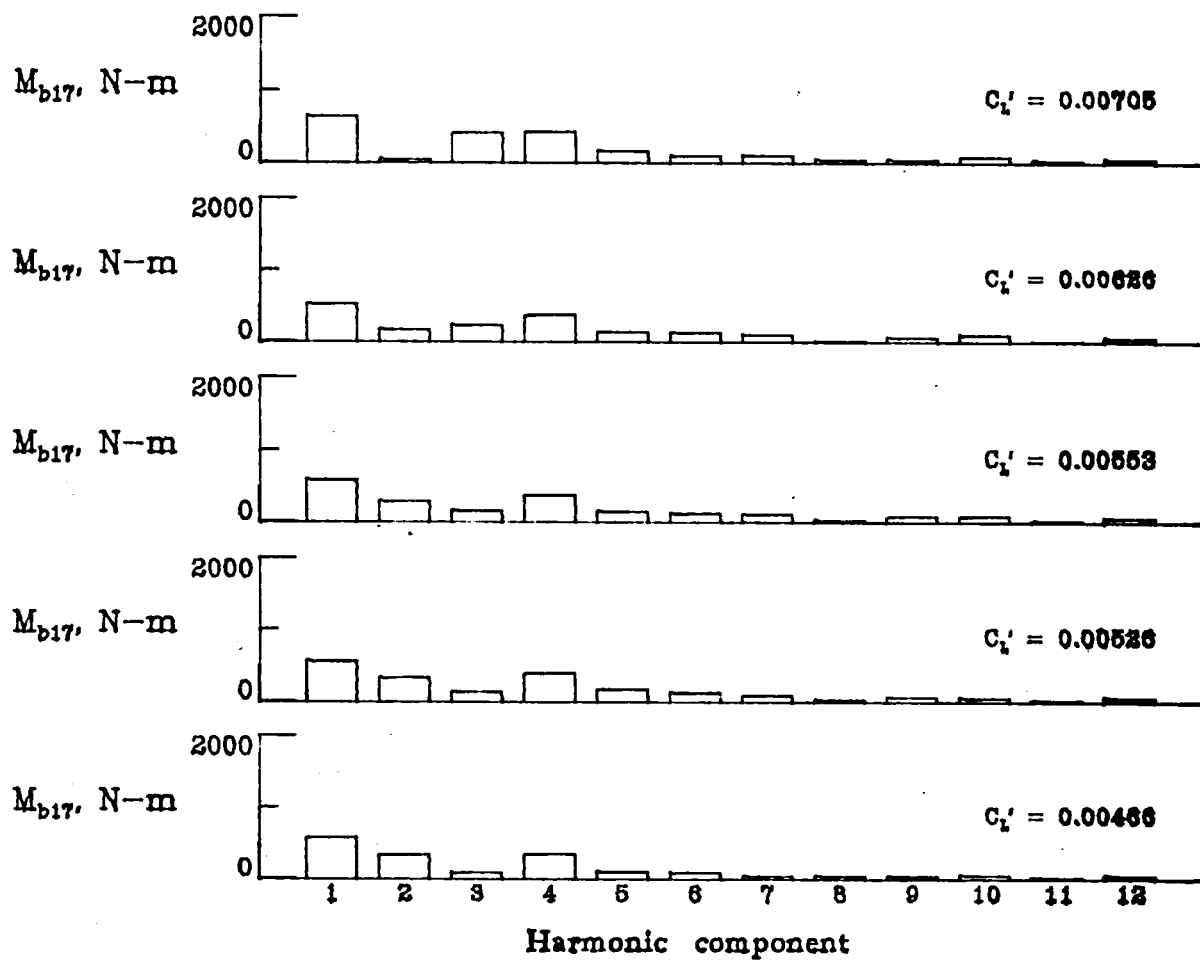
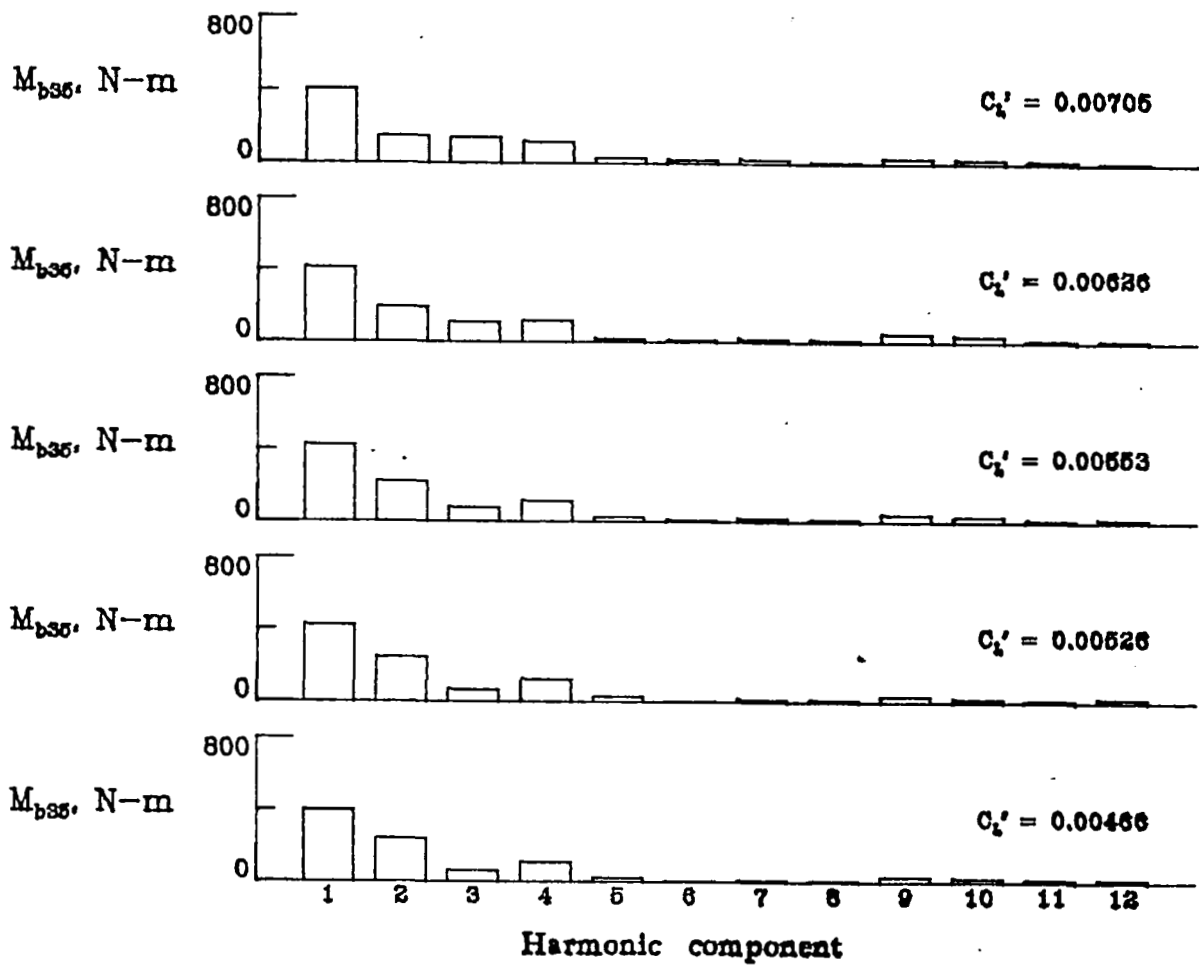

Figure 19. - Pitch-link load histories for a series of descending turns at  $\bar{c}_L'/\bar{n}_z = 0.0039$ ,  $\bar{M}_h = 0.71$  (Flight 66, runs 3, 4, 7 and 8 of Appendix C).



(a)  $M_{b17}$

Figure 20. - Harmonic content of rotor loads for descending left turns.  $\bar{\mu} = 0.24$ .



(b)  $M_{b35}$

Figure 20. - Continued



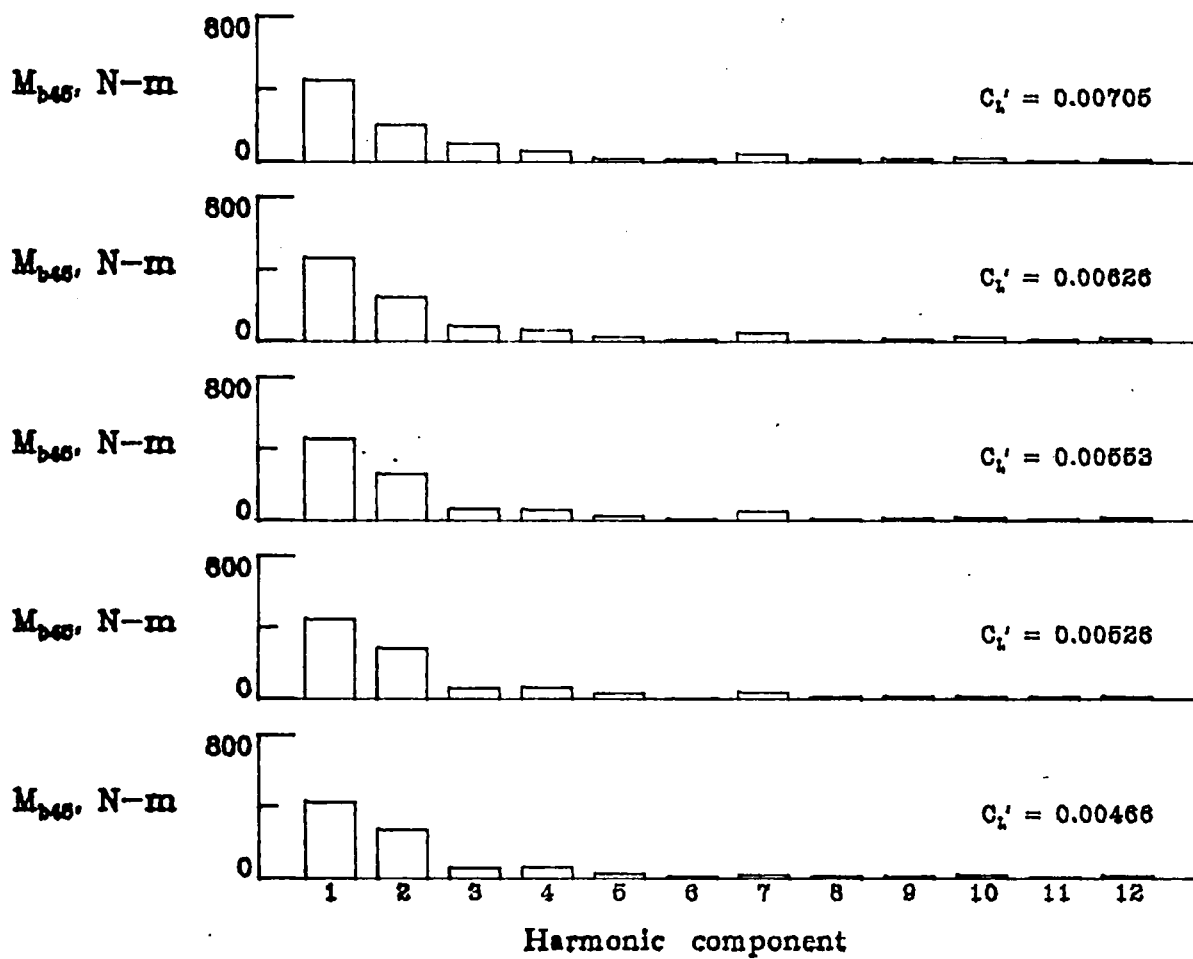

(c)  $M_{b45}$

Figure 20. - Continued

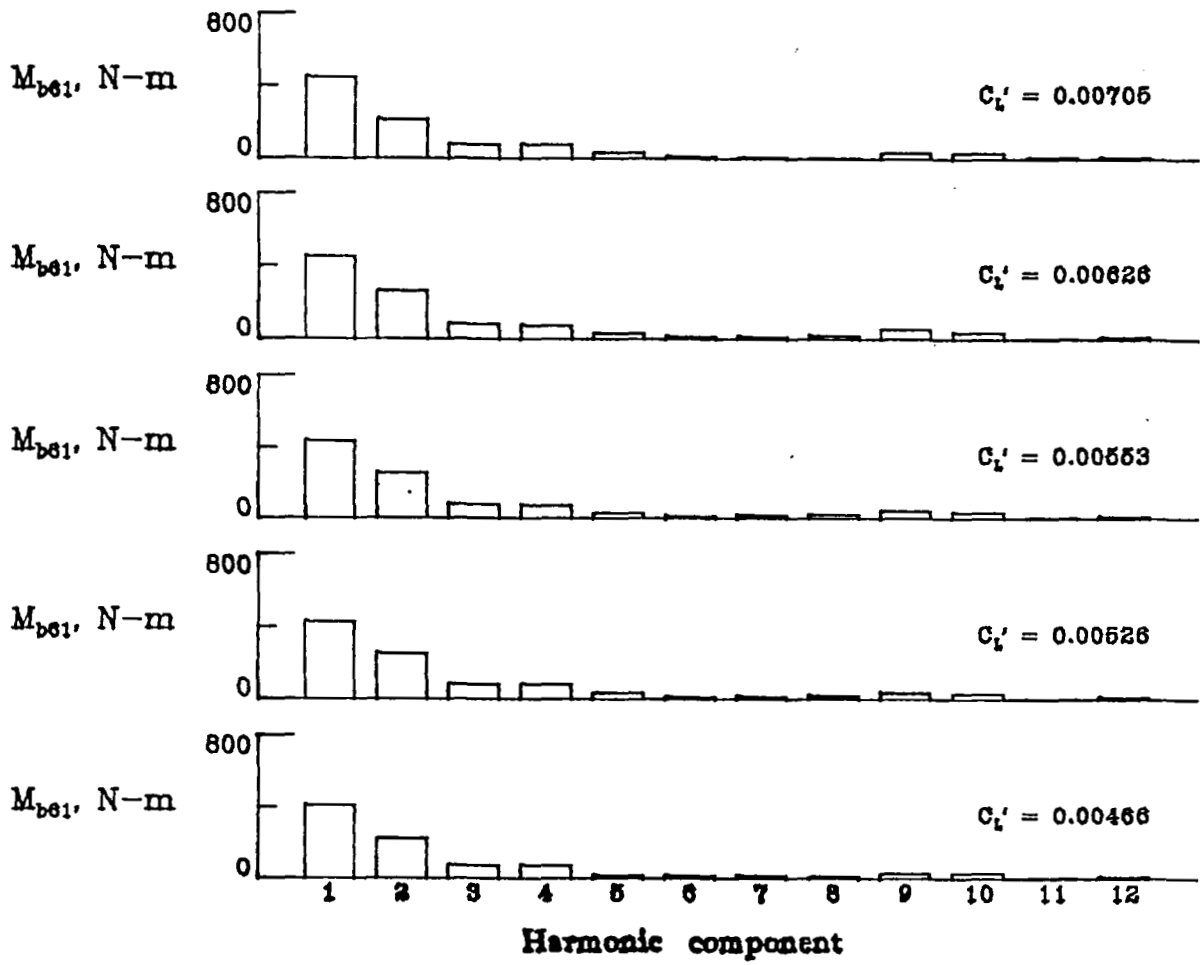

(d)  $M_{b61}$

Figure 20. - Continued

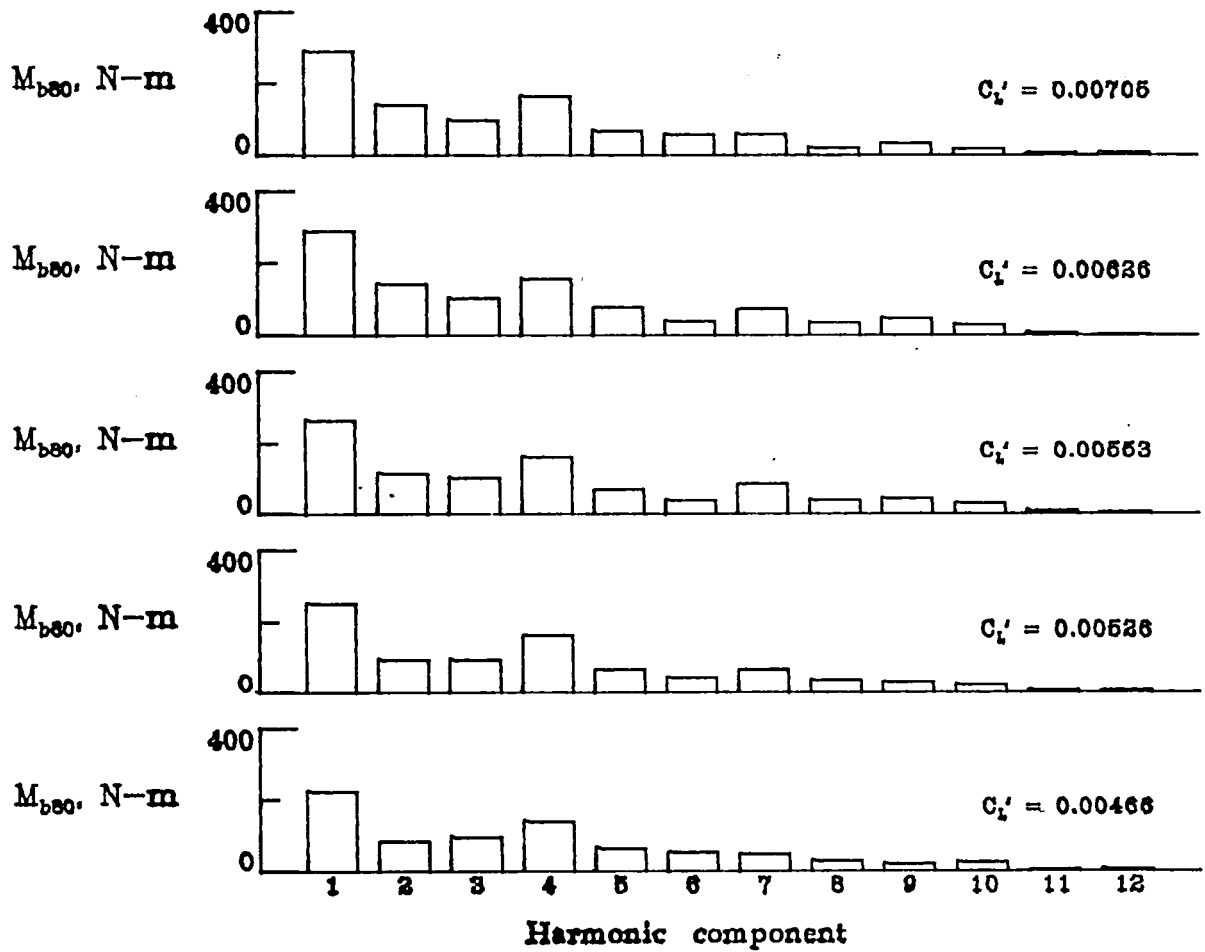

(e)  $M_{b80}$

Figure 20. - Continued

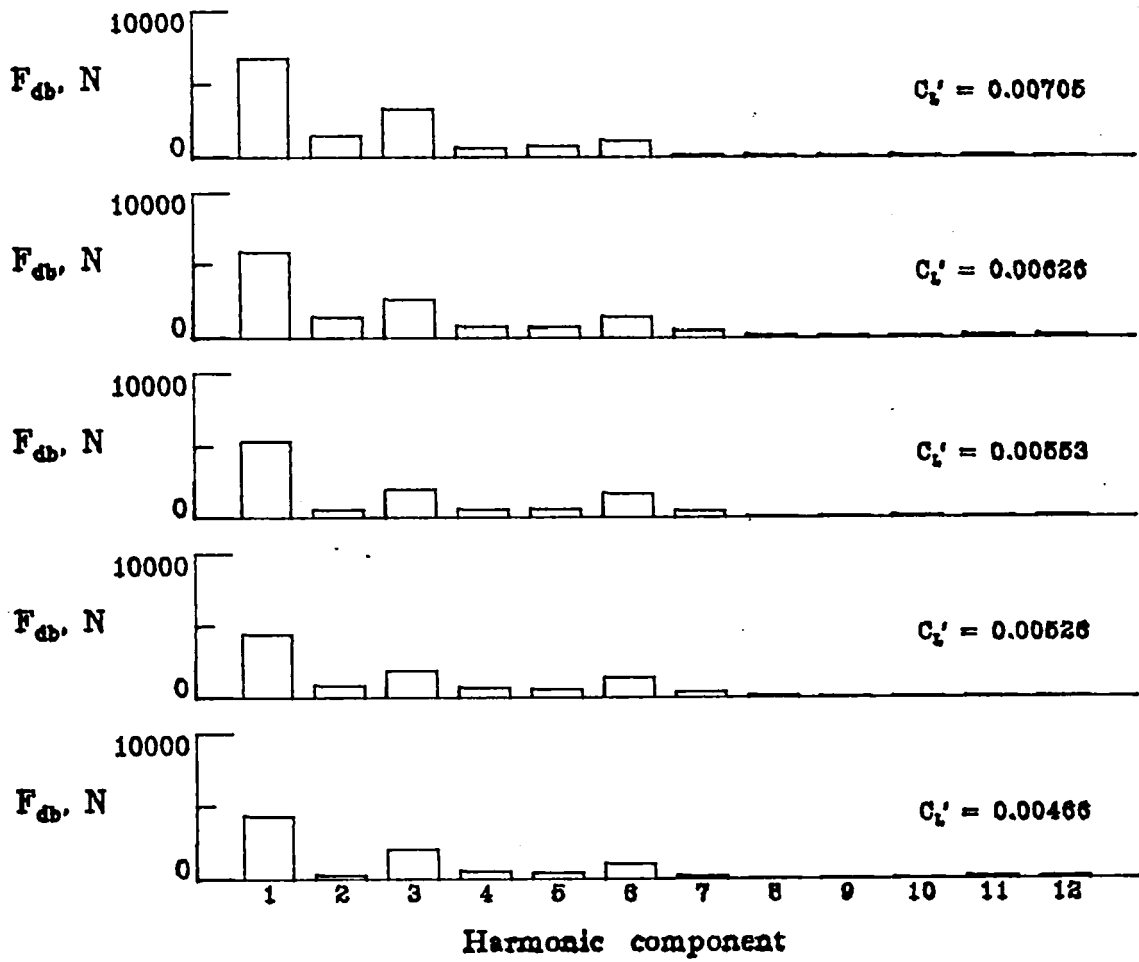

(f)  $F_{db}$

Figure 20. - Continued

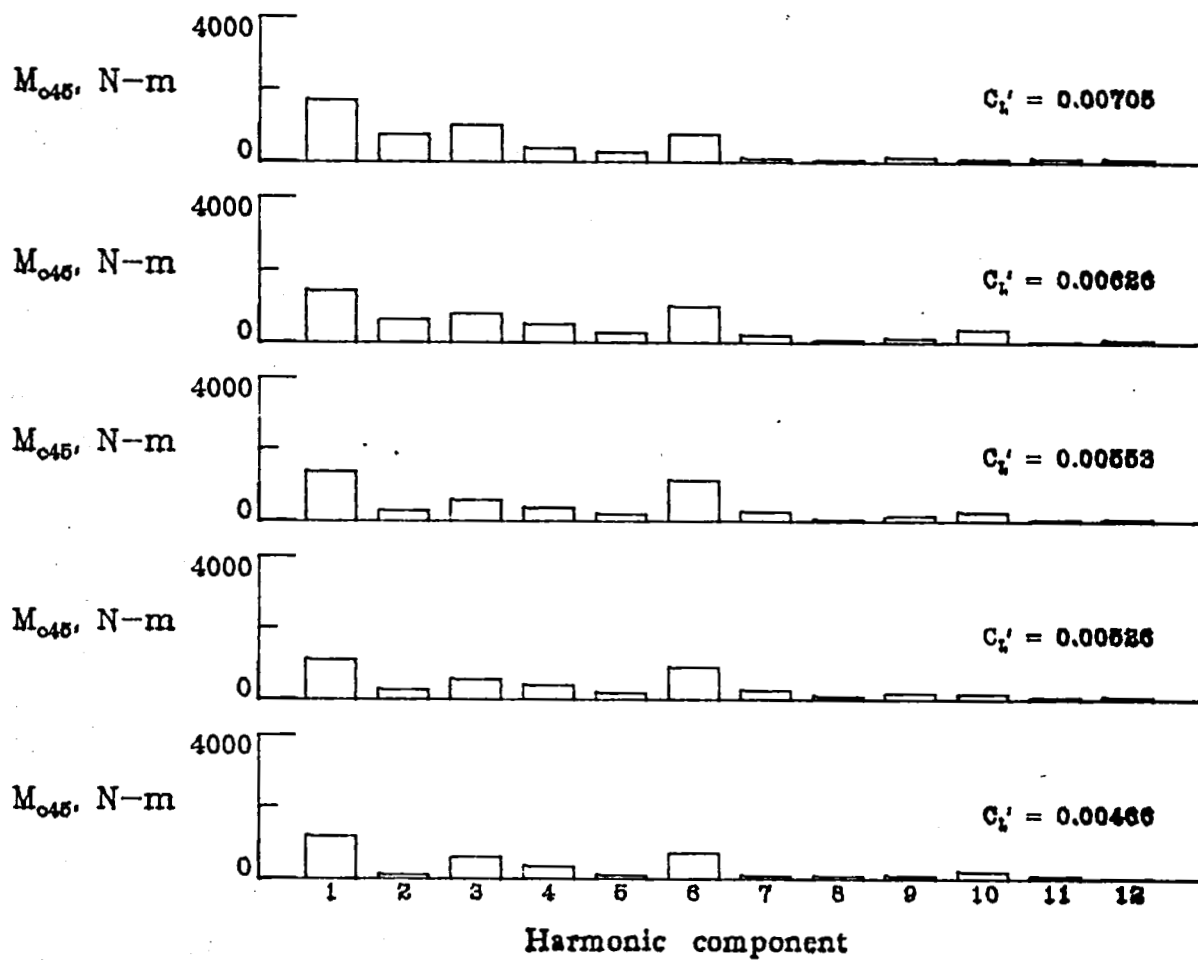

(g)  $M_{c45}$

Figure 20. - Continued

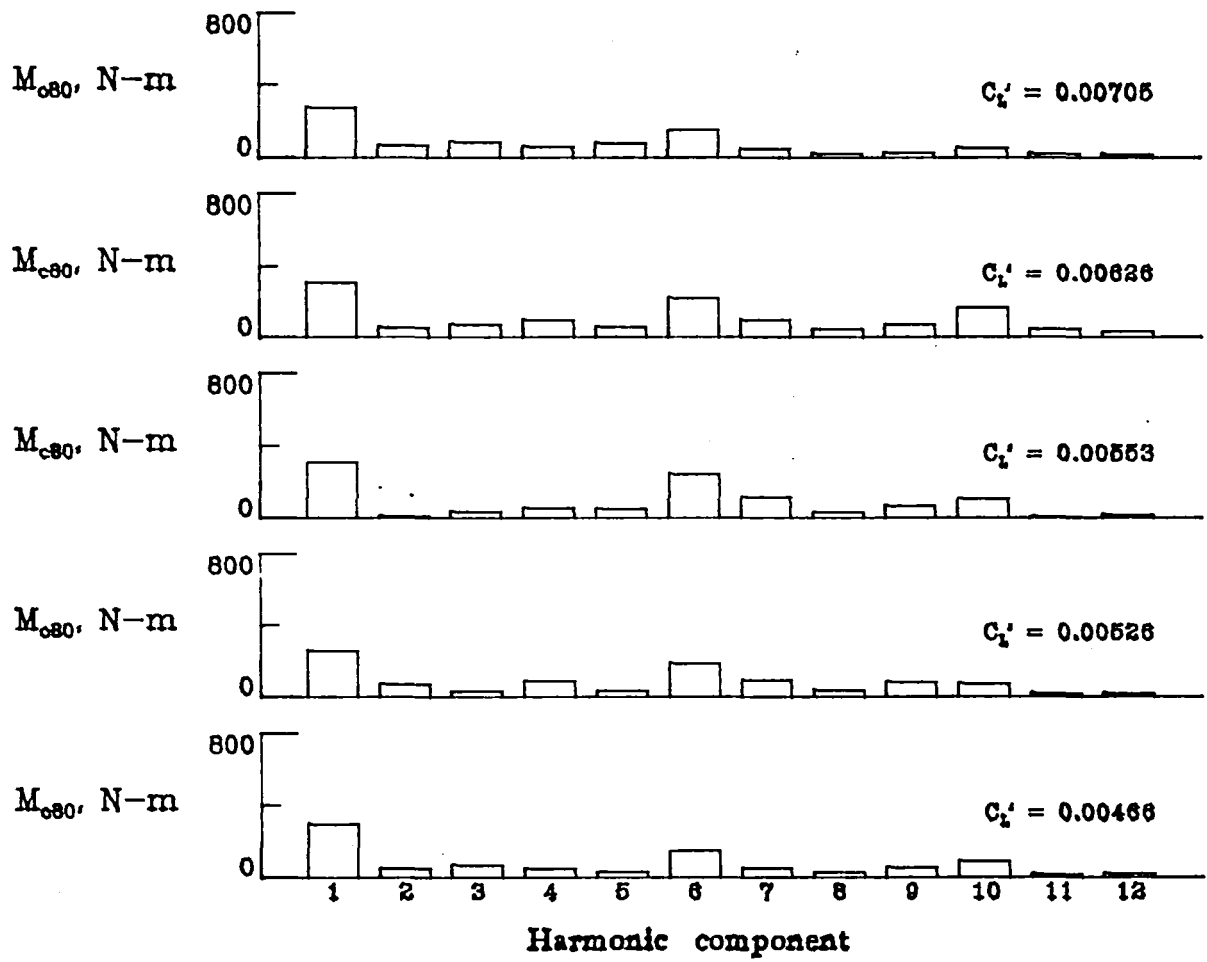

(h)  $M_{c80}$

Figure 20. - Continued

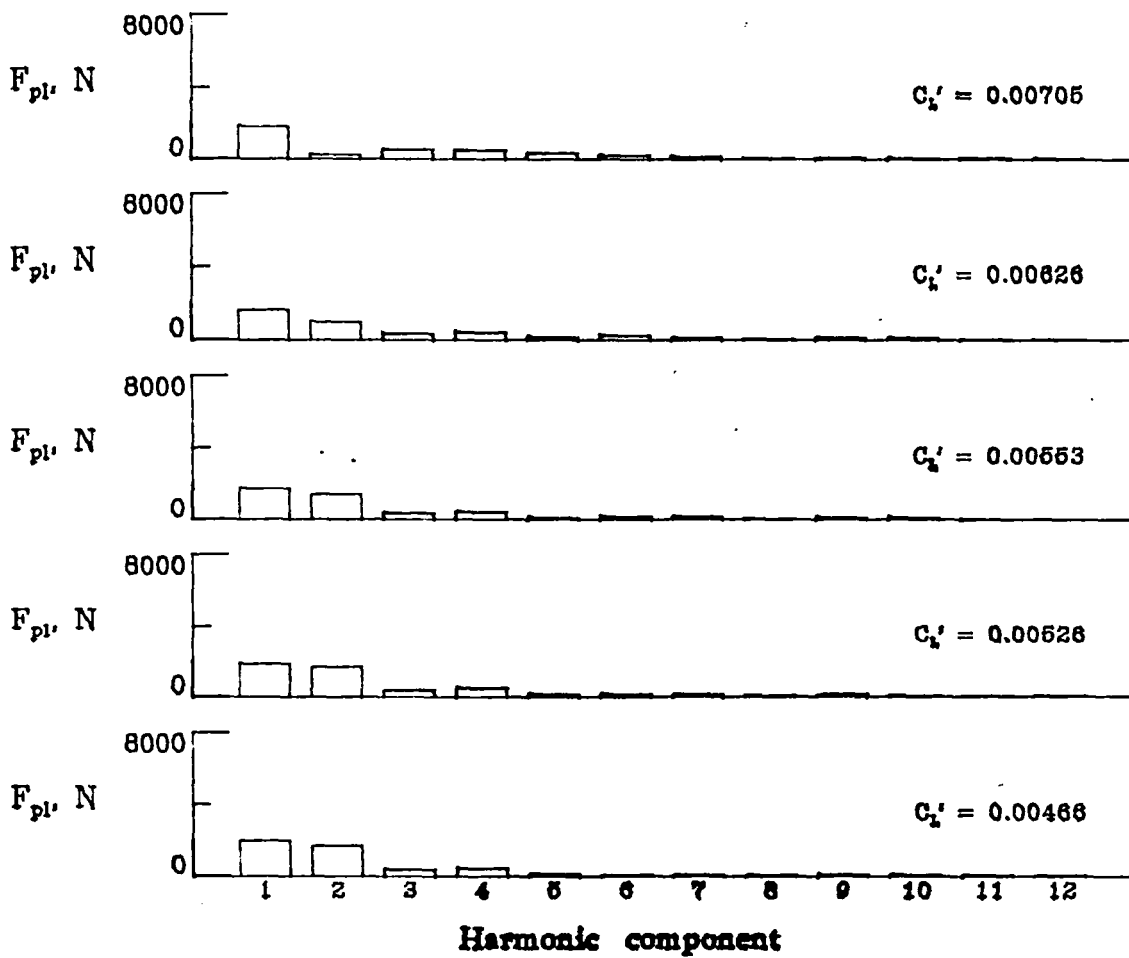

(i)  $F_{pl}$

Figure 20.. - Continued

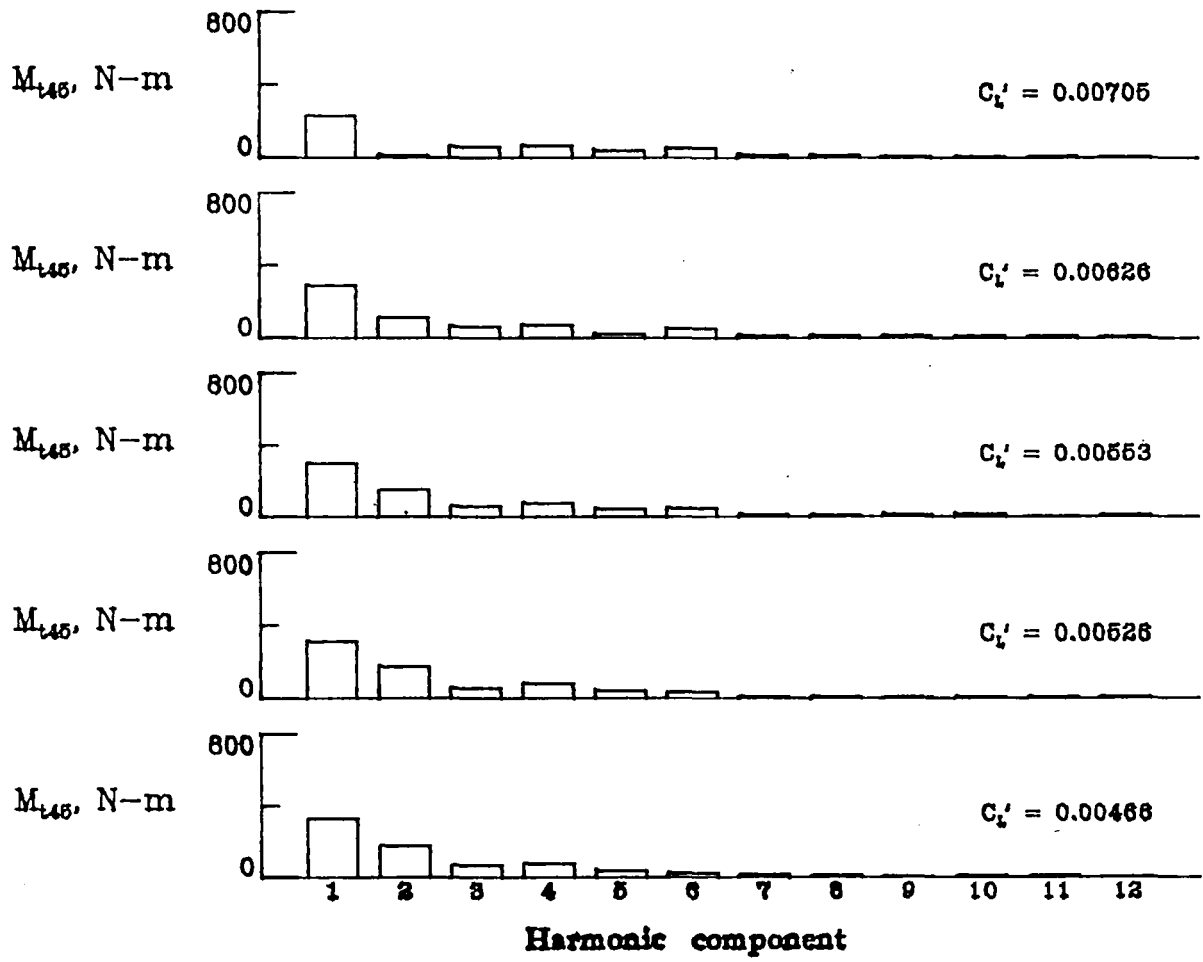

(j)  $M_{t45}$

Figure 20. - Concluded.



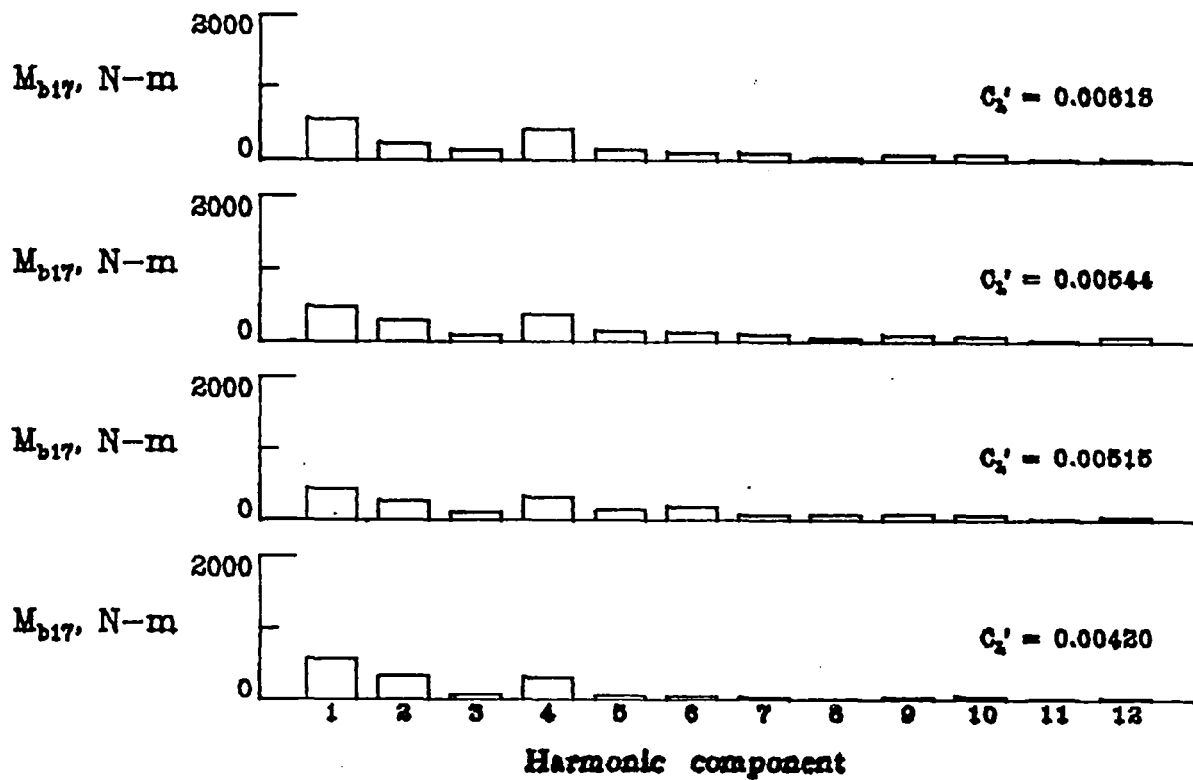

(a)  $M_{b17}$

Figure 21. - Harmonic content of rotor loads for descending right turn.  $\bar{\mu} = 0.24$

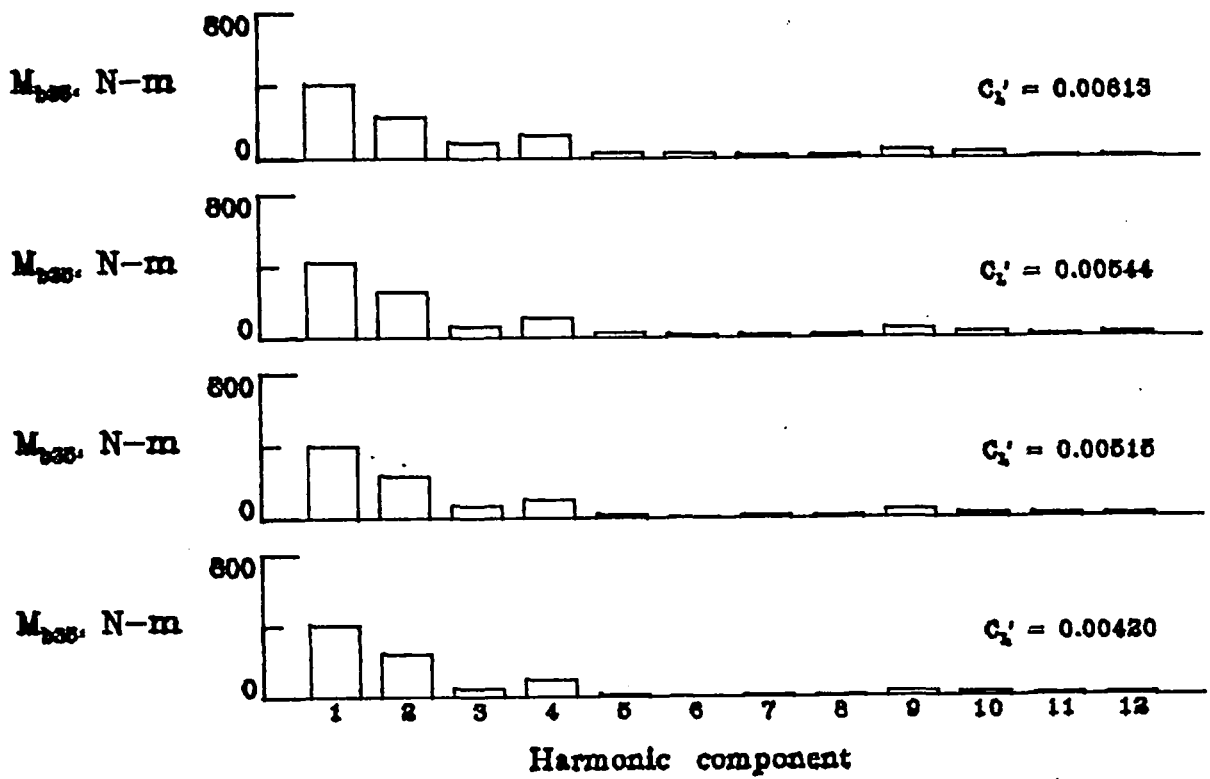

(b)  $M_{b35}$

Figure 21. - Continued

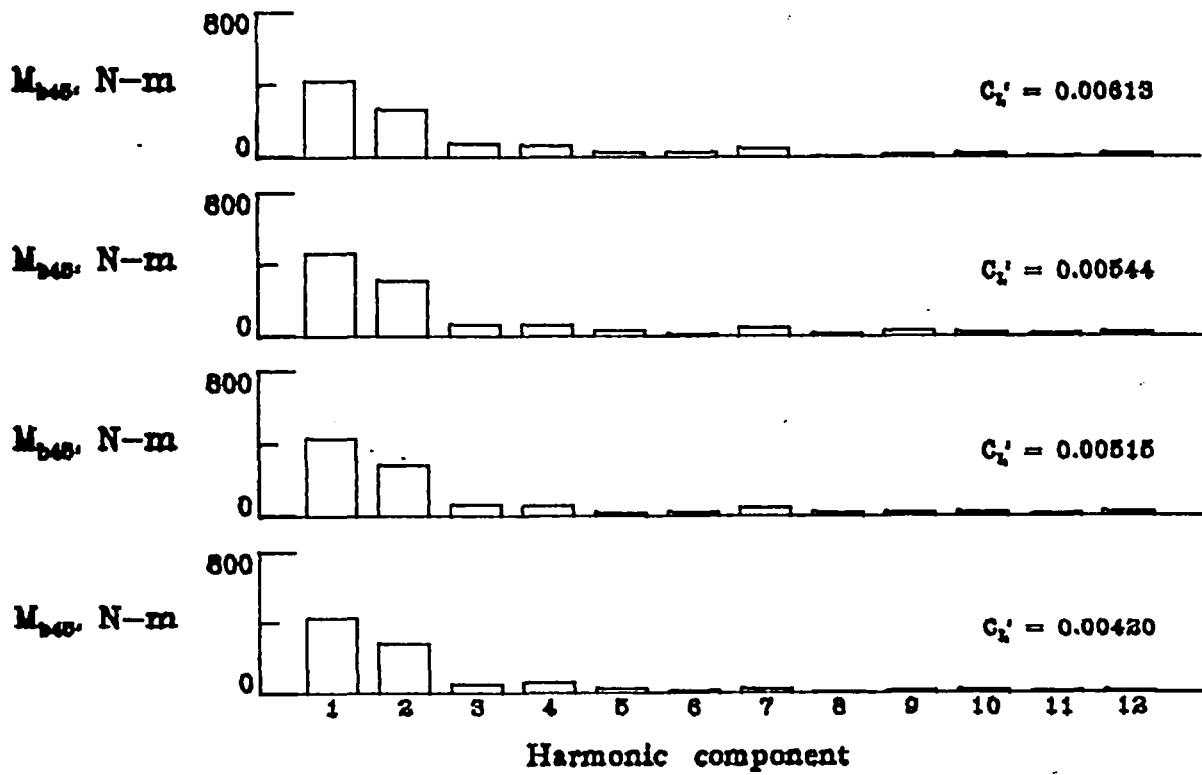

(c)  $M_{b45}$

Figure 21. - Continued

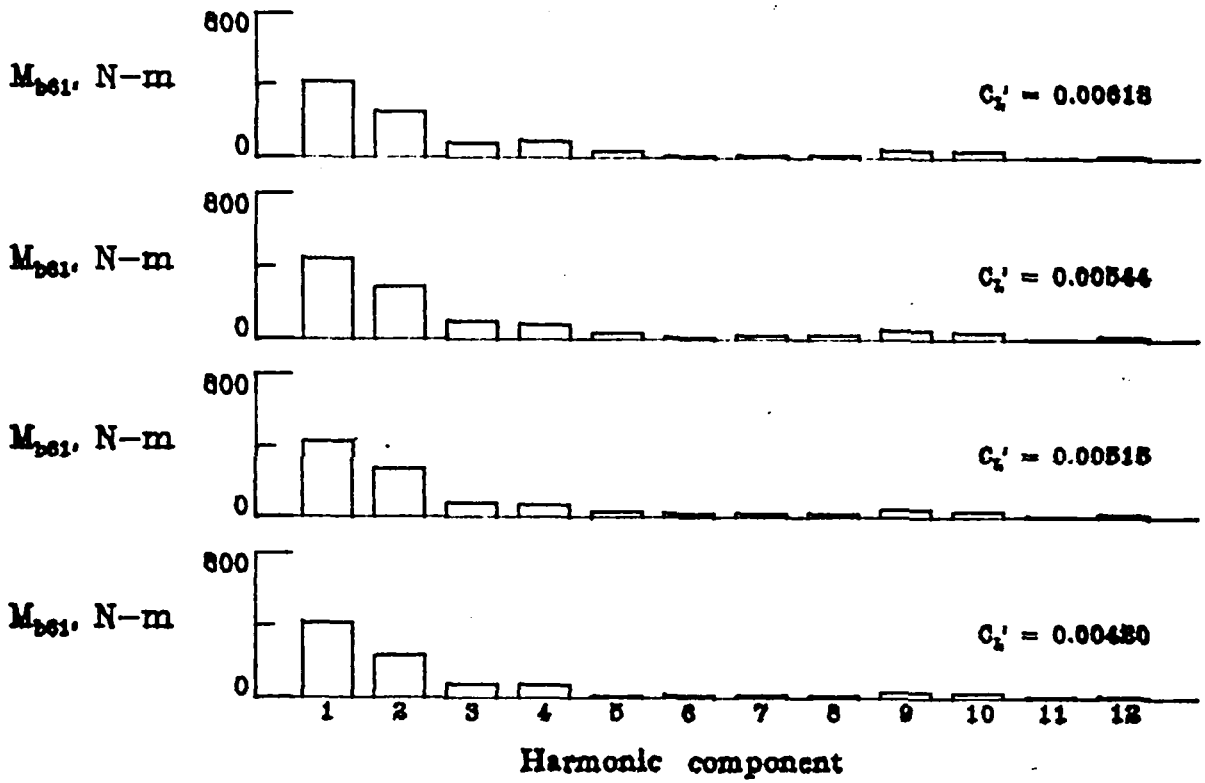

(d)  $M_{b61}$

Figure 21. - Continued

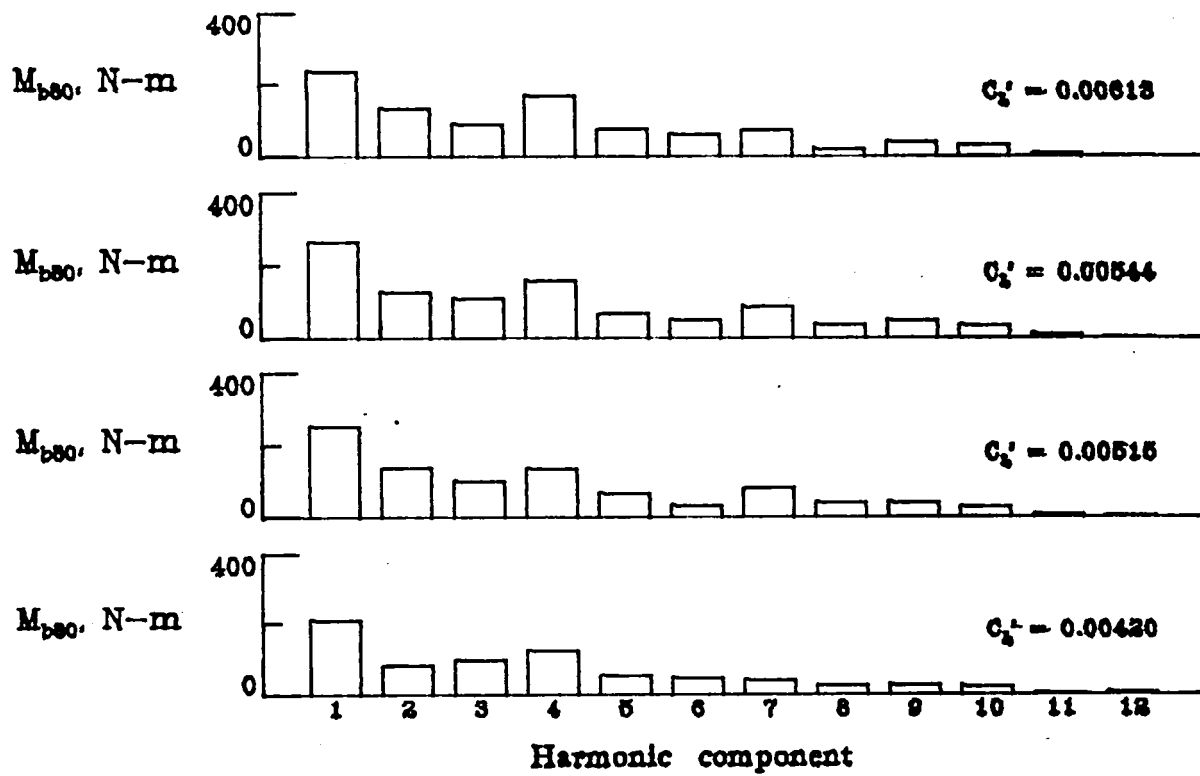

(e)  $M_{b80}$

Figure 21. - Continued

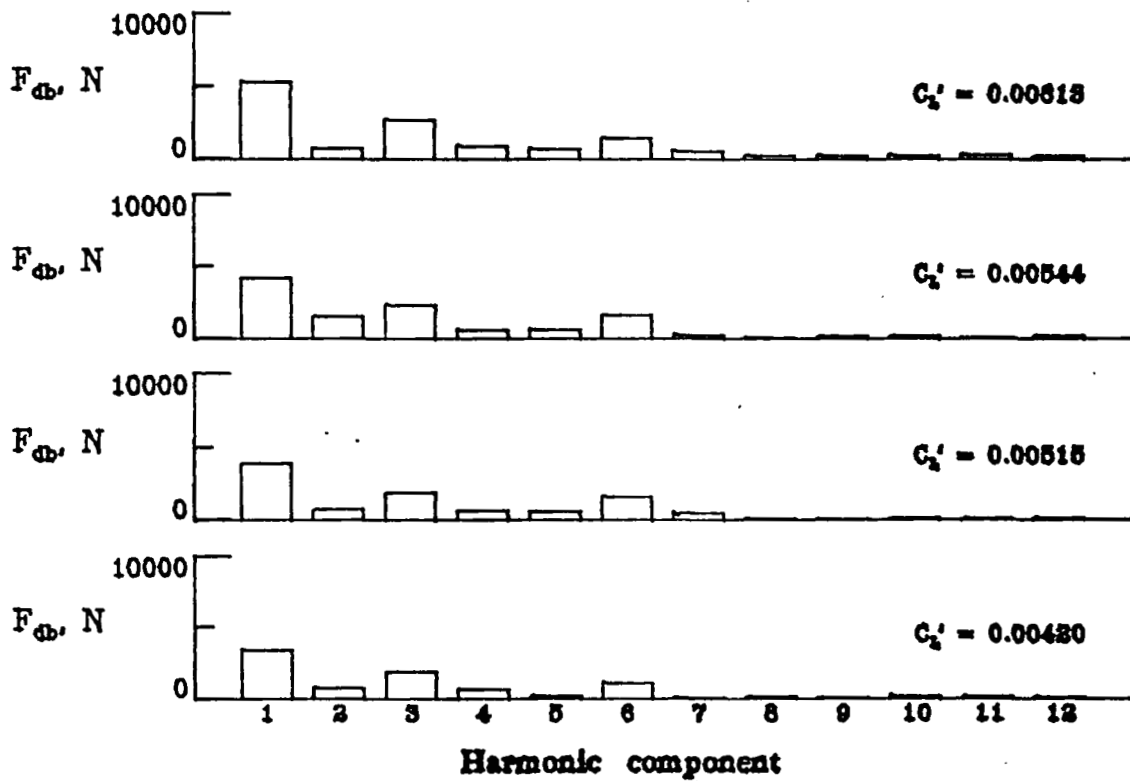

(f)  $F_{db}$

Figure 21. - Continued

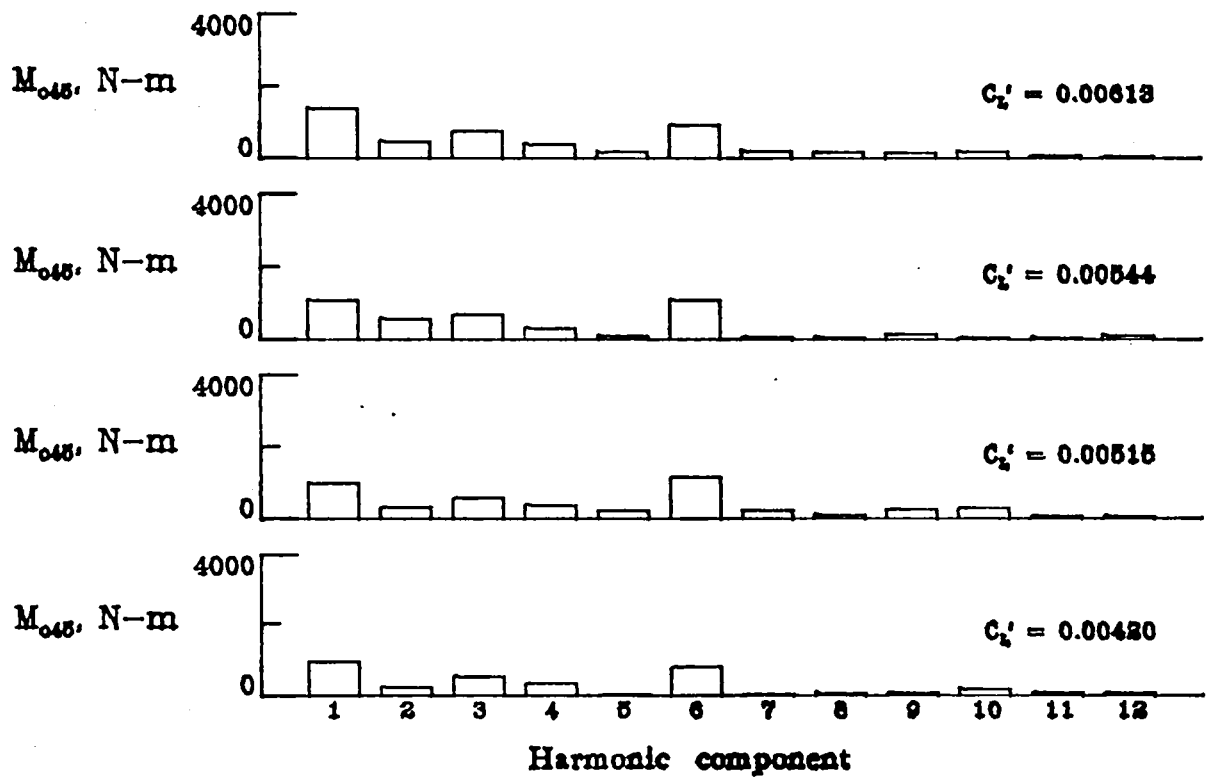

(g)  $M_{c45}$

Figure 21. - Continued

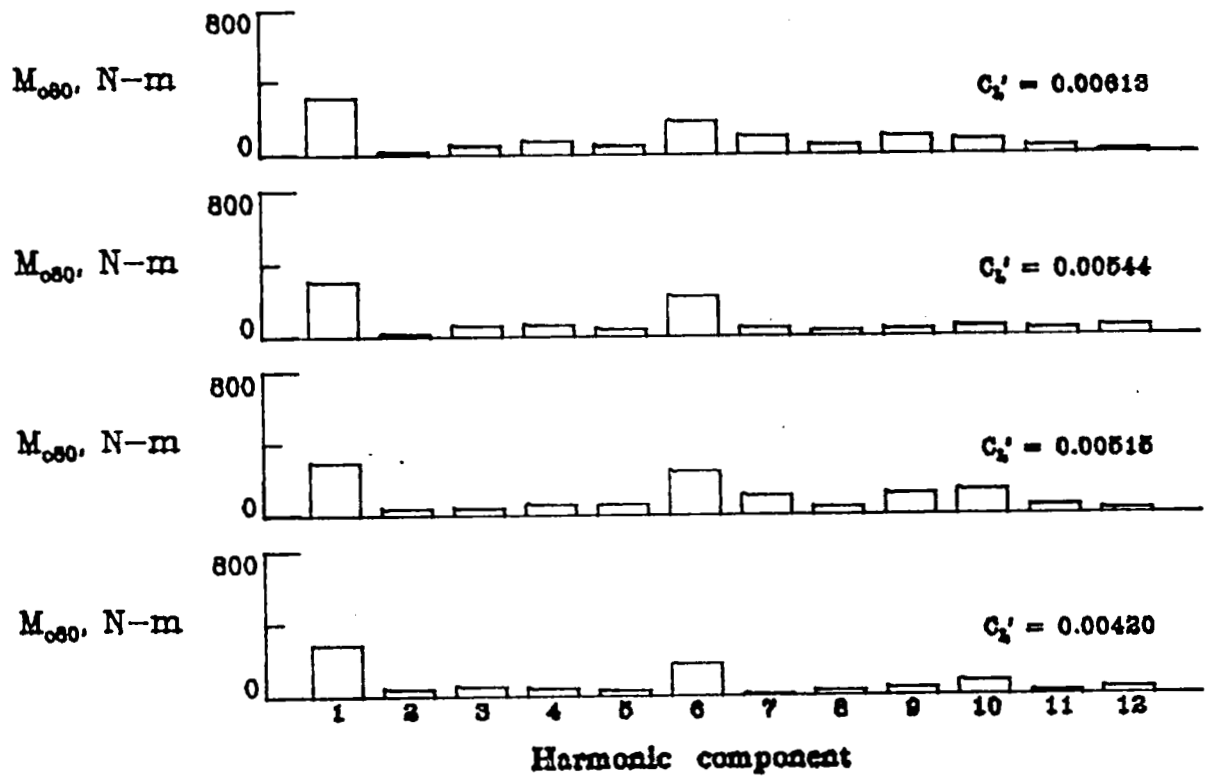

(h)  $M_{c80}$

Figure 21. - Continued



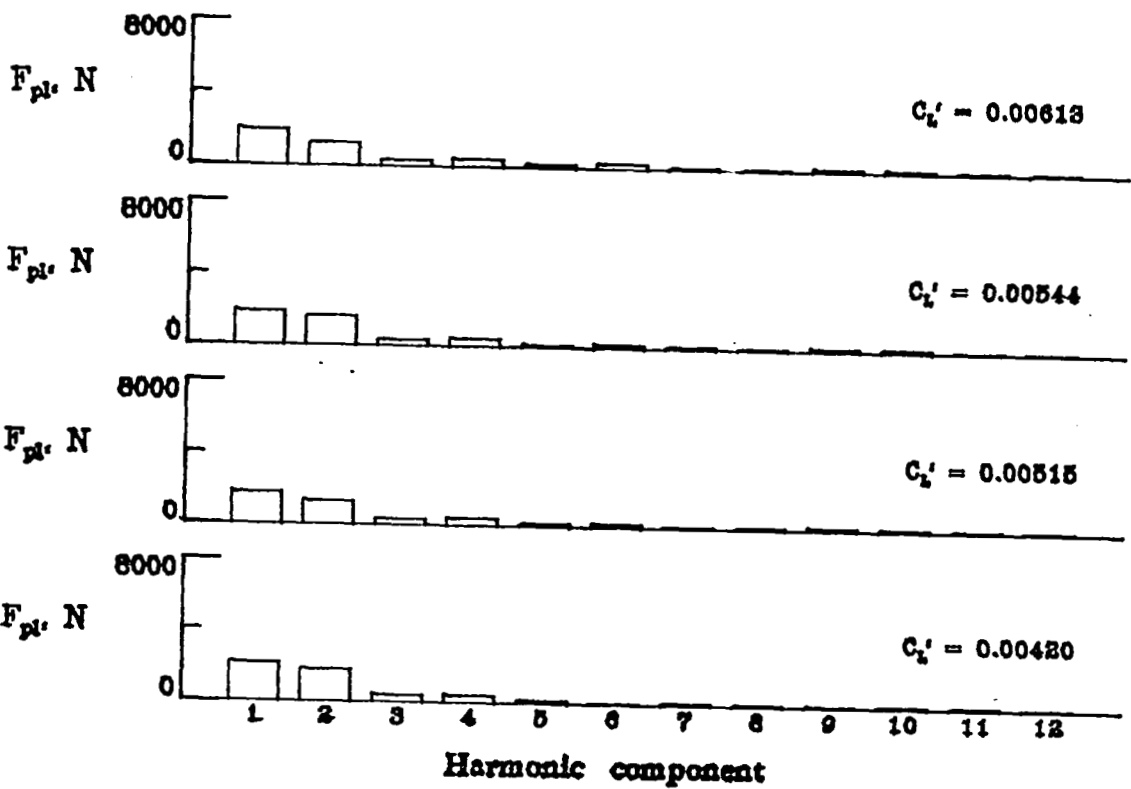

(i)  $F_{p1}$

Figure 21. - Continued

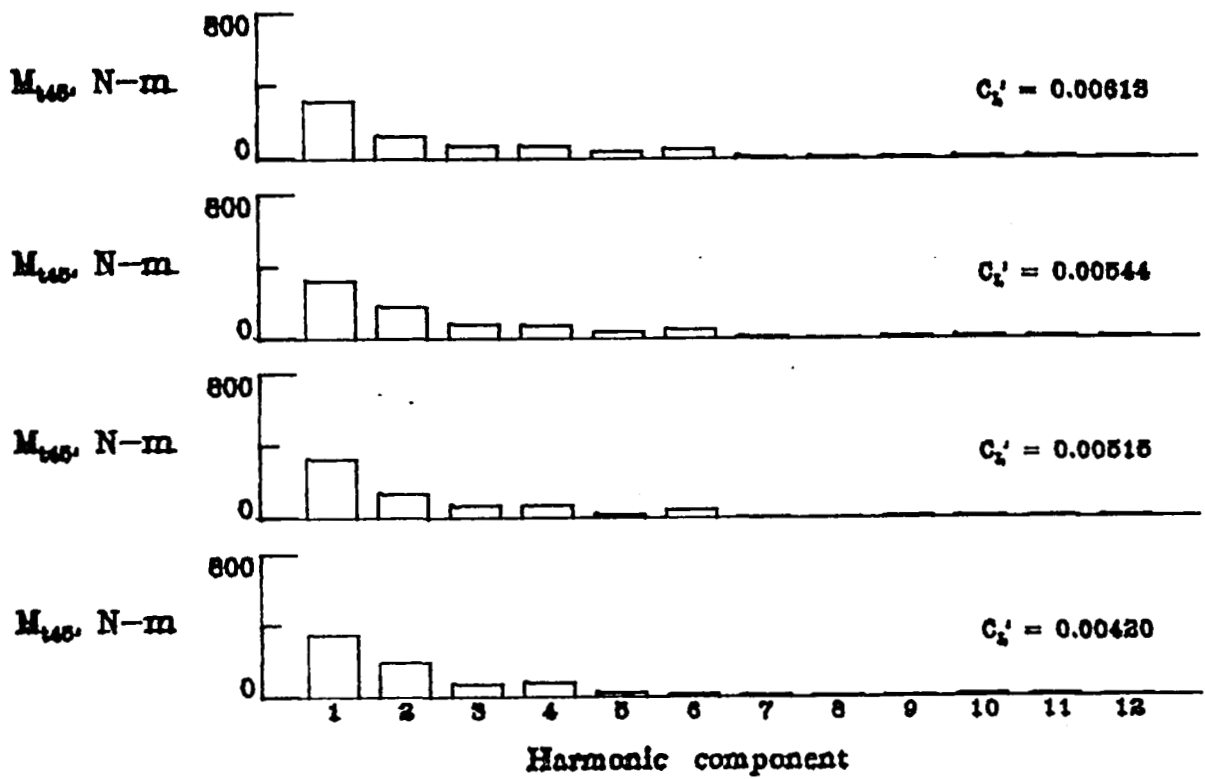

(j)  $M_{t45}$

Figure 21. - Concluded.

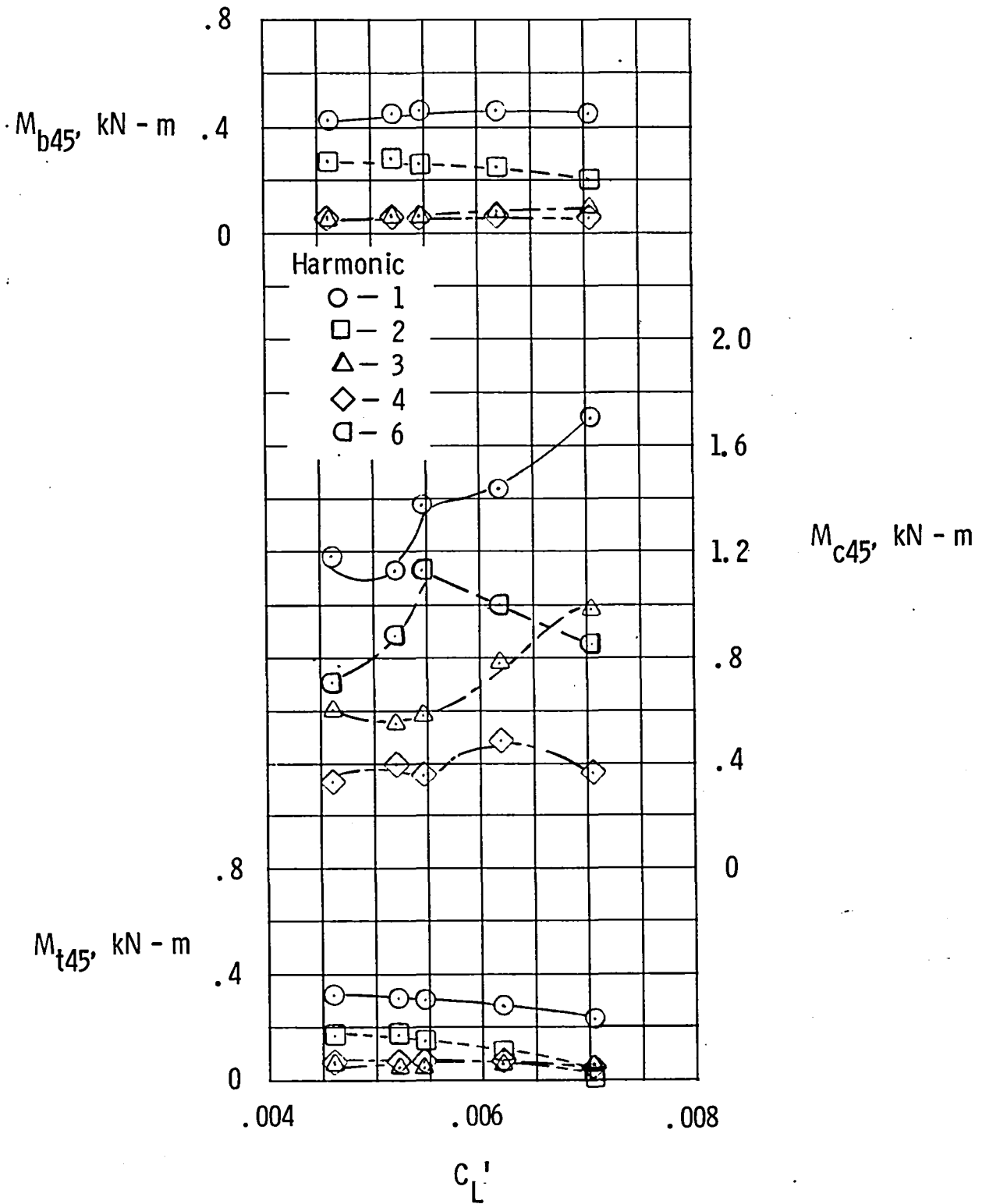
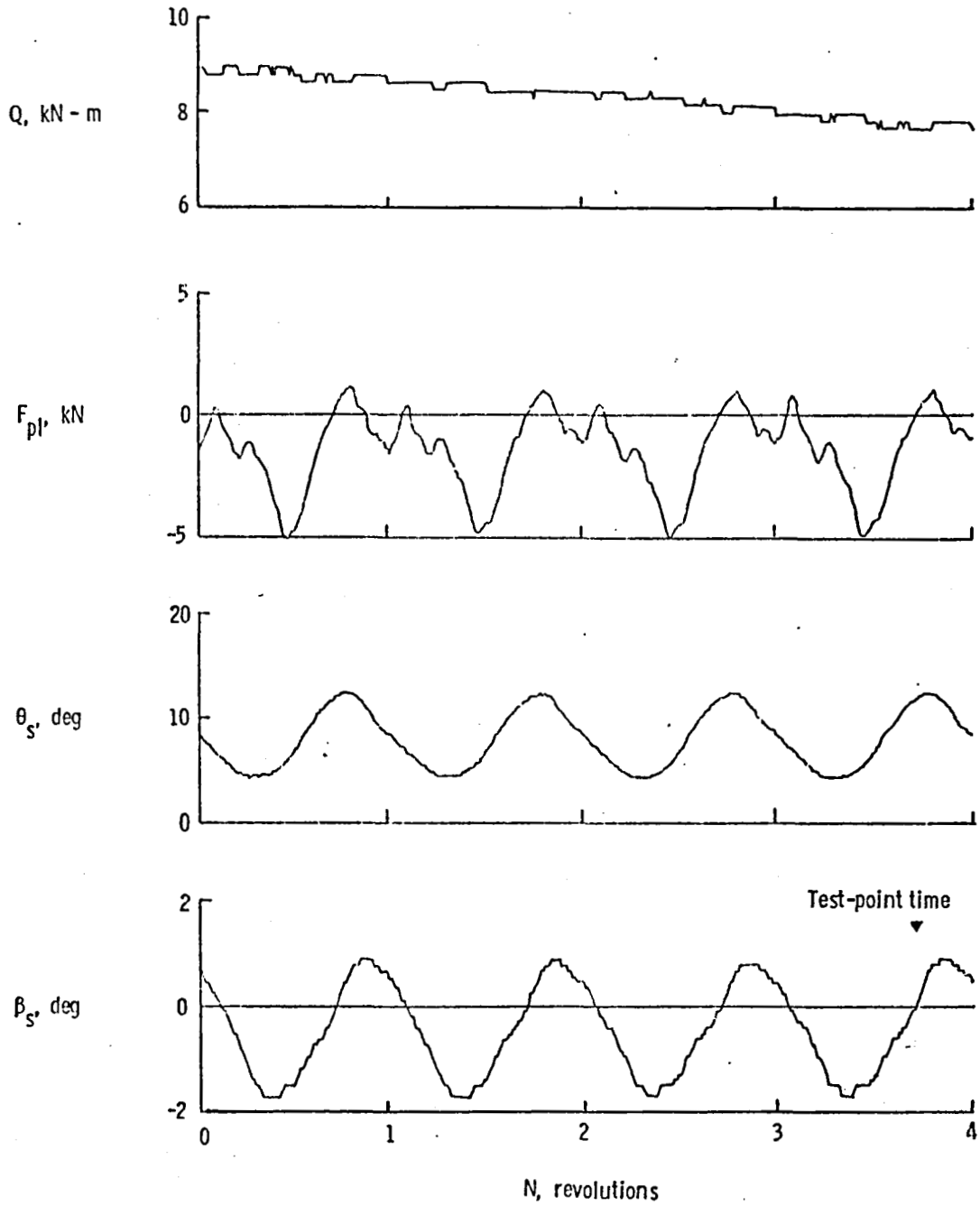
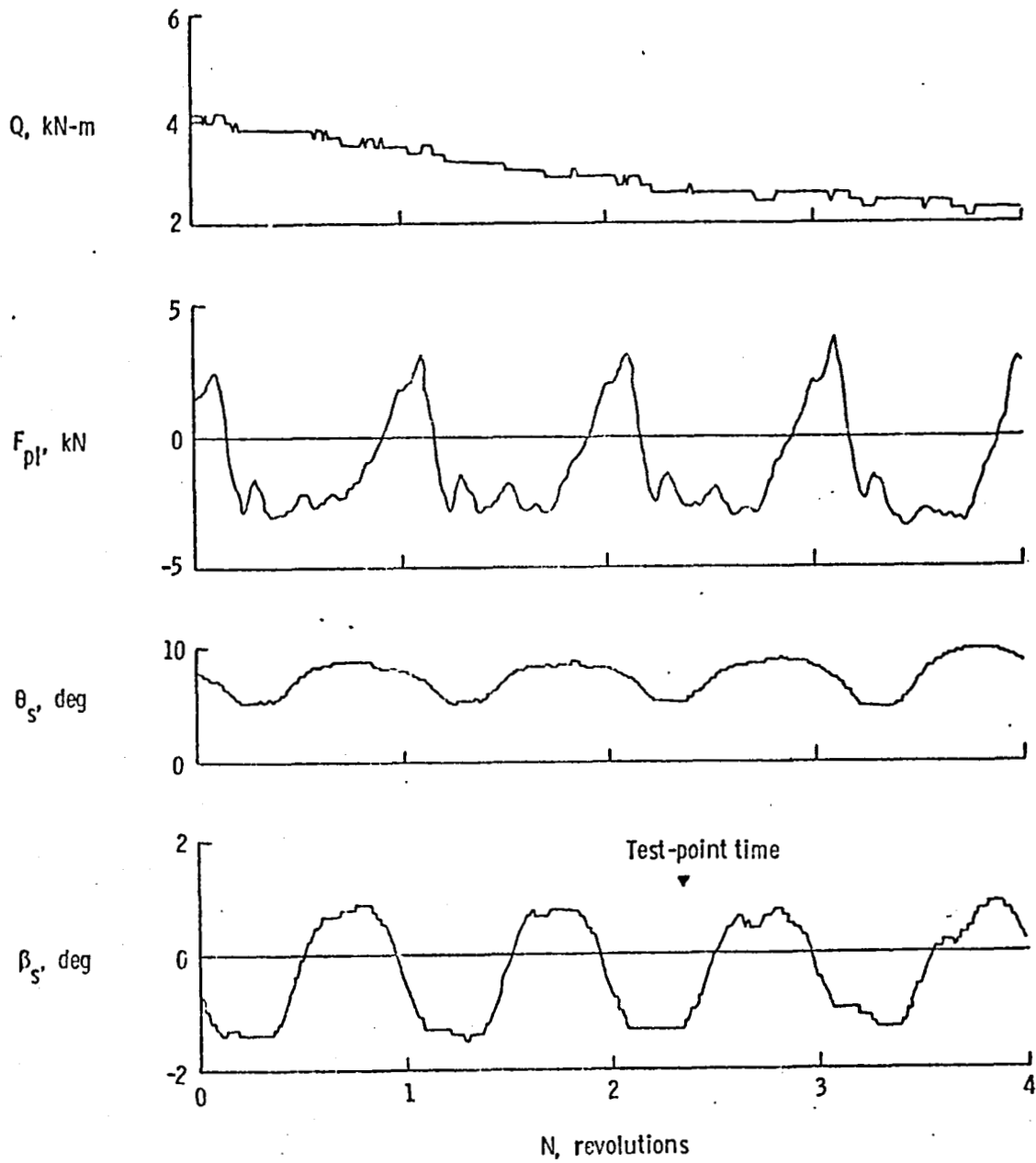

Figure 22. - Effect of Vehicle load coefficient on primary harmonic-load components for descending right turns.  $\bar{\mu} = 0.25$ .



(a)  $\mu = 0.24$ ;  $C_L^i = 0.0060$   
 (Flight 66, run 20 of Appendix c)

Figure 23. - Typical rotor-data histories for symmetrical pull-ups. Test-point time for data reduction was chosen on the basis of PADS data for vehicle pitch attitude.



(b)  $\mu = 0.23$ ;  $c_L' = 0.0079$

Figure 23. - Concluded.

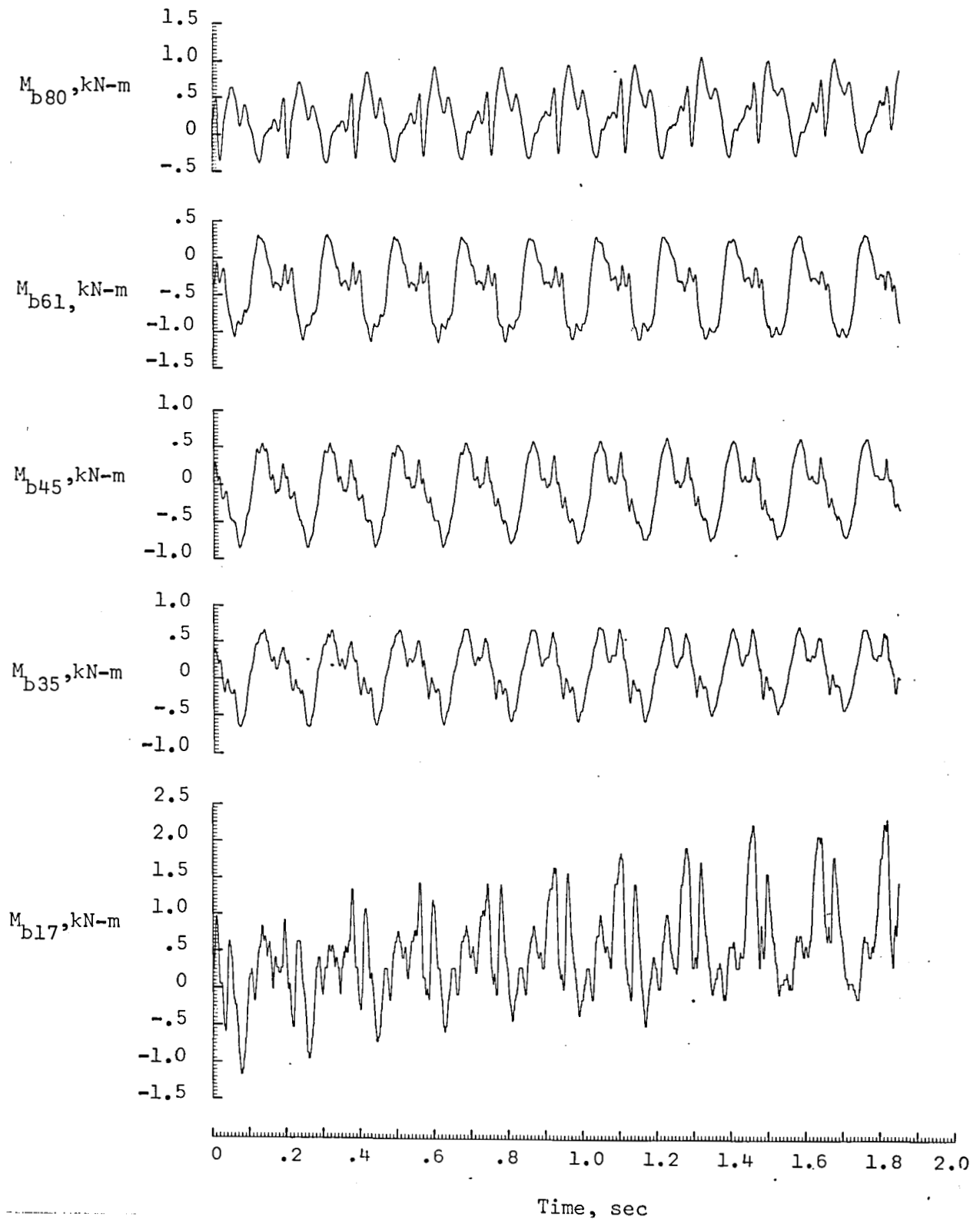

(a) Beamwise loads.

Figure 24. - Rotor-load histories for typical symmetrical pull-up  
 (Flight 66, run 22 of Appendix C).  $\mu = 0.25$ ;  $C_L' = 0.0078$

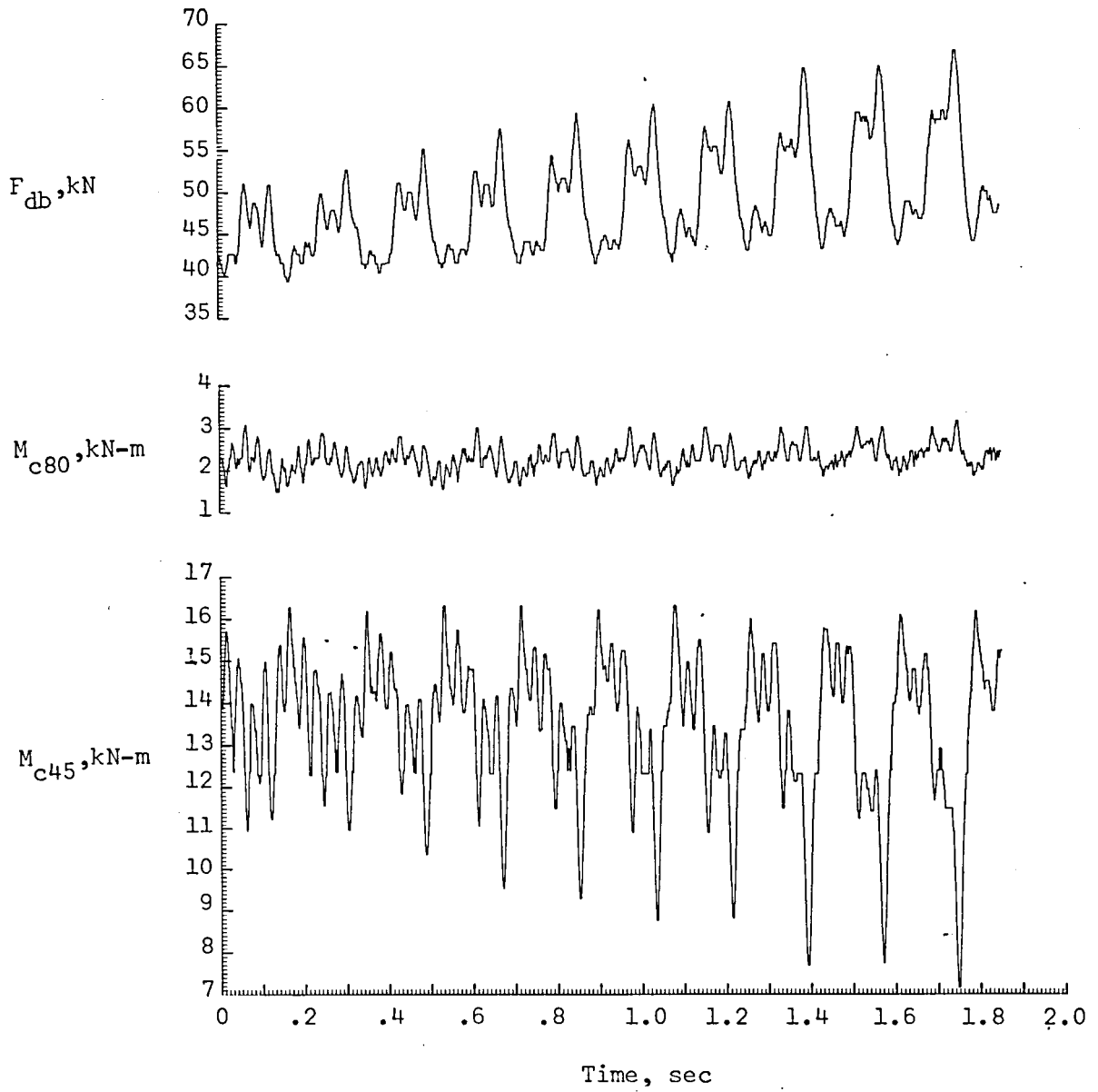

(b) chordwise loads.

Figure 24. - Continued

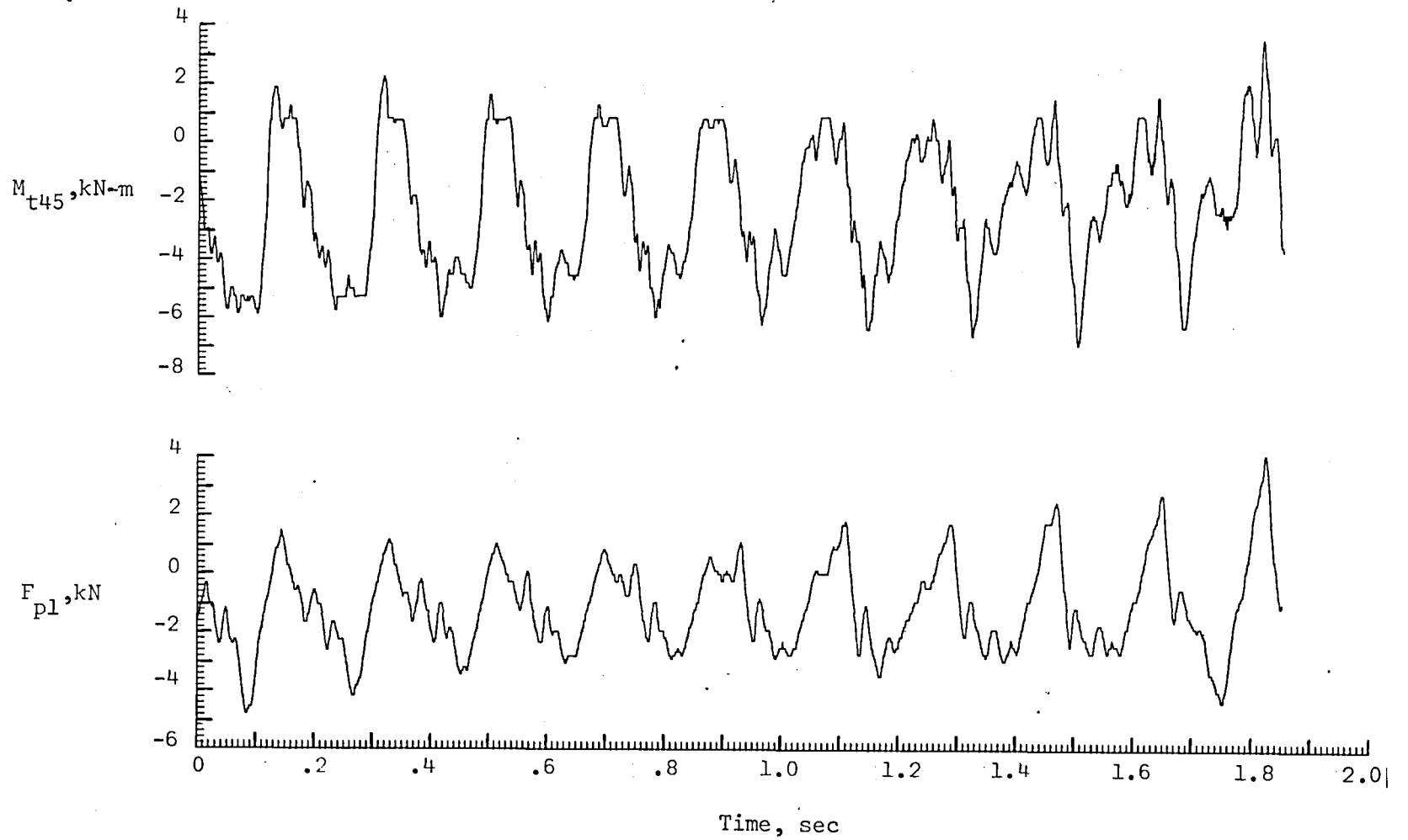

(c) torsional loads.

Figure 24. - Concluded.



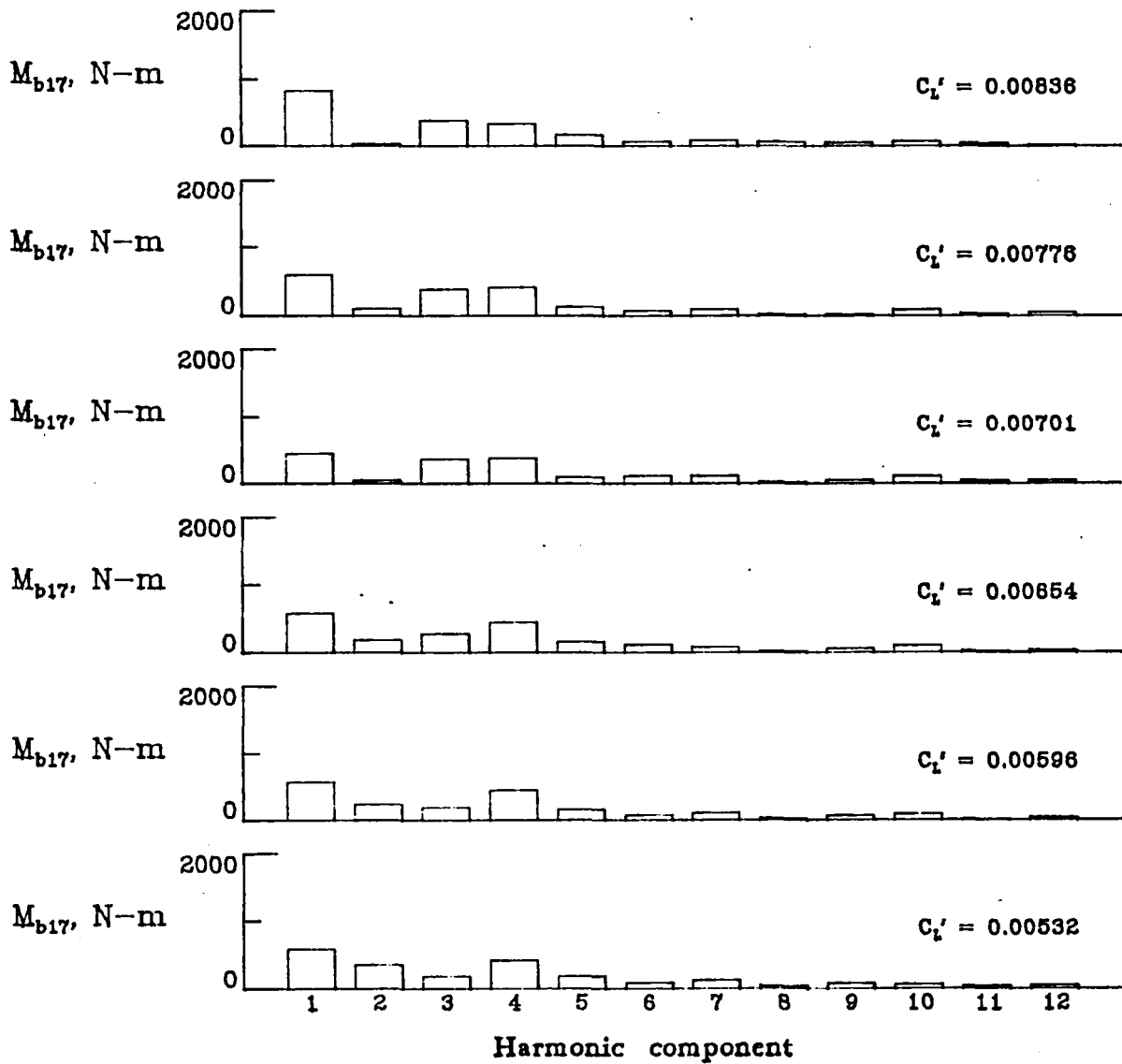

(a)  $M_{b17}$

Figure 25. - Harmonic content of rotor loads for symmetrical pull-ups.  
 $\mu = 0.25$ .

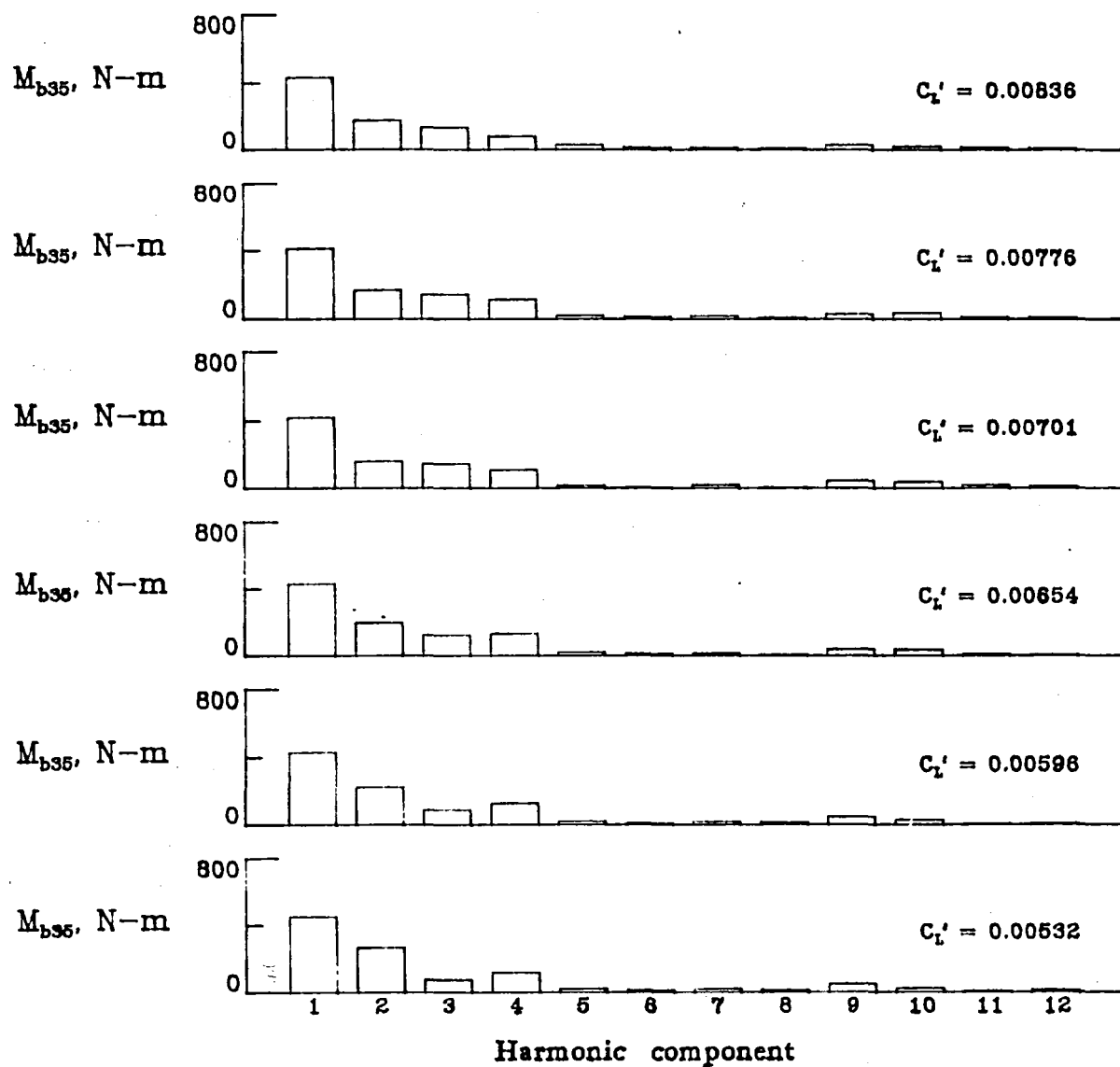

(b)  $M_{b35}$

Figure 25. - Continued.

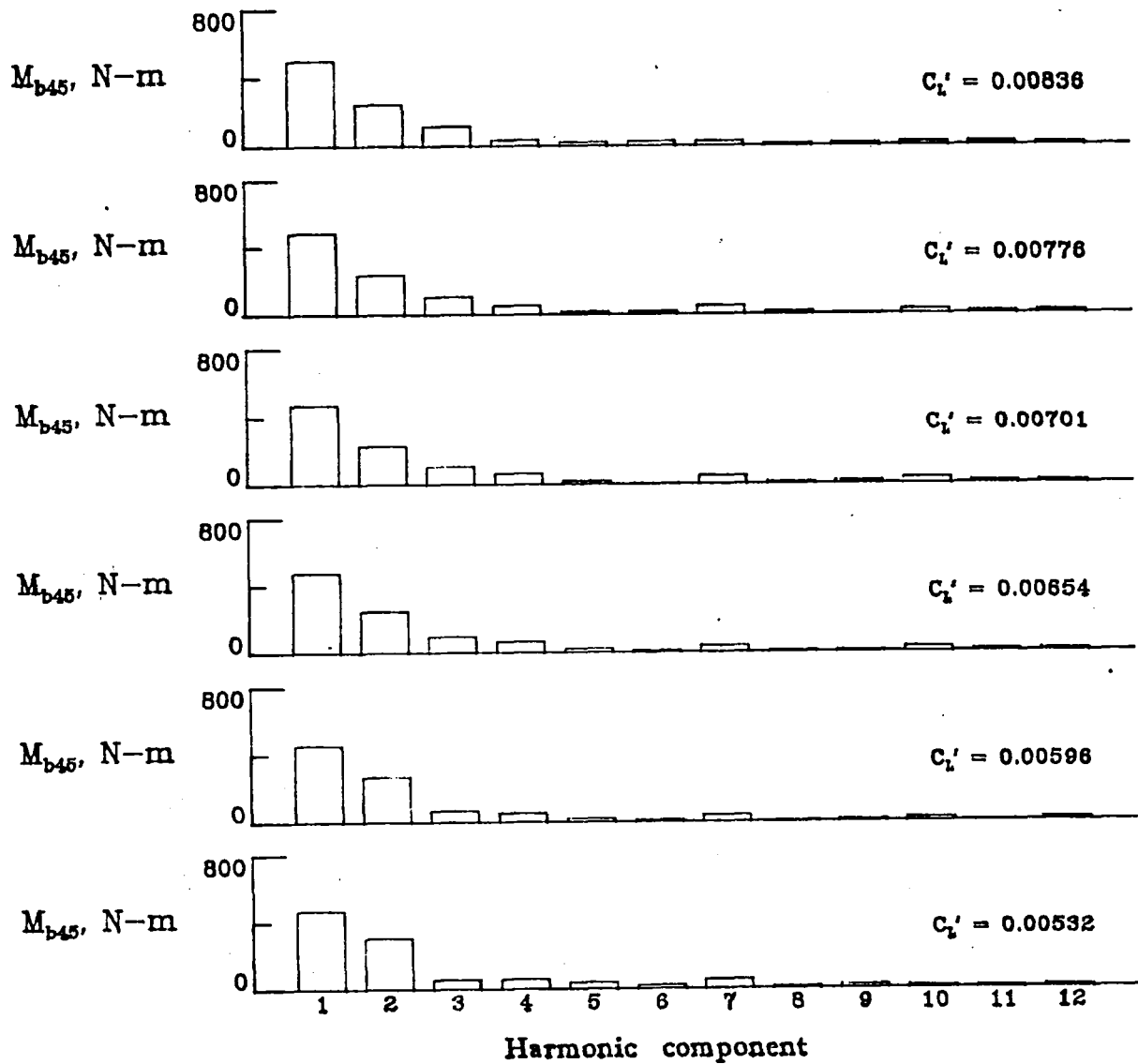

(c)  $M_{b45}$

Figure 25. - Continued.

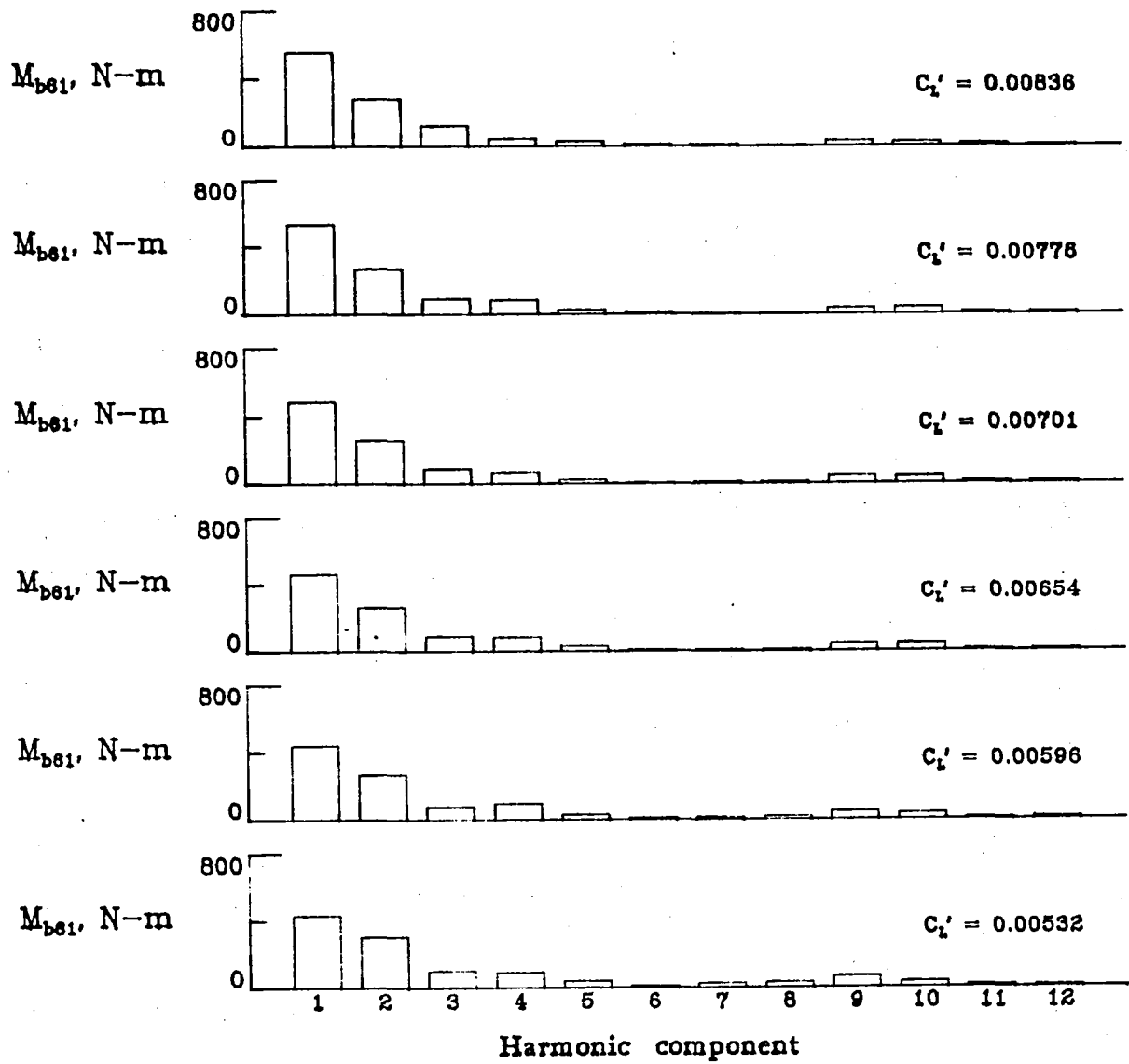

(d)  $M_{b61}$

Figure 25. - Continued.

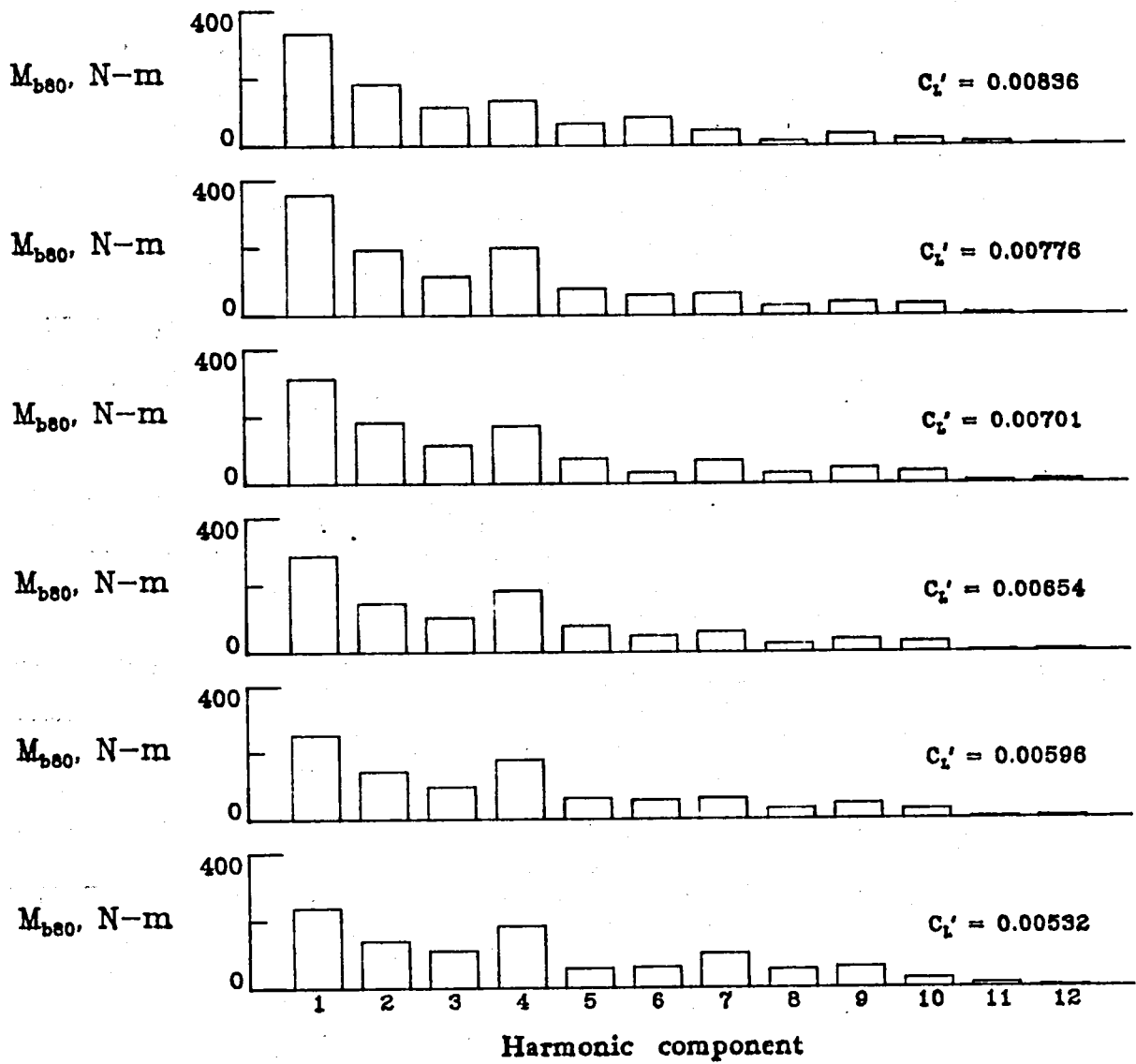

(e)  $M_{b80}$

Figure 25. - Continued.

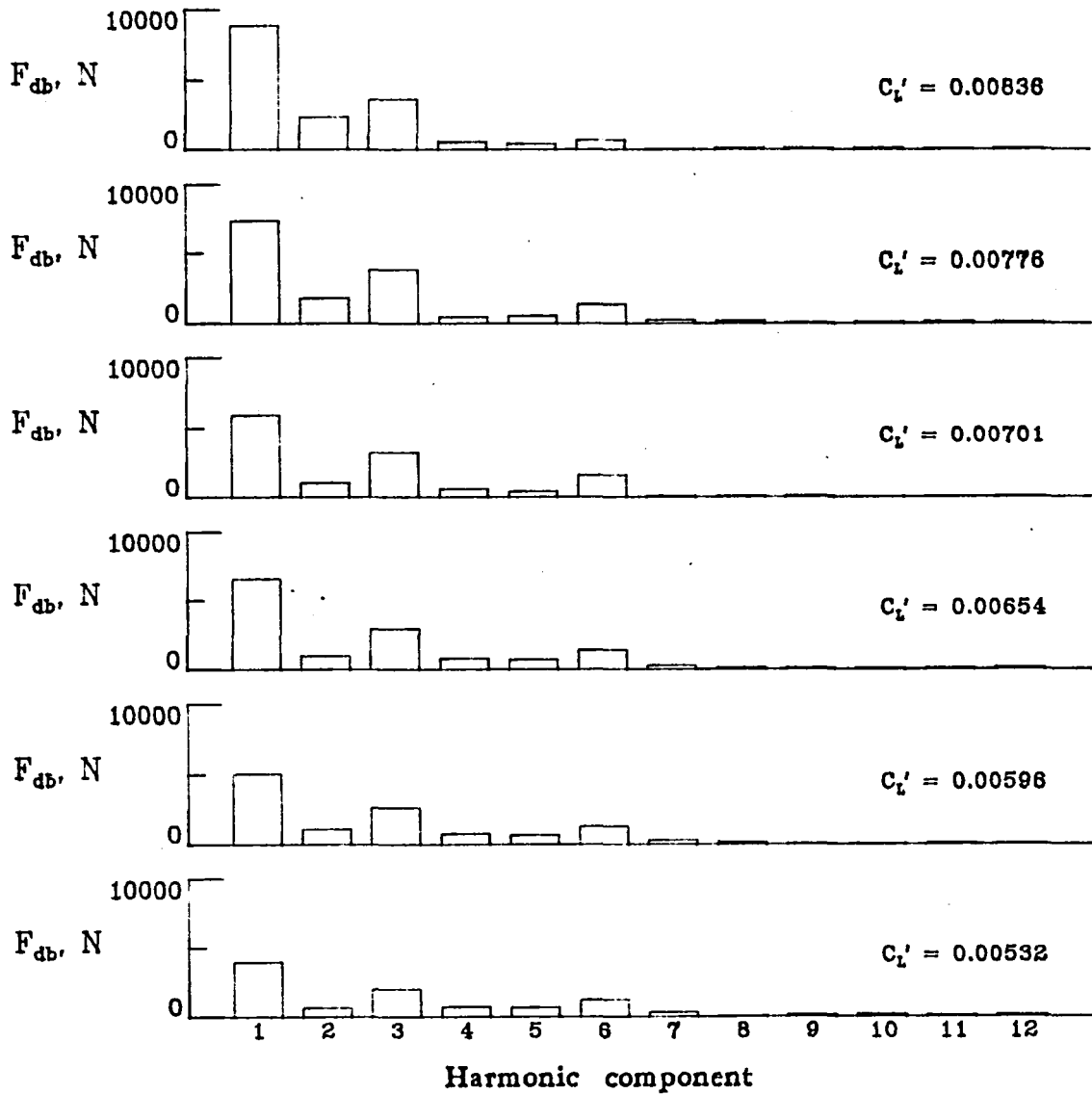

(f)  $F_{db}$

Figure 25. - Continued.

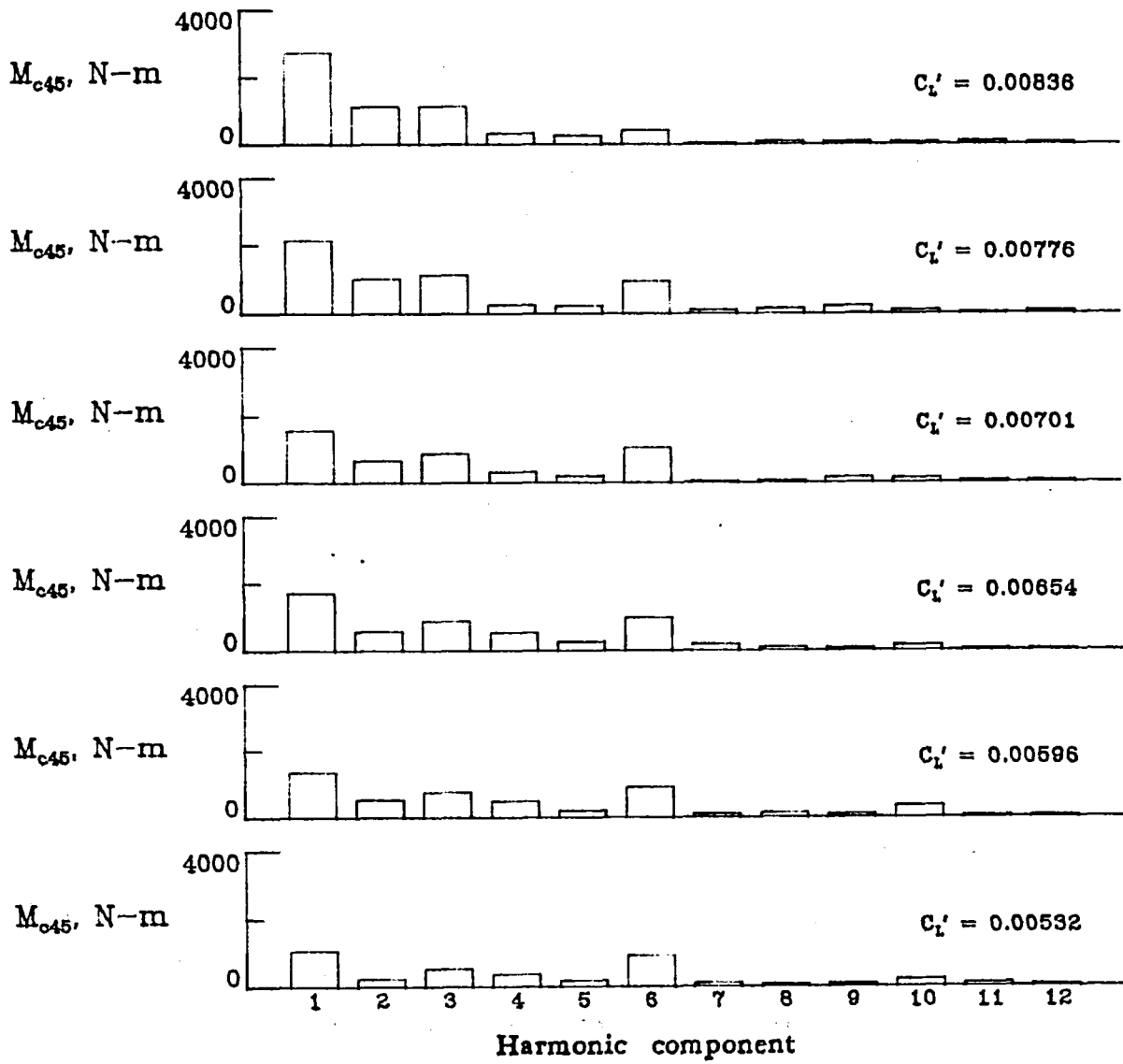

(g)  $M_{c45}$

Figure 25. - Continued.

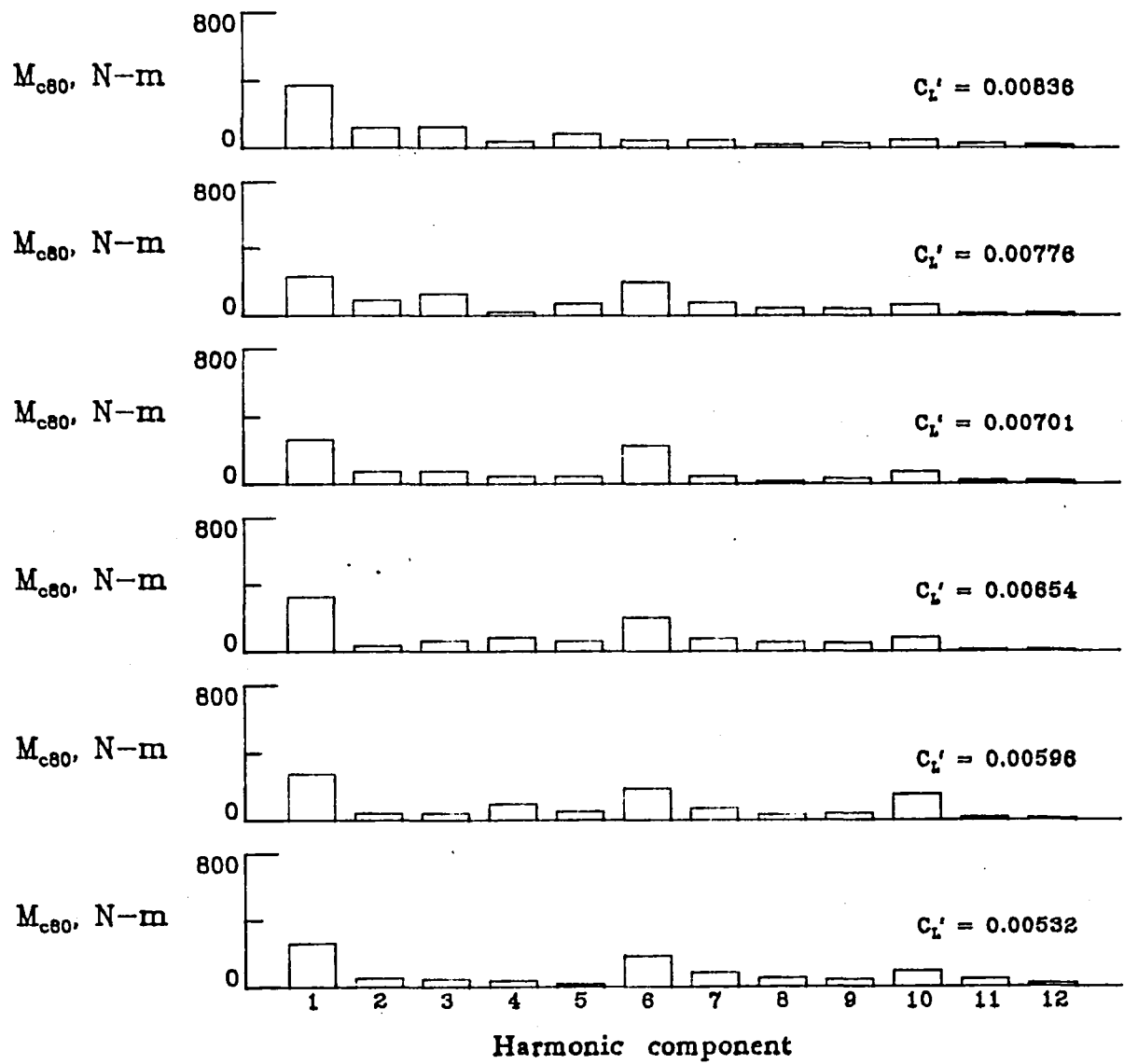

(h)  $M_{c80}$

Figure 25. - Continued.



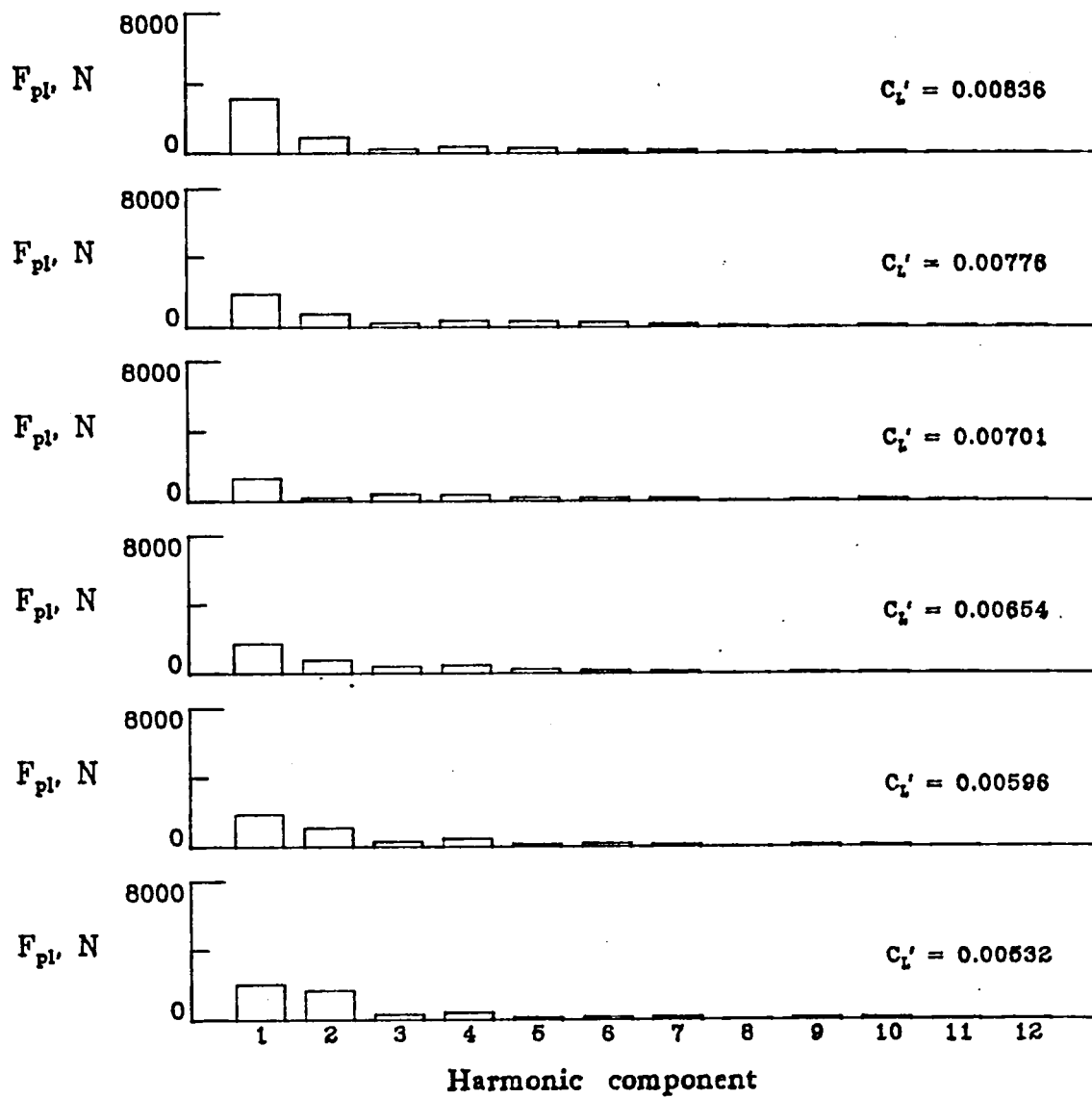

(i)  $F_{p1}$

Figure 25. - Continued.

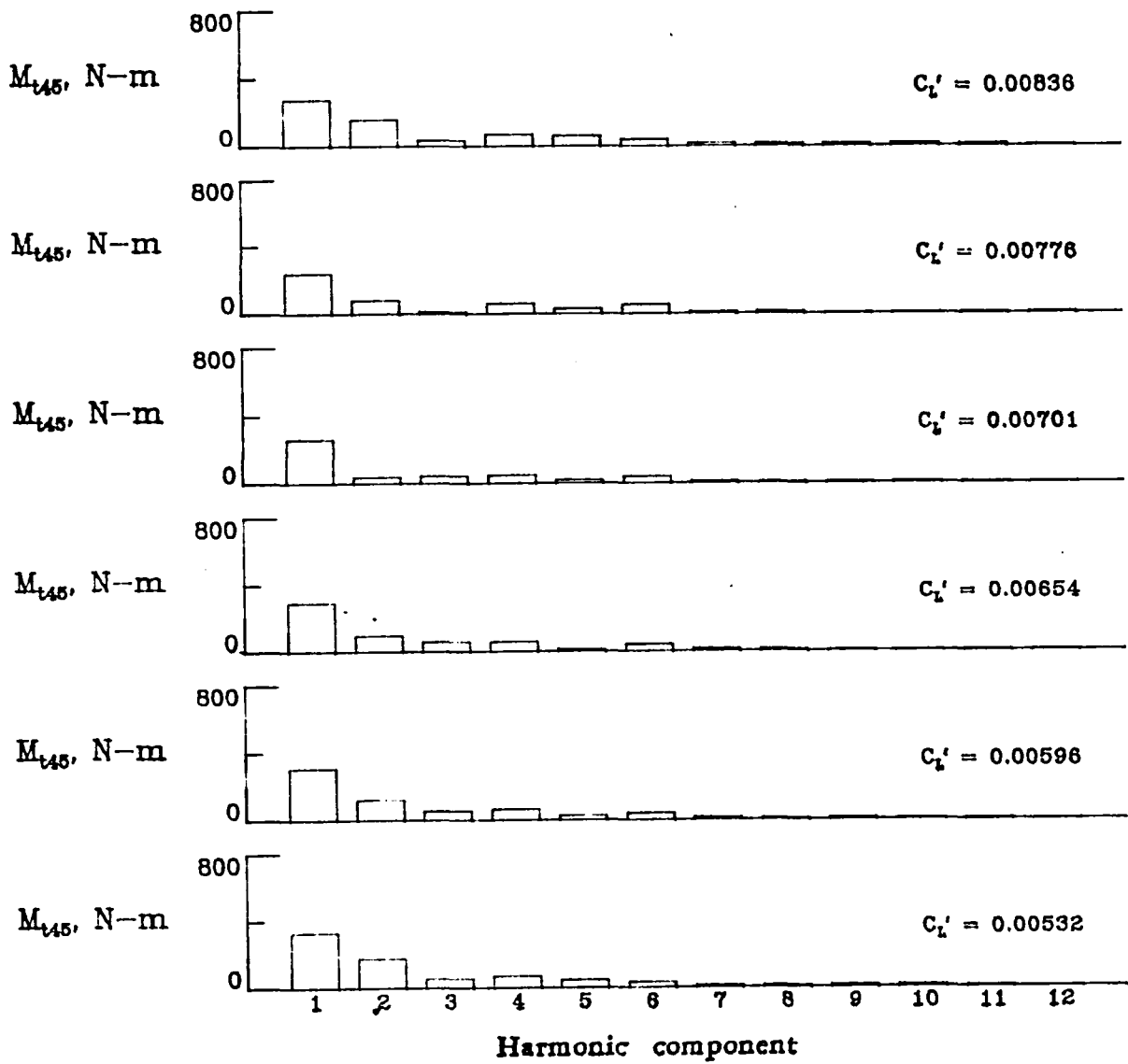

(j)  $M_{t45}$

Figure 25. - Concluded.

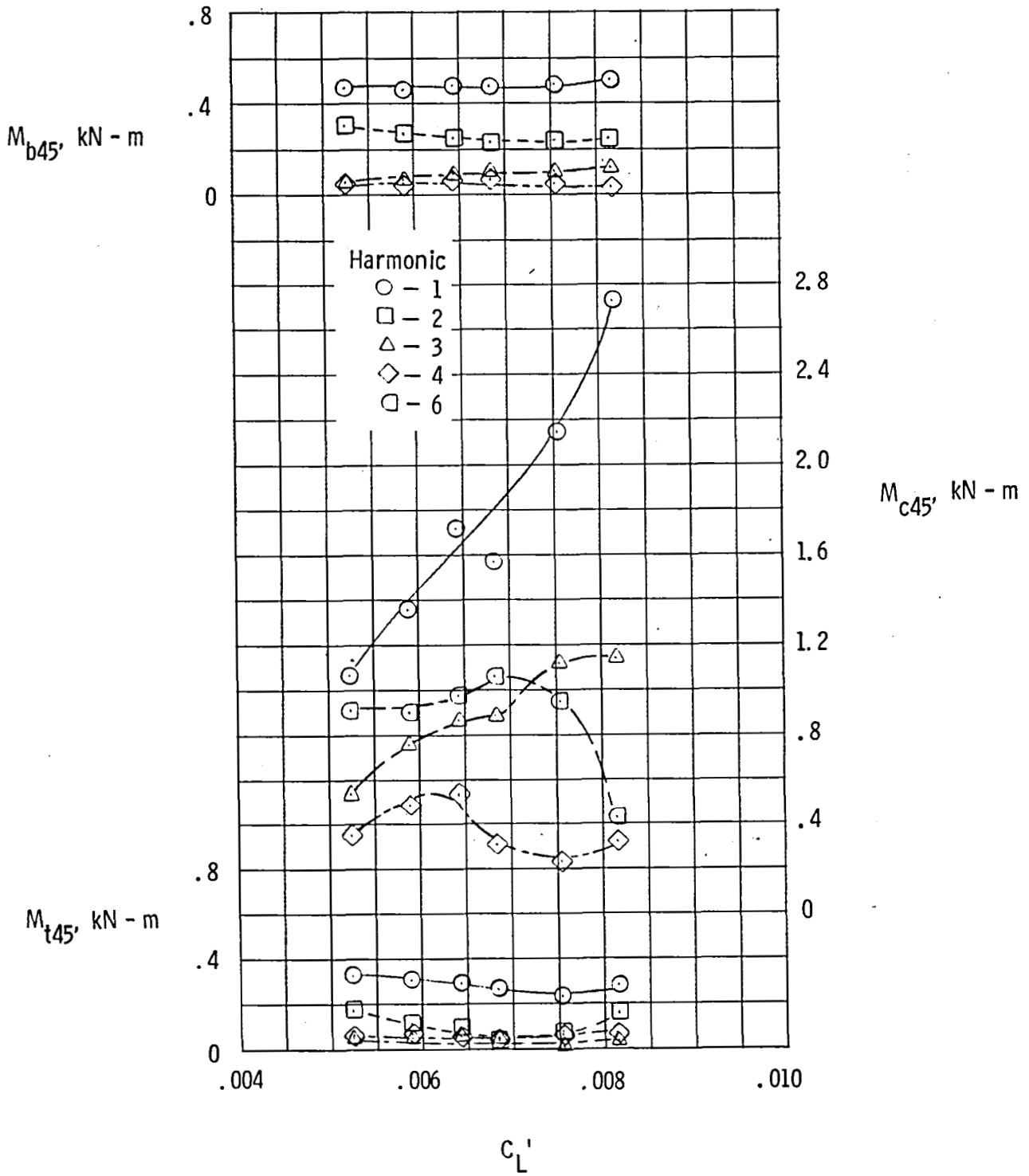
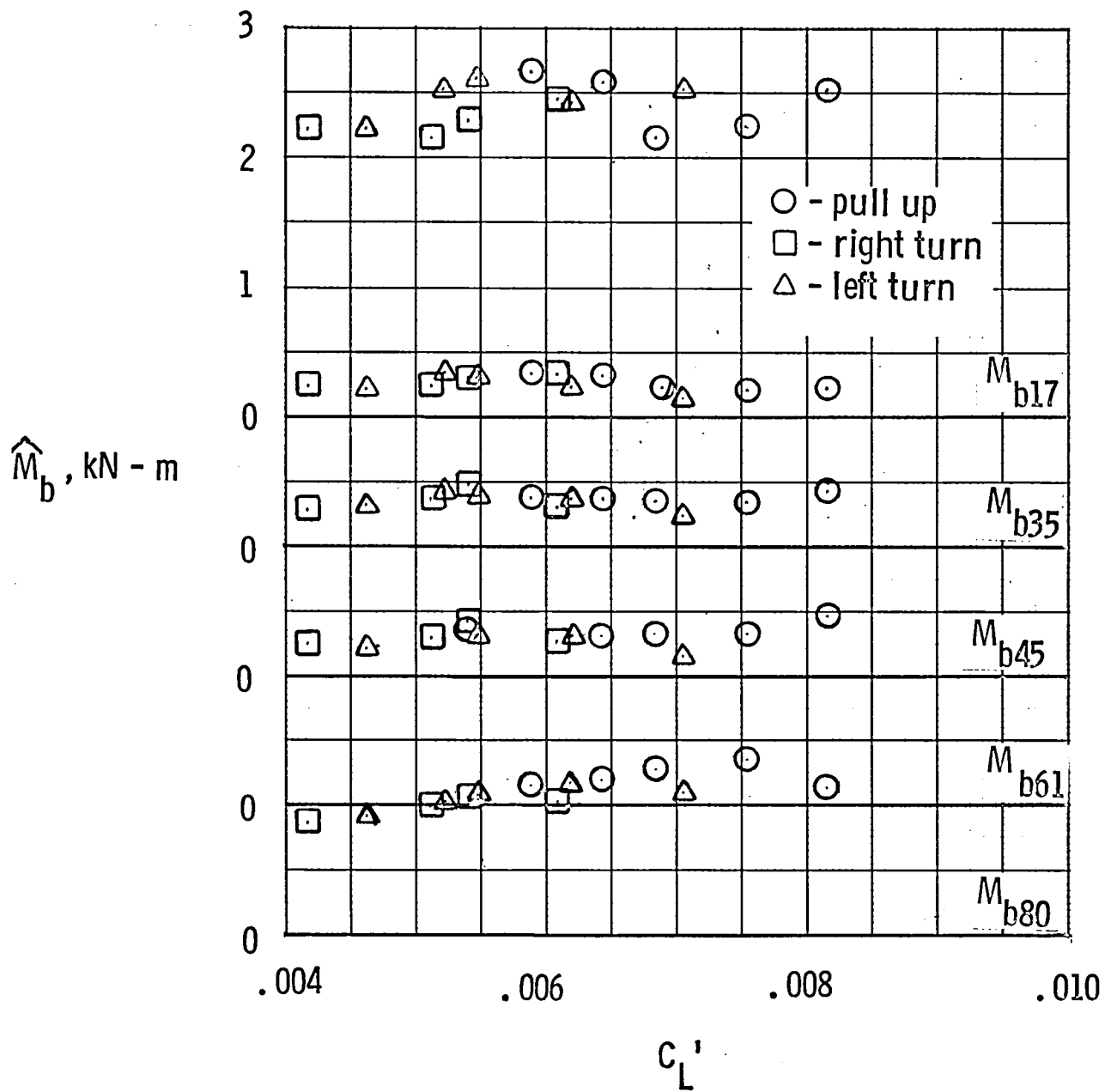
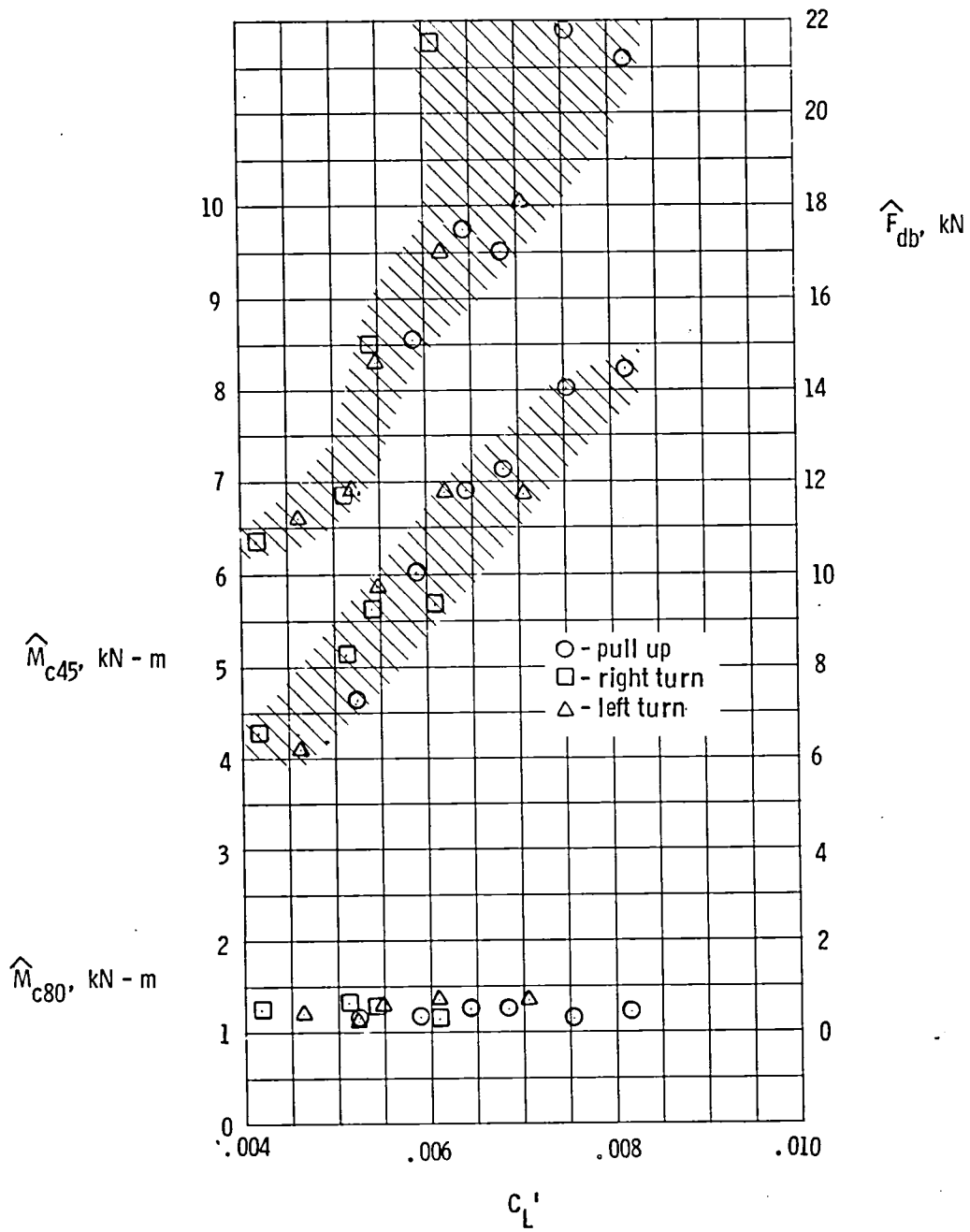

Figure 26. - Effect of vehicle load coefficient on primary harmonic-load components for symmetrical pull-ups.  $\bar{\mu} = 0.25$



(a) beamwise loads.

Figure 27. - Effect of vehicle load coefficient on peak-to-peak loads for maneuvering flight.  $\bar{\mu} = 0.25$ .



(b) chordwise loads.

Figure 27. - Continued

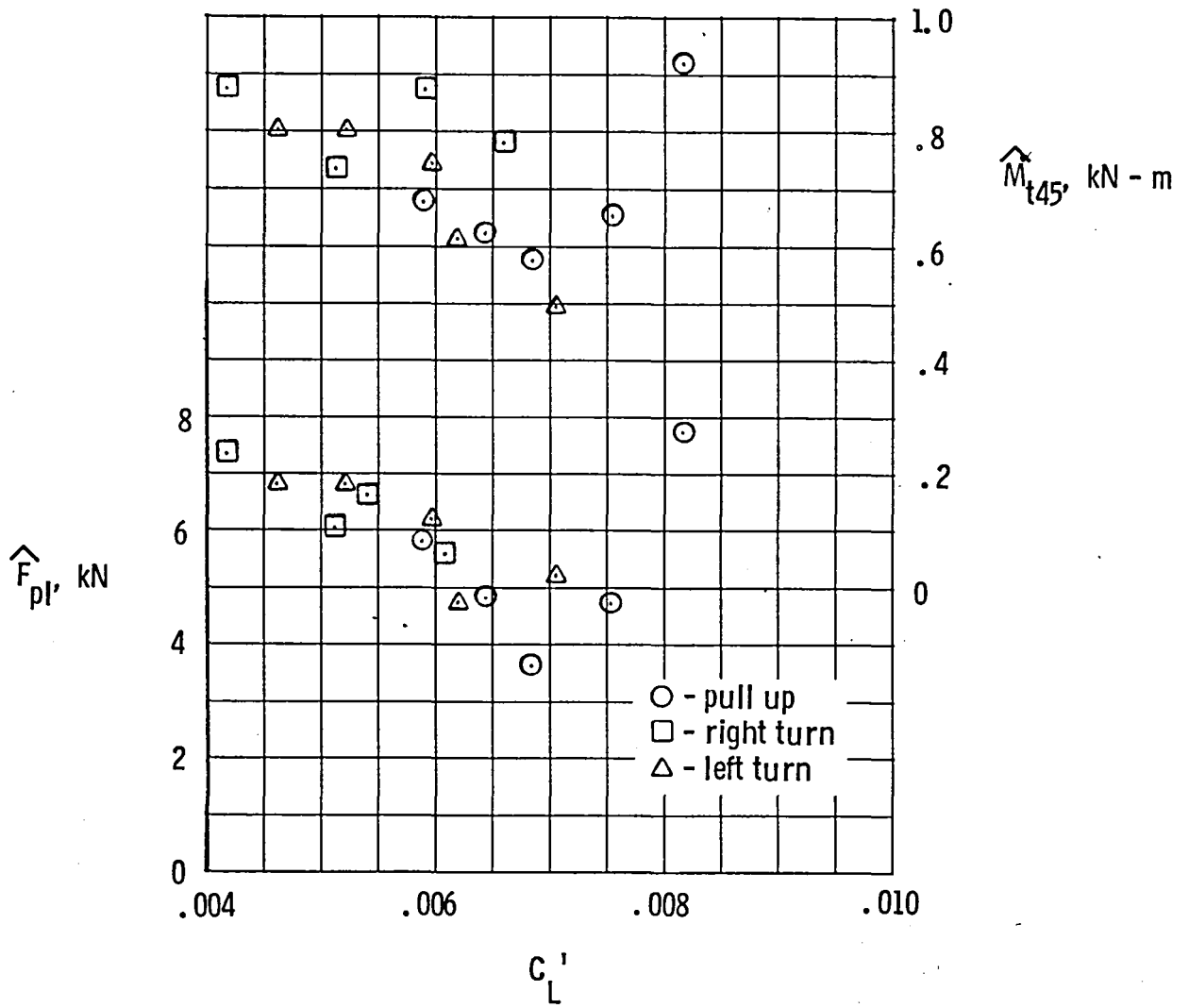

(c) torsional loads.

Figure 27. - Concluded.

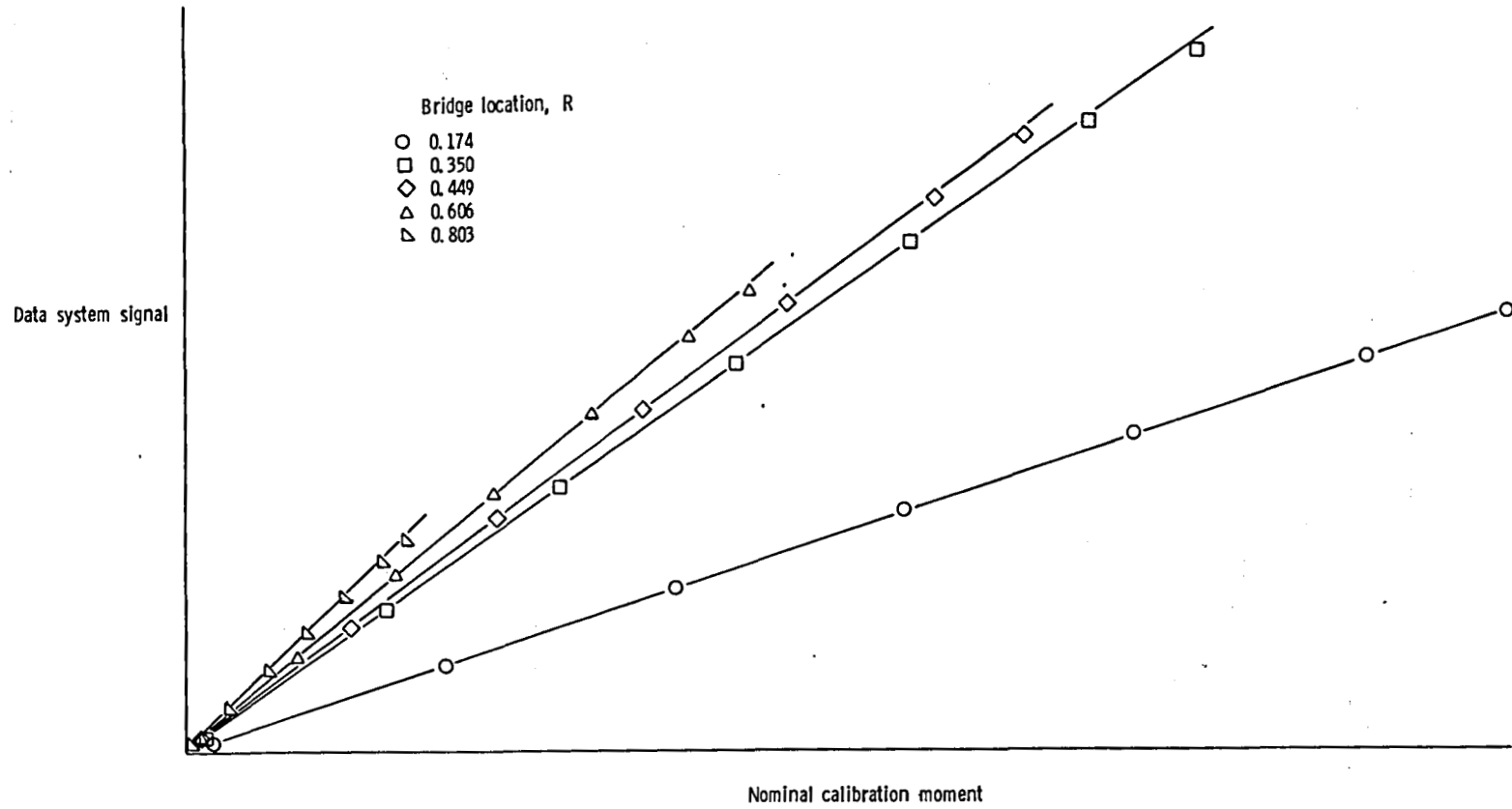

Figure 28. - Calibration data for beamwise bending of NLR-1T rotor blade clamped to 0.15R and loaded at 0.93R.

1. Report No. NASA TM 80165		2. Government Accession No.		3. Recipient's Catalog No.	
4. Title and Subtitle A FLIGHT INVESTIGATION OF PERFORMANCE AND LOADS FOR A HELICOPTER WITH NLR-1T MAIN-ROTOR BLADE SECTIONS				5. Report Date October 1979	
				6. Performing Organization Code	
7. Author(s) Charles E. K. Morris, Jr., Robert L. Tomaine, and Dariene D. Stevens				8. Performing Organization Report No.	
9. Performing Organization Name and Address NASA Langley Research Center and Structures Laboratory AVRADCOM Research and Technology Laboratories Hampton, VA 23665				10. Work Unit No.	
				11. Contract or Grant No.	
12. Sponsoring Agency Name and Address National Aeronautics and Space Administration Washington, DC 20546  and U.S. Army Aviation Research and Development Command St. Louis, MO 63166				13. Type of Report and Period Covered Technical Memorandum	
				14. Army Project No.  1L262209AH76	
15. Supplementary Notes a. Charles E. K. Morris, Jr. and Dariene D. Stevens: Langley Research Center Robert L. Tomaine: Structures Laboratory, AVRADCOM Research and Technology Laboratories.  b. Major contributors to this research at LaRC, NASA, were Messrs. M. A. Basnett, M. T. Baxter, P. L. Deal, J. A. Fernandez, P. R. Pfeffer, and L. B. McHenry of FMD and Messrs. J. F. Bryant, J. O. Riggins, F. S. Vassey, and W. A. Walls of FED.					
16. Abstract  A flight investigation has produced data on performance and rotor loads for a teetering-rotor, AH-1G helicopter flown with a main rotor that had the NLR-1T airfoil as the blade-section contour. The test envelope included hover, forward-flight speed sweeps from 35 to 85 m/sec (68 to 165 knots), and collective-fixed maneuvers at about 0.25 tip-speed ratio. The data set for each test point described vehicle flight state, control positions, rotor loads, power requirements, and blade motions.  Rotor loads are reviewed primarily in terms of peak-to-peak and harmonic content. Lower frequency components predominated for most loads and generally increased with increased airspeed, but not necessarily with increased maneuver load factor.  This report covers detailed data for an advanced airfoil on an AH-1G and is applicable for evaluating performance and airfoil analyses.					
17. Key Words (Suggested by Author(s)) Helicopter Performance Rotor loads Teetering rotor			18. Distribution Statement  Unclassified - Unlimited  Star Category 02		
19. Security Classif. (of this report) Unclassified		20. Security Classif. (of this page) Unclassified		21. No. of Pages 174	22. Price* \$8.00



