

SEPTEMBER 1982

LRP 213/82

A HIGH POWER D₂O LASER OPTIMIZED FOR
MICROSECOND PULSE DURATION

R. Behn, I. Kjelberg, P.D. Morgan,
T. Okada, and M.R. Siegrist

revised version: February 1983

A HIGH POWER D₂O LASER OPTIMIZED FOR MICROSECOND PULSE DURATION

R. Behn, I. Kjelberg, P.D. Morgan*, T. Okada⁺, and M.R. Siegrist

Centre de Recherches en Physique des Plasmas
Association Euratom - Confédération Suisse
Ecole Polytechnique Fédérale de Lausanne,
21, Av. des Bains, CH-1007 Lausanne, Switzerland,

ABSTRACT

A high power D₂O laser, pumped by a single mode CO₂ laser, has been optimized to produce 1 μsec pulses at 385 μm. Pump energies up to 100 J were available using an e-beam preionized CO₂ amplifier at 2 atm. FIR pulse energies of 140 mJ in multi-mode and 40 mJ in single mode operation have been obtained from a 4m unstable resonator. During parametric studies the influence of operating pressure, spatially inhomogeneous pump intensity, resonator feedback as well as saturation effects have been investigated.

Present address:

* JET Joint Undertaking, Abingdon, Oxfordshire OX14 3EA, Great Britain

+ Department of Energy Conversion, Graduate School of Engineering Sciences, Kyushu University, 33 Kasuga, Fukuoka 816, Japan

INTRODUCTION

We report results obtained with a high power D_2O laser emitting pulses of 1 μ sec duration at a wavelength of 385 μ m. Optically pumped with single mode CO_2 laser pulses of energy 100 J delivered in 1.2 μ sec, this system produces far infrared pulses through the stimulated Raman effect with an energy of up to 140 mJ. The system is being developed to satisfy the requirements of a Thomson scattering experiment with the aim of measuring the ion temperature of a Tokamak plasma. Earlier investigations proved that the D_2O laser is one of the most powerful sources of pulsed far infrared radiation and well suited for a scattering experiment.¹ More details about the various aspects of far infrared scattering diagnostics concerning both the laser and the detection system may be found elsewhere.^{2,3,4} While the power achieved still falls short of the required MW level, we have demonstrated that single mode pulses of 1 μ sec duration can be produced. This is essential for the planned scattering measurement since long pulse operation of the laser will improve the signal-to-noise ratio of the detected signal.

An extensive parametric study, varying gas pressure, resonator length, feedback and all pump beam parameters has allowed us to optimize this system and to obtain the information necessary for the scaling to higher powers. From experiments with different pump beam diameters we conclude that no saturation effects are to be expected when the pump beam energy is increased from 100 J to 500 J, by more efficient use of the e-beam preionized CO_2 laser used as final amplifier.

We have found good qualitative agreement between our measurements and the results obtained from a space and time resolved numerical

code. In particular, we have investigated the influence of a buffer gas on the so-called bottle-neck effect, which is due to the slow vibrational relaxation from the lower laser level in D_2O to the ground state. By adding SF_6 this relaxation rate increases, which leads to a considerable improvement in pumping efficiency at low D_2O pressure.

APPARATUS

The CO_2 laser system used to optically pump the D_2O laser consists of an oscillator, preamplifier and, as main amplifier, an e-beam controlled laser. This system is illustrated in Fig. 1. The oscillator of length 1.9 m incorporates a 60 cm long TEA gain section and a TE pulsed low pressure section operating at ~ 15 torr. The hemispheric resonator is formed by a plane grating (150 grooves per mm, blazed for $8 \mu m$) and a ZnSe meniscus output coupler of 5 m radius of curvature, coated to give a reflectivity of 75%. Apertures are used for transverse mode selection. Pulses of up to 1.6 μsec duration FWHM can be obtained by a judicious choice of the gas mix which is typically $CO_2:N_2:He=1:7:4$. All optical components, including the alignment system and the low pressure section, but not the pulsed TEA section, are mounted on an invar steel table from Newport Research Corporation inside a temperature stabilized enclosure. This guarantees excellent stability and reproducibility. After a double pass through the preamplifier, single mode pulses of energy 7J and duration up to 1.4 μsec are obtained. The pulse duration can be varied between 100 nsec and 1.5 μsec by changing the trigger delays between oscillator and preamplifier and by varying the composition of the gas mix.

The pulsed output is directed via a diffraction grating to decouple parasitic $10.6 \mu m$ emission into the main amplifier, an e-beam

preionized laser from RPC industries (Systems, Science and Software). This laser operates at a gas pressure of up to 3 atm and has a gain length of 2 m with a maximum beam cross-section of 16 cm. Ultimately it will be able to amplify, in a multi-pass configuration, pulses to an energy of 500 J, but for the experiments reported here only 100 J were obtained in a single pass through the amplifier at 9.25 μm .

To obtain a high gain on the 9R(22) line a CO_2 -rich gas mix is used viz $\text{He:N}_2:\text{CO}_2=1:1:4$. While it is no problem to obtain arc-free discharges at a pressure of 3 atm in a mixture which is 33% leaner in CO_2 , a tendency to arc is observed with this mix. The pressure was therefore lowered to 2.5 atm absolute. Single-mode pulses of 1.2 μsec duration are obtained with good reproducibility from this system.

The amplifier output is coupled into the FIR resonator tank through a KCl window of 16 cm diameter followed by a wire grid inclined at 45° and made of tungsten wires of diameter 10 μm spaced 100 μm apart. This system is illustrated in Fig. 2. The unstable telescopic resonator is L shaped, the grid being situated at the position of the elbow. The convex mirror which serves as output coupler is mounted at the far end of the long arm, in line with the CO_2 laser beam. The grid consisting of horizontal wires transmits 90% of the incident vertically polarized CO_2 laser radiation but is highly reflective ($R = 75\%$) to the FIR emission. In the short arm of the tank, the concave mirror is placed and forms the other end of the unstable resonator. All optical components are mounted inside the tank with mechanical adjustment from the outside. A glass tube of 20 cm diameter is used in the tank to guide the pump and FIR beams along the main arm of

the resonator. Its chief purpose is to collect CO₂ radiation which is diffracted away from the main axis by the grid.

For energy and pulse shape measurement the following equipment was used:

CO₂: a range of Gen-Tec energy meters for relative energy measurements and monitoring of the performance of the CO₂ laser chain. A Scientech type 38-0802 energy meter for precise energy measurements. This instrument accepts beam diameters up to 20 cm and energies up to 100 J.

Several Rofin photon drag detectors were available for pulse shape measurements.

FIR: A pyroelectric Laser Precision energy meter was used for energy measurements and a fast Molectron type P5-01 detector for the pulse shape. While the response time of this detector is sufficient for detection of the mode structure, its sensitivity is low. Hence we also used a Schottky diode, mounted in an edge reflector, and operated in video mode.

A Jarell-Ash grating spectrometer (1.6 grooves per mm) was used to resolve the FIR emission spectrum.

Pulse shapes were recorded on storage oscilloscopes with 400 MHz bandwidth or on a transient digitizer interfaced with a desk-top graphics system and a PDP 11/44 computer.

PRELIMINARY MEASUREMENTS

- a) The transmission of the wire grid was measured to be $T = 25\%$ for the polarization parallel to the wires of the grid (and hence perpendicular to the CO_2 beam) and $T \approx 90\%$ for the perpendicular polarization, at $\lambda = 385\mu\text{m}$. Assuming negligible mesh absorption and/or scattering the reflection for the "useful" polarization is thus 75%.

- b) With the aid of the monochromator and a Joule meter the intensity of the $359\mu\text{m}$ cascade line was established to be 9.5 times smaller than the $385\mu\text{m}$ line. No other line was sufficiently intense to produce a detectable signal.

- c) Both FIR lines are polarized perpendicularly to the CO_2 pump beam to better than 99%.

- d) The beam divergence of the FIR emission was measured with a liquid crystal camera. It was found to be of the order of 6 mrad.

- e) The conversion efficiency (ratio of FIR energy to CO_2 energy) was found to decrease by 20% by expanding the pulse length from 500 nsec to 1 μsec for constant pump energy. The results of this measurement are shown in Fig. 3. For our experimental system we conclude that long pulse operation, where the bottleneck effect is expected to play an important role, is not detrimental to the conversion efficiency.

COMPARISON OF UNSTABLE RESONATORS

Although the theoretical understanding of FIR lasers is well developed by now,^{5,6} the complexity of the pump mechanism and its influence on the intensity distribution in the resonator is such that it is difficult to predict accurately the optimum resonator configuration. Mirrors for a range of different resonators were therefore bought for experimental optimization (see Table I). Since only unstable resonators allow the efficient extraction of energy from a large volume of active medium, the mirrors were chosen to form telescopic confocal resonators of length 2,3 and 4m. The use of unstable resonators is commonplace for high power gas and solid state lasers in the infrared and visible parts of the spectrum.^{7,8} Their application at much longer wavelength with near-mm sources has been discussed recently.⁹ Here, the concept is applied to the FIR region with the expectation that the demonstrated advantages of unstable resonators at shorter wavelengths, such as large mode volume, excellent transverse mode control and efficient energy extraction will prove to be equally important.

According to geometrical optics laws the output of a telescopic confocal unstable resonator, viz. the radiation escaping around the edges of the convex mirror has a flat, ring-shaped intensity profile. To optimize transverse mode selection, the equivalent Fresnel number $N_{eq} = d^2/(4\lambda R)$ (d , R = diameter, radius of curvature of the convex mirror) was chosen to be 1/2 for all possible resonator configurations.¹⁰ The magnification M , which is the ratio of the mirror curvatures, defines the resonator feedback $T = 1/M^2$. However, this is only true as long as diffraction effects are neglected. At the wavelength of 385 μm diffraction effects are quite important. We calculated the

effective resonator feedback for the case of a nominal feedback of 5% by means of a beam transport code¹¹ and found an actual feedback of 18% for the case of an empty resonator. If the resonator contains a saturable gain medium with either a flat-topped or gaussian radial gain profile, the feedback values cover the range from 10 to almost 30% for conditions representative of our experimental situation. The cavity feedback is therefore a dynamical variable during the laser pulse.

Pressure scans for 5 different resonator configurations are shown in Fig. 4. In early measurements we relied on the efficient absorption of the CO₂ beam in the D₂O vapour to decouple the convex mirror of the FIR resonator from the CO₂ oscillator. However, this was found to be insufficient. Below a certain pressure value a deep modulation appeared in the pump pulse shape with a period corresponding to the roundtrip time from the CO₂ oscillator through the whole amplifier chain to the convex mirror of the FIR resonator and back; a distance of ~ 30m one way. Thin TPX sheets in front of the convex mirror served to decouple it from the CO₂ system but had an unfavorable effect on the FIR cavity by introducing significant losses. A TPX sheet cut to intercept only that part of the beam incident on the mirror and mounted at the Brewster angle solved the problem.

The pump beam parameters for the pressure scans shown in Fig. 4 were the following: 100 J in 1.2 μ sec FWHM in a beam of diameter 11 cm. Three of the scans shown were recorded without the TPX sheet and hence do not extend into the low pressure region. However, the information available is sufficient to draw conclusions.

The highest output energy is obtained with the longest resonator and amongst all 4m resonators investigated it is the one with the

smallest feedback which produced the best results. The optimal feedback is probably even lower than 5% but this could not be investigated because the appropriate mirrors were not available. The optimum pressure is higher for shorter resonators which reflects the fact that a higher vapor pressure is needed to absorb the same pump energy in a shorter distance.

These results cannot necessarily be applied readily to other systems. An important parameter is, for example, the diameter of the pump beam which was, in our case, smaller than the diameter of the cavity mode. This has an influence on the mode structure and hence also on the degree of output coupling. Also the degree of pump and FIR saturation reached is important. This depends on the local intensities of both beams and hence on the complex mode structure. However, effects like these should not significantly alter the main conclusions drawn above.

ABSORPTION OF PUMP BEAM

In order to measure the absorption of the CO_2 pump beam a Gen-Tec energy meter was mounted inside the FIR tank at the position of the convex mirror which was removed in this case. A KCl plate in front of the energy meter guaranteed that no FIR radiation was detected. Another, similar detector was aligned to record the fraction of CO_2 radiation reflected from the KCl input window. After cross-calibration of the two meters with the tube evacuated, the ratio of their readings directly yielded the transmission of pump radiation through the tube. For two different propagation distances we show in Fig. 5 the measured absorption as function of D_2O pressure. Comparison with Fig. 4 shows that the optimum pressure corresponds to the case where practically all the incident radiation has been absorbed efficiently without, how-

ever, being dumped into only a short section of the resonator, as is the case at higher pressure where the absorption is too strong.

SINGLE MODE OPERATION

An essential condition for single longitudinal mode operation is a single mode pump beam. This can be reliably achieved with our CO₂ pump system. However, it is not sufficient to guarantee single-mode FIR operation. In fact, this is quite difficult to achieve with the present set-up which does not include any frequency selective element to suppress unwanted longitudinal modes. Independent of the resonator configuration, the only way to achieve single mode operation was to operate at a D₂O pressure of > 6 torr. Since this is considerably beyond the optimum pressure the maximum energy obtained in a single mode was only about 30% of the maximum multimode energy. In Fig. 6, we show a typical single and multimode FIR pulse shape, recorded with the Schottky diode, together with the pump pulse shape.

It seems surprising that single mode operation is obtained at high pressures. A narrow linewidth favorable to single mode operation is expected at low pressures where pressure broadening has little effect. While there is a range of possible arguments to support the experimental observations, it is not easy to estimate the qualitative importance of an effect. The reason is that existing theories applicable to optically-pumped FIR lasers assume single mode operation and cannot be used to investigate mode competition. A reasonable explanation proposed by Peebles et al.² is the following: At high pressures the FIR lasing medium is homogeneously broadened hence a dominant mode can extract energy from the full width of the profile, thus suppressing the growth of other modes. As the pressure is lowered, the mechanisms leading to inhomogeneous broadening, like the Doppler effect,

become significant. In this case, the possibility of multi-longitudinal mode operation is increased since each mode interacts with a different class of molecules and therefore is decoupled from its neighbors. Of course, the gain is also smaller at higher pressures so that fewer modes reach the threshold condition for lasing.

The results from all the experiments performed with the present set-up suggest that the maximum possible output energy in a single mode cannot be achieved without any frequency-selective elements in the resonator.

We noted that the output energy and the pulse shape envelope (where the mode beating is not resolved) are fairly similar for multi-mode or single mode operation. Hence for many of the results reported (pressure scans etc.) the mode structure was not recorded and could have been either single or multi-mode.

SATURATION, VOLUME REQUIREMENTS

As mentioned earlier, an FIR energy of 1 J in 1 μ sec is required for an ion temperature measurement in a Tokamak. With our system we achieve the pulse duration required, but the maximum energy measured is a factor of 7 short of this goal. At energies exceeding 30-40 mJ, the laser emits several modes, but according to our experience this is not an important drawback. Suitable mode-selective methods which do not introduce significant losses, such as coupled resonators, intracavity etalons, or ring lasers will enforce single-mode operation without significant reduction in output energy.

We expect a factor of 5 increase in pump energy by multipassing the electron-beam-preionized main amplifier. If saturation effects do not change the linear relationship between pump energy and FIR energy, over 700 mJ can be expected. Saturation effects are intensity dependent. The main limitation is expected to be the bottle-neck effect which is due to slow vibrational relaxation from the lower FIR laser level to the ground state. We studied saturation effects by decreasing the pump beam diameter and hence increasing the pump intensity. This was achieved by shortening the distance between the main CO₂ amplifier and the D₂O tank. The diameter of the CO₂ beam could be reduced to 9 cm. The FIR beam diameter tended to follow the pump beam and hence was of comparable size.

In Fig. 7 we show the FIR output energy as function of pump energy for two vapor pressures, 2 and 5 torr. Over the range of measurement no deviation from linearity is observed at 5 torr, but at the optimum pressure of 2 torr, saturation effects manifest themselves from about 60 J of pump energy onwards. However, the flattening of the curve is slow so that an increase to 100 J of pump energy is still reasonable. If the full diameter of 20 cm, instead of 9 cm, could be pumped with the same intensity, the total pump energy dumped into the laser cavity would be a factor of 5 larger. This corresponds to the increase expected from the CO₂ laser system by using it more efficiently. It is, therefore, reasonable to expect that our D₂O laser can produce 700 mJ in its present form. Modifications are necessary to enforce single mode operation. This will be studied in the near future. We believe that energies approaching 1 J can be obtained by reducing several important loss mechanisms. Depending on the pressure up to 50%

of the available pump energy is at present absorbed in the 35 cm long section between the window of the tank and the grid. This section does not form part of the FIR resonator and energy dumped into it is wasted. Significant losses are also due to the TPX exit window of the tank. This has at present a useful diameter of 16 cm and is 7.9 mm thick. The use of a telescopic mirror system inside the tank to reduce the diameter of the output beam would allow us to use a quartz window cut to form a Fabry-Perot etalon and hence to maximize transmission.

TEMPORAL PULSE SHAPE

The temporal pulse shape in an optically-pumped FIR laser is influenced in a complex way by a multitude of different effects. The instantaneous gain at a particular point is a function of the local FIR and pump intensities and depends, through different population densities, on the time history. If cascade and refill transitions are neglected, the molecular system can be described by the population densities of 5 different levels, viz the lower levels of the FIR and the pump transition and the common upper level as well as the ground and excited vibrational levels. The two latter ones are actually manifolds, each containing several rotational sublevels, but since equipartition can be assumed for all rotational sublevels except those affected by the optical transitions considered, a population density can be assigned to each of the two vibrational levels. All collisional processes can then be described by two relaxation time constants: τ_R which is characteristic of the time it takes to re-establish equilibrium amongst rotational levels and τ_V which governs the de-excita-

tion of the excited vibrational manifold. With the first one being of the order of 10 nsec, rotational equilibration is maintained during a long pulse except during the rapidly rising leading edge. The same is not true for the vibrational relaxation which is of the order of 1 μ sec. An intense pump pulse can result in a quenching of FIR laser action due to depletion of the ground vibrational state: the so-called bottleneck effect. This is illustrated with three measured pulse shapes in Fig. 6. For similar pump parameters the traces show the observed FIR output at three different pressures. Taking into account the inverse linear relationship between τ_V and pressure the results can be explained qualitatively in the following way: at a high pressure (7 torr) the vibrational relaxation is fast, hence the bottleneck effect is of little importance. The FIR pulse will more or less follow the pump pulse, as observed. Since the pump radiation is efficiently absorbed near the entrance side, the resonator is pumped very non-uniformly, resulting in a relatively small ratio of roundtrip gain to roundtrip loss (the gain in the short pumped section has to compensate the distributed losses of the whole resonator). Thus, FIR laser action stops abruptly when the pump power drops below threshold.

At the low pressure of 2 torr the bottle-neck effect is important. The FIR laser intensity decreases when the ground level is depleted. However, the laser action continues at a reduced level governed by the vibrational de-excitation rate, as long as the pump power remains above threshold. Since the resonator is pumped fairly uniformly in this case, the ratio of roundtrip gain to roundtrip loss is high and the laser action continues for quite a long time: almost twice as long as in the case of 7 torr.

An interesting feature is also the delayed onset at higher pressures. This is mainly due to absorption in the 35 cm long section between the entrance window and the resonator grid. This section does not form part of the resonator but contains D_2O and thus absorbs pump radiation. At a high vapor pressure this absorption is quite large until bleaching has occurred through saturation and/or bottle-necking. The threshold condition in the resonator is thus reached with some delay.

With each measured trace in Fig. 6 we show the result of a numerical computation according to Ref. 12, simulating the experimental conditions. For reasons which are not fully explained as yet, this code does not correctly predict the observed intensity levels. The results were, therefore, scaled to match the observed intensity peaks, individually for each trace. It is remarkable how well the computed pulse shapes fit the observations. Specifically the delayed onset at the high pressure and the tail due to bottle-necking are predicted correctly.

BUFFER GAS

The aim of using a buffer gas is to shorten the vibrational decay time of the D_2O molecule to reduce the undesirable bottleneck effect. An ideal buffer gas should influence τ_V but not τ_R and absorb neither the pump nor the FIR radiation. For the very preliminary experiments reported here no detailed spectral investigations were performed to select a suitable buffer gas.

At first several gases were tried, for which data are already available:¹³ N₂, CO₂, He and air. All of them gave negative results. With SF₆, however, we obtained the encouraging results shown in Fig. 8. For a D₂O pressure of 3 torr which is somewhat below the optimum pressure we obtained a 75% increase in output energy by adding 12 torr of SF₆. However, at 5 torr of D₂O, which is close to the optimum pressure, no positive effect could be observed when SF₆ was added. In fact it was not possible to improve the output energy with SF₆ beyond the maximum obtained under optimal conditions, using D₂O only.

We ascribe the effect of SF₆ to a transition in coincidence with the vibrational transition in D₂O.

While these preliminary measurements are encouraging, a far more detailed investigation is required to find a more efficient buffer gas. However, first of all it should be established theoretically that an "ideal" buffer gas, if it existed, could indeed enhance the performance of an otherwise already optimized D₂O laser. It is conceivable that a buffer gas, although not necessarily improving the efficiency of a D₂O laser, might reduce the volume requirement. Since the cost of optical elements (windows, grids and mirrors) with diameters exceeding 20 cm becomes prohibitive, this would be very beneficial indeed. Calculations indicate that even with the non-ideal buffer gas SF₆ the cross-sectional area of a D₂O laser can be reduced by half, without loss of output energy. However, this has yet to be confirmed by experiment.

CONCLUSIONS

Pumping a D₂O laser in an unstable resonator configuration with single mode pulses of 1.2 μsec from a CO₂ laser system, FIR laser emission at 385 μm with pulse duration of 1 μsec has been produced. Long pulse operation is an essential step towards a D₂O laser system suitable for a Thomson scattering measurement in a Tokamak plasma to determine the ion temperature. The experimental studies, backed by numerical calculations, showed the influence of a number of design parameters on the laser performance.

With regard to the specifications set by the application envisaged, a considerable improvement in output energy is still required. From an extrapolation of the results presented here, an increase by a factor of 5 in FIR energy is expected when the e-beam CO₂ amplifier is used more efficiently in a multi-pass configuration. At present, single mode operation of the FIR laser could only be maintained at high D₂O pressures inconsistent with maximum output energy. A future system, therefore, would have to include additional means for longitudinal mode selection like coupled resonators or an intracavity etalon.

A serious limitation in pumping efficiency is set by the vibrational relaxation process in D₂O. First results using SF₆ confirmed that the relaxation rate can be increased by adding a suitable buffer gas. Further investigation will be required to find a buffer gas which also leads to an overall improvement in output energy.

ACKNOWLEDGMENTS

This work has been supported by the Ecole Polytechnique Fédérale de Lausanne, the Swiss National Science Foundation and by Euratom. The authors gratefully acknowledge valuable discussions with H. Van den Bergh on the effect of buffer gases.

REFERENCES

- ¹ P.D. Morgan, M.R. Green, M.R. Siegrist, R.L. Watterson, Comments Plasma Phys. Cont. Fusion 5, 141-158 (1979).
- ² W.A. Peebles, D. Umstadter, D.L. Brower, N.C. Luhmann, Appl. Phys. Lett. 38, 851-853 (1981).
- ³ P. Woskoboinikow, W.J. Mulligan, R. Erickson, D.R. Cohn, R.J. Temkin, Bulletin Am. Phys. Soc. 27, 1099-1099 (1982).
- ⁴ L.E. Sharp, A.D. Sanderson, D.E. Evans, Plasma Physics 23, 357-370 (1981).
- ⁵ R.L. Panock and R.J. Temkin, IEEE J. Quantum Electron., QE-13, 425-434 (1977).
- ⁶ T.A. DeTemple, Infrared and Millimeter Waves (edited by K.J. Button), Vol. 1, Ch. 3, Academic Press, New York, (1979).
- ⁷ A.E. Siegman, Laser Focus (May 1971), 42-47.
- ⁸ A.E. Siegman, Appl. Opt. 13, 353-367 (1974).
- ⁹ C.S. Willett, Int. J. of Infrared and Millimeter Waves 2, 605-627 (1981).
- ¹⁰ P.F. Kellen and M. Smith, Opt. Engineering 18, 157-160 (1979).

References (cont'd)

- ¹¹ M.R. Siegrist, M.R. Green, P.D. Morgan, and R.L. Watterson, Appl. Optics 19, 3824-3829 (1980).
- ¹² T. Okada, R. Behn, M.A. Dupertuis, P.D. Morgan, and M.R. Siegrist, LRP 211/82, Numerical Analysis of an optically-pumped D₂O FIR laser
- ¹³ R.L. Sheffield, K. Boyer, A. Javan, Opt. Letters 5, 10-11 (1980).

FIGURE CAPTIONS

Fig. 1: The CO₂ pump laser system. A_i are apertures, G_i gratings and M_i mirrors.

Fig. 2: The FIR laser consisting of a folded unstable telescopic resonator inside a tank containing D₂O vapor. The pump beam enters through a wire grid inclined at 45°.

Fig. 3: Conversion efficiency as function of pump pulse duration. Each data point is one measurement. The CO₂ energy was constant to within 10 %.

Fig. 4: FIR output energy as function of D₂O pressure for various resonator configurations. (Data points are averages of ~3 to 5 measurements).

Fig. 5: Transmission of pump radiation as function of D₂O pressure for 2 cell lengths.

Fig. 6a: Oscilloscope trace of a typical pump pulse shape (500 nsec/div).

Fig. 6b: Comparison of experimental and theoretical pulse shapes for three different D₂O pressures. Single mode operation is observed at 7 torr.

Figure Captions (cont'd)

Fig. 7: FIR output energy as function of pump energy density for two vapor pressures.

Fig. 8: The influence of the buffer gas SF₆ (2 m resonator length, 10% feedback).

Table I

The range of mirrors available to form unstable telescopic resonators

concave mirror		convex mirror		resonator length (m)	feedback (%)	magnification
diameter (cm)	curvature (cm)	diameter (cm)	curvature (cm)			
15	585	3.8	185	2 *	10	3.2
15	878	4.6	278	3 *	10	3.2
20	2049	10.6	1449	3	50	1.4
20	1030	4.2	230	4 *	5	4.5
20	1170	5.3	370	4	10	3.2
20	1447	7.1	647	4 *	20	2.2
20	1769	8.6	969	4	30	1.8
20	2177	10.3	1377	4 *	40	1.6
20	2731	12.2	1931	4	50	1.4

N_{eq} is 0.5 in all cases.

Results are reported for the resonators marked with *.

CO₂ TEA preamplifier

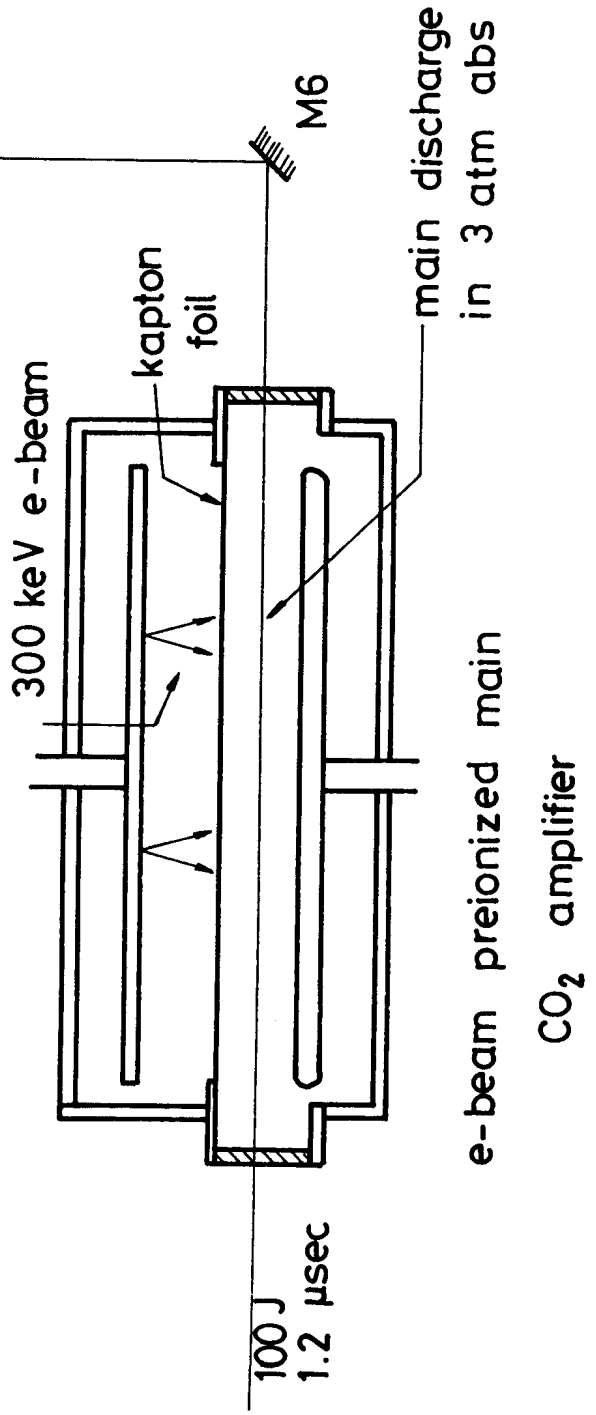
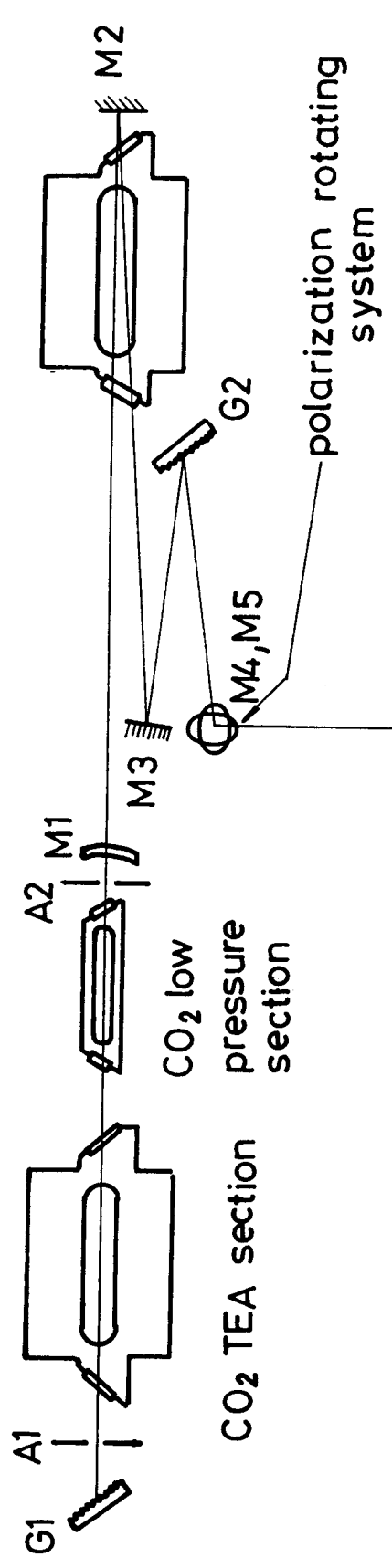

FIG. 1

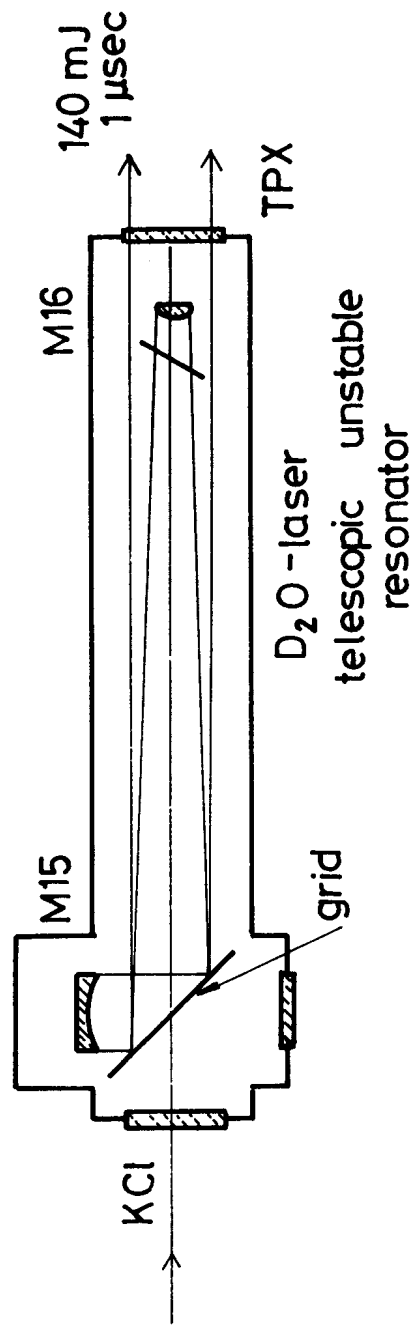

FIG. 2

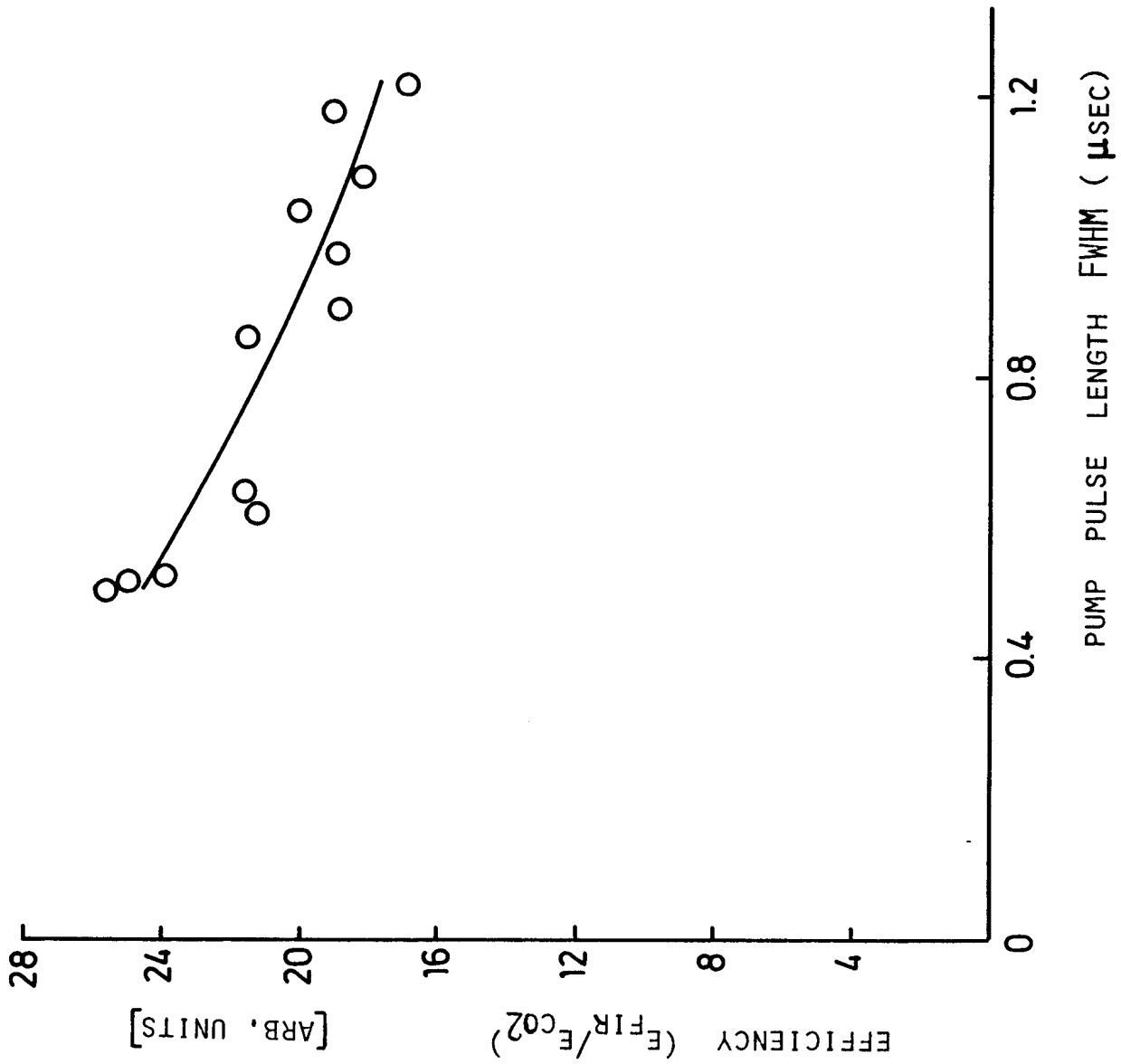
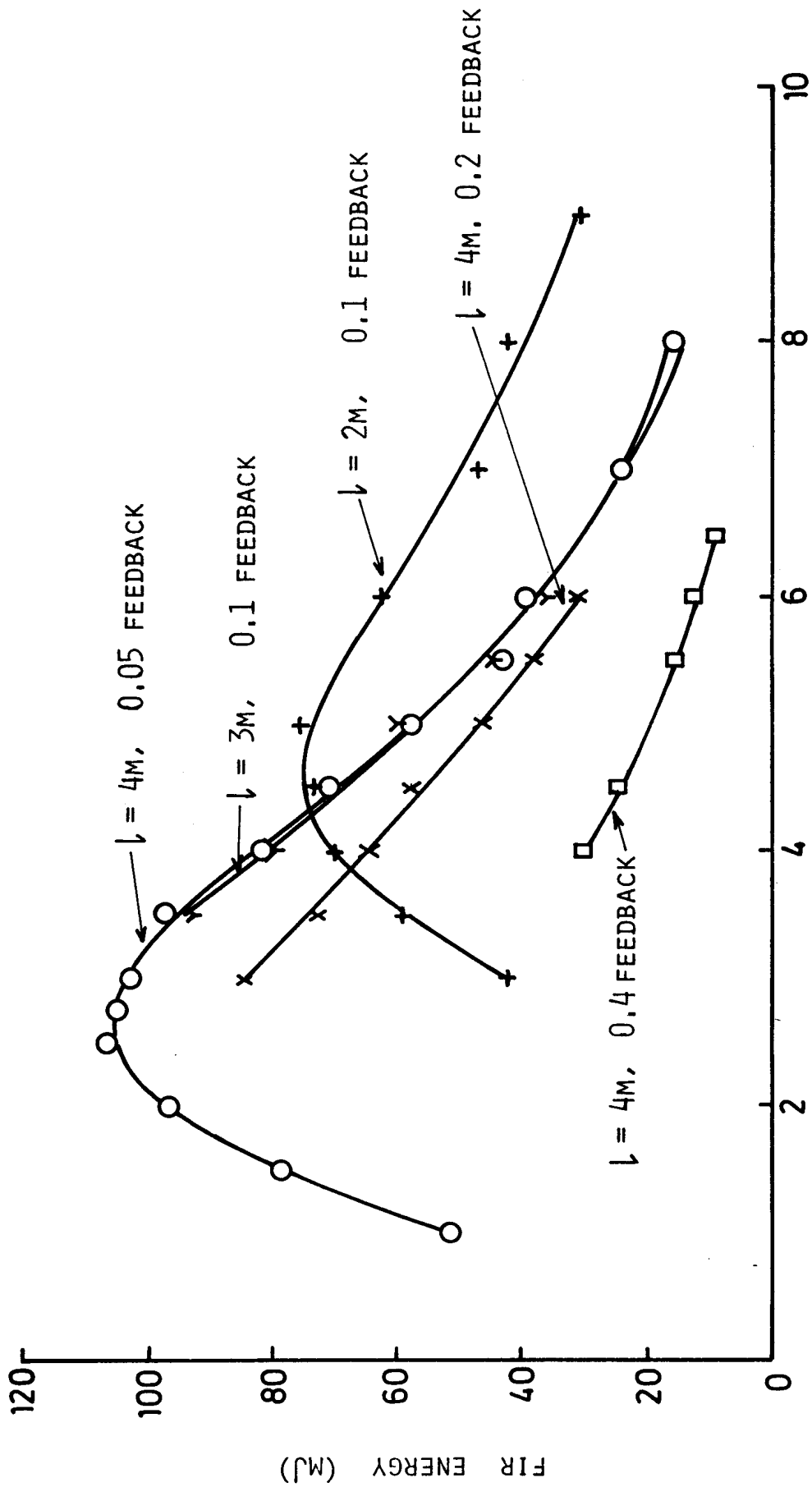

FIG. 3



D₂O PRESSURE (TORR)

FIG. 4

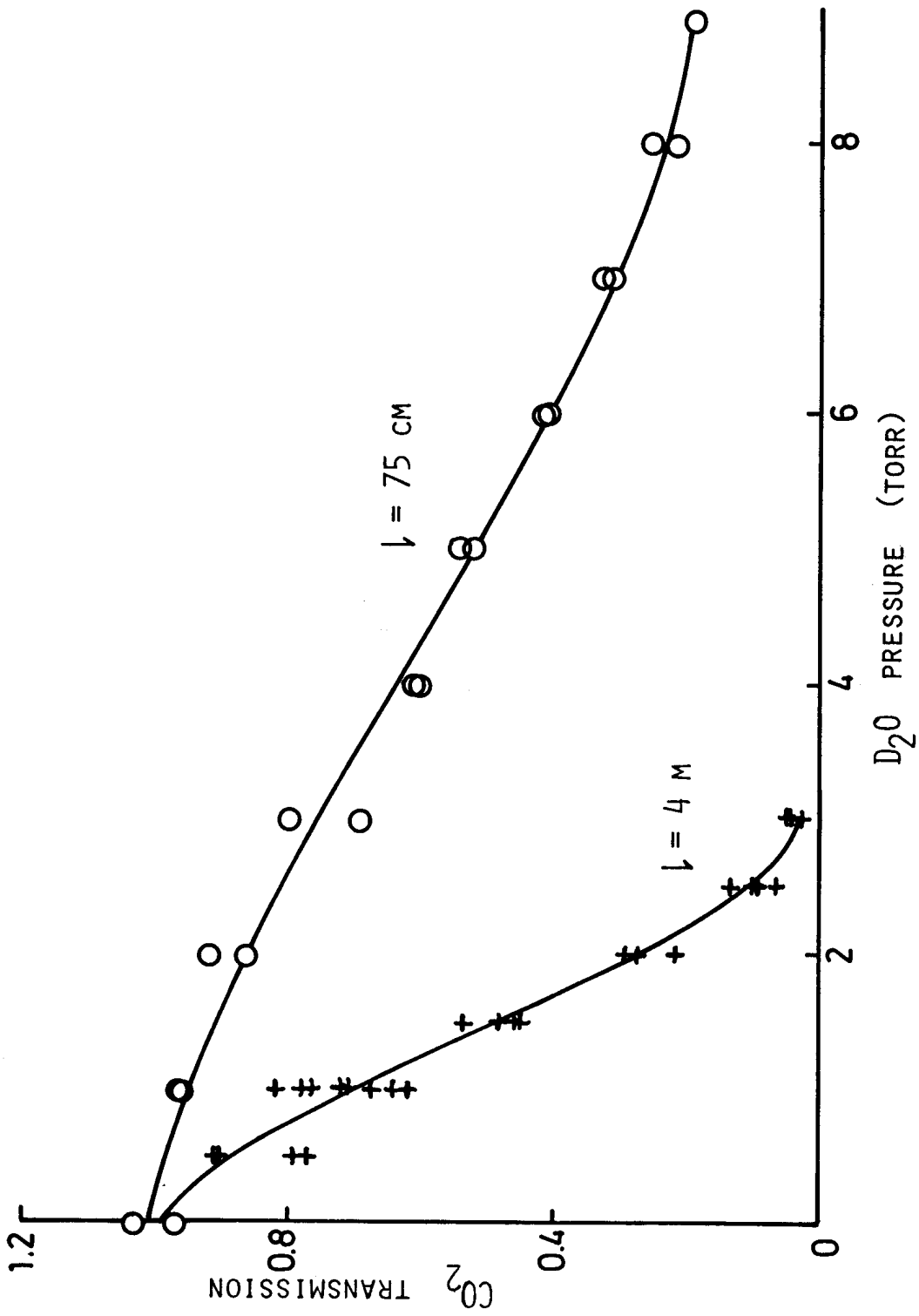

FIG. 5

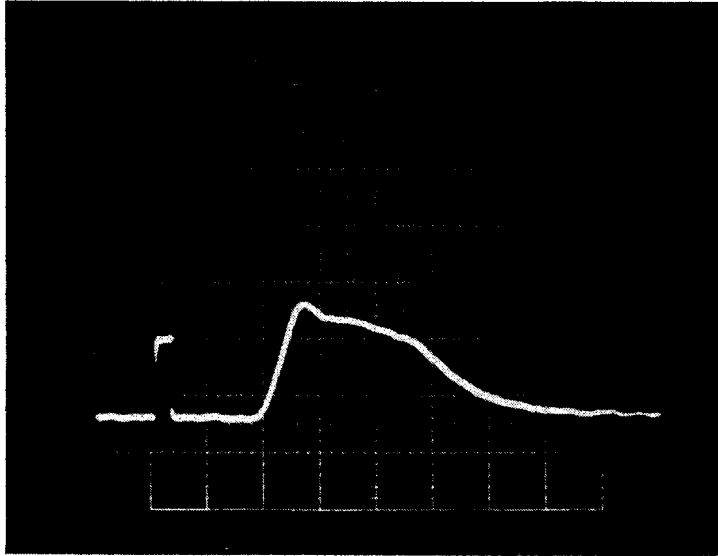

FIG. 6A

TIME SCALE : 500 NSEC / DIV.

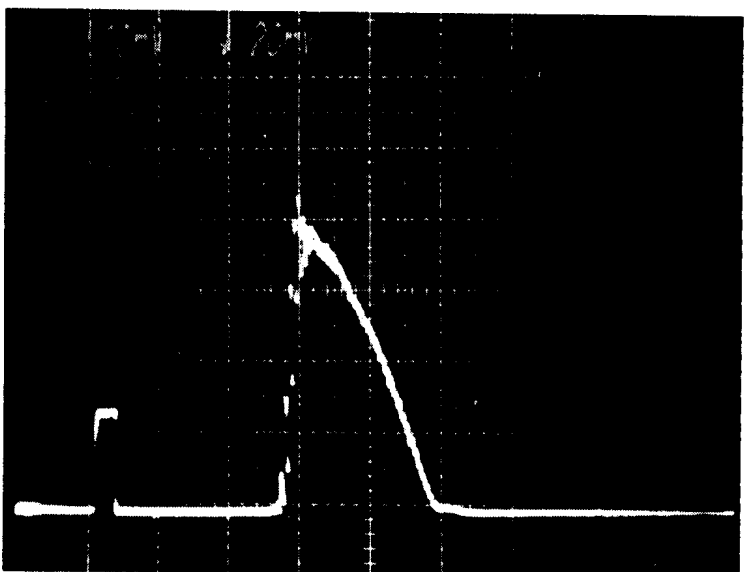
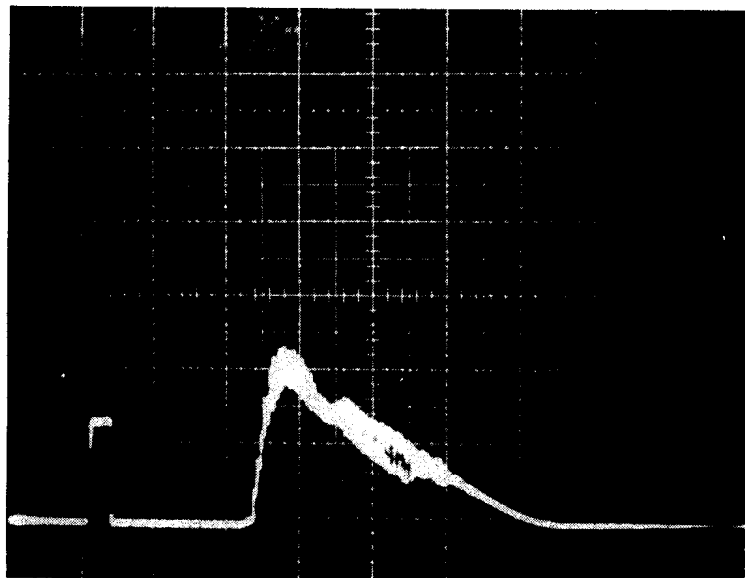
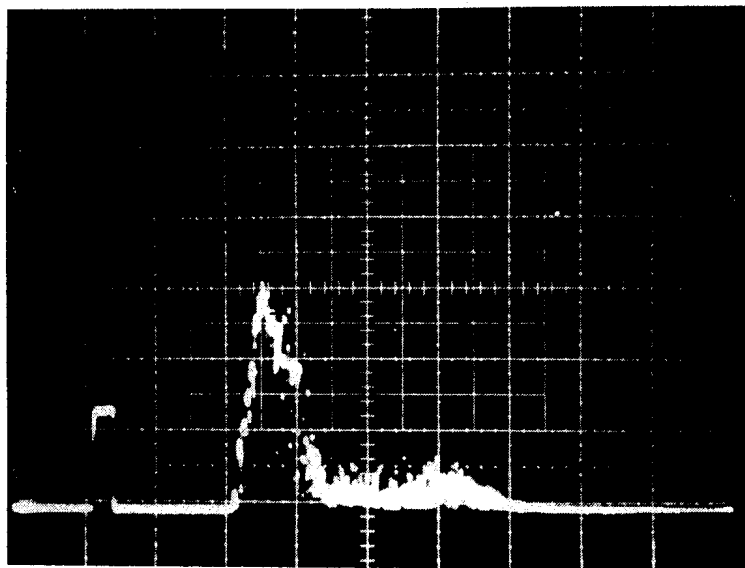
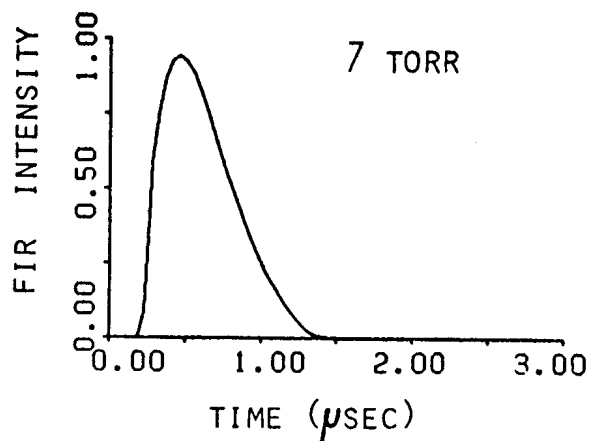
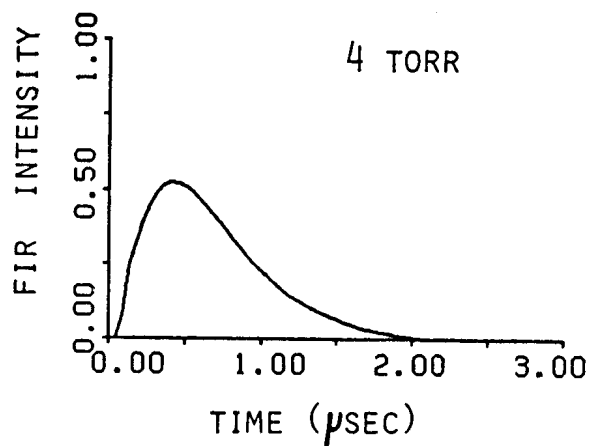
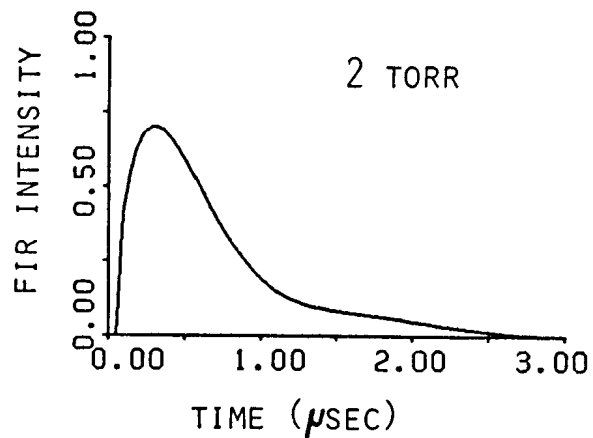
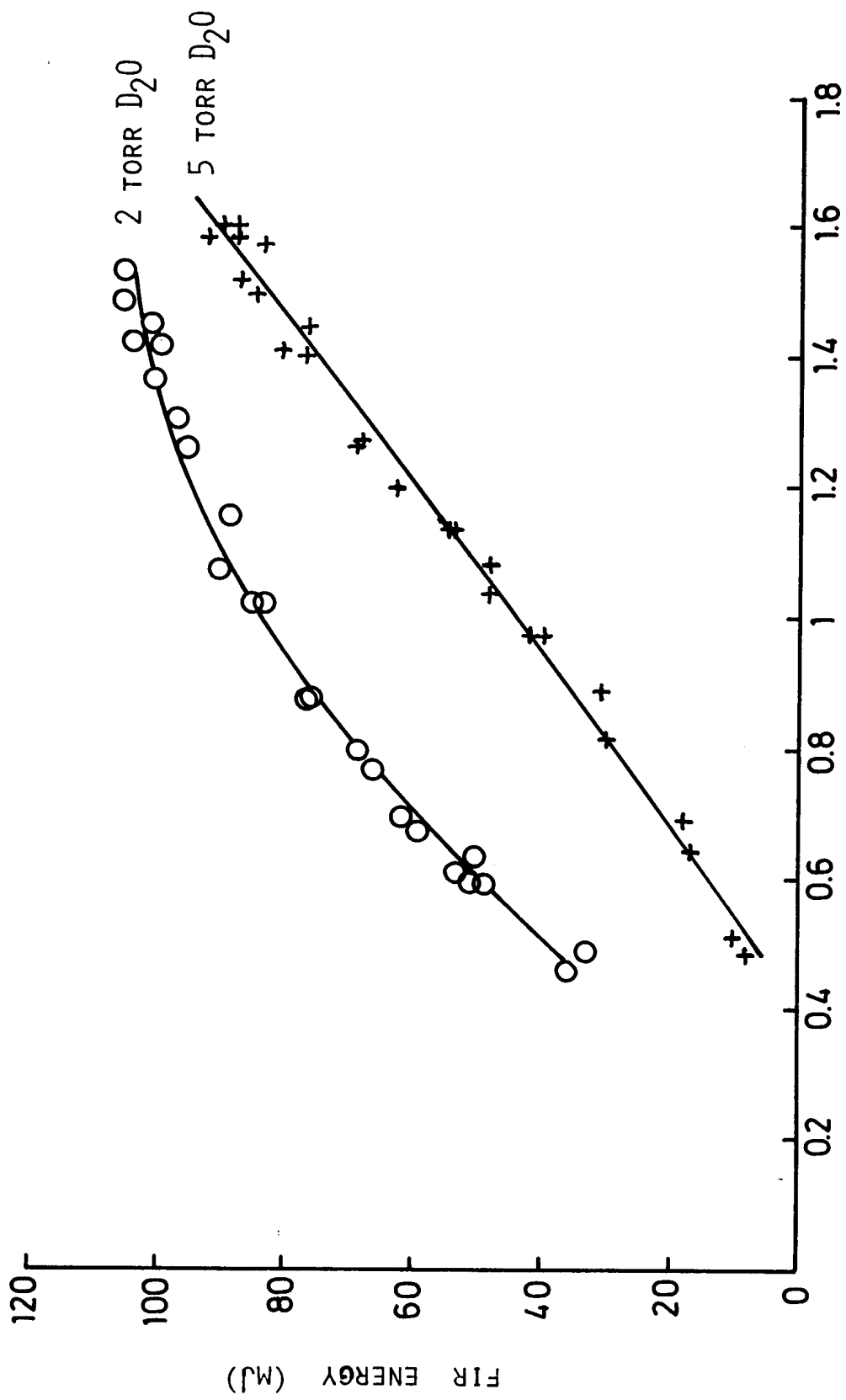

FIG. 6B

VERTICAL SCALES ADJUSTED
TO MATCH THE PHOTOS



PUMP BEAM DIAMETER 9 CM



PUMP ENERGY DENSITY (J/cm²)

FIG. 7

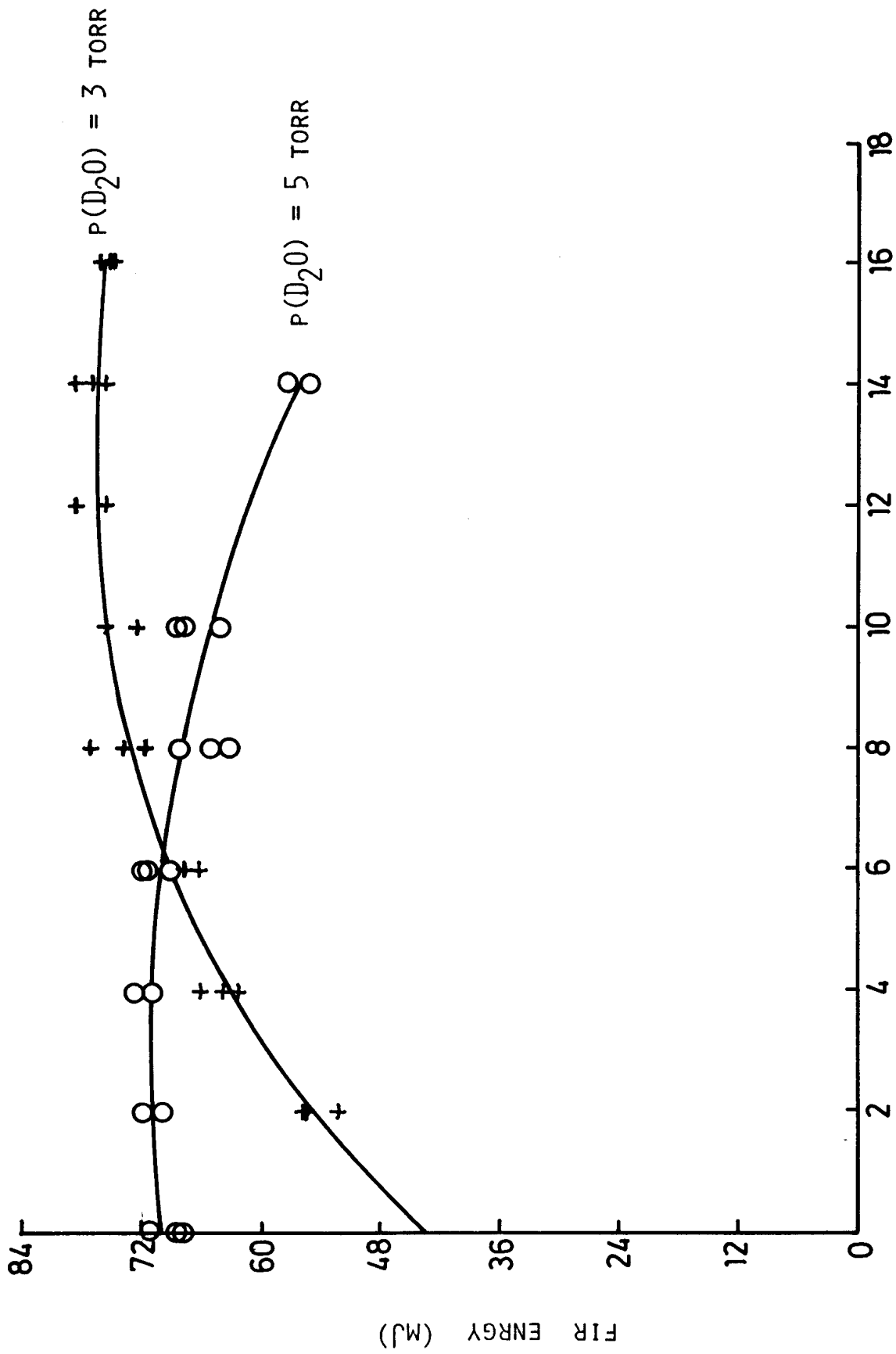

SF₆ PRESSURE (TORR)

FIG. 8