

A lead-free piezoelectric transformer in radial vibration modes

Mingsen Guo^{a)}

Department of Applied Physics, The Hong Kong Polytechnic University, Hunghom, Kowloon, Hong Kong, China; Materials Research Center, The Hong Kong Polytechnic University, Hunghom, Kowloon, Hong Kong, China; and Department of Physics, Wuhan University, Wuhan 430072, China

D. M. Lin, K. H. Lam, S. Wang, and Helen L. W. Chan

Department of Applied Physics, The Hong Kong Polytechnic University, Hunghom, Kowloon, Hong Kong, China and Materials Research Center, The Hong Kong Polytechnic University, Hunghom, Kowloon, Hong Kong, China

X. Z. Zhao

Department of Physics, Wuhan University, Wuhan 430072, China

(Received 11 October 2006; accepted 4 February 2007; published online 9 March 2007)

In this study, a disk-shaped piezoelectric transformer was fabricated using lead-free (K,Na)NbO₃-based ceramics with high mechanical quality factor. The transformer can operate in the fundamental or the third radial vibration mode. The transformer is poled along the thickness direction. The top surface is covered by ring/dot silver electrodes separated by an annular gap which serve as the input and output parts of the transformer, respectively. The bottom surface, fully covered with a silver electrode, is grounded as a common electrode. The dimensions of the top ring/dot electrodes are designed such that the third radial vibration mode can be strongly excited. The electrical properties of the transformer with diameter of 34.2 mm and thickness of 1.9 mm were measured. For a temperature rise of 35 °C, the transformer has a maximum output power of 12 W. With the matching load, its maximum efficiency is >95%, and maximum voltage gains are 6.5 and 3.9 for the fundamental and the third radial vibration modes, respectively. It has potential to be used in power supply units and other electronic circuits. © 2007 American Institute of Physics. [DOI: 10.1063/1.2712795]

I. INTRODUCTION

A piezoelectric transformer is a device that transforms an ac voltage or current by piezoelectric vibration. Compared with an electromagnetic transformer, it has the following favorable characteristics: (a) since it has a large power to volume ratio, it is easy to be miniaturized; (b) since piezoelectric vibration is involved instead of an electromagnetic field, it is electromagnetic-noise-free; (c) it is nonflammable because it has no windings; and (d) it can work at a higher frequency. Since the invention of Rosen-type transformer,¹ many piezoelectric transformers have been proposed and developed,²⁻⁹ and some of them have been used in practice. In general, piezoelectric transformers can be classified into two types. One type has a voltage gain (=ratio of output voltage to input voltage) of >1 (step-up transformers) with a high output voltage of more than several hundred volts. The other type has a voltage gain of <1 (step-down transformers) with a low output voltage of several volts. The former can be used in cold cathode fluorescent lamp (CCFL) inverters for liquid crystal displays (LCD),² and the latter can be used in the adapters for power supply units.⁴

Initially, the piezoelectric transformer technology suffered from serious instabilities and device failures related to immature material fabrication technology and mechanical re-

liability problems in the nodal point, as well as driving circuits. These drawbacks have subsequently been fully addressed through improvements in materials, new designs of structure, and self-tracking feedback circuits and resonant converters.^{10,11} In spite of the introduced modifications, piezoelectric transformers still suffer from a few drawbacks. First, the difference in polarization directions of input and output sections of a piezoelectric transformer may cause internal cracks during the electric poling process. The samples

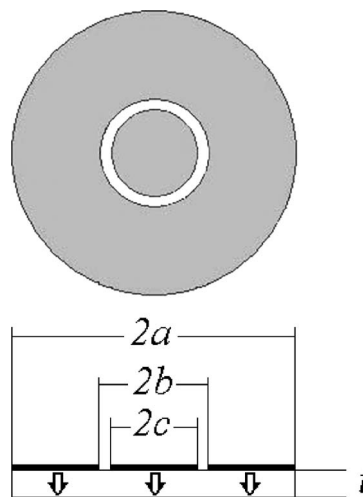

FIG. 1. Schematic diagram of piezoelectric transformer.

^{a)} Author to whom correspondence should be addressed; electronic mail: gmsone_cn@hotmail.com

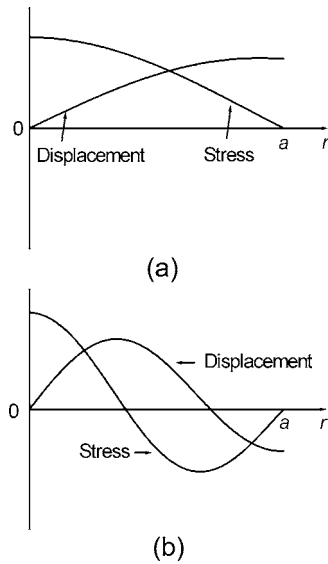

FIG. 2. The radial displacement and stress profiles of the piezoelectric transformer operating in (a) the fundamental radial vibration mode and (b) the third radial vibration mode.

would break down easily because of the premature mechanical fatigue during operation. The second issue is the enhancement of the power capabilities of piezoelectric transformers.

Recently, a piezoelectric transformer with a very simple structure was introduced to solve these problems.^{12–15} In this design, the input and output electrodes were on the same side of the piezoelectric ceramic disk and were isolated from each other by a fixed gap. The electrode pattern was a ring/dot structure, and the input and output sections were polarized along the thickness direction, such that the piezoelectric transformer used radial mode for input and output parts. Higher energy conversion efficiency and output power can be obtained from this structure because the electromechanical coupling factor k_p in planar mode is higher than the factor k_{31} in length extensional mode. This piezoelectric transformer can operate in radial vibration modes. In this article, a lead-free piezoelectric transformer which can operate in the fundamental and the third radial vibration modes was presented.

As known, $\text{Pb}(\text{Zr},\text{Ti})\text{O}_3$ (PZT) ceramics play a dominant role in current piezoelectric applications because of their superior piezoelectric properties. However, the high volatilization of PbO , a main component of PZT ceramics,

TABLE I. Properties of the KNN ceramics.

Density ρ ($\times 10^3$ kg/m ³)	4.65
Q_m	1500
$\varepsilon_{33}^T/\varepsilon_0$ at 1 kHz	300
$\text{tg } \delta$ at 1 kHz	0.003
k_p	0.40
k_{31}	0.24
d_{33} ($\times 10^{-12}$ m/V)	90
d_{31} ($\times 10^{-12}$ m/V)	-33
Poisson's ratio σ	0.27
s_{11}^E ($\times 10^{-12}$ m ² /N)	6.91

TABLE II. Dimensional specifications of the KNN piezoelectric transformer.

$2a$ (mm)	$2b$ (mm)	$2c$ (mm)	t (mm)
34.2	13.5	11	1.9

means that the substantial environmental pollution occurs during disposal of PbO -contaminated materials. As important ecomaterials, lead-free piezoelectric ceramics, especially $(\text{K},\text{Na})\text{NbO}_3$ -based ceramics, are attracting considerable attention.¹⁶ Therefore, the lead-free $(\text{K},\text{Na})\text{NbO}_3$ -based ceramics was developed for the application of the piezoelectric transformer.

II. CONSTRUCTION AND PRINCIPLE

Figure 1 illustrates the prototype of the disk-shaped piezoelectric transformer. Arrows indicate the direction of the polarization of the samples. The input and output electrodes are concentrically placed on the top surface of the ceramic. The outer ring is the input electrode while the inner dot is the output electrode. The bottom electrode, ground electrode, is common to both the input and output sections that is extended to the whole bottom area of the disk. This transformer operates in the fundamental radial vibration mode or the third radial vibration mode. The radial displacement and radial stress as a function of position along the radial direction of the disk are schematically shown in Fig. 2. For operating in the third radial vibration mode, the annular gap should be located at the position where the stress is the minimum.^{7,12,17,18} It is desirable to have the distance from the center of the disk to the annular gap equal to about 0.4 times of the radius of the disk. The lead wires of the input and output parts are soldered at the center of the internal electrode dot and the middle of the external electrode ring.

When an ac voltage with a frequency close to the fundamental or the third radial vibration resonance is applied to the input part of the transformer, the corresponding vibration mode is excited by the converse piezoelectric effect. With respect to the output part, an ac voltage is generated by the direct piezoelectric effect.

III. EXPERIMENTAL PROCEDURES

The piezoelectric transformer was fabricated using lead-free $(\text{K},\text{Na})\text{NbO}_3$ -based (abbreviated as KNN) ceramics which were made by the traditional ceramic processing. The key properties of the KNN ceramics are shown in Table I. Fired-on silver slurry was used for the electrode. The sample was poled across the thickness under a dc electric field of 4 kV/mm for 30 min in silicone oil at 150 °C. Table II

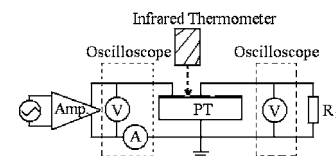

FIG. 3. Experimental setup for measuring the characteristics of the piezoelectric transformer.

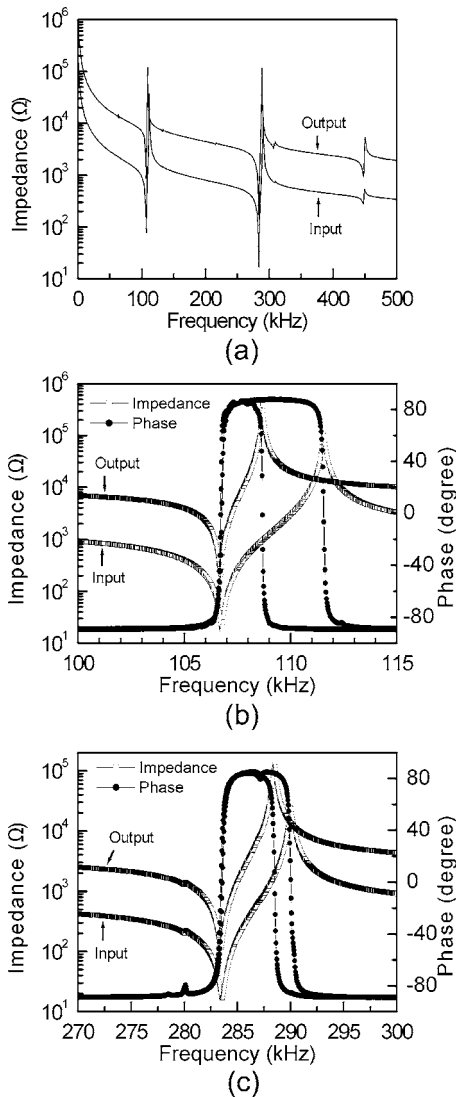

FIG. 4. The impedance spectra of the input and output parts of the KNN piezoelectric transformer with the frequency range (a) of 1–500 kHz, (b) near the resonance frequency of the fundamental, and (c) the third radial vibration mode.

shows the dimensional specifications of fabricated piezoelectric transformer in this study.

Impedance properties of the KNN piezoelectric transformer were measured as a function of frequency using a precision impedance analyzer (Agilent 4294A). The characteristics of the transformer under the variable load resistance were investigated using the experimental setup as shown in Fig. 3. The transformer was driven by an ac signal generated by a function generator and amplified by a high speed power

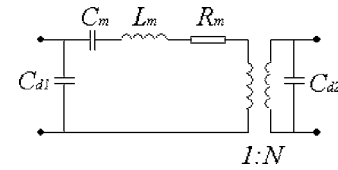

FIG. 5. Equivalent circuit of the piezoelectric transformer.

amplifier. A pure resistive load R_L was used. The voltage, current, and power of the input and output parts were measured by using two digital oscilloscopes. The temperature rise of the transformer was measured by an infrared thermometer about one minute after applying the input voltage. The temperature rise of the transformer can be controlled properly by tuning the input voltage.

IV. RESULTS AND DISCUSSIONS

The measured impedance spectra of the KNN piezoelectric transformer are shown in Fig. 4. The resonance and antiresonance responses of the fundamental radial vibration mode [Fig. 4(b)] and the third radial vibration mode [Fig. 4(c)] are clear without any spurious mode.

The electrical equivalent circuit of piezoelectric transformers operating near the resonance frequencies can be simplified as shown in Fig. 5.¹⁹ The turn ratio of the transformer N can be calculated by²⁰

$$N = \sqrt{\frac{L_{m,output}}{L_{m,input}}}. \quad (1)$$

The equivalent circuit parameters of the transformer under different vibration modes were measured using an impedance analyzer. Each part was measured under the condition that the other part was short circuited. The results are shown in Table III. Using Eq. (1), the N of the fundamental and the third vibration modes are 3.896 and 2.654, respectively.

Figure 6 shows plots of the voltage gain of the KNN piezoelectric transformer in the fundamental and the third radial vibration modes as a function of frequency with different load resistances. It is seen that the maximum voltage gain with respect to frequency increases with load resistance. As load resistance increases, the frequency where voltage gain attains maximum increases. In addition to the load resistance and driving frequency, the voltage gain also depends on the properties of the piezoelectric material.

In order to determine the matching load, where the efficiency of a piezoelectric transformer attains its maximal value, different load resistors were tested. Figure 7 shows the effect of load resistance on the efficiency of the KNN piezo-

TABLE III. Parameters of the input and output parts of the KNN piezoelectric transformer.

		f_r (kHz)	f_a (kHz)	R_m (Ω)	L_m (mH)	C_m (pF)	C_d (pF)	Q_m	$\gamma=C_d/C_m$
The first mode	Input	106.8	111.6	18.66	24.64	90.21	980.2	886	10.9
	Output	106.7	108.7	192.8	374.2	5.946	159.2	1302	26.8
The third mode	Input	283.6	290.0	16.72	7.279	43.28	937.9	776	21.7
	Output	283.5	288.5	113.5	51.29	6.147	170.7	805	27.8

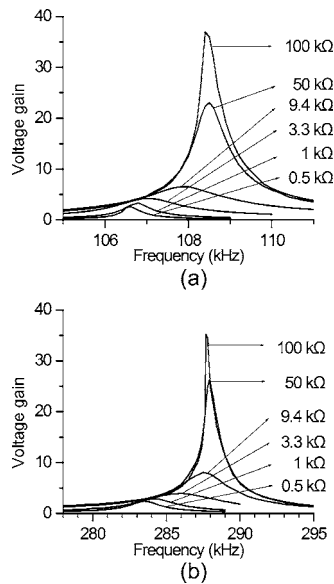

FIG. 6. Voltage gain as a function of frequency and load resistance: (a) the fundamental radial vibration mode and (b) the third radial vibration mode.

electric transformer. In this measurement, the frequencies were adjusted so that the efficiency attains maximum with respect to the individual load resistance. It is found that a maximum efficiency of $>95\%$ in the fundamental and the third radial vibration modes is obtained when the load resistance is 9.4 and 3.3 k Ω , respectively. According to the theoretical analysis, the matching load is equal to $1/(\omega C_{d2})$ where C_{d2} is the damped capacitance of the output part of the transformer.⁷ The experimental results are close to the theoretical values.

The relationship among the maximum output power, temperature rise, and input voltage of the transformer in the fundamental and the third radial vibration modes with matching load is shown in Fig. 8. Here, the maximum output power means the maximum value of the output power with respect to the driving frequency for a given input voltage. The temperature rise was measured at the annular gap where there is no electrode and the temperature is the highest. It is seen that the fundamental and the third radial vibration modes have almost the same power and temperature characteristics; a maximum output power of 12 W (a power density of 6.9 W/cm³) can be obtained with a temperature rise of 35 °C. Compared with the PZT piezoelectric transformer with the similar structure,^{13,14} the KNN piezoelectric transformer has a comparable voltage gain and a lower power

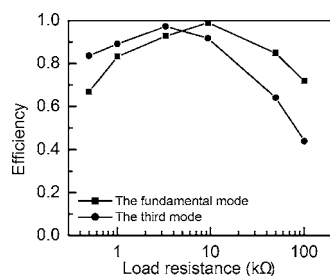

FIG. 7. Load resistance dependence of the efficiency of the KNN piezoelectric transformer.

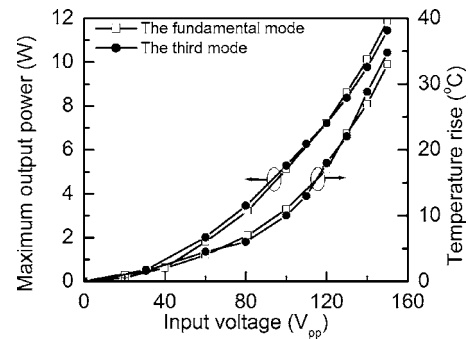

FIG. 8. Relationship among the maximum output power, temperature rise, and input voltage of the KNN piezoelectric transformer.

density (a typical value of power density for PZT piezoelectric transformer is 20 W/cm³ with a temperature rise of 20 °C). The cause of low power density may be a fast decrease in Q_m with increasing vibration velocity under high power condition. In order to further increase the maximum output power of the transformer, the planar electromechanical coupling factor k_p and the maximum vibration velocity v_{\max} of the piezoelectric ceramics need to be further improved.^{14,21}

V. SUMMARY

A lead-free KNN disk-shaped piezoelectric transformer operating in the fundamental or the third radial vibration modes has been fabricated and characterized. Near the resonance frequencies, the conventional electrical equivalent circuit was utilized to analyze the characteristics of the transformer. Properties of the piezoelectric transformer operating in the fundamental and the third radial vibration modes were measured. The experimental results show that it has a maximum output power of 12 W with a temperature rise of 35 °C. With the matching load, the maximum efficiency is $>95\%$, and maximum voltage gains are 6.5 and 3.9 for the fundamental and the third radial vibration modes, respectively. It has potential to be used in power supply units and other electronic circuits.

ACKNOWLEDGMENTS

This work was supported by the Innovation and Technology Fund (ITF GHS/066/04), the Centre for Smart Materials of the Hong Kong Polytechnic University, and the PolyU internal grants (Nos. 1-BBZ3 and 1-BB75).

¹C. A. Rosen, K. A. Fish, and H. C. Rothenberg, U.S. Patent No. 2830274 (April 8, 1958).

²S. Kawashima, O. Ohnishi, H. Hakamata, S. Tagami, A. Fukuoka, T. Inoue, and S. Hirose, Proc.-IEEE Ultrason. Symp. 1, 525 (1994).

³Y. Fuda, K. Kumasaka, M. Katsuno, H. Sato, and Y. Ino, Jpn. J. Appl. Phys., Part 1 36, 3050 (1997).

⁴O. Ohnishi, H. Kishie, A. Iwamoto, Y. Sasaki, T. Zaitso, and T. Inoue, Proc.-IEEE Ultrason. Symp. 1, 483 (1992).

⁵K. Nakamura and K. Kumasaka, Proc.-IEEE Ultrason. Symp. 2, 999 (1995).

⁶J. H. Hu, Y. Fuda, M. Katsuno, and T. Yoshida, Jpn. J. Appl. Phys., Part 1 38, 3208 (1999).

⁷J. H. Hu, H. L. Li, Helen L. W. Chan, and C. L. Choy, Sens. Actuators, A 88, 79 (2001).

⁸M. Yamamoto, Y. Sasaki, A. Ochi, T. Inoue, and S. Hamamura, Jpn. J.

- Appl. Phys., Part 1 **40**, 3637 (2001).
- ⁹J. L. Du, J. H. Hu, and K. J. Tseng, IEEE Trans. Ultrason. Ferroelectr. Freq. Control **51**, 502 (2004).
- ¹⁰M. Shoyama, K. Horikoshi, T. Ninomiya, T. Zaito, and Y. Sasaki Applied Power Electronics Conference and Exposition **2**, 573 (1997).
- ¹¹D. G. Hall, J. R. Phillips, G. L. Vaughn, D. Forst, and H. W. Mech, U.S. Patent 5872419 (16 February 1999).
- ¹²K. Uehara, T. Inoue, A. Iwamoto, O. Ohnishi, and Y. Sasaki, U.S. Patent 5278471 (11 January 1994).
- ¹³P. Laoratanakul, A. V. Carazo, P. Bouchilloux, and K. Uchino, Jpn. J. Appl. Phys., Part 1 **41**, 1446 (2002).
- ¹⁴S. Priya, S. Ural, H. W. Kim, K. Uchino, and T. Ezaki, Jpn. J. Appl. Phys., Part 1 **43**, 3503 (2004).
- ¹⁵S. Priya, H. Kim, S. Ural, and K. Uchino, IEEE Trans. Ultrason. Ferroelectr. Freq. Control **53**, 810 (2006).
- ¹⁶Y. Saito, H. Takao, T. Tani, T. Nonoyama, K. Takatori, T. Homma, T. Nagaya, and M. Nakamura, Nature (London) **432**, 84 (2004).
- ¹⁷H. L. Li, J. H. Hu, and H. L. W. Chan, IEEE Trans. Ultrason. Ferroelectr. Freq. Control **51**, 1247 (2004).
- ¹⁸D. A. Berlincourt, U.S. Patent 3764848 (9 October 1973).
- ¹⁹C. Y. Lin, Ph.D. dissertation, Virginia Tech, 1997.
- ²⁰J. L. Du, J. H. Hu, K. J. Tseng, C. S. Kai, and G. C. Siong, IEEE Trans. Ultrason. Ferroelectr. Freq. Control **53**, 579 (2006).
- ²¹P. Laoratanakul, Ph.D. dissertation, Pennsylvania State University, 2002.

Review of Scientific Instruments is copyrighted by the American Institute of Physics (AIP). Redistribution of journal material is subject to the AIP online journal license and/or AIP copyright. For more information, see <http://ojps.aip.org/rsio/rsicr.jsp>