

Research Article

A Low Complexity Active Sensing and Inspection System for Monitoring of Moveable Radiation Environments

Fei Ding ^{1,2} Dengyin Zhang ¹ Wanping Wang,³ and Zhenzhong Lei⁴

¹School of Internet of Things, Nanjing University of Posts and Telecommunications, Nanjing 210003, China

²School of Information Science and Engineering, Southeast University, Nanjing 210096, China

³Nuclear and Radiation Safety Supervision and Administration Bureau of Jiangsu Province, Nanjing 210000, China

⁴Radiation Protection Association of Jiangsu Province, Nanjing 210019, China

Correspondence should be addressed to Dengyin Zhang; zhangdy@njupt.edu.cn

Received 1 August 2017; Revised 9 November 2017; Accepted 27 December 2017; Published 27 March 2018

Academic Editor: Lucio Pancheri

Copyright © 2018 Fei Ding et al. This is an open access article distributed under the Creative Commons Attribution License, which permits unrestricted use, distribution, and reproduction in any medium, provided the original work is properly cited.

Due to the portable property of moveable radiation sources, the traditional monitoring method is becoming increasingly unsuitable and it is urgent to provide an effective and low-cost method. This paper presents an active monitoring scheme for moveable radiation environments, the in situ monitoring, including a radiation detection node, an infrared proximity node, and an alarm node; these three schemes communicate with each other through the ZigBee wireless network. An active monitoring mechanism which realizes the automatic judgment of radiation source inbound or outbound state is proposed, thereby automatically switching the data sampling mode under different working conditions, so as to reduce the energy consumption of nodes. Based on the mobile terminal client application to interact with the monitoring center, a collaborative management mode between enterprise users and the environmental protection department is realized. A testbed of a simple active sensing and inspection system is created to test its user interaction capabilities. Experimental results prove that the system schedule proposed can effectively detect and dynamically monitor the moveable radiation source. The system can be easily replicated and extended to more environmental monitoring network.

1. Introduction

Radiation sources and radiation devices are widely applied in the fields of industry, agriculture, medical treatment, scientific research, and teaching and are characterized by a large quantity, scattered distribution, high risk, and difficult management [1–4]. Owing to the limited staff of the radiation regulatory agencies, there exist hidden dangers in security control of radiation source and radiation device. In addition, with the rapid economic development, radiation source has been increasingly applied in various fields, resulting in heightened growth in the potential risk of radiation regulation. Once a radiation accident occurs, it can cause serious casualties, economic losses, environmental pollution, and even social panic and so on.

In the nuclear safety report, the International Atomic Energy Agency (IAEA) pointed out that the security management of nuclear materials and other radiation sources in use,

storage, and transport is still weak [5]. Not only is the report aimed at the effective monitoring of radiation sources but also it is aimed at the joint study of the rapid response to nuclear and radiological terrorism prevention and the emergency response system. Therefore, it is of great significance to monitor, manage, and deal with the radiation source. In addition, in the 4th session of Nuclear Security Summit in Washington, China requested all nations to join hands to implement and strengthen the radioactive source security action plan. In order to prevent a large number of radiation sources from being coveted by the terrorists, in the next five years, China will further sort out the situation of domestic radioactive sources, improve the security system, and focus on the real-time monitoring of high-risk moveable radioactive sources [6].

The traditional radiation monitoring system mainly achieves radiation dose monitoring [7–10]. The structure of the radiation detector predominantly adopts high-pressure

ionization chamber, compensation type GM counter tube, proportional counter, Na I (TI) coupling PMT scintillation detector, silicon detector, and so on [11–15]. A variety of corresponding products are launched, including Mirion's (MGP) radiation monitoring system, Thermo's FHT 1700 iodine monitors, Canberra's rad patrol continuous area monitor system, and Polimaster's NPNET system. In the study of radiation system optimization, the monitoring method of radiation environment based on wireless sensor networks (WSNs) is proposed in [1, 16–18], which improves the deficiency of fixed radiation source monitoring. Based on moveable robots, the radiation emergency response method is proposed in [19, 20]. In summary, the above studies have focused primarily on the on-line detection of spot dose or regional radiation dose, but it is not suitable for moveable radiation source monitoring. In particular, the implementation of radiation monitoring in a single point or region, as well as the redeployment of video surveillance, will cause the high investment costs for the system.

Meanwhile, the current radiation source supervision cannot achieve a comprehensive, real-time, and dynamic monitoring; the usage, storage, and transfer of the radiation source in the whole process are inside a vacuum state and are lacking in corresponding measures. Currently, the main situations are reflected in three aspects: (1) the monitoring sites with the installation of radiation monitoring system entirely rely on the reported data of the monitoring system; (2) attributable to the limited moveable manpower on duty, it is lacking a regular inspection process; and (3) because of the characteristics of moveable radiation sources, it is necessary to have a regular inspection of moveable flaw detection and other application scenarios. According to the radiation dose data reported in fixed monitoring points, the Environmental Protection Department is unable to obtain the save status (inbound and outbound) of the radiation source; if the entire work process of the radiation source achieves full coverage monitoring, then the system input costs are particularly high. In addition, most of the existing radiation monitoring systems have not yet realized the capacity of moveable inspection, which limits the flexibility, convenience, and linearity of regulation and law enforcement.

In conclusion, it is necessary to study low-cost, rapidly deployable, and more suitable methods for the monitoring and status identification of moveable radiation sources. This paper introduces an active sensing and inspection radiation source monitoring system. The monitoring sites are included in a ZigBee-based radiation monitoring (ZRM) node, a ZigBee-based infrared proximity (ZIP) node, and a ZigBee-based sound and light (ZSL) node, where they are connected to each other through the ZigBee wireless network. The convergence data is submitted to the monitoring center by the ZigBee-based gateway (ZGW) [21–27]. In addition, [28, 29] proposed a combination of ZigBee and other wireless technologies to achieve monitoring and control applications. The real-time dosage rate and storage conditions of the moveable radiation source are then monitored based on the data obtained from the sensor nodes. Meanwhile, the radiation monitoring work is cocompleted by enterprise users and local environmental authorities, forming the front end

of the collaborative management mode of “user-local environmental authorities.” It optimizes the monitoring degree in the radiation source of enterprise management personnel and solves the problem of manpower shortage of current local environmental authorities. Sections 2, 3, and 4 discuss the system architecture, the design methods of the active sensing and inspection system, and the demonstration experiment.

2. System Overview

As shown in Figure 1, a radiation management, monitoring, and emergency-handling scheme is generally divided into three layers: sensing layer, network layer, and application layer.

The sensing layer is predominantly responsible for the monitoring of the radiation dose rate level, position, and monitoring information in various radioactive areas. To guarantee the safety of the monitoring site, it can respond quickly to the abnormal changes of the radiation dose rate level.

The network layer mainly realizes the remote transmission of the field radiation monitoring data, which sends the terminal management and system control commands coming from the application layer to the sensing layer.

The application layer can be divided into the data layer, the decision support layer, and the service layer.

- (1) The data layer mostly fulfills the management of the basic information of the radiation source, the radiation monitoring terminal, enterprise information, radiation hazards, knowledge base, and case base.
- (2) The decision support layer includes a real-time tracking and monitoring subsystem, an early warning subsystem, and an emergency subsystem. The former chiefly realizes the input and query of the basic information of radiation source and dynamically displays and positions the aggregated statistical information of the enterprises in the whole system, as well as their corresponding radiation sources. It displays radiation dose data changes and save status of the radiation source in a map mode. So users can directly locate a radiation source or enterprise; it provides map layer selection, map zoom, and a radiation source and enterprise screening function. It achieves real-time updates and displays alarm events. The latter includes radiation index system, contingency plans, and command subsystem.
- (3) The service layer primarily includes the law and regulation inquiry, the radiation facility operation management, the administrative examination and approval, the declaration, and registration management.

Therefore, this proposed management scheme integrates the declaration and provision of the radiation source, daily use management, and application processing mechanisms

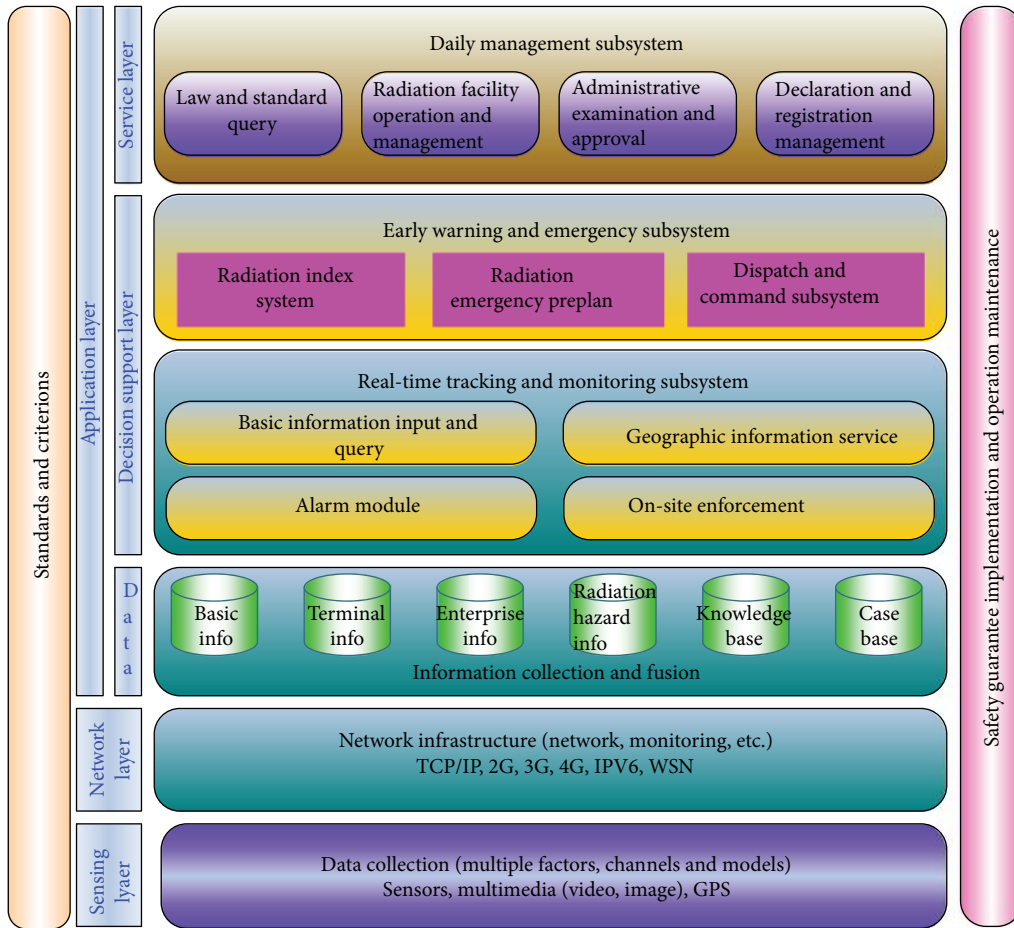

FIGURE 1: A radiation management, monitoring, and management architecture.

to guarantee that the radiation source is in a safe state of surveillance and effectively gives early warnings and handles any radiation crises that may occur.

3. Design Methods

3.1. Wireless Radiation Node Design. The wireless radiation node uses a Geiger counter as the radiation detection sensor, which realizes the wireless communication with the ZIP node and the ZSL node through the ZigBee technology; the data of all ZigBee nodes are converged to the gateway (as the sink node in ZigBee network) and transmitted to the monitoring center platform remotely. The circuit of wireless radiation node adopts the stack design, which is the bottom microprocessor control circuit, which mainly realizes the functions of power supply and management, and radiation signal acquisition, and the upper layer is the ZigBee node circuit. The antenna of the ZigBee node extends out through the cable. The wireless network based on ZigBee technology realizes multihop network topology, and the robustness of the network in the radiation field is good. The wireless radiation node uses external power supply in order to ensure the reliability and also integrates a lithium battery, resulting in external electric power down when the wireless radiation node can maintain stable operation. Figure 2 shows the

structure of the proposed wireless radiation node in an exploded view.

3.2. Logic Decomposition. According to the logic division, the active radiation monitoring system can be divided into a hardware layer and a software layer, as shown in Figure 3. The hardware layer is responsible for providing a sensor interface and a control interface to achieve infrared state detection, radiation dose monitoring, and a sound and light alarm, as well as other functions. The main functions of the software layer include multimode data sampling (such as a real-time sampling mode, high-frequency continuous sampling mode, and low-frequency continuous sampling mode). According to the infrared module, the real-time sampling mode begins when the personnel enters. When the alarm occurs, the system automatically triggers the audible and visual alarm, reporting the alarm information to the remote monitoring center. To evaluate the effect of different operating modes on the supply voltage, the sensor interface also performs real-time sampling and monitoring of the supply voltage of the radiation monitoring node.

3.3. Front-End Coordinated Inspection. As shown in Figure 4, the front-end coordinated inspection mode gives full play to current moveable terminal client application (APP for short)

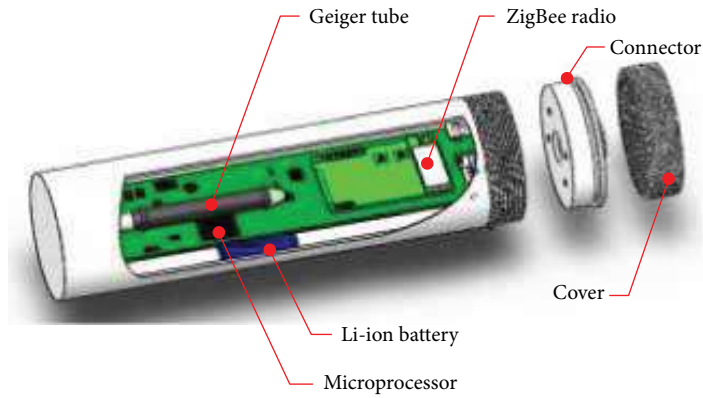

FIGURE 2: Principle of the proposed wireless radiation detection node.

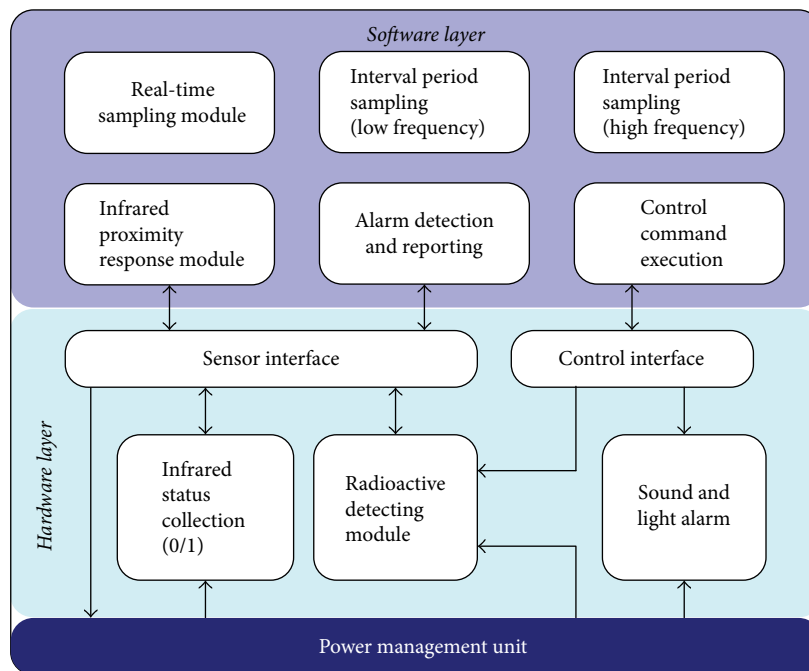

FIGURE 3: Logic decomposition of the proposed radiation monitoring node.

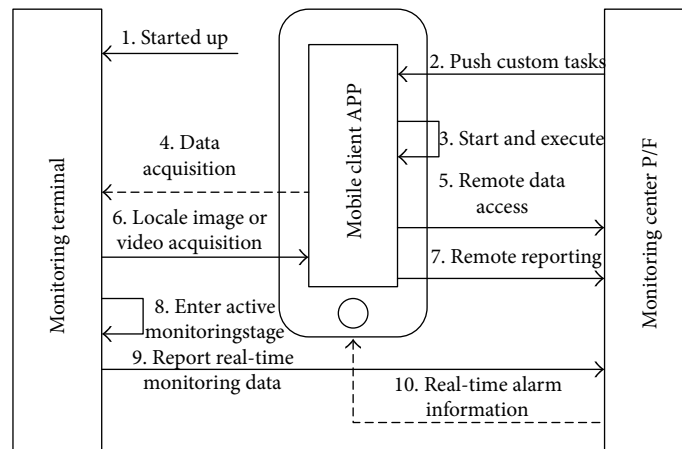

FIGURE 4: On-site inspection monitoring process.

self-service ability. So as to achieve a closed loop, interactive inspection, and monitoring service mode, the platform releases the daily inspection task to the client APP of the user and the user performs the inspection operation. The monitoring center formulates the corresponding inspection tasks (such as the setup of inspection cycle, reported image, and video selection) according to the monitoring needs of various radiation source enterprises. Based on the camera capacity of the mobile terminal, it can carry out task executions whenever and wherever possible (data acquisition, image monitoring, or video report), saving the cost of fixed camera deployment in the region and improving the flexibility of inspection work.

The main flow of interactive inspection monitoring is as follows:

(S1) Start the radiation monitoring terminal.

(S2) The remote monitoring center generates the inspection task and pushes to the mobile client APP of the enterprise inspector.

(S3) The enterprise user starts the mobile client APP and completes the inspection tasks according to the task requirements.

(S4) The mobile client APP initiates a data sampling request. The request is transmitted to the remote monitoring center. The real-time sampling instruction is issued by the monitoring center, and the radiation dose data is reported to the platform.

(S5) The mobile client APP remotely accesses the monitoring platform to obtain on-site monitoring data.

(S6) The mobile client APP takes an image or video sampling.

(S7) The sampled images and videos are reported to the platform.

(S8) The radiation monitoring terminal performs the active monitoring mode.

(S9) According to the set from the active monitoring mechanism, the monitoring terminal implements periodic data sampling and reports them to the platform.

(S10) If the radiation value exceeding the standard is detected, the radiation monitoring terminal automatically gives alarm information and the platform will push the alarm information to the corresponding enterprise user.

The workflow of inspection and monitoring is comprised of steps S2–S7. In addition to the implementation of inspection tasks, the radiation monitoring terminals are in the active mode of monitoring (S8–S10). Once an alarm occurs, the monitoring center and enterprise users will receive alerts in a timely manner to facilitate the rapid processing.

3.4. Active Monitoring Mechanism. The movable radiation source is deposited in the inbound state (kept in the safe) for a majority of the time. It is taken out for use when necessary (such as the internal structure of metal component testing, etc.). It is then put into storage after the detection task. Therefore, it is very important to obtain the real-time state of inbound/outbound for the movable radiation source.

Through the cooperation among the sensor nodes deployed in the field, the active monitoring mechanism will

Given: assuming that the environmental background radiation dose threshold is ϕ , the radiation source security radiation threshold is ρ , and the sampling period is T .

```

1:  If the infrared proximity node detects an access event.
2:      Trigger high-frequency continuous sampling and
      save the radiation monitoring value  $D_i$  into the database.
3:      If  $D_i \in (\phi, \rho]$ 
4:          Radiation dose monitoring is in normal condition,
      and the radiation source is kept inbound (inbound state).
5:      End if
6:      If  $D_i \in (0, \phi]$ 
7:          Periodic sampling, and record the total number
      of samples.
8:          If the total consecutive sampling number does
      not exceed the set threshold.
9:              Affirm that the movable radiation source
      has been taken out (outbound state).
10:         The radiation detection node keeps going
      into standby mode.
11:     End if
12:     If  $D_i \in (\rho, \infty)$ 
13:         Set alarm flag, trigger, and report the alarm
      information immediately.
14:     End if
15:      $i = i + 1$ .
16: Else
17:     Enter the low frequency sampling mode and realize
      the intermittent working stage.
18: End if
19: Repeat the above procedures for the next time slot.
```

ALGORITHM 1: Active processing procedure.

identify the inbound/outbound state of the movable radiation source. The main processing flow is as follows:

4. System Implementation

In order to verify the basic functions of the active sensing and inspection system, a testbed was created in an enterprise with movable radiation sources. Previously, the enterprise adopts multiple supervision modes for its own moveable radiation source. The moveable radiation source is placed within a safe with an iron cabinet outside. An iron fence is also surrounding the iron cabinet. The key to the safe and the iron cabinet are managed separately by two administrative staffs for the effective control of the radiation source. The inbound and outbound states are in manual recording. Throughout the whole process, the environmental protection department cannot obtain the working condition of the movable radiation source.

As shown in Figure 5, a ZRM node is deployed in the safe (ZigBee antenna is extended through the copper cable); a ZIP node and a ZSL node are also deployed at the same time. The data of the above three ZigBee nodes are aggregated to the ZGW, and they are finally remotely reported to the remote monitoring center. The testbed setup is shown in Figure 6. The wireless radiation node is deployed in the storage cabinet of the radiation source to monitor the radiation equivalent of the radiation source in real time. When the ZIP node detects

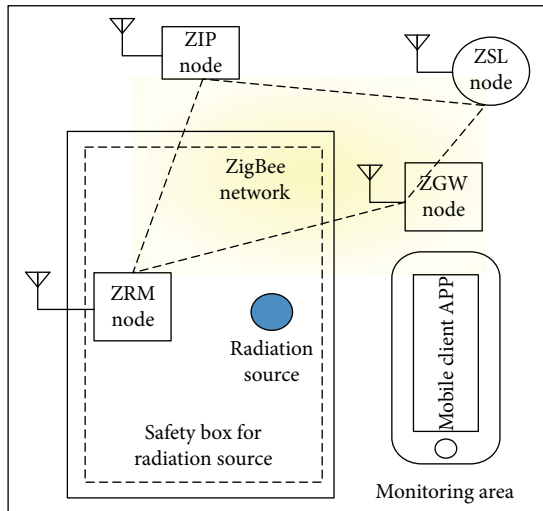
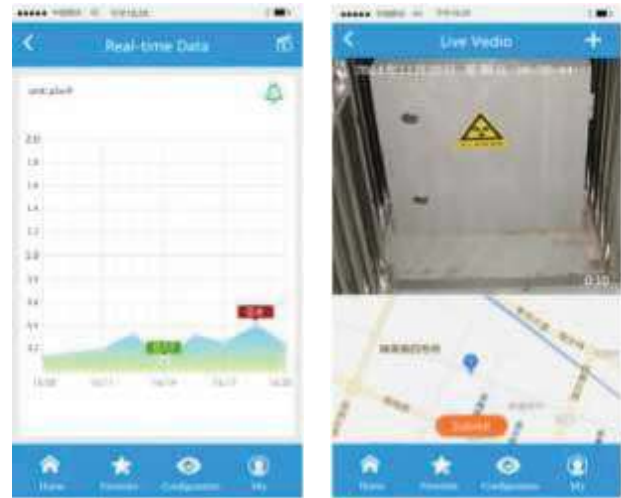

FIGURE 5: Simplified diagram showing the process of the active monitoring test.



(a)

(b)

FIGURE 7: GUIs of the prototype system on user terminals. (a) Real-time data window. (b) Video capture and upload window.



(a)

(b)



(c)

FIGURE 6: Testbed setup for the demonstration experiments. (a) Wireless radiation nodes based monitoring scenario. (b) Application scenarios of ZSL and alarm nodes. (c) ZigBee-based gateway node.

someone entering, the system will automatically start the active monitoring mechanism to determine whether the radioactive source is taken out (or stored). If the ambient radiation detected by the wireless radiation node exceeds the set threshold, the gateway node will trigger the ZSL node to start alarm information.



FIGURE 8: GIS-based GUI of monitoring center.

The main functions of the mobile inspection client APP include real-time monitoring, geographic information system- (GIS-) based map positioning, alarm management, historical data viewing, and system settings, as well as other functions. The designed graphical user interface (GUI) running on the hand-held devices is shown in Figure 7. The left is the real-time data acquisition curve, while the right is the on-site video monitoring GUI. The enterprise user can complete the radiation dose data inspection and on-site monitoring of the image or video reporting according to the inspection work issued by the monitoring center. In order to ensure the validity of the data, the uploaded images or videos are labeled with timestamp information. The mobile inspection client APP also supports government law enforcement officers to conduct on-site sampling inspection and achieves the photo shot function in emergencies.

As shown in Figure 8, the monitoring center platform includes user management, GIS map localization, real-time monitoring, alarm management, historical data query and radiation source database, and system configuration. Considering the cost of the ZRM node and its indoor working scene

most of the time, the ZRM node can configure the GPS module according to monitoring needs. When not equipped with a positioning module, its position can be designed in the monitoring center platform of manual mode. At the same time, it can be updated or recalibrated by using the location information reported by the mobile inspection client APP. The map monitoring GUI corresponds to the actual position of the ZRM node through the location icon, allowing the user to click and check the monitoring image or video received after the recent inspection.

In order to verify the wireless transmission performance of the image or video captured by the mobile client APP, we collect the images and video with various wireless network standards and evaluate the delay of transmission. Figure 9 displays the compared result of the setup of different image formats. Figure 10 shows the comparison result of the setup of different video formats.

Figure 11 is the delay test result of the uploaded image based on mobile inspection client APP (image format corresponds to the set parameters in Figure 9). It can be observed from the figure that the transmission delay of the 2G network is more than 5.2 seconds. The transmission delay in the 3G network is between 0.44 and 0.7 seconds. The transmission delay in the 4G network is within 0.03 seconds. Therefore, in image transmission, the 3G and 4G networks set the mobile client APP. When the mobile terminal is in the 2G network, there will be data cache. When the network mode is transferred to 3G or 4G network, it will upload to the platform so as to improve the efficiency of the inspection.

Figure 12 displays the delay test result of video transmission in varying wireless networks. It can be seen from the test results that the 2G network cannot achieve the basic video file transmission (transmission delay is too long or there is transmission failure). The 3G network video transmission delay is between 9.65 seconds and 26.4 seconds, making it unsuitable for video upload. The video transmission delay in the 4G network is less than 1.3 seconds. Therefore, when the inspection operation is performed, the video transmission is limited to the 4G network for data upload. The choice of wireless network transmission mode of images or video is predominantly set in the mobile client APP.

Figure 13 shows a sampling result based on the proposed active monitoring method. It is shown that the real-time radiation dose rate of the moveable radiation source deposited in a lead box is between $0.25 \mu\text{Gy/h}$ and $0.5 \mu\text{Gy/h}$, the radiative dose rate of the environmental background is between 0 and $0.15 \mu\text{Gy/h}$, and the former is more volatile than that of the latter. According to the proposed active monitoring mechanism, the parameter can be set between $0.15 \mu\text{Gy/h}$ and $0.25 \mu\text{Gy/h}$ and can be set to $0.2 \mu\text{Gy/h}$. Hence, through the ZIP node combined with the variation of radiative dose rate sampling, it can effectively identify the inbound or outbound state of the moveable radiation source and also push the identification results to the management GUI and the mobile terminal users.

Figure 14 shows the power consumption comparison results for ZRM nodes in various monitoring modes. It shows that the traditional continuous sampling mode can cause power consumption and the active monitoring

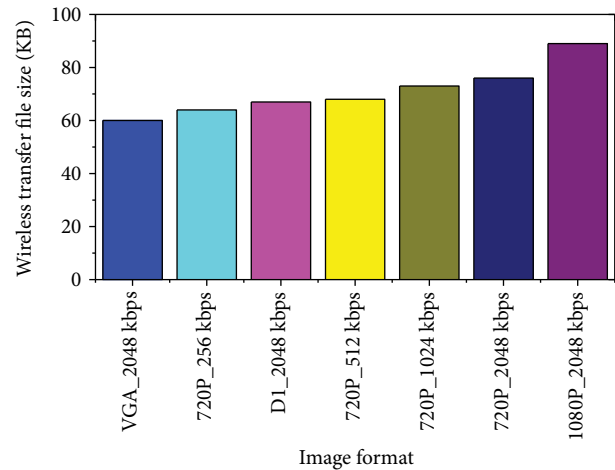

FIGURE 9: Transfer file size in different image formats.

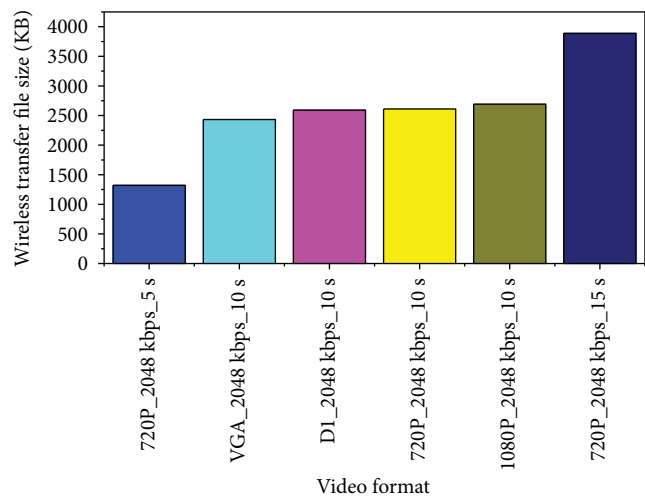

FIGURE 10: Transfer file size in different video formats.

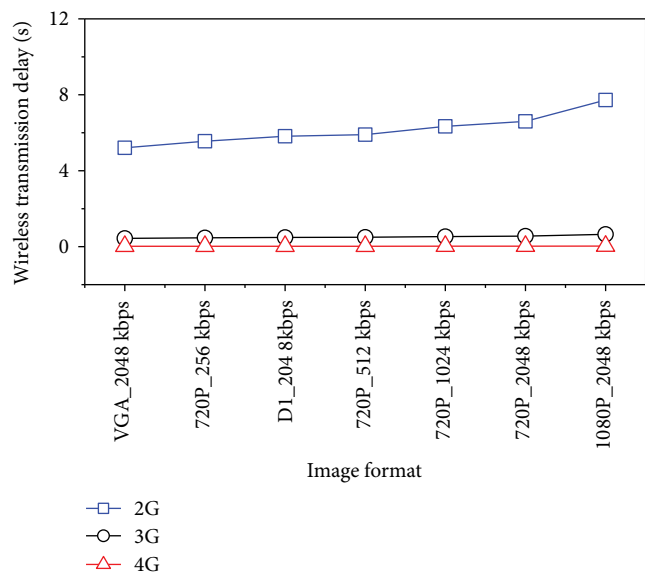

FIGURE 11: Image transmission delay in different networks.

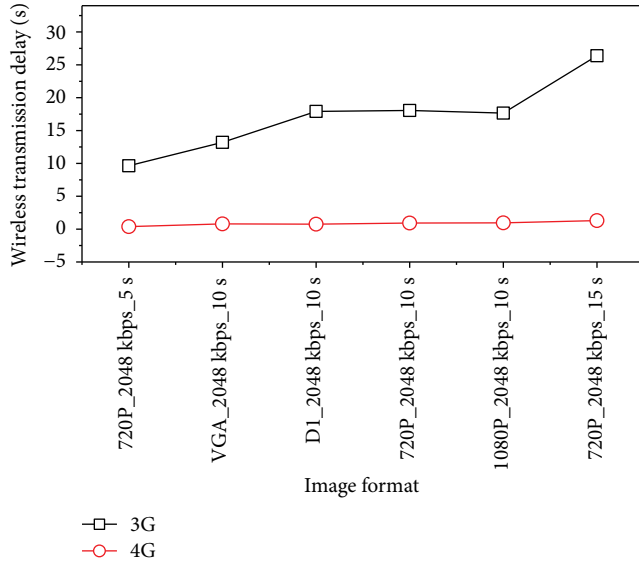

FIGURE 12: Video transmission delay in different networks.

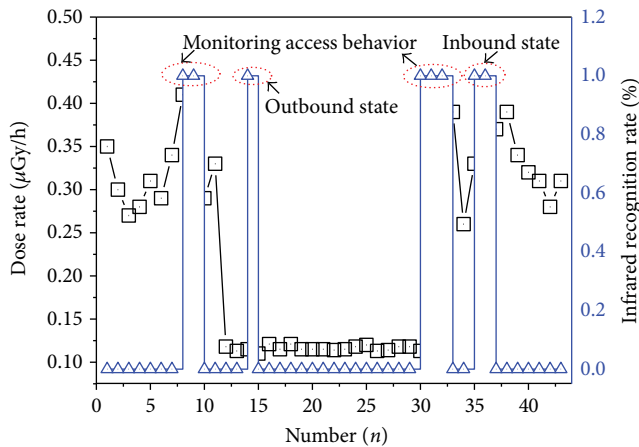

FIGURE 13: Sampling result based on the proposed active monitoring method.

mechanism can effectively optimize the power consumption of the radiation detection node, as well as obtaining better energy efficiency.

5. Conclusions

This paper proposes a low complexity active sensing and inspection system for the monitoring of moveable radiation environment. Its main contributions include the following aspects: (1) based on the deployment of radiation monitoring, infrared proximity, and alarm nodes, they connect to each other by ZigBee wireless communication. A fixed-point radiation monitoring of radiation sources, as well as automatic recognition of inbound and outbound states, can be achieved so as to fulfill the real-time and dynamic monitoring of movable radiation sources. (2) The inspection task can be set through the remote monitoring center. The

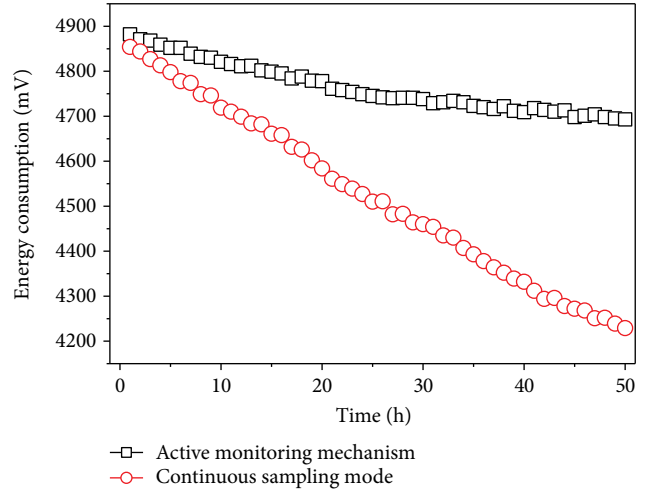

FIGURE 14: Energy efficiency comparison of different working modes.

enterprise personnel can participate in the inspection work. It can give full play to the advantage of the flexible and convenient monitoring task of the individual mobile terminal, as well as avoiding the high cost and inflexibility of traditional fixed deployment of video surveillance systems. (3) For the radiation source supervision, the establishment of the system transfers the management mode of traditional passive on-site monitoring data into the management mode of “real-time monitoring, state recognition, and regular inspection.” It optimizes the existing monitoring mode of radiation source and establishes cooperative radiation source security monitoring, as well as management mode of both the front-end (enterprise user) and back-end (environmental protection department).

Conflicts of Interest

The authors declared that they have no conflicts of interest to this work.

Acknowledgments

This work is partially supported by the National Major Project of China (no. 2010ZX03006-006), the National Natural Science Foundation of China (no. 61571241), the Ministry of Education-China Mobile Research Foundation, China (no. MCM20170205), the Communication Soft Science Research Project of the Ministry of Industry and Information Technology of China (no. 2017-R-34), the Scientific Research Foundation of the Higher Education Institutions of Jiangsu Province, China (nos. 15KJA510002 and 17KJB510043), the Research Foundation for Advanced Talents, Nanjing University of Posts and Telecommunications (no. NY217146), and the Open Foundation of the Key Laboratory of Remote Measuring and Control, Jiangsu Province, China (no. 2242015k30005). The authors would like to thank Wei Lu and Ming Hu for their help with the experiments.

References

- [1] L. Zhang, M. Yuan, D. Tai, J. Ding, and X. Xu, "Design and implementation of granary monitoring system based on wireless sensor network node," in *2010 International Conference on Measuring Technology and Mechatronics Automation*, pp. 950–953, Changsha City, China, 2010.
- [2] A. Badal, F. Zafar, and A. Badano, "A real-time radiation dose monitoring system for patients and staff during interventional fluoroscopy using a GPU-accelerated Monte Carlo simulator and an automatic 3D localization system based on a depth camera," in *Medical Imaging 2013: Physics of Medical Imaging*, Lake Buena Vista (Orlando Area), FL, USA, 2013.
- [3] A. M. Scott, "Current issues in radiation dose monitoring and reporting," *Radiologic Technology*, vol. 85, no. 5, pp. 501–516, 2014.
- [4] R. F. James, K. J. Wainwright, H. A. Kanaan et al., "Analysis of occupational radiation exposure during cerebral angiography utilizing a new real time radiation dose monitoring system," *Journal of Neurointerventional Surgery*, vol. 7, no. 7, pp. 503–508, 2015.
- [5] K. H. Harada, T. Niisoe, M. Imanaka et al., "Radiation dose rates now and in the future for residents neighboring restricted areas of the Fukushima Daiichi Nuclear Power Plant," *Proceedings of the National Academy of Sciences of the United States of America*, vol. 111, no. 10, pp. E914–E923, 2014.
- [6] H. Zhang, "How China needs to improve its legal framework on nuclear security," *Bulletin of the Atomic Scientists*, vol. 1, no. 1, 2016.
- [7] I. Mandic, V. Cindro, M. Deliyeriyev, and A. Gorišek, "First results from the online radiation dose monitoring system in ATLAS experiment," *Biosystems Engineering*, vol. 6963, no. 4, pp. 1107–1112, 2011.
- [8] F. T. Huang and T. T. Sun, "Design and implementation of radiation dose monitoring system based on wireless sensor network," in *International Conference on Future Information Technology (ICFIT)*, vol. 13, pp. 561–565, Singapore, September 2011.
- [9] K. Szewczak and S. Jednoróg, "Calibration of the RSS-131 high efficiency ionization chamber for radiation dose monitoring during plasma experiments conducted on plasma focus device," *Open Physics*, vol. 12, no. 10, pp. 719–724, 2014.
- [10] K. Higashigaito, A. S. Becker, K. Sprengel, H. P. Simmen, G. Wanner, and H. Alkadh, "Automatic radiation dose monitoring for CT of trauma patients with different protocols: feasibility and accuracy," *Clinical Radiology*, vol. 71, no. 9, pp. 905–911, 2016.
- [11] Z. Wang, Y. Shen, and J. An, "A new method for measuring the response time of the high pressure ionization chamber," *Applied Radiation & Isotopes*, vol. 70, no. 8, pp. 1718–1722, 2012.
- [12] G. M. Shrum and R. Smith, "A portable geiger-muller tube counter as a detector for radioactive ORES," *Canadian Journal of Research*, vol. 11, no. 5, pp. 652–657, 1934.
- [13] S. B. Guetersloh, T. B. Borak, P. J. Taddei et al., "The response of a spherical tissue-equivalent proportional counter to different ions having similar linear energy transfer," *Radiation Research*, vol. 161, no. 1, pp. 64–71, 2004.
- [14] A. Osovizky, D. Ginzburg, A. Manor et al., "SENTIRAD—an innovative personal radiation detector based on a scintillation detector and a silicon photomultiplier," *Nuclear Instruments and Methods in Physics Research Section A: Accelerators, Spectrometers, Detectors and Associated Equipment*, vol. 652, no. 1, pp. 41–44, 2011.
- [15] G. Bertuccio, D. Puglisi, L. Torrissi, and C. Lanzieri, "Silicon carbide detector for laser-generated plasma radiation," *Applied Surface Science*, vol. 272, no. 6, pp. 128–131, 2013.
- [16] R. Gomaa, I. Adly, K. Sharshar, and A. Safwat, "ZigBee wireless sensor network for radiation monitoring at nuclear facilities," in *6th Joint IFIP Wireless and Mobile Networking Conference (WMNC)*, pp. 1–4, Dubai, United Arab Emirates, 2013.
- [17] H. A. Adamu and M. B. Muazu, "Remote background radiation monitoring using Zigbee technology," *International Journal of Electronics & Computer Science Engineering*, vol. 3, no. 2, 2014.
- [18] J. Ebenezer and S. S. Murty, "Deployment of wireless sensor network for radiation monitoring," in *2015 International Conference on Computing and Network Communications (CoCoNet)*, Trivandrum, India, 2015.
- [19] T. Zhang, T. Wang, and Q. Zhao, "γ Ray irradiation test of motion control components of nuclear emergency rescue robot," in *2013 IEEE International Conference on Robotics and Biomimetics (ROBIO)*, pp. 2118–2123, Shenzhen, China, 2013.
- [20] R. M. Vazquez and E. Gutierrez, "Mobile robot for gamma radiation detection with long range remote control," in *2015 International Conference on Mechatronics, Electronics and Automotive Engineering (ICMEAE)*, pp. 175–180, Prague, Czech Republic, 2015.
- [21] J. Yang, B. Chen, K. Burk, H. Wang, and J. Zhou, "A mainstream monitoring system for respiratory CO₂ concentration and gasflow," *Journal of Clinical Monitoring and Computing*, vol. 30, no. 4, pp. 467–473, 2016.
- [22] J. Yang, J. Zhou, Z. Lv, W. Wei, and H. Song, "A real-time monitoring system of industry carbon monoxide based on wireless sensor networks," *Sensors*, vol. 15, no. 11, pp. 29535–29546, 2015.
- [23] F. Leccese, "Remote-control system of high efficiency and intelligent street lighting using a Zigbee network of devices and sensors," *IEEE Transaction on Power Delivery*, vol. 28, no. 1, pp. 21–28, 2013.
- [24] B. C. Mishra, A. S. Panda, N. K. Rout, and S. K. Mohapatra, "A novel efficient design of intelligent street lighting monitoring system using ZigBee network of devices and sensors on embedded internet technology," in *2015 International Conference on Information Technology (ICIT)*, pp. 200–205, Bhubaneswar, India, 2015.
- [25] J. Hu, "Application of ZigBee wireless sensor network in gas monitoring system," *Acta Technica CSAV (Ceskoslovensk Akademie Ved)*, vol. 62, no. 1, pp. 255–264, 2017.
- [26] Z. Kaleem, I. Ahmad, and C. Lee, "Smart and energy efficient LED street light control system using ZigBee network," in *2014 12th International Conference on Frontiers of Information Technology*, pp. 361–365, Islamabad, Pakistan, 2015.
- [27] A. B. Sakhare and Y. S. Angal, "High efficient and intelligent lighting and security remote control system using a Zigbee network," in *2015 International Conference on Industrial Instrumentation and Control (ICIC)*, pp. 551–555, Pune, India, 2015.
- [28] F. Leccese, M. Cagnetti, and D. Trinca, "A smart city application: a fully controlled street lighting isle based on Raspberry-Pi card, a ZigBee sensor network and WiMAX," *Sensors*, vol. 14, no. 12, pp. 24408–24424, 2014.
- [29] M. Cagnetti, F. Leccese, and D. Trinca, "A new remote and automated control system for the vineyard hail protection based on ZigBee sensors, raspberry-Pi electronic card and WiMAX," *Journal of Agricultural Science and Technology B*, vol. 3, no. 12, pp. 853–864, 2013.



Hindawi

Submit your manuscripts at
www.hindawi.com

