

A LOW-PROFILE HIGH-PERFORMANCE CRYSTAL OSCILLATOR FOR TIMEKEEPING APPLICATIONS

R. K. Karlquist**, L. S. Cutler**, E. M. Ingman*, J. L. Johnson**, and T. Parisek*

*Hewlett-Packard Company, Santa Clara Division, 5301 Stevens Creek Blvd., MS 7, Santa Clara, CA 95051

**Hewlett-Packard Laboratories, 3500 Deer Creek Rd., MS 26M3, Palo Alto, CA 94304

Abstract

A crystal oscillator is described that uses various unusual techniques to achieve double-oven class temperature stability with a single oven. Stability of better than 1 part in 10^{11} over a temperature range of -40° to $+85^{\circ}$ C has been demonstrated. The use of the single stage oven allows for a form factor with a relatively low height (19 mm. or $\frac{3}{4}$ inch) for an oscillator of this performance class. The low profile facilitates card-based designs. In timekeeping applications such as wireless and telecom synchronization, the temperature coefficient of frequency (tempco) is more important than ever. The temperature extremes involved in wireless base stations increase the error due to temperature while the use of GPS timing receivers to discipline quartz oscillators greatly reduces the error due to aging, leaving tempco as the major component. Numerous design innovations are described such as a hermetic oven mass assembly and a non-ovenized digital temperature controller. This controller permits automated optimization of the oven set point and thermal gain. An overview of a novel zero-gradient oven technique used to achieve the double-oven performance is given, with more details in a related paper. Frequency pulling due to the oscillator circuit components is greatly reduced by a novel balanced-bridge controlled oscillator circuit that is described briefly here and in more detail in another related paper.

Oscillator requirements for timekeeping applications

Quartz oscillators have traditionally been used as frequency sources, rather than as timebases for clocks, the latter role having been filled by atomic standards. Recently, GPS receivers using quartz “flywheels” have been replacing atomic clocks in synchronization applications such as wireless base stations and telecom central offices. Oscillators used in this new role have different requirements from traditional ones. In a traditional ap-

plication without GPS, an oscillator might be recalibrated as often as once per month. A good quartz oscillator will typically age several parts in 10^9 / month. Hence the accuracy, even with the monthly recalibrations, is limited to about 10^{-9} . In light of this, a tempco of 10^{-9} over 50° C (typical for a good single oven oscillator) would probably be considered adequate, since it wouldn't appreciably degrade the 10^{-9} . While this level of accuracy would be adequate for most syntonization type applications, it would not be acceptable for most synchronization applications since a 10^{-9} frequency error is equivalent to an accumulated time error of 86.4 μ sec per day, whereas only a few μ sec of error is tolerable.

In a quartz based GPS timing receiver, aging is measured by comparison to GPS, then future aging is predicted based on past aging, and the prediction is used to remove most of the aging. With aging thereby removed, the tempco is left as the major source of error. While the GPS receiver is good for correcting long term errors such as aging, it is of limited utility for dealing with frequency errors caused by rapid temperature fluctuations. This is because a long loop time constant is required to integrate out SA (selective availability) noise. It is also desirable to have the capability of operating without the help of GPS for periods of a few hours to a few days. This mode is known as holdover. When in holdover, the oscillator's frequency is adjusted to compensate for expected aging, but otherwise it is free running. An example of a holdover test is shown in fig. 1. An oscillator of the type described in this paper was locked to GPS for 24 hours so that past aging data could be gathered to predict future aging. After the 24 hours, the GPS antenna was removed, and the oscillator was steered with the algorithm's best guess about aging. The oscillator was predictable enough to keep a clock driven by it within $\frac{1}{2}$ μ sec after one day, and 3 μ sec after 2 days, and about 10 μ sec after 3 days. Since the aging

correction is not perfect, it is desirable to have as much of the error budget as possible available for uncorrected aging by minimizing temperature effects. This includes not only the usual tempo of frequency, but also tempo of frequency aging (e.g.: fig. 8).

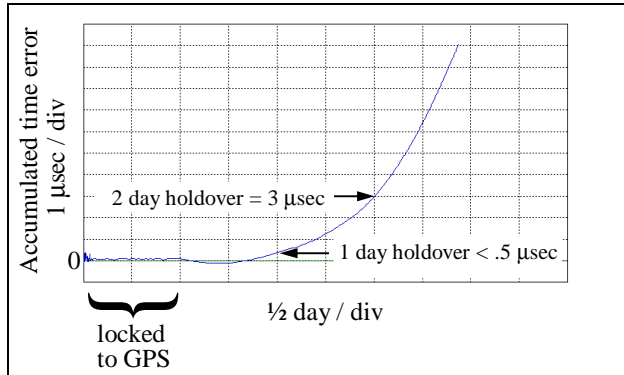

Figure 1. Oscillator holdover test.

Other oscillator requirements

The environmental requirements for wireless synchronization have become quite stringent with the trend towards microcell technology, in which base stations are mounted in non-environmentally controlled enclosures on utility poles instead of air conditioned sheds on mountaintops. For this reason, a specified temperature range of -40 to $+85$ °C was chosen for the oscillator described in this paper. This is significant because some oven designs can only achieve high thermal gain over a limited temperature range. Another trend in synchronization sources is card based design, rather than rack and stack boxes. Although small size in general is always desirable, the critical size issue in card based oscillators is the height. An oscillator with height exceeding the available headroom in a module, no matter how small its footprint, will require a double-width module, if that is an option, or will be unusable altogether. A height requirement of 19 mm or $\frac{3}{4}$ inch was chosen for this oscillator on the basis that it would fit most known modular systems, and was large enough to allow good oven design. Another requirement is that the oscillator must be hermetically sealed to prevent variations in humidity and barometric pressure from causing frequency errors.

Design philosophy

The underlying design philosophy for the oscillator is to build a high quality oven, minimize the ovenization requirements, and partition the system so that only those sections that must be ovenized are in the oven (fig.2). The non-ovenized circuitry can then be absorbed onto the card on which the oven is mounted. The minimization of tempo is based on the combination of operating the crystal very close to a turnover temperature and using an oven with extremely high thermal gain. Although the crystal is the major potential contributor to tempo, it is important to minimize tempo effects due to the oscillator circuit components. A two prong approach was used here. First, an extremely low tempo oscillator circuit was developed [1] . Second, it was located in the oven with the crystal, and the oven was designed to provide high thermal gain over its full volume, not just at the crystal [2] .

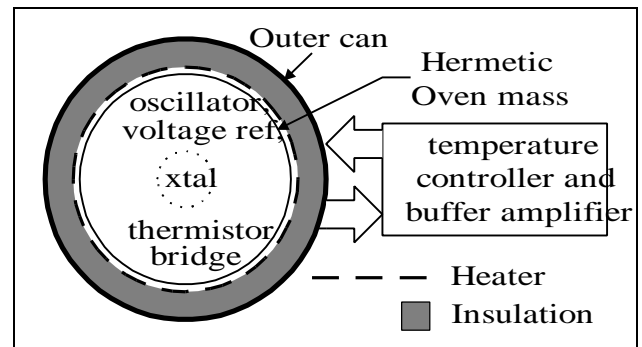

Figure 2. Oscillator partitioning.

To minimize temperature induced aging rate shifts (fig. 8), the oscillator and crystal are mounted within an isothermal hermetic space. This effect is covered in more detail below. The height was minimized by developing a low-profile crystal package and using a minimum amount of thermal insulation. Where necessary, footprint compactness was sacrificed to minimize height.

Mechanical construction

Figure 3 shows an exploded view of the oscillator oven assembly.¹ An outer cylindrical can of drawn copper is lined with thermal insulation about 3 mm. thick.

¹ Patent pending.

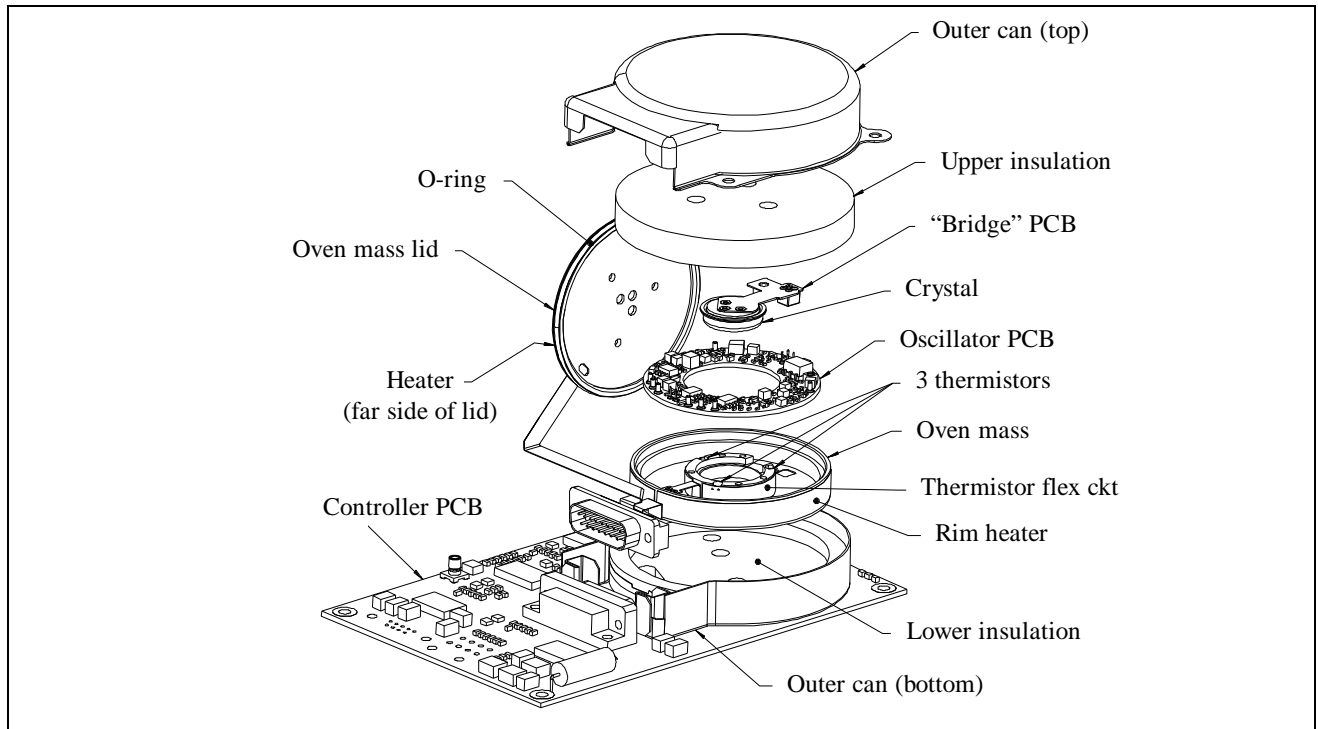

Figure 3. Mechanical design of oscillator, oven and controller board.

The top and bottom mate with overlapping sides for good thermal conductivity and detents built into the can allow snap-together assembly. A D-subminiature connector for interface with the controller circuitry on the board is built into the side of the outer can. The cylindrical oven mass is supported mechanically by the thermal insulation surrounding it. Both faces and the rim of the oven mass are covered by flex-circuit heaters. The flex circuit is also used to connect to the D-subminiature connector. It exits thru a small space between the two halves of the insulation. The oven mass consists of a main oven mass piece and a lid. The crystal and oscillator circuit are located inside the oven mass, which is sealed by an O-ring around the lid and fastened with O-ring seal screws to maintain hermeticity.

The crystal package is mounted by its rim in a well in the center of the oven mass containing three equally spaced thermistors embedded in the walls. The thermistor leads connect to a flex circuit that wraps around the crystal well for close thermal coupling. This prevents temperature offsets between the thermistor and oven mass caused by heat flow along the leads. The thermistor flex circuit connects to a precision resistor

bridge and bias source on the oscillator board. The EFC diode is mounted on this board and extends into a notch in the crystal well so that its temperature remains close to that of the crystal well. The oscillator board is circular and fits around the crystal well. A small auxiliary board called the "bridge" board connects the crystal leads to the oscillator board. The outputs of the thermistor bridge, the RF output, and the EFC and DC power inputs for the oscillator are brought out of the oven mass on hermetic feedthrough pins. These are connected to the D-subminiature connector with auxiliary traces on the heater flex circuit. Four mounting ears on the outer can are used to secure it to the board using threaded inserts. Heat sinks are provided on this board for the oven heater regulator FET's (not visible in fig 3).

Electrical architecture

Fig. 4 shows an electrical block diagram. Conditioned +4.5V from the controller board powers the oscillator and +2.5V reference. The ovenized +2.5V reference has three functions: It is used to generate a stable ALC reference voltage in the oscillator, it biases the thermistor bridge, and is used as the reference voltage for

a 24 bit A/D converter on the controller board. The RF output of the oscillator is coupled via an impedance step down transformer with a floating secondary. This results in a balanced circuit with a very low impedance (several ohms) that can be connected via a pair of traces on the flex circuit without significant susceptibility to RFI and ground loops. Coax would be impractical here. The oscillator drives a conventional low phase noise grounded base buffer amplifier on the controller board. The low input impedance of the buffer amplifier is compatible with the oscillator, which is designed to drive a low impedance load.

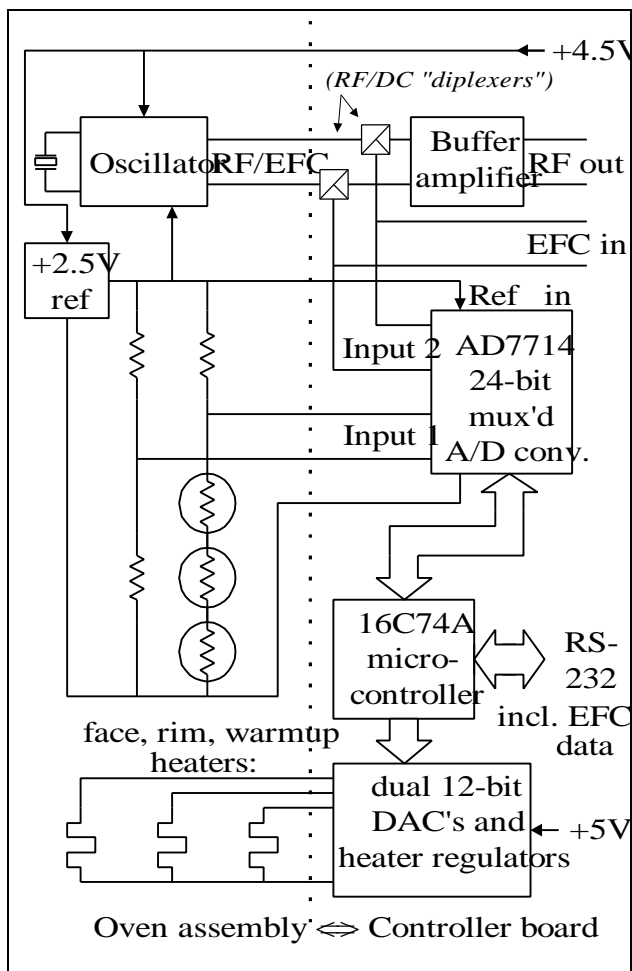

Figure 4. Block diagram.

The buffer amplifier has an auxiliary output that is converted to a 5V P-P square wave to act as a clock for the microcontroller. An interesting feature of this is that

the microcontroller has a watchdog timer that causes it to go into a failsafe mode if there is no clock, which will be the case if the oscillator has no output. The oscillator board contains an overtemperature sensor independent of the thermistor bridge that shuts off the oscillator if the oven temperature exceeds a safe value. This causes the watchdog timer to detect loss of clock and do a hardware reset of the oven heater DACs, shutting off the oven heat. Hence most possible causes of oven runaway are eliminated.

The EFC for the oscillator is multiplexed with the RF output lines to reduce the number of feedthrough and connector pins. The EFC voltage is monitored differentially by the second multiplexed input of the A/D converter. Between thermistor bridge voltage conversions, the A/D switches to the EFC lines and digitizes the EFC voltage. The EFC data is fed back to the controller for the EFC DAC (not shown) to correct DAC errors. Otherwise it would have been necessary to ovenize the DAC to avoid degrading the temperature stability of the complete system. Since the A/D converter is running from an ovenized reference and has autozero and autocal capabilities, it is far more stable than any DAC.

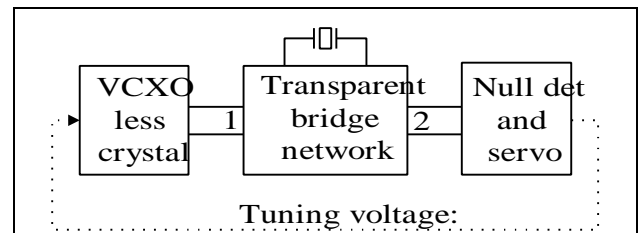

Figure 5. Balanced bridge controlled oscillator.

Balanced-bridge controlled oscillator circuit

In order to guarantee that the tempco of the oscillator is determined principally by the crystal, with negligible contribution from the temperature sensitivity of the oscillator circuitry, a new type of oscillator circuit was developed with about two orders of magnitude less temperature sensitivity than conventional circuits. The key aspect of this oscillator is a balanced-bridge developed especially for this oscillator.² The bridge acts as a network analyzer of sorts by balancing only when the frequency of the oscillator is at the series resonance of

² Patent pending.

the crystal, as modified by the EFC diode. An automatic frequency control (AFC) circuit tunes the oscillator as necessary to maintain bridge balance (fig 5). Hence the bridge is virtually the only temperature sensitive section in the oscillator, and it uses only low tempco components, with the exception of the EFC diode. The EFC diode is installed in a notch in the crystal well, where the thermal gain is very high. The bridge oscillator circuit is also an enabling technology for an ALC circuit with greatly improved temperature stability.³ This is important because non-linearities inherent in quartz cause the resonant frequency to be very sensitive to crystal drive current. Further details of the bridge oscillator and ALC circuit are described in [1].

Oven temperature controller

The oven temperature control loop is implemented digitally. The advantages of digital control over analog are numerous, some of which include:

- 1) Infinite loop gain is available at DC.
- 2) Loop parameters and temperature setpoint are adjustable in software.
- 3) Various operating parameters of the loop can be transmitted serially to a monitoring device.

The loop may be opened or closed via a keyboard selection over the serial port.

An advantage for the specific case of a digital oven control loop for a crystal oscillator is that the loop can be commanded to change the temperature a specific amount and for a specific amount of time, thereby allowing a search to be conducted for the crystal's zero temperature coefficient point. For the case of relatively slow loops, such as oven controllers, the ability to dither the output of an inexpensive DAC permits higher resolution to be obtained from a wide selection of commercially available components. Also, none of the loop components is required to operate at or near its limit of clock speed, thereby avoiding performance problems often seen in high speed digital applications.

A disadvantage in the final product is the addition of digital noise not seen in analog loops. A disadvantage in the development of the control loop is the

requirement of a software development system and the cost associated with the software writing/debugging effort.

Controller block diagram

A block diagram of the oven control loop is shown in fig. 4. The temperature of the oven mass to be controlled is sensed by three thermistors in a conventional bridge circuit. The three thermistors are spaced equally around the circumference of the metal chamber in which the crystal is contained and are approximately coplanar with the position of the quartz crystal blank. The crystal attains the average temperature of the three series connected thermistors if there are no radial gradients. One way to improve the temperature sensing technique would be to place thermistors both above and below the plane containing the three thermistors. We were not able to do this due to physical constraints on the height of the overall oven mass. The 2.5V low-noise reference voltage driving the bridge is also used as the reference for the 24-bit A/D converter that measures the bridge output voltage, thus implementing a ratiometric measurement. The reference needs to be a low-noise variety as it is also used in some applications to provide a reference for the oscillator's EFC circuit.

The most critical element in determining the final performance of the oven loop is the 24-bit A/D converter that digitizes the output of the thermistor bridge circuit. The mode in which the device is operated yields a resolution of 22 effective bits or a temperature resolution of $30 \mu\text{C} / \text{bit}$. An important feature of this converter is its ability to perform a full calibration at each sample time. Both a full-scale and a zero-scale calibration are performed just prior to each sampling of the thermistor bridge, which essentially removes any temperature effects of the conversion process. Thorough testing has shown that the error due to temperature variation applied to the A/D converter is far below the background noise in the oven loop. The converter has the capacity to digitize three differential input channels, leaving two spare channels in addition to the oven bridge input. In one application, the oscillator's EFC voltage, obtained externally, is digitized by one of the A/D converter's spare channels. This 24-bit conversion, using the oscillator's ovenized reference as the converter's reference, is used in a correction loop to ensure stable, accurate EFC voltage for the oscillator. The serial 24-bit

³ Patent pending.

oven bridge data is read by the microcontroller and is applied as the input data to the PID control algorithm described below.

A modified PID (Proportional-Integral-Derivative) approach was used to develop the control loop. This technique provides infinite gain at DC due to the integral term and fast response to a transient stimulus due to the derivative term. The modification to the standard PID algorithm was the addition of a double integrator term. This term removes the temperature offset present in a conventional PID loop when there is a ramp in ambient temperature. The resulting oven gain and transient response of this control loop easily met our expectations, without the addition of other compensating terms, such as those utilizing feedforward techniques. The P,I,I²,D algorithm results in less program memory space being used in the microcontroller than other, more complex implementations, such as state-space control.

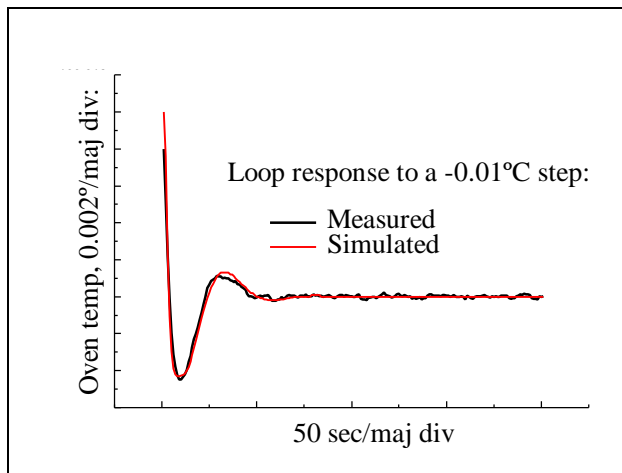

Figure 6. Oven transient response to set point step.

The sample rate of the loop is approximately 30 times faster than the loop bandwidth, which means that digital approximations to analog design equations work well. The goal of the loop design was to minimize the amount of time it takes the oven to recover from a change in ambient temperature without causing a large amount of overshoot or ringing in the response to such a stimulus. In order to facilitate selection of P,I,I², and D coefficients, a BASIC program was written that simulates both the analog and digital performance of the plant and loop filter. The thermal capacity of the plant (crystal oven), the thermal resistance of the oven insulation, and

the time delay in the thermal response of the bridge thermistors were measured in the laboratory and used in the BASIC computer model. Additional delays were used to model thermal diffusion through the copper oven mass. The simulation permitted rapid determination of the required loop filter coefficients and subsequent experimentation proved the model to be a valid predictor of actual oven performance. Figure 6 shows the results of the loop responding to a step in the oven setpoint, both simulated and experimental. There are no free parameters in the simulation and the agreement between simulated and actual performance shows that the model is quite accurate.

Other tasks that must be performed by the firmware in the microcontroller include RS-232 I/O implementation, a square-root algorithm, and dithering of the loop output DAC. All communication to and from the microcontroller is done via the RS-232 standard. Examples of this communication are the ability to change the oven setpoint and all of the P,I,I²,D coefficients, as well as transmission of each thermistor bridge data conversion sample, its error from the setpoint temperature, and the resulting loop filter output value. The calculation of filter output value per sample is done for oven heater power. However, the actual output to the heaters is a voltage, not power, so a square-root must be taken in order to express the loop filter value correctly to the output DAC. The DAC is a 12-bit resolution device, but the resolution necessary in the loop to control the oven properly to the level of “temperature noise” commensurate with our design goals is 18 bits. The microcontroller firmware accomplishes this increase in resolution by dithering the DAC output.

The oven control loop is sampled approximately once per second. The output DAC dithering is accomplished by updating the DAC at a rate of 256 times per second. If the dithering algorithm changes the output serial stream to the 12-bit DAC by one bit, only once out of the 256 times the DAC is updated per second, then the resolution of the DAC has been increased by 256:1 or an additional eight bits.

The physical limitations that restricted the oven package design caused its shape to be cylindrical rather than the ideal spherical shape. The crystal is placed in the center of the oven with radial symmetry being maintained in all dimensions. In order to approximate the

ideal condition where the mass can be heated uniformly, as in the spherical case, there are heaters placed on the top and bottom of the cylinder, as well as around its rim. A development technique used during the design of the oven was to have two DACs, one to drive the rim heater and the other to drive the parallel connection of the heaters on the top and bottom of the cylinder. This technique allowed the voltage applied to each set of heaters to be adjusted individually, which meant the power to each area of the cylinder could be “tuned” to compensate for the non-ideal cylindrical heat loss from the mass. With 18-bit resolution in the DACs driving the heaters, the ratio between the rim and top/bottom heaters could be adjusted to yield an oven gain of several million. The fact that this level of oven gain can be maintained as the ambient temperature is varied over a range of 150°C is evidence that the digital control loop is contributing very little to the overall system error. When the proper heat distribution was determined, the heater resistance was changed so that both heater assemblies (top/bottom and rim) could be driven from one DAC, thereby simplifying and reducing the cost of the control loop.

The amount of power and the ratio of power between the rim and the top/bottom heaters must be precisely maintained in order to preserve the high oven gain. The oven controller circuitry and layout are not necessarily unique, as each customer application of the oscillator may require a slightly different form factor for the combination oven mass and controller, and possibly different input/output configurations. To maintain consistent power and power ratio to the heaters under these varying conditions, and to remove effects of varying connector pin resistance, the heaters are sensed remotely. This is accomplished by having extra traces on the flexible heaters to sense both the voltage input and return lines directly on the oven mass. There is also a warmup heater trace on the top/bottom heaters that can be switched fully on or off to decrease warmup time. This heater trace is not used during normal operation at the oven setpoint temperature.

Measured oven performance

Figure 7 shows the measured oven temperature response to a 50°C step in ambient temperature with a fast rise time of 10°C/min. This translates into a transient thermal gain of 33,000 and a steady state thermal

gain of 500,000. The maximum transient error is only 0.0015° C and the steady state error is less than 100 μ°C.

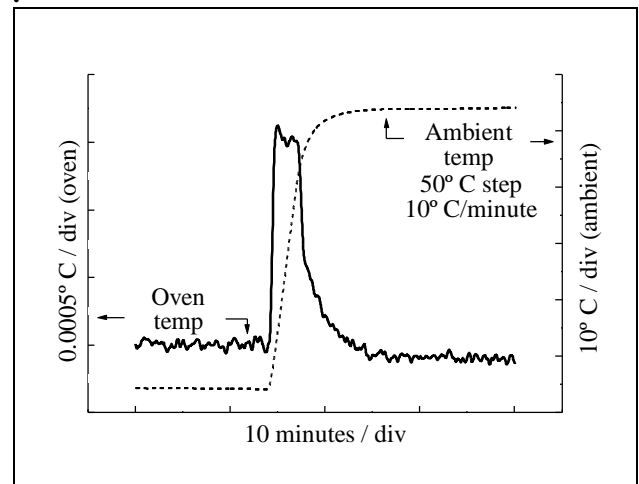

Figure 7. Oven transient response to ambient step.

Error Sources

The 24-bit A/D converter is configured such that its contribution to the residual thermal noise in the loop is at the level of about 20 μ°C, RMS. This contribution is primarily due to semiconductor device noise in the converter’s modulator. The actual loop noise referred to the input of the converter in terms of temperature is about 200 μ°C, RMS. There are two major contributors to this noise. The first is the fact that each input from the thermistor bridge to the differential input of the A/D converter is sampled at a slightly different time. The sample rate is 20 kHz at the input which makes the inputs pseudo-differential and can cause an error compared to simultaneous sampling, if there is noise. The second is the error due to the non-ideal ratiometric sampling that occurs because the 2.5V reference is very tightly coupled to the thermistor bridge, but the path from the reference voltage in the oven mass to the controller printed circuit board is longer and is subject to noise pickup from the immediate environment and the controller board itself.

Oven mass design for zero gradient operation

The oven controller does a nearly perfect job of keeping the temperature of the thermistors constant. To what extent this translates into high thermal gain for the crystal, EFC diode and oscillator circuit depends on the

degree of minimization of the thermal gradients between them and the thermistors. A heating technique rarely seen outside the laboratory is used consisting of covering the entire surface of the oven mass with distributed heaters [2]. The heaters are designed to supply just enough heat at each point on the oven mass to replace the heat that leaks out from that point through the insulation to the outside environment. Hence each point on the heater pulls its own weight, so to speak, without subsidizing or being subsidized by any other point. To the extent this is realized, areas of heat flow through the oven mass are eliminated along with their corresponding gradients. The highly thermally conductive outer can ensures that the heat loss distribution is not changed appreciably by environmental effects.

The crystal

A crystal used in a current production OCXO was modified for the oscillator described in this paper by redesigning the package to remove as much excess height as possible, resulting in a finished height of about 5 mm. or a little more than a quarter of the total height. The third-overtone SC cut crystal in the redesigned package is plated for series resonance at 10 MHz to be compatible with the oscillator circuit described below. The crystal is operated at its upper turnover temperature to allow sufficient headroom to realize a +85 °C ambient operating temperature.

Control of temperature induced aging effects

Temperature induced aging effects have recently received a lot of visibility with the advent of GPS timing receivers that attempt to predict and remove aging. These effects show up as a change in the rate, and possibly direction of, aging when the ambient temperature changes. Fig. 8 shows a purchased oscillator that exhibits this problem. There are two known sources of these effects, one due to the crystal and the other due to the oscillator circuit.

Crystal induced temperature/aging effects can occur due to insufficient oven gain at the crystal because changes in quartz resonator temperature can affect aging. In some oscillator designs, an attempt to overcome insufficient oven gain is made by operating the crystal at a turnover temperature and/or temperature compensating it by offsetting the EFC, as in a TCXO. While these techniques can fix the static tempco, they have no effect on

temperature/aging effects, and, in fact, can make them even worse. In the oscillator described in this paper, the oven gain at the crystal is simply so high that these effects are not measurable.

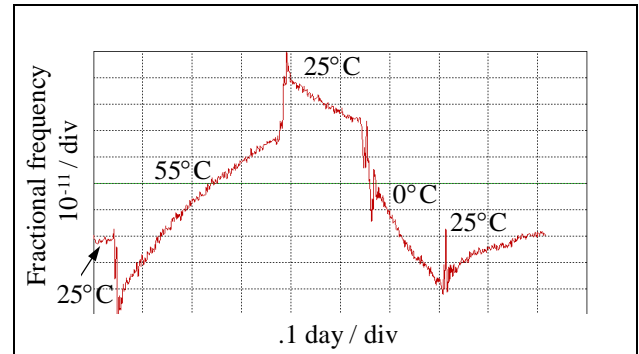

Figure 8. Temperature induced aging (purchased oscillator).

Oscillator circuit induced temperature/aging effects are not as well understood, but seem to be related to temperature gradients within the hermetic envelope volume of the oscillator. In conventional oscillators, the outer can is the hermetic envelope. This can operates at a small temperature rise above ambient, hence at low ambient temperatures there is a large temperature gradient across the thermal insulation. It appears that there is some sort of mass transport mechanism, probably involving water, that is dependent on this gradient. Perhaps water condenses out on the inner surface of a cold outer can. The hallmark of this phenomenon is that the effect goes away if the hermetic seal is broken to allow access to ambient air [3].

In this oscillator, the oven mass itself is hermetic. Since the oven mass is isothermal to within millidegrees, there is no opportunity for temperature gradients to cause this effect, whatever its mechanism. Also, this allows the outer can to be non-hermetic, which permits it to be made of light gauge copper without any risk of explosion at high altitudes.

Tempco budget

To design the oscillator for good overall tempco, three different issues must be addressed. Oscillator circuit tempco, oven temperature controller error, and oven mass gradient error. The oscillator circuit used here has a tempco of about $10^{-11}/^{\circ}\text{C}$, not including the EFC diode. An easily achieved thermal gain of 250 with respect to

the oscillator circuit will result in a tempco contribution of only 5×10^{-12} over the entire -40 to $+85^\circ\text{C}$ range.

However, the EFC diode has yet to be considered. Most tuning diodes have tempcos in the hundreds of $\text{ppm}/^\circ\text{C}$, the lowest being around $100 \text{ ppm}/^\circ\text{C}$ and the highest being around $1000 \text{ ppm}/^\circ\text{C}$. Some diodes have lower tempcos at higher voltages, many do not. There are many constraints on the choice of tuning diode, hence it is not necessarily possible simply to use the one with the lowest tempco. The ppm numbers quoted above refer to capacitance. Capacitance has a complicated relationship to frequency that depends on the total tuning range of the EFC and the deviation from series resonance. The best situation, which is the case in this oscillator, is to operate very close to series resonance, and provide only enough tuning range to account for aging, not using the EFC diode to take up calibration errors in the crystal frequency. It is also helpful to have a low long term aging rate such as the $10^{-8}/\text{year}$ figure for this oscillator. This allows the use of a $\pm 5 \text{ Hz}$ EFC range, which translates into a frequency change of about $10 \mu\text{Hz}$ for a 1 ppm change in EFC varactor capacitance. With a $500 \text{ ppm}/^\circ\text{C}$ EFC varactor, this results in a tempco of $0.005 \text{ Hz}/^\circ\text{C}$ or in fractional terms $5 \times 10^{-10}/^\circ\text{C}$. A thermal gain of $10,000$ at the varactor would result in a tempco contribution of 6×10^{-12} . In the oven described here, the thermal gain at the varactor is believed to be at least as high as it is at the crystal.

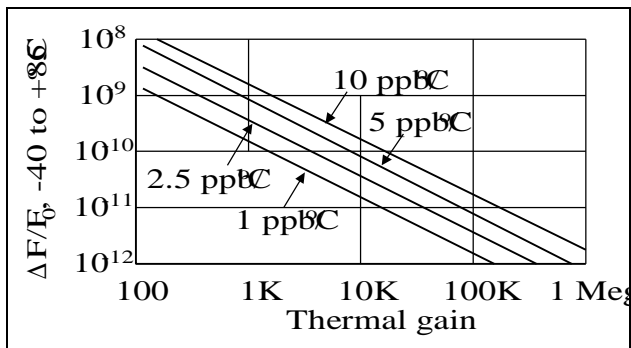

Figure 9. Frequency error budget tradeoffs.

A related issue to this is the required stability of the source driving the EFC line. By keeping the range at just 10 Hz , the tuning sensitivity is reduced to about 2 Hz/volt . Even at this low sensitivity, the EFC voltage must be stable within $25 \mu\text{volts}$ to hold the error down to $50 \mu\text{Hz}$, which is 5×10^{-12} . For an EFC voltage of 2.5V ,

$50 \mu\text{Hz}$ is 125 ppm . Over the temperature range of -40 to $+85^\circ\text{C}$, this is equivalent to less than $1 \text{ ppm}/^\circ\text{C}$. This level of stability is virtually impossible to achieve without an ovenized reference. In this oscillator, the reference on the oscillator board is freely available for this use.

Finally, and most importantly, there is the issue of crystal tempco. Fig 9 shows the relationship between crystal tempco, deviation from turnover temperature, thermal gain at the crystal, and resulting temperature stability over -40 to $+85^\circ\text{C}$ ambient. Various tradeoffs can be made among these parameters. For example, if crystals are available with turnover temperatures in the right range, the oven set point can be adjusted on each oscillator to coincide with the turnover. If this can be done to an accuracy of ± 1 degree, which is not difficult, then a crystal thermal gain of $10,000$ will result in a temperature stability of 7×10^{-11} . Together with the previously discussed portions of the error budget, this results in a design that will do better than 10^{-10} over the entire range. Another factor of 2 or 3 reduction in crystal tempco is reasonable by setting the oven set point more accurately at the turnover. This improves the stability to a few parts in 10^{11} . Alternately, more effort can be put into more accurately setting the thermal ratio on the zero gradient oven to boost the thermal gain to $100,000$ or more. With precision setting to the turnover, this further improves the temperature stability to a nearly unmeasurable level of parts in 10^{12} . Alternately, lower precision crystals can be used away from the turnover temperature. For example, with a thermal gain of $100,000$, a 15° difference between the set point and turnover results in a temperature stability of 10^{-10} .

Measured oscillator performance

Fig. 10 shows a frequency vs time/temperature plot of a typical oscillator. Fig. 11 shows the performance for a 90% change in relative humidity at 65°C . Since the oscillator itself is hermetic, this is mainly a test of the humidity effects on the exposed temperature controller circuitry, especially the accuracy of the A/D conversion. This test shows that the controller not only works under these adverse conditions, but contributes only a small error.

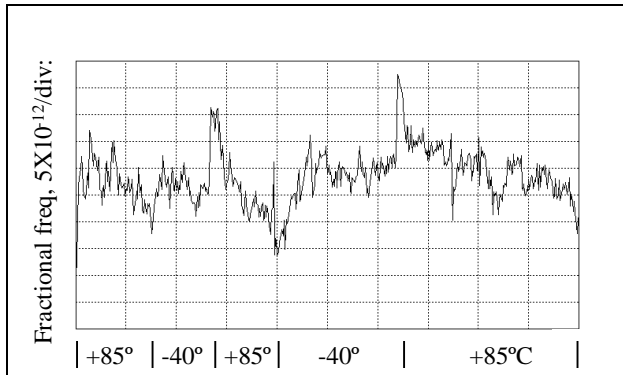

Figure 10. Tempo of complete oscillator/controller.

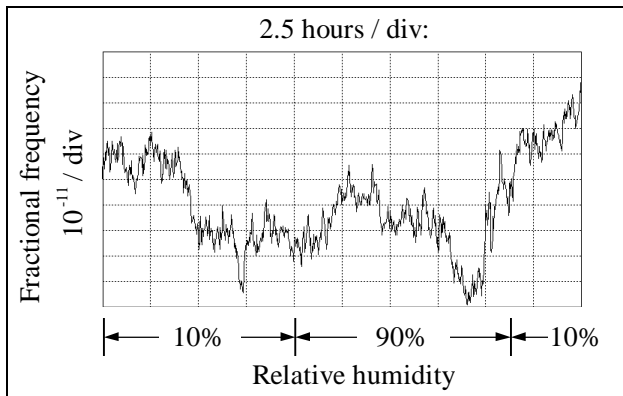

Figure 11. Humidity effects on oscillator/controller

Conclusions

The performance of this oven consistently yields an oven gain in excess of 100,000, with an initial overshoot in oven temperature of less than $.002^{\circ}\text{C}$ while the ambient temperature is being ramped at the level of $8^{\circ}\text{C}/\text{min}$. The double integrator feature of the controller algorithm prevents an oven temperature offset (after initial overshoot) while the ambient temperature is ramping. The low temperature coefficient of the crystal oscillator circuit combined with the high thermal gain of the oven produce a final product with a frequency change of less than 10^{-11} over an ambient temperature excursion of 125°C .

Appendix: linear oven regulator efficiency

This oscillator is heated by resistive heating elements (flex-circuits) controlled by linear pass-transistor regulators. These were widely used from the dawn of the transistor era until about 30 years ago when

they became “obsolete due to obvious inefficiency.” They were replaced by switching regulators controlling resistive heaters. These, in turn, were “superseded” about 20 years ago by the even more efficient (~100%) method of directly heating the oven from the collector dissipation of transistors thermally attached to the oven mass. In this oscillator, all three techniques were investigated as possible candidates for the oven heating system before the decision was made to use a linear regulator in contradiction to the conventional wisdom. It turns out, when all the tradeoffs are examined, that linear regulators are a viable alternative to the other two techniques, even when efficiency is considered. An additional consideration with this oscillator is that a zero gradient oven with distributed direct transistor heating would be virtually non-manufacturable.

Before discussing the specific methods, it is necessary to understand the context in which efficiency is defined, and why it is an issue. First, it is necessary to unlearn the tradeoffs between linear and switching regulators as they apply to conventional power supplies. In power supplies, the input voltage typically varies over a moderate range due to AC line variations or battery condition, and the output voltage is fixed. The load is a current sink, independent of input voltage. The range of the load currents is typically specified with a maximum and minimum, with a ratio of 4:1 or less. It is often necessary to provide input/output isolation. With these constraints, the tradeoffs usually greatly favor the switching regulator. In contrast, ovens often run from fixed input voltages; the oscillator described in this paper operates from $+5\text{V} \pm 5\%$.⁴ The load is resistive (except for the directly heated case), and the output voltage must be varied from zero power through maximum sustaining power (for minimum ambient) and up to warmup power. These different conditions result in different tradeoffs. For example, the zero load-current requirement is problematical for most switching regulator designs. Also, the RFI generated by switchers is more detrimental in an OCXO than most other applications.

⁴ It should be noted that many switching heater supplies historically were required to operate on a wide range of input voltages, in which case they have a substantial advantage over linear regulators.

Efficiency impacts (1) power supply capacity requirements, (2) active device thermal stress, and (3) thermal overhead contributed to the target system (particularly at high ambient). Regarding criterion (1): The worst case power supply current flows during warmup. The direct heating method, being nearly 100% efficient, minimizes supply current. However, the linear regulator is also nearly 100% efficient during warmup because the pass transistor is in saturation. This is possible as long as the input voltage and warmup current are nominally fixed. On the other hand, the switching regulator efficiency will be at its maximum-load value, perhaps 80%, calling for 25% more input power than the other schemes. Hence for criterion (1), the direct heating and linear regulator methods are winners, and the switching method is suboptimal.

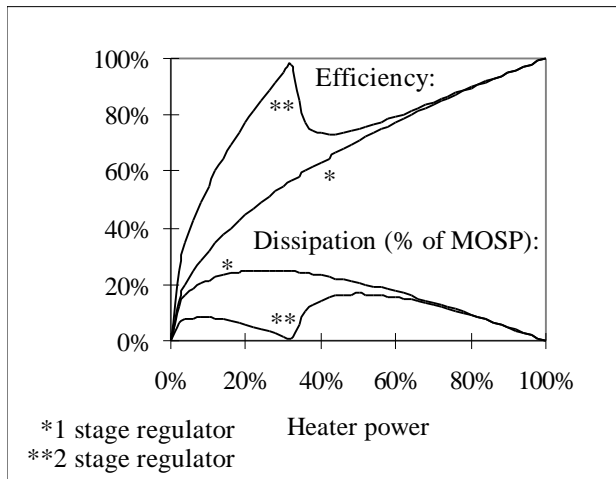

Figure 12. Characteristics of oven regulators.

Regarding criterion (2): The direct heating method is the clear loser here. The active devices are operated continuously at the oven set point temperature, which is always higher than the highest ambient temperature. At minimum ambient temperature, the active device dissipation equals 100% of the maximum oven sustaining power (MOSP). This results in a combination of maximum power dissipation and maximum temperature. Because of packaging constraints related to attaching to the oven mass, there is usually a substantial junction temperature rise above the oven set point, exacerbating the problem. Furthermore, the stress will be considerably higher than even the worst case stated

above during warmup just before reaching the set point, unless a tapered warmup power curve is utilized.

In the switching case, the worst case dissipation occurs during warmup, and is given by:

$$\text{dissipation} = (\text{warmup power}) \cdot (100\% - \text{efficiency})$$

If warmup power is 120% of MOSP and the switcher has an efficiency of 80%, the worst case switcher dissipation will be 24% of MOSP. Of course, if fast warmup is needed, this number will be considerably higher. Other than warmup, the worst case dissipation would be only 20% of MOSP, and this would occur at low ambient, which reduces the stress.

The efficiency and dissipation for a linear regulator is shown in figure 12 (single stage curves). As noted above, the efficiency is ~100% at warmup, where both the warmup heater and the operational heaters are fully on. It is also ~100% when the heater power is at 100% of MOSP. As ambient rises from its minimum, the efficiency drops following a square root law. However, the amount of power processed also drops as ambient increases resulting in a broad maximum of about 25% of MOSP. Thus the maximum dissipation in the linear regulator is about the same as for the switcher, although it occurs at a higher ambient temperature, so the stress on the active device is somewhat higher. However, a two stage heater approach can be used to reduce this. In the two stage heater scheme, there are two heater resistances co-located on the oven mass, controlled by separate transistors. The resistances are chosen so that one dissipates 33% of MOSP at 5V and the other dissipates 67% of MOSP at 5V. The lower power heater is used at high ambients where less than 33% of MOSP is required. For lower ambients, the lower power heater is fixed at full power (i.e. 5V) and the higher power heater is used to vary the power. This results in an efficiency of over 75% over 80% of the range, and dissipation peaks of 8% of MOSP at high ambient and 17% of MOSP at lower ambient. The conclusion is that with respect to criterion (2), the double stage linear regulator is best, followed closely by the switching regulator and the single stage linear regulator. All of the above operate with vastly lower stress than direct heating transistors.

Regarding criterion (3): the directly heated oven is clearly best, since no additional heat load is added. However, the two stage linear regulator adds

additional heat of only 8% of MOSP at high ambient. If the system design can accommodate 100% of MOSP at low ambient, it is highly likely to be able to withstand 8% of MOSP even at maximum ambient. A switcher might do better than a linear regulator if its efficiency holds up at low output power, but this is difficult to achieve in practical switchers.

Summarizing the above, it can be seen that the linear regulator is the overall method of choice, based on power supply current, active device stress, manufacturability, freedom from RFI, and thermal overhead.

Acknowledgments

On the controller board, Len Cutler developed the PII²D algorithm and the simulation software, Darius Mostowfi and Matt Semersky wrote the PIC firmware to implement it, Jim Johnson and Eric Ingman designed the circuitry, and Robin Giffard contributed to the characterization of the A/D converter. The thermal and mechanical design of the zero gradient oven was a group effort by all the co-authors of this paper plus Robin Giffard and Jim Collin, who was also the original project manager. The bridge oscillator was designed by Rick Karlquist. The mechanical design implementation was by Theo Parisek. The flex circuits were designed by Rick Karlquist and Theo Parisek. Lee Cosart wrote the test and analysis software. Advice on crystal technology was given by Jack Kusters and Charles Adams, who was also the final project manager. The new crystal packaging was developed by Jim Collin, Cathie Sousa, and Rick Sarica. Steve Kong developed some manufacturing processes such as the thermal insulation. Hagop Stephanian is the production engineer.

References

- [1] R. K. Karlquist, "A New Type of Balanced-Bridge Controlled Oscillator," Proceedings of the 1997 IEEE International Frequency Control Symposium.
- [2] R. K. Karlquist, et al, "The Theory of Zero Gradient Ovens," Proceedings of the 1997 IEEE International Frequency Control Symposium.
- [3] D.Chu and S. Kong, Hewlett-Packard Company, private communication.