

A MATHEMATICAL MODEL OF THE
BRIQUETTE INDUSTRY IN VICTORIA

S. E. Blanch, N. J. Henderson & K. W. Laing.

State Electricity Commission of Victoria, Melbourne, Australia.

Introductory Summary

This paper describes how a business model is created and used. In particular it focuses attention on a model which has been developed to represent a typical business comprising production, storage, distribution and demand in a competitive environment.

It describes the situation of the briquette industry in Victoria. The paper is presented not only to illustrate one successful and valuable application, but also to indicate the powerful nature of mathematical models and the way in which all businesses can be so represented. The example used in this paper to highlight the various aspects of model buildings fits into an emerging pattern of quantitative studies which are contributing toward the preparation of investment decisions by the State Electricity Commission of Victoria.

The paper is presented in the following way :

Section 1 describes the dependence of the economic and business activities of the industry upon the physical, technical and social factors.

Section 2 presents a family of models and outlines the reason for selecting a particular form of model to represent the business.

Section 3 summarises the rationale behind the model, then a detailed account of the model itself is given in Section 4.

Section 5 brings together all the components of the model into a coherent whole under the appropriate title of the logistic system.

Section 6 details the major benefits and the effectiveness of the model and discusses its role as a management tool in decision making.

1. The Business

Apart from its primary objective to generate and supply electricity, the State Electricity Commission of Victoria was also legislated to produce, distribute and sell briquettes* to the primary fuel and raw material markets. Whilst initially serving a purpose of decreasing the State's dependence upon the then sporadic availability of fuel imports, the briquette industry today provides an industrial carbon of unique properties, a cheap form of fuel for various markets and contributes to a highly competitive primary energy situation for the State. The fuel used in the Victorian domestic and industrial markets for the period 1963/64 to 1968/69 is listed in Tables 1 and 2 respectively.

* The Morwell factories produce brown coal briquettes at the rate of over two-and-a-half tons a minute, night and day, seven days a week. On average, production is about two-thirds the industrial type of briquette (L) and about one-third domestic (H).

To maintain this output, the factories process annually more than three million tons of raw brown coal in a continuous flow from moist coal in its crude state to the finished briquettes.

The raw brown coal used for the manufacture of briquettes has approximately a two-thirds moisture content. Untreated, it breaks up easily during handling, weathers quickly, and for effective use requires to be burned in special furnaces.

The purpose of briquetting is to convert low-grade raw brown coal into a high-quality fuel that possesses uniform characteristics and can be economically transported for use elsewhere. The moisture content is reduced to approximately 15 per cent, thus more than trebling the heating value per pound of fuel. At the same time, the coal is converted into hard, durable blocks of compressed fuel that can be easily stored and handled.

The share of the energy market supplied by briquettes gives some indication of its potential to affect relative fuel prices throughout the State.

The price of a particular fuel is an important determinant which governs its market share and revenue from sales. Volume of sales in turn determines the cost of production and thus net earnings. In this situation it is clear that the lowest priced fuel will command what is known as the pure "economic" buyers. The higher priced fuels rely on the more intangible benefits of their product to offset the price differential and so they attract those buyers more predisposed to attributes other than price. The higher the level of relative prices then *prima facie* the larger the number of pure economic buyers.

In this way briquettes retain some measure of influence on the price levels in the fuel market which is ultimately to the benefit of the consumer body as a whole. However, this influence is entirely dependent upon retaining the position of the lowest priced fuel in the State. Cost escalation tends to erode the earning base, thus placing management under continual pressure to maintain a rate of return on investment in the face of intense competition.

Upon appraising the various aspects of the industry it became obvious that its complexities made the adequate understanding of the business extremely difficult. Despite this complexity decisions had to be made concerning what role the briquette industry was to play in future years and the deployment of resources over those years which would maximise earnings. This was precisely a situation where the mathematical model could contribute uniquely in assisting management insight and appreciation to an otherwise intractable situation.

However, before outlining those aspects leading up to the development of the model it may be useful to have a general picture of the briquette industry. Figure 1 below is a diagrammatic representation.

The figure is divided into the classical areas of raw material acquisition, production, storage, distribution and demand. In the development of any and all models it is the accurate replication of the elemental building blocks which provides the foundation upon which validity of the total model rests. The functional areas listed above were selected for this study as

appropriate elements.

The decisions which faced management (and led to the development of the model) involved risk, uncertainty and variability. In the long term the questions were:

- (a) For what period of time would the industry contribute to the well-being of the consumer body as a whole?
- (b) What would be the industry's earnings over any period?

In the short term the questions were of more immediate consequence:

- (c) Should one or two production complexes be operated?
- (d) Were modifications to plant necessary?
- (e) Was the handling equipment of sufficient capacity?
- (f) Were adequate storages available and were these storages located in the best places?
- (g) Were the channels of distribution the most suitable and the distribution facilities adequate in various situations?
- (h) Were the price levels to the various markets appropriately set giving due regard to customer equity, total consumer benefit and the viability of the industry?

Through the medium of the model, answers to these questions could be obtained. The answers in all cases were expressed in marginal and average terms and used in each strategy evaluation where appropriate.

2. The Selection of a Suitable Model

The way in which uncertainty pervades the whole business (and therefore pervades a model replication) limits the use of direct optimising models, e.g., linear programming (LP), queuing models, inventory models, etc. For example, in the briquette industry to search for a long term strategy, the dynamic nature of the business must be known or estimated. An LP that does this but treats uncertainty aspects by simply using average values is not likely to yield a good strategy especially where the interactions between hourly events are critical in the performance of the industry.

By contrast, dynamic programming models can analyse problems to be evaluated over consecutive periods which contain uncertainties. However, dynamic programming in practice can treat only drastically simplified systems for unless the system is characterised by only a few state variables, the computational task of solving a dynamic programming model is beyond the capacity of most computers in use. This limitation is applied in an even more stringent way for dynamic probabilistic models.

The combined effect of uncertainty and risk, the interactions between decisions and subsequent events, the complex interdependencies among the variables of the business and the need to look at hourly events makes the total system problem too big and too intricate to handle by methods outlined above. The best operational research approach in these circumstances is the digital computer simulation.

In this method the uncertainties, decision interactions and interdependencies are formulated and written into a computer program. The simulation of the business begins at a specified starting state and the combined effects of decisions, predetermined and random events cause the system to move to another state. Dependent upon the particular system there will be an optimum time interval between successive states. To span the total period being simulated it is necessary to monitor and modify many consecutive states.

To obtain sufficient statistical accuracy for reliable decisions a considerable number of simulation runs are usually necessary. However, once a basis is established for a given set of input parameters, it is possible to evaluate the effect of a change of any one parameter by holding all others constant and repeating the simulation process.

The briquette industry simulation model provides management with a systematic approach to decision making, a way which is clearly more desirable than the alternative intuitive "analysis".

3. Macrostructure

The structure of the simulation model representing the briquette industry is conveniently described in terms of its dynamic functions and its entities. The dynamic functions are a set of decision rules which are typically expressed as:

What will happen to A if B occurs? These rules are the formalisation of events as they occur in practice. In many studies rules cannot be changed, in this exercise however the model was sufficiently flexible to permit rule manipulation and hence determine the optimal way (within the practical constraints) in which the industry should be run.

The entities of the briquette industry are the previously defined building blocks of production, storage, distribution and demand. Building blocks are composed of many attributes, e.g., consumer behaviour, plant throughput, equipment capability, coal quality, etc. Each of these attributes is ascribed a mean value and a variability. The mean value describes the average performance of the attribute whilst the variability indicates the way in which the attribute value varies in operation.

The complexity which results on putting together these building blocks arises in part from the number of blocks but mainly from the interdependencies of the various parts. Figure 2 illustrates the static framework which describes the structure of the briquette industry.

In Figure 2 the industry representation is shown in a static form, i.e., the time dimension has not been included. This introduces further complexities of even larger scale and is to be pursued later (Section 5). The figure is also depicted as a closed loop system with only three input values connecting this system to the environment. Although a rudimentary presentation, it permits the model to retain a significantly valid representation of the industry without becoming too large and thus losing the ability to obtain computable answers. For this reason it is also necessary to initially develop the model as time invariant, introducing the time dimension to the model after all the separate entities have been arranged as a total model. The full effect of the interactions within the model are then, and only then, realised.

4. Microstructure

Whilst the business in its total form essentially exhibits the state of a closed loop system (Figure 2), if more than a few variables exist it is extremely difficult to develop a model from the macrostructure. It is necessary to break the problem down to smaller elements (the entities) and analyse each

separately, building up a "block" for later synthesis to the total model. As the entities previously described have clearly defined boundaries they do constitute obvious areas for concentration. The macrostructure in Figure 2, is reproduced in Figure 3, indicating how a set of open loops (the building blocks) do form the closed loop of Figure 2.

It is perhaps a better representation, for those loops left open are in the main time-dependent and cannot function properly until the system is brought together as a coherent whole (Section 5). The remaining part of this section will concentrate on the detail of the development of each of the four building blocks.

4.1 Demand

Tables 1 and 2 indicate the type and size of the various markets. The demand in each market is clearly governed by different determinants. Each will be developed separately.

4.1.1. Domestic

Demand in the domestic market arises from the need for home heating and domestic hot water. The hot water load provides a base demand and the heating load the variable demand dependent upon the season. All domestic demand is satisfied through briquette distributors who hold virtually no stocks but order in anticipation of sales.

This set of circumstances allowed a forecasting model based on causality to be developed - the causal factor being that used by fuel merchants as "how cold it is" or more scientifically as used by the model as a function of temperature. Having established a rationale it was then necessary to compile the available statistics in a meaningful way. In terms of sales volume the briquette distributor's turnover is the aggregate of the purchases made by the end consumer. The daily consignment statistics to distributors were therefore used as the dependent variable after adjustments had been made to allow for the various preferences to have consignments placed at a rail siding on a particular day.

Several independent variables were processed by non-linear multi-regressional analysis to arrive at the best form of the forecasting model. (This form being dictated by the best level of significance of the dependent variable associated with least complexity of the model.) One independent variable, an

exponentially weighted function of temperature, was found to satisfy these requirements.

The following factors were used in or influenced the form of the model:

- * The living habits of the consumer population being normally distributed about a mean value of comfort.
- * 70°F is the criterion of comfort (in terms of temperature).
- * Weekly purchasing habits are a norm of consumer behaviour.
- * Purchases made over several weeks preceding the immediate purchase decision and the climate conditions expected in the future influence the magnitude of any purchase.

The equation expressing this behaviour was of the form -

$$Y = \frac{1}{A + BC^x}$$

Where Y represents the daily domestic demand of briquettes in tons;

$\frac{1}{A}$ represents the maximum daily demand;

B is a factor representing a learning curve effect of past and future climate on sales volume.

C is a factor representing the variability of consumer habits of the population

x represents the seven-day moving average of degree days based on temperature statistics of Melbourne.

The form of the domestic forecasting model is shown in Figure 4. The fundamental equation of relationship derived by least squares analysis revealed an acceptably low standard error of estimate, and a high degree of correlation between daily sales and the moving average of daily degree days.

4.1.2 Industrial

Demand in the industrial market arises from industrial heating and/or process steam requirements. It is dependent upon the cost of fuel, capital cost of plant, modification, operation and maintenance costs of plant. The industrial buyer is essentially an economic buyer.

Owing to the variety of ways in which each of the determinants listed

above could affect different customers, a general form, or model, satisfying each customer could be extremely cumbersome. A closer analysis revealed that 6% of customers accounted for 92% of industrial sales. Individual analysis of the customers in this group were carried out and their requirements for briquettes and susceptibility to competition determined. These demands were in terms of their mean value, the variability of their daily purchases being obtained from past records.

The last 8% of customers consuming whole briquettes were trended from records of past data using least squares analysis. Both mean values and daily variability were obtained.

Arising from the manufacture and handling of briquettes, a certain amount of wastage is obtained. Some of this wastage can be recirculated in the manufacturing process and rebriquetted. However, a large quantity must be either consumed by industry or used in the power stations.

The harvest of wastage was projected over the period of planning, sales were estimated to industry and the balance allocated to power stations. The variability associated with sales affected only the amounts going to the respective demand areas.

4.1.3 Char*

Char possesses unique properties as a source of industrial carbon of high purity. It is to be expected that a considerable demand will exist; however, as at present it is in the development phase, market performance is non-existent. In this situation market research is the only means of predicting future sales.

In the domestic forecasting model demand was associated with causality, i.e., a reason for purchasing was sought and demand was (statistically) associated with that reason. In the industrial forecasting model a type of adaptive model was used. A trend was obtained and modifications to this trend line were carried out taking into account the particular circumstances of each major consumer. To forecast the char market

* By carbonising briquettes with a closely controlled heating cycle, the volatile component of the fuel is removed, leaving a strong solid residue (char). This product possesses characteristics which are in high demand as an industrial carbon.

is far more difficult. Daily variability does not constitute the major problem as in the two methods above; it is the uncertainty that sales will eventuate.

In this situation market research provides the only means of gauging the future level of sales. Local and overseas markets were surveyed and intending manufacturers interviewed. Their plans (checked against market potentials) formed the basis of the forecast model for the char market. The continuous nature of the char making process eliminated any daily variability, although the expected level of sales contained a considerable degree of uncertainty.

Owing to the nature of its demand, however, the char market forecasts could be treated differently to the other forecasts. It affected only the level of production and not the daily variation. The level of sales was therefore used as a parameter in the simulation, not as a variable.

To each of these (static) models was superimposed a secular trend which was determined from consumer surveys and analyses of past statistics. This allowed the forecast models to predict forward any planning span required.

A flow diagram of the forecasting model for demand is shown in Figure 5.

4.2 Production

As the entire industry was presented in diagrammatic form earlier (Figure 1) a similar representation of the production entity to be modelled may also prove beneficial to the reader. Figure 6 represents the major functions within any of the factories.

The briquetting process takes about 3½ hours. After crushing and screening, fine, moist brown coal is passed through large, steam-heated, revolving drying drums to reduce its moisture content.

This dried coal is screened and the larger particles crushed. It is then cooled in special cooling houses.

Briquettes, extruded through forms, forced out from the presses along narrow troughs - known as launders - emerge in bars containing several briquettes joined together. As these bars reach the end of the launders, they are cut into separate briquettes.

Passage along launders and

conveyors allows the briquettes to cool off before being delivered into a specially ventilated storage shed or loaded into Victorian Railways trucks for despatch to other parts of the State. Briquettes for char making go direct to a processing source by belt conveyor.

Throughout this flow path 310 major items of plant are used. These plant are subject to various scheduled and unscheduled outages. In developing the production model all relevant statistics were assembled and the respective frequencies of particular plant downtime obtained. These are shown in Figures 7 & 8.

In addition, presses must be regularly taken out of service for retooling. The frequency of retooling is dependent upon form life, the variability of which is illustrated in Figure 9. In the program, press outage due to cascading of worn forms is avoided by continually seeking an optimal form life.

Apart from these constraints to plant operations the quantity and quality of the coal and steam affected production levels and the decisions arising from the applications of the rules. Their variability is shown in Figures 10 to 13.

In contrast to the uncertain environment of demand the production function could be quantified within stringent probability limits. This mathematical approach combined with a set of decision rules facilitated development of the production model.

The set of decision rules under which the factory operated (and therefore which governed the form of the model) centres about several factors of production. These were -

- * the daily moisture variation in the coal;
- * the quantity and quality of coal at each factory;
- * the quantity and quality of steam at each factory;
- * priority rating for type production;
- * drier breakdowns and outages;
- * plant breakdowns and outages;
- * press form life;
- * press outages;

- * routine maintenance programs;
- * plant shutdown;
- * industrial unrest.

Figure 14 illustrates the flow diagram of the production model.

4.3 Storage

The seasonality of demand for briquettes is shown in Figure 15. This seasonality imposes a necessity to hold stores or back-up production facilities. Owing to the cost escalating nature inherent in the production complex, storage presents the most economical way of augmenting production to match demand and supply.

Briquettes stored are of the industrial type owing to their greater resilience to weathering without a significant loss of quality. Storing industrial briquettes, however, introduces a production priority rating as the daily demand for domestic briquettes must be met ex-production. This multi-product situation serves to further complicate the interdependency between production and storage models.

Figure 16 shows the way in which production varies over the duration of one year due to operation procedures. The aggregate sales curve (from Figure 15) is also shown. The area lying between these two curves represents the major stock movements which are necessary to satisfy demand over the period. On any particular day, however, the daily balance of demand to supply determines what will be placed into or drawn from store. This aspect is discussed more fully in Section 5.

Storages located in the near vicinity of the production complex are clearly desirable. This follows from the cost of capital tied up in stocks at the manufacturing site being less than the cost of a similar quantity of briquettes at a site distant from the factory and the occasional inability of production to supply the local market at the works. However, some stock must be held at the market distant from the factory to cover contingencies which may arise from the distribution system. The size of the total holding is dependent upon the shortfall of production to demand over the winter period and the reliability of plant at that time.

The flow diagram of the storage model is shown below in Figure 17.

The model allowed the establishment of stringent control limits and priorities for placing and discharging from particular storage areas on a daily basis. In this way the optimal manipulation of storages was determined.

4.4 Distribution

From the loading sheds at Morwell, briquettes are consigned to private sidings and some 200 public rail sidings throughout the State. Briquette distributors take delivery from these sidings and supply and end consumer.

Using a transportation model the selection of the best use of sidings by particular briquette distributors was made. The transportation model is a deterministic model which searched for the optimal placement of briquette distributors. Supply to these sidings was dependent upon production, storage levels, equipment operation between the plant and outloading point, and the Victorian Railways facilities and timetable.

The available facilities of the VR imposed major constraints on a set of otherwise feasible alternative strategies. It constrained the optimal strategy because of several factors.

These were -

- * number of rail wagons available to the industry at any point in time and where these wagons are available;
- * turn-around time of rail wagons;
- * line capacity;
- * other VR business, e.g., wheat, super phosphate, etc.;
- * freight timetables;
- * locomotive availability;
- * siding capacities and daily variability.

The simulation was run with and without these constraints and at certain intermediate values to determine the best strategy to follow. The sensitivity of each of the constraints (above) was evaluated as was the cost of making each alternative workable given the particular constraint setting.

The flow diagram for the distribution model is shown in Figure 18.

5. The Logistic System

The concept of a logistic system is generally recognised. It implies the efficient management of the flow of materials and products from source to user. It has become accepted that there is a need to design and manage a business as a single unit rather than a series of discrete, independent functions.

This concept applied to the briquetting industry involves the integration of the four entities of demand, production, storage and distribution into an all-embracing form. This form is defined here as the logistic system and is represented by the briquette industry model.

The logistic system is time and event dependent. Any events occurring in entities which hitherto have been treated as disjoint from other entities clearly take on a new and more significant role. The situation is one where everything is dependent upon everything else constrained only by a set of working rules.

Integrating the time domain and the static model brings out the problem of evaluating and selecting the optimum time span between monitoring and modifying consecutive states in the simulation exercise. The optimum time span depends upon the particular event under study and the maximum length of time it may be ignored without significantly affecting the validity of the overall results, for example:

- (i) For the demand function the event must be looked at initially to allow production planning for the day and then modified when the actual orders are known. Two states of demand on any day are all that is required.
- (ii) For the production function the requirements are far more stringent. Owing to the large number of plant items and the inherent dependence of one item of plant on another, the state of the system can vary considerably over a short time span. For time spans in excess of one hour the effect of ignoring state changes becomes significant. Up to 24 states of production on any day must therefore be monitored. Other functions within the production entity, such as routine outages, do not require hourly observations. In such cases the period between subsequent

events of, say, a week, a month or a year, adequately describe the particular circumstance. This demonstrates the presence of many optimum time spaces within an entity. They are dependent upon the dynamic significance of the respective events.

- (iii) The variability of demand and of production on any day may require augmentation from, or dispatching to, storages. The event can occur at any time of the year, not only on occasions when seasonality is demanding a certain mode of operation. It is therefore necessary to monitor stores frequently throughout the day.
- (iv) The dependence of the whole works upon the collection conveyors and loading facilities points to the essential nature of their operation. Hourly events are clearly significant. This part of the distribution function is looked at on an hourly basis. In contrast, the VR empty wagon supply is evaluated only once per day, as are the fixed aspects of freight timetable, daily siding usage and wagon turn-round time.

Once time has been brought into the framework of the model, the resulting form assumes a dynamic character. Interdependencies between variables are then further influenced by interactions between events of a time period and the events that precede and follow it. Uncertainty and variability which permeate through the entire model bring out a degree of complexity almost beyond human comprehension. It is a situation where some scientific approach must be used; and the mathematical model contributes precisely this. It can and does provide a sound basis for the effective management of the business.

Figure 19 illustrates the broad aspects of the model.

Figure 20 shows a typical full output format for a single day which is necessary for evaluating tactical manoeuvres, and Figure 21 illustrates a summarised form used for strategic evaluations.

Modelling of the logistic system throws into sharp relief the areas sensitive to business decisions, be they seemingly insignificant (press form life) or of a major nature (retirement of a factory). The model allows management to concentrate on those areas critical to

the efficient running of the business.

6. Cost/Effectiveness of the Model

The cost of building a model such as this is mainly in the salaries of the staff engaged in its construction. The balance of costs are absorbed by program development and operation of the computer. Development of this model involved some three man-years - this covered the period starting with the definition of the problem to a stage where results for management perusal and action were being obtained. Of the computer costs, 25 hours elapsed time on an IBM 360 Model 40 were spent in developing the program. On the Commission's IBM 360 Model 50 a production run for one year in full output form takes 4 minutes of c.p.u. time. In summarised form it takes 2½ minutes. Tactical decisions are made from the full output mode and rarely extend for more than 18 months. Background to decision making on the tactical front is therefore obtained in about 6 minutes of c.p.u. time for each simulation. On the other hand, strategic decisions are required over a planning horizon of 5-10 years. Each simulation run on this basis takes about 12½ to 25 minutes of c.p.u. time.

The value obtained from this investment could be assessed on two fronts:

6.1 Tactical Control

As a tool to provide a quantitative basis for decision making, the model has been used in many application areas. Examples of these are:

- * Optimal level of stock holding by weeks and the areas where these stocks should be held.
- * Evaluation of emergency situations and the ability of optimal stock levels to supply these requirements.
- * The best use of existing store facilities.
- * Production capability required.
- * The effect of plant additions or removals.
- * Upgrading or degrading of plant capability.
- * Optimal maintenance programs and determination of the best times for routine shutdowns and plant maintenance.

- * The effect of varying the quality and quantity of coal and steam inputs.
- * Establishment of optimal working rules for the factory.
- * Elimination of production "bottle-necks".
- * Determination of a realistic incremental cost of production.
- * The sensitivity of the VR interface with the model.
- * Short term sales strategy based on incremental costs.
- * Cost relationship between product quality and sales.
- * Areas for intensive sales promotion.

6.2 Strategic Planning

In the long term the model quantifies the role of the briquette industry in terms of present worth. The viability of the industry can be brought under intense scrutiny merely by applying sensitivity analyses to critical factors. Such studies include:

- * Evaluation of consumer trends.
- * The effect of various pricing strategies.
- * Desirability of capital investments.
- * New market penetration.
- * Competitive activity.
- * Variations in cost structure.
- * Product development.
- * Variation of personnel numbers.

The model provides management with a tool that can evaluate any set of input conditions. It gives management a quantitative base for decision making.

7. Acknowledgements

The authors are indebted to the State Electricity Commission of Victoria for permission to publish the information contained in this paper. In particular they wish to express their appreciation to Mr. V. D. Friend, Manager, Briquette Sales Branch, and Mr. G. G. Lake, Production Planning Engineer, for their assistance and continued support.

TABLE 1

FUEL USED IN THE DOMESTIC MARKET *

Therms x 10⁶

Year	Briquettes	Coke	Wood	Heating Oil & Kero.	Gas	Electricity	Other	Total	% Share for Briquettes
1963/64	103.3	4.6	87.7	29.5	71.0	92.7	6.9	395.7	26.1
1964/65	115.4	3.0	82.5	36.8	72.5	101.6	11.2	423.0	27.3
1965/66	106.5	2.0	82.8	46.2	71.0	102.5	11.3	422.3	25.2
1966/67	108.5	1.8	66.1	57.1	76.4	110.2	12.5	432.6	25.1
1967/68	107.9	1.6	54.6	66.0	78.4	115.4	19.5	443.4	24.3
1968/69	113.7	1.5	56.8	89.4	87.1	128.7	32.2	509.4	22.3

TABLE 2

FUEL USED IN THE INDUSTRIAL MARKET *
(EXCLUDING ELECTRICITY, FEEDSTOCKS AND
FUEL USED FOR ELECTRICITY GENERATION)

Therms x 10⁶

Year	Black Coal	Brown Coal	Briquettes	Coke	Wood	Fuel Oil	Gas	Total	% Share for Briquettes
1963/64	75.8	90.5	82.4	17.5	31.0	289.8	20.3	607.3	13.6
1964/65	68.8	95.1	95.3	16.5	25.6	332.6	23.8	657.7	14.5
1965/66	67.1	90.3	90.2	14.3	25.3	330.0	21.2	638.4	14.1
1966/67	61.6	95.9	91.3	13.7	22.8	369.9	21.9	677.1	13.5
1967/68	56.9	90.8	86.1	13.1	17.1	414.8	23.5	702.3	12.3

* Deputy Commonwealth Statistician, Victoria - Factory Statistics
 " " " " - Victorian Production Statistics Bulletin
 Electricity Supply Association of Australia Annual Statistics
 Joint Coal Board Annual Reports
 Petroleum Information Bureau, Oil and Australia
 Gas & Fuel Corporation Annual Reports
 Victorian Forests Commission Annual Reports

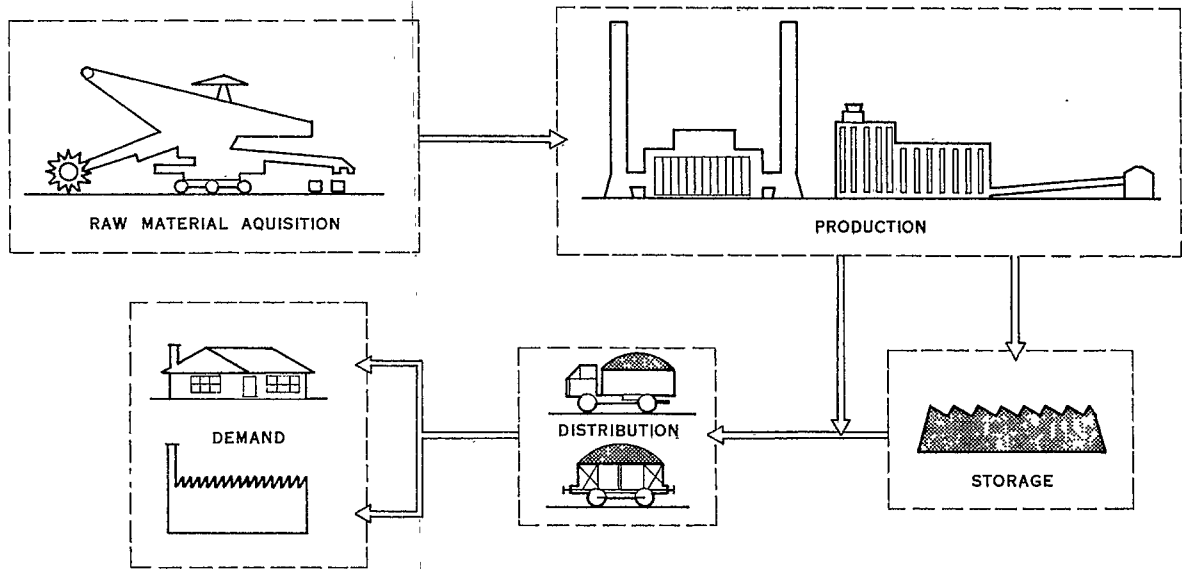

Figure 1. Diagrammatic Arrangement of the Briquette Industry

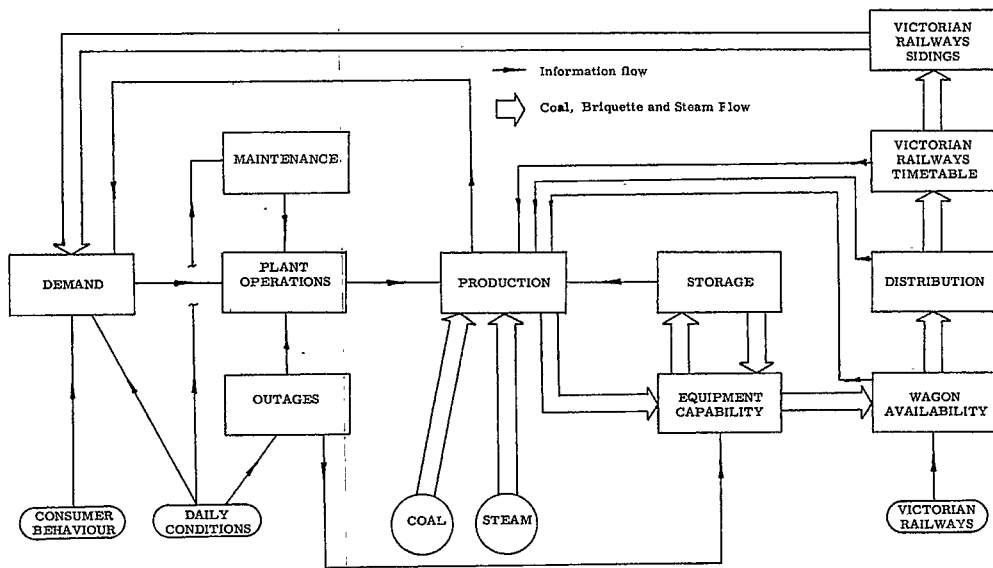

Figure 2. Structure of the Briquette Industry-Closed Loop System

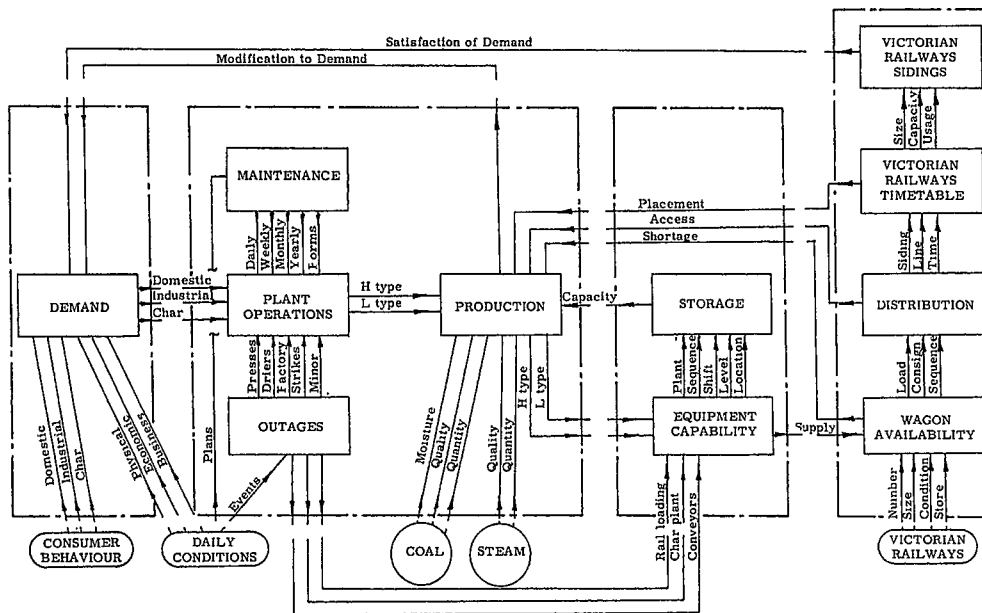

Figure 3. Structure of the Briquette Industry- Sequence of Open Loop System

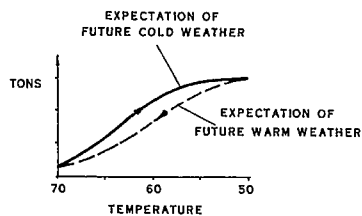

Figure 4. Domestic Forecasting Model

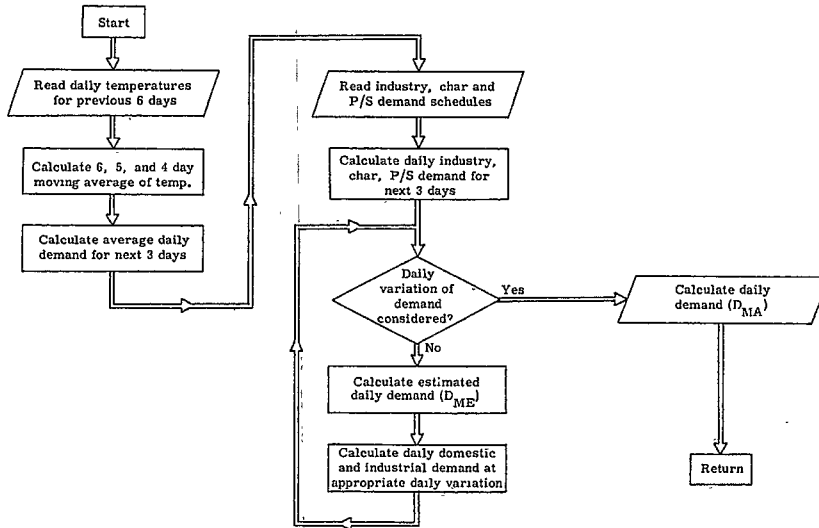

Figure 5. Flow Diagram of Forecasting Model

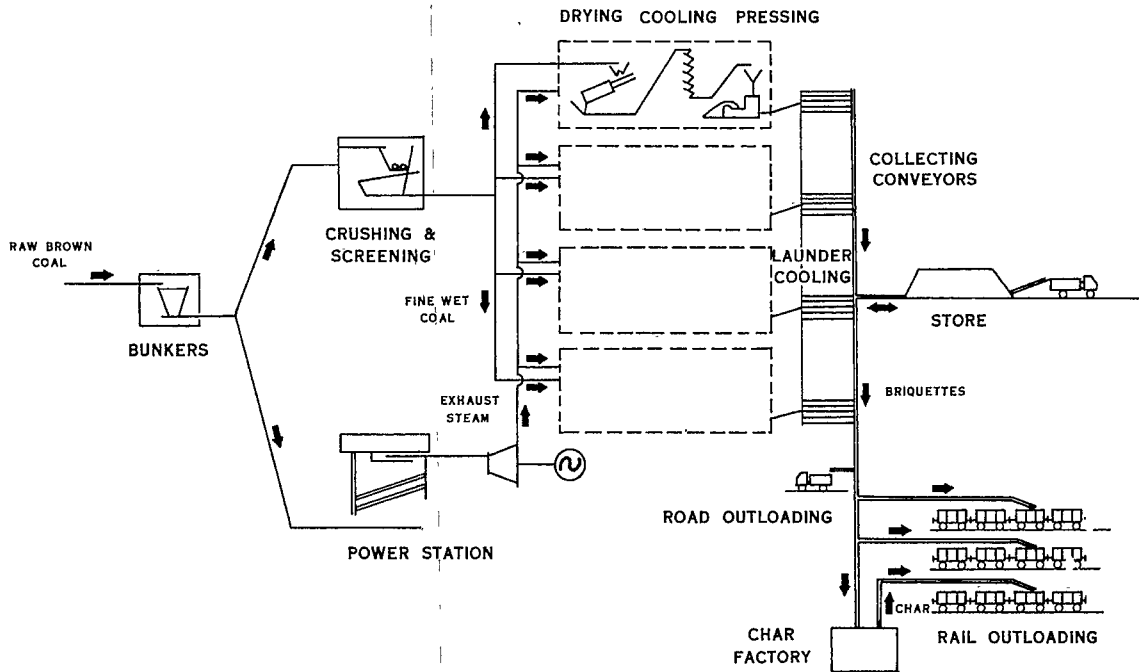

Figure 6. Diagrammatic Arrangement of the Production Functions

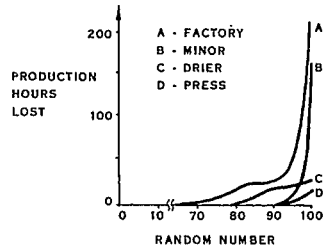

Figure 7. Plant Outages

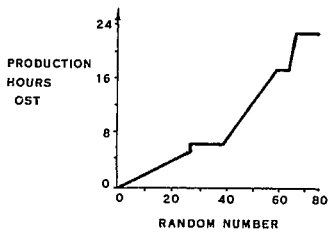

Figure 8. Strikes

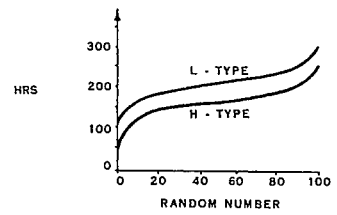

Figure 9. Form Life

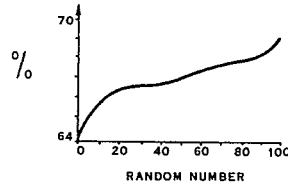

Figure 10. Coal Moisture

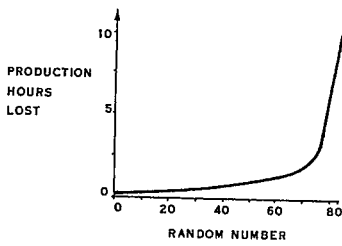

Figure 11. Coal Quality

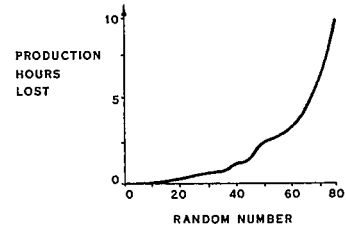

Figure 12. Coal Shortage

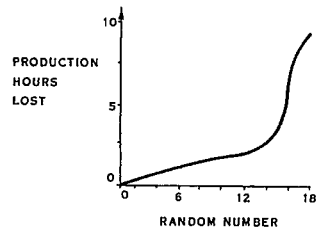

Figure 13. Steam Shortage

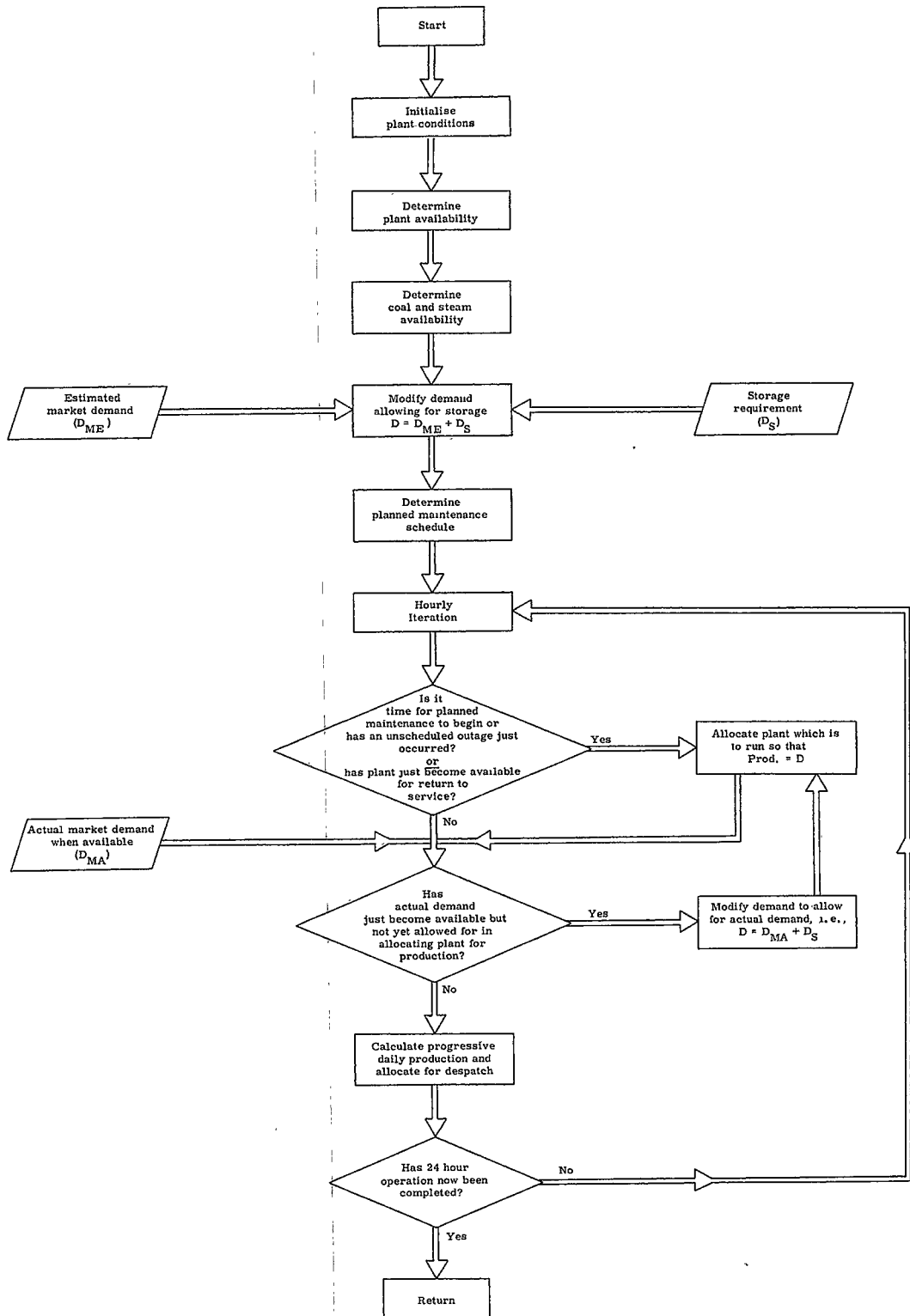

Figure 14. Flow Diagram of Production Model

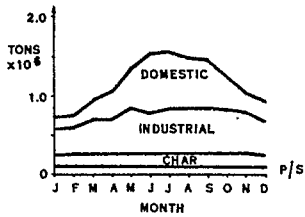

Figure 15. Seasonality of Demand

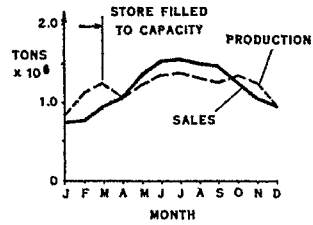

Figure 16. Supply and Demand

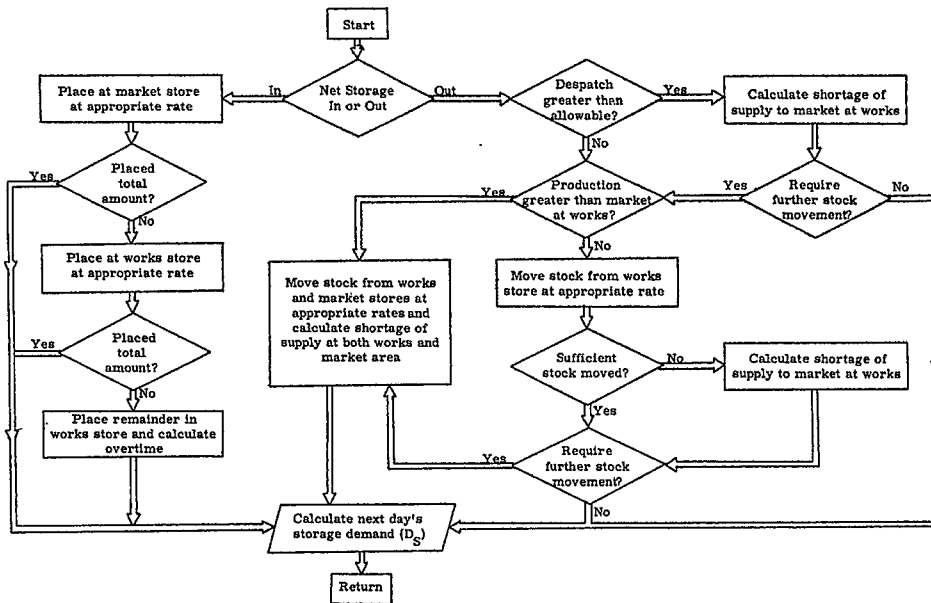

Figure 17. Flow Diagram of the Storage Model

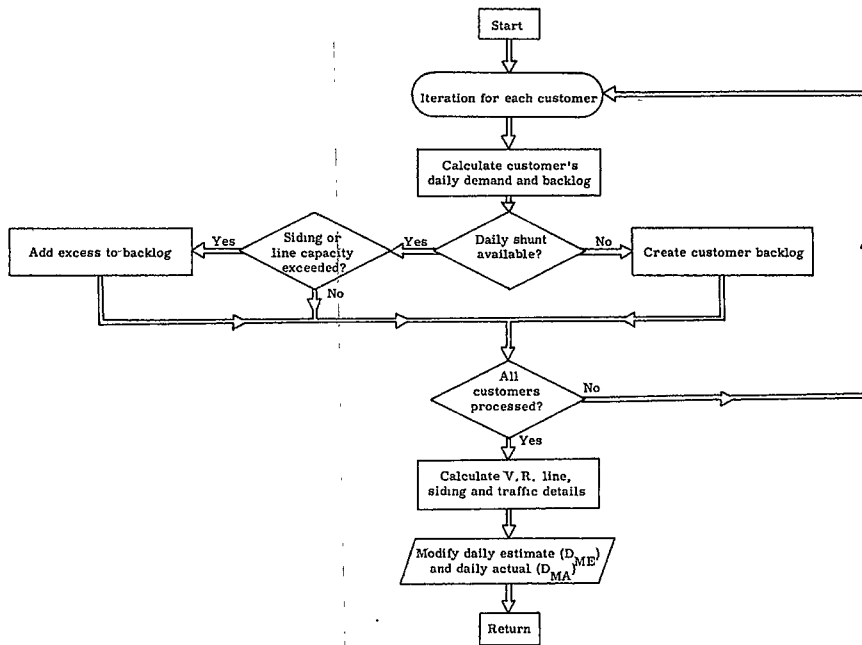

Figure 18. Flow Diagram of the Distribution Model

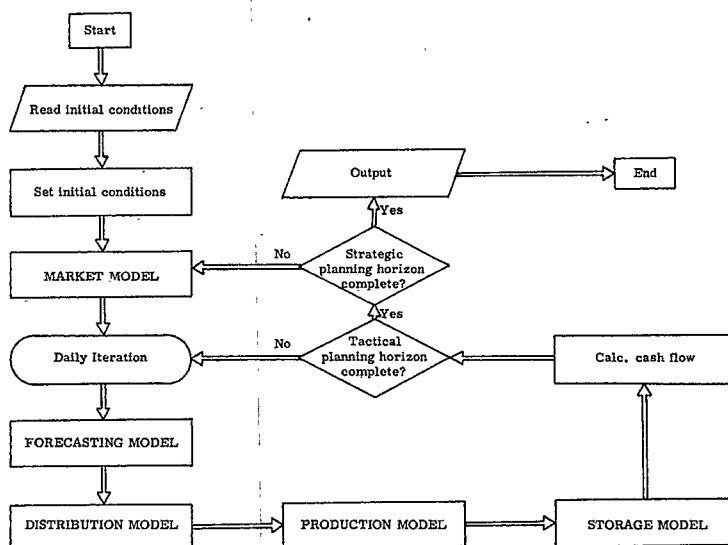

Figure 19. Flow Diagram of the Logistic System

JCR REF 10-27 2 APR 71

SIMULATION RESULTS FOR DAY NUMBER 29 (WED)

25

FORECAST REQUIREMENTS
 WED THU FRI
 DOMESTIC 407 517 500
 INDUSTRIAL 1769 906 1214
 CHAR 400 400 400
 POWER STN 325 325 358
 EST H DEM 568 547 547
 EST L DEM 2332 1478 1667

H-TYPE L-TYPE
 OOHRS STOCK 30 38256
 EST REQ PROD 538 2332
 ACTUAL DEM 893 2339
 DAILY PROD 736 2221
 VR TRK DESP 56 104
 VR TRK LOAD 54 104
 BUFFER TRK -8 34

STORAGES METRO L-V
 24HRLEVELS 14178 23448
 MOVEMENT 0 0
 SUPPLY SHORT 0 0
 DRIER RATING - 6.661 TONS
 DRIER POTENTIAL 3078 TONS

EXPIRED FORM-LIFE & PRESS CONDITIONS
 FACTORY A H C D A B C D
 PRESS1 79 *** 9 *** AVL NI AVL NI
 PRESS2 127 103 162 41 WFL AVL AVL YSL
 PRESS3 103 60 162 160 AVL AVH AVL YSH
 PRESS4 19 9 77 157 AVH AVL AVH YSL
 PRESS5 79 128 189 47 AVL AVL AVL YSL
 PRESS6 *** 57 *** 61 NI AVL NI YSL

PLANT UTILIZATION & PROGRESSIVE PROD LEVELS
 AT PRESS ALLOCATION & RPM DRIER DRY COAL PRG PROD
 HOUR A-FAC B-FAC C-FAC D-FAC ABCD TRANSFER F L
 0000 1H 73 1H 73 CH C OH 0 666C C.C C C
 3L 97 3L 84 4L100 OL 0 0.0
 040C 1H 73 1H 73 OH 0 OH C 666C C.C 103 404
 3L 97 3L 84 4L100 OL 0 0.0
 060C 1H 73 1H 73 CH C CH C 666C C.C 155 607
 3L 97 3L 84 3L 98 OL 0 0.0
 1500 1H 73 1H 73 1H 73 OH C 6660 0.0 387 1416
 3L 97 3L 84 3L 97 OL 0 0.0

DAILY OUTAGES
 OUTAGE DURATION AT HR
 PRESS B5 DDOWN 4 HRS 0
 LGADING SMDU 7 HRS 0

FACTORY D ON ANNUAL SHUTDOWN
 PRESSES OUT FOR FORM CHANGE- A2 & C5

JOB REF 10-27 2 APR 71

SIMULATION RESULTS FOR DAY NUMBER 30 (THU)

30

FORECAST REQUIREMENTS
 THU FRI SAT
 DOMESTIC 266 475 141
 INDUSTRIAL 791 1132 1886
 CHAR 400 400 400
 POWER STN 325 358 358
 EST H DEM 339 557 314
 EST L DEM 1442 1666 2445

H-TYPE L-TYPE
 OOHRS STOCK -120 38136
 EST REQ PROD 459 1442
 ACTUAL DEM 655 1449
 DAILY PROD 77 182
 VR TRK DESP 41 22
 VR TRK LOAD 41 22
 BUFFER TRK -46 0

STORAGES METRO L-V
 24HRLEVELS 13757 23114
 MOVEMENT -421 -330
 SUPPLY SHORT 0 0
 DRIER RATING - 6.779 TONS
 DRIER POTENTIAL 260 TONS

EXPIRED FORM-LIFE & PRESS CONDITIONS
 FACTORY A B C D A B C D
 PRESS1 103 *** 33 *** AVL NI AVL NI
 PRESS2 9 125 186 41 AVL WFL WFL YSL
 PRESS3 118 84 177 160 AVL AVH WFL YSH
 PRESS4 43 13 86 157 AVH AVL AVH YSL
 PRESS5 103 146 9 47 AVL AVL AVL YSL
 PRESS6 *** 79 *** 61 NI AVL NI YSL

PLANT UTILIZATION & PROGRESSIVE PROD LEVELS
 AT PRESS ALLOCATION & RPM DRIER DRY COAL PRG PROD
 HOUR A-FAC B-FAC C-FAC D-FAC ABCD TRANSFER F L
 0000 1H 73 OH 0 1H 73 OH C 666C C.0 C C
 4L100 3L 98 2L105 OL 0 0.0
 0600 CH 0 1H 73 1H 73 OH 0 6660 0.0 0 C
 4L100 3L 98 2L105 OL 0 0.0
 1500 1H 73 1H 73 1H 73 CH 0 666C 0.0 C C
 4L100 4L100 3L105 OL 0 0.0
 2200 1H 73 1H 73 1H 73 CH 0 6660 0.0 C C
 3L 99 3L 86 3L 99 OL 0 0.0

DAILY OUTAGES
 OUTAGE DURATION AT HR
 INDUST DISPUTE 402 DHR 0
 CCAL QUALITY 30 DHR 11

FACTORY D ON ANNUAL SHUTDOWN
 PRESSES OUT FOR FORM CHANGE- B2 & C2

Figure 20. Output Format-Detail

2
3
4
5
6
7
8
9
10
11
12
13
14
15
16
17
18
19
20
21
22
23
24
25
26
27
28
29
30
31
32
33
34
35
36
37
38
39
40
41
42
43
44
45
46
47
48

DAILY SUMMARY FOR AUG YEAR 1

DAY NUM	ACTUAL H DEMAND	ACTUAL L DEMAND	ACTUAL H PROD	ACTUAL L PROD	TRUCKS FILLED H	TRUCKS FILLED L	TOTAL TRUCK DESP	RJFFER TRUCKS H	BUFFER TRUCKS L	STORAGF L TYPE METRQ	LPVELS LV	STORAGE L TYPE METRQ	MOVF LV	TOTAL LOST L	DRY COAL AVAIL	TOTAL BRIQ PROD
213	1972	2044	1945.	1223.	126	81	209	2	0	17443.	36062	0	-820	0	3323	3168
214	2869	2920	2377.	2359.	187	147	336	-30	0	17443	35501	0	-561	0	4863	4736
215	1699	2256	2287.	2299.	121	114	235	0	2	17443	35501	0	0	0	4598	4585
216	1410	2790	1395.	2520.	87	105	192	0	0	17443	35262	0	-239	0	4538	3915
217	1530	2657	1628.	2498.	101	101	196	6	0	17443	35104	0	-158	0	4419	4126
218	2626	2503	2287.	2369.	168	133	307	-16	0	17443	34971	0	-133	0	4866	4656
219	1550	2380	1861.	2534.	101	84	181	4	10	17443	34971	0	0	0	4598	4394
220	2042	2173	1809.	2286.	126	70	200	-11	17	17443	34971	0	0	0	4282	4095
221	2410	3184	2481.	1790.	156	153	309	-6	0	17443	33833	0	-1138	0	4271	4271
222	2396	2533	2481.	1969.	156	113	269	0	0	17443	33269	0	-564	0	4449	4449
223	1621	2505	1744.	2537.	113	119	224	8	2	17443	33269	0	0	0	4360	4281
224	2582	2483	2093.	2595.	160	110	278	-24	9	17443	33269	0	0	0	4747	4688
225	2986	2660	2430.	2258.	194	115	309	-61	0	17443	33002	0	-267	0	4747	4688
226	1840	2544	2669.	1959.	120	122	242	-5	0	17443	32417	0	-585	0	4629	4628
227	2137	2002	2210.	1948.	142	101	243	0	0	17443	32363	0	-54	0	4229	4157
228	2941	3006	2669.	2003.	194	157	351	-18	0	17443	31361	0	-1007	0	4866	4672
229	2954	2295	2695.	2073.	196	116	312	-35	0	17443	31139	0	-227	0	4745	4767
230	2370	3275	2863.	1438.	151	104	255	-2	0	16866	29879	-577	-1260	0	4300	4301
231	2238	3449	1606.	974.	144	84	228	-44	0	15980	28619	-886	-1260	329	2630	2579
232	3059	2744	2192.	2370.	202	163	365	-101	0	15980	27916	0	-703	0	4776	4562
233	1672	1966	2575.	2102.	109	85	194	-40	9	15980	27916	0	0	0	4836	4676
234	2217	1982	2956.	1008.	152	72	215	9	0	15980	27078	0	-838	0	3964	3964
235	2342	2810	2300.	1514.	150	134	287	6	0	15945	25818	-35	-1260	0	4747	3814
236	2413	2665	2446.	1676.	160	127	285	8	0	15945	24829	0	-989	0	4687	4121
237	2360	2545	2340.	1800.	151	64	217	6	0	15213	24817	-732	-12	0	4224	4140
238	2310	3154	2287.	1969.	148	103	253	4	0	14481	24365	-732	-452	0	4598	4256
239	3012	2865	2476.	1620.	193	71	268	-31	0	13506	24095	-975	-270	0	4479	4095
240	1527	2443	2093.	2043.	106	92	192	6	0	13107	24095	-399	0	0	4925	4136
241	1609	1958	1718.	1897.	112	85	190	13	0	13106	24035	-1	-60	0	4330	3615
242	1905	2938	1744.	2240.	113	98	222	2	0	12408	24035	-698	0	0	4788	3984
243	1523	2425	1512.	2538.	100	128	229	1	7	12408	24035	0	0	0	4568	4049

Figure 21. Output Format-Summarised Form