

A Method to Relate the Affecting Parameters and Estimate Dilution in Coal Mines

Gholamreza Saeedi, Bahram Rezai, Koroush Shariar, Kazem Oraee and C. Karpuz

Abstract

This study provides an overview of the various issues influencing Out-of-Seam Dilution (OSD) in longwall mining method. The collected data has been statistically analyzed to examine the effect of the some factors causing OSD in front of the longwall mining face. Multiple parameter regression analysis was conducted on affecting parameters and the OSD. The SPSS (Statistics Package for Social Sciences) for Windows software package was used for the statistics analysis. Finally, a relationship between affecting parameters and the OSD is established by using the multiple parameter regression results. Results of this study have revealed that depth of seam, dip of seam, roof quality and variation in seam thickness are the most important influence factors for OSD. The proposed method may be utilized for the estimation of OSD for similar mines since, it was based on actual collected data from the coal mines.

INTRODUCTION

Approximately 90% of all coal production by underground mines in Iran is derived directly from longwall mining method in Kerman, Tabas and Albors coal mines. In the mines, OSD usually varies from 15 to 30%, depending upon the mining, geological and technical conditions. The amount of OSD substantially reduces the efficiency of the mines. Also, OSD lowers the quality of the run of mine coal, raises the cost of concentration, milling, cooking processing, transport and handling, especially when long-distance hauls are involved (Popov, 1971). Saeedi *et al.* (2008) reported when OSD increases 1% at Tabas coal mine, net profit and the efficiency of coal washing plant decreases by 0.75% and 1.17 \$ t⁻¹, respectively.

To date, attempts have been rare for a comprehensive understanding of the formation state and the factors influencing OSD in the longwall mining method. The earlier studies have only been done by investigators for some of mining methods such as sublevel stopping. In one of the estimation methods, the content of the useful constituent in the extracted coal, the useful constituent in the solid coal in place and the useful constituent in the rock contaminating coal were related to dilution (Popov, 1971). The main advocate of this idea was Agoshkov who established a relationship between mentioned parameters and dilution. Agoshkov proposed that the dilution coal is largely dependent upon the content of coal in the rocks contaminating it. Therefore high dilution figures do not always mean low extraction efficiency. Another similar study was presented by Nazarchik in mining thin ore bodies. Nazarchik investigations is considers on width of the stope area, mean width of the vein, volume weight of the host rock, volume weight of the vein matter, content of metal in the vein matter and host rocks (Popov, 1971). The third dilution approach proposed by Pakalnis (1986) based on case histories from the Ruttan mine. This method is not used by industry. However, it is an early attempt to quantify dilution. Clark developed a new dilution estimation method based on the format of the modified stability graph and expressed the stope stability as a dilution

estimate (Clark, 1998). Another study was based on field-collected data at Stillwater mine in Montana (Annels, 1996). In this method, the dilution is estimated by the use of a power curve equation based on studies of the actual dilution associated with different ore thicknesses. According to the investigations performed by Annels (1996), the dilution increased when the thicknesses of seam decreased.

Some researchers used numerical modeling techniques to investigate parameters influencing dilution in open stope method. Suorineni *et al.* (1999) investigated fault-related dilution in open stop mining method where dominant geological weaknesses or faults exist by using Phase 2. They proposed that the presence of a fault near an open stope can increase the size of the distressed zone and dilution around the stope relative to conditions without a fault.

Another numerical modeling method was based on evaluation stress and hanging wall geometry on open stope stability and dilution by using two boundary element method programs (Examine 3D and Examine 2D) (Wang, 2004). According to the investigations performed by Wang, with an increase in the radius factor and the stress ratio, dilution increases.

The third numerical approach proposed by Henning and Mitri (2007). In the method, a series of three-dimensional numerical models are developed and analyzed to examine the effect of mining depth, *in situ* stress as well as stope geometry and orientation on ore dilution.

In assessing OSD in longwall mining method, it is necessary to understand factors causing and the main sources of OSD. Therefore, in this study, the main sources and the relative importance of factors influencing OSD was investigated base on the data obtained at coal mines, in Iran. To better understand the how factors increase the OSD, a statistical analysis was conducted using SPSS (Statistics Package for Social Sciences).

THE SOURCES OF OSD IN THE LONGWALL MINING

In longwall mining method, which is the preferred method of mining a flat-lying stratiform orebody when a high area extraction ratio is required, OSD is unavoidable with extracting the full seam thickness. Especially, when a fully mechanized face is used for extraction of coal. In this method, the average of OSD is 10-25%.

As a first step in evaluation OSD, the sources of OSD must be determined. In the longwall mining method, the sources of OSD may be divided into three main classes; primary, secondary and tertiary dilution (Noppe, 2003). Primary dilution includes cutting of the stone floor or roof by the longwall shearer machine. Secondary dilution is slabbing or break-up of the roof or floor during mining and tramming and the subsequent loading of this material together with the coal (rather than being stowed in back areas). Tertiary dilution includes waste material loaded with the coal during section-cleaning operations. Parameters influencing OSD categorization differs among the above main sources. [Figure 1](#) presents the general and detailed factors influencing OSD for each source. These factors can be treated as independent and dependent variables.

Basically, the most significant contributing factors can identified as independent variables, excluding the human element, such as geologic anomalies, bottom and

roof quality, hardness of seam, depth of seam, height of seam, amount of water present and dip of seam. To some extent these variables are interrelated. For example, roof quality is partially a function of the depth of the seam and floor quality may be affected by the presence of water.

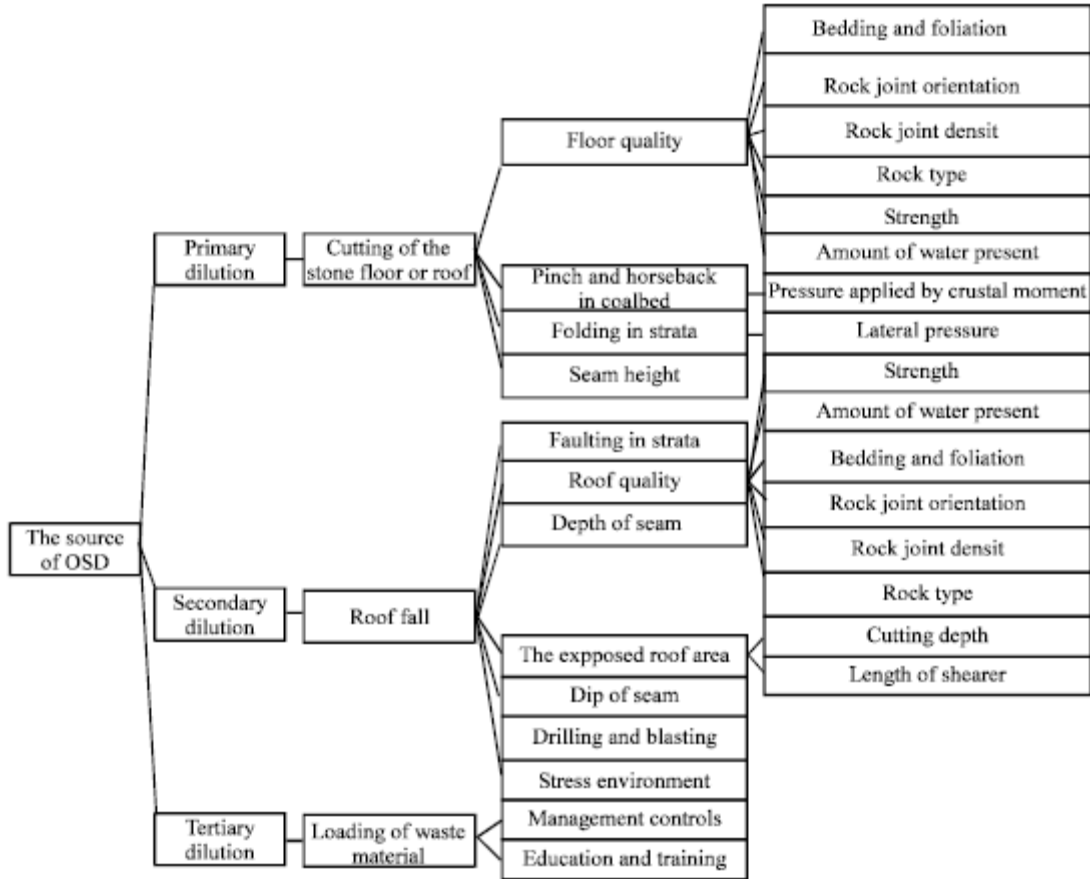

Fig. 1: The main sources of OSD and factors influencing OSD for each source in longwall coal mines

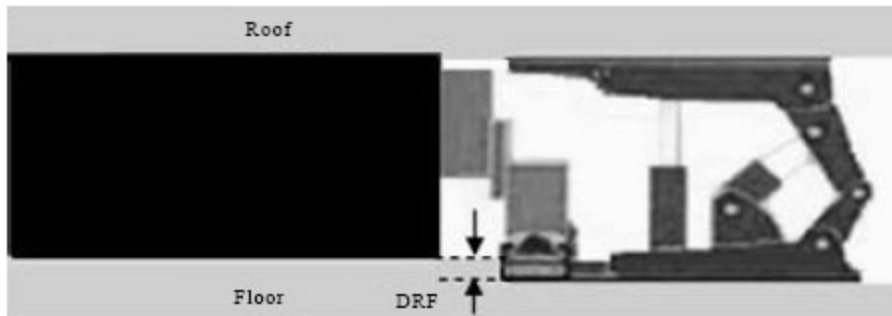

Fig. 2: Depth of Removing Floor (DRF) by shearer on a soft floor in longwall

Table 1: A classification for floor quality

Floor quality	Description
Excellent	Smooth, hard, grades less than 1.5%, dry
Good	Smooth, soft but dry, grades less than 3%, possibly some heaving at a later time
Fair	Soft and dam, ruts with regular use, adverse grades of 5 to 7%, possibly slippery bottom, occasional steep rolls

Stefanco (1984)

However, each can also be a factor independent of any other.

Primary OSD: The primary OSD plays a significant role among the sources of OSD. It often occurs due to cutting of the stone floor or roof (accidental or planned) by the longwall shearer machine or by the drilling and blasting operations in hard coals. The type of OSD takes place with cutting the coal at the same time. The following seem to be detailed description of factors influencing primary OSD.

Floor quality: While all mining systems operate at optimum efficiency on firm bottoms, the condition of the floor is most critical for longwall. Because in massive rock that required heavy-duty support and shearer, the bearing capacity of a weak floor would not be adequate. Consequently, if the floor is soft the support system and longwall shearer machine may sink into the floor under the roof pressure. It will not only reduce the supporting capacity of the powered supports, but will also be removed some material from the floor by shearer. [Figure 2](#) shows the Depth of Removing Floor (DRF) by shearer on a soft floor in longwall mining method.

Many factors, such as bedding and foliation, rock joint orientation, rock joint density, rock type, strength and amount of water pressure can significantly affect floor quality and hence the primary OSD. A classification of floor quality proposed by Stefanco (1983) is shown in [Table 1](#).

For the calculation of DRF in soft and plastic rocks, the bearing capacity of floor and external loadings on the powered supports or support capacity should be calculated. Since, the material properties of this type of rock are similar to soil, the theories from the soil mechanics can be applied (Peng and Chiang, 1984). The most widely used one is the terzaghi's bearing capacity equation which when applied to the mine floor for rectangular base is:

$$\sigma_b = \left[\left(1 + 0.3 \times \frac{B}{L}\right) \times C \times N_c + (\gamma_1 - \gamma_w) \times Z \times N_q + \left(1 - 0.2 \times \frac{B}{L}\right) \times \frac{(\gamma_2 - \gamma_w) \times B \times N_r}{2} \right] \times \frac{1}{\eta_0} \quad (1)$$

where, σ_b is the bearing capacity of floor; C is cohesion of the floor rock; γ is the weight per unit volume of the soil; B and L are the width and length of the footing; N_c , N_q and N_r are bearing capacity factors; r is the uniform loading on both sides of the base; γ_1 and Z are the weight per unit volume and thickness of the strong stratum, respectively. N_c , N_q and N_r are the bearing capacity factor, γ_2 is the weight per unit volume of the weak stratum and η_0 is stress distribution coefficient.

For determination of support capacity, based on the characteristics of the roof, a statistical model for describing the interaction between the roof strata and support has been developed (Peng, 1986). Coal mine ground control:

$$\Delta q = 2q_s^2 e^{-2a_s} \quad (2)$$

where, Δq is the effective increment of load density in $t \text{ ft}^{-2}$, i.e.,

$$\Delta q = \frac{\Delta p \eta}{A}; \quad q_s = \frac{p_s \eta}{A}$$

where, p_s is the setting load in tons; Δp is the load increment from support setting to final load immediately before the support is released for advance in tons; η is the support efficiency; A is the canopy area of the support in ft^2 and a and c are constants related to roof conditions. Based on this model, the following formulas can be used for calculating the setting load, load increment and the yield load P_y :

$$P_s = \frac{3.2A}{c\eta} \quad (3)$$

$$P_s = \frac{0.417Aa}{c^2\eta} \quad (4)$$

$$P_y = P_s + \Delta P \quad (5)$$

The minimum bearing capacity of floor (σ_b) required for the condition in which the base-sinking problems will not occur is:

$$\sigma_b \geq P_y \times A \quad (6)$$

Therefore:

$$\text{DRF} = 0, \text{ if } \sigma_b \geq P_y \times A \quad (7)$$

If the bearing capacity of floor is less than the total pressure on canopy, the support system and longwall shearer machine will sink into the floor under the roof pressure. In this case, the base-sinking depth or DRF is a function of the total pressure on canopy that can be determined by stress-strain relationships for materials with plasticity behavior. Therefore:

$$\text{DRF} = \varepsilon = f(\sigma_t) \text{ if } \sigma_b \leq P_y \times A \quad (8)$$

where, ϵ is normal strain. [Equation 8](#) means that DRF is dependent on material behavior, type of floor material and the total pressure on canopy.

Geologic anomalies: Geologic anomalies are often a major cause of primary OSD in the form of coalbed displacement in underground coal mines. Three main subjects are discussed below in terms of the influence of geological factors on OSD.

When a section of a coalbed becomes constricted by reason of a rising bottom and a lowering roof, as shown in [Fig. 3a](#), the terms pinch, squeeze or swell are used to describe this condition (Stefanco, 1983). The underlying stratum or bottom of a coalbed is rarely a smooth horizontal surface but usually has many undulations or rolls that very considerably in both horizontal and vertical extent. If the rolls become exaggerated the term horseback, as shown in [Fig. 3b](#), is used to describe this condition. The folding of coalbeds results from movements of the earth's crust. Folds, as shown in [Fig. 3c](#), are strata that have been thrown into more or less curved forms. Authorities classify these structural features as resulting from pressure applied by crustal movement to the bed during formation, or by strata adjoining the bed.

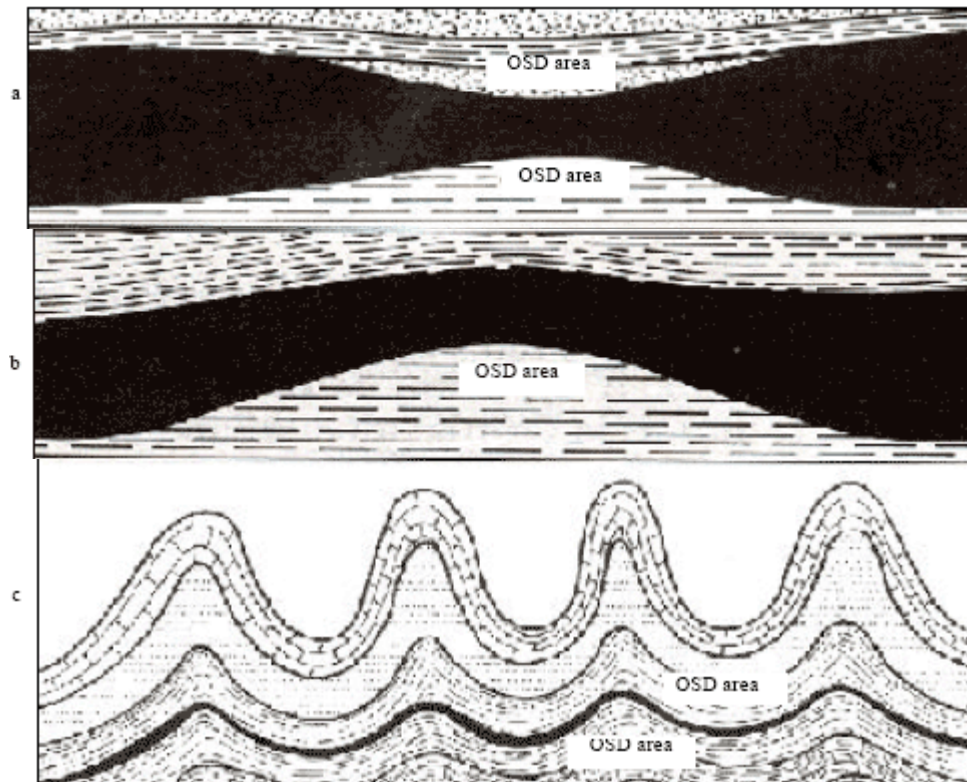

Fig. 3: OSD as resulting from pinch (a) horseback, (b) folding and (c) in a coalbed (Stefanco, 1983)

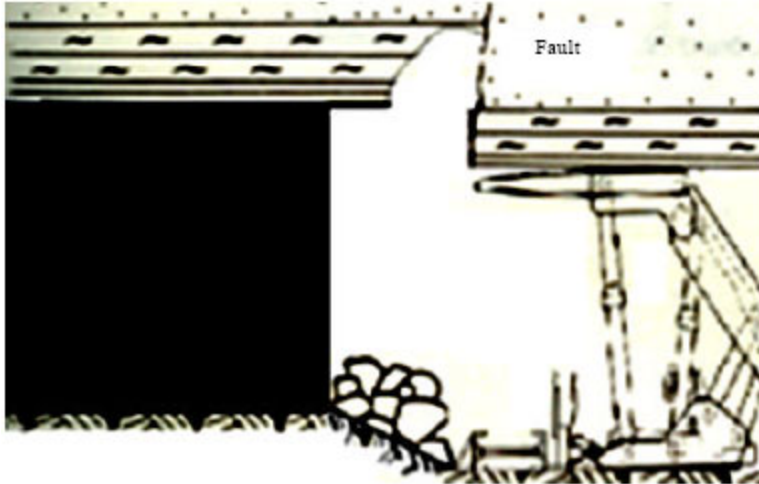

Fig. 4: Roof fall as a result of fault in the prop-free front of the face in longwall

However, in these mentioned cases, with cutting and loading the coal, a significant amount of the immediate floor and roof strata will be extracted and consequently OSD would also be increased.

Seam height: In longwall mining method, the seam height H_c should first be considered for properly selecting the dimensions of the shearer, which includes the diameter of the cutting drum D , body height L_a , ranging arm length B , body depth B and swing angle α of the ranging arm (Hartman, 1992). The relationship among those parameters can be expressed by:

$$H_c = H_b - \frac{B}{2} + L_a \sin \alpha + \frac{D}{2} \quad (9)$$

If, $\alpha_1 \leq \alpha \leq \alpha_2$. Thus the minimum seam height H_{cm} is:

$$H_{cm} = H_b - \frac{B}{2} + L_a \sin \alpha_1 + \frac{D}{2} \quad (10)$$

The seam height should not be less than H_{cm} . Otherwise, the amount of stone roof and floor should be cut by the shearer to gain height for operator comfort and a mining area of minimal breadth. Consequently, the primary OSD increases.

Secondary OSD: The type of OSD includes slabbing or break-up of the roof or floor during mining and the subsequent loading of this material together with the coal. This form of dilution is very common in weak roof and weak floor conditions.

Faulting strata: A fault is a major geologic structure in underground coal mines. In a fault area, as shown in [Fig. 4](#), the surrounding strata are generally broken; therefore, when the face through a fault, the roof falls in the prop-free front can be a major cause of OSD. Many factors, such as the angle between a fault and the face, fault friction angle and fault position are often the most important factors influencing the severity of fault-related sloughage in longwall.

Roof quality: The major reason for local roof fall at the longwall face is the lack of efficient means for supporting the exposed immediate roof between the faceline and the tip of the canopy and subsequently the failure to prevent the broken rocks from falling into the working space and increasing OSD. Amount of the roof fall depend on bedding and foliation, joint orientation, joint density, rock type, strength and water pressure.

Roof fall in prop-free front of the face can be determined by roof fall sensitivity or roof fallibility. Roof fall sensitivity is a measure of the extent of roof fall at the face area (Peng and Chiang, 1984). It is defined as:

$$RF = \frac{A}{A_t} \times 100 \quad (11)$$

where, A is the summation of area of roof fall cavities and A_t is the total area surveyed. A should be measured at the roofline and only those roof falls with height greater than 20 inch are counted.

However, roof fall cavities are most irregular in shape. They not only take a longer time to map, but very often can't be done accurately. For account this problem, roof fall sensitivity can be represented by the percentage of roof fall cavity width to the total unsupported roof span, that is:

$$F_v = \frac{d}{a+b+c} \times 100 \quad (12)$$

Table 2:

Roof classification by roof fallibility

Roof type	F_v (%)	Roof control problems
I	0-10	Easily controllable
II	11-20	Medium controllable
III	21-30	Hardly controllable, productivity low
IV	>30	Hardly controllable, productivity severely curtailed

Peng and Chiang (1984)

where, F_v , a, b, c and d are roof fallibility, distance from edge of the canopy to the first roof contact point on the canopy, nominal unsupported roof span from front edge of the canopy, depth of face sloughing and width of roof fall cavity, respectively. [Table 2](#) shows a roof classification scheme based on roof fallibility.

Based on roof fallibility, the following formula can be used for calculating the percentage of OSD cause by roof falls:

$$OSD = \frac{1}{1 + \frac{H}{h \times F_v}} \times 100 \quad (13)$$

where, h and H are the average cavities depth and coal seam height, respectively.

Underground investigation have shown that there are four types of open roof fractures in longwall faces: R_1 is parallel to bedding, R_2 is perpendicular to bedding, R_3 is dipping toward the faceline and R_4 is dipping toward the gob ([Fig. 5](#)). If R_1 and

R_2 intersect and form a high wedge shaped cavity, it signifies a loose roof. Each type should be recorded and expressed in terms of the average cavities depth.

Exposed roof area: The exposed roof area in front of the face varies, depending on the cutting depth and the length of shearer, as shown in Fig. 6. The shape factor is frequently used to quantify the exposed roof geometry. The shape factor is another word for Hydraulic Radius (HR). The HR is calculated by dividing the area of exposed roof by the perimeter of that roof. For a rectangular shaped surface, the HR can be calculated by Eq. 14 (Laubscher, 1977):

$$HR = \frac{L \times S}{2(L + S)} \quad (14)$$

where, HR, L and S are the hydraulic radius of the exposed roof area, the length of shearer (length of the exposed roof area) and cutting depth (width of the exposed roof area), respectively.

This is due to the fact that under constant conditions, the local roof fall and consequently the OSD increase with the hydraulic radius and roof exposure time.

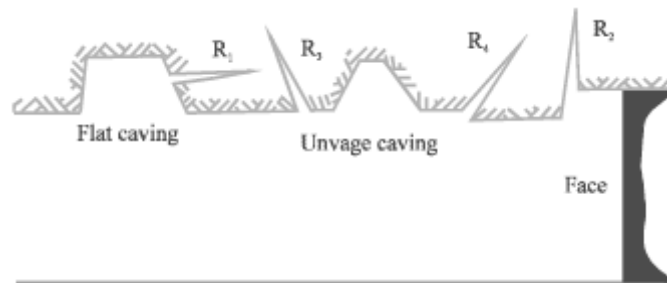

Fig. 5: Type of roof fractures in prop-free front of the face area (Peng and Chiang, 1984)

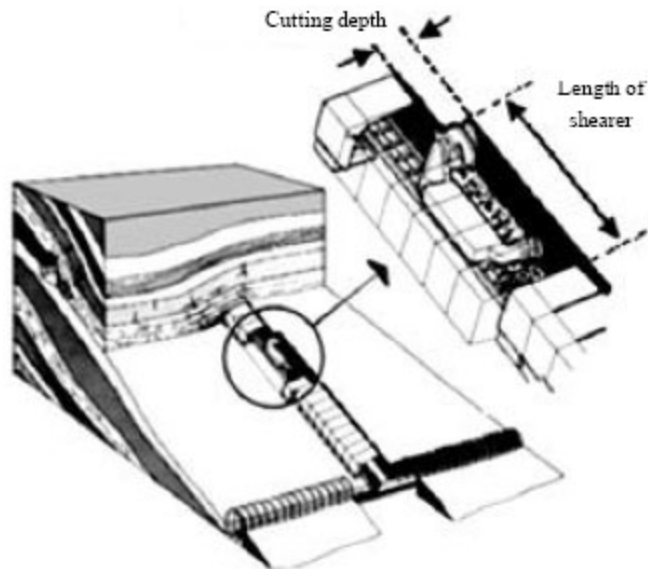

Fig. 6: The exposed roof geometry in prop-free front of the face (Whittaker, 1974)

Stress environment: When an underground opening is excavated into a stressed rockmass, stresses near the new opening are disrupted and re-distributed. [Figure 7a](#) shows an interpretation of the distribution of vertical stress, σ_{zz} , around a single longwall face. The vertical stress is zero at the face and the rib side (Brady and Brown, 2004). Therefore, a relaxation zone with low stress exists in prop-free front the face.

In the relaxation zone, the absence of significant clamping stresses is often cited as one of the main reasons for the instability and fall of roof and consequently, the OSD occur in this relaxation zone ([Fig. 7b](#)) (Henning and Mitri, 2007).

Dip of seam: The influence of hanging-wall dip on the roof fall can be significant. With steeply dipping seams, vertical stresses are shed around the coalbed. As the dip of the hanging-wall becomes shallower, vertical stresses are shed onto the coalbed, leading to larger displacements and roof falls (Henning and Mitri, 2007). Therefore, severity of OSD increases as seam dip angle became increasingly shallow.

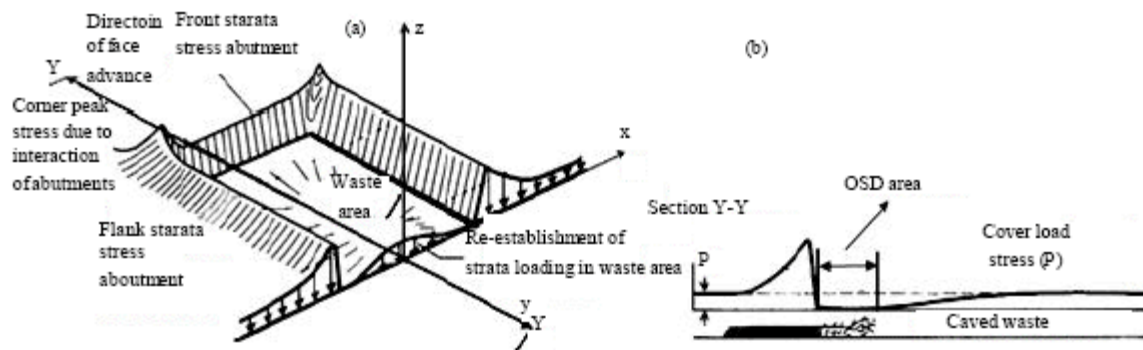

Fig. 7: Vertical stress redistribution in the plane of the seam around a longwall coal face (a) and OSD area in front of the face (b) (Richard *et al.*, 1998)

Drilling and blasting: When hardness of the coal is high, the coal is barely capable of being cut with shearer. In this case, it must be cut using drilling and blasting operations. Drilling and blasting of the coal can significantly damage the roof falls and overbreak in front of the face. So, some degree of the OSD can be attributed to blast vibrations and damage.

Many factors, such as drillhole size, drillhole spacing and burden, charging geometry and the drillhole accuracy are often the most important factors influencing the severity of roof falls and overbreaks.

Tertiary OSD: Tertiary OSD includes waste material loaded as a result of gob area with the coal during section-cleaning operation by workers. The type of OSD can be reduced by practices such as management controls, education and training. Management controls induces type of contract, incentive plans, management initiatives and coal quality controls. Education and training induces awareness of dilution impacts and dilution impacts on company profitability (Chugh and Moharana, 2005).

Statistical analysis: A statistical analysis was conducted to evaluate the relationship between OSD and some of the effective parameters mentioned above. The SPSS (Statistics Package for Social Sciences) for windows software package was

used for the statistical analysis. [Table 3](#) and [4](#) shows the parameters included in the statistical analysis. Field data of these tables was collected from coal mines in Iran.

Multiple parameter regression analysis was carried out by the parameters shown in [Table 4](#). The OSD is defined as dependent variable and the remaining parameters are referred to as independent variables in the study. The general additive multiple parameter regression model express as the following (Devore, 1995):

$$Y = \beta_0 + \beta_1 x_1 + \beta_2 x_2 + \dots + \beta_i x_i + \dots + \beta_k x_k + \varepsilon \quad (15)$$

where, Y , β , k , x and ε are the dependent variable, coefficient, the number of independent variables, the independent variables and the random error term, respectively. By replacing the dependent variable Y in [Eq. 15](#) by OSD and the independent variables x_i by X_i , we have the multiple parameter regression model given as [Eq. 16](#):

$$Y = \beta_0 + \beta_1 X_1 + \beta_2 X_2 + \beta_3 X_3 + \beta_4 X_4 + \beta_5 X_5 + \beta_6 X_6 + \beta_7 X_7 + \beta_8 X_8 + \beta_9 X_9 \quad (16)$$

where, OSD is out-of-seam dilution and X_1 , X_2 , X_3 , X_4 , X_5 , X_6 , X_7 , X_8 and X_9 are variation in seam thickness (m), seam thickness (m), dip of seam (degree), cutting methods (pick, shearer or blasting), roof quality, floor quality, depth of seam (m), hydraulic radius (m^2) and type of contract, respectively. X_4 , X_5 , X_6 and X_9 are string variables. [Table 5](#) shows string variables and its imported value labels in statistical analysis.

The field data were imported into the statistical analysis package SPSS and a multiple parameter regression was conducted. The correlations between parameters and the multiple parameter regression quantitative coefficients were obtained. [Table 6](#) presents the correlation matrix and the calculated coefficients for the parameters involved in the analysis. The sign of the correlation coefficient indicates the direction of the relationship (positive or negative). The absolute value of the correlation coefficient indicates the strength, with larger absolute values indicating stronger relationships. [Table 6](#) shows that X_7 has the strongest correlation with OSD (with a correlation coefficient of 0.998) and X_4 has the weakest correlation with OSD (with a correlation coefficient of 0.273) among the independent variables. The significance of each correlation coefficient is also displayed in the correlation table.

Table 3: The collected data for statistical analysis from Iran coal mines

Name of mine	X ₁	X ₂	X ₃	X ₄	X ₅	X ₆	X ₇	X ₈	X ₉	OSD
Asadabad	0.50	1.5	33	1	1	1	500	0.6	1	24.6
Eshkeli	0.48	1.3	30	1	2	1	250	0.7	2	13.0
Babnizo	0.68	0.9	24	2	2	2	187	1.0	1	10.4
Babshegon	0.50	1.3	30	1	2	1	300	0.7	2	15.5
Pabedanae asli	0.65	0.6	18	3	2	2	223	1.3	1	12.6
Tonel 12-14	0.60	1.1	27	2	2	2	169	0.9	1	9.3
Cheshmeh podeneh	0.29	2.0	41	1	1	1	809	0.2	2	39.5
Darbidkhon	0.34	1.8	38	1	1	1	900	0.3	2	44.2
Serapardeh	0.50	1.3	30	1	2	1	300	0.7	1	15.5
Tabas	0.58	1.1	27	2	2	2	169	0.9	1	9.3
Komsar	0.59	0.6	18	3	2	2	227	1.3	1	12.8
Geletot	0.61	0.4	15	4	2	2	250	1.4	2	14.1
Hojetk	0.60	0.4	15	4	2	2	200	1.4	1	11.6
Hashoni	0.78	0.5	35	4	3	3	200	2.3	1	11.8
Hamkar	0.50	1.3	30	1	2	1	146	0.7	2	7.8
Pabedana 234	0.51	1.3	30	1	3	4	148	0.7	1	9.0
Pabedana 243	0.60	1.1	27	2	2	2	168	0.9	1	9.3
Pabedana 107	0.70	0.1	9	4	2	2	285	1.7	1	16.2
Pabedana 210	0.20	2.2	20	1	1	1	553	0.2	2	27.6
Pabedana 115	0.20	2.2	5	1	1	1	450	0.2	2	23.1
Pabedana 265	0.33	1.8	10	1	1	1	89	0.3	1	4.9
Pabedana 165	0.29	1.8	38	1	1	1	478	0.3	2	23.1
Pabedana 213	0.51	1.3	30	1	2	1	250	0.7	2	13.0
Pabedana 45	0.32	1.8	18	1	1	1	345	0.3	1	17.4
Pabedana 214E	0.30	1.8	20	1	1	1	300	0.3	2	15.0
Pabedana 214W	0.50	1.3	30	1	2	1	148	0.7	1	7.9
Pabedana 208	0.40	1.5	33	1	1	1	600	0.6	2	29.5
Pabedana 222	0.53	0.9	24	2	2	2	201	1.0	1	11.0
Pabedana 119	0.55	0.7	20	3	2	2	180	1.2	1	10.3
Khomrod	0.70	2.0	40	1	1	1	498	0.1	2	24.1
Pabedan S	0.60	0.6	18	3	2	2	225	1.3	1	12.7
Pabedana N	0.20	2.2	27	1	1	1	589	0.12	2	29.1
Madanjo1	0.30	2.0	15	1	1	1	162	0.2	1	8.3
Madanjo2	0.50	1.2	28	1	2	2	155	0.8	2	8.4
Madanjo3	0.80	0.6	40	4	3	3	413	2.7	1	22.3
Madanjo4	0.10	2.6	34	1	1	1	741	0.1	2	36.3
Madanjo5	0.20	2.2	43	1	1	1	676	0.15	2	32.7
Tabas	0.80	2.63	10	1	3	4	192	1.1	2	12.1

Table 4: Parameters included in the analysis and descriptive statistics

Parameters	N	Minimum	Maximum	Mean	SD
X ₁	38	0.100	0.800	0.48263	0.182885
X ₂	38	0.100	2.630	1.36658	0.653482
X ₃	38	5.000	43.000	25.78947	9.770772
X ₄ *	38	1.000	4.000	1.73684	1.107327
X ₅ *	38	1.000	3.000	1.71053	0.653799
X ₆ *	38	1.000	4.000	1.60526	0.823292
X ₇	38	89.000	900.000	333.57895	207.774908
X ₈	38	0.100	2.700	0.79132	0.597337
X ₉ *	38	1.000	2.000	1.47368	0.506009
OSD	38	4.900	44.200	17.23684	9.734598
Valid N (listwise)	38				

*X₄, *X₅, *X₆ and *X₉ are string variables

Table 5: String variables and its imported value labels in statistical analysis

Variables	Description
X ₁ = 1, 2, 3	1: Cut with pick, 2: Cut with shearer, 3: Cut with drilling and blasting
X ₂ = 1, 2, 3, 4	1: Roof quality is excellent, 2: Roof quality is good, 3: Roof quality is fair, 4: Roof quality is poor
X ₃ = 1, 2, 3, 4	1: Floor quality is excellent, 2: Floor quality is good, 3: Floor quality is fair, 4: Floor quality is poor
X ₉ = 1, 2	1: Type of contract is state, 2: Type of contract is private

The significance (or p value) represents the low degree of a certain result. A significance less than 0.05 (p<0.05) means that there is less than a 5% chance that this relationship occurred by chance. If the significance level is very small (less than 0.05) then the correlation is significant and the two variables are linearly related. If

Table 6: Correlations and significant between parameters

the significance level is relatively large (for example, 0.50) then the correlation is not significant and the two variables are not linearly related.

Variables	Parameters	X ₁	X ₂	X ₃	X ₄	X ₅	X ₆	X ₇	X ₈	X ₉	OSD
X ₁	Pearson correlation	1	-0.691(**)	-0.083	0.631(**)	0.798(**)	0.678(**)	-0.560(**)	0.808(**)	-0.458(**)	-0.527(**)
	Sig. (2-tailed)	.	0	0.618	0	0	0	0	0	0.004	0.001
	N	38	38	38	38	38	38	38	38	38	38
X ₂	Pearson correlation	-0.691(**)	1	0.162	-0.828(**)	-0.591(**)	-0.389(*)	0.532(**)	-0.805(**)	0.583(**)	0.506(**)
	Sig. (2-tailed)	0	.	.330	0	0	0.016	0.001	0	0	0.001
	N	38	38	38	38	38	38	38	38	38	38
X ₃	Pearson correlation	-0.083	0.162	1	-0.258	-0.069	-0.179	0.505(**)	-0.112	0.261	0.486(**)
	Sig. (2-tailed)	0.618	0.330	.	0.118	0.680	0.283	0.001	0.505	0.113	0.002
	N	38	38	38	38	38	38	38	38	38	38
X ₄	Pearson correlation	0.631(**)	-0.828(**)	-0.258	1	0.527(**)	0.506(**)	-0.316	0.868(**)	-0.495(**)	-0.273
	Sig. (2-tailed)	0	0	0.118	.	0.001	0.001	0.053	0	0.002	0.097
	N	38	38	38	38	38	38	38	38	38	38
X ₅	Pearson correlation	0.798(**)	-0.591(**)	-0.069	0.527(**)	1	0.836(**)	-0.610(**)	0.798(**)	-0.391(*)	-0.572(**)
	Sig. (2-tailed)	0	0	0.680	0.001	.	0	0	0	0.015	0
	N	38	38	38	38	38	38	38	38	38	38
X ₆	Pearson correlation	0.678(**)	-0.389(*)	-0.179	0.506(**)	0.836(**)	1	-0.440(**)	0.676(**)	-0.382(*)	-0.395(*)
	Sig. (2-tailed)	0	0.016	0.283	0.001	0	.	0.006	0	0.018	0.014
	N	38	38	38	38	38	38	38	38	38	38
X ₇	Pearson correlation	-0.560(**)	0.532(**)	0.505(**)	-0.316	-0.610(**)	-0.440(**)	1	-0.437(**)	0.548(**)	0.998(**)
	Sig. (2-tailed)	0	0.001	0.001	0.053	0	0.006	.	0.006	0	0
	N	38	38	38	38	38	38	38	38	38	38
X ₈	Pearson correlation	0.808(**)	-0.805(**)	-0.112	0.868(**)	0.798(**)	0.676(**)	-0.437(**)	1	-0.498(**)	-0.391(*)
	Sig. (2-tailed)	0	0	0.505	0	0	0	0.006	.	0.001	0.015
	N	38	38	38	38	38	38	38	38	38	38
X ₉	Pearson correlation	-0.458(**)	0.583(**)	0.261	-0.495(**)	-0.391(*)	-0.382(*)	0.548(**)	-0.498(**)	1	0.537(**)
	Sig. (2-tailed)	0.004	0	0.113	0.002	0.015	0.018	0	0.001	.	0.001
	N	38	38	38	38	38	38	38	38	38	38
OSD	Pearson correlation	-0.527(**)	0.506(**)	0.486(**)	-0.273	-0.572(**)	-0.395(*)	0.998(**)	-0.391(*)	0.537(**)	1
	Sig. (2-tailed)	0.001	0.001	0.002	0.097	0	0.014	0.00	0.015	0.001	0.00
	N	38	38	38	38	38	38	38	38	38	38

**Correlation is significant at the 0.01 level (2-tailed); *Correlation is significant at the 0.05 level (2-tailed)

Table 7: Multiple parameter regression coefficients

Model variables	Unstandardized coefficients		Standardized coefficients		
	β	SE	β	t-value	Sig.
Constant	-0.057	0.064		-0.880	0.387
X_1	0.337	0.063	0.006	5.359	0.000
X_2	-0.069	0.023	-0.005	-2.971	0.006
X_3	-0.045	0.001	-0.045	-49.810	0.000
X_4	0.054	0.017	0.006	3.147	0.004
X_5	0.807	0.031	0.054	25.702	0.000
X_6	0.088	0.017	0.007	5.218	0.000
X_7	0.050	0.000	1.069	828.155	0.000
X_8	0.117	0.037	0.007	3.176	0.004
X_9	-0.020	0.016	-0.001	-1.218	0.233

The strength of the correlations for the analyzed independent variables to the dependent variable (OSD) are sequenced from strongest to the weakest as:

$$X_7 \rightarrow X_3 \rightarrow X_9 \rightarrow X_1 \rightarrow X_2 \rightarrow X_3 \rightarrow X_6 \rightarrow X_8 \rightarrow X_4 \quad (17)$$

The unstandardized coefficients in [Table 3](#) are the coefficients β_i for [Eq. 16](#). The independent variables in [Table 6](#) are often measured in different units. It is difficult to compare the unstandardized coefficients (β 's) to each other. The standardized coefficients or betas are an attempt to make the regression coefficients more comparable. The t-statistic helps determine the relative importance of each variable in the model. The larger values are the more important the parameters in the model. The t-statistics in [Table 7](#) show that X_7 , X_3 , X_5 and X_1 are the most important influence factors for OSD, compared to the other contributing factors. Type of contract X_9 has the smallest t-value compared to the other factors listed. This means that type of contract is the least important influence factor among the independent variables. The t-statistic and its significance value are used to test the null hypothesis that the regression coefficient is zero. With regard to the multiple parameter regression results, the relationship between independent variables and OSD can be established as:

$$\begin{aligned} \text{OSD} = & -0.057 + 0.337X_1 - 0.069X_2 - 0.045X_3 + 0.054X_4 + 0.807X_5 \\ & + 0.088X_6 + 0.05X_7 + 0.117X_8 - 0.02X_9 + \epsilon \end{aligned} \quad (18)$$

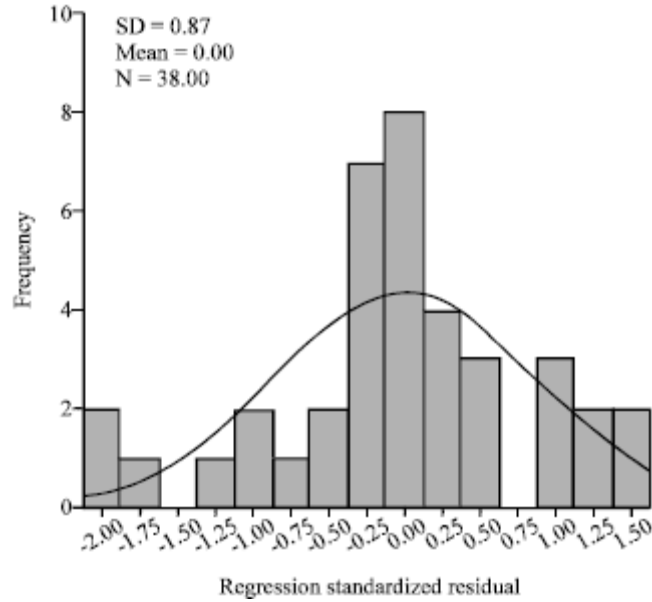

Fig. 8: Histogram of regression standardized residual

Table 8: Actual and predicted OSD resulted from the proposed model for Parvadeh coal mine (in Tabas)

Variables	Values
Mine	Parvadeh
X_1	0.48
X_2	1.36
X_3	25.80
X_4	2.00
X_5	3.00
X_6	3.00
X_7	333.50
X_8	0.80
X_9	1.00
Actual OSD (%)	20.10
Predicted (%)	18.40

As defined in Eq. 12, ε is a random variable and usually is referred to as the random deviation or random error term. When ε is normally distributed, the ε term vanishes. This can be tested by plotting a histogram of the data with a normal curve superimposed to see if the data appear to be normally distributed. Figure 8 shows the histogram of regression standardized residual. It shows a reasonable fit to a normal distribution, so Eq. 18 becomes:

$$\text{OSD} = -0.057 + 0.337X_1 - 0.069X_2 - 0.045X_3 + 0.054X_4 + 0.807X_5 + 0.088X_6 + 0.05X_7 + 0.117X_8 - 0.02X_9 \quad (19)$$

The statistical significance and validity of the presently derived model was checked by comparison of actual and predicted OSD. For this comparison, field data were collected from Parvadeh (in Tabas) coal mine as shown in Table 8. In Table 8, there is insignificant discrepancy between the actual and predicted OSD. Therefore, the

model presented can be adopted to develop mine specific design tools for the prediction of OSD associated with a proposed mine design.

DISCUSSION

The assessment of earlier methods shows that the OSD have only been determined by the sampling and assaying from the coal layer and mined coal in longwall mining method. Since, these methods do not adequately or specifically consider factors affecting on OSD, prediction errors may be expected when using them. Therefore, in this study, parametric statistical studies were undertaken to examine the impact of a variety of factors on OSD in the prop-free front of the longwall face. Based on the collection and analysis of a large number of case histories from field-collected data, a relationship between OSD and contributing factors was derived from the statistical analysis. The statistical analysis results showed that each parameter included in the analysis had a certain contribution to OSD. Hence, this method is a powerful tool for OSD estimation and prediction, without any sampling and assaying process, compared to the previous methods.

CONCLUSION

The research presents the results of a study of the factors causing OSD or dilution in longwall coal mines. The main sources and factors influencing OSD for each source with a detailed description have been presented to quantify OSD. A statistical analysis was conducted to evaluate the relationship between OSD and some of its effective parameters such as variation in seam thickness, seam thickness, dip of seam, cutting methods, roof quality, floor quality and depth of seam, hydraulic radius and type of contract. This analysis shows that depth of seam, dip of seam, roof quality and variation in seam thickness are the most important influence factors and type of contract is the least important influence factor for OSD. The validity of the presented model was assessed by comparison of actual and predicted OSD in Parvadeh coal mine and may be utilized for similar mines. The results clearly show that the OSD prediction error for this coal mine data assessed using the presented model is very low.

ACKNOWLEDGMENTS

Author would like to thank the Tabas Mines and Kerman Mines who allowed me to collect data and provided the with valuable assistance for the study. Special thanks go to Mr. Moqadam for their assistance with my field work.

References

- Annels, A.E., 1996. Mineral Deposit Evaluation. A Practical Approach. 1st Edn., Chapman and Hall, UK., ISBN: 0903317796.
- Brady, B.H.G. and E.T. Brown, 2004. Rock Mechanics for Underground Mining. 3rd Edn., Allen and Unwin, London, ISBN: 9781402021169.
- Chugh, Y. and A. Moharana, 2005. Dilution in underground coal mining in USA- Impacts on production, processing and waste disposal. Proceedings of the International Conference on Mineral Processing Technology, Jan. 6-8, New Dehli, India, pp: 10-20.
- Clark, L.M., 1998. Minimizing dilution in open stope mining with a focus on stope design and narrow vein longhole blasting. Msc. Thesis. University of British Columbia, Canada.
- Devore, J.L., 1995. Probability and Statistics for Engineering and the Sciences. 4th Edn., Duxbury Press, Boston, ISBN: 0534242669.
- Hartman, H.L., 1992. Mining Engineering Handbook. 2nd Edn., SME, Colorado, ISBN: 0873351002.
- Henning, J.G. and H.S. Mitri, 2007. Numerical modelling of ore dilution in blasthole stoping. Int. J. Rock Mech. Min. Sci., 44: 692-703.
[CrossRef](#) |
- Laubscher, D.H., 1977. Geomechanics classification of jointed rock mass-mining applications. Trans. Inst. Min. Metall, 86: A1-A8.
- Noppe, M., 2003. The measurement and control of dilution in an underground coal operation. Proceedings of the 5th International Mining Geology Coferene, Nov. 17-19, Bendigo, pp: 189-195.
- Pakalnis, R., 1986. Empirical stope design at ruttan mine. Ph.D. Thesis. University of British Colombia, pp: 276.
- Peng, S.S. and H.S. Chiang, 1984. Longwall Mining. 3rd Edn., Wiley, New York, ISBN: 0471868817.
- Peng, S.S., 1986. Coal Mine Ground Control. 3rd Edn., Wiley, New York, ISBN: 0471041211, pp: 237-264.
- Popov, G., 1971. The Working of Mineral Deposits. 2nd Edn., Mir Publishers, Moscow.
- Richard, E., Gertsch and L. Richard, 1998. Techniques in Underground Mining. 1st Edn., Society for Mining Metallurgy and Exploration, Inc., USA., ISBN: 0873351630.
- Saeedi, G., B. Rezaie and K. Shahriar, 2008. Quantifying level of out-of-seam dilution for long wall mining method and its impact on yield of coal washing plant in tabas coal mine. Proceedings of the International Seminar on Mineral Processing Technology (MPT), Apr. 22-24, Trivandram, India, pp: 370-373.

Stefanco R., 1983. Coal Mining Technology Theory and Practice. 3rd Edn., Society of Mining Engineers, SME, American Institute of Mining, Metallurgical and Petroleum Engineers, Inc., USA., ISBN: 0 89520 404 5.

Suorineni, F.T., D.D. Tannant and P.K. Kaiser, 1999. Determination of fault-related sloughage in open stopes. Int. J. Rock Mech. Min. Sci., 36: 891-906.
[Direct Link](#) |

Wang, J., 2004. Influence of stress, undercutting, blasting and time on open stope stability and dilution. Ph.D. Thesis. University of Saskatchewan, Saskatoon.

Whittaker, B.N., 1974. An appraisal of strata control practice. Min. Eng., 166: 9-24.