

# A Mode-Filtering Scheme for Improvement of the Bandwidth-Distance Product in Multimode Fiber Systems

Zygmunt Haas, *Senior Member, IEEE*, and Mario A. Santoro, *Member, IEEE*

**Abstract**—In this paper, we investigate a scheme in which the *bandwidth-distance* product of a multimode fiber is extended, so that it can nearly support the transmission rate of single-mode systems. Some pioneering work suggest that limited mode launch may improve the system performance by reducing the modal dispersion and increasing the system bandwidth. The scheme investigated in this paper is based on selective launching of lower order modes into the fiber at the transmitting end and on filtering out at the receiver the fraction of the energy that was coupled into the higher order modes throughout the propagation in the multimode fiber. We investigate here the power penalty and the dispersion performance of the scheme. In particular, we show that the scheme carries about 6.5-dB penalty and we demonstrate doubling of the *bandwidth × distance* value. Moreover, the effect of splices on the scheme performance is also presented. We envision that the scheme may be used for upgrading the existing multimode systems without the need to rewire these installations. For example, the scheme can be used to replace the FDDI installations with future high-speed networks, when transmission rates increase from megabits per second to gigabits per second.

## I. INTRODUCTION AND MOTIVATION

THE motivation behind this work is to propose a scheme that will enable an easy (i.e., economical) upgrade of a communication system based on optical multimode fiber from a network operating at tens to hundreds of megabits per second, such as fiber distribution data interface (FDDI), to a network capable of supporting gigabit per second transmission. On one hand, the relatively large amount of multimode fibers already deployed in buildings for FDDI and similar LAN's will not, presently, support such an increase in speed to gigabits per second. On the other hand, the recent increased interest in very-high-speed networks, may shortly turn the gigabit per second communication networks into reality. Thus a technique that will enable reuse of the multimode fibers in high-speed transmission is of particular importance. Moreover, some system designs call for the use of multimode fibers, such as some military installations. Our scheme can be used in these cases to support increased transmission rates.

Multimode fibers were widespread when the first optical systems were designed, because it was easier and cheaper to work with a multimode fiber than with a single-mode fiber. In fact, some standards call for multimode fibers (*FDDI*).

However, the *bandwidth-distance* product of the multimode fiber is much smaller than the *bandwidth-distance* product of a single-mode fiber. Thus when increase in the transmission rate in a multimode system is needed, it may be required to rewire the whole system with single-mode fiber. This may be, of course, quite an expensive proposition in many circumstances.

The potential of multimode fibers for high-bandwidth transmission, as well as evaluation of the performance of multimode fiber dispersion was described in several papers. Mode-dependent characteristics, such as attenuation, for example, were explored by various researchers (e.g., [1]). Impulse response and the obtainable data rates of multimode fibers investigated in [2] indicating that mode coupling may, in fact, reduce the effect of modal dispersion.<sup>1</sup> In [3], a study of lower order mode launching is described for the purpose of learning the relative contribution of wall imperfections and bends to the mode-mixing phenomenon. The study concludes that the amount of mode conversion due to wall imperfection is negligible and that it is expected that single-mode operation may be possible over considerable distances. A study of multimode liquid-core fibers in [4] shows that pulse dispersion depends on launched mode distribution and on mode conversion, which is primarily a result of the band radius. Furthermore, [4] suggested that mode filtering by selectively absorbing higher order modes can be used to maintain wide bandwidth. Similarly, [5] reports on the dependence of pulse broadening in high-loss multimode fibers, concluding that axial launching into the core is essential for minimum dispersion. Several authors dealt with analytical estimation of system response. For example, [6] proposes a bundle ray model with angular distribution of power characteristic to Gaussian beam and [7] models the response of a concatenated system for the low- and the high-order modes. It is suggested in [7] that the system performance depends on the actual distribution of power among the propagated modes.

Based on the above studies, we propose here a practical scheme, in which the *bandwidth-distance* product of a multimode fiber can be easily extended to support nearly the same transmission rate as the single-mode system. The performance of the scheme are investigated.

Manuscript received February 4, 1992; revised December 1, 1992.  
The authors are with AT&T Bell Laboratories, Holmdel, NJ 07733.  
IEEE Log Number 9207460.

<sup>1</sup>It is pointed out in [2] that the loss associated with the coupling may limit the usefulness of such a scheme.

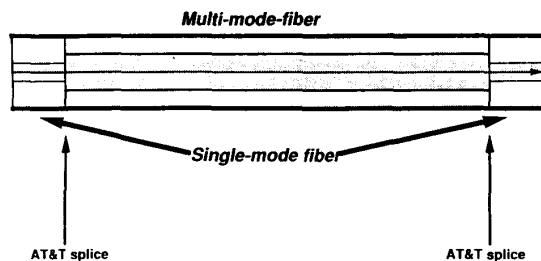

Fig. 1. Principle of the proposed scheme for extension of the bandwidth-distance product in multimode fibers.

## II. EXTENDING THE BANDWIDTH-DISTANCE PRODUCT FOR MULTIMODE FIBERS

Since modal dispersion in a direct detection system is a multipath, nonlinear phenomenon, it can be partially corrected by nonlinear post-detection adaptive filtering. We, however, propose here a scheme that operates in the optical domain. The idea behind the scheme is to reduce the number of propagated modes by launching a limited number of lower order modes into the multimode fiber and by recovering a limited number of modes on reception. The principle of the scheme is shown in Fig. 1, where we show ideal propagation in a single-mode fiber. By exciting a limited number of lower order modes, only a small portion of the total power will be coupled into the other modes. And since only the lower order modes are retrieved at the receiving end, the power contributing to the modal dispersion is considerably reduced. The residual modal dispersion is created by two elements: the modal dispersion among the lower order modes, and the power coupled from the lower order modes into the higher order modes and back into the lower order modes. This second element is relatively small, as suggested in [8]. Consequently, the expected penalty of the filtered systems as opposed to a regular single-mode system is relatively low. We investigate this penalty in this paper.

The basic experimental setup is shown in Fig. 2. 2.3 km of multimode fiber is placed on a spool.<sup>2</sup> The fiber was manufactured by AT&T with the following parameters: 62.87  $\mu\text{m}/125.24 \mu\text{m}$  core/cladding diameters, attenuation of 0.86 dB/km at 1300  $\mu\text{m}$  and bandwidth  $\times$  distance of 1114 MHz at 1300  $\mu\text{m}$ .<sup>3</sup> The laser is ASTROTEC 1216D. The receiver is ASTROTEC 1306AA, with capability of up to 1.7 Gb/s.

The laser terminates with a single-mode fiber (9- $\mu\text{m}$  core) pigtail. An attenuator was placed after the laser and an additional 1.6 m of single-mode jumper connects between the multimode fiber spool and the attenuator. This connection, which performs the initial filtering by launching only the lower order modes into the multimode fiber, is made with an AT&T rotary splice. These lower order modes propagate through the multimode fiber with relatively small coupling of power into the other modes. At the receiver side, the multimode fiber

<sup>2</sup>The FDDI standard defines 2 km as the maximal distance between adjacent nodes on the ring.

<sup>3</sup>This is rather high bandwidth  $\times$  distance value; four other samples are between 577 and 748 MHz  $\cdot$  km. We chose the 1114 MHz  $\cdot$  km fiber to demonstrate the "worst case" improvement. And still with this relatively high bandwidth-distance product, our scheme demonstrates quite significant improvement.

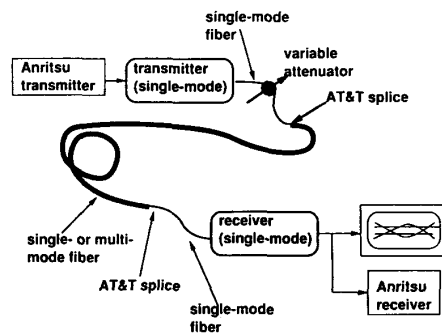

Fig. 2. The experimental setup.

is coupled by another AT&T rotary splice to a single-mode jumper of length 1.6 m, which is, in turn connected to the receiver pigtail. This splice at the receiver side provides the filtering means that removes higher order modes, which were excited by fiber-mode coupling from the initially launched modes.

Both of the elements of the proposed technique are essential: launching of the lower order modes and retrieving of the lower order modes. Launching of the lower order modes has two important implications: it concentrates most of the energy near the center of the fiber core, from where the energy is filtered at the receiving end, and reduces the amount of energy in the higher order modes, thus reducing the effect of modal dispersion from the coupling of the higher order modes into the lower ones.

In order to learn how the spatial distribution of the launched signal changes with propagation through the fiber, we looked at the near field emerging from a multi mode fiber in three different configurations. The near field was observed by focusing the output of multimode fiber on a CCD camera. First, we observed the near field of a multimode fiber with large number of modes excited (Fig. 3). This gives us the reference to calculate the spatial distribution of other cases (since the diameter of the multimode fiber is known to be 62.5  $\mu\text{m}$ ). The near-field distribution of a short piece of multimode fiber after launching the lower order modes is displayed in Fig. 4. The size of the beam is approximately 9  $\mu\text{m}$ , which corresponds to the size of the launched beam coming from single-mode fiber. Fig. 5 shows the size of the 9- $\mu\text{m}$  beam after propagation through 2 km of multimode fiber. The beam size appears to be  $\approx 15 \mu\text{m}$ , or only 1.7 times larger than the launched beam. These figures demonstrate that the beam remains more or less contained to the center of the core after passing the 2-km distance.

## III. PERFORMANCE OF THE SCHEME

Two performance criteria have to be considered here: signal attenuation and residual modal dispersion.

Signal attenuation is created by the filtering operation. The splice at the transmitter side introduces little loss of the optical signal, since all the energy in the single-mode fiber is concentrated in the lower order modes that is fully coupled into the multimode fiber. This is not the case at the receiving splice, where the filtering of the higher order modes removes

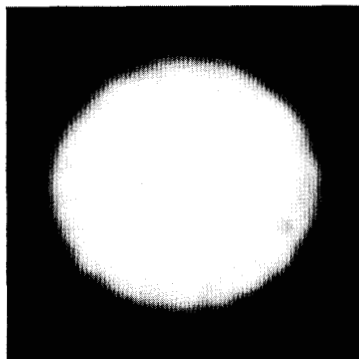

Fig. 3. Near-field distribution of a multimode fiber with all modes excited.

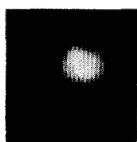

Fig. 4. Near-field distribution of a short piece of MM fiber coupled to 9-μm beam.

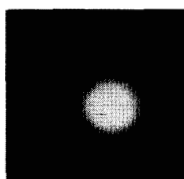

Fig. 5. Near-field distribution of 2 km of MM fiber coupled to 9-μm beam.

some of the signal energy and thus results in some loss. The amount of this loss is difficult to calculate, since it is created by the mode-coupling phenomenon in the multimode fiber, where the spatial distribution of energy is not uniform. Moreover, this loss increases with distance, since the amount of coupling increases with distance. Some references quote quite a large loss (about 19 dB) at the multimode-to-single-mode junction ([9]). However, these references assume uniform distribution of energy or excitation of many modes in the multimode fiber. Obviously, this is not the case here. In order to evaluate the actual loss in our case, an experiment, shown in Fig. 6 was conducted. By varying the laser current supply, the power launched into the fiber under test was varied. The results are summarized in the following table ( $P_1$  and  $P_2$  are defined in Fig. 6):

$P_1$ [dBm]	$P_2$ [dBm]	Loss [dB]
-25.0	-30.40	-5.40
-20.0	-24.92	-4.92
-15.0	-20.56	-5.56
-10.0	-15.28	-5.28
-5.0	-9.69	-4.69
-0.0	-5.43	-5.43
+3.0	-2.10	-5.10

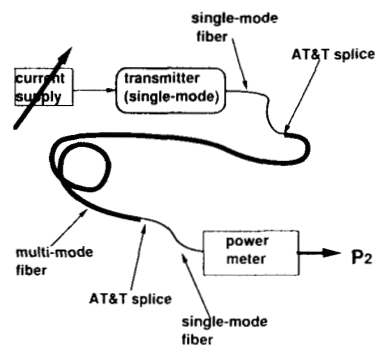
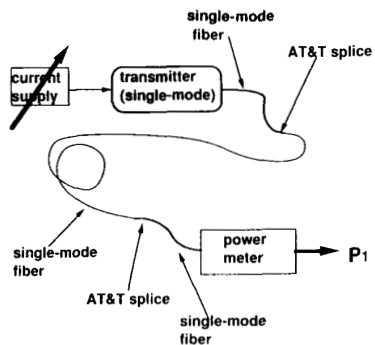

Fig. 6. Measuring the power and the loss of the filtering technique.

As evident from the above table, the excess loss for the above setup is on the order of 5 dB. This 5 dB is in good agreement with the observed beam divergence in Figs. 4 and 5. From these figures, a launched beam of 9 μm diverged to a beam of 15 μm in 2 km of multimode fiber. Coupling the 15-μm beam into 9-μm single-mode fiber results in a loss equal to square of the ratio of the two beams; i.e., 4.4 dB.

Besides the power loss, the scheme may still have some residual dispersion, since some of the power from the lower order modes is coupled into the higher order modes and back into the lower order modes. We evaluate this dispersion by comparison of the BER performance of the filtered multimode transmission with the single-mode system. In order to do so, we measured in both of the systems the BER as a function of bit rate with received power as a parameter. The tests were done using the a Bit-Error Rate tester and  $2^{10} - 1$  PN sequence. The results are shown in Fig. 7. In Fig. 8, the BER is shown as a function of received power, for a selected number of bit rates. As a point of reference, the BER of the filtered system at 1 Gb/s and -30 dBm is about  $10^{-9}$ .

In Figs. 9 and 10, the performance of the same setup but with single-mode fiber instead of the multimode fiber is shown. At 1 Gb/s, the required received power for  $10^{-9}$  BER is -31.5 dBm; i.e., about 1.5-dB penalty in the filtered system. Figs. 11 and 12 superimpose the performance of the filtered and the single-mode systems. For large bit rate and small received power, the two curves are close to each other, indicating that the performance of the system is limited by other than modal

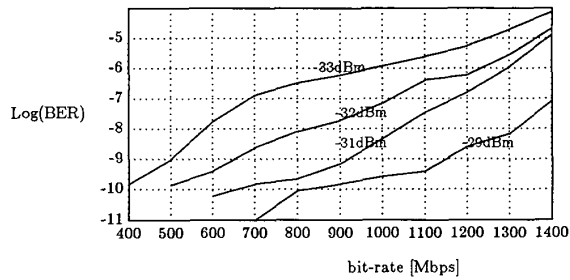

Fig. 7. Performance of the filtered system: BER versus bit rate.

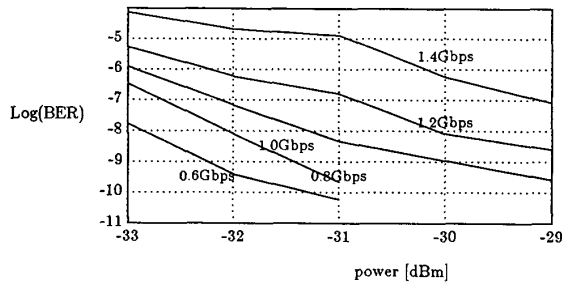

Fig. 8. Performance of the filtered system: BER versus received power.

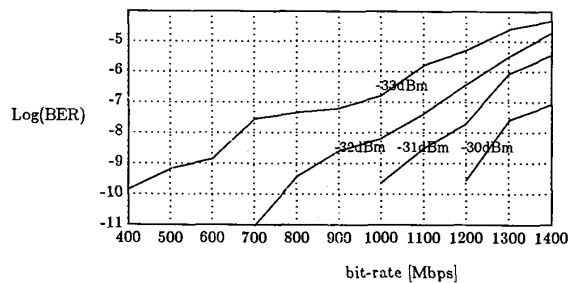

Fig. 9. Performance of the single-mode system: BER versus bit rate.

dispersion.<sup>4</sup> In the dispersion-limited regions, the penalty is between 1.0 to 1.5 dB for the filtering system. Thus coupled with the loss penalty due to the filtering operation of 5 dB, the total system penalty is about 6.5 dB. The *bandwidth*  $\times$  *distance* product for the filtered system is 2185 MHz  $\cdot$  km, and is calculated from Figs. 7, 9, and 12 by noting that the penalty of the system is about 1 dB at 950 MHz. Thus the improvement is nearly double the *bandwidth*  $\times$  *distance* product; i.e., from 1114 to 2185 MHz  $\cdot$  km. Even more dramatic improvement is achieved with multimode fiber with lower *bandwidth*  $\times$  *distance*, as was the case with the other multimode samples (see footnote 2).

Next, we demonstrate the improvement in dispersion by the use of the mode filtering technique. In order to do so, the following set of experiments was performed:

1. Multimode launching, Multimode fiber, Multimode receiver (MM-MM-MM);

<sup>4</sup>In fact, the performance in these regions is limited by the receiver, whose sensitivity for  $3 \times 10^{-11}$  is  $-32$  dBm at 1.7 Gb/s.

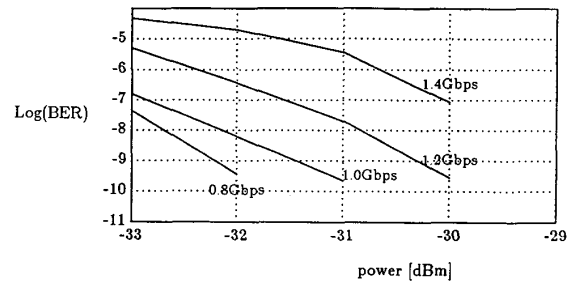

Fig. 10. Performance of the single-mode system: BER versus received power.

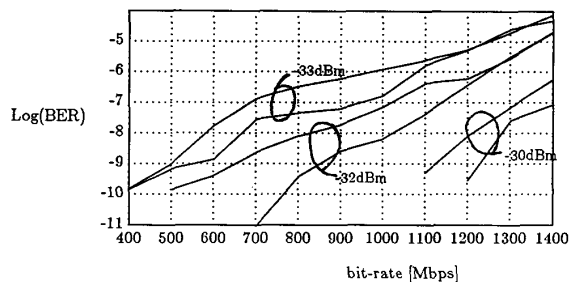

Fig. 11. Comparison of the systems: BER versus bit rate.

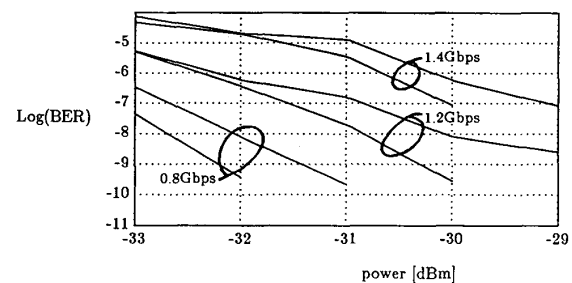

Fig. 12. Comparison of the systems: BER versus received power.

2. Multimode launching, Multimode fiber, Single-mode receiver (MM-MM-SM);
3. Single-mode launching, Multimode fiber, Multimode receiver (SM-MM-MM);
4. Single-mode launching, Multimode fiber, Single-mode receiver (SM-MM-SM)—this is the proposed scheme;
5. Single-mode launching, Single-mode fiber, Single-mode receiver (SM-SM-SM).

To perform these experiments, a mode scrambler (Model FM-1 Newport Corp.) was placed on the multimode fiber and an additional receiver with multimode pigtail was employed. The modified setup is shown in Fig. 13. The mode scrambler simulates the mode mixing as if a multimode fiber pigtail were coupled to a laser.<sup>5</sup> The multimode pigtailed receiver couples all the received modes to the detector. The resulting waveforms were recorded in Figs. 15–19. All the experiments

<sup>5</sup>We assume that the mode scrambling simulated in this way is sufficient for the purpose of our comparison.

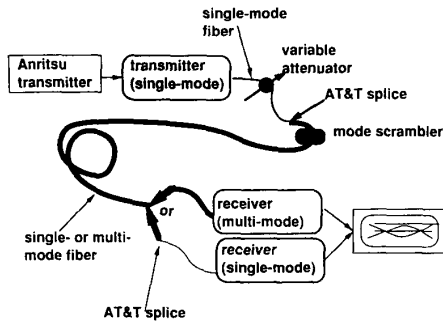

Fig. 13. The modified experimental setup.

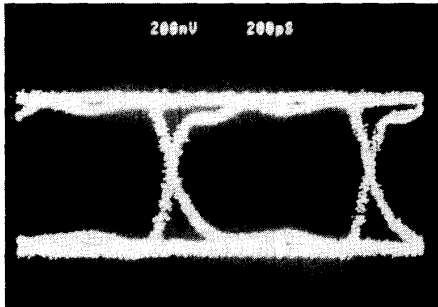

Fig. 14. Eye diagram for the direct connection.

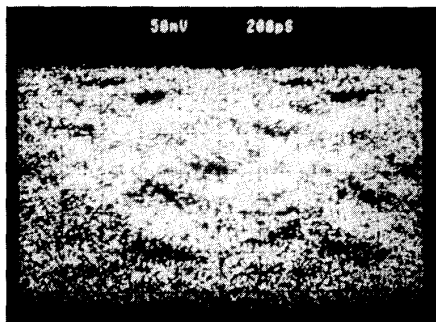

Fig. 15. Eye diagram for the MM-MM-MM experiment.

were performed at 1 Gb/s using the  $2^{10} - 1$  PN sequence, with a 2.3-km multimode fiber.

The eye diagram in Fig. 14 is the direct connection of the transmitter to the scope; i.e., without the optical link. Fig. 15 shows the amount of intersymbol interference for full multimode system operating at 1 Gb/s. Obviously, errorless reception cannot be achieved without any post-detection processing, since the eye is completely closed. The reception is significantly improved when a mode filter is placed either at the transmitting end (Fig. 16) or at the receiving end (Fig. 17). When both the changes are made simultaneously (filtering at the input and at the output), the performance is close to that of the full single-mode fiber system, as evidence from Figs. 18 and 19 (the fully single-mode system).

Finally, we investigate in Fig. 20 the effect of the splices on the performance of the proposed scheme. In this figure, the BER is shown as a function of the received power with

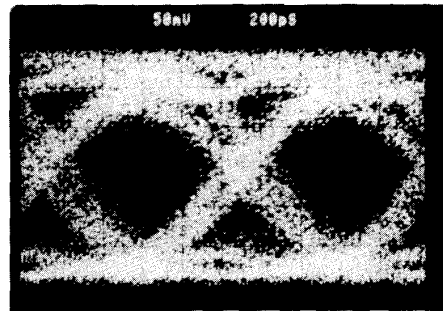

Fig. 16. Eye diagram for the SM-MM-MM experiment.

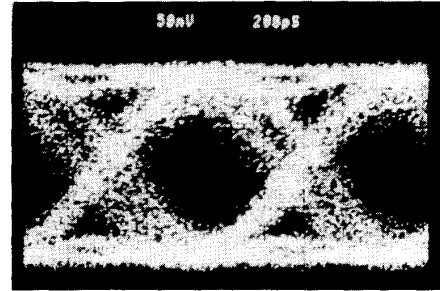

Fig. 17. Eye diagram for the MM-MM-SM experiment.

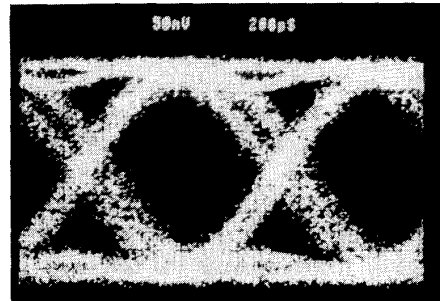

Fig. 18. Eye diagram for the SM-MM-SM experiment.

a number of 1-m segments as a parameter. Each segment is equipped with rotary splices on both ends. Thus in the one segment configuration, there are two additional splices on the multimode fiber, besides the basic configuration in Fig. 2. The experiment was performed with approximately 2 km of multimode fiber. As the number of splices increases, there is an increase in the BER. However, this increase is relatively small for 1 or 3 segments. Thus our conclusion is that for small number of splices on the multimode filter (say, up to four), the degradation is rather limited.

To evaluate the performance of the scheme as a function of time, the experiment was left running for a period of two weeks. No evident changes in the performance were noticed. However, the scheme may suffer from mechanical perturbations. In other words, the launching and the receiving splices need to be optimized for best performance. Changes in this setting may considerably affect the scheme performance. Moreover, twisting and bending of the fiber may also affect the

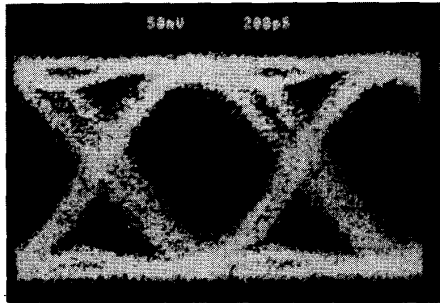

Fig. 19. Eye diagram for the SM-SM-SM experiment.

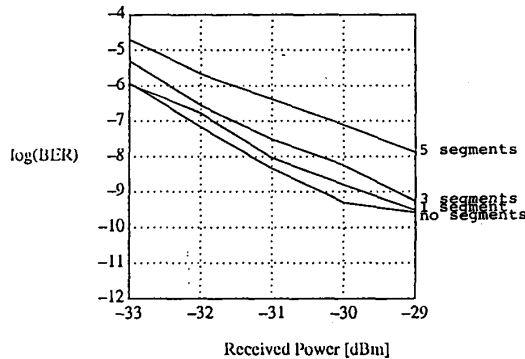

Fig. 20. The effect of splices on the BER performance.

results. Thus it is important that the multimode fiber remains relatively stationary. This would be achieved in wall wiring or in reinforced cables, for example, but may not hold true for loose fiber.

#### IV. SUMMARY, DISCUSSION, AND CONCLUDING REMARKS

The presented scheme extends the *bandwidth-distance* product of a multimode fiber to facilitate upgrading of the existing networks, such as FDDI, wired with multimode fiber, from hundreds of megabits per second to gigabit per second transmission rates. (A similar technique used in a different environment was proposed in [10].) In particular, we have demonstrated that using this technique, 1-Gb/s signal at  $-30$  dBm can be transmitted over 2.3 km of multimode fiber with an error rate of  $1 \times 10^{-9}$ . The penalty of the scheme is approximately 6.5 dB and an improvement of doubling the *bandwidth-distance* product can be achieved, even with multimode fiber with initially large *bandwidth-distance* product. The effect of up to four splices on a 2-km multimode link is relatively limited.

We have concentrated in this paper on the propagation through lower order modes. However, an alternative scheme is possible, in which higher order modes are used. Such a scheme may have, on one hand, the advantage of lower coupling between the modes and, on the other hand, the disadvantage of the more sophisticated launching method. Moreover, because of the lower coupling between the higher order and the lower order modes, and among the higher order modes, filtering at the receiving end may be unnecessary. Since the receiving

filtering is mostly responsible for mechanical susceptibility, the use of the higher order modes for propagation may prove to be a more practical scheme. Also, if no receiving filtering is performed, the power penalty is significantly reduced.

Use of the proposed schemes may have significant economical consequences, when connectivity approaching gigahertz per second rates is needed in the already existing, prewired environments.

#### REFERENCES

- [1] R. Olshansky and D. A. Nolan, "Mode-dependent attenuation of optical fibers: Excess loss," *Appl. Opt.*, vol. 15, no. 4, Apr. 1976.
- [2] D. Gloge, "Impulse response of clad optical multimode fibers," *Bell Syst. Tech. J.*, vol. 52, no. 6, pp. 801-816, July-Aug., 1973.
- [3] W. A. Gambling *et al.*, "Mode excitation in multimode optical-fibre waveguide," *Electron. Lett.*, vol. 9, no. 18, Step. 6, 1973.
- [4] W. A. Gambling, D. N. Payne, and H. Matsumura, "Gigahertz bandwidths in multimode, liquid-core, optical fibre waveguides," *Opt. Commun.*, vol. 6, no. 4, Dec. 1972.
- [5] W. A. Gambling *et al.*, "Pulse dispersion in glass fibers," *Electron. Lett.*, vol. 7, no. 18, Sept. 9, 1971.
- [6] W. A. Gambling *et al.*, "Propagation model for multimode optical-fibre waveguide," *Electron. Lett.*, vol. 8, no. 10, May 18, 1972.
- [7] G. T. Holmes, "Estimation of concatenated system response based on measured transfer function for low and high order modes," in *Proc. 7th European Conf. on Optical Communication* (Copenhagen, Denmark, Sept. 8-11, 1981), pp. 3.4-1-3.4-4.
- [8] S. Shaklan, "Measurement of intermodal coupling in weakly multimode fibre optics," *Electron. Lett.*, vol. 26, no. 24, Nov. 22, 1990.
- [9] E.-G. Neumann, *Single-Mode Fibers*. Berlin, Germany: Springer-Verlag, 1988, pp. 219.
- [10] M. Stern *et al.*, "Short-wavelength transmission on 1300 nm optimized single-mode fiber," in *SPIE vol. 841 Fiber Optic Networks and Coherent Technology in Fiber Optic Systems II*, 1987.



**Zygmunt Haas** received the B.Sc. degree in electrical engineering, in 1979 and the M.S. degree in electrical engineering, in 1985, both with "Summa Cum Laude." From 1979 to 1985 he worked for the Government of Israel. In 1988, he earned the Ph.D. degree from Stanford University, researching fast optical packet-switched networks.

Subsequently, he joined AT&T Bell Laboratories in Holmdel, NJ, where is now a Member of Technical Staff. He is an author of numerous technical papers and holds several patents in the field of optical switching and optical networking, high-speed networking, and wireless networks. He has organized several Workshops and served as an editor for *Computer Networks* and *ISDN Systems* journal and as a guest editor for *JSAC* issues: optical switching, optical switching, mobile communication, and personal communication services.

**Mario A. Santoro** (S'85-M'87) received the professional degree in electrical engineering from the University of Rosario, Santa Fe, Argentina, in 1976, and the M.S., M.Phil., and Ph.D. degrees from the University of Columbia, New York, NY, in 1982, 1985, and 1986, respectively.

In 1976 he joined ACINDAR S.A., Villa Constitucion, Argentina, as a Design and Development Engineer where he was involved in the design of control systems. From 1978 to 1980 he worked as an assistant professor in the department of Mathematics, University of Rosario, Santa Fe, Argentina. In 1984, he joined Netek, Inc., as a research engineer working on lightwave components and systems. In 1987, he joined AT&T Bell Laboratories, Holmdel, NJ, where he conducted research in lightwave networks and systems, and photonic switching applications using WDM. Recently, he joined the newly formed Networking Center of Expertise within AT&T Bell Laboratories, Holmdel, NJ, as a principal architect to provide consultancy services for complete Networking Solutions.

Dr. Santoro is the recipient of the Edwin Howard Armstrong Memorial

Award for Outstanding Graduate Research. He has authored and co-authored over 30 papers in Lightwave Systems and hold patents on an Optical Packet Switch and on Interleave Receivers. He is a member of SPIE, the International Society of Optical Engineers, the Optical Society of America, and the LEOS representative to PACE, the professional Activity Council for Engineers.