

A Near-Term, High-Confidence Heavy Lift Launch Vehicle

William J. Rothschild¹ and Theodore A. Talay²
John Frassanito & Associates, Inc.
1350 NASA Parkway, Suite 214, Houston, TX 77058

Abstract

The use of well understood, legacy elements of the Space Shuttle system could yield a near-term, high-confidence Heavy Lift Launch Vehicle that offers significant performance, reliability, schedule, risk, cost, and work force transition benefits. A side-mount Shuttle-Derived Vehicle (SDV) concept has been defined that has major improvements over previous “Shuttle-C” concepts. This SDV is shown to carry crew plus large logistics payloads to the ISS, support an operationally efficient and cost effective program of lunar exploration, and offer the potential to support commercial launch operations. This paper provides the latest data and estimates on the configurations, performance, concept of operations, reliability and safety, development schedule, risks, costs, and work force transition opportunities for this optimized side-mount SDV concept. The results presented in this paper have been based on established models and fully validated analysis tools used by the Space Shuttle Program, and are consistent with similar analysis tools commonly used throughout the aerospace industry. While these results serve as a factual basis for comparisons with other launch system architectures, no such comparisons are presented in this paper. The authors welcome comparisons between this optimized SDV and other Heavy Lift Launch Vehicle concepts.

Nomenclature

<i>ATP</i>	=	Authority to Proceed
<i>ATV</i>	=	Automated Transfer Vehicle
<i>CEV</i>	=	Crew Exploration Vehicle
<i>EDS</i>	=	Earth Departure Stage
<i>ET</i>	=	External Tank
<i>GEO</i>	=	Geosynchronous Orbit
<i>ISS</i>	=	International Space Station
<i>JF&A</i>	=	John Frassanito and Associates
<i>LEO</i>	=	Low-Earth orbit
<i>LSAM</i>	=	Lunar Surface Access Module
<i>MECO</i>	=	Main Engine Cutoff
<i>MLP</i>	=	Mobile Launch Platform
<i>OMS</i>	=	Orbit Maneuvering System
<i>RCS</i>	=	Reaction Control System
<i>SDV</i>	=	Shuttle Derived Vehicle
<i>SSME</i>	=	Space Shuttle Main Engine
<i>SRB</i>	=	Solid Rocket Booster
<i>STS</i>	=	Space Transportation System
<i>TLI</i>	=	Trans-Lunar Injection
<i>VSE</i>	=	Vision for Space Exploration

I. Introduction

IN January 2004, President Bush announced the Vision for Space Exploration to return Americans to the Moon by 2020 as a prelude to the human exploration of Mars. In late April 2005, the NASA

¹ Retired. AIAA Member.

² Senior Engineer, NASA Retired.

Administrator commissioned that a 90-day study be conducted known as the NASA's Exploration Systems Architecture Study (ESAS, Ref. 1) in the period May - July 2005.

A major focus of the study was the launch architecture necessary to support a lunar mission. Recommendations of ESAS included a "1.5-Launch Architecture". A heavy payload launcher (subsequently called Ares V) would place a Lunar Surface Access Module (LSAM) attached to a large Earth Departure Stage (EDS) into low-Earth orbit. A smaller payload launcher (subsequently called Ares I) would launch the smaller mass Crew Exploration Vehicle (CEV) into orbit for rendezvous with the EDS+LSAM. Following docking the EDS stage would perform the necessary trans-lunar injection (TLI) burn for the combined vehicle stack sending the elements into lunar space. A number of major design changes have been made in these launchers since the original ESAS recommendations. Many have been propulsion system changes where SSME engines have been replaced with RS-68B engines for the Ares V main propulsion, 5-segment SRBs have been replaced by 5.5-segment SRBs, a new J-2X engine has replaced the upper-stage propulsion systems recommended in the ESAS study, and the replacement of the existing 4-segment Solid Rocket Booster (SRB) on Ares I with a new design 5-segment SRB. The Ares I and Ares V designs continue to evolve in efforts to meet the original lunar mission performance objectives to the degree that they are nearly all-new designs, retaining little of the Shuttle-derived heritage recommended in the ESAS study or as authorized by Congress in 2005. Such all-new designs can reasonably be expected to follow lengthy and costly development processes.

Other launch vehicle options were examined in the ESAS study. One of these was a Shuttle-Derived Vehicle based on "Shuttle-C" concepts which were studied extensively in the 1980's at NASA Marshall Space Flight Center (Ref. 2). In the Shuttle-C approach (Fig. 1), the reusable Shuttle Orbiter was replaced by an expendable cargo carrier with an attached SSME and orbit maneuver propulsion package. The NASA MSFC studies had progressed to the point that a mockup was built of the cargo/propulsion element in the 1980s. Payloads to low-Earth orbit of up to 60 mt were examined. However, the approach fell out of favor because of budgetary pressures at the time. A survey of the ESAS Final Report indicates that the only side-mount SDVs described were of this "Shuttle-C" variety where the entire cargo carrier is placed into orbit by the SSME main propulsion – in essence flying a Shuttle-type mission with the Orbiter replaced by an expendable cargo carrier.

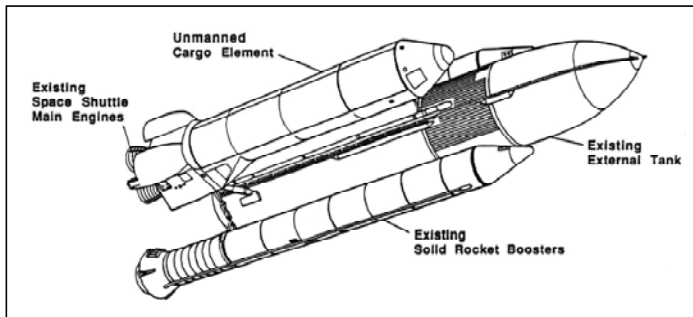

Figure 1. Example of Shuttle-C Configuration (Ref. 2)

NASA, which was formed in 2004 to study VSE implementation. The team examined several concepts in detail including an updated version of the Shuttle-C called Concept B (see Fig. 2, Ref. 3) that could deliver 68 mt to LEO, an improvement over Shuttle-C. The ESAS study, by comparison, used a similar configuration that could deliver 66 mt to the same circular low-Earth orbit.

Subsequent to Industry Team efforts, however, JF&A in 2006 re-examined the Shuttle-C operational approach of orbiting the entire payload carrier and SSME main propulsion. It was noted that the Ares V stages the Earth Departure Stage suborbitally and utilizes that stage in two distinct steps to attain a low-Earth orbit as well as conduct a trans-lunar injection (TLI) propulsive burn. The ESAS report, however, does not depict a similar suborbital stage approach with propulsion recovery module for the SDV as shown in Fig. 3.

Since before the President's Vision for Space Exploration was announced, John Frassanito & Associates, Inc. (JF&A), has been studying launch concepts for Earth-to-orbit heavy-lift missions that make extensive use of present Space Shuttle elements. JF&A participated with the Industry Team, in collaboration with

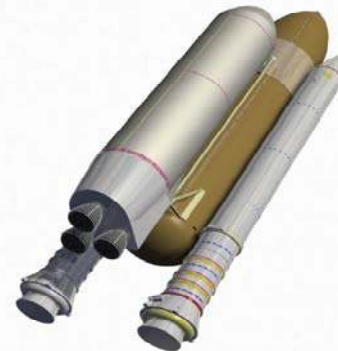

Figure 2. Industry/NASA Team Concept B Shuttle Derived Vehicle (Ref. 3)

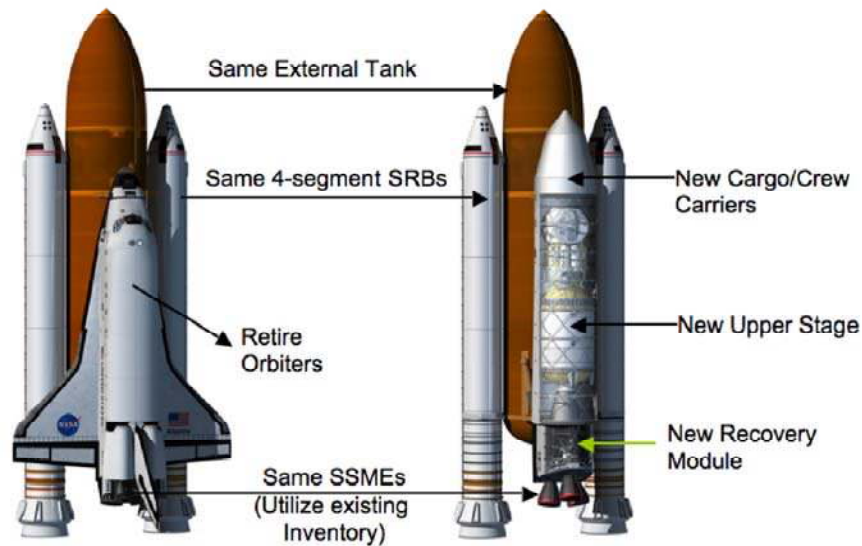

Figure 3. Sub-orbital Staging Shuttle-Derived Vehicle with Recoverable Propulsion/Avionics Module

The following important changes occur in a lunar launch architecture when a suborbital staging SDV is included in the comparisons with the recommended ESAS architecture:

- JF&A determined that, for an SDV, a suborbital staging of the payload carrier, release of the upper stage and payload, followed by a first burn of the upper stage to place the attached payload in orbit significantly improved the payload capability of the system to 78 mt (12 metric tons larger than that quoted by the ESAS for the same orbit).
- JF&A determined that for the masses of the LSAM and CEV elements for lunar exploration missions presently being considered, this suborbital staging variant of the side-mount SDV provides the necessary payload improvements to permit current reference lunar exploration missions to be conducted using only two SDV launches (not three as reported by the ESAS).
- JF&A has further determined that the side-mount SDV can be used to support crew transfer and logistics to the International Space Station reducing the number and reliance on international flights to support the U.S operating segment of ISS in the post-2015 time period.
- Further, these SDVs utilize existing 4-segment SRBs, External Tanks, and SSME main propulsion with the only major new launch elements being the side-mount carriers, the recoverable propulsion/avionics module, and an upper stage that functions to obtain a low-Earth orbit and conduct trans-lunar injection propulsive maneuvers.
- Because the Orbiter is removed from the launch system, significant reductions in processing time and recurring costs are possible.

II . Concept of Operations

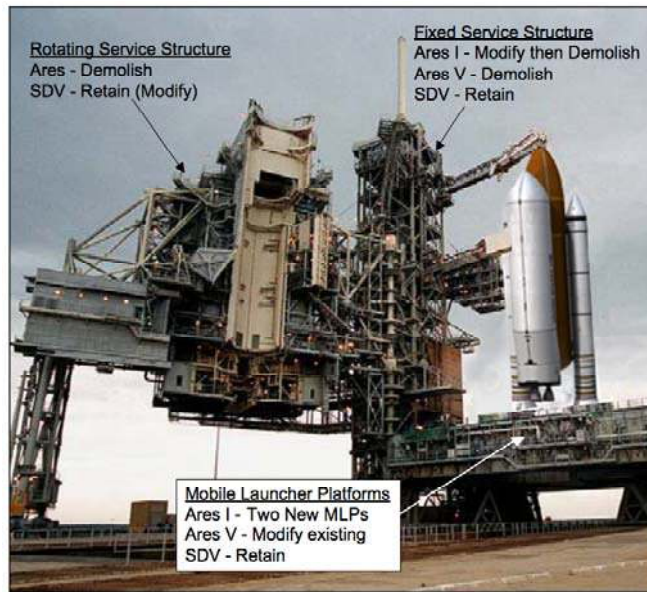

Figure 4. Examples of Ground Infrastructure Changes for Ares and SDV Launch Systems

Because the SDV configuration is similar to the present STS, the supporting SDV infrastructure will require relatively minor modifications unlike the current Ares systems which require major changes to, scrapping of, and new builds of supporting infrastructure (see Fig. 4). The Rotating Service Structure would require modifications to match the 7.5-m diameter payload carrier for the SDV. Relatively minor modifications to work platforms in the Vehicle Assembly Building and launch pad also would be necessary. Modifications of existing facilities for processing of the payload carrier and the recoverable propulsion/avionics module would be required.

Flight operations will support the example flight profile depicted in Fig. 5.

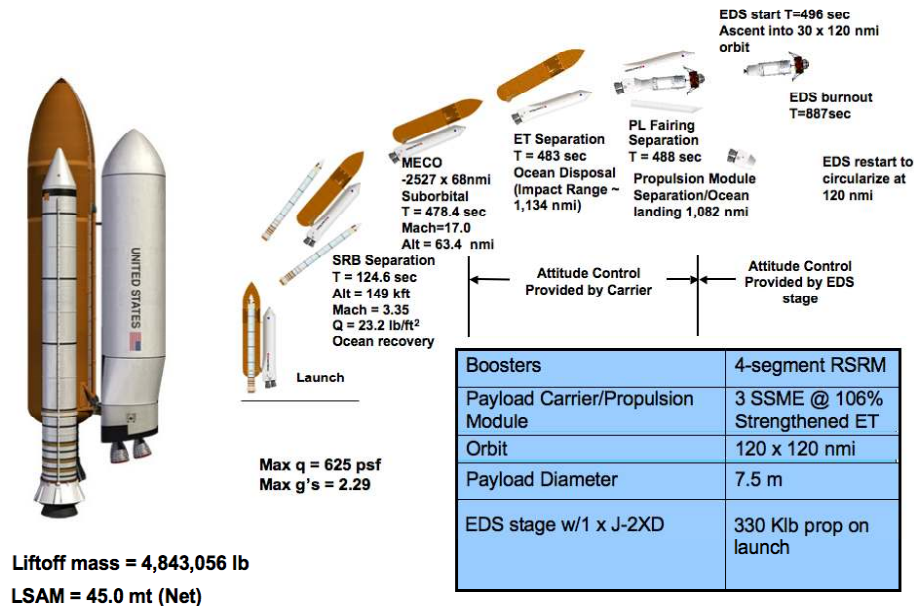

Figure 5. Flight Profile for Launch of LSAM Payload

The first phase of the launch is similar to the Space Shuttle with SRB burnout and separation at ~125 seconds after liftoff. The SSMEs are run at a 106.5% Rated Power Level which is well within the certified performance level. Maximum dynamic pressure is 625 lb/sq ft. Maximum acceleration is 2.29 g's. Ocean recovery of the SRBs follows a pattern similar to the present Shuttle. The larger overall mass of the SDV results in SSME shutdown at a suborbital Mach number of 17 and ~ 63 nmi altitude when External Tank propellants are exhausted. Over the next 20 seconds, the External Tank is jettisoned, the payload carrier fairings are jettisoned, and separation motors are fired in a posigrade manner to separate the payload and upper stage (Earth Departure Stage) from the aft recoverable propulsion module. The EDS stage engine then ignites and burns for ~ 391 seconds to achieve a preliminary 30 x 120 nmi orbit. Meanwhile, the recoverable propulsion/avionics module makes a near ballistic entry followed by parachute landing in the Atlantic Ocean ~1,100 nmi from the launch site where a recovery vessel is stationed. A second burn of the EDS main propulsion establishes a circular 120 nmi orbit.

III. Missions

Many missions are possible using the SDV described in this paper. Flying the maximum number of SDV missions supported by the present infrastructure reduces the cost of each mission. Two design references missions among these helped define the configuration described:

A. Human Lunar Missions – Design Reference Mission 1

Figure 6 depicts one possible human lunar exploration mission scenario using two nearly identical SDVs. The scenario utilizes Earth-orbit rendezvous and docking and a series-burn of the two delivered EDS stages. A total of 75-mt gross payload could be delivered to lunar space following the trans-lunar injection propulsion maneuvers. The JF&A concept analysis shows that this option meets the present human lunar mission requirements with existing propulsion system elements (4-segment SRBs and SSME) and with a less costly, early development version of the J-2X engine called J-2XD for the Earth Departure

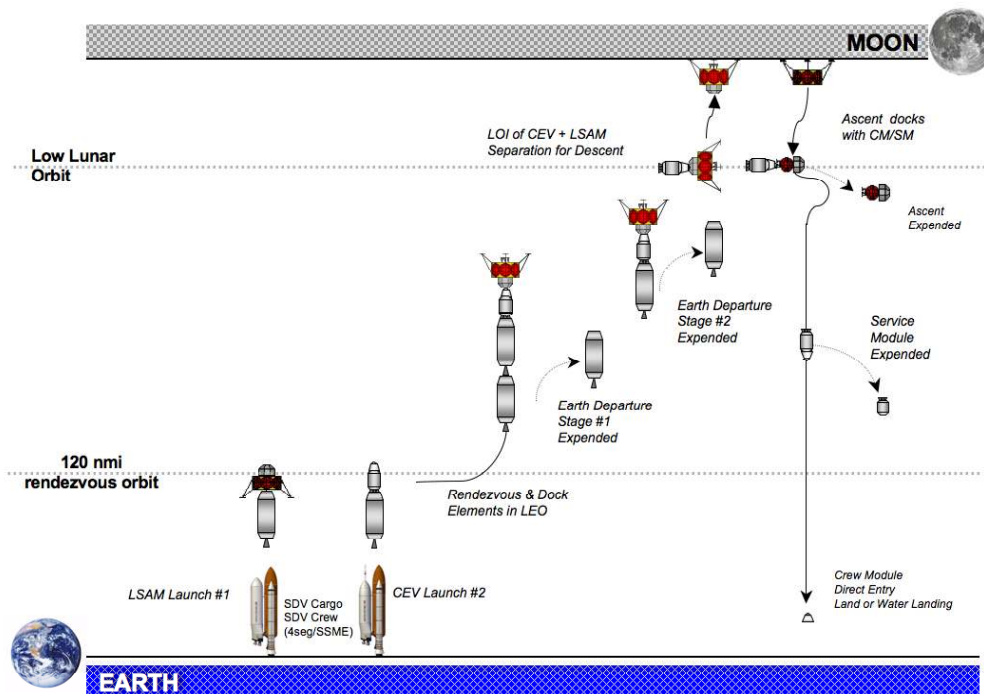

Figure 6. Lunar Exploration Mission Using Two SDV Launches

Stage (EDS). A suborbital-staged propulsion/avionics recovery module provides for the reuse of the three SSME engines, avionics, and other high value hardware. Further, the flight environment in terms of g-loads and dynamic pressures are more benign than for Shuttle, Ares I, and Ares V launches. Significant

payload margin increases of up to 11 mt could be realized using the J-2X advanced engine, 5-segment SRBs currently under development for the Ares I launcher, and running the SSMEs at 109% (as certified for the Block II SSMEs presently flying).

B. ISS Logistics Resupply – Design Reference Mission 2

The Space Shuttle has been the primary transportation system for assembly and logistics supply for the International Space Station. With a Shuttle retirement when ISS assembly is complete, a substantial annual logistics shortfall for full ISS operations is expected which will require U.S. purchases of logistics resupply capability from other international partners and potential U.S. private services if available in time. The SDV could deliver all annual logistics supplies (pressurized and unpressurized) for ISS and all crew launch services in three yearly flights. Figure 7 depicts the configurations of the SDV side-mount carriers for logistics only and mixed crew and logistics missions. The existing dual-engine Centaur stage, the ESA Automated Transfer Vehicle (ATV), and the Orion Crew Exploration Vehicle (CEV) are utilized for these purposes in this example.

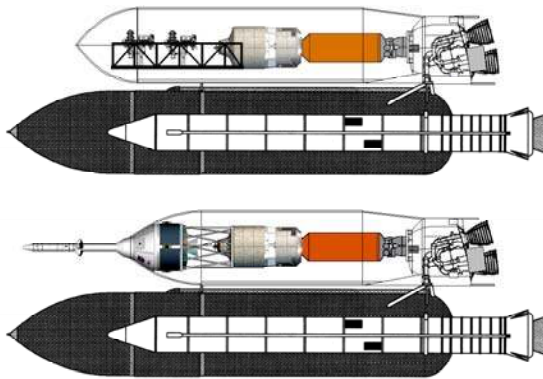

Figure 7. SDV Use for ISS Resupply and Crew Exchange

The Centaur stage and payload are separated suborbitally at Mach 18.9 with the Centaur providing the impulse necessary to achieve a low-Earth orbit. An estimated 45 mt of payload could be mounted forward of the Centaur stage. For logistics flights, the Centaur stage is not only used to achieve a low-Earth orbit, but also conducts subsequent orbit maneuvers to place the ATV and unpressurized logistics in close enough proximity to ISS for the ATV to maneuver the payload stack to ISS. An ISS arm secures the unpressurized logistics rack set while the ATV decouples itself and docks at the ISS for unloading of pressurized logistics. For

mixed crew and logistics flights, upon achieving low-Earth orbit, the Orion CEV and the ATV separate and each conducts separate orbital maneuvers, approaches, and dockings to the ISS. In each case the Centaur stage retains sufficient propellant and restart capability to conduct a dedicated reentry burn maneuver.

Essentially each SDV flight takes the place of two or more flights of other smaller launchers (Ariane V, Ares I, Soyuz, Progress, and Commercial Orbital Transportation Services (COTS) launch vehicles).

C. Large Robotic Lunar Missions

The SDV has a capability of sending 30 mt of net payload on a translunar injection trajectory in a single launch in support of large robotic lunar missions. Also, using the ESAS defined Lunar Surface Access Module in a one-way cargo mode, nearly 10 mt of cargo supporting a lunar base development can be landed on the lunar surface.

D. Solar Power Satellite Development & Deployment Missions

The SDVs described in this paper can also provide for the launch of other heavy-lift missions such as large space-based solar power satellites that can supply power for specific targeted applications on Earth. Commercial missions of this type can increase the overall flight rate of these SDVs further reducing the costs of exploration missions. The ability to place 30 metric tons of payload into geosynchronous orbit (GEO) is nearly five times the capability of the existing Delta IV-Heavy EELV.

E. Heavy-Lift Exploration Missions

In addition to heavy robotic and crewed lunar missions, the SDV can support exploration missions to other planets. For example, Reference 4 describes an advanced technology NASA manned Mars mission that can be assembled in low-Earth orbit using as few as three 80-mt heavy-lift launches. Other options would utilize five or more launches with Earth-orbit assembly. The SDV provides such a capability to support these large Mars reference missions.

IV. Configurations

Lunar Mission SDVs

Figure 8 depicts the two side-mount SDVs configurations that would be used for a lunar mission. The LSAM and CEV shown are those contemporary to the Ares I and Ares V designs when this paper was written (LSAM mass = 45.9 mt and CEV mass = 20.2 mt in a 120 nmi rendezvous orbit).

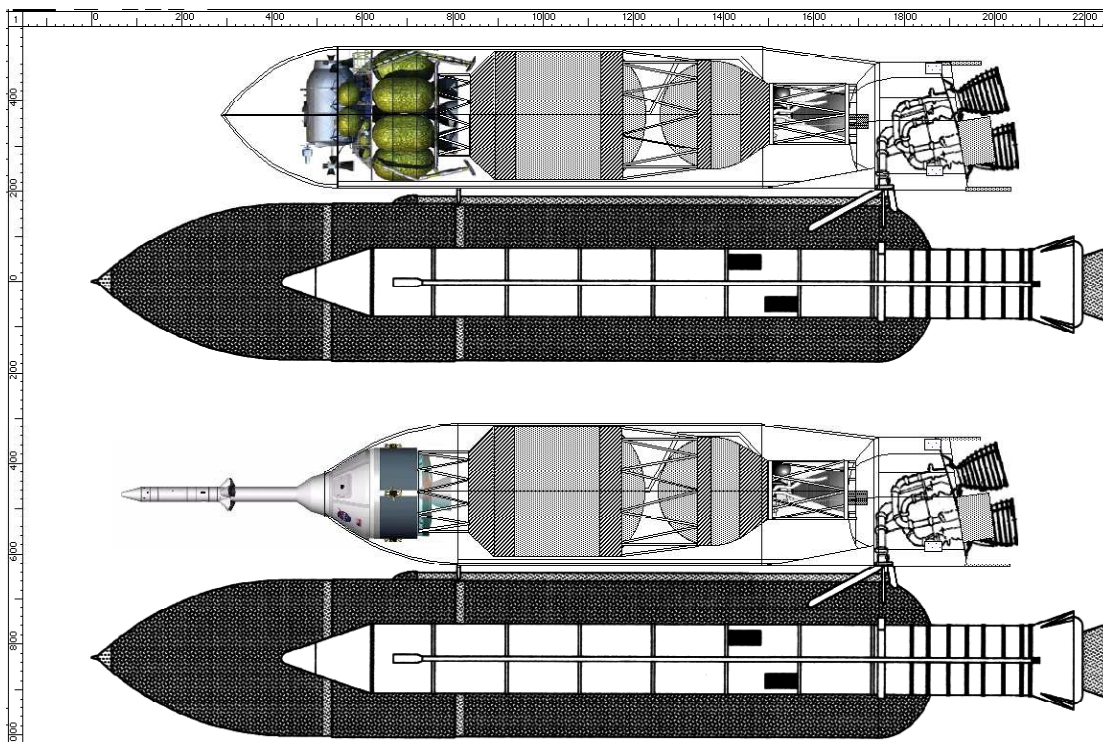

Figure 8. Side-mount SDV with LSAM & CEV Payloads

The 4-segment SRB's and External Tank are basically unchanged from current Shuttle versions. Further analysis is required to determine the extent to which the existing forward and aft struts will require strengthening to carry a heavier carrier/payload static load during EDS stage propellant loading while on the pad. An ET tank mass increase of one metric ton was allocated for such a possibility. The EDS stage is attached to the keel structure of the carrier. A dynamic strut, strategically placed on the launch pad, is an option for load relief at the aft keel structure/boat tail interface as the EDS stage is loaded with propellants. After ignition of the SSMEs, load relief is not necessary unless there is an abort shutdown at which point the dynamic strut will dampen the motion of the launch stack as the load is relieved. The STS aft boat tail with three existing SSMEs is reconfigured into a recoverable propulsion/avionics module and includes the removal of unnecessary existing Shuttle elements including the OMS/RCS pods and structures associated with the vertical tail. This design has been shown to increase cost effectiveness of the system, optimize masses and load paths, and recover the high value SSME engines, avionics, and boat tail structures. The propulsion/avionics module is detailed in a later section.

The payload carriers are new designs with a payload diameter of 7.5 meters consistent with the LSAM maximum design diameter as defined by the ESAS. This also drives the design of the EDS stage. A 10-m option carrier for a wide-body LSAM was also examined in a trade study. The impacts on system mass and launch aerodynamics were determined to reduce lunar payload after TLI by ~ 0.7 mt. The carriers are of a strong back design and split open to expose the payloads and EDS for the staging maneuver. The carriers are identical aft of the forward External Tank attachment structure. The forward sections differ in carrier length according to whether the payload is the LSAM or CEV.

Table IV-1 provides an overview of the mass breakdown of these two SDV configurations. A typical *Space Shuttle* launch mass is about 4.52 Milb or about 250 – 300 klb less than these configurations.

Figure 9 provides additional details of the payload carrier and propulsion system in this case configured for LSAM delivery to low-Earth orbit. The carrier design differs from Shuttle-C in being less analogous to a converted Shuttle payload bay and more analogous to a payload fairing structure although strengthened by a keel, longerons, and ring frame structures for side-mount on existing External Tank struts. The Earth Departure Stage has forward and aft attachment structures to secure the LSAM payload and also mount to the aft propulsion module.

Table IV-1 – Side-Mount SDV Masses

Elements LSAM SDV	Mass, lbm	Elements CEV SDV	Mass, lbm
		CEV Launch Abort System	13,400
Carrier/Prop + EDS	582,029	Carrier/Prop + EDS	514,292
Carrier	45,116	Carrier	35,569
Prop/Avionic Module	58,711	Propulsion	58,711
Aft payload adapter	1,725	Aft Payload Adapter	0
LSAM with 10% margin	110,250	CEV with 10% margin	52,920
EDS stage	366,227	EDS stage	367,092
EDS prop	326,254	EDS prop	326,254
EDS burnout	39,973	EDS burnout	40,838
External tank	1,664,095	External tank	1,664,095
ET Empty	60,700	ET Empty	60,700
MECO Residuals	13,611	MECO Residuals	13,611
Usable	1,589,784	Usable	1,589,784
SRB Gross	2,596,932	SRB Gross	2,596,932
SRB Separation	385,227	SRB Separation	385,227
SRB Usable Propellant	2,211,705	SRB Usable Propellant	2,211,705
Total Liftoff	4,843,056	Total Liftoff	4,788,719

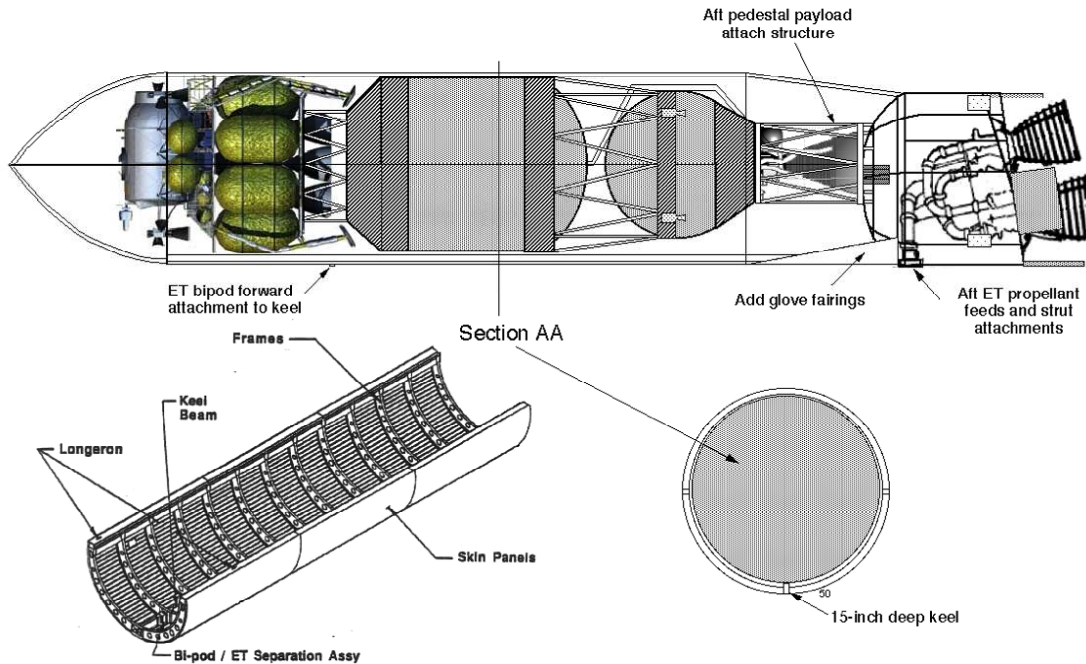

Figure 9. Carrier/Propulsion System and EDS Stage Design Details

SDV Propulsion/Avionics Module

Analysis of the use of a recoverable propulsion/avionics module was conducted to provide a means to save high value assets following launch of the SDV – namely the three SSME engine systems and SDV avionics. Because the staging point of the SSME propulsion is around Mach 17-19, the module will reenter and land in the Atlantic Ocean. Tests of a recovery system for a single SSME engine have been conducted in the past including hot firing of the SSME after recovery (Ref. 5). These tests and previous work on engine recovery modules were used to define a propulsion/avionics module concept shown in Figure 10. The concept uses five movable drag flaps that stabilize the module during entry and also provide a degree of control on entry-loads.

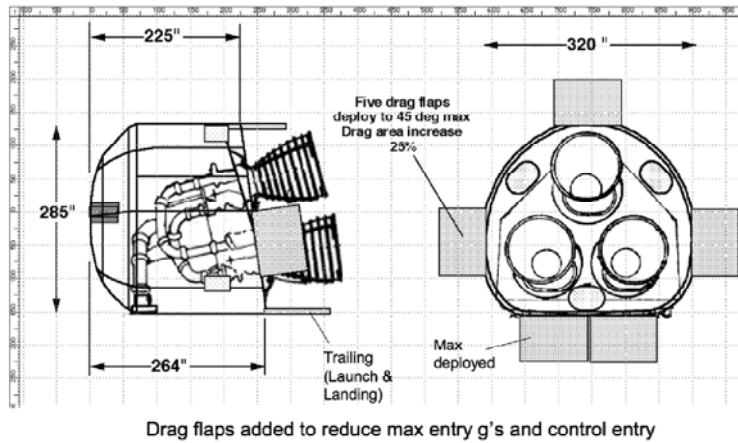

Figure 10. Concept for SDV Recoverable Propulsion/Avionics Module

savings per flight of \$150 M. The landing site is in the Atlantic Ocean approximately 1,100 nmi from the launch site. An ocean-going recovery vessel would be stationed in a position to rapidly recover the landed module and return it to the Kennedy Space Center launch site for processing and reuse.

Final descent is on three main parachutes. Landing rockets reduced impact loads (similar to the methodology used by the Russians in landing their Soyuz manned spacecraft). To protect the engines and avionics from salt water following an ocean landing, a spray shield is deployed before landing and is cinched to cover the engine bells. After landing flotation bags are deployed to maintain an upright float position in sea wave conditions until recovery is accomplished. The use of a recoverable propulsion/avionics module results in an estimated net cost

V. Safety and Reliability

The SDV described is based on elements of the Space Shuttle that have over 20 years of actual flight experience. The 4-segment Solid Rocket Boosters have been used in flight 246 times with one major failure (*Challenger*), the SSME engines have been used 369 times with no major failures (several safe shutdowns), and the External Tank flown 123 times with one failure (foam shedding fatally damaged *Columbia*). The SDV, thus, utilizes the legacy of fully matured, flight-proven systems.

The two major failures of the Space Shuttle have been studied in detail. In both instances, the failure modes have been isolated and fixes incorporated. With each flight, improvements in reliability and flight safety have been incorporated. For example, since the *Challenger* accident in 1986, the SRBs have incorporated new joint designs and heaters. The Space Shuttle Main Engines have been improved with enlarged main combustion chambers and more robust high-pressure pumps that reduce temperatures and pressure throughout the engine, thereby adding safety margin. Since the *Columbia* accident in 2003, more than 5,000 hardware components have been evaluated to ensure that the current operational environment is within the original certification baseline. Efforts since the *Columbia* accident have significantly reduced foam-shedding events from the External Tank with the most recent Shuttle flights being the cleanest in terms of foam shedding in Shuttle history. Most importantly, the SDV cargo and crew carriers are not subject to foam shedding damage, as they are not covered by the fragile thermal protection systems used by the Orbiter. Instead, the carriers are constructed of impact resistant metallic and composite materials. Further, any foam that is shed will follow trajectories along the carrier's longitudinal surfaces producing low-angle glancing impacts, as opposed to the Orbiters that have surfaces, such as the wings, that are subject to more direct impacts. The forward-mounted Orion CEV would also be covered with a boost protective cover during the critical initial phases of ascent and, when combined with the high-thrust abort motors, ensures that the crew can quickly escape the danger of a failed booster.

The SDV will benefit from all previous operational experiences and use proven Shuttle legacy systems. Thus, from the start of flights, the SDV will be more reliable and safer than other designs that exist today only on paper.

VI. Transition Plan & Risks

This paper has described the use of near-term SDV as a heavy-lift system for a variety of missions. To maximize the advantages requires that a smooth transition occur as the Space Shuttle is phased out and the SDV is phased in to support these missions. The transitions necessary include:

1. Minimize the human spaceflight gap (presently projected as up to 6 years)
2. Retain critical work force skills to support VSE
3. Provide logistics support of ISS to eliminate projected shortfalls in logistics, crew rotation, and allow full ISS operations including a full science capability. In the process, the critical work skills necessary for the Vision for Space Exploration are retained in place. The SDV development is realistically projected to take 66 months from a fully funded Authority to Proceed (ATP).
4. Support test flights of the lunar elements - CEV and LSAM
5. Support operational lunar missions
6. Support other priority missions including solar power satellites

Figure 11 provides an example transition plan that satisfies the above. In this plan the Shuttle flies an additional five years, until 2015, at two-three flights per year. These missions, to the International Space Station, eliminate projected shortfalls in logistics, crew rotation, and allow full ISS operations including a full science capability. In the process, the critical work skills necessary for the Vision for Space Exploration are retained in place. The SDV development is realistically projected to take 66 months from a fully funded

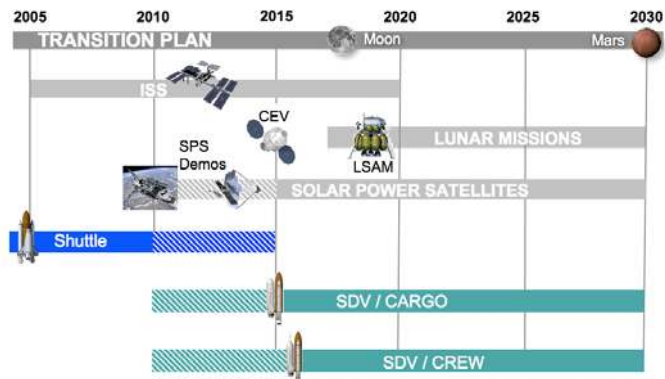
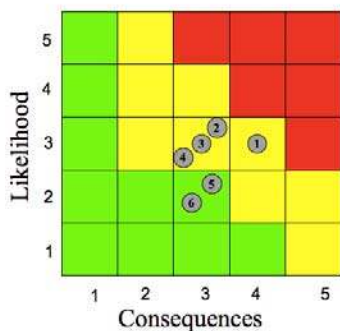

Figure 11. Transition Plan

Authority to Proceed (ATP). Assuming an ATP in early FY10, this places the first SDV operational cargo flight in 2015. The Orion CEV is scheduled to become available by then and could be ready to fly with crew on SDV in 2015-2016 as a crew/logistics mission to ISS. Because the existing Space Shuttle would continue to fly in this scenario until 2015, the human space flight gap would be eliminated.



1. Rehosting Shuttle flight software into new computer hardware and code.
2. Availability / Producibility of Shuttle avionics.
3. Development and verification of ground operations and launch control software.
4. Reusable Propulsion/Avionics Module.
5. Main propulsion producibility and flight certification.
6. Low thrust/weight propulsion effects on separation dynamics

Figure 12. Highest Development Risks for SDV

The risk for SDV is relatively low to moderate as it takes advantage of mature Shuttle systems and proven processes. No development items are viewed as high risk. Early focus on these items in the development schedule will mitigate the overall risk to the SDV development.

SDV could deliver a Solar Power Satellite demonstration mission to GEO in 2016. Lunar missions could begin using the SDVs in 2017 with heavy robotic landing missions followed by lunar outpost systems deliveries. The first human lunar mission could take place in 2018 or when the Lunar Surface Access Module becomes available.

Development of the SDV system by 2015 involves some technical risks. Figure 12 depicts the highest risk items in such a development program. Green is relatively low risk while red represents the highest

VII. Development and Recurring Costs

The development cost to reach the first operational SDV flight vehicle is estimated at \$6.9 billion (fixed year \$2008) with a development period of 5.5 years. The SDV cost estimates are based on the actual historical costs for the same elements used by the Space Shuttle Program, with complexity factors applied to modifications to similar Shuttle elements. A Level of Effort factor of 8% for Program Management and 15% for Systems Engineering & Integration has been applied to the basic hardware, software, and facilities cost estimates. Contingency Factors of 15% for DDT&E costs and 10% for recurring costs have been applied to the basic cost estimates to mitigate cost risks.

Figure 13 shows the estimated funding profile for the SDV development program. The largest funding requirement of \$1.6 B occurs in the fourth year of development. The primary new developments include the side-mount carrier and the recoverable propulsion/avionics module. Not included in these launch vehicle development cost estimates is the large upper stage used for heavy-lift lunar and GEO missions, which is estimated to add another \$2.5 B to the overall system development cost bringing combined overall costs to \$9.4 B. By comparison, the combined Ares I and Ares V development costs are estimated as over \$30 B.

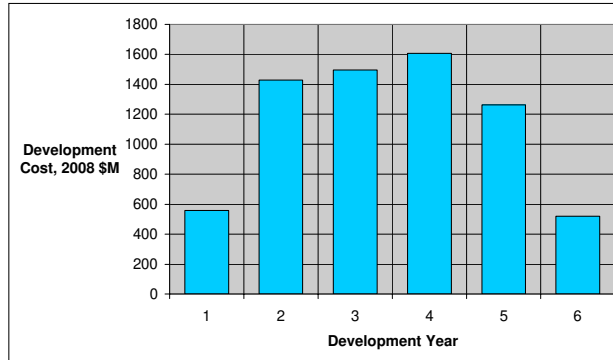

Figure 13. SDV Development Costs

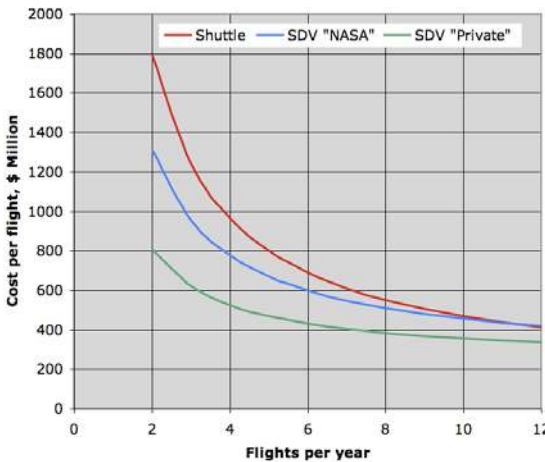

Figure 14. Recurring Costs vs. Flight Rate

The major cost benefit attained with using SDV is illustrated in Figure 15 by considering the cost per unit payload mass orbited. The SDV has over 3.5 times the payload capability of the Space Shuttle into a low-Earth orbit. Coupled with avoiding most of the recurring costs associated with the Orbiter, the resulting dollars per pound (or dollars per kg) for payload delivered to orbit by SDV shows a significant advantage compared with the Space Shuttle. At a flight rate of 6 per year, launch costs for a privatized SDV could be reduced to approximately \$2,200 per pound (\$1,000/kg) to low-Earth orbit.

Recurring costs depend on flight rate. Figure 14 shows the estimated cost per flight as a function of yearly flight rate up to 12 flights per year. The Space Shuttle costs are based on a FY'08 budget assuming five flights per year. The first curve showing SDV costs is based on a program with NASA management and institution costs. The second curve for a privatized SDV is a reflection of streamlined management operations that also minimizes institution and other costs associated with NASA oversight. At an SDV flight rate of six missions per year (two missions to ISS and four flights to support two lunar missions per year), the average SDV launch cost can be as low as \$430M for a privatized SDV.

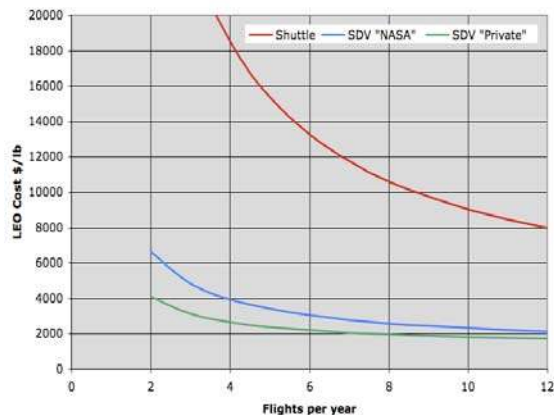

Figure 15. Cost per Pound of Payload vs. Flight Rate

VIII. Conclusion

The use of well understood, legacy elements of the Space Shuttle system could yield a near-term, high-confidence heavy lift launch vehicle that offers significant performance, reliability, schedule, risk, cost, and work force transition benefits. A side-mount Shuttle-Derived Vehicle (SDV) concept has been defined that has major improvements over previous “Shuttle-C” concepts. By replacing the Shuttle Orbiter with a new cargo carrier using sub-orbital staging, this optimized SDV could deliver up to 78 mt payload to LEO. This SDV could be developed in 66 months at an estimated cost of \$9.4B, including a new, large upper stage. It could provide attractive opportunities for delivering crew plus large logistics payloads to the ISS, support an operationally efficient and cost effective program of lunar and Mars exploration, and offer the potential to support commercial heavy lift launch operations.

References

- ¹NASA, “NASA’s Explorations Systems Architecture Study. Final Report”, NASA-TM-2005-214062. Nov. 2005.
- ²Martin Marietta Manned Space Systems, “Shuttle-C User’s Guide”, May 1989.
- ³Rothschild, W. J., Bailey, D. A., Henderson, E. M., Crumbly, C., “Shuttle-Derived Launch Vehicles’ Capabilities: An Overview”, Presented at the AIAA 1st Exploration Conference, Orlando, FL, Jan.30-Feb. 1, 2005.
- ⁴Drake, B. G. Editor, “Reference Mission Version 3.0 Addendum to the Human Exploration of Mars: The Reference Mission of the NASA Mars Exploration Study Team”, NASA SP-6107-ADD. June 1998.
- ⁵Delurgio, P. R., Reinhard, D. J., Taylor, A.P., Wells, J.A., Graves, D. L., “Recovery System for the Evolved Expendable Launch Vehicle,” AIAA Paper 97-1513.