

# A New Control Technique for Active Power Filters Using a Combined Genetic Algorithm/Conventional Analysis

M. El-Habrouk and M. K. Darwish

**Abstract**—In this paper, the computational problems associated with the optimization techniques used to evaluate the switching patterns for controlling variable-characteristics active power filters are presented and critically analyzed. Genetic algorithms (GAs) are introduced in this paper to generate a fast and accurate initial starting point in the highly nonlinear optimization space of mathematical optimization techniques. GAs tend to speed up the initialization process by a factor of 13. A combined GA/conventional technique is also proposed and implemented to reduce the associated computational burden associated with the control and, consequently, increasing the speed of response of this class of active filters. Comparisons of these techniques are discussed and presented in conjunction with simulation and practical results for the filter operation.

**Index Terms**—Active power filters, genetic algorithm, harmonic elimination.

## I. INTRODUCTION

SINCE THE increase in the occurrence of nonlinear loads in the power system, active power filters have been used extensively. The main aim of active power filters is to compensate for the undesired harmonics generated by offending loads. The parallel connection of active filters has been the most attractive and the most extensively used in the power system since it does not cause any disturbance to the power flow [1], [2].

As shown in Fig. 1(a), the nonlinear load current ( $i_L$ ), consisting of a fundamental component ( $i_1$ ) and a harmonic component ( $i_H$ ), is drawn by the load from the power network. The filter operates in order to inject a current signal ( $i_F$ ) into the supply at the point of common coupling (PCC). Under ideal conditions, this injected current has the same magnitude and  $180^\circ$  phase shift with respect to the nonlinear load current harmonics  $i_F = -i_H$ . The resulting supply current is, consequently, free from harmonics and only contains the fundamental component of the load current flowing in the supply side  $i_S = i_1$ .

The active filter circuit block in Fig. 1(a) includes the circuit used for the system operation. The majority of active filter circuits used include a voltage-fed inverter with a superimposed current control loop and a relatively large value of dc-link ca-

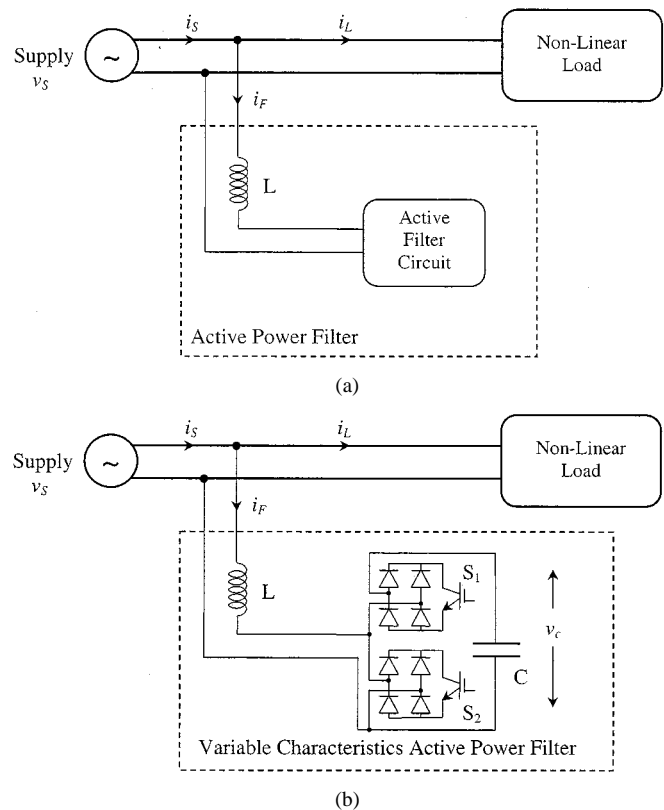

Fig. 1. (a) Shunt active filter with nonlinear load. (b) Variable-characteristics filter with nonlinear load.

pacitor (4000–9000  $\mu\text{F}$ ) on the dc side [1], [2]. The operating frequency of inverter-based active power filters is in the range of 20–30 kHz [1], [2]. This relatively high switching frequency reduces the current-carrying capabilities of the switches used and necessitates the use of fast semiconductor devices. Several other configurations exist such as the variable-characteristics circuits [3]–[5], the lattice structures [5]–[7], and the voltage regulator type of active filter [8].

Variable-characteristics filters [3]–[5] [shown in Fig. 1(b)] have a major advantage over inverter configurations in that they operate on a relatively very low switching frequency ( $\sim 4$  kHz) with capacitors in the range of 40–80  $\mu\text{F}$ , which represents a major achievement as compared to inverter configurations. The overall system cost would then be greatly reduced due to these relatively modest requirements, in addition to the smaller number of switches used (only two switches as compared to four for inverter configurations).

Manuscript received June 16, 2000; revised July 25, 2001. Abstract published on the Internet December 5, 2001.

M. El-Habrouk was with the Department of Electronic and Computer Engineering, Brunel University, Uxbridge, UB8 3PH, U.K. He is now with the Faculty of Engineering, Alexandria University, Alexandria, Egypt.

M. K. Darwish is with the Department of Electronic and Computer Engineering, Brunel University, Uxbridge, UB8 3PH, U.K.

Publisher Item Identifier S 0278-0046(02)00921-8.

This paper deals with the control and optimization implementation of variable-characteristics active filters, shown in Fig. 1(b). Conventional optimization techniques were used to synthesize the switching pattern of the semiconductor switches, yielding switching frequencies in the range of 2–4 kHz, with capacitors on the order of 40–80  $\mu\text{F}$  [3]–[7]. These calculus-based optimization techniques are briefly reviewed in the following section in conjunction with the power circuit analysis. The genetic algorithms (GAs) as well as the combined technique are then introduced and their application is thoroughly explained and, consequently, implemented to a variable-characteristics active filter circuit. Finally, a comparison between the proposed and conventional techniques is presented in conjunction with simulation and practical results of the circuit operation.

## II. EVALUATION OF SWITCHING ANGLES USING CONVENTIONAL OPTIMIZATION TECHNIQUES

The conventional analysis of the active filter's switching pattern has been presented in different publications [3]–[5]. This analysis is summarized here for the reader's convenience and as a basis for comparison with the proposed techniques. As shown in Fig. 1(b), the variable-characteristics active filter circuit has two different operating states depending on the two complementary switches ( $S_1$  and  $S_2$ ). Two different circuits arise.

The first circuit exists when the switch  $S_1$  is ON. In this case, the circuit consists of an inductor in series with a capacitor. This combination is connected across the supply. The first and second derivatives of the load current exist and are controlled by the location of the roots of the characteristic equation of the system. The circuit can be represented by the following equation:

$$\frac{di_F}{dt} = \frac{v_s - v_c}{L}. \quad (1)$$

Assuming  $v_s$  to be piecewise constant during the whole of the switching period, the second derivative of the filter current can be reduced to be

$$\frac{d^2i_F}{dt^2} = -\frac{1}{L} \frac{dv_c}{dt} \quad (2)$$

reducing to

$$\frac{d^2i_F}{dt^2} = -\frac{i_F}{LC}. \quad (3)$$

The second circuit exists when the switch  $S_2$  is ON and the inductor is connected across the supply. The circuit equation reduces to the form

$$\frac{di_F}{dt} = \frac{v_s}{L} \quad (4)$$

where, under the above assumption of supply voltage piecewise constancy, the second derivative reduces to zero as

$$\frac{d^2i_F}{dt^2} = 0. \quad (5)$$

Through an appropriate choice of switching patterns, variable-characteristics active filters are able to generate the required compensating currents by controlling the first and second derivatives of the filter current. Equations (2)–(5) show

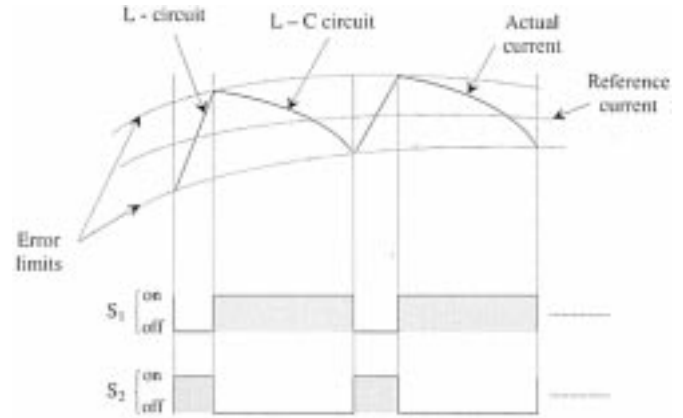

Fig. 2. Filter current control.

that the polarity and rate of change of the filter current can be controlled by varying the switching pattern and, hence, the circuit characteristics (from which comes the name “variable-characteristics filters”) of the two transistor switches. A typical switching pattern is shown in Fig. 2.

In order to generate the required compensation signal, a suitable switching pattern must be chosen. The above differential equations are then repeatedly solved for each switching cycle. Assuming half-wave symmetry with an even number of switching instants per cycle ( $n$ ), the system reduces to the solution of  $(n/2 + 1)$  differential equations with variable coefficients in order to get the best switching pattern (switching instants)  $\bar{x} = \{x_i; i = 1 \dots n\}$ . An optimization process is required to obtain the best switching pattern  $\bar{x}$ .

In order to proceed with the optimization process, an objective function including a measure for the effectiveness of the filter is defined. The cost function should include the total harmonic distortion (THD) of the load current after filtering and is defined as

$$f(\bar{x}) = \sum_{j=3}^{N_{\max}} \left( A_j + \hat{A}_j(\bar{x}) \right)^2 + \left( B_j + \hat{B}_j(\bar{x}) \right)^2 \quad (6)$$

where  $j$  is the harmonic index,  $N_{\max}$  is the maximum number of harmonics considered in the analysis,  $A_j$  and  $B_j$  are load current harmonic coefficients, and  $\hat{A}_j$  and  $\hat{B}_j$  are filter current harmonic coefficients and are functions of the switching instants  $\bar{x}$ . Therefore, by minimizing the cost function  $f(\bar{x})$ , the switching instants are optimized and the required compensation signal is generated, resulting in the load harmonics being filtered.

The optimization technique used in this case relies on minimizing the objective function  $f(\bar{x})$  using the hill-climbing technique [3]–[7], [9]. This optimization starts by assuming an initial set of switching instants ( $\bar{x}^0$ ), which is used to compute the gradient of the objective function at this particular point ( $\bar{g}_0 = \nabla f(\bar{x}^0)$ ) as well as the direction coefficient ( $\bar{d}_0 = -\bar{g}_0$ ).

Since  $f(\bar{x}^0)$  is not an explicit function in the switching instants ( $\bar{x}^0$ ), the technique uses a numerical approximation of the function which is calculated using a fourth-order Runge–Kutta procedure to obtain the discrete samples of the filter current. A simple discrete Fourier transform (DFT) technique is then used to evaluate the harmonic coefficients and, hence, the cost function.

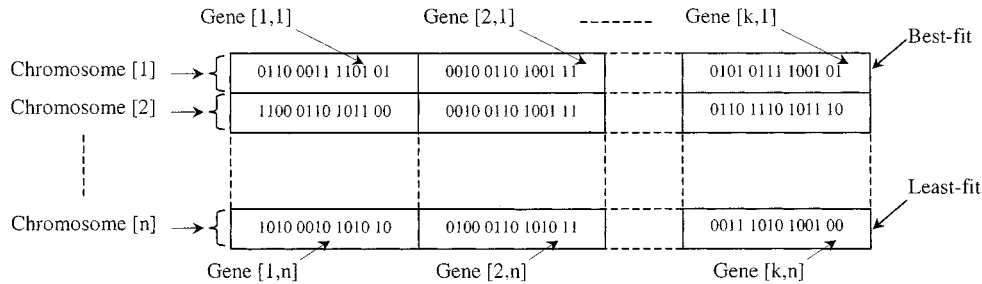

Fig. 3. Organization of the GA problem as a population of ordered best-fit chromosomes.

The hill-climbing technique [5], [9] is then applied to find the estimation of the next set of switching instants ( $\bar{x}^1 = \bar{x}^0 + \alpha_0 \bar{d}_0$ ). The value of  $\alpha_0$  is chosen to minimize  $f(\bar{x}^0 + \alpha_0 \bar{d}_0)$ . The constraints on the new switching pattern are checked to ensure a feasible solution. These constraints relate to the fact that each switching instant has to be larger than or equal to the previous one ( $\bar{x}_i^1 \geq \bar{x}_i^0$ , for  $i = 1, 2, \dots, n$ ). In addition, the last switching instant has to be smaller than or equal to the duration of one complete mains cycle (20 ms).

The gradient of the new objective function is calculated to decide on the direction of the next approximation step ( $\bar{g}_1 = \nabla f(\bar{x}^1)$ ). Then, the direction coefficients are determined as  $\bar{d}_1 = -\bar{g}_1 + \beta_0 \bar{d}_0$ , where the constant  $\beta_0$  is defined as  $\beta_0 = (\bar{g}_1^T \bar{g}_1) / (\bar{g}_0^T \bar{g}_0)$ .

This process is repeated successively using the above steps (with the superscript “0” replaced by “k” and the superscript “1” replaced by “k + 1” for all the sets of switching angles  $\bar{x}$ ) for  $m - 1$  times until the final estimate of  $\bar{x}^m$  is reached.

The amount of computations involved, especially with the numerical evaluation of the partial derivatives, is phenomenal. The computational time requirements are quite considerable and prevent the filter from being able to adapt to changes in the nonlinear load current within an acceptable time period.

In the following sections, GAs are introduced and investigated in order to reduce the time required for the determination of a suitable switching pattern to generate the compensation signal. It eliminates the need for auxiliary information regarding the optimization surface (i.e., partial derivatives) [10]–[13], in order to direct the search for a suitable switching pattern.

### III. GAS

GAs were originally introduced and developed as a system aimed at explaining and modeling the adaptation of natural systems. A basic GA involves selection, mixing, and mutation of components. Like biological systems, selection is driven by an organism’s ability to survive in its environment (survival of the best fit). Mixing in GAs is usually implemented by combining genetic information from two or more parents. Mutation is a mechanism for reintroducing information that may not have been contained in the population. The population serves as an organism with distributed knowledge throughout the genes of the entire population.

GAs have been recently introduced into the context of nonlinear function optimization problems [10], [12]. They constitute biologically inspired multiparameter search/optimization algorithms that have proven to be effective at solving a variety

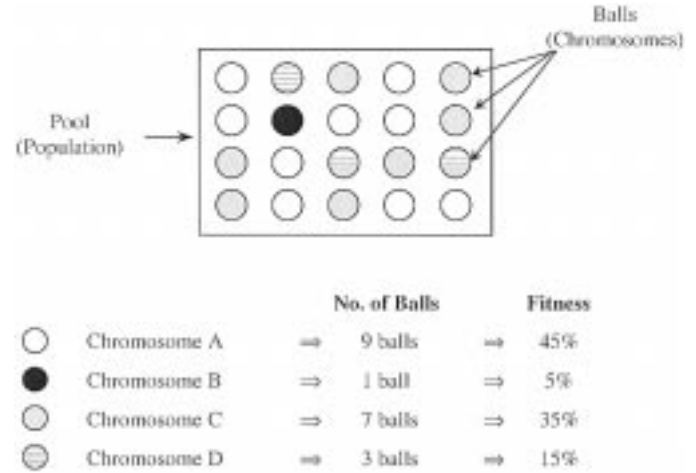

Fig. 4. Selection mechanism.

of complex problems that other algorithms have difficulties solving. GAs perform a search for a multidimensional space containing a hypersurface known as the fitness surface.

As shown in Fig. 3, the basis of GAs is that a “population” of problem solutions is maintained in the form of “chromosomes,” which are strings encoding problem solutions. These chromosomes are formed from the combination of individual variable solutions called “genes.” Genes are normally represented in binary and are converted into problem solutions such that an objective “fitness scoring function” can be evaluated for each chromosome in the entire population.

The process of fitness evaluation is followed by the selection mechanism, which can best be exemplified with a practical example. Consider a pool (representing the overall population) where all the chromosomes are represented by balls with distinct colors to differentiate between them. As shown in Fig. 4, the incorporation of the fitness value is implemented by introducing a number of balls for each chromosome proportional to its fitness. The example here considers four balls of fitnesses (45%, 5%, 35%, and 15%). The respective number of balls representing each of the chromosomes is selected to be (9, 1, 7, and 3), with a total of 20 balls representing each 5% fitness. If the balls are randomly selected, the first and third balls stand more chances to be selected than the fourth and second, respectively. The selection process may be performed in several different manners depending on the application, as will be explained in the Sections IV and V.

Following the selection of the “parent” population, a new “child” population of chromosomes is generated by applying

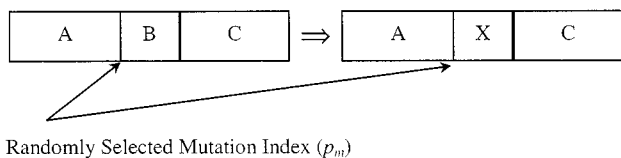

Fig. 5. Mutation operation.

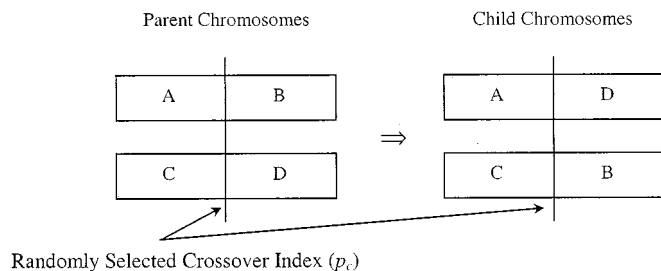

Fig. 6. Crossover operation.

a set of genetic operators to the parent population. During this process, two main operations may be performed.

- 1) A gene may be “*mutated*” from its parents by introducing unprecedented information as part of its parent’s genes (see Fig. 5).
- 2) A gene may be “*crossed over*” from its parents by combining segments from two or more parent chromosomes (see Fig. 6).

The exact locations of mutation and crossover performed on the chromosome (or the set of two chromosomes) are regulated by the mutation index ( $p_m$ ) and the crossover index ( $p_c$ ). The indexes are each scaled a by random numbers to generate the required bit number, which will undergo the operation. It was proven [12] that a short section of a chromosome, containing some optimal information (leading to a high fitness), is more likely to increase in occurrence throughout the population, thus leading to a gradual improvement in the overall fitness as time passes under certain circumstances such as very large populations.

GAs are particularly good at finding optimal minimum, where the fitness surface is nonlinear, highly convoluted with many local minima and dependent on several parameters simultaneously. The time taken by GAs to reach these solutions is merely a fraction of that of other conventional techniques. Moreover, GAs possess a much better advantage over conventional optimization techniques in that they produce a set of optimal and suboptimal solutions, simultaneously. This aspect is particularly useful in engineering problems, where the optimal solution can not be practically implemented. Then, one of the suboptimal solutions, within only a few percents away from the optimum, can be used without any additional computational time as compared to other techniques.

These clear advantages of GAs helped them to find a vast number of applications. One of these is in the area of active power filters as explained in the following section.

#### IV. EVALUATION OF SWITCHING ANGLES USING GAS

The main aim of using GAs in variable-characteristic filters is to replace “slow” conventional optimization techniques in eval-

uating the optimal switching pattern, which is used to control switches  $S_1$  and  $S_2$  so that the filter current  $i_F$  is equal and in antiphase to the harmonic components of the load current  $i_L$ .

In order to apply the GA solution to the optimization problem, the definition of the variables has to be taken into account in order to yield the fastest implementation. The following points are to be considered.

- 1) GAs operate on positive numbers, which is ideal for the case of the set of switching instants at the  $i$ th iteration  $\bar{x}^i$ . However, GAs cannot implement constraints such that for each iteration  $i$  and at any instant  $k$ ,  $x_k^{i+1} \geq x_k^i$ . This is overcome by formulating the independent variable as a time difference ( $\Delta x_k^i$ ) from the previous switching instant and not as an absolute time ( $x_k^i$ ). This implies that the absolute switching time at instant  $k$  and iteration  $i$ ,  $x_k^i$  can be calculated as  $x_k^i = \sum_{j=1}^k \Delta x_j^i$  and, consequently, the switching time difference ( $\Delta x_k^i = x_k^i - x_{k-1}^i$ ) is always positive or zero and conformable with the constraints.
- 2) The other constraint to take into account relates to the fact that the sum of all the switching pulses calculated from the above program should not exceed the period of the mains cycle (0.02 s). The pulses are, in effect, uncontrolled in time duration. Their sum for the  $i$ th iteration is  $x_{tot}^i = \sum_{k=1}^n \Delta x_k^i$  can be used to scale the obtained  $n$  pulses in a way so as to make them fit into 20 ms. This is performed by applying the equation  $\Delta \hat{x}_k^i = 0.02 \cdot \Delta x_k^i / x_{tot}^i$  to each of the pulsewidths computed at iteration  $i$  for all values of  $k = 1$  to  $n$ . The modified pulses ( $\Delta \hat{x}_k^i$ ) are then used instead of the original ones for the computation of the filter performance. In effect, this process introduces a penalty function for the switching pattern, hence, implementing the constraint.
- 3) It remains to decide on the implementation technique of the pulses for the chromosome representation of the GA problem. The simplest and most effective solution for this case is the use of a string of integers concatenated together to form the chromosome. This representation necessitates the determination of the number of bits used for each switching cycle. The resolution of computation is the decisive factor in this case. It is decided to take a practical value of  $1 \mu s$  as a time increment (since this is a practical value from the point of view of the switching speeds of power switching devices). This value implies the use of 14-b integer representation for each of the pulses.
- 4) GAs have the main characteristic of maximizing functions since they operate on the basis of the survival of the best fit. This implies that the objective function  $f(\bar{x})$  defined in (6) is the inverse of  $J_i$ , the objective function for the GA optimization.
- 5) Finally, it is very important to note that power system waveforms normally possess half-wave symmetry property. This in fact will imply that the same property holds for the switching pulses and that there is only a need to genetically represent the switching pattern for only one half cycle. This is very useful in the fact that it reduces the storage space of the program by half and it permits the computational speed to be at least doubled.

Following the problem specifications outlined above, the first population is generated under the following assumptions. There are 40 switching instants (per half cycle) to be optimized, which are coded into a set of 40 genes of 14 b each. All the genes for each solution are concatenated into one string (chromosome). The initial population is composed of 100 chromosomes, which are randomly selected.

As outlined earlier, once the initial population is formed, the fitness of each chromosome is evaluated and the selection mechanism, explained in the previous section, is applied to the parent population in conjunction with the crossover and mutation operators in order to generate the child population. The process is repeated successively until the overall fitness (THD) of the population is acceptable or a maximum predefined number of iterations  $N_p$  is reached. This number is decided upon from experience when the simulation results do not reach convergence except after a very large number of generations (iterations). At this point, the best optimal solution is chosen and used in the implementation of the filter. The detailed flowchart of the GA optimization program implementation is shown in Fig. 7. In this flowchart, the maximum number of generations is used to determine the best chromosome.

It is worthwhile to note that the selection mechanism implemented and described in Fig. 7, depends on the capability of each of the chromosomes with fitness  $J_i$  ( $i = 1$  to  $N_c$ ) to affect the probability of having a certain probabilistic percentage of the overall  $J_{tot}$ , which is defined in  $F_i$ . The elements, which have higher values of  $J_k$  ( $k = 1$  to  $m$ ), would mainly contribute in the selection of the desired element  $m$  from the inequality  $\sum_{k=1}^m J_k > F_j$ . In other words, these chromosomes will have a higher probability of being selected than the others as they will easily satisfy the relation with their large fitness values.

Moreover, as is further indicated in the flow chart of Fig. 7, the crossover/mutation operations are performed at the end of the selection process aimed at reordering the chromosomes in a manner that the ones with high fitness are next to each other. The procedure then endeavours to perform the GA operators (crossover/mutation) to result in a newer generation, which will still fit the constraints as explained above and at the same time explore other solutions, keeping the good ones in hand with slight modifications. This way, the parents can stress their good characteristics in their children, resulting in the high fitness being improved.

## V. SOFTWARE SIMULATION

The actual current waveform of a nonlinear load, consisting of a rectifier circuit and a capacitive/resistive load (with a smoothing inductance), were used as a basis for the simulation of the variable-characteristics active filter performance under the effect of the switching pattern generated by different optimization techniques. The load used in the analysis was taken from sampled data of a practical circuit implementation of the rectifier circuit and has a 1- $\mu$ s step size. The Fourier analysis is performed on this signal and introduced into the optimization processes.

The simulation results of the active power filter performance under the nonlinear operating conditions outlined above and for

a fixed switching frequency of 4 kHz are obtained in two consecutive steps.

- 1) Generate the optimal switching pattern for the filter switches using either the conventional optimization technique or the GAs.
- 2) Simulate the active filter performance using the computed optimal switching pattern.

Two optimization programs were implemented to generate the required switching patterns. The first program realized the conventional optimization technique, outlined in Section II, for the sake of comparison with the proposed GA implemented in the second program. The GA program followed the same flowchart outlined above in Fig. 7.

The main advantage in using GAs is that they use multiple starting points (different chromosomes in the initial population) as opposed to a single starting point in the whole of the multidimensional solution space for conventional optimization techniques. This implies that GAs investigate simultaneously a much larger portion of the solution space and scatter starting points randomly to escape from local minima. This, in effect, is a major advantage and results in the fact that the solution obtained from conventional optimization can get "trapped" in one of the local minima. The solution is then to try different starting points and run the same program several times (implying larger simulation times).

The convergence diagram shown in Fig. 8 compares the convergence speed of both techniques for the worst case of a rectifier bridge feeding a capacitive load with a smoothing inductance (shown in Fig. 9). It can be seen that GAs converge to 20% THD in only 31 s at least 13 times faster than conventional optimization. On the other hand, It is noted that GAs tend to slow down the final convergence process after achieving the large initial step. This is mainly attributed to the crowding factors of GAs, which have a tendency of attempting newer solutions in the surroundings of the best solution achieved so far [10], [12]. The final convergence part of the GA technique is only twice as fast as the conventional optimization techniques, reaching 10% THD in only 430 s as compared to 850 s.

In order to gain both advantages of the fast initial convergence of GAs as well as the steady convergence of conventional optimization techniques, it has been decided to use the GAs for the first convergence step in order to reach the 20% THD stated above. The optimal chromosome, containing the information regarding the optimal switching pattern so far, is then used as an initial starting point for conventional algorithms, which then take over and the optimization process is carried out as in Section II to reach the absolute minimum THD. This enables the optimization process to speed up considerably as shown in the third curve of Fig. 8. The conventional techniques (using the hill-climbing method) tend to produce much better results when triggered from an initial starting point nearer to the optimal one. The convergence curve reaches the 10% limit in only 109 sec, which is around one-eighth of the conventional one. The limit of 5% is reached in around 390 s, as compared to 1420 s, which is only 27.4% of the required time for conventional techniques.

The switching pattern finally obtained from the combined GA/conventional optimization is then applied to the active filter

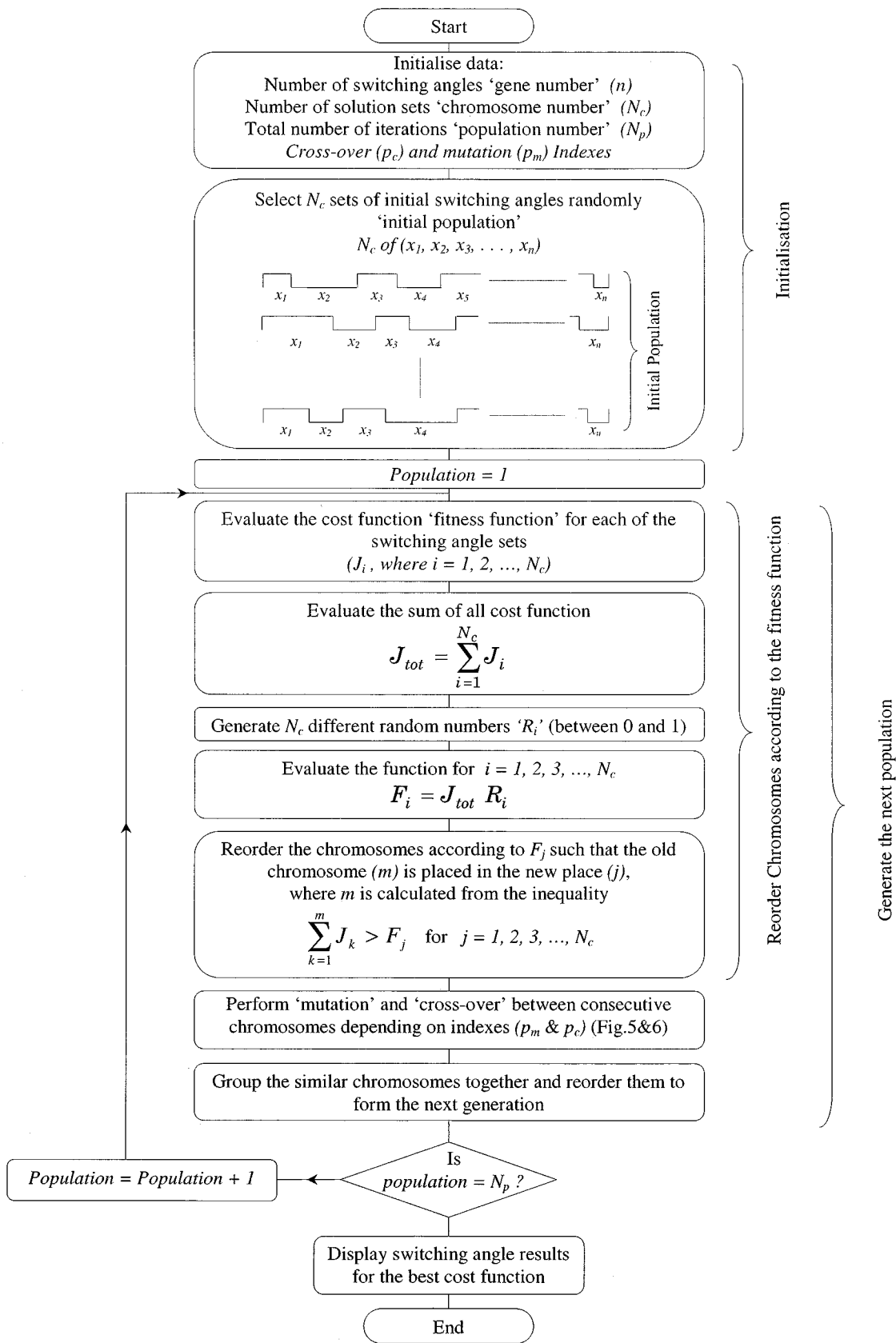

Fig. 7. Flowchart of the GA algorithm.

simulation program mentioned earlier to reflect the second computational step of the system simulation. This program is dedicated to simulate the performance of the active filter. The results

of the simulation are shown in Fig. 9, where the nonlinear load is simulated as above. The initial THD of the nonlinear load current is 102%. The waveforms represent the nonlinear load cur-

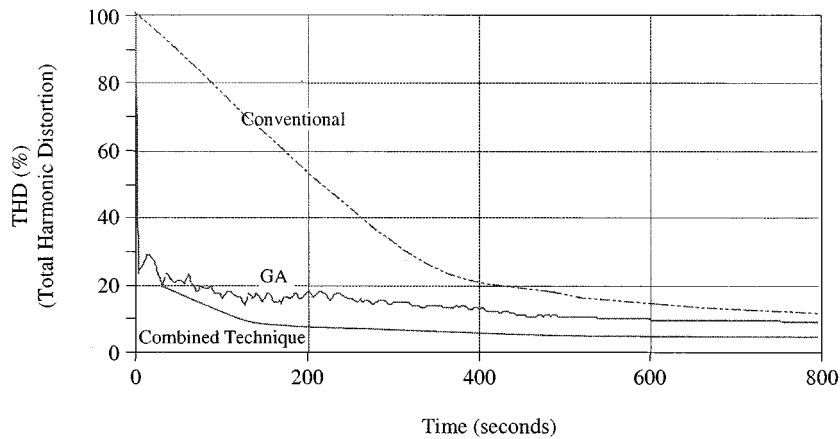

Fig. 8. Convergence graphs for conventional, GA, and combined GA/conventional techniques.

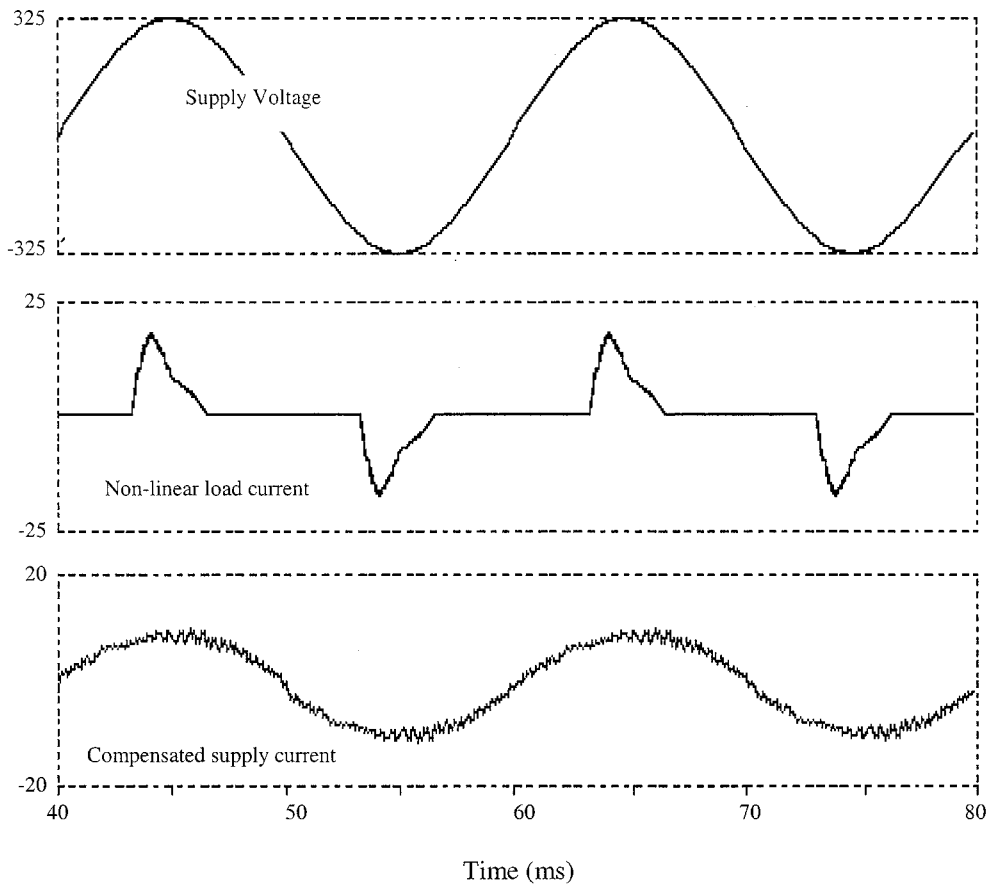

Fig. 9. Simulated voltage ( $V$ ) and current ( $A$ ) waveforms.

rents, as well as the compensation filter current. The resulting supply current is shown to be rather sinusoidal.

The high-frequency component superimposed upon the supply current is due to the switching frequency used, in this case, 4 kHz (80 pulses per cycle). The necessary switching frequency for this class of active filters ( $\sim 4$  kHz) is relatively very low compared to the switching frequencies of inverter filters (20–30 kHz). The practical implementation of the above filter using the combined GA/conventional techniques is presented in the following section.

## VI. PRACTICAL IMPLEMENTATION

Fig. 10 shows the block diagram of a 3.5-kVA active power filter prototype. The system consists of a nonlinear load formed using a diode bridge rectifier feeding a capacitive load ( $C = 600 \mu\text{F}$ ,  $R = 31.5 \Omega$ ) with a smoothing inductance ( $L = 1$  mH). The nonlinear load current is sensed and fed back using Hall-effect transducers in the system variables feedback. The load current harmonics and supply voltage at the PCC are then fed to the offline optimization block to generate the optimal switching

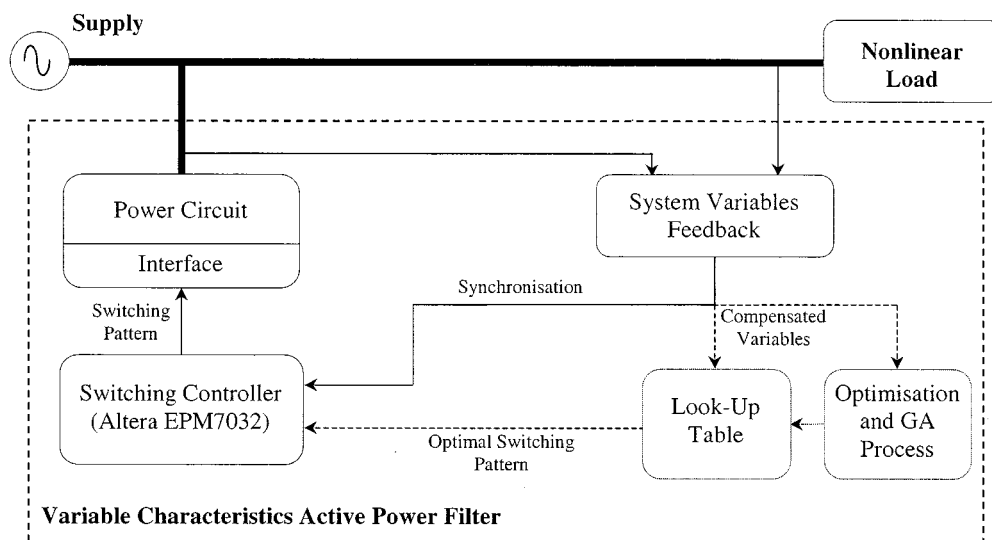

Fig. 10. Block diagram of the experimental setup.

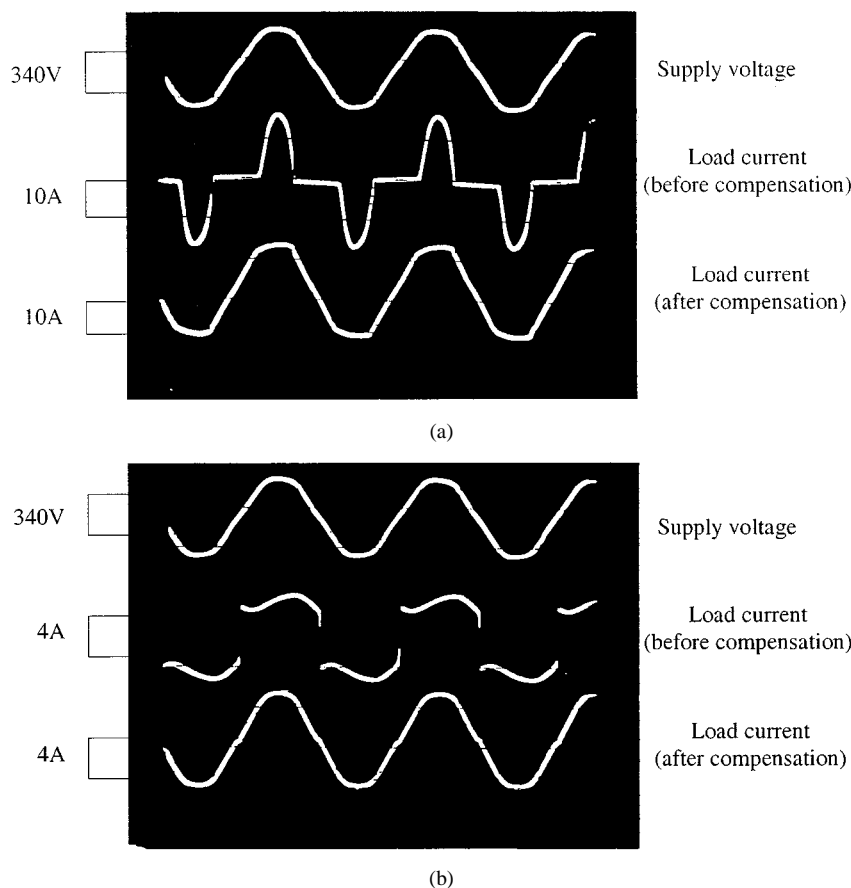

Fig. 11. Practical results of the prototype. (a) Capacitive load. (b) Inductive load.

pattern used to drive the switching controller through a lookup table [14]. The switching controller is an Altera EPM7032 responsible for generating the required timing pulses to drive the power circuit through proper isolation and interface.

The implementation technique of the online system cannot, of course, apply the optimization process (either conventional or GA) while controlling the filter at the same time. The response time and performance of the filter will definitely deteriorate and

result in a compensation of a certain harmonic pattern, which existed a large number of cycles ago. The system would then be inconsistent in the compensation. The online implementation of this type of active filter has been addressed using pattern recognition techniques in [14], which is outside the scope of this paper. The main use of the proposed combined GA/conventional analysis in this case is the reduction of the computation and optimization times, which are used in the faster generation



of several hundreds of sets of optimal switching patterns. These patterns can then be used in a lookup table, in pattern recognition systems, or even for neural network training.

Fig. 11(a) shows the practical results of the circuit implementation. The figure shows the supply voltage, the uncompensated current, and the compensated current. For the sake of comparison, the nonlinear load was then replaced by a diode bridge rectifier feeding an inductive load ( $L = 88$  mH,  $R = 31.5 \Omega$ ). The computation process of the optimal switching pattern was then repeated for this load, in an exact manner to the capacitive case. The resulting switching pattern was then applied to the switches and resulted in the practical result waveforms shown in Fig. 11(b) for the inductive load case.

The improvement in the THD is dramatic, from 102% for the nonlinear capacitive-load current to 4.1% for the compensated case and from 46% for the nonlinear inductive-load current to 4% for the compensated case. These values were measured using a Voltech PM100 Power Analyzer.

## VII. CONCLUSION

In this paper, GAs were analyzed and implemented as an alternative solution to the optimization problem for generating the switching pattern used to control the semiconductor switches of variable characteristics active power filters. GAs have proven to be very efficient in halving the time required by the computational process in order to reach an acceptable solution from the point of view of THD of the resulting compensated supply current with an initial prediction 13 times faster at 20% THD. The proposed combined GA/conventional optimization technique has shown much better performance as compared to either the conventional or the GA techniques. It has succeeded in reducing the optimization time by a minimum factor of 7.8 times for certain cases of the nonlinear load currents, as compared to conventional optimization techniques and almost one-quarter of the amount of time needed by the GAs. It also managed to provide an early estimate of the switching angles to generate lower THD. The reduction in time is very useful for the large number of optimization runs required for the implementation of practical online knowledge-based systems.

## REFERENCES

- [1] H. Akagi, "New trends in active filters," in *Proc. EPE'95*, Seville, Spain, Sept. 1995, pp. 17–26.
- [2] M. El-Habrouk, M. K. Darwish, and P. Mehta, "Active power filters—A review," *Proc. IEE—Elect. Power Applicat.*, vol. 147, no. 5, pp. 403–413, Sept. 2000.

- [3] P. Mehta, M. K. Darwish, and T. Thomson, "Switched capacitor filters," *IEEE Trans. Power Electron.*, vol. 5, pp. 331–336, July 1990.
- [4] Z. D. Koozehkanani, P. Mehta, and M. K. Darwish, "An active filter for retrofit applications," in *Proc. IEEE PEVD'96*, Nottingham, U.K., Sept. 1996, pp. 150–155.
- [5] Z. D. Koozehkanani, "Active filters: A unified approach," Ph.D. dissertation, Dept. Elect. Eng. Electron., Brunel Univ., Uxbridge, U.K., 1996.
- [6] Z. D. Koozehkanani, P. Mehta, and M. K. Darwish, "Active filter for eliminating current harmonics caused by nonlinear circuit elements," *Electron. Lett.*, vol. 31, no. 13, pp. 1041–1042, June 1995.
- [7] —, "Active symmetrical lattice filter for harmonic current reduction," in *Proc. EPE'95*, Seville, Spain, Sept. 1995, pp. 869–873.
- [8] M. El-Habrouk, M. K. Darwish, and P. Mehta, "Analysis and design of a novel active power filter configuration," *Proc. IEE—Elect. Power Applicat.*, vol. 147, no. 4, pp. 320–328, July 2000.
- [9] D. G. Luenberger, *Introduction to Linear and Non-Linear Programming*. Reading, MA: Addison-Wesley, 1973.
- [10] D. E. Goldberg, *Genetic Algorithms in Search, Optimization and Machine Learning*. Reading, MA: Addison-Wesley, 1997.
- [11] D. A. Coley, *An Introduction to Genetic Algorithms for Scientists and Engineers*. Singapore: World Scientific, 1999.
- [12] T. Furuhashi, *Advances in Fuzzy Logic, Neural Networks and Genetic Algorithms*. Berlin, Germany: Springer-Verlag, 1995.
- [13] M. Gen and R. Cheng, *Genetic Algorithms and Engineering Optimization*. New York: Wiley, 2000.
- [14] M. Darwish, P. Mehta, and M. Darwish, "Control strategies for active filters using pattern recognition techniques," in *Proc. IEEE PESC'93*, Seattle, WA, June 1993, pp. 20–24.



**M. El-Habrouk** was born in Alexandria, Egypt, in 1970. He received the B.Sc. and M.Sc. degrees from Alexandria University, Alexandria, Egypt, and the Ph.D. degree from Brunel University, Uxbridge, U.K., in 1992, 1995, and 1998, respectively.

From 1992 to 1996, he was an Assistant Lecturer at Alexandria University. From 1996 to 2000, he was with the Department of Electronic and Computer Engineering, Brunel University, as a Ph.D. student and later as a Research Fellow. Since 2000, he has been a Lecturer in Power Electronics at Alexandria University.

His research interests include motor drives, active power filters, power quality improvement, and the application of new control techniques to power electronics.



**M. K. Darwish** was born in Alexandria, Egypt, in 1955. He received the B.Sc. degree in electrical engineering from Helwan University, Cairo, Egypt, and the Ph.D. degree from Brunel University, Uxbridge, U.K., in 1978 and 1987, respectively.

Since 1987, he has been a Lecturer in Power Electronics at Brunel University. His research interests include active filtering techniques, UPS systems, and power quality issues. He has authored more than 70 technical papers published in leading journals and conference proceedings.