

## A New Design and Development of Portable Personal Vehicle

Shimon Ajisaka <sup>1</sup>, Sousuke Nakamura <sup>2</sup>, Takashi Kubota <sup>3</sup>, and Hideki Hashimoto <sup>4</sup>

<sup>1</sup> Department of Electrical Engineering, The University of Tokyo, s\_ajisaka@ee.t.u-tokyo.ac.jp

<sup>2</sup> Department of Electrical, Electronic, and Communication Engineering, Chuo University, nakamura@elect.chuo-u.ac.jp

<sup>3</sup> Department of Electrical Engineering, The University of Tokyo, kubota@isas.jaxa.jp

<sup>4</sup> Department of Electrical, Electronic, and Communication Engineering, Chuo University, hashimoto@elect.chuo-u.ac.jp

### Abstract

In recent years, to cope with low carbon society and diversification of individual mobility, new kinds of vehicles have received a lot of attention to expand our mobility. This paper proposes a new concept of vehicle named portable personal vehicle. The proposed portable personal vehicle is small and light enough, which enables not only to carry the driver but also to be carried by the driver. The proposed portable personal vehicle can easily overcome barriers in mixed traffic such as university campus, airports, shopping malls etc. It is harmless to surrounding pedestrians. This paper describes a developed inverted pendulum vehicle based on the concept of portable personal vehicle.

### Keywords

personal vehicle, inverted pendulum, portability, light weight, prototype

### 1. INTRODUCTION

Recently, to cope with low carbon society and diversification of individual mobility, new kinds of vehicles to expand our mobility have received a lot of attention [Masaaki, 2008; Suda et al., 2012; Taro and Shuro, 2012; Masamichi and Yoshiyuki, 2010]. In response, the requirement for new devices or schemes which can support individual person's mobility for "last one mile" is increasing. Here, a mobile scheme to support personal transportation is called personal mobility. Electricity-powered personal mobile devices are called personal vehicle. There are several differences between environments where conventional vehicles schemes (e.g. car or train) and personal vehicles are used, as follows:

- There are always pedestrians as obstacles
- There are no infrastructures for vehicles (e.g. crosswalks, signals etc.)
- Driver's skill is not guaranteed due to lack of driver's licence

Therefore, conventional vehicles like bicycles or cars cannot be used as personal vehicles. In recent years, due to advances in small and high power density battery and motor, a lot of products and researches about personal vehicles are appearing. Specifically, as a personal vehicle for non-handicapped, some stand-up riding vehicles using inverted pendulum structure

are developed. This paper especially focuses on this inverted pendulum personal vehicle since its mobility is higher than other vehicles. This is because the inverted pendulum structure can reduce its length and achieve counter-rotation. From these characteristics, an inverted-pendulum vehicle has efficient structure for personal vehicles running in mixed traffic. Recent researches show that an inverted pendulum personal vehicle is less harmful to pedestrians since the crushing could be easily avoided due to its reduced length and increased maneuverability. Figure 1 and Table 1 show the overview and specification about existing inverted pendulum personal vehicle respectively [Segway, 2012; Toyota, 2012; Naohisa, 2014].

In response to these characteristics, authors suggests an advanced concept of personal vehicle focusing on vehicle weight and size, named portable personal vehicle [Shimon et al., 2012; Shimon et al., 2013].

Unlike the normal electric vehicles [Johnson and Aylor, 1985], portable personal vehicle is a new type of electric vehicle which can not only carry drivers



Fig. 1 Personal vehicles

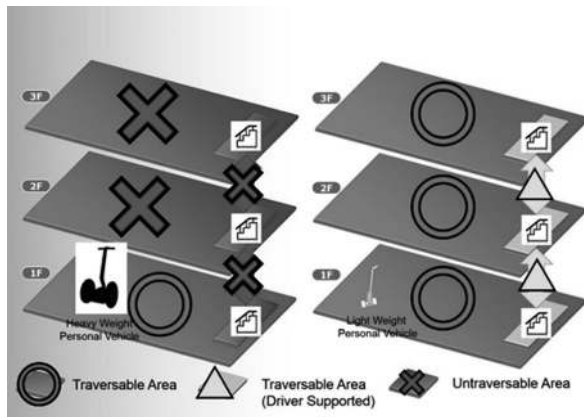


Fig. 2 Merits of portable personal vehicle

Table 1 Specification of existing personal vehicles

	Segway	Winglet	Micro Mobility
Company	Segway (USA)	TOYOTA (JAPAN)	AIST (JAPAN)
Weight	50 kg	15 kg	13 kg
Max. speed	20 km/h	6 km/h	6 km/h
Battery remain	2 hours	2 hours	30 min
Width	60 cm	40 cm	55 cm
Depth	50 cm	30 cm	40 cm
Height	120 cm	120 cm	130 cm

but also can be carried by drivers in case of overcoming the barriers (e.g. steps and escalators). Therefore, portable personal vehicle does not require any specific devices as the case of normal vehicles to overcome barriers (e.g. devices to climb up steps [Lawn and Ishimatsu, 2003]) while it is space-saving and harmless to other pedestrians and environments.

In addition, this paper describes a developed prototype of portable personal vehicle to validate its ability of both carrying drivers and carried by drivers.

## 2. PORTABLE PERSONAL VEHICLE

Personal vehicle is a single seater, short distance (within range of airports, shopping malls etc.) and electrically-powered vehicle. It is designed to support not only disabled persons but also non-handicapped persons in large space (e.g. university campus, airport, shopping mall etc.) [Joshua et al., 2010], where conventional vehicles (e.g. car, bike, etc.) cannot enter. Since infrastructures are designed for only pedestrians in those environments, barriers for the vehicle such as steps and escalators usually exists. In terms of energy consumption, weight and cost, however, using high traversability locomotion mechanism with huge wheels or caterpillar are not suitable solution. Therefore this paper suggests a concept that vehicle uses

driver to overcome limited but fatal barriers. Figure 2 shows an example case to explain this concept of portable personal vehicle. In Figure 2, a three-story building and its floors are connected to other floor by steps. Here each floor is flat and large enough to ride personal vehicles. If the large and powerful personal vehicle like Segway is used, it is impossible to move between floors. This is because Segway is so heavy and huge that we cannot lift them up. But if the vehicle is small and light enough to be lifted up by drivers, it is possible to move upstairs or downstairs carrying personal vehicle. Of course, the vehicle can climb up steps if a personal vehicle has high traversability locomotion mechanism with huge wheels or caterpillars. However, huge and heavy vehicles will harm other pedestrians in the mixed traffic environment [Chihiro et al., 2010; Chihiro et al., 2012]. Therefore the portable personal vehicles (of course maximum speed and power are less than existing personal vehicles) are much useful in mixed traffic environment [Makiko et al., 2012]. This paper describes a developed prototype of portable inverted pendulum personal vehicle based on such concept.

## 3. DEVELOPMENT OF PORTABLE PERSONAL VEHICLE

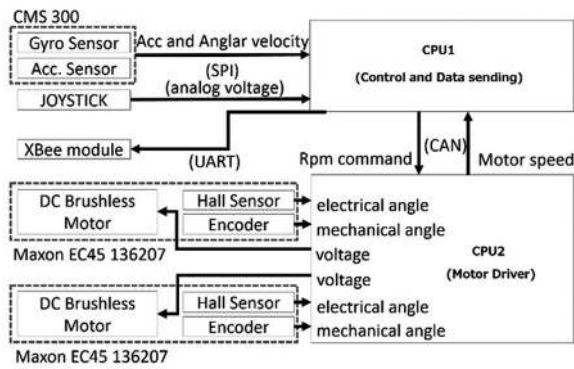
### 3.1 Objective

Under mixed traffic, maximum speed and running time are not important. This is because, high-speed vehicle is dangerous to pedestrians and short running distance is enough since long-distance transportation are not needed. Contrarily, weight is the most important factor of personal vehicle since to realize portability. In response, design targets are set as follows:

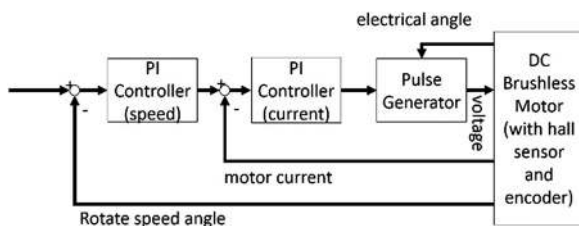
- Total weight is under 10 kg (including battery)  
10kg is the maximum weight that people can lift up by their single hand.
- Enough battery capacity to achieve running time more than 30 min  
30 min. is enough for moving from shop to shop in shopping malls at one time.
- Enough motor power for posture control and maximum transit speed is under 6 km/h  
Avoid falling forward or backward, the posture control is required. Also the restriction in the Japanese law that the Electrical Wheelchairs must not run at over 6km/h should be considered.

### 3.2 Overview

A system diagram and an overview of prototype vehicle are shown in Figure 3 and Figure 4 respectively. For downsizing and weight saving, the developed vehicle has two CPUs (CPU1 and CPU2). CPU1 sends



(a) System overview



(b) Motor driver diagram

Fig. 3 System overview and motor driver diagram

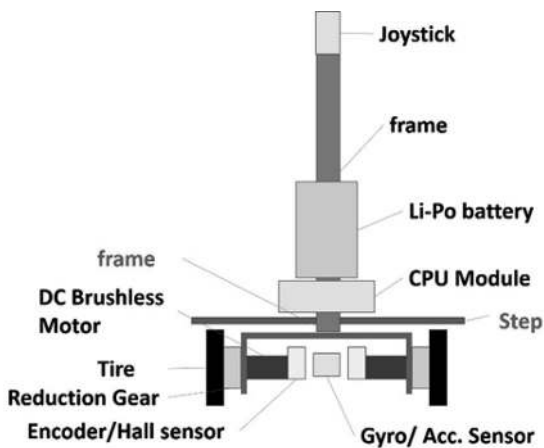


Fig. 4 Structure overview

Table 2 Parts of prototype vehicle

Reduction Gear	CSF-17-30-2UH (Harmonic Drive Systems Inc.)
Motor	EC45 (maxon)
Encoder	HEDL9140 (maxon)
Gyro and Acc. Sensor	CMS300 (Silicon Sensing Systems Inc.)
Motor Driver	TEC-3PMD-RB-V8 (Techno Craft Inc.)
CPU	mbed LPC1768
JoyStick	COM-09032 (Sparkfun)
Battery	Lipo 7S 2700 mAh (ZIPPY)

vehicle status (angle, angular velocity, transit and rotate velocity) via XBee wireless module and controls motor, And CPU2 is used for Motor Driver. In addition, a developed prototype vehicle uses a speed

feed-back control system instead of torque feed-back control. Using speed commands, vehicle can rotate in constant speed irrespective of driver's weight.

### 3.3 Reduction Gear

The weight of a developed vehicle is about 50 % of existing personal vehicle, due to the fact that choice of reduction gear becomes an important issue. Since a small and light personal vehicle must have small wheels (in the developed prototype vehicle uses 100 mm diameter, self-sealing tires), assuming the case of prototype vehicle running in normal speed of 4 [km/h], rotation speed of tire must have more than 212 [rpm]. In response, a motor itself must have higher rotation speed than existing vehicles like Segway. This leads to difficulty in keeping vehicle's posture since torque of vehicle's motor will be decreased at high rotation speed. Therefore, direct drive cannot be used. However, normal reduction gear has backlash as nonlinear element. In inverted pendulum vehicles, time lag and jerk around zero rotation speed (motor changes its rotation direction continuously) in occurred by backlash. In particular, large jerk reduces comfort of personal vehicle driver. Consequently, a developed prototype vehicle uses wave gear (reduction rate is 30) as reduction gear which has much less backlash.

### 3.4 Motor

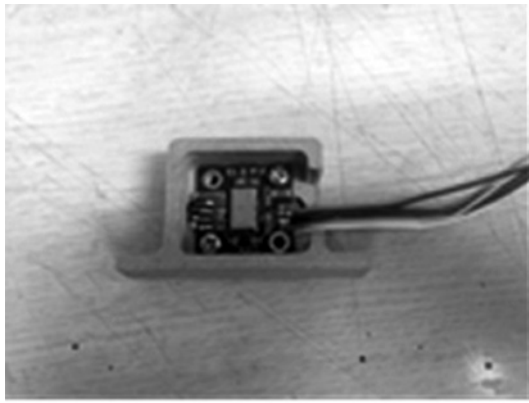
Since all the devices in the developed vehicle (motors, sensors, CPUs etc.) are powered by single battery, electrical noise for sensors and processors have to be reduced. Though DC brush motors have simple structure and are easily driven, it has brush as physical switch which becomes huge noise source since spark occurs when the motor is rotating. Therefore, to reduce spark noise, the developed prototype vehicle uses DC brushless motor (maxon inc. EC-45 250W).

### 3.5 Sensor

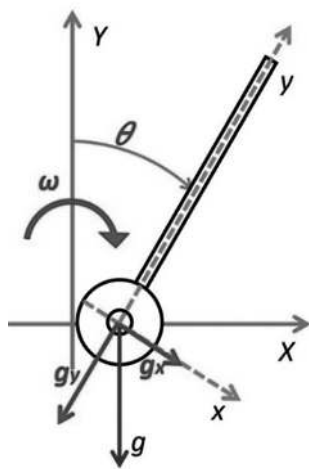
Figure 5 shows acceleration and gyro sensor (CMS300: Silicon Sensing Systems Inc.) used in the prototype vehicle and its corresponding axis. This sensor device has 2 axis accelerator sensor and one axis gyro sensor. Each axis has same origin and these axis are orthogonal axis. Therefore, gap between each sensor's axes does not need to be considered and space can be reduced. In addition, since CMS300 has SPI (Serial Peripheral Interface) as its signal interface, the effect of noise to sensors (which have analog voltage as its signal interface) can be reduced.

$$\theta_{acc} = \tan^{-1} \frac{gx}{-gy} \quad (1)$$

$$\theta_{gyro} = - \int \omega dt \quad (2)$$



(a) Overview of CMS300



(b) Axis of CMS300

Fig. 5 CMS300 and its axis

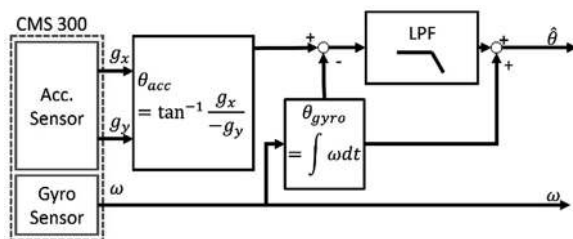


Fig. 6 Angle estimate filter

$$\hat{\theta} = \frac{1}{1 + \tau_{LPF}s} \theta_{acc} + \frac{1}{1 + \tau_{HPF}s} \theta_{gyro} \quad (3)$$

$$\hat{\theta} = \frac{1}{1 + \tau s} (\theta_{acc} - \theta_{gyro}) + \theta_{gyro} \quad (4)$$

The overview of gyro and acceleration sensor, filter diagram to estimate true angle and angular velocity of prototype vehicle, are shown in Figure 5 and Figure 6 respectively. Angle  $\theta_{acc}$  is derived as equation (1) in case only acceleration sensor is used to estimate vehicle's angle. However, there is a problem that the

acceleration sensor cannot separate gravitational acceleration and vehicle's acceleration. This means that the accuracy of angle estimation decreases when the prototype vehicle is increasing or decreasing its speed. And  $\theta_{acc}$  becoming non-negligible and it decrease. Estimated angle from gyro sensor  $\theta_{gyro}$  is defined in equation (2). Though gyro sensor is not effected by acceleration of vehicle, there is an integration error which makes it difficult to estimate angle only by gyro sensor. To estimate angle precisely, generally filtering methods such as Kalman or Perticle Filters are used [Hyung and Seul, 2009; Stuflessner and Brandner, 2008]. However in this prototype vehicle, to reduce calculation cost, this paper especially focuses on frequency band of acceleration and gyro sensors, and use only low pass filter to estimate angle. When frequency of vehicles acceleration is considered,  $\theta_{gyro}$  is more reliable than  $\theta_{acc}$  at high frequency (e.g. acceleration or deceleration) and  $\theta_{acc}$  is more reliable than  $\theta_{gyro}$  at low frequency (e.g. uniform moving). Therefore, in this filter, estimated angle  $\hat{\theta}$  is sum of high pass filtered  $\theta_{gyro}$  (time constant is  $\tau_{HPF}$ ) and low pass filtered  $\theta_{acc}$  (time constant is  $\tau_{LPF}$ ). Equation of  $\hat{\theta}$  is shown in equation (3). In addition, to estimate  $\hat{\theta}$ , sum of each filter's gain must be 1 so  $\tau_{LPF}$  must be equal to  $\tau_{HPF}$ . Consequently when  $\tau_{LPF} = \tau_{HPF} = \tau$  is substituted to equation (3),  $\hat{\theta}$  is described as equation (4).

### 3.6 Controller

Figure 7 shows a rotation controller of the developed prototype vehicle. Joy stick is used to command rotate velocity to prototype vehicle. Since joystick has more simple structure than other interfaces such as huge lever-like structure of Segway, weight could be reduced and toughness could be increased.

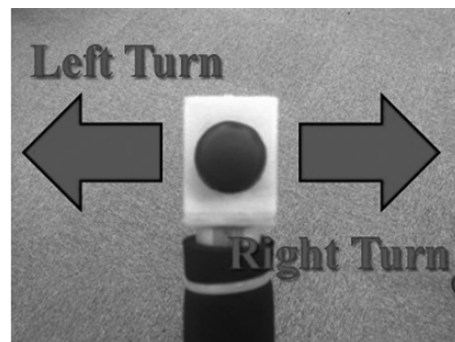
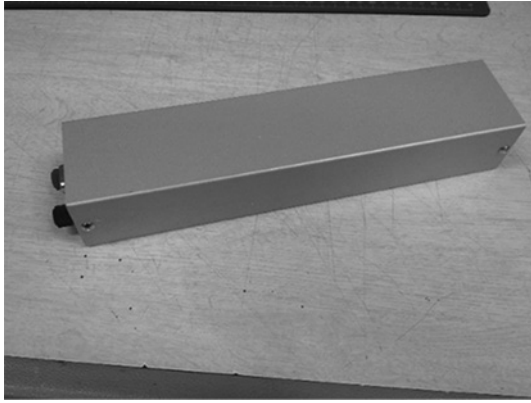


Fig. 7 Joystick interface

### 3.7 Battery

Figure 8 shows battery module of the prototype vehicle. Li-po battery (25.9 V 2700 mAh) is chosen as battery module because of safety, lightness and maximum output current. In addition, Li-po battery is put

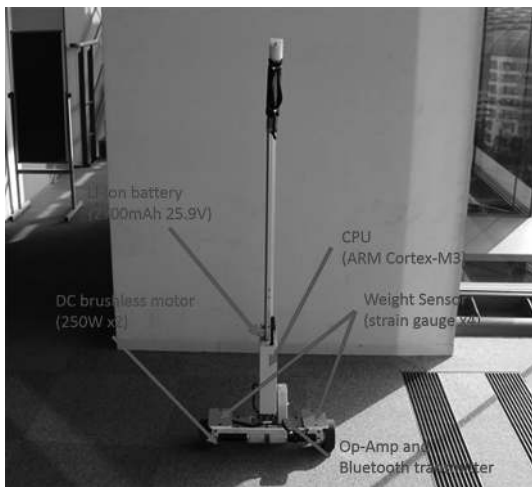


**Fig. 8** Battery module

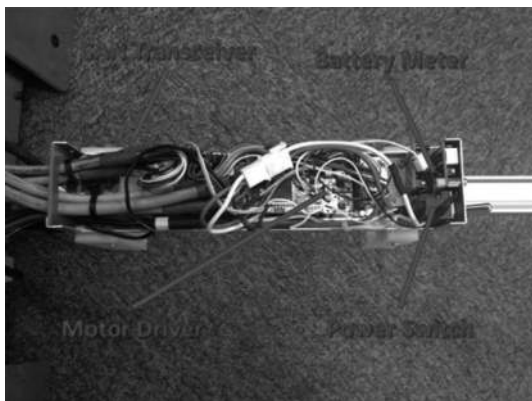
in aluminium case (45 mm × 55 mm × 250 mm) to defend drivers from damage of battery and to easily replace the battery.

**4. TRIAL RUN**

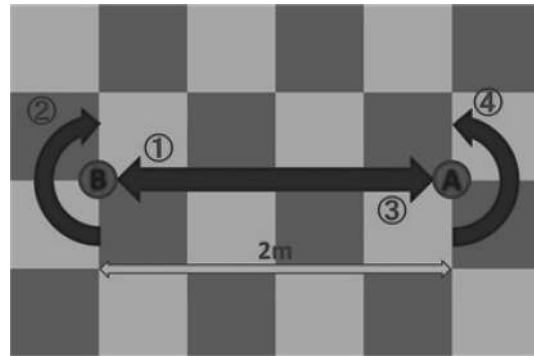
Figure 9 and Figure 10 shows an overview of the prototype vehicle and its internal circuit respectively. Table 3 shows specification of the developed prototype



**Fig. 9** Overview of prototype vehicle

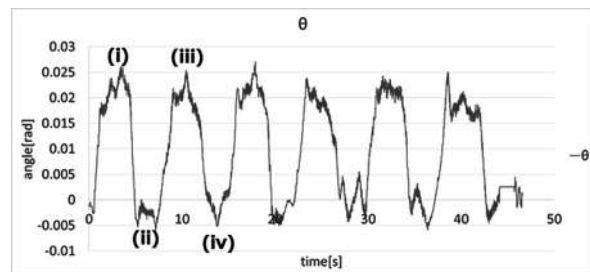


**Fig. 10** Internal circuit

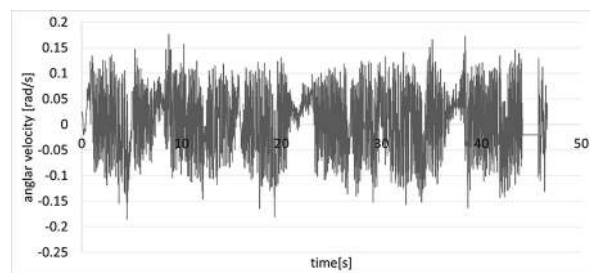


- i) Move A to B
- ii) Rotate 180 degree at B (Clockwise)
- iii) Move B to A
- iv) Rotate 180 degree at A (Counterclockwise)
- v) Repeat Step1 to 4 (3 times )

**Fig. 11** Test course



(a) Angle  $\theta$



(b) Angular velocity  $\omega$

**Fig. 12** Estimated angle and angular velocity while test course running

**Table 3** Specification of prototype vehicle

Spec	Value
Weight	8.2 kg
Max. speed	4.0 km/h
Running time	1.0 h
Width	50 cm
Depth	25 cm
Height	130 cm

vehicle. A developed prototype vehicle successfully fulfilled the objectives of portable personal vehicle. To validate posture control with drivers, trial run shown in Figure 11 was executed. In the trial run, subjects

were 10 healthy male persons (age 22-24) and each subject ran the trial course for 5 times. As a result, all the subjects have not fallen down. Therefore, it was proved that the prototype vehicle can be used as personal vehicle. Figure 12 shows one example of actual posture status (angle and angular velocity) of prototype vehicle during trial run. Judging from Figure 12 and Table 3 respectively, the prototype vehicle is lighter than general inverted-pendulum vehicle but it has enough power to carry drivers.

## 5. CONCLUSION

This paper proposed the concept of portable personal vehicle to overcome barriers where infrastructures are only designed for walking humans. Portable personal vehicle should be small and light enough which enables not only to carry drivers but also to be carried by the driver. Portable personal vehicle can easily overcome barriers in mixed traffic such as university campus, airports, shopping malls etc. and it is harmless to surrounding pedestrians.

Then a new inverted pendulum personal vehicle was developed based on the concept of portable personal vehicle. The developed prototype personal vehicle is much smaller and lighter than existing inverted pendulum personal vehicle (e.g. Segway, Winglet) since it weighs only 8.2kg. In addition, from the trial run, it was verified that the prototype vehicle has enough stability and power to be used as personal vehicles.

## References

- Ajisaka, S., S. Nakamura, T. Kubota, and H. Hashimoto, Proposal about control system of human affinitive personal vehicle including unconscious input, *30th Annual Conference of Robotics Society of Japan*, 2012.
- Ajisaka, S., S. Nakamura, T. Kubota, and H. Hashimoto, Basic verification of body sway characteristics for personal vehicle drivers, *CogInfoCom2012*, 2012.
- Ajisaka, S., T. Kubota, and H. Hashimoto, Proposal of human affinitive personal vehicle in iSpace, *The Robotics and Mechatronics Conference*, 2013.
- Candamo, J., M. Shreve, D. B. Goldgof, D. B. Sapper, and R. Kasturi, Understanding transit scenes: A survey on human behavior-recognition algorithms, *IEEE Transactions on Intelligent Transportation Systems*, Vol. 11, No. 1, 206-224, 2010.
- Fujikawa, T. and S. Nakajima, Proposal for an IR system to support automatic control for a personal mobility vehicle, *Proceedings of the 2012 IEEE International Conference on Robotics and Biomimetics*, 2207-2212, 2012.
- Hahimoto, N., Research status and challenges of mobility robot as new mobility, *The Journal of Institute of Electronics, Information and Communication Engineers*, Vol. 97, No. 6, 507-512, 2014.
- Johnson, B. W. and J. H. Aylor, Dynamic modeling of an electric wheelchair, *Industry Applications, IEEE Transactions*, Vol. IA-21, No. 5, 1284-1293, 1985.
- Lawn, M. J. and T. Ishimatsu, Modeling of a stair-climbing wheelchair mechanism with high single-step capability, *Neural Systems and Rehabilitation Engineering, IEEE Transactions*, Vol. 11, No.3, 323-332, 2003.
- Lee, H-J, and S. Jung, Gyro sensor drift compensation by Kalman filter to control a mobile inverted pendulum robot system, *IEEE International Conference on Industrial Technology*, 1-6, 2009.
- Miura, M. and Y. Takahashi, Proposal for personal mobility vehicle for people with limited mobility, *19th The Transportation and Logistics Conference*, 299-302, 2010.
- Nakagawa, C., K. Imai, A. Shintani, and T. Ito, Experimental study on the influence of the size of personal mobility vehicle on pedestrians, *Transactions of the Japan Society of Mechanical Engineers. C*, Vol. 78, No. 794, 3332-3342, 2012.
- Nakagawa, C., K. Nakano, Y. Suda, Y. Kawarasaki, and Y. Kosaka, Safety and comfort of the personal mobility vehicles in the pedestrian flows, *Transactions of the Society of Automotive Engineers of Japan*, Vol. 41, No. 4, 941-946, 2010.
- Sasaki, M., N. Yanagihara, O. Matsumoto, and K. Komoriya, Light weight personal vehicle operated by the movement of rider's center-of-gravity, *Journal of the Robotics Society of Japan*, Vol. 24, No. 4, 533-542, 2006.
- Segway (online), available from <http://www.segway.com/individual/models/index.php>, (accessed on 14 September, 2012).
- Stuessler, M., and M. Brandner, Vision-based control of an inverted pendulum using cascaded particle filters, *Instrumentation and Measurement Technology Conference Proceedings*, 2097-2102, 2008.
- Suda, Y., Y. Hirayama, D. Yamaguchi, and M. Aki, Communication with personal mobility vehicle and driver, *Research of Production*, Vol. 64, No. 2, 193-196, 2012.
- Toyota Winglet (online), available from [http://www.toyota.co.jp/jpn/news/video\\_news/tech](http://www.toyota.co.jp/jpn/news/video_news/tech), (accessed on 14 September, 2012).
- Yamaoka, M., Personal mobility robot, *Journal of the Robotics Society of Japan*, Vol. 26, No. 8, 885-886, 2008.

(Received July 12, 2014; accepted October 30, 2014)