

A NEW REDUCED SIZE MICROSTRIP PATCH ANTENNA WITH FRACTAL SHAPED DEFECTS

A. Kordzadeh and F. Hojat Kashani

College of Electrical Engineering
Iran University of Science and Technology
Narmak, Tehran, Iran

Abstract—With development of communication with integration technology, size reduction of microstrip antennas is becoming an important design consideration for practical applications. Here a new microstrip antenna with Koch shaped fractal defects on the patch surface is presented. Using this method, the overall electric length of the antenna is increased largely and hence the size of antenna is reduced to 85%, compared to an ordinary microstrip antenna with the same resonance frequency. Antenna is simulated using high frequency structure simulator (HFSS) V.10 which is based on finite element modeling (FEM). Finally antenna is fabricated on RO4003 substrate. Measurement results are in good agreement with simulated results.

1. INTRODUCTION

Microstrip antennas are investigated vastly due to their properties, such as low profile, low cost, conformability and ease of integration with active devices. The size of antenna is extremely important for most wireless communication systems. But it is desired that the reduced size antenna have equivalent operation in comparison with ordinary developed antennas. There are limits to how small an antenna can be, however the most important of them are bandwidth and gain. Fortunately a lot of communication systems don't require large bandwidths; therefore, it is not an important problem. Many techniques have been used to reduce the size of antenna, such as using dielectric substrates with high permittivity [1], applying resistive or reactive loading [2], increasing the electrical length of antenna by optimizing its shape [3], Utilization of strategically positioned notches on the patch antenna [4]. Various shapes of slots and slits have been embedded on patch antennas to reduce their size. These perturbations

that are embedded on the antenna are used to increase the surface current path. To decrease the resonant frequency of an antenna for a given surface area, the current path must be maximized within the area [4].

Fractal shaped antennas show some interesting features which results from their geometrical properties. These shapes are characterized by two important properties; one of them is self similarity and another one is space filling. The self-similarity of certain fractal structures result in a multi-band behavior of self similar fractal antennas and frequency selective surfaces (FSS) [5]. Due to their space filling prosperities, Fractals can be used in antenna miniaturization. The usage of space filling curves increase antenna's electrical length [6].

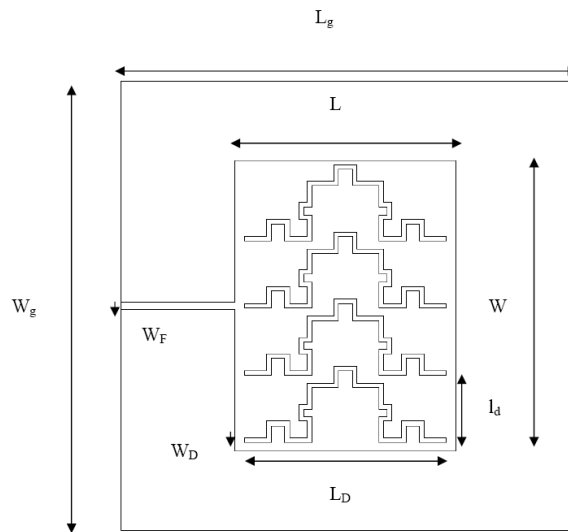

Figure 1. Schematic of the antenna.

2. ANTENNA GEOMETRY AND OPERATION MECHANISM

Here a new reduced size microstrip antenna with ultra low profile features is presented. This antenna configuration is shown in Fig. 1. The patch has dimensions of $W \times L$. The RO4003 substrate which has a relative permittivity $\epsilon_r = 3.38$ and thickness 0.762 mm (30 mil) is used. The ground plane dimensions are $W_g \times L_g = 10 \text{ cm} \times 10 \text{ cm}$. The antenna is fed by a microstrip line with characteristic impedance 50Ω and width $W_f = 1.7 \text{ mm}$, that is placed at the center of the patch

radiating edge. Four fractal defected microstrip structures (DMS) are excoriated from the patch's surface. The lengths of these DMS's are L_d and their width are W_d , and all have the same dimensions. These DMS's are placed at equal distances from each other. Table 1 shows the designed dimensions that are used for the antenna.

Table 1. Designed dimensions of the antenna in mm.

W_g	L_g	W	L	W_D	L_D	l_d	W_f
100	100	65	49	1	45	15	1.7

The proposed antenna is simulated using high frequency structure simulator (HFSS) V.10 which is based on finite element modeling (FEM). Fig. 2 shows the simulated and measured return loss versus frequency for the proposed antenna without matching network. As it can be seen in this figure, the first resonance occurs at 622 MHz, in comparison with the antenna with the equal size but without DMS's that has a resonance frequency at 1.61 GHz. A rectangular patch with the resonance frequency at 622 MHz, must have a total area of about 31353 mm². The proposed antenna with the total area of 3204 mm², operates at this frequency. So the size reduction of this approach is about 85% in comparison with ordinary patch.

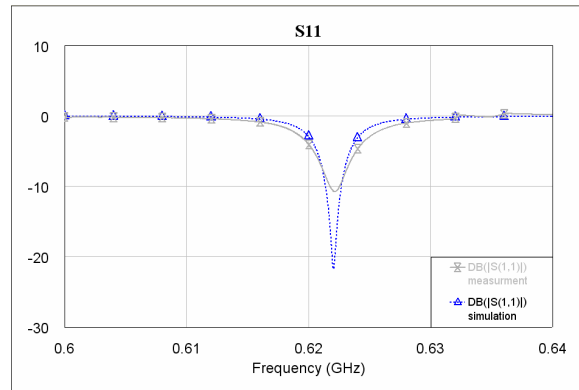

Figure 2. Simulated and measured return loss of the proposed structure.

Figure 3 shows the simulated vector surface current distribution on the patch antenna at the operating frequency. As can be seen in this figure, by inserting these defects on the antenna, surface current path's

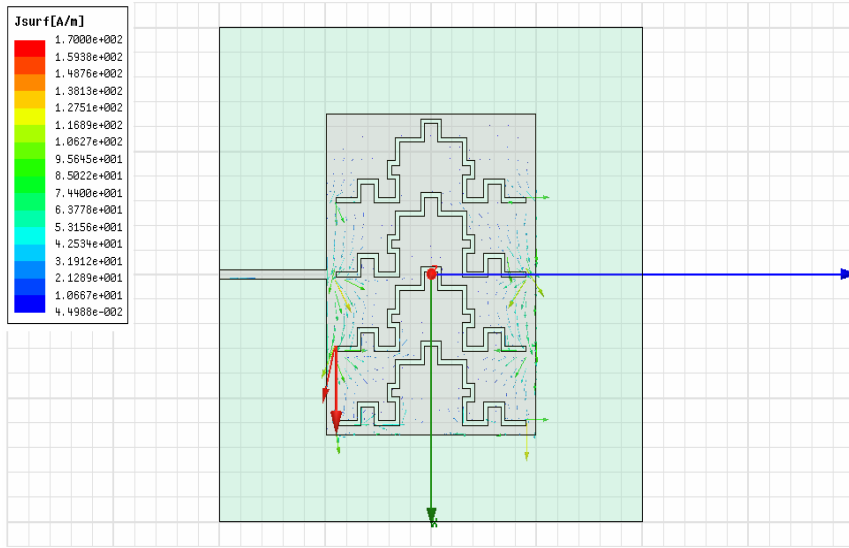

Figure 3. Simulated vector surface current distribution on the patch antenna.

is meandered and hence the electrical length of antenna is increased, although the physical length is left constant. So by increasing the electrical length of the antenna, the resonance frequency is decreased. This means that for an antenna with the same resonance frequency, the overall surface of antenna is decreased to a great amount.

The simulated antenna impedance bandwidth for 10 dB return loss is very narrow (below 1%). In order to increase the antenna bandwidth to an acceptable value, a matching circuit, as shown in Fig. 4, is used at the feed line, to achieve a higher bandwidth. This matching circuit is simulated and optimized by Microwave Office 2004 (AWR V.6.51). These LC matching circuit parameters are optimized in order to achieve an acceptable bandwidth about 1%. The final optimized values are inserted at the antenna feed line, and are listed on Table 2.

Table 2. Values of optimized parameters of the matching network.

L_1	L_2	C_1	C_2
8.2 nH	56 nH	28.8 μ F	10.14 μ F

Fig. 5 shows the measured return loss versus frequency for this

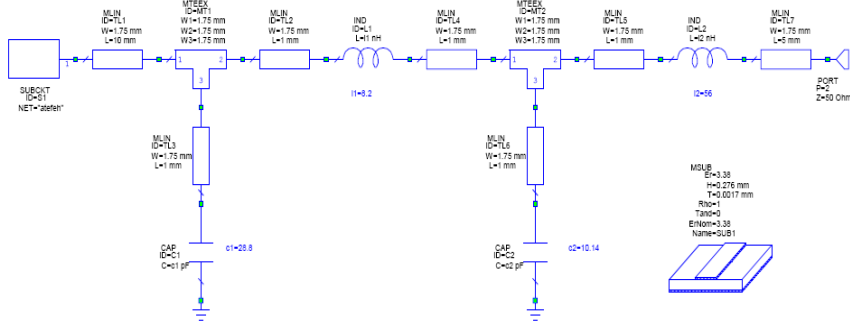

Figure 4. Matching network.

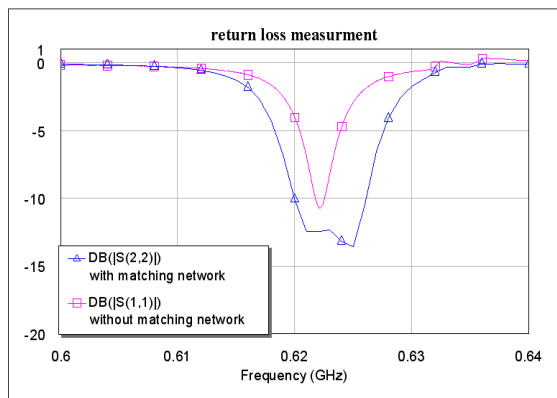

Figure 5. Measured return loss of the proposed antenna with and without matching circuit.

antenna with and without matching network. It can be seen that bandwidth is increased to 1%.

3. MEASUREMENT RESULTS

Finally antenna is fabricated and tested. The following measurement results show a good agreement with the simulations. The fabricated prototype is shown in Fig. 6. The measured radiation pattern is shown in Fig. 7. Back lobe in radiation pattern is because of small ground plane.

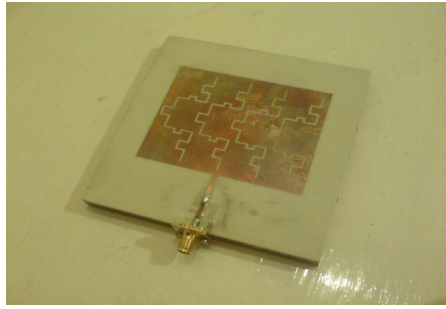
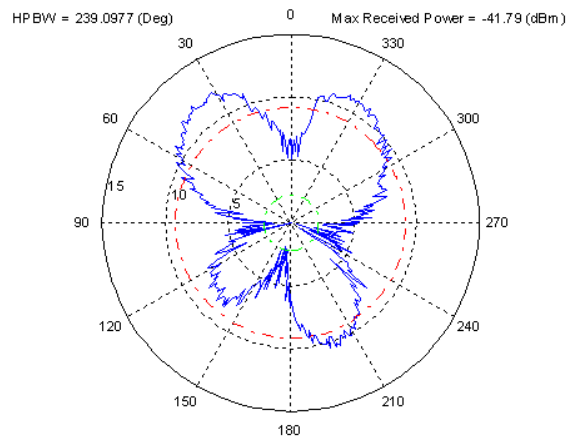
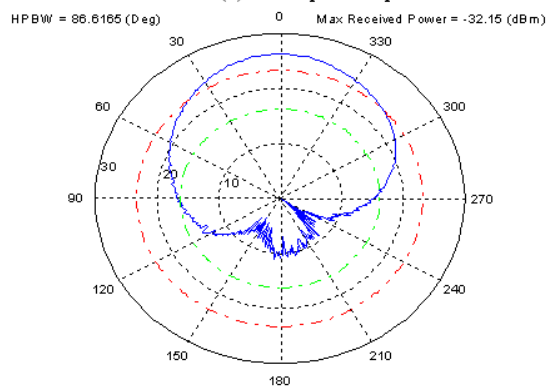

Figure 6. Fabricated antenna.



(a) Cross polar H plane



(b) Copolar H Plane

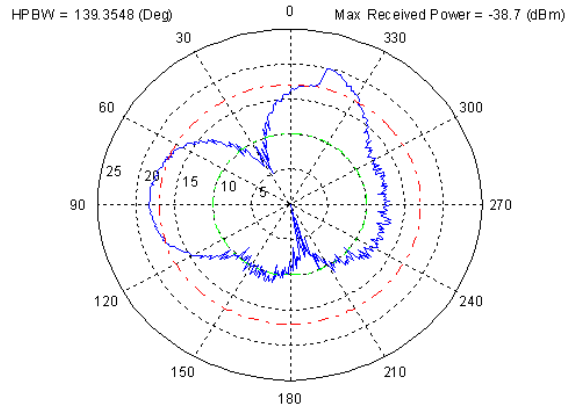

(c) Crosspolar E Plane

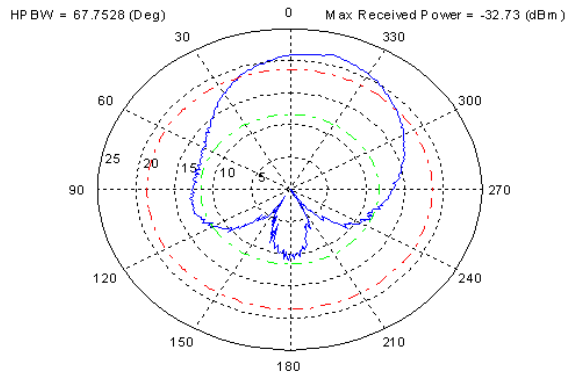

(d) Copolar E Plane

Figure 7. The measured radiation pattern.

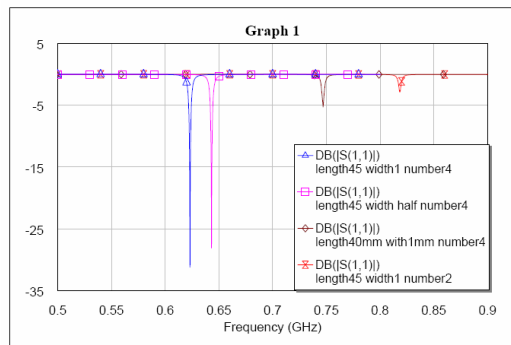

Figure 8. Effect of dimensional variation on the frequency response.

4. THE EFFECT OF DIMENSIONAL VARIATION ON FREQUENCY RESPONSE

As shown in previous sections, by inserting several DMS's on the patch antenna, the resonant frequency is decreased. In this section, the effect of these defects' dimensions such as their length and width, on the frequency response is investigated. By increasing defect's length, the electrical length is increased more; hence there is a more reduction in the resonant frequency. These effects are more obvious in Fig. 8. In this figure once the element length is fixed and width is halved, and once length is decreased and width is remained fixed and in another one, number of defects is reduced to 2. In this figure, length and width is related to the defects dimensions, and number refers to the number of defects. Table 3 list values and their related resonant frequency that are used for this analysis. As is expected, higher number of these defects results in more increase in electrical length and more decrease in the resonance frequency.

Table 3. Effects of dimensional variations of the DMS on the resonance frequency.

L_d	W_d	Number of defects	f_r
45	1	4	622 MHz
40	1	4	728 MHz
45	0.5	4	638 MHz
45	1	2	800 MHz

5. CONCLUSION

Here a new fractal shaped defected microstrip antenna is proposed. Using these defects, the surface current path is lengthened and thus the resonance frequency is decreased to a great deal. When compared with an antenna of the same resonance frequency, a reduction of about 85% is achieved in antenna size. By adding a matching network to the antenna feed, bandwidth is increased to an acceptable value. This antenna can be used in applications where the overall volume of the structure is an important factor, such as mobile terminals, etc.

REFERENCES

1. Lo, T. K. and Y. Hwang, "Microstrip antennas of very high permittivity for personal communications," *1997 Asia Pacific Microwave Conference*, 253–256, 1997.
2. Sinati, R. A., *CAD of Microstrip Antennas for Wireless Applications*, Artech House, Norwood, MA, 1996.
3. Wang, H. Y. and M. J. Lancaster, "Aperture-coupled thin-film superconducting meander antennas," *IEEE Transaction on Antennas and Propagation*, Vol. 47, 829–836, 1999.
4. Waterhouse, R., *Printed Antennas for Wireless Communications*, John Wiley & Sons Inc, 2007.
5. Borja, C. and J. Romeu, "On the behaviour of koch island fractal boundry microstrip patch anetnna," *IEEE Transaction on Antennas and Propagation*, Vol. 51, No. 6. July 2003.
6. Kim, L.-K., J.-G. Yook, and H.-K. Park, "Fractal-shape small size microstrip patch antenna," *Microwave and Technology Letters*, Vol. 34, No. 1, July 2002.