

Air Force Institute of Technology

**AFIT Scholar**

---

Theses and Dissertations

Student Graduate Works

---

3-2008

## A Novel Communications Protocol Using Geographic Routing for Swarming UAVs Performing a Search Mission

Robert L. Lidowski

Follow this and additional works at: <https://scholar.afit.edu/etd>



Part of the [Computer Sciences Commons](#)

---

### Recommended Citation

Lidowski, Robert L., "A Novel Communications Protocol Using Geographic Routing for Swarming UAVs Performing a Search Mission" (2008). *Theses and Dissertations*. 2753.

<https://scholar.afit.edu/etd/2753>

This Thesis is brought to you for free and open access by the Student Graduate Works at AFIT Scholar. It has been accepted for inclusion in Theses and Dissertations by an authorized administrator of AFIT Scholar. For more information, please contact [richard.mansfield@afit.edu](mailto:richard.mansfield@afit.edu).



A NOVEL COMMUNICATIONS PROTOCOL  
USING GEOGRAPHIC ROUTING  
FOR SWARMING UAVS PERFORMING  
A SEARCH MISSION

THESIS

Robert L. Lidowski, Captain, USAF

AFIT/GCS/ENG/08-14

DEPARTMENT OF THE AIR FORCE  
AIR UNIVERSITY

**AIR FORCE INSTITUTE OF TECHNOLOGY**

Wright-Patterson Air Force Base, Ohio

APPROVED FOR PUBLIC RELEASE; DISTRIBUTION UNLIMITED.

The views expressed in this thesis are those of the author and do not reflect the official policy or position of the United States Air Force, Department of Defense, or the United States Government.

AFIT/GCS/ENG/08-14

A NOVEL COMMUNICATIONS PROTOCOL  
USING GEOGRAPHIC ROUTING  
FOR SWARMING UAVS PERFORMING  
A SEARCH MISSION

THESIS

Presented to the Faculty

Department of Electrical and Computer Engineering

Graduate School of Engineering and Management

Air Force Institute of Technology

Air University

Air Education and Training Command

In Partial Fulfillment of the Requirements for the

Degree of Master of Science in Computer Science

Robert L. Lidowski, BS

Captain, USAF

March 2008

APPROVED FOR PUBLIC RELEASE; DISTRIBUTION UNLIMITED.

A NOVEL COMMUNICATIONS PROTOCOL  
USING GEOGRAPHIC ROUTING  
FOR SWARMING UAVS PERFORMING  
A SEARCH MISSION

Robert L. Lidowski, BS  
Captain, USAF

Approved:

  
\_\_\_\_\_  
Barry E. Mullins, PhD (Chairman)

29 Feb 08  
Date

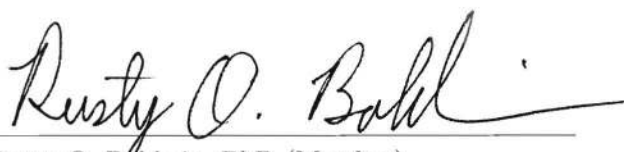
  
\_\_\_\_\_  
Rusty O. Baldwin, PhD (Member)

29 Feb 08  
Date

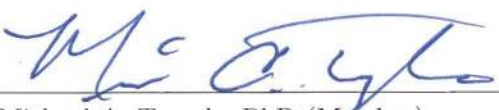
  
\_\_\_\_\_  
Michael A. Temple, PhD (Member)

29 Feb 08  
Date

*Abstract*

This research develops the UAV Search Mission Protocol (USMP) for swarming UAVs and determines the protocol's effect on search mission performance. It is hypothesized that geographically routing USMP messages improves search performance by providing geography-dependent data to locations where it impacts search decisions. It is also proposed that the swarm can use data collected by the geographic routing protocol to accurately determine UAV locations and avoid sending explicit location updates.

The hypothesis is tested by developing several USMP designs that are combined with the Greedy Perimeter Stateless Routing (GPSR) protocol and a search mission swarm logic into a single network simulation. The test designs use various transmission power levels, sensor types and swarm sizes. The simulation collects performance metrics for each scenario, including measures of distance traveled, UAV direction changes, number of searches and search concentration.

USMP significantly improves mission performance over scenarios without inter-UAV communication. However, protocol designs that simply broadcast messages improve search performance by 83% in total searches and 20% in distance traveled compared to geographic routing candidates. Additionally, sending explicit location updates generates 3%-6% better performance per metric versus harvesting GPSR's location information.

*To my Wife and Son*

## *Acknowledgements*

I would like to thank Dr. Barry Mullins, my thesis advisor, for keeping me on track. I would also like to acknowledge my classmate, Moses James, for his invaluable lessons in C programming.

Robert L. Lidowski



## Table of Contents

	Page
Abstract . . . . .	iv
Acknowledgements . . . . .	vi
List of Figures . . . . .	x
List of Tables . . . . .	xii
List of Abbreviations . . . . .	xiii
I. Introduction . . . . .	1
1.1 Motivation . . . . .	1
1.2 Overview and Goals . . . . .	1
1.3 Thesis Layout . . . . .	2
II. Literature Review . . . . .	3
2.1 Overview . . . . .	3
2.2 UAVs . . . . .	3
2.3 Sensors . . . . .	5
2.4 Autonomous Control Techniques and UAV Swarms . . . . .	7
2.5 Cooperative Robotic Search . . . . .	9
2.6 Wireless Networks . . . . .	11
2.7 MANETs . . . . .	14
2.7.1 The Study and Effect of Mobility on MANETs . . . . .	15
2.7.2 Network Partitioning . . . . .	16
2.7.3 Routing in a UAV Swarm . . . . .	17
2.8 Geographic Routing and GPSR . . . . .	18
2.9 Wireless Signal Properties . . . . .	21
2.9.1 Interference . . . . .	21
2.9.2 Path Loss, Propagation Models and Transmission Range . . . . .	21
2.9.3 Wireless Collisions . . . . .	22
2.10 Simulation . . . . .	23
2.11 Related Research . . . . .	24
2.12 Summary . . . . .	25
III. Methodology . . . . .	27
3.1 Overview . . . . .	27
3.2 Problem Definition, Goals and Hypothesis . . . . .	27
3.3 Approach . . . . .	28
3.4 System Boundaries . . . . .	33
3.5 System Services . . . . .	34
3.6 Workload . . . . .	34

	Page
3.7 Metrics . . . . .	36
3.8 System Parameters . . . . .	38
3.9 Workload Parameters . . . . .	42
3.10 Factors . . . . .	43
3.11 Evaluation Technique . . . . .	46
3.12 Experimental Design . . . . .	47
3.13 Summary . . . . .	49
IV. Results and Analysis . . . . .	51
4.1 Overview . . . . .	51
4.2 Validation . . . . .	51
4.2.1 UAV Search System Validation . . . . .	51
4.2.2 GPSR Model and USMP Validation . . . . .	55
4.3 Results and Analysis of UAV Search System Performance . . . . .	58
4.3.1 Analysis of Total Searches . . . . .	61
4.3.2 Analysis of Average Distance Traveled . . . . .	65
4.3.3 Analysis of Average Direction Changes . . . . .	69
4.3.4 Analysis of Search Redundancy Concentration . . . . .	76
4.3.5 Analysis of Cooperation Score and Search Redundancy . . . . .	80
4.4 Overall Analysis . . . . .	81
4.5 Summary . . . . .	83
V. Conclusions and Recommendations . . . . .	84
5.1 Overview . . . . .	84
5.2 Conclusions . . . . .	84
5.3 Significance of Research . . . . .	86
5.4 Recommendations for Future Research . . . . .	86
5.5 Summary . . . . .	87
Appendix A. Implementation Details . . . . .	88
A.1 Overview . . . . .	88
A.2 Node Models . . . . .	88
A.3 Process Models . . . . .	90
A.4 uav_search Packet Format . . . . .	92
A.5 Setting Up a New Scenario . . . . .	93
Appendix B. OPNET Workflow Tips . . . . .	102
B.1 Overview . . . . .	102
B.2 The Code Editor . . . . .	102
B.3 Common OPNET Errors . . . . .	103
B.4 Distributed Simulations . . . . .	103
B.5 Version Control . . . . .	104
B.6 Statistics Collection . . . . .	105
B.6.1 Adding and Changing Local Statistics . . . . .	105

	Page
B.6.2 Size of Results . . . . .	105
B.6.3 Recording a Single Statistic Value for an Experiment . . . . .	106
B.6.4 Exporting Data to a Spreadsheet . . . . .	106
B.7 Animation . . . . .	107
Bibliography . . . . .	109

*List of Figures*

Figure		Page
1	Micro-, mini- and major-UAVs . . . . .	4
2	A swarm of ants computing the shortest path to food . . . . .	8
3	OSD's projected trend in UAV autonomy through 2025 . . . . .	9
4	The components of a geographic routing algorithm . . . . .	18
5	A situation where greedy forwarding fails to find a route . . . . .	20
6	Waypoint Conflict Resolution Process . . . . .	31
7	UAV Search System . . . . .	33
8	The center quarter cell search criterion . . . . .	43
9	Calculation the minimum full network transmission range . . . . .	45
10	Comparison of validation flight paths versus original control scenarios . . .	53
11	Average Distance Traveled validation (UAV 1) . . . . .	56
12	Average Distance Traveled validation (UAV 2) . . . . .	56
13	Cooperation Score validation . . . . .	57
14	Average Direction Changes validation . . . . .	57
15	Example test scenario for GPSR and USMP validation . . . . .	59
16	Reciprocal Total Searches ANOVA assumptions plots . . . . .	63
17	Reciprocal Total Searches Main Effects Plot . . . . .	64
18	Reciprocal Total Searches interaction plot . . . . .	65
19	Log Average Distance Traveled ANOVA assumptions plots . . . . .	66
20	Log Average Distance Traveled main effects plot . . . . .	68
21	Log Average Distance Traveled interaction plot . . . . .	69
22	Total Searches versus Average Distance Traveled * Swarm Size . . . . .	70
23	Log Average Direction Changes ANOVA assumptions plots . . . . .	72
24	Log Average Direction Changes main effects plot . . . . .	73
25	Log Average Direction Changes interaction plots . . . . .	74
26	Search Redundancy Concentration ANOVA assumptions plots . . . . .	78

Figure		Page
27	Search Redundancy Concentration main effects plot . . . . .	79
28	Search Redundancy Concentration interaction plots . . . . .	80
29	The positive linear relationships selected metrics . . . . .	81
30	The two important simulation node models . . . . .	88
31	UAV node model . . . . .	89
32	Search Observer node model . . . . .	90
33	USMP packet format . . . . .	92

*List of Tables*

Table		Page
1	Search mission related features of in-service mini-UAVs . . . . .	5
2	A comparison of performance analysis techniques . . . . .	24
3	Transmission ranges and their associated transmit power . . . . .	46
4	Summary of factor levels and brevity codes . . . . .	49
5	Model and ANOVA results for Reciprocal Total Searches . . . . .	62
6	Model and ANOVA results for Log Average Distance Traveled . . . . .	67
7	Model and ANOVA results for Log Average Direction Changes . . . . .	71
8	Model and ANOVA results for Search Redundancy Concentration . . . . .	77
9	Positive effect of USMP versus no inter-UAV communication . . . . .	85
10	List of simulation attributes . . . . .	94

*List of Abbreviations*

Abbreviation		Page
UAV	Unmanned Aerial Vehicle . . . . .	1
USMP	UAV Search Mission Protocol . . . . .	1
MANET	Mobile Ad Hoc Network . . . . .	3
GPSR	Greedy Perimeter Stateless Routing . . . . .	3
DoD	Department of Defense . . . . .	3
RF	Radio Frequency . . . . .	5
OSD	Office of the Secretary of Defense . . . . .	8
IEEE	The Institute of Electrical and Electronic Engineers . . . . .	11
AP	Access Point . . . . .	12
AP-UAV	Access Point Enabled UAV . . . . .	12
PDA	Personal Digital Assistant . . . . .	14
GPS	Global Positioning System . . . . .	18
dB	decibels . . . . .	21
dBm	decibel milliwatts . . . . .	22
MAC	Media Access Control . . . . .	22
SIFS	Short Interframe Space . . . . .	23
DIFS	Distributed Coordination Function Interframe Space . . . . .	23
m	meters . . . . .	46
WR	Waypoint Conflict Resolution (factor) . . . . .	49
LU	Location Updates (factor) . . . . .	49
TP	Transmission Power (factor) . . . . .	49
Ssr	Sensor Type (factor) . . . . .	49
SS	Swarm Size (workload parameter) . . . . .	49
IL	Initial Location (factor) . . . . .	49
ODB	OPNET debugger . . . . .	58
ICI	Interface Control Information Structure . . . . .	90
KP	OPNET Kernel Procedure . . . . .	102

A NOVEL COMMUNICATIONS PROTOCOL  
USING GEOGRAPHIC ROUTING  
FOR SWARMING UAVS PERFORMING  
A SEARCH MISSION

**I. Introduction**

**1.1 Motivation**

The Air Force employs unmanned aerial vehicles (UAVs) for reconnaissance, battle damage assessment and direct attack missions. Currently, pilots control UAVs remotely without the intervention of algorithms to control UAV behavior or intercommunication. The one-to-one relationship between pilots and UAVs limits the scope of UAV mission capability as the number of UAVs working cooperatively is limited by the number of operators and how well they can coordinate their efforts. Some important missions, like continuous reconnaissance over hundreds of square kilometers using hundreds of UAVs, are beyond the scope of available resources. Shifting from human control to an autonomous swarm of cooperative UAVs will enable the Air Force to carry out large scale UAV missions.

**1.2 Overview and Goals**

The goal of this research is to develop the UAV Search Mission Protocol (USMP) for swarming UAVs and determine the effect of the protocol on search mission performance. Optimum performance is defined as the minimum amount of searching and travel required to scan each cell in a search area at least once.



### ***1.3 Thesis Layout***

This chapter describes research motivation, overview and goals. Chapter II defines important terms, summarizes related research and reviews concepts necessary to understand USMP design and requirements. Chapter III outlines research methodology. Chapter IV describes and analyzes experimental results, and Chapter V provides conclusions, explains the significance of this research and recommends future areas of research.

## II. Literature Review

### 2.1 Overview

This chapter defines UAVs, sensors, swarms, mobile ad hoc networks (MANETs), geographic routing, wireless signal properties, simulation and related research. Section 2.2 outlines different types and missions of UAVs and describes the search mission in particular. Section 2.3 describes the need for sensors in UAVs and different categories of sensors. Sections 2.4 and 2.5 introduce swarming and applying it to groups of UAVs. Section 2.6 discusses wireless networks; Section 2.7 discusses MANETs, a special type of wireless network. Section 2.8 describes geographic routing and Greedy Perimeter Stateless Routing (GPSR), a MANET routing protocol. Section 2.9 covers the properties of wireless signals that affect wireless network studies, especially simulations, which are defined in Section 2.10. Section 2.11 compares this study to related research efforts in swarming, UAVs, the search mission and MANET routing protocols.

### 2.2 UAVs

UAVs are aerial vehicles that do not carry human operators. They operate autonomously or receive remote direction from human pilots. Though UAVs may carry munitions, missiles and artillery shells themselves are not UAVs [DoD07]. UAVs range in size from the man-portable (mini- and micro-UAVs) to full-sized aircraft (major-UAVs). They fulfill a wide variety of missions, and interest in them spans the Department of Defense (DoD). Air Force interests include reconnaissance, “strike, force protection, and signals collection” [OSD05]. Army interests in UAVs include forward reconnaissance and extending network connectivity to forward deployed units through multi-hop wireless routing [JoP04].

UAVs offer cost and safety benefits compared to piloted aircraft. In hostile areas where aerial vehicles have a high probability of loss, commanders can employ UAVs without risking friendly personnel. Smaller UAVs, such as micro- and mini-UAVs, provide cost savings, including reduced manufacture and maintenance costs, as well as reduced fuel consumption. Military units with man-portable models can pack UAVs into regular cargo and setup operations without airfield support, which further reduces operating cost. Figure 1 shows the relative sizes of mini-, micro- and major-UAVs.



(a) Micro-UAV and a pencil



(b) Mini-UAV and a human operator



(c) Major-UAV and human operators

Figure 1: Micro-, mini- and major-UAVs [OSD05]

This research examines mini-UAVs performing a “search mission” as defined by Gaudio, et al. [GSB04]. Search missions encompass reconnaissance, signal collection and target search. In view of their size, portability and expendability, mini-UAVs conform well to the search mission. While several micro-UAVs are in development, at least four mini-UAV

models can provide surveillance service to US forces [OSD05]. Mini-UAVs also offer a better cost-risk ratio compared to major-UAVs when searching dangerous areas [OSD05].

For a study of mini-UAVs, a general model of the “typical mini-UAV” needs to be developed. Table 1 contains the characteristics of in-service mini-UAVs related to search missions. The typical in-service mini-UAV can fly for about 1 hour and travel at 16-22 meters per second. Search missions require a mini-UAV to carry electronic sensors for detection of signals, enemies, or other interesting phenomenon.

Table 1: Search mission related features of in-service mini-UAVs [US 99] [US 07a] [US 07b] [US 06]

	<b>Dragon Eye</b>	<b>FPASS (Desert Eagle)</b>	<b>Pointer</b>	<b>Raven</b>
Flight Endurance	45-60 min	1 hour	2 hour	1.5 hours
Cruise Speed	18 m/s	14.4-24.6 m/s	22.1 m/s	13.4-26.8 m/s

### 2.3 Sensors

Electronic sensors detect properties of the physical environment and produce an electrical signal for analysis. For example, sensors can observe radio frequency (RF) signals, visible light, air pressure and distance. A UAV reconnoitering for targets may listen for enemy RF signals produced by communication, use light sensors to record video of enemies, and then use a laser-based distance sensor to calculate target coordinates. The precise capability of a UAV’s sensors, or sensor array, differs between UAV models.

Recent simulation studies of UAVs performing a search mission do not focus on the precise capabilities of each UAV’s sensor [YoP05] [GSB04] [Mor06]. In these studies, the search area is divided into a 2 or 3-dimensional grid where cell size roughly corresponds to how much surface area a downward-directed sensor can scan in a single time quantum.

This is useful since government and private industry develop a wide variety of adjustable precision sensors [LTH02] [MyH04]. Thus, a study focused on search mission performance can adequately model sensor precision by controlling the search grid’s cell size relative to the overall search area.

Though abstracting away a sensor’s precise capability proves useful in experimentation, the distinction between passive and active sensors must still be considered. Active sensors, such as a laser range finder, expend enough energy to require a UAV with limited battery power or fuel to selectively operate the sensor to avoid reducing the UAV’s flight endurance period. In a search mission, that would mean turning off the active sensor until the UAV is needed to search a specific cell. Passive sensors consume power at a rate low enough to allow searching UAVs to continually operate sensors without affecting flight endurance. In a search mission, this means leaving the sensor on to scan any cell the UAV happens to pass through. As described in Chapter III, this research explores the effect of passive versus active sensors on the USMP and search mission performance.

When employed in a search as outlined in Section 2.2, large-scale missions (more than 10 UAVs working cooperatively) require multiple sensor-carrying UAVs. In such a mission, the optimal (minimum) search time decreases as additional UAVs join the search until the search task can no longer be subdivided [Mor06] [GSB04]. Currently, the number of UAVs working cooperatively on a mission is limited by the number of available human operators and how well the human operators can coordinate their efforts.

## *2.4 Autonomous Control Techniques and UAV Swarms*

Scaling up UAV search missions requires autonomous UAV control techniques. Autonomous control techniques allow UAVs to make mission decisions independent of human operators. Clough, et al. propose two promising approaches to autonomous UAV control: leader-follower and swarming [Clo03]. In the leader-follower technique, human operators control a large group of UAVs through the actions of a single “leader UAV.” Followers execute autonomous flight control relative to the leader. This technique works well for formations of UAVs performing missions on pre-planned flight paths, but prevents followers from reacting to environmental changes (e.g., the loss of the leader). Swarming invests each UAV with more autonomy and, therefore, more flexibility.

Bees, ants, other social insects and certain microscopic organisms inspired the idea of swarming in computer science. Through simple interactions, for example, ants can solve complex problems [BT00]. Figure 2 demonstrates how a swarm of ants solves the shortest path problem. When the obstacle in Figure 2(b) blocks the path to food shown in Figure 2(a), the swarm must find a new path to the food. As seen in Figure 2(c), the ants begin taking random paths around the obstacle. The ants drop pheromone trails as they travel the new paths, which strengthens as more ants follow the same path. All the random paths to food taken by foraging ants receive pheromone, but the shortest experiences the most traffic. More ants travel over the shortest path than any other path for any given time period since it takes less time to traverse. The higher traffic leads to more pheromone. Since pheromone concentration increases the probability an ant will travel a particular trail, more and more ants decide to take the shortest path. Eventually, all ants traveling to the same food choose

the same path as illustrated in Figure 2(d). In this way, ants can solve the shortest path problem.

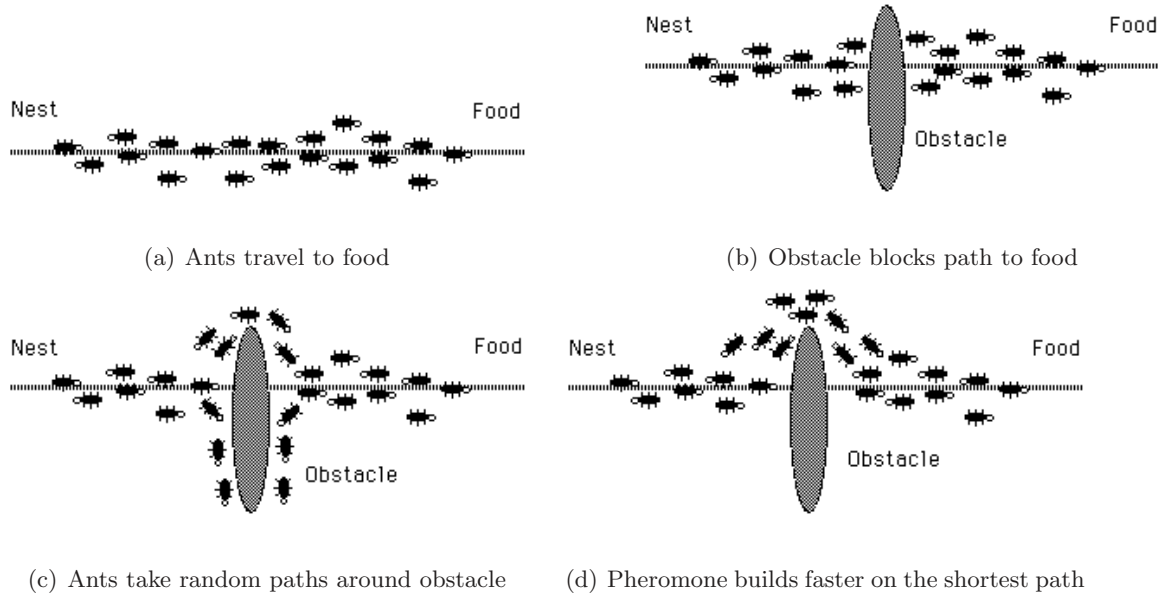

Figure 2: A swarm of ants computing the shortest path to food [Dor06]

Though some swarming algorithms specifically model ants, swarming in computer science has a more general definition:

Swarms consist of many simple entities that have local interactions, including interacting with the environment. The emergence of complex, or macroscopic, behaviors and the ability to achieve significant results as a team result from combining simple, or microscopic, behaviors. [HSR07]

Implementation of the microscopic behavior (“swarm logic”) from the definition often takes the form of a simple set of rules. Such simplicity keeps software development and maintenance costs down compared to other software-based autonomous control systems, and ease efforts to formally prove system behavior [Clo03].

Military policy also recognizes swarming as a likely candidate for autonomous UAV control. The Office of the Secretary of Defense (OSD), overall manager of UAV development

[RoF04], issued the *Unmanned Aircraft Systems Roadmap* in 2005 [OSD05]. This DoD-wide guidance for the “logical, systematic migration of [UAV] mission capabilities” estimates that the military could replace “a pilot with a mechanical facsimile of equal or superior thinking speed, memory capacity, and responses” by 2030 [OSD05]. Figure 3 shows the OSD’s projected trend for UAV autonomy through the year 2025, with autonomous swarms as the end state of UAV development.

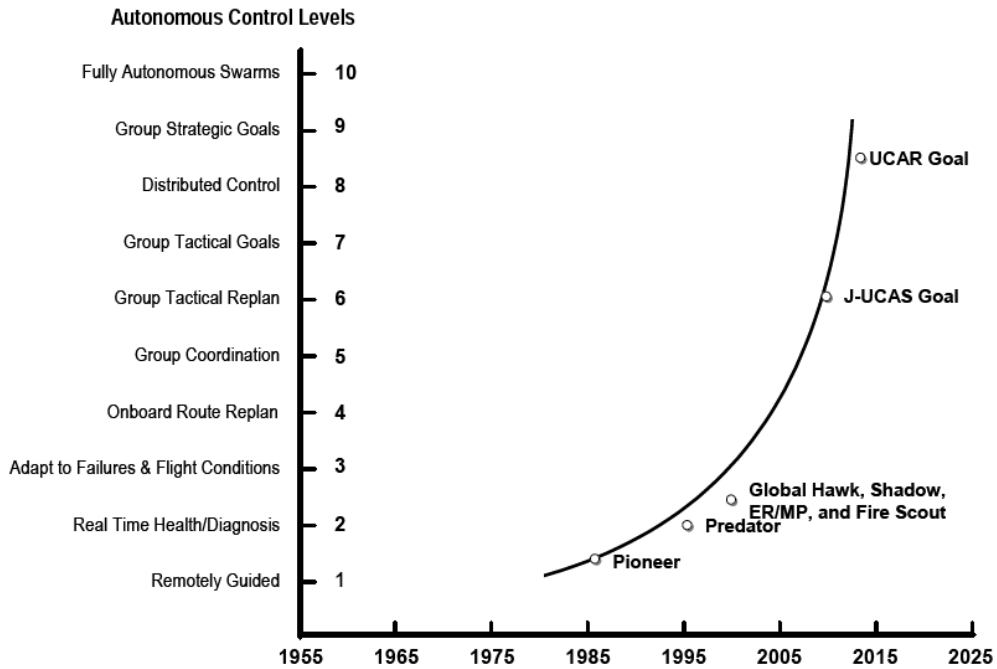

Figure 3: OSD’s projected trend in UAV autonomy through 2025 [OSD05]

## 2.5 Cooperative Robotic Search

This research builds on swarm logic that Pack and Mullins developed and tested for robots cooperating to search a 2-dimensional space [PaM03]. In [PaM03], robots select waypoints and travel to each one through a series of rectilinear moves. All robots travel at the same speed, and waypoint decisions occur serially. When a robot arrives at its waypoint,



it considers the space surrounding the waypoint (i.e., the “cell”) searched. Robots deconflict waypoint selections through a shared global state. A summary of the rules follows:

1. Distance Rule: Select the closest cell
2. Neighbor Rule: Select the cell farthest away from known neighbors
3. Travel Straight Rule: Select the next cell that requires the least direction change
4. Random Rule: Select a cell at random

When the robots consider cells in the search area for their next waypoint, they apply rules in order to the set of all cells. Each rule reduces the set of candidate cells until a single, best candidate remains or the Random Rule selects from a final set of equally good candidates. Pack and Mullins also incorporated an implied “Single Search” rule—no robot should search a previously searched cell, which increases the rule count to five.

These five rules produce an optimal search for two robots in certain control scenarios. The control scenarios comprise a square, 16-cell search area and place robots at opposite corners of the square. Further experimentation used the Random Rule as a base case and measured search performance as the Distance, Neighbor and Travel Straight Rules were added to the swarm logic in order. Each rule incrementally improved search performance. Chapter III covers search performance metrics.

The 5-rule swarm logic easily translates from ground robots to UAVs. Assuming a constant altitude above any terrestrial obstacles, UAVs on a search mission treat the search area as a 2-dimensional grid analogous to the search area grid in the robotic search experiments. If the UAVs can access a global search state as the robots did, then no limitation prevents them from executing the same swarm logic. In this study, only UAV-

local states exist, so communication between UAVs must provide the information needed to execute the swarm logic efficiently.

## ***2.6 Wireless Networks***

Just as manned aircraft use radios to coordinate missions, UAVs require wireless communication to coordinate swarm activity. The OSD lists at least 34 models of major-, mini- and micro-UAVs, and 22 corporations that manufacture or design UAVs [OSD05]. The OSD outlines the following investment strategy for UAV communication systems:

Rely on commercial markets (wireless communications, airliner links, finance) to drive link modulation methods technology. Focus DoD research on increasing the power of higher frequency (Ka) SCA waveform components and decrease size, weight, for [UAV] applications. [OSD05]

Corporations could develop separate communication systems for each UAV model, but the OSD strategy suggests that common communication standards and available commercial equipment would better serve interoperability and system cost.

The Institute of Electrical and Electronic Engineers (IEEE) governs a commercially popular family of standards for wireless networking that fits the OSD's communication spending strategy [IEE03]. The IEEE 802.11 family of standards defines how a radio transceiver encodes and decodes digital data, as well as how the encoded data is transformed into modulated wireless signals for a wireless data network. Since all communication in a single IEEE 802.11 network occurs in the same band of frequencies (or wireless channel), the standard also describes how network devices deconflict simultaneous communication attempts.

IEEE 802.11 wireless networks can operate in two modes: infrastructure mode and ad hoc mode. Infrastructure mode requires a central coordinator called an access point (AP). The AP relays communications between other devices on the same wireless network, controls timing and processes channel reservation requests, thereby deconflicting access to the wireless channel. When the AP operates reliably and remains stationary, infrastructure mode works well.

Infrastructure mode works poorly when the network itself moves to execute a mission, or the AP fails. A UAV swarm that communicates over an IEEE 802.11 network could use a ground-based AP for communication, but this approach tethers the swarm to the transmission range of the AP. Section 2.9 covers transmission range and other challenges when communicating with wireless signals. Alternatively, one of the UAVs could act as an AP during the mission, but this introduces a single point of failure as in leader-follower autonomous control. Since military missions subject aircraft to enemy attack, in-flight accidents and other forms of failure, an AP-enabled UAV (AP-UAV) would also experience higher rates of failure than commercial APs.

Adding an AP-UAV to the swarm introduces other undesirable effects to the search mission. Transmitting data in a wireless network expends energy. The AP-UAV would need more energy/fuel since it needs to communicate more often than other UAVs to deconflict the network's traffic. The capability of the AP-UAV would therefore limit the overall swarm size and mission length. Besides limiting mission scope, the AP-UAV's communication range constrains the distance between other UAVs in the swarm. This increases the effectiveness of enemy anti-aircraft attacks and increases the chance of mid-air collisions. UAV search missions require a more flexible network topology that eliminates single points of failure.

IEEE 802.11 wireless networks running in ad hoc mode offer more flexibility than infrastructure mode networks and eliminate single points of failure for the entire network. In traditional packet switched wired networks such as the Internet, network devices act as either host or router [SoK91]. Similarly, wireless devices in infrastructure networks act as hosts or APs, with APs often connected to a wired network of routers. Network devices in ad hoc networks act as both host and router. This dual role for each device leverages redundancy against the possibility of device failure. The dual nature of ad hoc networking also allows devices to route data through neighboring devices. As the data “hops” from device to device, the effective communication range of the network increases without increasing the physical transmission range of any particular device.

Multi-hop forwarding decisions at each device require a distributed routing algorithm that can discover network topology so that routes between communicating nodes can form. Mobile devices as described in Section 2.7 further complicate route discovery and maintenance by changing network topology.

Network research offers many different ad hoc routing protocols. Ad hoc routing protocols fit into one of three categories: proactive, reactive or hybrid [AWD04]. Proactive protocols discover and maintain routes between all devices in the network. Reactive devices discover routes as devices need them and only maintain routes that are in use. Hybrid protocols mix proactive and reactive characteristics. Sections 2.7 and 2.8 discuss the routing protocols related to this thesis.

## 2.7 *MANETs*

MANETs are wireless ad hoc networks with mobile devices. Aside from mobility, MANET research generally assumes the following additional conditions [Sun01]:

- Distributed operation. The control and routing operations are distributed among network devices.
- Multi-hop routing. Packets outside the range of one-hop communication are forwarded via intermediate nodes.
- Fluctuating link capacity. MANETs operate in the wireless domain. Atmospheric properties, competition from other sources of RF radiation and noise limit the capacity of a node to transmit information.
- Light-weight terminals. Since MANETs require mobility, nodes often run off battery power and conform to small form-factors that limit computing power.

MANETs represent a wide group of conceptual networks, including personal digital assistant (PDA) users walking around a city or groups of ground vehicles communicating to form an accurate battlefield picture.

UAV swarms communicating over a wireless ad hoc network also qualify as MANETs. Swarms are distributed by definition, and this study incorporates multi-hop routing into swarm communication. As an ad hoc network, a real swarm would experience signal interference as described in Section 2.9, which, in turn, causes link capacities to fluctuate. Finally, all the in-service mini-UAVs listed in Section 2.2 can be considered light weight computing platforms since they each operate from batteries with about 1 hour of life.

*2.7.1 The Study and Effect of Mobility on MANETs.* The mobility of devices in a network may be studied via mobility models. Mobility models imitate node mobility on real networks and come in two varieties: network traces and synthetic models. Network traces record mobility data from a real network which then replay it in network simulations. Network traces faithfully represent real-world conditions, but may be difficult to record and store depending on network size and the type of mobile entity carrying the network device. Synthetic mobility models mimic device mobility through stochastic processes [CBD02]. Simulation studies use synthetic mobility models to generate mobility data algorithmically without concern for storage or collection.

Two common synthetic mobility models are random walk and random waypoint. In random walk, network devices travel at random speeds and directions. The model accepts a device speed and time quantum which controls the amount of time between direction changes. Random waypoint forces devices to select a random waypoint within a predefined set of coordinates, then travel in a straight line to the waypoint and pause between direction changes. Random waypoint accepts a device speed and pause time. Simulation studies commonly use random waypoint models to simulate MANET behavior [CBD02].

The pattern of network devices' mobility can dominate MANET routing protocol performance. In fact, the performance of a single routing protocol varies widely across four different synthetic mobility models for end-to-end delay, packet overhead, average hop count and packet delivery ratio [CBD02]. Connectivity and link failure has been tested using real users [LWM06]. Researchers assigned PDAs with wireless ad hoc networking features to 20 people. The users worked in the same building, and the researchers instructed them to wear the wireless devices from the beginning of the workday until the PDA battery failed. The

PDAs exchanged and recorded receipt of periodic hello messages to gauge connectivity. The record of hello exchanges provided a history of network link breaks. While packet collisions dominated link breaks for short observation periods (5 minutes), user mobility caused the most link breaks for long observation periods (55 minutes) [LWM06]. This showed that mobility can dominate MANET routing protocol performance.

Secondly, synthetic mobility models used in simulation produce valid conclusions about the effect of mobility on wireless links. Using the random waypoint mobility model to mimic the average speed and pause time used by the human subjects, the empirical measurements and simulation studies' results showed no statistically significant difference between causes of link failure [LWM06]. Provided simulated speed and pause time approximately reflect real-world node attributes, this, combined with the work of Camp, et al. suggests, that the random waypoint mobility model accurately models MANET movement.

*2.7.2 Network Partitioning.* Network partitions occur when enough link breaks prevent communication between two or more subsets of devices on the same network. Network partitions degrade routing protocol performance by causing routes between the partitions to fail. MANET studies must control the probability of network partitioning to accurately measure performance of the system under test, otherwise, partitioning could unintentionally dominate routing performance.

If each device in an ad hoc wireless network can communicate with  $5.177 \log n$  neighbor devices, “the network is asymptotically connected with probability approaching one as  $n$  increases” where  $n$  is the number of devices in the network [XuK04]. The optimum transmission range is the minimum transmission range required for each device to average  $5.177 \log n$  neighbors over the network's lifetime. The optimum transmission range given

the number of devices and the network area for a uniform distribution of devices is

$$r \approx \sqrt{\frac{5.771 A \log n}{\pi n}} \quad (1)$$

where  $r$  is the ideal transmission range for a connected network,  $A$  is the physical network area (or area of the search mission), and  $n$  is the number of devices in the network [Hyl07]. This simple equation controls the probability of network partitions for experiments that can control transmission power (and, therefore, transmission range). The transmission power required to achieve the ideal transmission range differs depending on an experiment's wireless signal propagation model. Section 2.9 discusses common propagation models.

*2.7.3 Routing in a UAV Swarm.* Hyland examined the performance of proactive, reactive and hybrid (GPSR) ad hoc routing protocols under a random waypoint mobility model with typical mini-UAV swarm movement parameters [Hyl07]. The proactive and reactive protocols are considered representative of their respective protocol families. Data throughput, packet delay, and hop count were measured among other network performance metrics [CoM99].

The hybrid protocol, a geographic routing protocol called GPSR, outperformed the proactive and reactive protocols in simulation. Hyland concluded:

The results of over 4,000 computer simulations supports the hypothesis that a geographic routing protocol, specifically GPSR, is an efficient and effective routing protocol for a swarm of UAVs. Furthermore, when considering successful packet delivery ratio and end-to-end delay, GPSR outperforms [the reactive protocol] with an equivalent packet delivery ratio but a 53% shorter end-to-end delay. GPSR also outperforms [the proactive protocol] with a comparable end-to-end delay but with a 25% higher packet delivery ratio. [Hyl07]



The random waypoint mobility model used in the experiments is similar to the movement of the robots in the Pack and Mullins study. The UAVs and robots both select a waypoint and travel without pause to that waypoint. While the robots make fewer random decisions as they apply more rules, the random initial placement of robots randomizes the robots' search paths over many experiments and approximates the behavior of a random waypoint model. Therefore, the conclusions also apply to GPSR in studies where swarm logic controls UAV mobility.

### 2.8 Geographic Routing and GPSR

GPSR is a geographic routing protocol. Geographic routing protocols make routing decisions based on the physical topology (geography) of the network. They contain up to four parts as seen in Figure 4. The absolute positioning service provides a network device with its own absolute position, usually through hardware. Examples of positioning service hardware include Global Positioning System (GPS) receivers, tactical air navigation system receivers, and RF tag readers.

The absolute positioning service feeds the location service, through which network devices advertise their location and locate other network devices. The location service



Figure 4: The components of a geographic routing algorithm

depends on the positioning service for accurate information, so any error introduced by the positioning service propagates to the location service. When a sender needs a final receiver's location for geographic addressing, it queries the location service [MWH01].

The forwarding strategy decides which hops data takes through the network based on information from the location service. Common forwarding strategies include [MWH01]

- *Restricted Directional Flooding*: A sender calculates the region where it expects the receiver to be and forwards its data packet to all neighbor devices in the direction of the “expected region.”
- *Greedy Forwarding*: A sender and any intermediate hops forward data packets to neighbor devices successively closer to the intended receiver.
- *Hierarchical*: The forwarding strategy changes based on distance (hierarchy of distances) or device capability (hierarchy of devices).

Just as the location service depends on the positioning service, the forwarding strategy depends on the location service for accurate location information. Errors in the location service propagate to forwarding strategy decisions.

The routing protocol also requires a recovery strategy when its forwarding strategy fails to find an existent route. Greedy forwarding will fail to find an existent route when no neighbor device is positioned closer to the intended receiver. Figure 5 illustrates a situation where greedy forwarding fails to find an existent route. The sending device (S) cannot find another device within its transmission range (dashed circle) closer to the destination (D) than itself, so it drops the packet, though clearly a route to the destination exists through hops 1-5 (H1-H5).

As specified by Karp and Kung, devices track their neighbors' locations to make forwarding decisions [KaK00]. For network-wide location information, GPSR assumes perfect absolute positioning and location services. To track neighbor locations, each device sends and promiscuously listens for location beacons. Data packets routed by GPSR also carry

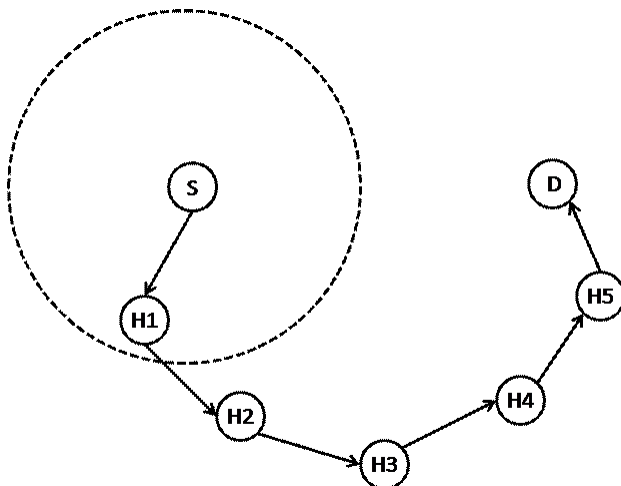

Figure 5: A situation where greedy forwarding fails to find a route

location information. From this information, GPSR builds a neighbor table of locations, device addresses and reception times. When forwarding data packets, a device consults its neighbor table and greedily selects the neighbor geographically closest to the final destination. If no neighbor is closer to the final destination than the current hop, the protocol forwards the packet in “perimeter mode.”

Perimeter mode, GPSR’s recovery strategy, builds a planar graph of the network’s topology. Edges in a planar graph do not cross, which allows GPSR to apply a graph theory principle called “the right hand rule” to forward perimeter mode packets along the graph’s edges [KaK00]. A fuller description of GPSR’s perimeter mode is omitted—this research does not evaluate the USMP and search mission performance when perimeter mode is enabled.

GPSR and other geographic routing protocols offer capabilities especially suited to the UAV search mission. First, devices can geographically address packets instead of using a specific device’s network address. In the search mission, for example, UAVs in a MANET using GPSR could forward waypoint reservations to their intended waypoint. UAVs posi-

tioned along the greedy route path could receive the reservation and respond if necessary. Furthermore, GPSR can greedily forward geographically addressed packets without a location service since decisions only require a neighbor table. Finally, a search mission could harvest the location data already used by geographic routing protocols for mission execution. Using GPSR beacon data to track the position of other nodes for the swarm logic could eliminate some of the control traffic explicitly generated by the search mission.

## 2.9 *Wireless Signal Properties*

*2.9.1 Interference.* MANETs benefit from the flexibility of wireless networks, but flexibility comes at the cost of undesirable properties of wireless signals. Excluding infrared versions, the wireless networks described in Section 2.6 use RF signals to transmit data. When a network device transmits, its signal is spatially distributed through the atmosphere according to the antenna’s properties. The transmitted signal can experience different forms of interference that introduce error into the received signal. For example, obstacles in the propagation path can reflect the signal back into the atmosphere, where the reflected, out-of-phase signal recombines with the original signal. Obstacles can also completely block the reception of RF signals. Other forms of interference include: electrical devices producing noise and other wireless devices outside the network transmitting at the same RF frequency.

*2.9.2 Path Loss, Propagation Models and Transmission Range.* Even supposing no interference, wireless signals attenuate (lose power) at a rate of one over the square of the distance traveled. This form of attenuation is called free-space path loss. In decibels (dB), path loss is

$$\text{path loss (dB)} = 32.5 + 20 \log F + 20 \log d \tag{2}$$

where  $F$  is the transmission frequency in gigahertz and  $d$  is the distance in meters [Gas05].

Wireless networking simulation experiments must account for interference and attenuation. The simplest model is the free-space path loss model, which uses (2) to calculate attenuation assuming no interference. Other propagation models for more complex forms of attenuation and interference include the Raleigh fading channel model and the Weibull model [SJK<sup>+</sup>03].

Transmission power, receiver sensitivity, antenna properties, path loss and interference determine a network device's transmission range. When experiments assume free-space path loss and omnidirectional antennas with 0 dB gain, the power in decibel milliwatts (dBm) a device requires to transmit a specific range is

$$\text{transmit power}(dBm) = \text{path loss}(dB) + \text{receiver sensitivity}(dBm) \quad (3)$$

where path loss is calculated using (2), and receiver sensitivity is always expressed in negative dBm.

*2.9.3 Wireless Collisions.* When two or more devices on a wireless network transmit simultaneously, a collision occurs, causing data loss. Media Access Control (MAC) protocols attempt to deconflict access to the wireless channel, thereby preventing or recovering from collisions. The MAC protocol defined by the IEEE 802.11 standard allows wireless channel reservations and contention-based service where devices can sense the channel is free and transmit. A busy channel or a collision causes the device to wait an algorithmically-determined back-off time before retransmitting [Gas05].

MAC protocols that use timing to control channel access make assumptions about transmission range (and therefore transmission power) to account for the wireless signal's propagation delay. Experiments that vary transmission power should adjust MAC protocol parameters to account for the new range of propagation delay values. The relevant timing parameters in IEEE 802.11 ad hoc networks are [Gas05]:

- *Short Interframe Space (SIFS)*: The time a device must wait to send high priority transmission after it detects a clear channel.
- *Distributed Coordination Function Interframe Space (DIFS)*: The time a device must wait to send a normal priority transmission after it detects a clear channel.

### **2.10 Simulation**

Mathematical analysis, empirical measurement or simulation can determine system performance [Gra07]. Analysis builds a mathematical model of real-world phenomena. Analysis draws on existing theory, such as graph theory for network analysis. While analysis by mathematical model costs less than simulation or measurement, the resulting accuracy falls short of other methods. Conversely, empirical measurement examines the performance of a real system. This produces the most accurate results (if measurement of the system is possible), but incurs the cost of building a real system. For systems in development, measurement may be impractical. Simulation is a compromise between the benefit of mathematical models and the accuracy of empirical measurement. In simulation, software models the operation of a real system. Software cannot account for all real-world conditions, but offers far more control over system parameters than other evaluation techniques. Table 2 summarizes the three performance analysis techniques.

Table 2: A comparison of performance analysis techniques [Gra07]

<b>Criterion</b>	<b>Analytical</b>	<b>Simulation</b>	<b>Measurement</b>
Development Stage	Any	Any	Post-prototype
Time required	Small	Medium	Varies
Accuracy	Low	Moderate	Varies
Trade-off Evaluation	Easy	Moderate	Difficult
Cost	Low	Medium	High
“Saleability”	Low	Medium	High

Popular network simulation tools include ns2 [Inf08] and OPNET Modeler [OPN08].

This and significant related research covered in Section 2.11 use Modeler to examine UAV swarms that communicate over IEEE 802.11b wireless networks. OPNET offers standard models for wireless networks, which the corporation and customer base validate through an active bug reporting process. Use of these standard models allows research to incorporate network components the system under test depends on.

### *2.11 Related Research*

Pack and Mullins developed a set of swarm logic rules for robots searching a 2-dimensional area [PaM03]. Their experiment assumed perfect communication between robots, including deconfliction of waypoints selected by the robots. This research implements a set of swarm logic rules updated from Pack and Mullins’ rules and validates the set’s implementation against results from the original study. A simulated swarm of mini-UAVs execute a search mission with the updated rule set. This research also develops a protocol to resolve waypoint selection conflicts under realistic communication conditions.

Morris studied the robotic swarm logic under realistic communication conditions as part of a larger targeting system [Mor06]. He implemented an equation version of the rule set (first suggested by [PYT05]) which has not been shown to be equivalent. This study’s

UAVs apply the rules sequentially to all cells in the search area to prevent the equation from introducing unexpected swarm behavior. Morris developed a search mission protocol which advertised a UAV's next waypoint by simple broadcast (i.e., no routing), and concluded that "communication between nodes has little effect, which may indicate the items communicated are of little benefit to the search algorithm" [Mor06]. This research combines a MANET geographic routing protocol with a new search mission protocol designed to improve swarm search performance as defined in Chapter III.

Hyland studied GPSR, the routing protocol used in this study. He compared performance of MANET routing protocols in a swarm of UAVs using the random waypoint mobility model for network densities unlikely to experience partitions, and concluded that GPSR outperforms popular reactive and proactive protocols for a system similar to the system under test in this research [Hyl07]. Instead of a swarm algorithm, Hyland used a synthetic mobility model [Hyl07]. This study combines the swarm algorithm with GPSR, modifies GPSR to accept geographic addresses from the swarm algorithm and incorporates this feature into the new USMP.

### ***2.12 Summary***

This chapter introduced UAVs, their missions and categories. Next, sensors were defined. Autonomous control of UAVs, including swarming, was described along with swarm logic for UAVs performing a search mission. Swarming UAVs require a wireless network to communicate effectively, and when UAVs become devices in a wireless ad hoc network, the swarm qualifies as a MANET. GPSR was shown to work well in a MANET composed of UAVs. Next, the wireless signal properties that affect MANET studies were summarized,



and simulation was defined and compared to other performance evaluation techniques. Finally, related research efforts were presented. The next chapter describes how related research is combined to create a system of searching UAVs, how a communications protocol is developed for the system and how both the system and protocol are tested.

## III. Methodology

### 3.1 Overview

This chapter defines research methodology. Section 3.2 defines the problem, presents research goals and poses several hypotheses about the expected outcome of experiments. Section 3.3 describes the design approach for USMP and how USMP is combined with GPSR and swarm logic to form the UAV Search System. Section 3.3 also introduces performance evaluation and validation techniques. Section 3.4 defines the UAV Search System's boundaries. Section 3.5 outlines the system services. Section 3.6 describes system workload, how it is adjusted and how the selected workload compares to workloads in previous research. Section 3.7 identifies metrics used to measure search mission performance and introduces a new metric, Search Redundancy Concentration, to measure search spread. Section 3.8 outlines system parameters which could affect system performance when varied. Section 3.9 defines all parameters that affect system workload. Section 3.10 selects the workload and system parameters (factors) to vary during experimentation. Section 3.10 also lists the levels associated with each experimental factor. Section 3.11 covers the performance evaluation technique (simulation), and Section 3.12 lays out the experimental design. Finally, Section 3.13 summarizes the chapter.

### 3.2 Problem Definition, Goals and Hypothesis

The swarm logic developed in [PaM03] directs a swarm of searching robots under ideal communication conditions, but a swarm of UAVs executing a real search mission would not encounter ideal conditions [PaM03]. The robots share a global search state, but the UAV swarm needs a communication protocol to convey the same information within each device's

local state. The goal of this research is to develop USMP for swarming UAVs and determine the effect of the protocol on search mission performance.

A previously developed protocol had no significant effect on search performance [Mor06]. That protocol advertised UAV waypoint selections, but communicated with simple broadcasts so only neighboring UAVs received the data. It is hypothesized that designing USMP to leverage geographic routing features will improve search performance by providing geography-dependent data to locations where it impacts search decisions. The swarm can also use the data collected by the geographic routing protocol to accurately determine UAV locations and avoid sending explicit location updates.

### ***3.3 Approach***

USMP conveys the same information as the robots in [PaM03]. The robots share a perfect global search state, which includes the location of all other robots, the search status of all cells in the search area and all robots' waypoint selections. USMP includes two features that provide similar state information within each UAV: Location Update and Waypoint Conflict Resolution. A proposed design that leverages geographic routing features is produced for each USMP feature, and an alternative without geographic routing features is used for comparison.

The Location Update feature propagates neighbor UAV location information to the swarm. UAVs use these Location Update messages to build a local search state for making waypoint decisions. UAVs also use the location information to determine if the Location Update message provider has searched the cell from which the message was sent.

Two candidate designs for the USMP Location Update feature are implemented. The first design generates Location Update messages explicitly, and the second design harvests GPSR’s location information (aka, GPSR harvesting). With explicit updates enabled, UAVs generate updates every second and upon waypoint arrivals. Since Location Update provides data on neighboring UAVs, Location Update data is considered geographically dependent on the sender’s current location. Therefore explicit Location Update messages are simply broadcast to neighboring UAVs. GPSR beacons are broadcast to neighboring devices at one second intervals by default. When GPSR harvesting is enabled, USMP receives a location update each time GPSR receives a packet since GPSR appends location information to data packets as well as creating location beacons [KaK00].

Waypoint Conflict Resolution resolves waypoint selection conflicts between UAVs. Since the robotic search made waypoint decisions serially [PaM03], no robot ever selected another robot’s waypoint and there was no need to resolve conflicts. UAVs select waypoints simultaneously and may lack information about other UAVs’ selections. If two or more UAVs select the same waypoint, a conflict occurs. USMP discovers conflicts by sending and processing waypoint reservation messages which contain the sender’s rank (a unique integer rank, or “id”, assigned to each UAV before the search mission begins), an estimated waypoint arrival time and the coordinates of the waypoint.

Figure 6 illustrates the Waypoint Conflict Resolution process and shows when reservation messages are generated. Waypoint reservations are generated when a UAV selects a new waypoint or when a UAV wins a waypoint conflict. Once a UAV receives a waypoint reservation, it determines if its waypoint is the same as the waypoint advertised in the reservation. If the waypoints are equal, a conflict is detected (i.e., “Same Waypoint”

decision in Figure 6). Conflicts are resolved at the receiving UAV. Regardless of how the receiver resolves the conflict (“Conflict Winner” decision in the figure), a conflict loser selects a new waypoint (“Select Waypoint” event) without responding directly to the conflict winner. The winner sends a reservation message addressed to the conflict loser (“Generate Reservation Addressed to Reservations Return Network Address” event). If received, the conflict winner’s reservation is processed by the conflict loser like any other reservation. The loser is unaware it has lost the resolution process until it receives the winner’s reservation and processes it, starting at the “Receive Reservation” event in Figure 6.

Waypoint conflicts could occur between any set of two or more UAVs in the network, but the UAV Search System’s swarm logic alters the probability a UAV will experience conflicts. Since the swarm logic prioritizes distance in waypoint selections, a new waypoint selection is more likely to conflict with waypoint selections by UAVs closer to the intended waypoint. Therefore, Waypoint Conflict Resolution data is considered geographically-dependent on the area between the waypoint reservation sender and the intended waypoint.

Waypoint Conflict Resolution data’s geographic dependency is exploited in both routing waypoint reservations and the rules used to process received reservations. USMP exploits routing by greedily forwarding reservation messages to the geographic address of the advertised waypoint. UAVs promiscuously listen for and process any available USMP reservations. Thus, UAVs positioned directly between the sender and the sender’s intended waypoint receive and process the sender’s reservation. Alternative designs that simply broadcast waypoint reservations to neighbors are used for comparison.

USMP also exploits waypoint conflict resolution rules by resolving conflicts in favor of UAVs closer to the waypoint. This resolution technique is called the Estimated Arrival

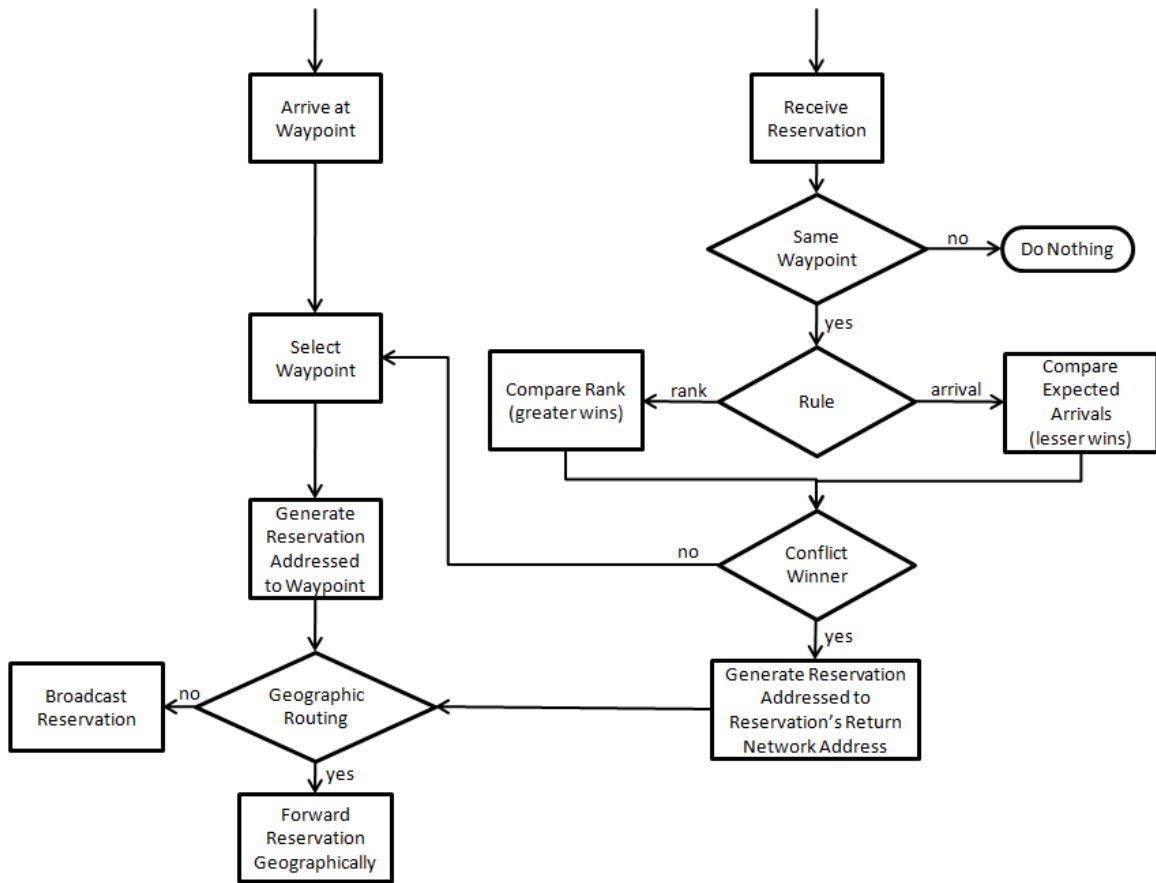

Figure 6: Waypoint Conflict Resolution Process

Rule. The Estimated Arrival Rule compares the estimated arrival time advertised by a received waypoint reservation to the receiver’s calculated estimate of waypoint arrival time. If the receiver’s expected arrival is sooner than the advertised arrival, it wins the conflict. Otherwise, the receiver loses the conflict.

For comparison, an alternative rule is designed without geographic dependencies. The Rank Rule resolves waypoint conflicts based on a unique integer rank assigned to UAVs before the search mission. If the rank of the receiving UAV is higher than the rank advertised in the reservation, the receiving UAV wins the conflict. Otherwise, the receiver loses.

Combining the routing and conflict resolution rule designs produces four candidate Waypoint Conflict Resolution designs: Arrival Broadcast, Arrival Geographic, Rank Broadcast and Rank Geographic. In all designs, waypoint reservation messages also serve as location updates by advertising the sender’s location information.

Finally, USMP, Hyland’s GPSR implementation in OPNET Modeler, Pack and Mullins’ swarm logic and standard OPNET simulation models are combined to create a swarm of searching UAVs capable of geographic routing as a MANET [Hyl07] [PaM03]. For swarm logic validation, a simulation that reproduces the assumptions of Pack and Mullins’ robot experiment is created as described in Chapter II. Each UAV in the simulation executes the swarm logic, and metrics are compared to the robot experiment. Candidate USMP feature designs are implemented in Modeler as part of the simulated UAV swarm. Comparative simulation experiments with the various Location Update and Waypoint Conflict Resolution designs are run, as well as scenarios where Location Update and Waypoint Conflict Resolution are disabled. Metrics collected from the simulated system are statistically analyzed to determine the effect of each feature design on search mission performance.

### 3.4 System Boundaries

The system under test is the UAV Search System, a swarm of UAVs that search a fixed 2-dimensional area (search area) while communicating over a wireless ad hoc network. Of primary interest is USMP and how it affects search performance. The system under test includes the swarm of UAVs, the set of swarm logic rules, GPSR, the wireless network and USMP. Figure 7 illustrates the UAV Search System.

The component under test is the set of various USMP designs, wireless transmission power levels and sensor types. The system under test does not include targets or any non-swarm aircraft. The UAVs in the system are typical in-service mini-UAVs as defined in Chapter II. Additionally, speed and flight endurance are the only UAV flight characteristics considered since they directly limit search performance.

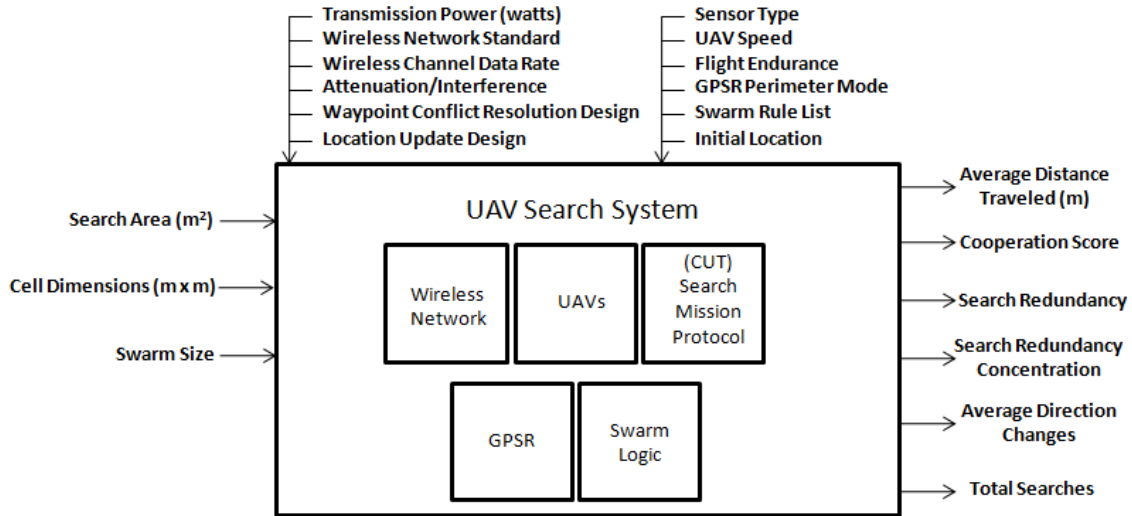

Figure 7: UAV Search System

The UAV Search System includes several assumptions to limit complexity. The system is limited to a fixed square-shaped search area of  $1 \text{ km}^2$ . UAVs may not leave the search



area, and new UAVs may not enter. The system operates for up to the flight endurance of a typical mini-UAV (approximately 1 hour). All nodes fly for the full period of flight endurance or until the search completes. No other form of failure is modeled in the system. The search area is assumed to be free of obstacles, and UAVs never collide (i.e., the system allows multiple UAVs to occupy the same physical space). All UAVs fly at the same altitude and speed, and direction changes occur instantaneously. Between direction changes, a UAV travels in a straight line toward its waypoint.

### ***3.5 System Services***

The system provides one service; it searches a fixed area with a swarm of UAVs. The following service outcomes are possible:

- The system searches a cell once
- The system searches a cell more than once

### ***3.6 Workload***

In a fixed size search area, sensor capability and number of sensors determine the system workload. Chapter II showed that sensor capability can be modeled as the search cell dimensions. Thus, adjusting the search area's cell dimensions determines a sensor's scan radius. If the sensors are less capable, more cells must be searched for the same area. Conversely, as more sensors are added, more cells can be searched per time quantum thus reducing workload. Increasing the UAV swarm size is the only way to add sensors to the system under test. Therefore system workload is expressed in terms of the ratio between cell count and swarm size.

The original experimental design scaled the search area (cell count) and swarm size by one fourth compared to the swarm sizes and search areas used in [Hyl07] and [Mor06] to reduce simulation time while preserving workload. [Hyl07] and [Mor06] used swarm sizes ranging from 50 to 300, and generally incremented swarm size by 50 between factor levels. Both used a search area of  $100 \text{ km}^2$ . The scaled swarm sizes are rounded up so the scaled range runs from 13 to 75, and the scaled search area is  $25 \text{ km}^2$ . A pilot study found this configuration incompatible with the speed and flight endurance characteristics of the typical mini-UAV. For scaled swarm size sizes 13, 25 and 38 UAVs, a majority of simulated swarms failed to complete the search mission within 1 simulation hour. For scaled swarm sizes of 38, 50 and 75 UAVs, simulation time was excessive, and the majority of simulation runs aborted due to memory limitations. Scaling swarm size by one fourth and scaling cell count by one one-hundredth, however, allows all simulations to complete within 1 simulation hour without memory issues. Therefore, the experimental design adopts this scaling, which reduces the workload compared to related research. The  $50 \text{ m} \times 50 \text{ m}$  cell dimensions used in Morris' experiment is retained.

This research keeps a constant cell count (400 cells) and search area ( $1 \text{ km}^2$ ) for all experiments. Thus, workload is expressed in terms of swarm size alone. Varying swarm size creates three workload levels:

- 13 UAVs
- 25 UAVs
- 38 UAVs

### 3.7 Metrics

The following metrics gauge the search mission performance for each experiment.

**Total Searches** Total Searches is the sum of searches performed by UAVs during the search mission. Lower values for Total Searches are better, and the best achievable score is equal to the cell count since the search completes after each cell is searched once.

**Average Distance Traveled** Average Distance Traveled is the sum of Euclidean distances in meters traveled by all UAVs divided by the swarm size. The UAVs move constantly until the simulation completes. Since UAVs also travel at the same constant speed, Average Distance Traveled is isomorphic to search time. Therefore, Average Distance Traveled is  $D_{average} = t_{sim\ end} \cdot S_{uav}$  where  $t_{sim\ end}$  is the final simulation time in seconds and  $S_{uav}$  is UAV speed in  $m/s$ . Lower values for Average Distance Traveled indicate more efficient search performance.

**Average Direction Changes** Average Direction Changes measures the number of direction changes a UAV makes during a search mission. Changing direction expends more energy than flying straight, and UAVs need to conserve their limited power supply. This metric is calculated by dividing the total number of UAV direction changes by the swarm size. A lower Average Direction Changes indicates a more efficient search.

While changing directions during flight consumes energy, the energy is still consumed in propelling the UAV. Total Searches and Average Distance Traveled relate directly to the energy used to move UAVs through space. Therefore, Total Searches and Average Distance Traveled are more dominant measures of search performance than Average Direction Changes.

**Cooperation Score** Cooperation Score [PaM03] measures of how well UAVs cooperate.

The Cooperation Score can be used to compare experimental results regardless of the number of robots in each experiment. The Cooperation Score is

$$cooperation\ score = \frac{1}{n} \left| \sum_{i=1}^n D_{ideal}^i - D_{actual}^i \right| \quad (4)$$

where  $D_{ideal}^i$  is the distance the  $i^{th}$  UAV would travel in an optimal search,  $D_{actual}^i$  is the actual distance traveled by the  $i^{th}$  UAV, and  $n$  is swarm size [PaM03]. Lower values indicate a higher level of cooperation, and thus, a more efficient search. Optimal searches receive a Cooperation Score of zero.

**Search Redundancy** Search Redundancy is the mean number of searches over all cells.

Search Redundancy measures how many unnecessary searches take place [Mor06].

In an optimal search, the swarm searches each cell once, so anything above one is redundant. Search Redundancy is the number of searches divided by the cell count.

Lower values indicate more efficient search performance. The best achievable value is one.

**Search Redundancy Concentration** Search Redundancy Concentration measures how

evenly the UAV swarm distributes redundant searches. Concentration of searches into a few cells indicates the swarm is neglecting the rest of the search area. The number of searches for each cell is sorted from lowest to highest, split in half, and each half is summed. The absolute difference between the two sums is divided by the cell count to produce the Search Redundancy Concentration.

Sorting the number of searches for each cell and splitting the list allows a comparison between the most-searched cells and the least-searched cells. The difference between the upper and lower sums describes the disparity between most- and least-searched cells. Finally, dividing this difference by the cell count computes a ratio, which can be compared to Search Redundancy Concentrations from experiments with different cell counts. Since less disparity indicate a more evenly spread-out search, lower values of Search Redundancy Concentration indicate a more efficient search.

### **3.8 System Parameters**

**Transmission Power** Transmission Power determines the transmission range of UAVs. In turn, transmission range determines how many UAVs can receive a transmitted packet, which controls USMP's effect on the search mission. Lowering transmission power reduces transmission range which increases the probability of network partitions and degrades GPSR's ability to route USMP packets. For transmission range calculations, wireless propagation patterns are assumed to be isotropic.

**Wireless Network Standard** As discussed in Chapter II, a wireless networking standard includes a MAC protocol and defines how data is transformed into and recovered from wireless signals. Recall that MAC protocols deconflict access to the wireless channel. If the MAC performs poorly, resulting in frequent collisions or limited channel access, UAVs are not able to send USMP messages. IEEE 802.11b is selected as a wireless network standard since it is compatible with the OSD's UAV spending policy described in Section 2.6. Morris and Hyland also used IEEE 802.11b, which excludes

the possibility that differences in GPSR and the swarm logic efficiency are due to a difference in wireless networking standards.

**Wireless Channel Data Rate** The data rate defines how much data in bits/second can be transmitted across the wireless network. If the load on the network exceeds the wireless channel's aggregate data rate, packets are delayed or dropped. Dropping or delaying USMP packets degrades the search system's performance by preventing delivery of time sensitive information. The data rate is set to the highest allowed by the IEEE 802.11b networking standard. The IEEE 802.11b standard is based on Direct Sequence Spread Spectrum modulation and has a maximum data rate of 11 Mbps. Since the network carries no other traffic, the data rate far exceeds the expected demand of USMP. This minimizes the possibility of dropped or delayed packets due to network overload.

**Attenuation and Interference Conditions** These conditions define the level and types of attenuation and interference present in the wireless network. Attenuation and interference reduce the transmission range and reliability of wireless links. The system under test experiences no interference, and only free-space path loss contributes to signal attenuation.

**Waypoint Conflict Resolution** The Waypoint Conflict Resolution feature determines how USMP resolves a waypoint conflict. UAVs send out waypoint reservation messages to deconflict waypoint selections. Design choices include various conflict resolution rules that are applied when a UAV receives a waypoint reservation from another UAV. The design also includes how the reservations are routed. Resolving waypoint conflicts

reduces the amount of redundant searching by preventing UAVs from simultaneously traveling to the same waypoint.

**Location Update** The USMP Location Update feature defines how location information about other UAVs is distributed. UAVs know their own location, but must communicate with the swarm to discover the position of other UAVs. The accuracy and frequency of location updates determine whether UAVs can correctly evaluate the Neighbor Rule, and whether UAVs successfully advertise cell searches to the swarm. While GPSR and explicit Location Update messages both provide location information, GPSR approximates the reported location so the same range of values apply to different network areas [KaK00]. For example, Hyland’s GPSR implementation only recognizes  $2^{32}$  discrete coordinates regardless of the network’s physical dimensions [Hyl07]. Real points are approximated to the closest GPSR coordinate. This approximation could degrade search performance.

**Sensor Type** Sensor Type determines whether the sensors used by the system are active or passive. As described in Section 2.3, a passive sensor implies all cells through which a UAV passes may be searched, while an active sensor is used selectively for searching waypoint cells only.

**UAV Speed** Speed determines how much time it takes a UAV to travel between adjacent cells. The speed of all UAVs in the system is  $25\text{ m/s}$ , a value comparable to the typical mini-UAV described in Chapter II.

**Flight Endurance** Flight Endurance, or the flight endurance period, is the time a UAV can continuously fly before refueling or recharging. UAV Speed and Flight Endurance

determine whether the system will complete its search. The typical in-service mini-UAV offers 1 hour of continuous flight.

**Set of Swarm Logic Rules** These are rules that determine the swarm's complex behavior. This research modifies Pack and Mullins' robot swarm logic slightly. The logic each UAV applies to the system is:

1. Number of Searches Rule: Select the cell with the least known number of searches
2. Distance Rule: Select the closest cell, excluding the current cell
3. Neighbor Rule: Select the cell farthest away from all known neighbors
4. Travel Straight Rule: Select the cell that requires the least change to the current flight bearing when plotting a new course to that cell
5. Random Rule: Select a random cell

When experiments terminate on search completion, the Number of Searches Rule produces the same effect as the Single Search Rule from Section 2.5. A UAV applying the Single Search Rule selects a cell it believes to be unsearched over other cells. Likewise, UAVs applying the Number of Searches Rule select cells with zero searches over any other cell. If the search mission continues beyond searching each cell once, the Number of Searches Rule more evenly distributes cell searches than the Single Search Rule. An evenly distributed search pattern is considered more desirable in cases where real swarms need to constantly survey the search area.

**GPSR Perimeter Mode** GPSR Perimeter Mode determines whether perimeter mode is enabled or not. Geographically addressed USMP packets that reach the node closest to the geographic address should be dropped, since the purpose of geographic



addressing is to contact devices close to the geographic address. Normally, GPSR enables perimeter mode when greedy forwarding fails. When perimeter mode is enabled, however, GPSR forwards geographically addressed packets around the network even after the packet reaches the node closest to the geographic address and should be dropped. Therefore perimeter mode is disabled.

**Initial Location** Initial Location is where the UAVs are positioned at the beginning of a simulation. UAVs located closer to each other perform more work to search the same area than UAVs uniformly distributed across the search area, since the Neighbor Rule has a stronger effect on clustered UAVs. UAVs in this study are always initially placed in the search area according to a random uniform distribution. The random number generator that determines the distribution is seeded with the integer values 170-179.

### **3.9 Workload Parameters**

**Swarm Size (SS)** Swarm Size is how many UAVs are taking part in the search. Increasing Swarm Size reduces the number of cells each UAV needs to search. The abbreviation for Swarm Size is used in the ANOVA model tables presented in Chapter IV.

**Search Area** Given fixed cell dimensions, search area size determines cell count. Search area is fixed at  $1\text{ km} \times 1\text{ km}$ .

**Cell Length and Width** Cell length and width determine the number of cells that can fit inside a fixed search area. Cell dimensions reflect the length and width used in Morris' study ( $50\text{ m} \times 50\text{ m}$ ). How cell dimensions affect workload is described in Section 3.6. A UAV's sensor is considered capable of scanning a cell when it enters the cell's center quarter as seen in Figure 8.

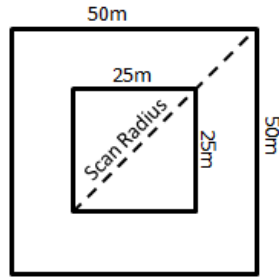

Figure 8: The center quarter cell search criterion [Mor06]

### 3.10 Factors

Factors are the system parameters adjusted during experimentation. Factor abbreviations are used in the ANOVA model tables presented in Chapter IV.

**Waypoint Conflict Resolution (WR)** The factor levels for Waypoint Conflict Resolution are:

- Disabled. No resolution (no waypoint reservations sent)
- Arrival Broadcast. Use the Expected Arrival Rule and broadcast messages without routing
- Arrival Geographic. Use the Expected Arrival Rule and route messages geographically
- Rank Broadcast. Use the Rank Rule and broadcast messages without routing
- Rank Geographic. Use the Rank Rule and route messages geographically

The factor levels in Waypoint Conflict Resolution are referred to as “Waypoint Conflict Resolution designs.”

**Location Updates (LU)** The factor levels for Location Update are:

- Disabled. Disable location updates (No messages sent, and no information harvested from GPSR)
- Explicit. Generate explicit Location Update messages
- Harvest. Harvest GPSR location data

Factor levels in Location Update are also called “Location Update designs.”

**Transmission Power** While this study uses transmission range as a measure of network connectedness, transmission range cannot be controlled as a factor directly. When receiver sensitivity and antenna properties are constant, varying Transmission Power is the only method of adjusting transmission range. The factor levels for Transmission Power are determined by how much power is required to transmit at the following ranges for each swarm size:

- 75% optimal transmission range
- Optimal transmission range
- Full network range

Optimal range is defined by (1) from Chapter II. UAVs transmitting at full network range communicate directly with any other UAV in the search area. Transmission Power calculations combine (1), (2), (3) and  $power_{mW} = (10^{power_{dBm}/10})$  to find Transmission Power in milliwatts or

$$transmission\ power_{mW} = 10^{(32.5 + 20 \log F + 20 \log \{ \sqrt{\frac{5.771 A \log n}{\pi n}} \} + -90\ dBm) / 10} \quad (5)$$

where  $A$  is the search area in  $m^2$ ,  $n$  is Swarm Size and  $F$  is 2.46 Ghz, the IEEE 802.11b center frequency. Under the assumptions of constant search area and frequency, Transmission Power reduces to

$$transmission\ power_{mW} = 10^{(-49.681\ dBm + 20 \log \{ \sqrt{\frac{5.771 A \log n}{\pi n}} \}) / 10}. \quad (6)$$

The power required for the full network range is calculated by substituting the farthest distance any two UAVs could be from each other in place of optimum transmission range formula in (6). The farthest distance is equal to the length of the diagonal line connecting any two non-adjacent corners of the search area as shown in Figure 9.

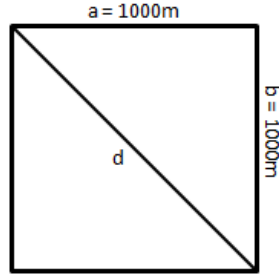

Figure 9: Calculation the minimum full network transmission range

The distance of this line,  $d$ , is calculated using the Pythagorean theorem or  $d = \sqrt{(1000\ m)^2 + (1000\ m)^2} \approx 1414.214\ m$ . Table 3 summarizes the examined transmission ranges and powers for each swarm size.

Table 3: Transmission ranges and their associated transmit power

Swarm Size	Factor Level	Transmission Range (m)	Transmit Power (mW)
13	75%	281.829	0.855
13	100%	375.772	1.520
25	75%	227.667	0.558
25	100%	303.556	0.992
38	75%	196.305	0.415
38	100%	261.741	0.737
All	Full Network	1414.214	21.524

**Sensor Type (Ssr)** Sensor type determines whether a UAV is always searching, or only searching waypoints. The factor levels for Sensor Type are:

- Active sensor
- Passive sensor

**Initial Location (IL)** Initial Location is randomized at the beginning of each scenario according to the scenario's random seed. Ten random seeds are supplied (170-179), so each Swarm Size level has 10 different Initial Location levels.

### ***3.11 Evaluation Technique***

The performance of the UAV Search System is evaluated using simulation. Few UAV swarms on the scale examined here exist, so direct measurement of the system is not possible. Additionally, no tractable mathematical models for a swarm of searching UAVs communicating as a MANET are known to exist. Therefore simulation is the only viable option.

Previous work simulated networks in OPNET Modeler [Hyl07] [Mor06]. This work expands on that research and uses their OPNET models, as well as new swarm logic and USMP implementations. Each USMP feature design is validated by stepping through a scaled down simulation in debug mode, viewing UAV mobility as an animation and verifying local search states are correct after each feature executes. Furthermore, the Pack and Mullins' robot experiments are executed on the updated OPNET models and checked for accuracy against previously reported results [PaM03].

### ***3.12 Experimental Design***

A full factorial simulation experiment in OPNET Modeler 12.0 for all factors and their levels is performed. The UAV Search System is contained within a subnet whose span is the previously defined  $1\text{ km} \times 1\text{ km}$  search area. Simulations run until search completion or 1 simulation hour, which is the flight endurance for a typical mini-UAV. At the beginning of each simulation, UAVs are placed in uniformly random locations across the search area. UAVs begin searching immediately after placement, but search protocol traffic starts after 10 seconds of simulation time. A pilot study demonstrated that GPSR needs at least 10 seconds to initialize and exchange location beacons before it can route packets. Ten repetitions of each simulation are performed with random number generator seeds of 170 through 179 to randomize initial UAV placement and Random Rule cell selections.

The UAV node model modifies the standard *manet\_station\_adv* OPNET node model by adding UAV swarm logic and USMP process models. The GPSR process model, *gpsr\_rte*, is registered as a child process of the new UAV node model's *ip* process, which makes it selectable as a routing protocol in the MANET. The process that executes the swarm logic

and generates USMP messages is *uav\_search* which checks its parent UAV's location in the subnet every 0.1 seconds to determine if the UAV's location constitutes a cell search and whether the UAV has arrived at its waypoint. A UAV arrives at a waypoint if it is less than or equal to a threshold of  $t_w$  meters away from a waypoint, where  $t_w = [UAV\ speed_{m/s} \cdot location\ check\ interval_s + 0.1\ s]$ . Scheduled location checks are necessary since OPNET does not calculate mobile node positions until the simulation kernel needs them. The same threshold determines if any two distance values are approximately the same, including when UAVs apply the Distance Rule. This prevents small distances ( $< 2.5\ m$ ) from unfairly biasing the swarm's search decisions.

Cell searches occur when *uav\_search* detects a parent UAV has entered the center quarter of a new cell. *uav\_search* updates the UAV's local search state by incrementing its private count of the cell's number of searches by one. *uav\_search* then notifies the *search\_observer* process, which is globally available to all instances of *uav\_search*. The *search\_observer* records the search in a global search state which always reflects accurate information concerning the search, whereas local search states may be incorrect or incomplete. Validation simulations use the global search state to make swarm decisions when perfect communication between UAVs is assumed. During the main experiment, the *search\_observer* process uses the global search state to calculate statistics about the simulation. The *search\_observer* process also uses the global search state to determine search completion.

Finally, OPNET accommodates collection and reporting of the search performance statistics through its default graphical interface. Custom statistics for search performance are exported to a text file at the end of each simulation for analysis in the Minitab sta-

tistical analysis software package. Appendix A covers full implementation details of the simulated system, and Appendix B describes important OPNET “lessons learned” during implementation, including tips on metric collection.

### 3.13 Summary

This research investigates the UAV Search System under varying transmission powers, USMP feature designs and sensor types. Table 4 summarizes the levels and brevity codes for each factor. Transmission Power limits the dissemination of search protocol packets, thereby limiting the effect of the protocol on the system. The component under test is USMP. The proposed USMP feature designs control how the search system resolves waypoint conflicts, and disseminates UAV locations for use by the swarm logic.

Table 4: Summary of factor levels and brevity codes

<b>Factor</b>	<b>Code</b>	<b>Level 1</b>	<b>Level 2</b>	<b>Level 3</b>	<b>Level 4</b>	<b>Level 5</b>
Waypoint Conflict Resolution	WR	Disabled	Arrival Broadcast	Arrival Geographic	Rank Broadcast	Rank Geographic
Location Update	LU	Disabled	Explicit	Harvest		
Transmission Power	TP	75%	Optimal	Full		
Sensor Type	Ssr	Active	Passive			
Swarm Size	SS	13	25	38		
Initial Location	IL	170-179				

The system’s workload is determined by varying the swarm size, which changes the ratio of cells to UAVs. The experiment is a full factorial simulation with 10 repetitions for



each scenario. Simulations run for up to 1 simulation hour, but terminate upon search completion. Metrics for network performance and cooperative search performance are collected, and compared using statistical analysis.

## IV. Results and Analysis

### 4.1 Overview

This chapter presents and analyzes the results of simulations described in Chapter III. Section 4.2 presents validation results to show models behave correctly. Section 4.3 describes the analytical process and the performance results for each metric. Section 4.4 provides an overview of search performance for all metrics and significant factor levels. Finally, Section 4.5 summarizes the chapter.

### 4.2 Validation

Validation demonstrates that a system produces accurate results when compared to known results under the same conditions. This research validates the UAV Search System using results from the robotic search study [PaM03]. This section also validates the modified components of the GPSR protocol with control scenarios. This research assumes that OPNET Technologies Inc. validates its standard model library as part of product testing and user-supported bug reporting.

*4.2.1 UAV Search System Validation.* The validation simulations for the UAV Search System use a four by four grid of search cells. The original study's mobile nodes moved at a rate of one search cell per turn and assumed turns occurred sequentially. The validation simulation places each search cell center point 1  $m$  from its vertical and horizontal neighbors, and sets each UAV's speed to 1  $m/s$ . This results in approximately one search cell per turn rate of movement, though turns in the validation scenario occur in parallel at a rate of 1  $turn/s$ .

Validation simulations conform to several other constraints found in the original system. UAVs take a rectilinear path to their next waypoint and may not pick the same waypoint as another UAV. While the UAV Search System would ideally resolve all waypoint selection conflicts, non-validation simulations use a local state for each UAV and do not guarantee this. Thus, a global search state is made accessible to all UAVs, which enables perfect waypoint conflict resolution. Finally, both validation and the original study require a UAV to search the cell only if it contains its selected waypoint. UAVs in non-validation simulations search a cell according to sensor type and the central quarter criterion described in Section 3.9.

The validation simulations first prove that the UAV Search System produces an optimal flight path in certain control scenarios. Figure 10 displays each of the control scenarios. A single UAV starts in the lower left corner of the map and travels exactly 15 cell lengths with 6 direction changes when it searches the map optimally. The left half of Figure 10(a) shows a single UAV starting in the lower left corner of the map after searching the whole map, and the figure's right half shows the original study's matching travel path diagram for the same configuration. Figure 10(b) shows the two-UAV scenario with Number of Searches, Distance, Neighbor and Random Rules where the validation flight path is equivalent to the original flight path. Figure 10(c) shows path diagrams when all five rules are used. The UAVs' matching optimal flight paths validate the UAV Search System for each control scenario presented in original study.

Modeler collects Average Direction Changes, Average Distance Traveled and Cooperation Score metrics for each validation simulation. The original study's simulations collected metrics for 240 different combinations of initial node placement where nodes started in dif-



ferent cells for each of four experiments. To reduce the number of experiments, validation simulations select a uniform random initial placement for each node for each of 60 random number generator seeds. After simulation, all data rows where the two UAVs are placed in the same initial cell are removed since the original study excluded these placement values. The results from the randomly selected placement are used to calculate a 95% confidence interval of mean performance suitable for comparison with the original study. Validation covers the four original experiments (the Number of Searches Rule replaces the Single Search Rule):

**Experiment 1** Number of Searches Rule and Random Rule

**Experiment 2** Number of Searches Rule, Distance Rule and Random Rule

**Experiment 3** Number of Searches Rule, Distance Rule, Neighbor Rule and Random Rule

**Experiment 4** Number of Searches Rule, Distance Rule, Neighbor Rule, Travel Straight Rule and Random Rule

Figures 11, 12, 13 and 14 show the mean values from the original and validation experiments.

While differences exist between means from the original study and the validation, overall trends are the same as the figures demonstrate. The common trends in each metric validate the UAV Search System as implemented in this research under the parameters used in the original study. The remainder of this section explains why some means differ between validation and the original study.

Differences in simulation implementation cause a significant difference in several means between the original and validation experiments. Differences in Cooperation Score in Figure 13 and Average Distance Traveled in Figures 11 and 12 are due to different node movement

implementations. Mobile nodes in the original study take turns moving from cell to cell. This results in a node arriving at a new search cell while other nodes are immobile. The validation experiment executes serially, but simulates constant movement by all UAVs in the experiment. Constant movement means all UAVs in a simulation travel the same distance. While one UAV travels toward the last unsearched cell, other UAVs continue traveling and adding to Average Distance Traveled.

The greater disparity of means for Cooperation Score and Average Distance Traveled in experiment 1 derives from cell selection differences. Experiment 1 selects cells at random from the entire map, excluding only previously searched cells. Since experiment 1 excludes the Distance Rule, it is more likely to select waypoints farther than one cell away. Therefore, differences in random seeds and random number generators would be highlighted. The greater probability of farther travel between searches also worsens the “last cell” scenario, forcing UAVs who cannot search the final cell to travel farther.

As Figure 14 shows, implementation differences also cause Average Direction Changes to differ from the original study. The previously mentioned last unsearched cell scenario also records at least one additional UAV direction change as some UAVs travel toward previously searched cells. Additionally, Modeler requires mobile nodes begin a simulation with an initial bearing. In all cases where the first search cell selection lies on a different bearing, the statistic probe collects a direction change for the first move.

*4.2.2 GPSR Model and USMP Validation.* Hyland implemented and validated GPSR in his thesis [Hyl07]. This research validates GPSR with different control scenarios which exercise both the main and modified features of GPSR: greedy geographic forwarding and geographic addressing. While USMP uses simple broadcast for baseline configurations,

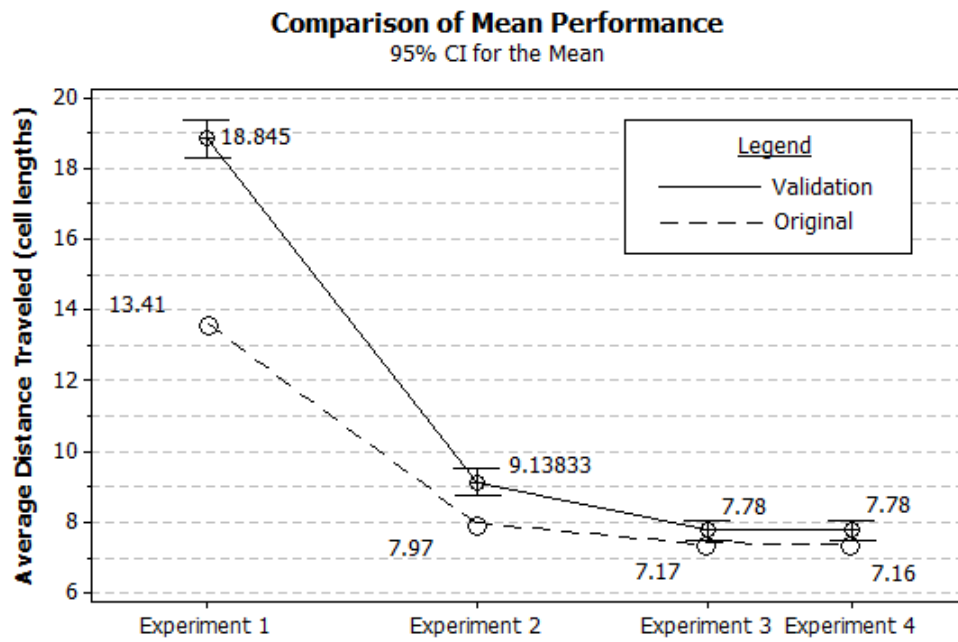

Figure 11: Average Distance Traveled validation (UAV 1)

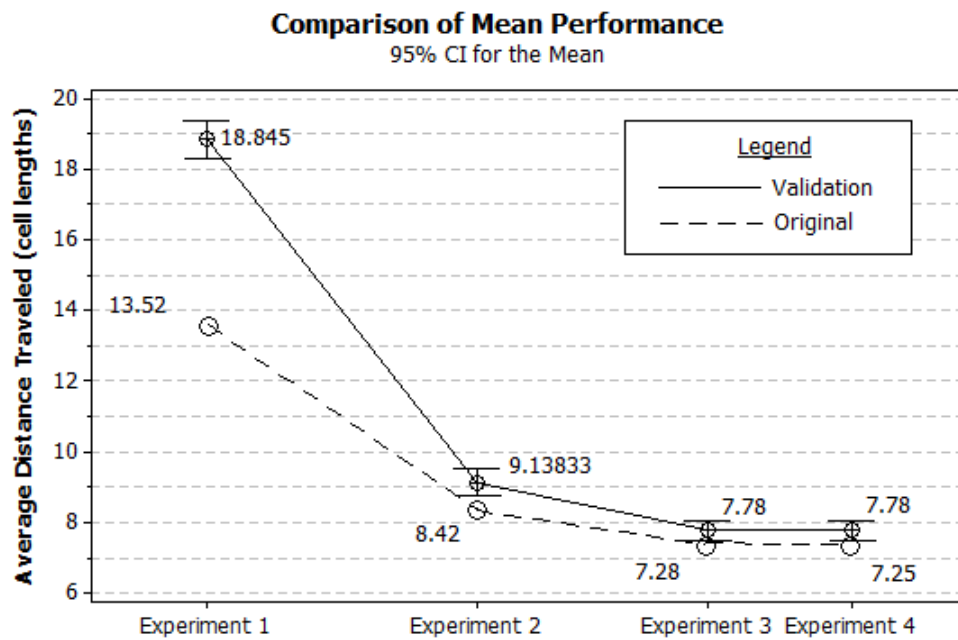

Figure 12: Average Distance Traveled validation (UAV 2)

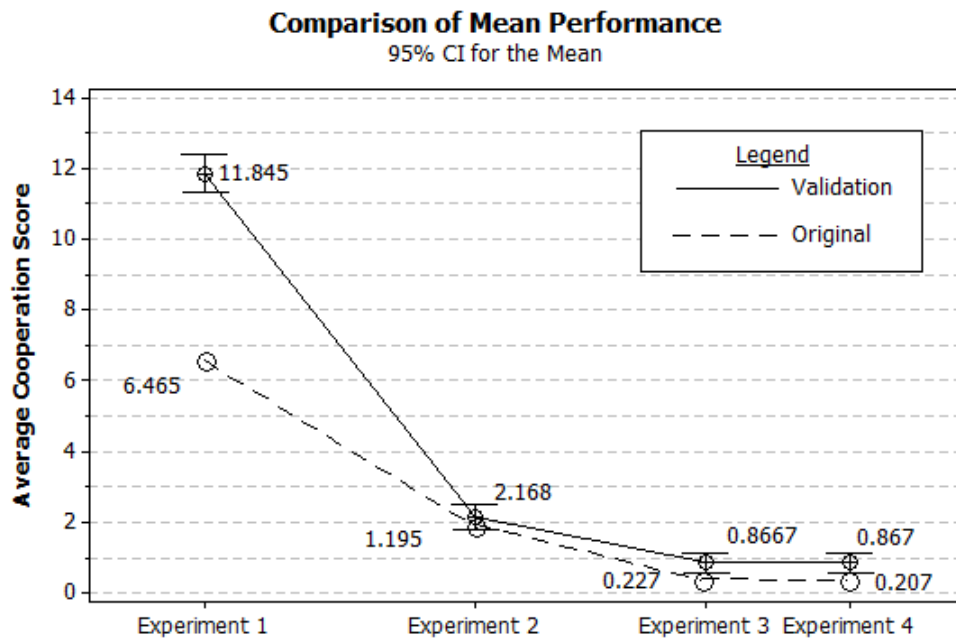

Figure 13: Cooperation Score validation

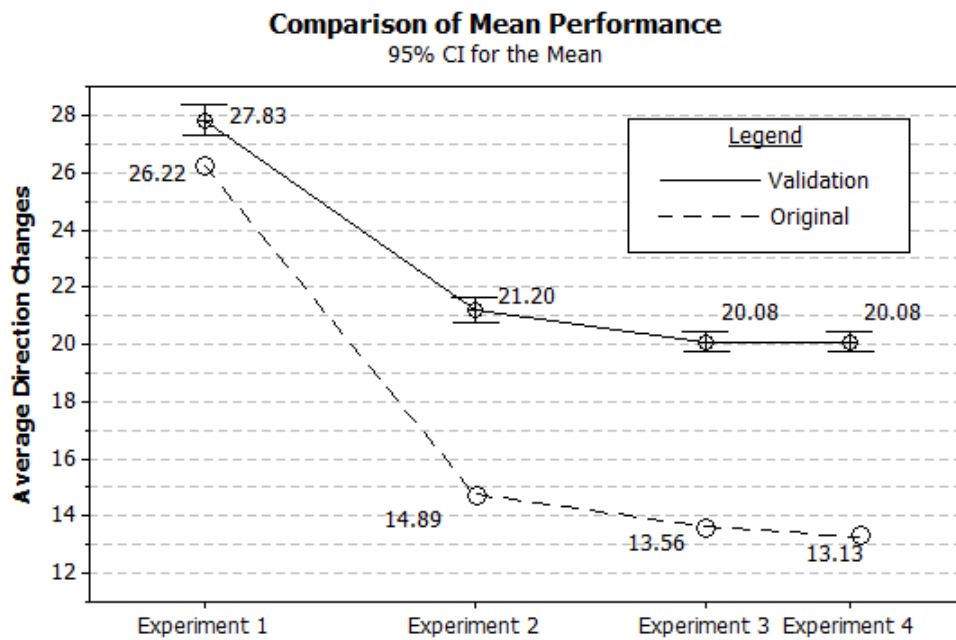

Figure 14: Average Direction Changes validation



several proposed feature designs depend on the geographic addressing and greedy geographic forwarding of GPSR. Therefore, validation of USMP encompasses validation of basic GPSR features. Validation also tests a new cross-layer location information sharing feature (GPSR harvesting) which passes all newly received GPSR location updates to the UAV Search System.

Figure 15 shows the basic GPSR/USMP test setup. A single sender (the UAV labeled “sender”) is placed in communication range of one or more receivers (“hop 1” and “wrong way”). The final destination of each packet resides outside the range of the sender (“destination”), so packets must traverse intermediate hops (“hop 1” and “hop 2”) in most cases and avoid potential hops (“wrong way” and “wrong destination”) that fail the greedy forwarding criteria. All UAVs that forward a USMP packet process the packet and respond if the protocol requires. Test cases specify a starting state for each UAV (parameterized at simulation run time), trigger the sending of a USMP packet and test the state of each UAV after each stage in the protocol. The visual OPNET debugger (ODB) animates the creation, transmission and processing of each packet. After packet processing at each UAV, the ODB pauses and each UAV’s state is displayed for visual inspection. Thus, USMP is verified to update state correctly as well as provide correct responses to received packets. GPSR is validated when USMP packets take the correct route in each control scenario.

### ***4.3 Results and Analysis of UAV Search System Performance***

This section presents statistical analysis of each performance metric defined in Chapter III. The analytical steps taken are:

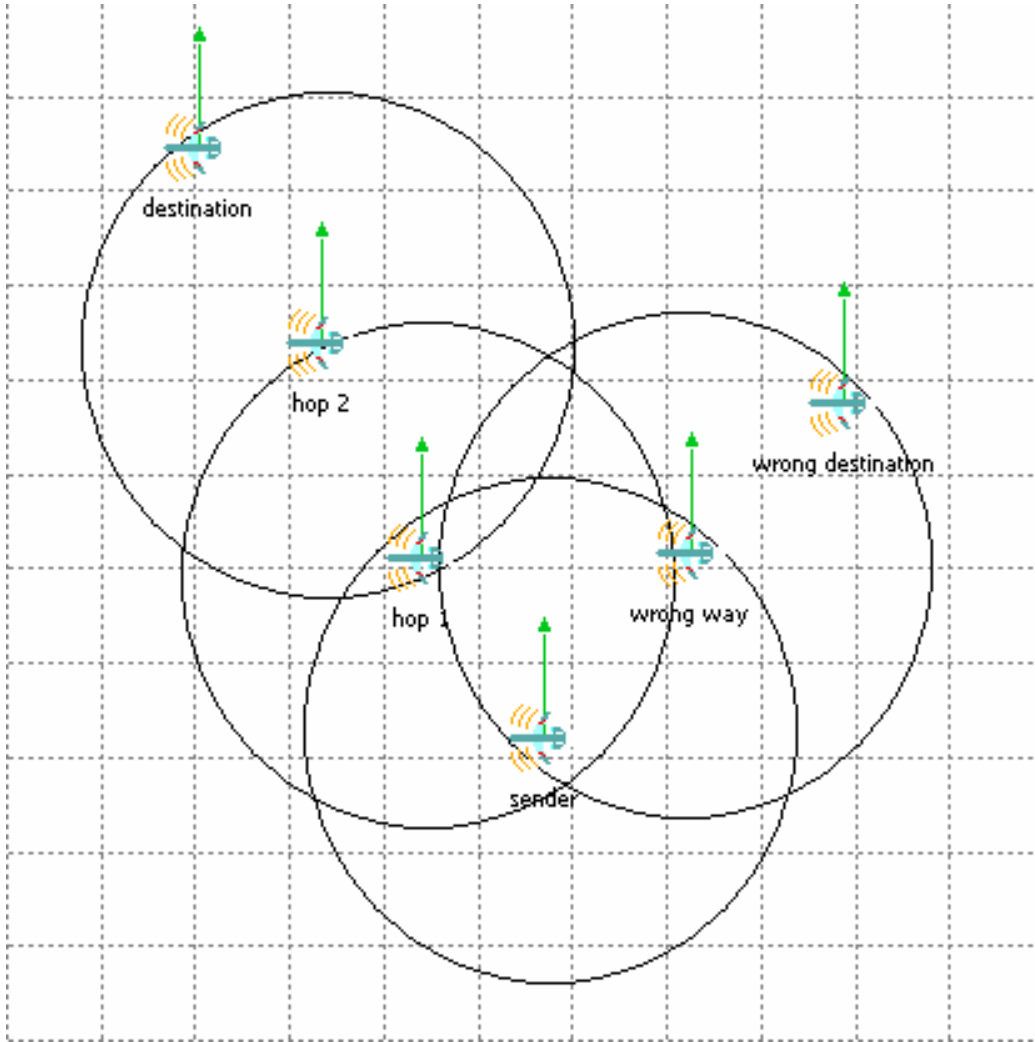

Figure 15: Example test scenario for GPSR and USMP validation

1. A model of all factors and second through fifth order interactions is developed and compared to the response variable using an ANOVA.
2. Minitab generates plots of the residuals to demonstrate independence and normal distribution of residual values. If the plot of residuals versus fits shows a pattern, the response is transformed using logarithmic, square root and reciprocal transformations of the response in that order and retested until the data meets ANOVA assumptions for the general linear model [RaS02]. General linear models used in Minitab enforce a model hierarchy. This means that all lower order effects included in a higher order effect are also included in the model. For example, if a model contains a second order effect, the model also must contain the first order factors that interact to produce the second order effect.
3. Without violating the model hierarchy required by Minitab, the highest order interaction that fails to demonstrate statistical significance in the model is removed and the ANOVA is reapplied. This heuristic process continues until all insignificant interactions are removed from the model [Bal07].
4. Again, without violating model hierarchy requirements, significant interactions that contribute to the least amount of variation in the model are removed iteratively to simplify the model. The process continues as long as the adjusted R-squared value produced by the ANOVA remains above 90% [Bal07], and the resulting residual plots continue to validate the ANOVA assumptions. The adjusted R-squared value measures how much of the response's variation the proposed model explains, while incorporating a "penalty" for extraneous parts of the model [RaS02].

5. The top contributors to variation are investigated via effects plots and comparison of means.

ANOVAs are calculated using an adjusted sum of squares. Confidence intervals are generated with 95% confidence using the Tukey-Kramer method. Sample means whose pairwise comparison produce a p-value less than 0.05 are considered to be statistically different. Statistically different means indicate differences in performance between the levels of each factor. The solid horizontal line in each of the main effects plots describes the total sample mean as a reference.

*4.3.1 Analysis of Total Searches.* Data collected for Total Searches fails the ANOVA assumptions, so a reciprocal transformation is examined (Reciprocal Total Searches). Figure 16(a) shows no clear pattern in the residuals versus fits plot for Reciprocal Total Searches. This validates the ANOVA assumption that residual values are independent. Figures 16(b) and 16(c) demonstrate that the distribution of residual values also closely matches a normal distribution, another ANOVA assumption. The reciprocal transformation alters metric interpretation so that a higher value is better. Table 5 summarizes the ANOVA results. The adjusted R-squared value shows the proposed model accounts for 90.64% of the variation in the sample collected. Waypoint Conflict Resolution, Transmission Power, Location Update and the interaction between Transmission Power and Location Update contribute most significantly to variation. Tukey-Kramer pairwise comparison of all sample means validates the following analysis of main effects and interactions plots.

The main effects plot in Figure 17 illustrates the Reciprocal Total Searches response to Waypoint Conflict Resolution, Transmission Power and Location Update. The Tukey-Kramer analysis computes a statistical significance for all differences in means displayed

Table 5: Model and ANOVA results for Reciprocal Total Searches

Source	DF	Seq SS	Adj SS	% Variation	Adj MS	F	P
IL	9	0.0000005	0.0000005	0.08%	0.0000001	2.3	0.014
SS	2	0.000007	0.000007	1.07%	0.0000035	154.42	0
<b>WR</b>	<b>4</b>	<b>0.000049</b>	<b>0.0000489</b>	<b>7.48%</b>	<b>0.0000122</b>	<b>539.66</b>	<b>0</b>
<b>TP</b>	<b>2</b>	<b>0.0001877</b>	<b>0.000188</b>	<b>28.75%</b>	<b>0.000094</b>	<b>4149.02</b>	<b>0</b>
Ssr	1	0.0000108	0.0000109	1.67%	0.0000109	479.02	0
<b>LU</b>	<b>2</b>	<b>0.0002257</b>	<b>0.0002258</b>	<b>34.53%</b>	<b>0.0001129</b>	<b>4982.59</b>	<b>0</b>
IL*SS	18	0.0000008	0.0000008	0.12%	0	1.88	0.014
IL*WR	36	0.0000016	0.0000016	0.24%	0	1.98	0
IL*TP	18	0.0000009	0.0000009	0.14%	0.0000001	2.22	0.002
IL*LU	18	0.0000008	0.0000008	0.12%	0	1.93	0.011
SS*WR	8	0.000002	0.000002	0.31%	0.0000002	11	0
SS*TP	4	0.000012	0.000012	1.83%	0.000003	131.91	0
SS*Ssr	2	0.0000002	0.0000002	0.03%	0.0000001	4.7	0.009
SS*LU	4	0.0000012	0.0000012	0.18%	0.0000003	12.74	0
WR*TP	8	0.0000094	0.0000094	1.44%	0.0000012	51.63	0
WR*Ssr	4	0.0000015	0.0000015	0.23%	0.0000004	16.89	0
WR*LU	8	0.0000177	0.0000177	2.71%	0.0000022	97.39	0
TP*Ssr	2	0.0000058	0.0000058	0.89%	0.0000029	127.56	0
<b>TP*LU</b>	<b>4</b>	<b>0.000039</b>	<b>0.000039</b>	<b>5.96%</b>	<b>0.0000098</b>	<b>430.6</b>	<b>0</b>
Ssr*LU	2	0.0000046	0.0000046	0.70%	0.0000023	100.6	0
SS*WR*TP	16	0.0000026	0.0000026	0.40%	0.0000002	7.2	0
SS*WR*LU	16	0.0000035	0.0000035	0.54%	0.0000002	9.53	0
IL*SS*WR	72	0.0000034	0.0000034	0.52%	0	2.06	0
SS*TP*LU	8	0.0000014	0.0000014	0.21%	0.0000002	7.68	0
SS*Ssr*LU	4	0.0000004	0.0000004	0.06%	0.0000001	4.07	0.003
IL*SS*LU	36	0.0000014	0.0000014	0.21%	0	1.71	0.006
WR*TP*Ssr	8	0.0000011	0.0000011	0.17%	0.0000001	6.06	0
WR*TP*LU	16	0.0000023	0.0000023	0.35%	0.0000001	6.41	0
IL*WR*TP	72	0.0000024	0.0000024	0.37%	0	1.45	0.009
WR*Ssr*LU	8	0.0000018	0.0000018	0.28%	0.0000002	9.72	0
IL*WR*LU	72	0.0000028	0.0000028	0.43%	0	1.69	0
TP*Ssr*LU	4	0.0000022	0.0000022	0.34%	0.0000006	24.38	0
Error	2210	0.0000501	0.0000501	7.66%	0		
Total	2698	0.0006531	0.000654			R-Sq(adj)	90.64%

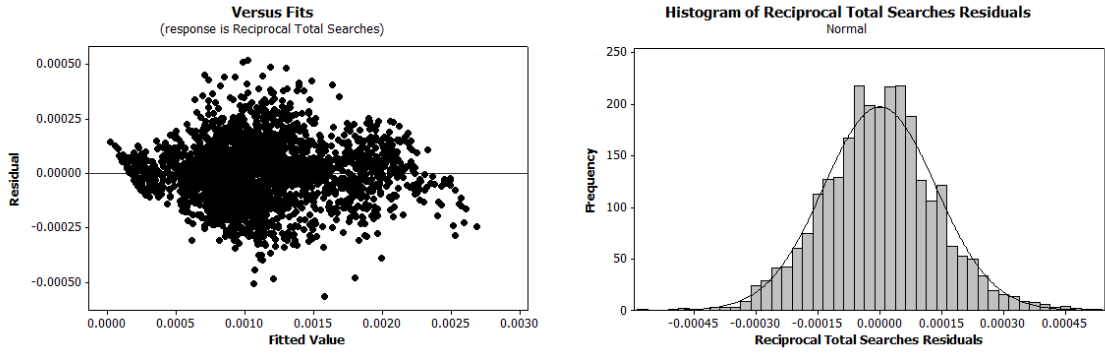

(a) Residuals scatter plot

(b) Residuals histogram versus normal distribution

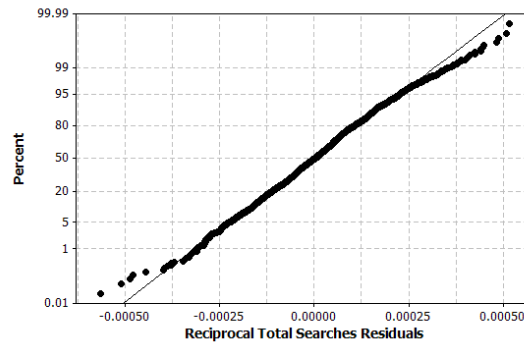

(c) Normal quantile versus residual quantile

Figure 16: Reciprocal Total Searches ANOVA assumptions plots

in the figure. Each increase in Transmission Power significantly increases the Reciprocal Total Searches response. Enabling Location Update increases Reciprocal Total Searches by at least 188%, and explicit updates outperform GPSR harvesting by 3.2%. Enabling Waypoint Conflict Resolution also increases Reciprocal Total Searches by 23.9%. Broadcast Waypoint Conflict Resolution designs outperform geographic routing designs by 13.5% and 13.9% respectively for the Expected Arrival and Rank Rules. The Expected Arrival Rule improves performance by 3% when Waypoint Conflict Resolution messages are broadcast and by 3.3% when geographically routed.

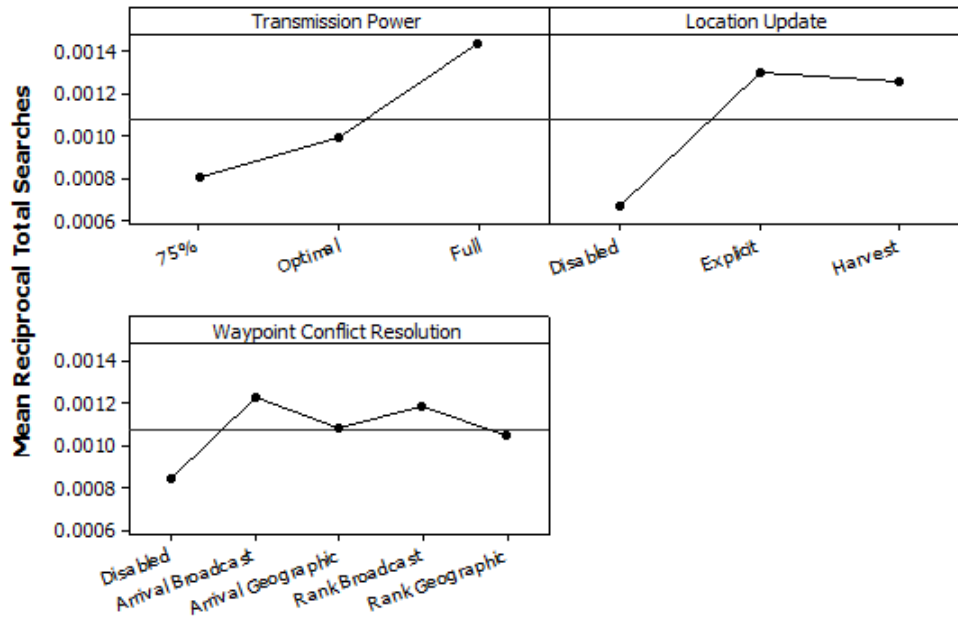

Figure 17: Reciprocal Total Searches Main Effects Plot

The interaction plot in Figure 18 shows that increasing Transmission Power magnifies the effect of Location Update for the three Location Update factor levels where Location Update is enabled. Explicit updates outperform GPSR harvesting by 5.5% when paired with Optimal Transmission Power and 2.7% when paired with Full Transmission Power.

At the lowest Transmission Power setting no significant performance difference occurs between GPSR harvesting and explicit. For both the main effect and the interaction, the difference between explicit updates and GPSR harvesting is two orders of magnitude smaller than the difference between enabling and disabling Location Update.

Overall, the data for Reciprocal Total Searches shows clear trends regarding the USMP design options. The Expected Arrival Rule outperforms the Rank Rule in every case where

Waypoint Conflict Resolution is enabled. Broadcast Waypoint Conflict Resolution design options provide 83% fewer searches on the original scale than geographic routing Waypoint Conflict Resolution designs. Finally, explicit updates outperform GPSR harvesting by a 3.2% (2.8% in the original scale).

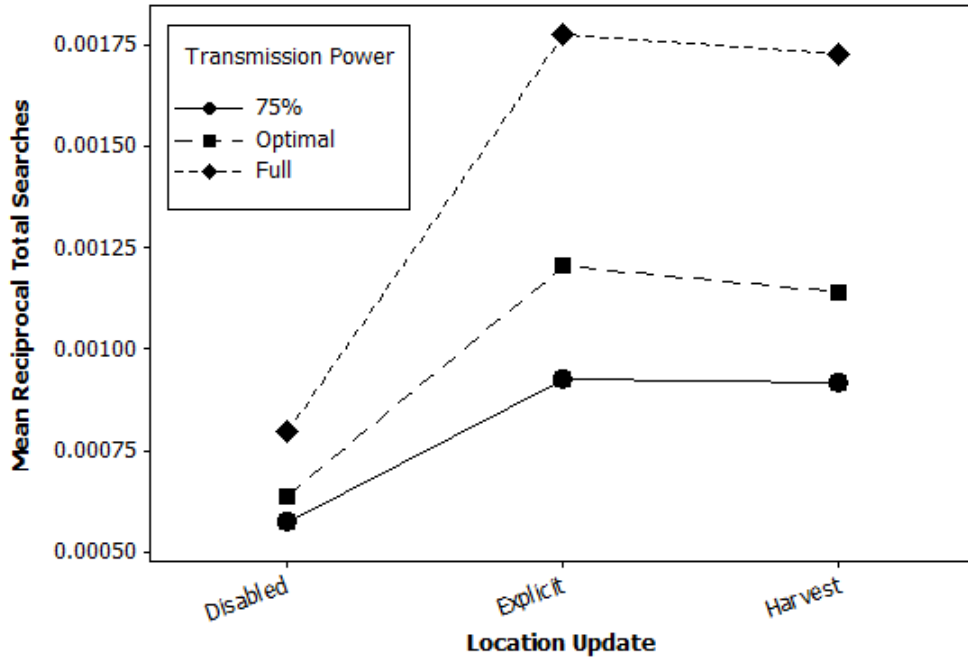
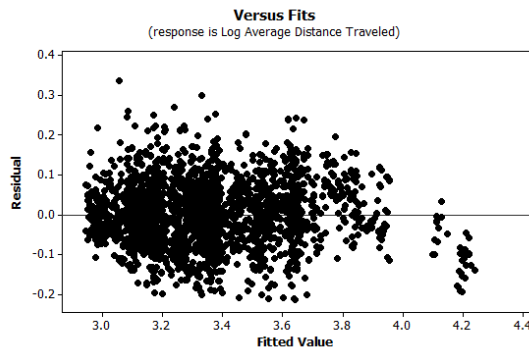

Figure 18: Reciprocal Total Searches interaction plot

*4.3.2 Analysis of Average Distance Traveled.* Data collected for Average Distance Traveled fails the ANOVA’s assumptions of residual normality and independence. Therefore, a log transformation of the data (Log Average Distance Traveled), which meets ANOVA assumptions, is analyzed instead. Figure 19(a) shows some patterning in the residuals versus fits plot for Log Average Distance Traveled, but is considered random enough to meet the assumption. This validates the ANOVA assumption that residual values are inde-



pendent. Figures 19(b) and 19(c) demonstrate that the distribution of residual values also closely matches a normal distribution, another ANOVA assumption. Table 6 summarizes the ANOVA model and results. The adjusted R-squared value shows that the proposed model accounts for 90.82% of the variation in the sample collected. The top first-order contributors to variation include Location Update, Waypoint Conflict Resolution, Transmission Power and Swarm Size. The interaction between Location Update and Waypoint Conflict Resolution is the only significant second order effect to contribute more than 1% to variation.



(a) Residuals scatter plot

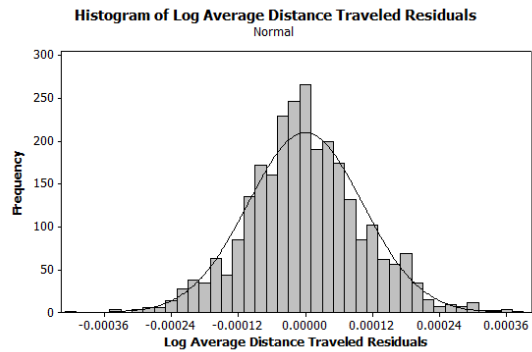

(b) Residuals histogram versus normal distribution

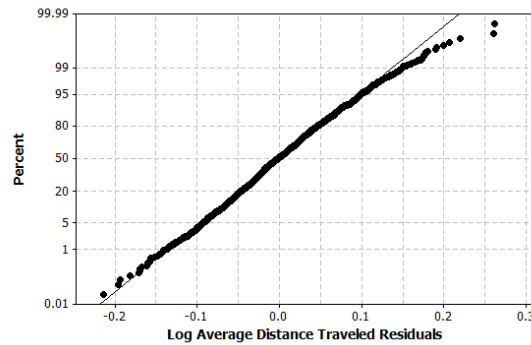

(c) Normal quantile versus residual quantile

Figure 19: Log Average Distance Traveled ANOVA assumptions plots

Table 6: Model and ANOVA results for Log Average Distance Traveled

Source	DF	Seq SS	Adj SS	%Variation	Adj MS	F	P
IL	9	1.0637	1.0674	0.54%	0.1186	17.66	0
<b>SS</b>	<b>2</b>	<b>71.4062</b>	<b>71.4199</b>	<b>36.19%</b>	<b>35.71</b>	<b>5317.18</b>	<b>0</b>
<b>WR</b>	<b>4</b>	<b>16.9998</b>	<b>16.9969</b>	<b>8.61%</b>	<b>4.2492</b>	<b>632.70</b>	<b>0</b>
<b>TP</b>	<b>2</b>	<b>15.5214</b>	<b>15.5446</b>	<b>7.88%</b>	<b>7.7723</b>	<b>1157.29</b>	<b>0</b>
<b>LU</b>	<b>2</b>	<b>48.5437</b>	<b>48.5463</b>	<b>24.60%</b>	<b>24.2732</b>	<b>3614.25</b>	<b>0</b>
IL*SS	18	1.9139	1.9137	0.97%	0.1063	15.83	0
SS*TP	4	1.0786	1.0785	0.55%	0.2696	40.15	0
WR*TP	8	0.9123	0.9125	0.46%	0.1141	16.98	0
<b>WR*LU</b>	<b>8</b>	<b>20.9058</b>	<b>20.9053</b>	<b>10.59%</b>	<b>2.6132</b>	<b>389.10</b>	<b>0</b>
TP*LU	4	1.2708	1.2708	0.64%	0.3177	47.30	0
Error	2637	17.71	17.71	8.97%	0.0067		
Total			197.3659	100.00%		Adj R-Sq	90.82%

Figure 20 plots the main effects of each significant factor. The Tukey-Kramer pairwise analysis of means confirms all mean differences indicated on the plot are statistically significant. Just as Total Searches, broadcast Waypoint Conflict Resolution designs outperform geographic routing designs, and the Expected Arrival Rule reduces distance traveled compared to the Rank Rule. In the original scale, using broadcasts over geographic routing decreases Average Distance Traveled by 20%, and using the Expected Arrival Rule versus the Rank Rule reduces Average Distance Traveled by about 4%. Increasing Transmission Power steadily decreases Log Average Distance Traveled. Increasing Swarm Size also steadily decreases Average Distance Traveled, which is consistent with the definition of workload from Chapter III. Enabling Waypoint Conflict Resolution reduces Log Average Distance Traveled by 4.1%, and enabling Location Update reduces Log Average Distance Traveled by 8.3%. Explicit updates outperform GPSR harvesting by 0.6% (6% in the original scale).

Performance differences in the interaction between Location Update and Waypoint Conflict Resolution are only distinguishable when Location Update is disabled. This is most clearly illustrated by the top line in Figure 21 which shows the effect of all Waypoint

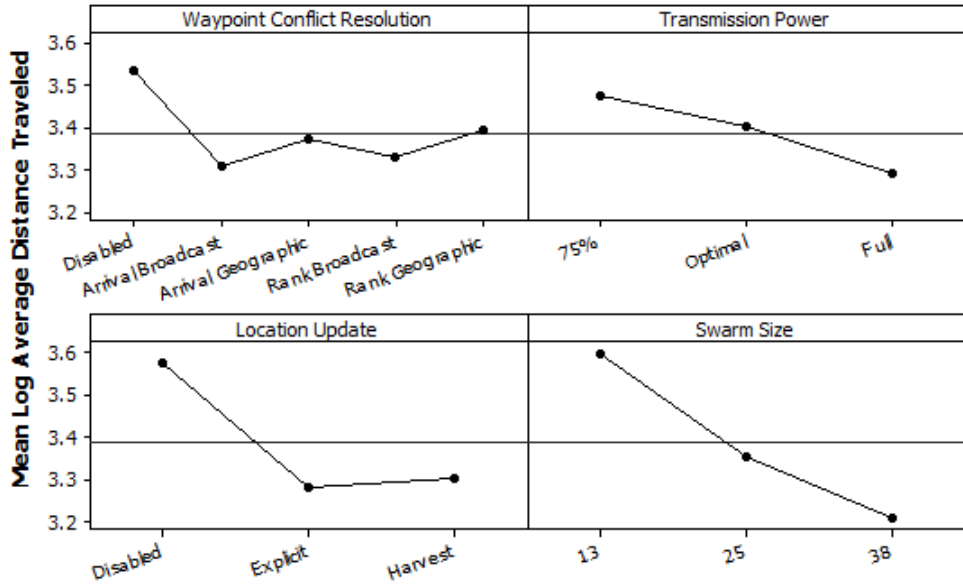

Figure 20: Log Average Distance Traveled main effects plot

Conflict Resolution factors when Location Update is disabled. It is notable that when Location Update and Waypoint Conflict Resolution are enabled, no statistically significant performance difference exists between explicit updates and GPSR harvesting. The bottom two trend lines in Figure 21 highlight this phenomenon.

Except for Swarm Size, the analytical results from examining Log Average Distance Traveled closely track the Reciprocal Total Searches results. The Distance Rule accounts for this result. Since the swarm prioritizes adjacent cells, distances between cell searches are either 50 *m* for rectilinear moves or 70.71 *m* for diagonal moves until no unsearched, adjacent cells are available. Because of the approximate equidistance between search choices, Average Distance Traveled and Total Searches share a roughly linear relationship as seen in Figure 22(a). Using linear regression and given Swarm Size's factor level, Average Distance Traveled can predict Total Searches with 96.42% confidence using  $Total\ Searches = -20.5 +$

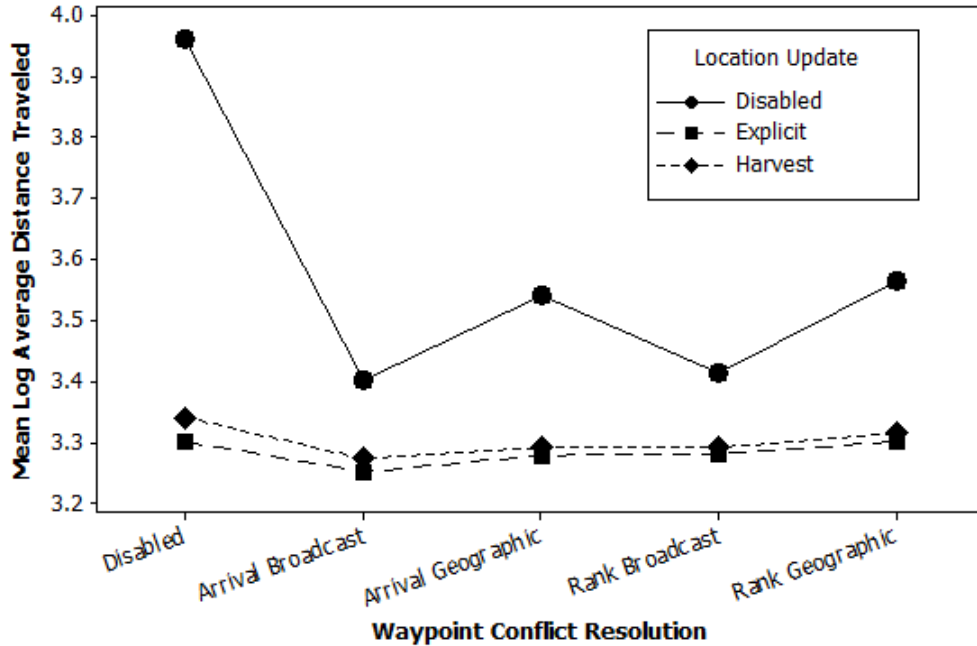

Figure 21: Log Average Distance Traveled interaction plot

0.0193 *Average Distance Traveled \* Swarm Size*. The data points from a single Initial Location (random seed 178) generate the smaller, divergent line in Figure 22(a). This divergent line suggests that a relationship may exist between Initial Location and average distance traveled *per search* (Average Distance Traveled measures average distance per UAV). Figure 22(b) shows the same plot without the data points generated by random seed 178.

*4.3.3 Analysis of Average Direction Changes.* The residuals from Average Direction Changes fail the ANOVA assumptions, so a log transformation of the sample (Log Average Direction Changes) is examined. Figure 23(a) shows no pattern in the residuals versus fits plot for Log Average Direction Changes. This validates the ANOVA assumption that residual values are independent. Figures 23(b) and 23(c) demonstrate that the distribution of residual values violates the assumption of normality. However, ANOVAs are

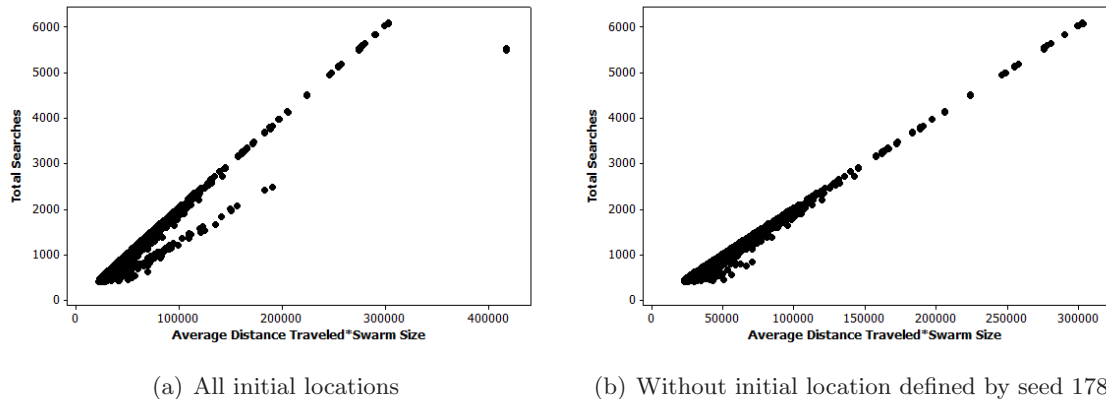

Figure 22: Total Searches versus Average Distance Traveled \* Swarm Size

resilient against violations of normality for large sample sizes [MiA04]. The sample size examined here is 2700, and the distribution of residuals is unimodal and symmetric. Therefore, the distribution of residuals matches a normal distribution *sufficiently well* to continue with the ANOVA with the expectation of accurate results. Compared to other metrics, Average Direction Changes requires the most complex model to explain variation with an adjusted R-squared value greater than 90%. Table 7 summarizes the results. The adjusted R-squared value shows that the proposed model accounts for 91.36% of the variation in Log Average Direction Changes. Transmission Power, Waypoint Conflict Resolution and their second order interactions with Location Update contribute most significantly to variation. The Tukey-Kramer pairwise comparison of all sample means validates the following analysis of main effects and interactions plots.

The main effects plot in Figure 24 illustrates Log Average Direction Changes' response to Transmission Power and Waypoint Conflict Resolution. While the shift from 75% to Optimal in Transmission Power produces no significant change, increasing Transmission Power to Full significantly increases the number of direction changes per UAV. For Waypoint Conflict Resolution, the geographic routing designs significantly reduce direction changes compared

Table 7: Model and ANOVA results for Log Average Direction Changes

Source	DF	Seq SS	Adj SS	% Variation	Adj MS	F	P
<b>TP</b>	<b>2</b>	<b>110.1685</b>	<b>109.83</b>	<b>19.67%</b>	<b>54.92</b>	<b>2748.65</b>	<b>0</b>
Ssr	1	1.0362	1.03	0.18%	1.03	51.62	0
LU	2	6.0569	6.06	1.09%	3.03	151.61	0
SS	2	12.8404	12.84	2.30%	6.42	321.36	0
IL	9	0.2486	0.25	0.04%	0.03	1.39	0.191
TP*Ssr	2	0.0842	0.08	0.01%	0.04	2.09	0.125
<b>TP*LU</b>	<b>4</b>	<b>47.4341</b>	<b>47.32</b>	<b>8.48%</b>	<b>11.83</b>	<b>592.06</b>	<b>0</b>
TP*SS	4	7.8942	7.90	1.41%	1.97	98.83	0
TP*IL	18	1.4742	1.47	0.26%	0.08	4.1	0
Ssr*LU	2	0.5002	0.49	0.09%	0.25	12.3	0
Ssr*SS	2	0.2212	0.22	0.04%	0.11	5.49	0.004
Ssr*IL	9	0.2761	0.28	0.05%	0.03	1.54	0.129
LU*SS	4	0.9777	0.98	0.18%	0.25	12.26	0
LU*IL	18	1.2224	1.22	0.22%	0.07	3.39	0
SS*IL	18	1.6878	1.69	0.30%	0.09	4.7	0
TP*Ssr*LU	4	0.043	0.04	0.01%	0.01	0.54	0.704
TP*Ssr*SS	4	0.1416	0.14	0.02%	0.03	1.73	0.143
TP*Ssr*IL	18	0.6539	0.66	0.12%	0.04	1.83	0.019
TP*LU*SS	8	3.7063	3.70	0.66%	0.46	23.18	0
TP*LU*IL	36	2.5371	2.54	0.46%	0.07	3.53	0
TP*SS*IL	36	3.2089	3.21	0.58%	0.09	4.47	0
Ssr*LU*SS	4	0.0821	0.08	0.01%	0.02	1.02	0.397
Ssr*LU*IL	18	0.4333	0.44	0.08%	0.02	1.21	0.245
Ssr*SS*IL	18	0.7865	0.79	0.14%	0.04	2.18	0.003
LU*SS*IL	36	2.5471	2.53	0.45%	0.07	3.52	0
TP*Ssr*LU*IL	36	0.6592	0.66	0.12%	0.02	0.92	0.6
TP*LU*SS*IL	72	5.0953	5.10	0.91%	0.07	3.54	0
Ssr*LU*SS*IL	36	1.0823	1.07	0.19%	0.03	1.49	0.035
<b>WR</b>	<b>4</b>	<b>84.4419</b>	<b>84.43</b>	<b>15.12%</b>	<b>21.11</b>	<b>1056.44</b>	<b>0</b>
Ssr*WR	4	1.2376	1.24	0.22%	0.31	15.54	0
<b>LU*WR</b>	<b>8</b>	<b>84.5504</b>	<b>84.51</b>	<b>15.14%</b>	<b>10.56</b>	<b>528.72</b>	<b>0</b>
SS*WR	8	5.4469	5.45	0.98%	0.68	34.13	0
IL*WR	36	2.8198	2.83	0.51%	0.08	3.93	0
Ssr*LU*WR	8	1.4323	1.44	0.26%	0.18	9.01	0
Ssr*SS*WR	8	0.1951	0.19	0.03%	0.02	1.21	0.293
Ssr*IL*WR	36	0.7257	0.73	0.13%	0.02	1.01	0.457
LU*SS*WR	16	1.7591	1.74	0.31%	0.11	5.46	0
LU*IL*WR	72	5.271	5.28	0.95%	0.07	3.67	0
SS*IL*WR	72	3.6385	3.62	0.65%	0.05	2.52	0
Ssr*LU*SS*WR	16	0.2294	0.23	0.04%	0.01	0.72	0.776
Ssr*LU*IL*WR	72	1.9595	1.96	0.35%	0.03	1.36	0.032
Ssr*SS*IL*WR	72	2.0941	2.09	0.38%	0.03	1.46	0.012
LU*SS*IL*WR	144	9.377	9.33	1.67%	0.06	3.24	0
Ssr*LU*SS*IL*WR	144	3.7287	3.69	0.66%	0.03	1.28	0.025
<b>TP*WR</b>	<b>8</b>	<b>49.0212</b>	<b>48.89</b>	<b>8.76%</b>	<b>6.11</b>	<b>305.87</b>	<b>0</b>
TP*LU*WR	16	23.4434	23.40	4.19%	1.46	73.19	0
TP*SS*WR	16	7.2219	7.22	1.29%	0.45	22.6	0
TP*IL*WR	72	5.4604	5.44	0.97%	0.08	3.78	0
TP*LU*SS*WR	32	3.2226	3.21	0.58%	0.10	5.02	0
TP*LU*IL*WR	144	7.479	7.49	1.34%	0.05	2.6	0
TP*SS*IL*WR	144	9.0722	9.08	1.63%	0.06	3.15	0
TP*LU*SS*IL*WR	288	13.9975	13.98	2.50%	0.05	2.43	0
TP*Ssr*WR	8	0.1069	0.11	0.02%	0.01	0.66	0.729
TP*Ssr*SS*WR	16	0.4272	0.42	0.07%	0.03	1.3	0.19
TP*Ssr*IL*WR	72	2.0343	2.04	0.37%	0.03	1.42	0.017
TP*Ssr*LU*WR	16	0.4	0.41	0.07%	0.03	1.28	0.204
TP*Ssr*LU*IL*WR	144	3.6279	3.63	0.65%	0.03	1.26	0.034
Error	579	11.5681	11.57	2.07%	0.02		
Total	2698	559.0885	558.27	100.00%		R-Sq(adj)	90.36%

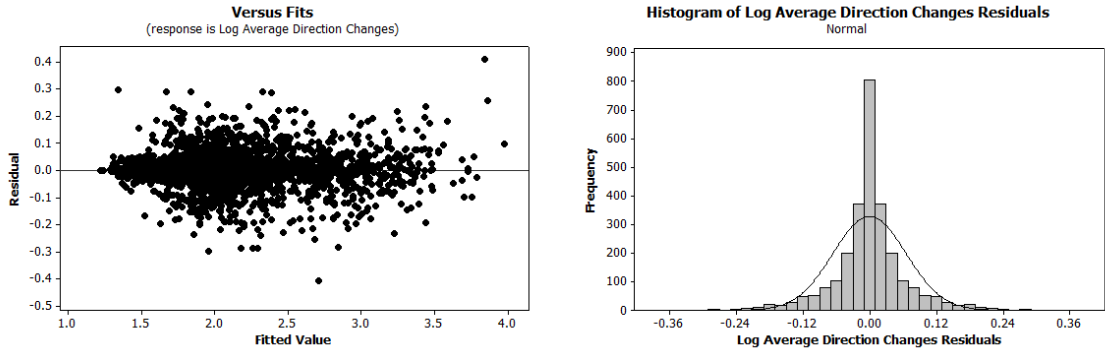

(a) Residuals scatter plot

(b) Residuals histogram versus normal distribution

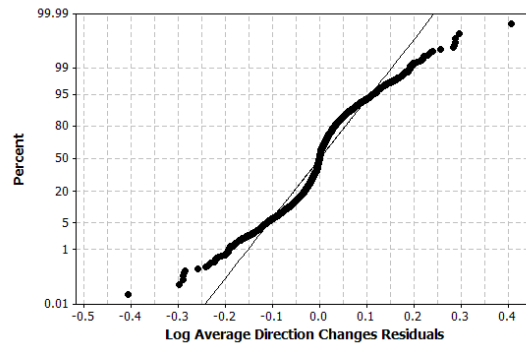

(c) Normal quantile versus residual quantile

Figure 23: Log Average Direction Changes ANOVA assumptions plots

to their broadcast alternatives—6.5% for the Rank Rule and 6.1% for the Expected Arrival Rule (21.4% and 69.7% in the original scale). The most significant reduction in Log Average Direction Changes from varying Waypoint Conflict Resolution levels, 18.4%, results when Waypoint Conflict Resolution is disabled. As expected, employing Waypoint Conflict Resolution increases Average Direction Changes since a successful conflict resolution often results in a direction change. The Estimated Arrival Rule performs better than the Rank Rule by 1.1% (36.1% in the original scale) for geographic routing, while broadcast versions with different resolution rules fail to differ significantly.

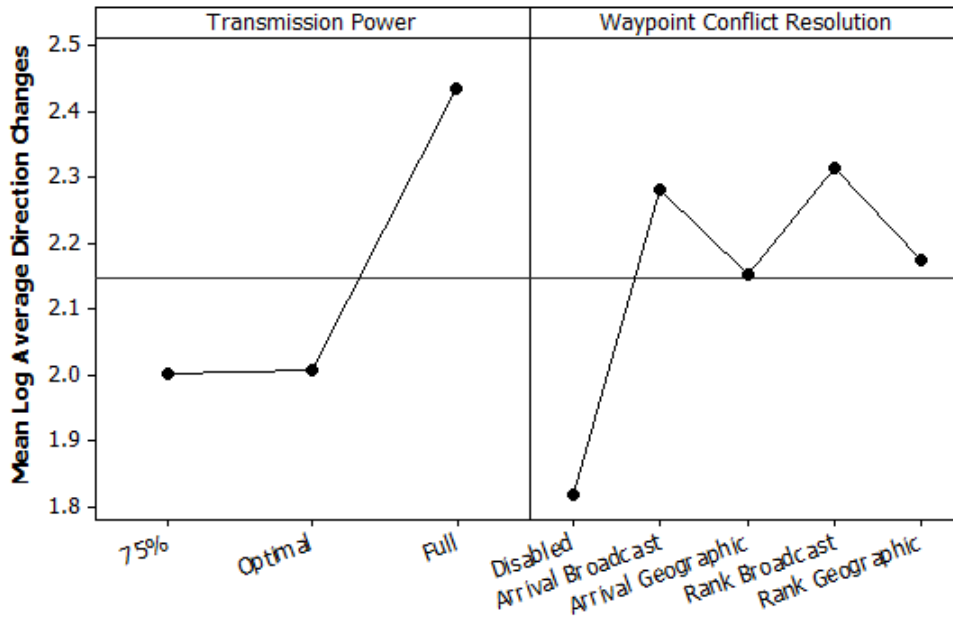

Figure 24: Log Average Direction Changes main effects plot

The interaction plots for Log Average Direction Changes in Figure 25 are similar to the main effects, but offer additional insight. The top lines in Figures 25(a) and 25(b) show that Full Transmission Power magnifies the effect of Location Update and Waypoint Conflict Resolution designs. Figure 25(a) shows that increasing Transmission Power from 75% to Optimal results in a significant 2.3% decrease in performance for GPSR harvesting. In the original scale, the median Average Direction Changes jumps from 171 to about 541 direction changes. The solid lines in Figures 25(d) and 25(c) show that disabling either Location Update or Waypoint Conflict Resolution, but not both, results in significant Log Average Direction Changes decreases. When Location Update is enabled, Waypoint Conflict Resolution geographic routing designs significantly reduce Log Average Direction Changes by 6.7% compared to their broadcast counterparts for the same Location Update level. When Waypoint Conflict Resolution is enabled, explicit updates reduces Log Average



Direction Changes by 2.4% versus GPSR harvesting for the same level of Waypoint Conflict Resolution.

Resolution.

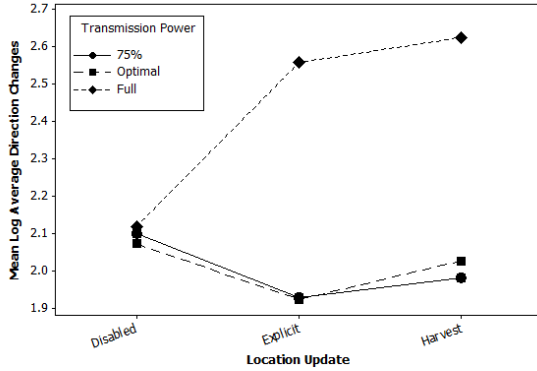

(a) Transmission Power versus Location Update

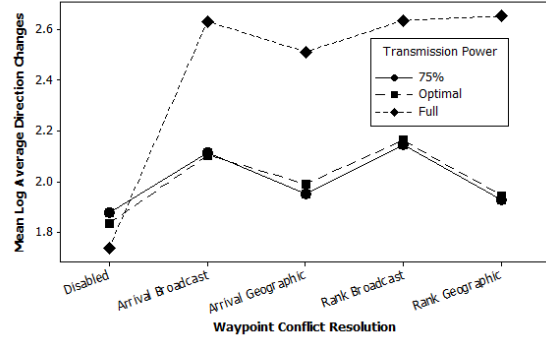

(b) Transmission Power versus Waypoint Conflict Resolution

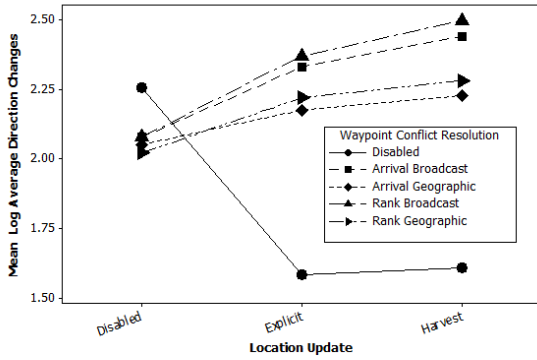

(c) Waypoint Conflict Resolution versus Location Update

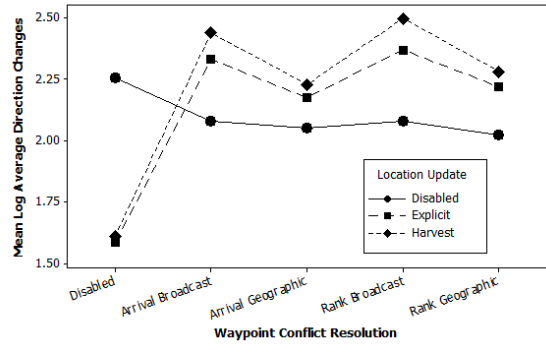

(d) Location Update versus Waypoint Conflict Resolution

Figure 25: Log Average Direction Changes interaction plots

Overall, the results for Log Average Direction Changes suggest that reducing, but not eliminating the dissemination of search information improves search performance by reducing Average Direction Changes. The most pronounced effect occurs when Transmission Power is increased to Full, which magnifies the effect of Location Update and Waypoint Conflict Resolution. The interaction between Location Update and Waypoint Conflict Resolution also suggests that increasing communication increases Average Direction Changes. In a real UAV swarm, stale or incorrect location information could explain why more com-

munication would increase Average Direction Changes. Discounting latent software errors in the simulation, location information in the UAV Search System is always correct, and the experiment's low network utilization makes stale information unlikely. Therefore, another property of the system must be increasing Average Direction Changes as information dissemination increases.

The interaction between Location Update and Transmission Power points to the swarm logic as the source of Average Direction Changes increase. Without location information from others, a UAV is free to search all cells, meaning only the Travel Straight Rule, the Random Rule and the Distance Rule are applied to the UAV's own previous search history dictate search decisions. As soon as external location information becomes available, the other swarm rules prioritize cells that may require a direction change. Increasing location information availability would only further diminish the effect of the Travel Straight Rule. This explains the increase in Average Direction Changes as Transmission Power increases.

It is conjectured that limiting the information available to the Neighbor Rule could reduce Average Direction Changes without negatively impacting the other search metrics. While the Number of Searches Rule causes direction changes by limiting selection choices, it is necessary to guarantee search completion. The Distance Rule causes direction changes the same way, but results from the original and validation experiments show it significantly reduces Average Distance Traveled. Both of these searches are tied directly to a pertinent search performance metric. Limiting information to these rules would therefore result in poorer search performance. The Neighbor Rule, however, does not make search decisions based directly on a search performance metric. Therefore, the trend of decreasing Average

Direction Changes as data transfer decreases makes the Neighbor Rule a promising candidate for further research where location information to that rule is limited.

*4.3.4 Analysis of Search Redundancy Concentration.* Figure 26 shows that Search Redundancy Concentration meets the assumptions of the ANOVA without transformation of the response data, though a pattern of horizontal straight lines appears in the residuals versus fits plot in Figure 26(a) as the fit values increase. A constant difference in variation between Swarm Size levels where Location Update is disabled accounts for the lines since examining a single Swarm Size level in isolation eliminates the pattern and reduces residual spread by half. Eliminating all data points where Location Update is disabled also removes the pattern, while residual spread remains approximately the same. This shows that the horizontal linear pattern in the overall residuals versus fits plot occurs when the protocol starves the swarm of location data. In the absence of communicated data, the only way to adjust search performance is changing Swarm Size (i.e., workload). Therefore, for the patterned section in Figure 26(a), Swarm Size is the only factor that affects Search Redundancy Concentration. These data points are retained for comparisons between communication and no communication scenarios, and the pattern is considered slight enough to continue with the ANOVA. Figures 26(b) and 26(c) show the data isn't normal, but just as for Average Direction Changes in Section 4.3.3, the distribution of residuals matches a normal distribution *sufficiently well* to continue with the ANOVA. Table 8 summarizes the ANOVA model and results.

The adjusted R-squared value shows that the proposed model accounts for 91.06% of the variation in the response. The top contributors to variation are Location Update, Way-point Conflict Resolution and their second order effect. The main effects and interaction

Table 8: Model and ANOVA results for Search Redundancy Concentration

Source	DF	Seq SS	Adj SS	% Variation	Adj MS	F	P
TP	2	0.52202	0.51739	1.60%	0.25869	241.99	0.00
Ssr	1	0.76698	0.76978	2.39%	0.76978	720.06	0.00
<b>LU</b>	<b>2</b>	<b>5.69356</b>	<b>5.69617</b>	<b>17.67%</b>	<b>2.84808</b>	<b>2664.14</b>	<b>0.00</b>
SS	2	1.09309	1.09203	3.39%	0.54602	510.75	0.00
IL	9	0.08873	0.08901	0.28%	0.00989	9.25	0.00
TP*Ssr	2	0.9432	0.94423	2.93%	0.47212	441.63	0.00
TP*LU	4	0.5899	0.58985	1.83%	0.14746	137.94	0.00
TP*SS	4	1.18184	1.18126	3.66%	0.29531	276.24	0.00
TP*IL	18	0.05207	0.0522	0.16%	0.00290	2.71	0.00
Ssr*LU	2	0.3891	0.38909	1.21%	0.19454	181.98	0.00
LU*SS	4	0.03509	0.0351	0.11%	0.00877	8.21	0.00
LU*IL	18	0.10195	0.10194	0.32%	0.00566	5.30	0.00
SS*IL	18	0.09954	0.09953	0.31%	0.00553	5.17	0.00
TP*Ssr*LU	4	0.58821	0.5873	1.82%	0.14682	137.34	0.00
TP*LU*SS	8	0.28808	0.28809	0.89%	0.03601	33.69	0.00
TP*LU*IL	36	0.09306	0.09303	0.29%	0.00258	2.42	0.00
TP*SS*IL	36	0.04559	0.0456	0.14%	0.00127	1.18	0.21
LU*SS*IL	36	0.13117	0.13116	0.41%	0.00364	3.41	0.00
TP*LU*SS*IL	72	0.12128	0.1211	0.38%	0.00168	1.57	0.00
<b>WR</b>	<b>4</b>	<b>6.97196</b>	<b>6.97071</b>	<b>21.62%</b>	<b>1.74268</b>	<b>1630.13</b>	<b>0.00</b>
Ssr*WR	4	0.1525	0.15268	0.47%	0.03817	35.70	0.00
<b>LU*WR</b>	<b>8</b>	<b>4.17858</b>	<b>4.17801</b>	<b>12.96%</b>	<b>0.52225</b>	<b>488.52</b>	<b>0.00</b>
SS*WR	8	0.87951	0.87949	2.73%	0.10994	102.84	0.00
IL*WR	36	0.22084	0.22082	0.68%	0.00613	5.74	0.00
LU*SS*WR	16	1.27615	1.27604	3.96%	0.07975	74.60	0.00
LU*IL*WR	72	0.41574	0.41553	1.29%	0.00577	5.40	0.00
SS*IL*WR	72	0.32059	0.32045	0.99%	0.00445	4.16	0.00
LU*SS*IL*WR	144	0.62311	0.623	1.93%	0.00433	4.05	0.00
TP*WR	8	0.29879	0.29878	0.93%	0.03735	34.94	0.00
TP*LU*WR	16	1.46787	1.46688	4.55%	0.09168	85.76	0.00
TP*SS*WR	16	0.02379	0.02378	0.07%	0.00149	1.39	0.14
TP*IL*WR	72	0.10932	0.10947	0.34%	0.00152	1.42	0.01
TP*LU*SS*WR	32	0.11352	0.11326	0.35%	0.00354	3.31	0.00
TP*LU*IL*WR	144	0.21943	0.21898	0.68%	0.00152	1.42	0.00
TP*SS*IL*WR	144	0.22197	0.22194	0.69%	0.00154	1.44	0.00
TP*LU*SS*IL*WR	288	0.36517	0.36513	1.13%	0.00127	1.19	0.03
TP*Ssr*WR	8	0.14461	0.14461	0.45%	0.01808	16.91	0.00
Error	1328	1.41969	1.41969	4.40%	0.00107		
Total	2698	32.25	32.24311			R-Sq(adj)	91.06%

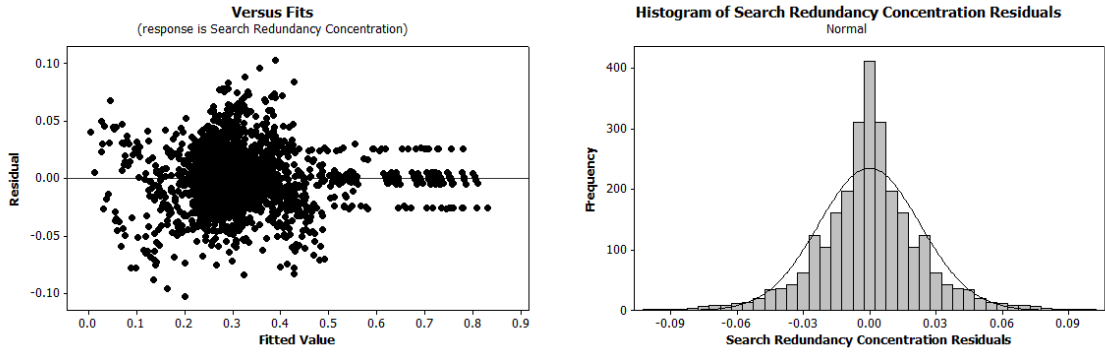

(a) Residuals scatter plot

(b) Residuals histogram versus normal distribution

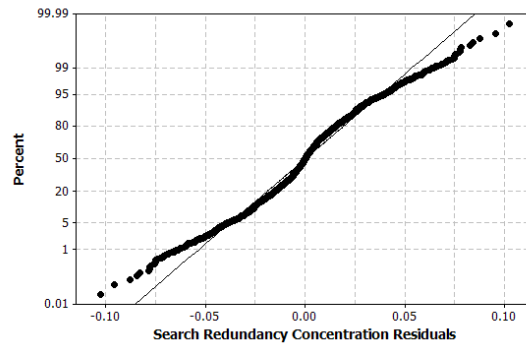

(c) Normal quantile versus residual quantile

Figure 26: Search Redundancy Concentration ANOVA assumptions plots

plots in Figure 27 show the general relationship between means. A Tukey-Kramer pairwise comparison of all means for Waypoint Conflict Resolution indicate that only the means for levels Arrival Broadcast and Rank Broadcast *fail* to demonstrate a statistically significant difference. Thus, the main effects plot in Figure 27 indicates that broadcast Waypoint Conflict Resolution designs result in lower Search Redundancy Concentration compared to geographic routing designs. The difference, however, is only 0.011 which is small since the scale of recorded values ranges from about 0.005 to 0.8. Thus, 0.011 accounts for a shift of 1.4% over the range of recorded values. When the Waypoint Conflict Resolution design uses geographic routing, the Expected Arrival Rule offers lower Search Redundancy Concentra-

tion (0.8% over the range of recorded values). Performance differences are indistinguishable between different broadcast Waypoint Conflict Resolution designs.

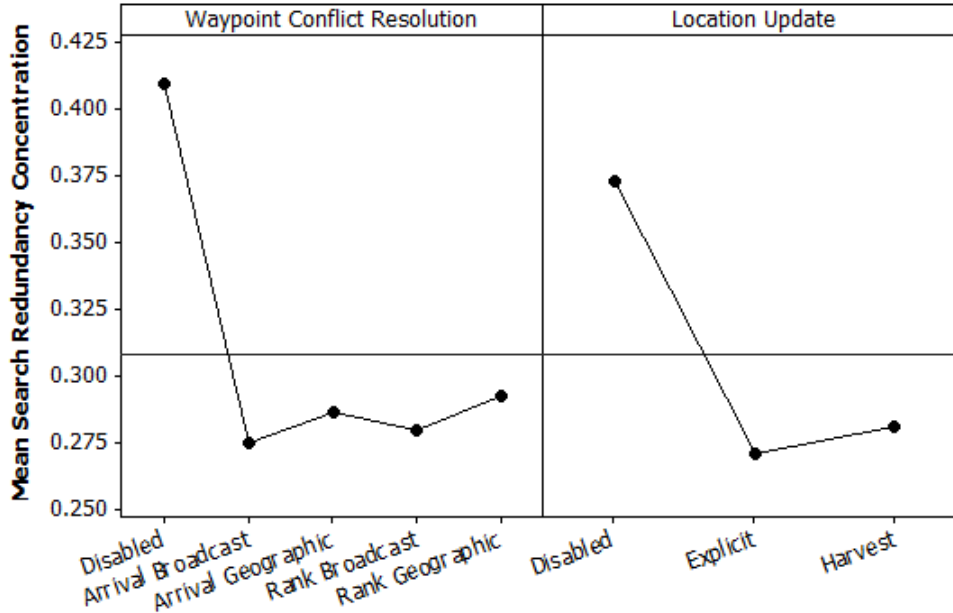
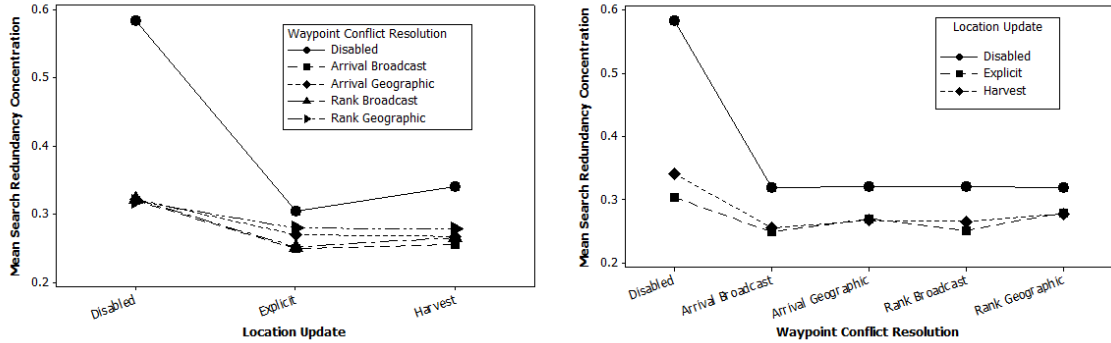

Figure 27: Search Redundancy Concentration main effects plot

The pairwise comparison also rejects the null hypothesis for all Location Update factor levels, so Figure 27 accurately reflects differences in means for Location Update levels. Both Location Update designs produce lower Search Redundancy Concentration compared to when Location Update is disabled. Explicit location updates lower Search Redundancy Concentration compared to GPSR harvesting (1.3% over the range of recorded values). The interaction plot in Figure 28(b) emphasizes that explicit updates gains most of its performance boost when Waypoint Conflict Resolution is disabled. When Waypoint Conflict Resolution is enabled, the differences between explicit updates and GPSR harvesting are negligible. Since Waypoint Conflict Resolution messages increase the frequency of Location Update messages (recall that waypoint reservations double as location updates), increasing

the frequency of updates may improve search performance while harvesting GPSR location data. Finally, Figure 28(a) shows performance differences between all Waypoint Conflict Resolution designs are negligible when Location Update is disabled.



(a) Waypoint Conflict Resolution versus Location Update (b) Location Update versus Waypoint Conflict Resolution

Figure 28: Search Redundancy Concentration interaction plots

Overall, the analysis of Search Redundancy Concentration shows that Waypoint Conflict Resolution and Location Update designs behave similarly when Waypoint Conflict Resolution is enabled. The performance differences between explicit updates and GPSR harvesting shown in the main effects plot occur when Waypoint Conflict Resolution is disabled as seen in the related interaction plot in Figure 28(a). Broadcast and geographic routing designs spread redundant searches equally well, and so Search Redundancy Concentration cannot be used as a discriminator when choosing between designs.

*4.3.5 Analysis of Cooperation Score and Search Redundancy.* Exploratory analysis with scatterplots found that Cooperation Score and Search Redundancy can be predicted with high confidence by Average Distance Traveled and Total Searches respectively. Figure 29(a) shows the positive linear relationship between Average Distance Traveled and Cooperation Score. Linear regression indicates  $Cooperation\ Score = -652 +$

0.913 *Average Distance Traveled* predicts Cooperation Score with 97.04% accuracy. Figure 29(b) shows the linear relationship between Search Redundancy and Total Searches. Since Search Redundancy derives its value from Total Searches and the cell count by definition, when cell count remains constant, Total Searches predicts Search Redundancy with 100% accuracy using  $Search\ Redundancy = \frac{1}{cell\ count} * Total\ Searches$ . These strong linear relationships make it unnecessary to analyze Cooperation Score and Search Redundancy separately from their respective predictors, since such analysis would produce the same results.

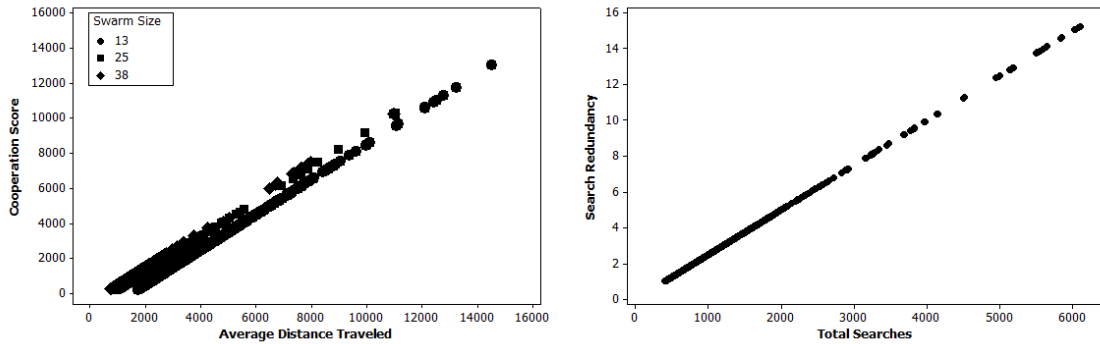

(a) Cooperation Score versus Average Distance Traveled

(b) Search Redundancy versus Total Searches

Figure 29: The positive linear relationships selected metrics

#### 4.4 Overall Analysis

The ANOVA tests reveal that Waypoint Conflict Resolution and Location Update contribute to variance with statistical significance for all performance metrics as either first or second order effects. In each case they are among the top contributors of variance as well. Transmission Power also strongly affects search performance for all metrics except Search Redundancy Concentration. Swarm Size affects Average Distance Traveled only.



The factors notably missing as top contributors of variance for any metric were Initial Location and Sensor Type.

Overall, broadcast Waypoint Conflict Resolution designs outperform geographic routing designs for Total Searches and Average Distance Traveled metrics, while the opposite is true for Average Direction Changes. The Expected Arrival Rule for Waypoint Conflict Resolution outperforms the Rank Rule for Total Searches, Average Distance Traveled and Average Direction Changes (geographic routing only). When Waypoint Conflict Resolution is enabled, none of the designs perform differently for Search Redundancy Concentration.

Transmission Power generally increases the performance effects of USMP features, though it has no effect on Search Redundancy Concentration and produces worse performance in Average Direction Changes. Transmission Power's magnification of USMP's effects fits expectations since Transmission Power controls how many UAVs can receive a USMP packet. The relationship with Average Direction Changes was unexpected and may indicate an unavoidable tradeoff between Average Direction Changes and Average Distance Traveled/Total Searches, or that limiting information in some way may improve search performance.

For Location Update, explicit updates perform better than GPSR harvesting for all metrics, but only by 3% to 6% in each case. The performance-improving effect of enabling Waypoint Conflict Resolution suggests that increasing update frequency for GPSR harvesting could close the performance gap between Location Update designs.

For all metrics, enabling Location Update or Waypoint Conflict Resolution at all improves search performance more than any other factor changes, though for Average Direction Changes enabling both worsens performance. Thus, Location Update and Waypoint

Conflict Resolution are positive features of USMP, and should be included in any future USMP design updates.

Sensor Type has little effect on search performance. It appears in most of the ANOVA models, but always accounts for less than 3% of the variation. The most probable explanation is that the Distance Rule negates the difference in active versus passive sensors by selecting mostly adjacent cells for each UAV's next waypoint. This effectively makes the active sensor behave like a passive sensor for most searches.

Initial Location also appears to have little effect on search performance, though analysis hints at a link between the amount of distance traveled per search and Initial Location. Initial Location and its higher order effects never account for more than 2.5% of variation in any model, and most effects account for less than 1% of variation.

#### **4.5 Summary**

This chapter discusses swarm logic and GPSR validation. Analysis of the search performance metric responses collected for the experiment is performed. Main effects and interactions are calculated to determine relative performance gains and losses between different factor levels. The next chapter considers the analysis of each metric to determine the best design for USMP.

## V. Conclusions and Recommendations

### 5.1 Overview

This chapter synthesizes the analysis of search performance data and draws conclusions about the UAV Search System and USMP design in Section 5.2. Section 5.3 explains the significance of this research. Section 5.4 recommends future areas of research, and Section 5.5 summarizes the chapter.

### 5.2 Conclusions

The experimental results reject the hypothesis that leveraging geographic routing for Waypoint Conflict Resolution improves search performance. Using geographic routing actually degrades search performance for Total Searches and Average Distance Traveled compared to broadcasting Waypoint Conflict Resolution messages. While geographic routing improves Average Direction Changes versus broadcast, Total Searches and Average Distance Traveled should dominate measures of search performance. Thus, USMP should simply broadcast Waypoint Conflict Resolution messages instead of geographically routing them.

The results also reject GPSR harvesting as a replacement for explicit location updates, though performance differs by only 3%-6% for each metric, and further experimentation may alter this conclusion. Experimental evidence suggests increasing update frequency could close the performance gap between Location Update designs. Since GPSR treats every data packet as a source of location updates, GPSR harvesting in a network with higher background traffic would likely rival or outperform explicit updates. At the very least, GPSR harvesting and explicit updates could be combined for greater performance.

For Waypoint Conflict Resolution, the results prove that the Expected Arrival Rule outperforms or matches the Rank Rule for every search metric, whether of broadcast or geographic routing is used. The Expected Arrival Rule should be used by Waypoint Conflict Resolution in USMP.

USMP has a definite positive effect on search performance. In all cases except Average Direction Changes, enabling Location Update and Waypoint Conflict Resolution improves search performance as demonstrated in Table 9. For Average Direction Changes enabling either Waypoint Conflict Resolution or Location Update, but not both, improves search performance. However, successful conflict resolutions often result in a direction change, so a rise in Average Direction Changes is required for any successful Waypoint Conflict Resolution feature. The main effects and interactions plots in Chapter IV clearly indicate that performance gains from enabling Location Update or Waypoint Conflict Resolution are at least twice the performance gains between any pair of different Waypoint Conflict Resolution or Location Update designs. The positive effect of USMP is magnified by increasing Transmission Power, so USMP implementations should increase Transmission Power as much as is feasible until every UAV can communicate directly with all other UAVs across the network, or interference begins reducing performance.

Table 9: Positive effect of USMP versus no inter-UAV communication

Metric	Improvement Versus No Communication	
	Location Update	Waypoint Conflict Resolution
Reciprocal Total Searches	188%	23.90%
Log Average Distance Traveled	8.30%	4.10%
Search Redundancy Concentration	23%	30.50%

### ***5.3 Significance of Research***

This research successfully developed a communications protocol for a swarm of searching UAVs. It is the first known protocol to have a positive effect on the search performance of the swarm logic used. The protocol brings the UAV Search System closer to real-world implementation since the system has been shown to operate successfully under realistic communication conditions.

Secondly, the UAV Search System's swarm logic and USMP are resilient to different sensor types and starting locations. Military operations require a high level of system flexibility, and this resilience shows that the system may be applied under a wide variety of UAV sensor configurations and operating conditions.

Finally, this research combines the search swarm logic with an existing implementation of GPSR. While Hyland's system combined a UAV swarm with GPSR, he replaced the swarm algorithm with a random waypoint mobility model [Hy107]. This work represents the first known example of combining a search mission swarm algorithm with a geographic routing protocol. The combination creates a simulation framework from which future research can use geographic routing as a search mission primitive in the swarm's communication protocol.

### ***5.4 Recommendations for Future Research***

The GPSR implementation used in this research assumes a perfect location service for forwarding packets. A production geographic routing algorithm would require a real location service. The location service could approximate a global search state for the swarm, which each UAV could query and update for improved search performance. The most promising

candidates include location services that view the search area in ways similar to how the swarm views it, such as the Grid Location Service [Li01].

While Waypoint Conflict Resolution packets should not be geographically addressed, future research could study the effect of geographically addressing search history packets to the location of the previous search. Research related to this area should also determine the effect of history packet frequency, and how to process the packets.

Previous research by Pack, York and Morris implemented an equation version of the swarm logic [PYT05] [YoP05] [Mor06]. The equation modified swarm behavior by replacing the Distance Rule with a rule based on the last time a cell was searched, and added a rule that accounted for distance from the search area border. The border rule counterbalances the Neighbor Rule's effect. Morris' implementation also limited possible waypoint selections to adjacent cells. Unfortunately, the search equation and the other changes mentioned above have not been shown equivalent to the original swarm logic. Future research could compare the equation's search performance against the ordered swarm logic rules. This research path should also examine ways to modify the Neighbor Rule by incorporating features from the equation version, or by limiting information supplied to the rule as suggested by the analysis of Average Direction Changes in Chapter III.

## ***5.5 Summary***

This chapter considers the analysis of search performance and presents conclusions about the UAV Search System and the design of USMP. It explains the significance of this research, and provides recommendations for future research.

## Appendix A. Implementation Details

### A.1 Overview

This appendix specifies implementation details used in the OPNET simulation of the UAV Search System.

### A.2 Node Models

UAV Search System simulation scenarios require two essential node models: the *uav\_manet\_station\_adv\_thesis* and *uav\_search\_observer*. The system requires instances of both node models to run a successful simulation. *uav\_manet\_station\_adv\_thesis* represents an individual UAV and takes the appearance seen in Figure 30(a). *uav\_search\_observer* calculates global statistics, keeps the global search state, animates global search state and determines when the simulation ends. Figure 30(b) shows the *uav\_search\_observer* icon. Depending on the version of OPNET in use, the node model may revert to a generic network node icon; this should not affect simulation results.

The *uav\_manet\_station\_adv\_thesis* model was originally based on the OPNET Standard Model *manet\_station\_adv* which is available when OPNET Modeler's Wireless Networking Suite is installed. Hyland customized the model with a geographic routing algorithm called

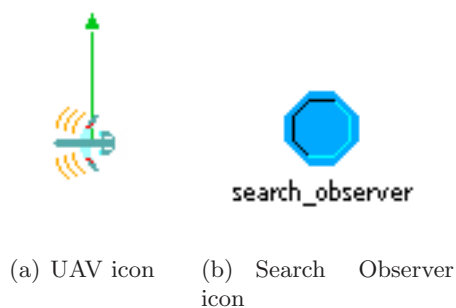

Figure 30: The two important simulation node models

GPSR in 2007 [Hyl07]. This thesis edited Hyland’s model to include a cooperative search feature. The search feature is based largely on the models provided by Morris in 2006 [Mor06]. This version of the model adds the *uav\_search*, *uav\_dispatcher* and *uav\_decision\_animator* process models and modifies the *gpsr\_rte* process model. Figure 31 shows how each process model fits into the overall node model. *gpsr\_rte* is not shown—it is a child process of *manet\_mgr*, which in-turn is declared a child process of *ip*.

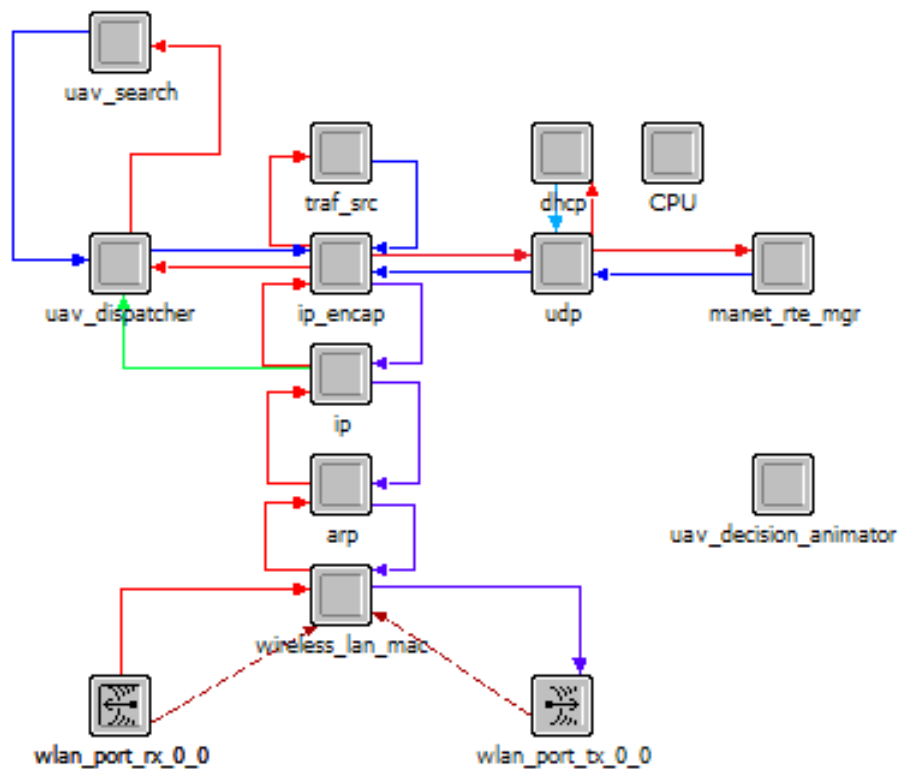

Figure 31: UAV node model

Unlike *uav\_manet\_station\_adv\_thesis*, *uav\_search\_observer* is a completely new node model. It contains only two processes as shown in Figure 32. *uav\_search\_observer* de-



pendents entirely on remote interrupts for communication. A single *uav\_search\_observer* named “search\_observer” must be placed inside the subnet containing the swarm. When the simulation begins, each UAV sends a remote interrupt to the Search Observer to request a UAV id. The observer then accesses the state of the calling UAV’s *uav\_search* process and sets the rank. Ranks start at 0 and increment by 1. During the simulation, UAVs notify the observer with remote interrupt location updates. The observer uses the interrupt information to update the global search state. When the global search state indicates that all cells have been searched at least one time, the observer writes its final statistics and ends the simulation.

### A.3 Process Models

The *uav\_search* process model implements the UAV Search System swarm logic and generates all USMP messages. *uav\_search* only sends packets to *uav\_dispatcher* which handles the details of registering USMP with the *ip* process, configuring interface control information structures (ICIs) for *ip\_encap*, receiving packets from the *ip* process and recording packet-related statistics. *uav\_search* does not know about any other processes in the node model except *uav\_dispatcher*. Outside of the node model, *uav\_search* communicates directly with the Search Observer to receive a UAV id (or rank) and report search actions. There



Figure 32: Search Observer node model

must be a node named “search\_observer” located in the same subnet as *uav\_search*’s parent node for *uav\_search* to successfully initialize.

The *uav\_dispatcher* process provides an interface to *uav\_search* for creating, sending and receiving packets through the *ip* process. The stream interrupt connecting the *ip* process to *uav\_dispatcher* delivers some search packets from *ip* directly to *uav\_dispatcher*. This occurs when *ip* receives an encapsulated USMP packet that is addressed to another UAV (i.e., this UAV will forward the packet). The KP `op_pk_deliver()` is used so that *ip\_encap* cannot alter the ICI and fields associated with the original packet. A separate packet stream is used so *uav\_dispatcher* can tell the difference between forced-delivery packets and ones coming from *ip\_encap*. This is useful when keeping separate statistics for forced-delivery packets versus packets addressed to the receiving UAV.

The *uav\_decision\_animator* process executes optional animation that can be toggled through node-level attributes. *uav\_decision\_animator* can animate a UAV’s flight path and local search state. At least one animation probe must reference *uav\_decision\_animator* or its parent for the animation to display.

The *gpsr\_rte* process is only instantiated when *manet\_mgr* detects that GPSR is selected as the ad hoc routing protocol. When *gpsr\_rte* is instantiated, it handles packets received from the network and from *uav\_dispatcher*. It generates its own location beacons and builds a neighbor list for greedy forwarding decisions. Successful use of *gpsr\_rte* requires editing certain header files in the OPNET standard library as Hyland instructs in Appendix C of his thesis [Hyl07]. *gpsr\_rte* is modified for this research in three ways. First, it now expects a “uav\_search\_pkt\_ici” to be attached to any packets from *uav\_dispatcher*. This special ICI enables geographic addressing by specifying a destination coordinate without

a destination network address. Secondly, *gpsr\_rte* listens for USMP packets and forwards them to *uav\_dispatcher* even if they are not addressed to the current UAV’s network address. Finally, each time *gpsr\_rte* adds a neighbor to its table, it remotely interrupts *uav\_search* with the new location information.

The processes contained in the Search Observer are less complex than those found in *uav\_manet\_station\_adv\_thesis*. The *uav\_observer\_animator* process produces the Search Observer’s animation. The *uav\_search\_observer* process (it uses the same name as its parent node model) implements all of the other Search Observer functionality. Both processes only communicate with remote interrupts.

#### A.4 *uav\_search Packet Format*

All USMP messages use the same basic format as seen in Figure 33. Every message is an LU message, so the *msg\_type*, *uav\_id*, *x\_pos*, *y\_pos* and *time\_stamp* fields are always used. If the message is a WR message, *x\_pos\_waypoint* and *y\_pos\_waypoint* are filled with the sender’s waypoint and *expected\_arrival* is filled with the sender’s expected arrival in simulation time at the waypoint. The last field is reserved for a search history feature that is still under development. If any field is unused (i.e., when an LU message is sent, the WR fields are unset), the simulation sets the unused fields to 0 bytes.

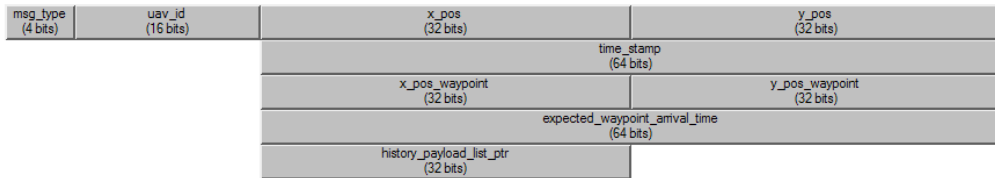

Figure 33: USMP packet format

### *A.5 Setting Up a New Scenario*

Setting up a new scenario requires the following steps:

1. Collect UAV Search System model files into one directory
2. Backup, then modify the standard OPNET library header files as outlined in Appendix C of Hyland’s thesis [Hyl07]
3. Add the directory with the model files as OPNET’s default model directory
4. Create new project, or open existing project
5. Create new scenario with scenario creation wizard
6. Select a campus-sized network, select meters as the unit of measurement and pick x/y span parameters so the network area forms a square
7. Rename the newly created subnet “search\_area”
8. Add a Search Observer (*uav\_search\_observer*) to the subnet and name the observer “search\_observer”
9. Add UAV nodes (*uav\_manet\_station\_adv\_thesis*) to subnet and ensure their trajectory attribute is set to “VECTOR”
10. Open the “Configure/Run” dialog box and set the x/y span parameters in the global attributes under both the “GPSR” and “uav\_boundary” attribute groups
11. Copy the resolution information from the background properties, and paste it into the “Resolution Size” global attribute
12. Finally, review the attributes in Table 10 and customize them for the desired scenario

Table 10: List of simulation attributes

Group	Attribute Name	Source Model	Global	Description
AD-HOC Routing Parameters	GPSR Parameters	manet_mgr	Y	The GPSR beacon interval and neighbor timeout settings.
animation	Animate Cell Values	uav_manet_station_adv_thesis	N	Places the number of searches and last time searched values on the animation window per the local UAV state.  Only one UAV should have this enabled at once.
animation	Animate Communication Range	uav_manet_station_adv_thesis	N	Draws a circle around a UAV to show its effective transmission range. This feature is still in development.
animation	Animate Flight Path	uav_manet_station_adv_thesis	N	Draws a line between the center points of cells that a UAV has searched. The line appears as soon as a UAV considers a new cell searched.
animation	Flight Path Color	uav_manet_station_adv_thesis	N	The color of the animated flight path.
animation	Flight Path Line Style	uav_manet_station_adv_thesis	N	Specifies the line style of the animated flight path.

animation	Use Local Animation	uav_manet_station_adv_thesis	N	General on/off switch for all animation generated by a single UAV.
GPSR	Beacon Start Time	gpsr_rte	Y	The time during the simulation that GPSR starts sending location beacons.
GPSR	Operational Area Length	gpsr_rte	Y	The one-sided length of the search area. This implementation of GPSR assumes a square grid. So if GPSR is used, $x_{max}==y_{max}==Operational\ Area\ Length$ must be true.
GPSR	Perimeter Routing Enabled	gpsr_rte	Y	Enable/disable perimeter mode.
None	anim_update	uav_search_observer	Y	How often search_observer updates any animation it produces.
None	Animate Cell Values	uav_search_observer	N	Animates the global state for each cell.
None	Resolution Size	uav_search_observer	Y	Used to determine animation placement. This changes for every new subnet or every change to the size of the subnet. Go to <i>View</i> → <i>Background</i> → <i>Set Properties</i> and copy/paste the resolution value to this attribute.
None	Use Observer Animation	uav_search_observer	N	General on/off switch for all animation generated by the search_observer.

uav	Begin Sending Updates	uav_search	Y	Still under development. Supposed to force uav_search to initialize after gpsr_rte.
uav	Final Score Calculation Method	uav_search	Y	Offers a choice between an ordered rule set and an equation version proposed by Morris and Pack (the "Product version"). Should always be set to "Ordered Rule" unless you understand how the other options work. The equation versions ignore the UAV rule lists.
uav	Force Shared State Waypoint Resolution	uav_search	Y	Prevents UAVs from selecting the same waypoint when using a shared state. ONLY USE THIS WHEN USING LOCAL STATE IS DISABLED.
uav	Force Travel at Right Angles	uav_search	Y	Forces UAV to "zig-zag" at right angles to get to diagonally located search cells. This option is required to reproduce the rectilinear movement assumption used in Pack and Mullins' original robotic swarm search experiment.
uav	Location Update Interval	uav_search	Y	How often uav_search interrupts itself to send an LU packet. This value is ignored when "Location Update Method" is set to anything besides "Explicit Updates."
uav	Location Update Method	uav_search	Y	The method of providing location updates to the UAV Search System.

uav	Mark Only Waypoint Cells As Searched	uav_search	Y	This is the sensor type parameter. If enabled, UAV will only mark waypoint cells as searched. If disabled, a uav will evaluate the "center quarter" search criterion for every cell it passes through.
uav	Reevaluate Waypoint on Location Updates	uav_search	Y	Under development. An original USMP feature that forced UAVs to reevaluate their current waypoint selection each time a new location update arrived. Cut because of time constraints.
uav	Rule List	uav_search	N	Formulates an ordered list of rules that each UAV executes during simulation. Rules are executed in the order specified. This attribute is often promoted to the simulation level so that all UAVs are guaranteed to run the same rule list. The rule list is ignored if the global attribute "Final Score Calculation Method" is set to anything except "Ordered Rule."



uav	Search  Radius	uav_search	Y	In development. The “Ordered Rule” calculation method ignores this and examines the entire map. The equation calculation methods use this to define how much of the map is examined. It is the radius (in cells) that the select_cell_to_search function will examine when selecting a cell. The examined cells are the ones whose grid coordinate matches the UAVs current grid coordinate x/y values + or - the range of 1 to the search radius. For example, if the current grid coordinate is (5,5) and search radius = 1, then the examined cells include (4,5) (5,4) (4,4) (6,5) (5,6) (6,6) (4,6) (6,4). The current cell is also considered if it has not yet been searched (e.g. when the simulation starts). Any cell coordinates that extend beyond the boundaries of the search area are ignored.
uav	uav_speed	uav_search	Y	How fast all UAVs travel.
uav	Use Local  Search State	uav_search	Y	If enabled, each UAV uses its own state to make search decisions. If disabled, all UAVs used the global search state maintained by the search_observer. Disable this to run simulations that assume perfect communication.
uav	Wait for  GPSR Init	uav_search	Y	Still under development. Supposed to force uav_search to initialize after gpsr_rte.

uav	Waypoint Arrival Check Interval	uav_search	Y	How often uav_search interrupts itself to determine if it has arrived at a waypoint, searched a cell or both. This should be carefully set in conjunction with "Waypoint Arrival Resolution" to avoid UAVs missing their waypoints.
uav	Waypoint Ar- rival Resolu- tion	uav_search	Y	The distance considered negligible in the simulation. Used to determine arrival at a waypoint. For example, if this attribute is set to 5.1m, arriving anywhere between 0 and 5.1m of the intended waypoint is considered a waypoint arrival. This value is also used in the Distance Rule to negate the effects of very small distance differences.
uav	Waypoint Conflict Resolution	uav_search	N	Setting that specifies the WR rule ("Handling Rule") and routing scheme ("Broadcast Method"). These values override the default rules in uav_dispatcher.
uav dispatcher	Force IP to Deliver All uav_search Packets	uav_dispatcher	Y	If enabled, forces GPSR to send all received uav_search packets to uav_dispatcher.
uav dispatcher	History Update Broadcast Method	uav_dispatcher	Y	The default routing/broadcast method if uav_search fails to specify a method.

uav dispatcher	Location  Update  Broadcast  Method	uav_dispatcher	Y	The default routing/broadcast method if uav_search fails to specify a method.
uav dispatcher	Waypoint  Update  Broadcast  Method	uav_dispatcher	Y	The default routing/broadcast method if uav_search fails to specify a method.
uav_boundary	x_max	uav_search	Y	The width of the subnet.
uav_boundary	y_max	uav_search	Y	The length (or height) of the subnet.
uav_cell	x_cell_num	uav_search	Y	The width of a search area grid row in cells.
uav_cell	y_cell_num	uav_search	Y	The height of a search area grid column in cells.
uav_rules	Number of  Searches  Weight	uav_search	Y	The specified weight used in the Number of Searches rule.
validation	Initial Bearing	uav_manet_station_adv_thesis	N	Used to set the initial bearing between 0 to 360 degrees. Different from setting the bearing using the default model attributes, since this is applied after initial node placement.
validation	Initial  History List	uav_search	N	Allows a UAV to start a simulation with a local search state different from the initialized state. Useful for validation.

validation	Initial Placement	uav_search	N	Determines if the UAV will be placed randomly in the subnet or if a cell index has been specified for a starting location. If a cell index is specified, the uav will start at the center coordinate.
validation	UAV Traffic Generation Parameters	uav_dispatcher	N	Explicit test traffic settings for geographically addressed packets.

## Appendix B. OPNET Workflow Tips

### B.1 Overview

This appendix covers basic tips and lessons learned while using Modeler.

### B.2 The Code Editor

The default Modeler code editor boasts little more functionality than Windows Notepad. It highlights OPNET-related syntax and accepts a line number parameter when launched from the list of compile errors. Any Modeler project over several hundred lines of code requires a more robust development environment. Fortunately, Modeler allows users to define an alternate code editor. Developers could use Microsoft Visual Studio (since Modeler for Windows currently requires the Microsoft C compiler anyway), or Notepad++ [not08].

Any code editor replacement should contain the following features for efficient management of non-trivial projects:

- Code Completion for OPNET Kernel Procedures (KP)
- Clickable Function List
- Text Search and Replacement
- Syntax Highlighting for C Code
- Command-line acceptance of a source code file name as parameter

Unfortunately, Modeler 12.0 does not pass the line number to any user-defined code editors. Also, Modeler apparently fails to recognize changes to source code until *the instance of the code editor where changes occurred* closes. Closing the edited source file alone is insufficient.

### ***B.3 Common OPNET Errors***

This section covers some common OPNET errors and how best to troubleshoot the error.

**Invalid Memory Access** Simulation executable tried to access null. To find the null reference without using a source debugger, run the simulation in the development kernel, turn on “fulltrace” in the OPNET debugger console and let the simulation run until the exception occurs. The function call directly before the error usually contains the null reference. Finally, use the source debugger to isolate the error. To troubleshoot future errors, good practice would check for null pointers and end the simulation with a descriptive error message. This isolates the simulation time, event number, KP, module and node.

**Binding Errors** By default, Modeler creates a compiled version of scenarios into “repositories” to avoid potentially expensive recompilation and linking. Repositories sometimes cause binding errors if development requires frequent changes to model code. To avoid binding errors related to repositories, select the “Ignore Repository Preferences” from the “Configure/Run” menu. Binding errors that persist after ignoring repository preferences may require changing the compiler flags.

**Abnormal Stack Imbalance** Indicates a stack-corrupting bug in the model code. Use external tools that auto-detect memory leaks.

### ***B.4 Distributed Simulations***

Distributed simulations allow a set of simulation runs to execute on different hosts. A single run begins and completes on the same host. A single host controls the distribution of

simulations and accepts messages concerning the progress of other simulations. Distributing a large simulation set sharply decreases overall execution time. However, research should avoid distributing simulations when execution time is less than one real-time second, or when statistics collection might overwhelm available shared storage.

Executing distributed simulations in Modeler 12.0, especially multiple simulations on a single multi-processor host, triggers a file access race condition when simulations execute for less than a second. The race condition causes random simulations listed in the DES Execution Manager to report 0 events and 0 events per second. Viewing the simulation messages reveals a recoverable file access error.

Distributed simulation run sets require access to shared project and model files. Modeler records each run's statistics in the same shared project directory. When each simulation run records a large set of statistic values (e.g., all values for vector statistics) the stored statistics may overrun the available shared space, causing the simulation set to crash. Avoid overrunning shared storage by using scalar statistics as described in Section B.6.2. Any crash of a distributed simulation may irrevocably corrupt project or scenario files. Backup any project and scenario files onto local storage before executing a distributed simulation. Reference Appendix D of Hyland's thesis for further directions on how to run distributed simulations [Hyl07].

### ***B.5 Version Control***

Modeler 14.0 offers a version control feature that allows developers to store model code on any Concurrent Versioning System (CVS) server. Modeler 12.0 offers no similar feature. If a CVS server is unavailable, or if using Modeler 12.0, write a script or batch file to back up

node and process models, and external C files daily. Back up copies of project and scenario files before any distributed simulation run, or large number of serial runs. Experience shows that a failed distributed simulation run can irrevocably corrupt project files.

## ***B.6 Statistics Collection***

*B.6.1 Adding and Changing Local Statistics.* Local statistics always start at the module (process or queue) level and propagate upwards. New statistic definitions include collection modes and other integral settings. Developers may then promote the same local statistic to the node level, or access it directly through a statistic probe via the advanced statistic selection screen. Once the developer promotes this value, or references it with a probe, however, subsequent changes to the local statistic definition *may not propagate to the node or probe levels*. Specifically, whatever collection mode that was set in the higher level probe or node will remain the same after changes to the local statistic definition. Not taking this into account greatly affects the perceived outcome of simulations.

*B.6.2 Size of Results.* The storage expense of collecting every value of each statistic may exceed the storage capacity of the simulation's host computer. Simulations should deposit large collections of data onto a local hard drive instead of common shared drives with user storage limits. Exceeding the storage limit on a drive will likely crash a long simulation mid-run. Use scalar statistics to avoid unnecessarily large data sets. Scalar statistics keep a single running value through the whole simulation. Alternatively, vector statistics collect multiple (potentially all values) of a statistic. If analysis requires multiple values, be sure to configure the collection mode to "bucket." Both the advanced and simple statistics selection screens allow access to scalar and vector attributes.



*B.6.3 Recording a Single Statistic Value for an Experiment.* Modeler statistics collection gives the impression that only multiple values can be collected during a simulation. If a particular model knows when the simulation will end (i.e., it decides to end the simulation), it can write to a statistic once and the results viewer will show that single value. Most of the time, models do not know when a simulation will end. In this case, the model should keep a variable value of the statistic and write to the registered statistic handle whenever the value changes. The associated statistic probe should be set to scalar value with a scalar type of “last value.” Thus, Modeler only keeps the single statistic value required.

*B.6.4 Exporting Data to a Spreadsheet.* This research required external statistics packages (i.e., Minitab) for analysis of simulation results. Modeler offers no automated export feature for data formats required by external packages. This situation requires an indirect workflow to get simulation data into the correct format. The workflow to export data is:

1. Run simulation and collect desired statistics
2. View the results
3. Click on the “DES Parametric Studies” tab
4. Select a statistic
5. Click on “Set as Y-Series” button (leave the X-series undefined)
6. Click the “Show” button
7. Select the next statistic and click “Set as Y-Series” button

8. Click on the “Add Button” then click on the original graph
9. Continue adding statistics to original graph
10. Right click on graph
11. From the resulting pop-up menu, select “Export Graph Data to Spreadsheet”

If the export procedure follows the above steps, a new window with the statistical data appears. Statistic names appear across the top row and Modeler will organize the data into columns. If the X-series was left blank, the far left column contains the experiment number. Minitab and other statistical packages find this data format acceptable (Microsoft Excel may also read this format).

### ***B.7 Animation***

Watching the animation of nodes in a simulation can validate node movement and communication. While the graphical debugger and the default movement animation in Modeler help, validation often requires customized animation aids. In this research, for example, UAVs display their previous flight path to prove that a optimal search pattern occurs in special situations. Unfortunately, Modeler’s mechanisms for presenting animation favor the expert user. Modeler’s 2-dimensional animation requires use of animation KPs as well as setup of animation probes. Additionally, any animation should scale to the size of the displayed network or subnet if the user wants to view useful animation.

Modeler documentation adequately covers the animation KPs, but skims the workflow necessary to view the animation. This subsection covers the basic use of animation probes to view custom animation. The basic workflow for creating custom animation is:

1. Open the probe editor
2. Define an animation probe
3. Use the window name from the animation probe to obtain a video display identification number (Anvid)
4. Call Modeler animation KPs with the Anvid as a parameter

To access the probe editor for the current project, open the advanced statistics menu. The easiest way to enable custom animation is to edit the existing automatic animation probe and give it a memorable window name. After saving the probe settings, use this window name and animation KPs to obtain an Anvid in model code. Any animation without an Anvid that references an active window name defined by an animation probe will not be displayed.

As a final warning, deselecting then reselecting “Record Node Movement 2D Animation for Subnet” resets the automatic animation probe settings. If using animation to validate scenarios, separate the validation scenarios from multiple run scenarios.

## Bibliography

- [AWD04] Mehran Abolhasan, Tadeusz Wysocki, and Eryk Dutkiewicz. “A review of routing protocols for mobile ad hoc networks”. *Ad Hoc Networks*, 2(1):1 – 22, 2004.
- [Bal07] Rusty Baldwin. Personal Interview, Jan 2007.
- [BT00] Eric Bonabeau and Guy Theraulaz. “Swarm Smarts”. *Sci Am*, 282(3):72–9, 2000.
- [CBD02] Tracy Camp, Jeff Boleng, and Vanessa Davies. “A survey of mobility models for ad hoc network research”. *Wireless Communications and Mobile Computing*, 2(5):483 – 502, 2002. Available from: <http://dx.doi.org/10.1002/wcm.72>.
- [Clo03] Bruce T. Clough. “Unmanned Aerial Vehicles: Autonomous Control Challenges, A Researchers Perspective”. In *2nd AIAA “Unmanned Unlimited” Systems, Technologies, and Operations*, San Diego, California, 2003. AIAA. AIAA 2003-6504.
- [CoM99] Scott Corson and Joseph Macker. Mobile Ad hoc Networking (MANET): Routing Protocol Performance Issues and Evaluation Considerations. RFC 2501 (Informational), January 1999. Available from: <http://www.ietf.org/rfc/rfc2501.txt>.
- [DoD07] Department of Defense (DoD). *Department of Defense Dictionary of Military and Associated Terms*. HQ DoD, 2001(As Amended Through 22 March 2007).
- [Dor06] Marco Dorigo. Ant colony optimization: Behavior of real ants. website, November 2006. Available from: <http://iridia.ulb.ac.be/~mdorigo/ACO/RealAnts.html> [cited 14 Jan 2008].
- [Gas05] Martin Gast. *802.11 Wireless Networks: The Definitive Guide*. O’Reilly Media, Inc., 2005.
- [Gra07] Scott Graham. Course Notes, Queuing Theory. unpublished, 2007.
- [GSB04] Paolo Gaudiano, Benjamin Shargel, Eric Bonabeau, and Bruce T. Clough. “Control of UAV Swarms: What the Bugs Can Teach Us”. *AIAA 3rd “Unmanned Unlimited” Technical Conference, Workshop and Exhibit*, 2004. AIAA 2003-6624.
- [HSR07] Mike Hinchey, Roy Sterritt, and Chris Rouff. “Swarms and Swarm Intelligence”. *Computer*, 40(4):111–113, 2007.
- [Hyl07] Matthew T. Hyland. *Performance Evaluation of Ad Hoc Routing Protocols in a Swarm of Autonomous Unmanned Aerial Vehicles*. Master’s thesis, Air Force Institute of Technology, 2007.
- [IEE03] IEEE Computer Society LAN MAN Standards Committee. “Wireless LAN Medium Access Control (MAC) and Physical Layer (PHY) Specifications”. *IEEE Std. 802.11-1999 (R2003)*, 2003.
- [Inf08] Information Sciences Institute. ns2 Official Website. website, 2008. Available from: <http://www.isi.edu/nsnam/ns/> [cited 13 Jan 2008].
- [JoP04] Leland Joe and Isaac Porche III. *Future Army Bandwidth Needs and Capabilities*. RAND Corporation, 2004.

- [KaK00] Brad Karp and H.T. Kung. “GPSR: Greedy Perimeter Stateless Routing for wireless networks”. *Proceedings of the Annual International Conference on Mobile Computing and Networking, MOBICOM*, pages 243 – 254, 2000. Available from: <http://dx.doi.org/10.1145/345910.345953>.
- [Li01] Jingyang Li. A scalable location service for geographic ad hoc routing. Master’s thesis, Massachusetts Institute of Technology, 2001. Available from: <http://hdl.handle.net/1721.1/38859>.
- [LTH02] Clement Larroque, Karl Thompson, and Duncan Hickman. “UAV sensor systems for close-range operations”. *Infrared and Passive Millimeter-wave Imaging Systems: Design, Analysis, Modeling, and Testing, Proceedings of SPIE*, 4719:124–133, 2002.
- [LWM06] Vincent Lenders, Jörg Wagner, and Martin May. “Analyzing the impact of mobility in ad hoc networks”. In *REALMAN ’06: Proceedings of the second international workshop on Multi-hop ad hoc networks: from theory to reality*, pages 39–46, New York, NY, USA, 2006. ACM Press.
- [MiA04] Susan J. Milton and Jesse C. Arnold. *Introduction to Probability and Statistics: Principles and Applications for Engineering and the Computing Sciences*. McGraw-Hill, Singapore, international edition, 2004.
- [MyH04] Jeffrey S. Myers and Edward Hildum. “NASA UAV Sensor Development: Works in Progress”. *AIAA 3rd “Unmanned Unlimited” Technical Conference, Workshop and Exhibit*, 2004. AIAA 2004-6419.
- [Mor06] Kevin M. Morris. *Performance Analysis Of A Cooperative Search Algorithm For Multiple Unmanned Aerial Vehicles Under Limited Communication Conditions*. Master’s thesis, Air Force Institute of Technology, 2006.
- [MWH01] Martin Mauve, Jörg Widmer, and Hannes Hartenstein. “A survey on position-based routing in mobile ad hoc networks”. *IEEE Network*, 15(6):30 – 39, 2001. Available from: <http://dx.doi.org/10.1109/65.967595>.
- [not08] Notepad++ project homepage. website, 2008. Available from: <http://notepad-plus.sourceforge.net> [cited 29 Jan 2008].
- [OSD05] Office of the Secretary of Defense (OSD). *Unmanned Aircraft Systems Roadmap 2005 to 2030*, August 2005. Available from: <http://www.acq.osd.mil/usd/Roadmap%20Final2.pdf>.
- [OPN08] OPNET Technologies. OPNET Website. website, 2008. Available from: <http://www.opnet.com> [cited 13 Jan 2008].
- [PaM03] Daniel J. Pack and Barry E. Mullins. “Toward Finding an Universal Search Algorithm for Swarm Robots”. *IEEE International Conference on Intelligent Robots and Systems*, 2:1945 – 1950, 2003.
- [PYT05] Daniel Pack, George York, and Gregory Toussaint. “Localizing mobile RF targets using multiple unmanned aerial vehicles with heterogeneous sensing capabilities”. volume 2005, pages 632 – 637, Tucson, AZ, United States, 2005. Available from: <http://dx.doi.org/10.1109/ICNSC.2005.1461264>.

- [RoF04] Frank Roberts and Ted Ferrazano. “Multiple Unmanned Aerial Vehicle (UAV) experimentation: Forward look”. *AIAA 3rd “Unmanned-Unlimited” Technical Conference, Workshop, and Exhibit*, 2004.
- [RaS02] Fred L. Ramsey and Daniel W. Schafer. *The Statistical Sleuth: A Course in Methods of Data Analysis*. Duxbury, Pacific Grove, Ca, 2nd edition, 2002.
- [SJK<sup>+</sup>03] Tapan Kumar Sarkar, Zhong Ji, Kyungjung Kim, Abdellatif Medouri, and Magdalena Salazar-Palma. “A Survey of Various Propagation Models for Mobile Communication”. *IEEE Antennas and Propagation Magazine*, 45(3):51 – 82, 2003. Available from: <http://dx.doi.org/10.1109/MAP.2003.1232163>.
- [SoK91] Theodore J. Socolofsky and Claudia J. Kale. TCP/IP tutorial. RFC 1180 (Informational), January 1991. Available from: <http://www.ietf.org/rfc/rfc1180.txt>.
- [Sun01] Jun-Zhao Sun. “Mobile Ad Hoc Networking: An Essential Technology for Pervasive Computing”. *Info-tech and Info-net, 2001. Proceedings. ICII 2001 - Beijing. 2001 International Conferences on. 316-321 vol.3*, 2001.
- [US 99] US Joint Forces Command. Dragon Eye Unmanned Aerial Vehicle. website, November 1999. Available from: <http://www.jfcom.mil/about/experiments/mc02/concepts/drageye.htm> [cited 14 Jan 2008].
- [US 06] US Army. *FMI 3-04.155*, April 2006. Available from: [http://www.uavforum.com/library/army\\_fmi3-04-155.pdf](http://www.uavforum.com/library/army_fmi3-04-155.pdf).
- [US 07a] US Air Force. Desert Hawk Small Unmanned Aircraft System Factsheet. website, November 2007. Available from: <http://www.af.mil/factsheets/factsheet.asp?id=10467> [cited 14 Jan 2008].
- [US 07b] US Air Force. RQ-11 Raven Small Unmanned Aircraft System Factsheet. website, October 2007. Available from: <http://www.af.mil/factsheets/factsheet.asp?id=10446> [cited 14 Jan 2008].
- [XuK04] Feng Xue and Panganamala R. Kumar. “The Number of Neighbors Needed for Connectivity of Wireless Networks”. *Wireless Networks*, 10(2):169 – 181, 2004. Available from: <http://dx.doi.org/10.1023/B:WINE.0000013081.09837.c0>.
- [YoP05] George York and Daniel Pack. “Comparative study on time-varying target localization methods using multiple unmanned aerial vehicles: Kalman estimation and triangulation techniques”. *2005 IEEE Networking, Sensing and Control, ICNSC2005 - Proceedings*, 2005:305 – 310, 2005. Available from: <http://dx.doi.org/10.1109/ICNSC.2005.1461206>.

# REPORT DOCUMENTATION PAGE

Form Approved  
OMB No. 0704-0188

The public reporting burden for this collection of information is estimated to average 1 hour per response, including the time for reviewing instructions, searching existing data sources, gathering and maintaining the data needed, and completing and reviewing the collection of information. Send comments regarding this burden estimate or any other aspect of this collection of information, including suggestions for reducing this burden to Department of Defense, Washington Headquarters Services, Directorate for Information Operations and Reports (0704-0188), 1215 Jefferson Davis Highway, Suite 1204, Arlington, VA 22202-4302. Respondents should be aware that notwithstanding any other provision of law, no person shall be subject to any penalty for failing to comply with a collection of information if it does not display a currently valid OMB control number. **PLEASE DO NOT RETURN YOUR FORM TO THE ABOVE ADDRESS.**

<b>1. REPORT DATE (DD-MM-YYYY)</b> 27-03-2008		<b>2. REPORT TYPE</b> Master's Thesis		<b>3. DATES COVERED (From — To)</b> Aug 2006 — Mar 2008	
<b>4. TITLE AND SUBTITLE</b>  A Novel Communications Protocol Using Geographic Routing for Swarming UAVs Performing a Search Mission				<b>5a. CONTRACT NUMBER</b>	
				<b>5b. GRANT NUMBER</b>	
				<b>5c. PROGRAM ELEMENT NUMBER</b>	
<b>6. AUTHOR(S)</b>  Robert Lidowski, Capt, USAF				<b>5d. PROJECT NUMBER</b>	
				<b>5e. TASK NUMBER</b>	
				<b>5f. WORK UNIT NUMBER</b>	
<b>7. PERFORMING ORGANIZATION NAME(S) AND ADDRESS(ES)</b> Air Force Institute of Technology Graduate School of Engineering and Management 2950 Hobson Way WPAFB OH 45433-7765				<b>8. PERFORMING ORGANIZATION REPORT NUMBER</b>  AFIT/GCS/ENG/08-14	
<b>9. SPONSORING / MONITORING AGENCY NAME(S) AND ADDRESS(ES)</b> United States Air Force Academy, UAV Research Group Contact: Daniel Pack, Ph.D. Mailing Address: USAFA/DFEC, 2354 Fairchild Drive, Suite 2F6 USAF Academy, Colorado Springs, CO 80840 Phone: (719) 333-6967 DSN: 333-6967 Fax: (719) 333-3756 e-mail: daniel.pack@usafa.edu				<b>10. SPONSOR/MONITOR'S ACRONYM(S)</b>	
				<b>11. SPONSOR/MONITOR'S REPORT NUMBER(S)</b>	
<b>12. DISTRIBUTION / AVAILABILITY STATEMENT</b>  APPROVED FOR PUBLIC RELEASE; DISTRIBUTION UNLIMITED.					
<b>13. SUPPLEMENTARY NOTES</b>					
<b>14. ABSTRACT</b> This research develops the UAV Search Mission Protocol (USMP) for swarming UAVs and determines the protocol's effect on search mission performance. It is hypothesized that geographically routing USMP messages improves search performance by providing geography-dependent data to locations where it impacts search decisions. It is also proposed that the swarm can use data collected by the geographic routing protocol to accurately determine UAV locations and avoid sending explicit location updates. The hypothesis is tested by developing several USMP designs that are combined with the Greedy Perimeter Stateless Routing (GPSR) protocol and a search mission swarm logic into a single network simulation. The test designs use various transmission power levels, sensor types and swarm sizes. The simulation collects performance metrics for each scenario, including measures of distance traveled, UAV direction changes, number of searches and search concentration. USMP significantly improves mission performance over scenarios without inter-UAV communication. However, protocol designs that simply broadcast messages improve search performance by 83% in total searches and 20% in distance traveled compared to geographic routing candidates. Additionally, sending explicit location updates generates 3%-6% better performance per metric versus harvesting GPSR's location information.					
<b>15. SUBJECT TERMS</b>  Computer Networks, Communication protocols, Wireless communications, Performance analysis, Swarming					
<b>16. SECURITY CLASSIFICATION OF:</b>			<b>17. LIMITATION OF ABSTRACT</b>	<b>18. NUMBER OF PAGES</b>	<b>19a. NAME OF RESPONSIBLE PERSON</b>
<b>a. REPORT</b>	<b>b. ABSTRACT</b>	<b>c. THIS PAGE</b>			Barry E. Mullins, Ph. D. (ENG)
U	U	U	UU	126	<b>19b. TELEPHONE NUMBER (include area code)</b> (937) 255-3636, ext 4916/barry.mullins@aft.edu