

A Product Lifecycle Management methodology for supporting knowledge reuse in the Consumer Packaged Goods domain

Original

A Product Lifecycle Management methodology for supporting knowledge reuse in the Consumer Packaged Goods domain / Vezzetti, Enrico; Moos, Sandro; Kretly, S.. - In: COMPUTER AIDED DESIGN. - ISSN 0010-4485. - (2011). [10.1016/j.cad.2011.06.025]

Availability:

This version is available at: 11583/2429999 since: 2016-02-12T14:57:45Z

Publisher:

Elsevier

Published

DOI:10.1016/j.cad.2011.06.025

Terms of use:

openAccess

This article is made available under terms and conditions as specified in the corresponding bibliographic description in the repository

Publisher copyright

(Article begins on next page)

A PLM strategy for supporting knowledge reuse in the Consumer Packaged Goods domain

Enrico Vezzetti ^a, Sandro Moos ^a, Simona Kretli ^b

^a *Dipartimento di Sistemi di Produzione ed Economia dell'Azienda, Politecnico di Torino, Corso Duca degli Abruzzi 24, Torino, 10129, Italy
(enrico.vezzetti@polito.it)*

^b *Department of Science, Università degli Studi "G.D'Annunzio" Chieti-Pescara, Viale Pindaro 42, Pescara, 65127, Italy
(kretli@sci.unich.it)*

Abstract: The present globalised market is forcing many companies to invest in new strategies and tools for supporting knowledge management. This aspect is becoming a key factor in the industrial competitiveness for the presence of extended enterprises that normally deal with huge data exchange and share processes. This scenario is due to the presence of partners, geographically distributed over the entire globe, that participate, in different steps of the product lifecycle, to product development, maintenance and recycling. At present Product Lifecycle Management (PLM) seems to be the right solution for supporting enterprises in this complex scenario, even if a real standardised approach for the implementation of knowledge sharing and management tools doesn't exist. For this reason the aim of this paper is to develop a knowledge management strategy able to support the formalisation and the reuse of the enterprise expertise acquired working on previous products. Focusing the attention on consumer packaged goods enterprises the strategy has developed a systematic a methodology integrating the Quality Function Deployment (QFD) and the Teoriya Resheniya Izobreatatelskikh Zadatch (TRIZ) for supporting the knowledge codification and management. A case of study, with the intent to solve the problem of waste disposal, has been conducted to validate the proposed methodology.

Keywords: PLM, QFD, TRIZ, knowledge sharing, waste disposal

1. Introduction

PLM is the acronym of Product Lifecycle Management: it is the process of managing the entire product lifecycle through all phases of its life: conception, design, manufacture, use and disposal [1]. PLM integrates people, data, process and business system and provides a product information to all organization sectors. Its aim is to promote the knowledge sharing among all organization sectors and members, so that anyone, with specific keys, can access to data base information, which cover the lifecycle of the product. To store the product information into the PLM data base, it is necessary to adopt a common and simple semantics for the subsequent search, access and reuse purposes.

According with G. Schuh et al. [2] there are seven key elements of the PLM definition (Fig. 1). In the technical literature the approach of PLM have multiple perspectives, vary within method and process specification for partial PLM aspects to detailed technical issues at software integration level.

At the methods and process level, Schuh et al. [3] position the product structure as a core discipline of PLM, as it structurally connects the modules, items and information of a product. Eigner and Stelzer [4] consider the management of the product configuration over the entire lifecycle as an integral part of PLM. Xu et al. [5] emphasize the cost tracking and analysis associated with each phase of the product lifecycle.

Other authors also apply the lifecycle perspective in order to analyse the environmental impact of products [6]. At the technical software integration level, McKay et al. [7] presents a product specification data model to support the transition between product requirements to design at early development stages. Eynard et al. [8] explore the advantages of using an object-oriented approach and UML diagrams to specify the product structure and workflows for a PDM implementation. Aziz et al. [9] analyse the application of open standard, open source, and peer-to-peer solutions to support collaboration in product development considering a PLM context. Kiritsis et al. [10] describe the potential of smart embedded systems to collect product data during its use in order to close the lifecycle information loop.

The new products need to simplify the ideas generation process, so to better exploit the product portfolio of the enterprise, integrating the ideas evaluation, the knowledge of implemented and completed projects and the planning capacity. In this way the company is able to rapidly reply to market shifts and to contain the development costs of product.

Focusing the attention on the Consumer Packaged Goods (CPG) Industry, it is necessary to emphasize that the product concept should not only consider the content but also the packaging, which definitely concour to the overall

product cost, by its own cost and for the transport of its weight. For example [11], the packaging costs of the jar which contains beans is about 26% of the industrial selling price, for a tomato sauce bottle of 700 gr. it can reach to 25%, for the fruit juice in brick the 20% and for milk in plastic bottle it is above 10%. Packaging represents a significant portion of a product's selling price also in other market sectors. For example [12], in the Cosmetics Industry the packaging cost of some products may be as high as 40% of the product's selling price.



Figure 1. Product Lifecycle Management (PLM) Elements

The environmental aspect is also very important: today the food sector is the most responsible for the production of packaging waste. The 94/62/EC Directive [13], on packaging and packaging waste, states clear specifications on the fundamental aspect of packaging environmental impact. The rules concern the prevention of packaging waste, the packaging reuse, the recycling and other forms of recovering for the volume reduction in the final disposal phase. For the reuse and recycling purpose, systems must be set up to guarantee and monitor the return of used packaging and packaging waste; life-cycle assessments should be completed to define reusable, recyclable and recoverable packaging categories. The Annex II specifies the requirements of packaging relatively to manufacturing, composition, reusability and recoverability. Packaging ought to be designed to limit its volume and weight, still maintaining the adequate level of safety and hygiene. It ought to be designed and commercialized so to permit its reuse, recover or recycle, with limited noxious or hazardous substances. For the reusability, it is required that the packaging physical properties and characteristics allow a number of trips or rotations in normal use conditions. It must be manufactured to allow the recycling of a certain percentage by weight of its component materials. The packaging waste destined to energy recovery process ought to have a minimum inferior calorific value, while the biodegradable packaging waste ought to be able of undergoing physical, chemical, thermal or biological decomposition such that it ultimately decomposes into carbon dioxide, biomass and water.

So, the main packaging function is to guarantee the product safety and conservation during the logistic process and it's also important for the shipping, storing, piling, loading and unloading operations, it must be suitable for recycling. Moreover, the packaging is the most important factor that influence the customer's purchase process: a correct product identification, a beguiling aspect and a good market appeal are decisive for the customer's choices [14], [15]. One operative way to cut down the packaging development costs is to reuse the knowledge and the data relative at previous projects, where is possible, e.g. where the product has the same characteristics or the same final use. The firms that have previously invested in ERP system shall encourage the use and the development of PLM system, product-oriented, in order to develop a packaging in an innovative way.

In many companies, indeed, it is habitual to design the packaging ex-novo or to outsource the design and the production to external supplier. A new trend may be, precisely, to exploit the knowledge and experiences relating to existing packaging in order to develop new products inside the product holding enterprise. In this instance is essential the aid of the information technologies and in particular way the PLM approach. In the technical literature the research papers deal with vertical applications, none of them addresses the problem of formalizing the sharing of knowledge.

2. The proposed methodology

This paper proposes a methodology for supporting product innovation design in the consumer packaged goods, through PLM philosophy, combining Quality Function Design approach (QFD) [16], which is necessary for system requirements codification, with the Teoriya Resheniya Izobreatatelskikh Zadatch (TRIZ) methodology [17], which is used to define a common semantic in the product development process that allow the comparison of the currently developing product features with those available in the enterprise knowledge and expertise.

The methodology starts (Fig. 2) from the evidence that the development of a product begins when the market stakeholders show new needs. As a consequence of this, it is necessary to collect as more needs as possible in order to

have a clear idea of the market scenario for succeeding in accomplish all of them through the identification of the right product in the right moment. When collected and elaborated, the stakeholders needs are converted in technical specifications, as first description of the new product.

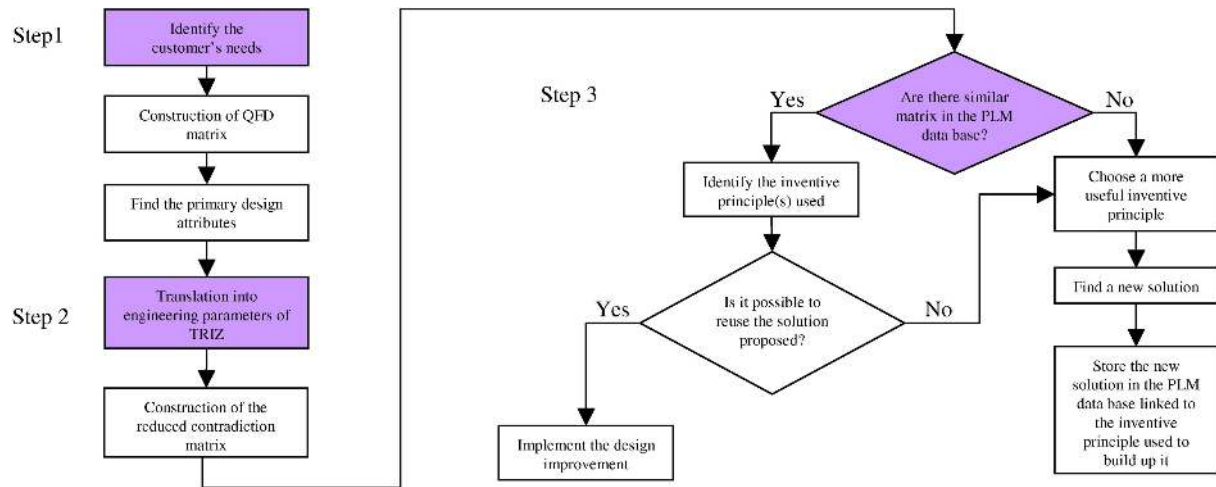

Figure 2. Proposed Methodology Flowchart

The customer needs codification in technical specification represents one of the key factor for the product development, and QFD represents one of the best tools for its implementation. Unfortunately, working only with the QFD approach, every engineering and technicians involved in this codification employ his own semantic, based on his experience. This represents a problem when this experience would be reused. Working only with the QFD it is possible to work on a product with design problems similar to other previously faced, without understanding the situation only because it has been described using a different semantic, instead of using a common one developed in the company.

To reduce the problem, the designers need to acquire a certain experience and consequently the non formal company knowledge, “by doing”. The problem is clearly critical when a new member of the product development team is involved in the project and ignores any previous experiences. For this reason it is necessary to define a common language that could be used for storing previous experiences, and so the company knowledge. Using a unique formalisation language, it will be more simple to retrieve the previous experiences and this formalisation will also allow the reuse of the company knowledge.

In order to fulfil this aim the methodology proposed integrate the TRIZ methodology for introducing a common formalisation language and to support the company knowledge reuse. The TRIZ method provides 39 engineering parameters for describing the products (speed, weight, measurements accuracy, ...), divided in three categories that include: physical and geometric parameters, negative parameters independent by technique, positive parameters independent by technique, which are used to translate all the QFD technical specification (Fig.3).

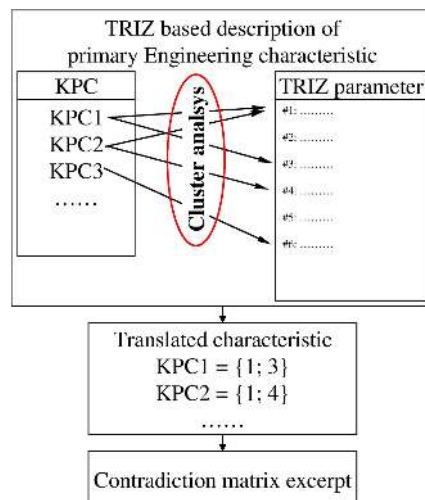

Figure 3. QFD Technical Specification translation in TRIZ variable

Using the QFD correlation matrix and its roof, it is possible to understand which technical specifications are directly correlated, so increasing one also the other will increase, and which others are inversely correlated, and which of them should be maximised and which one should be minimised. As a consequence of this, the method provides a set of TRIZ variables in contradiction. Instead of using the complete contradiction TRIZ matrix (39 x 39), it's introduced a reduced one, composed only by those involved in the semantic translation process. Not all the TRIZ variable could be useful for the enterprise' specific product task, for example the TRIZ parameters speed (9) and power (21) are not compatible with the food and beverage packaging characteristics. For this it is employed a reduced contradiction matrix.

As the 39 x 39 matrix is structured with a first column and a first row where the 39 engineering variables are located, also the reduced one presents the involved TRIZ variable in the first row and in the first column and one or more of the 40 inventive principles in the other cells. Those inventive principles were got analysing breakthrough international patents by TRIZ developers. Looking at these inventive principles it will be possible to identify one physical suitable to the product development process. The translation from QFD specifications to TRIZ variables is performed using a cluster analysis approach [18]. So, looking at which variables need opposite physical principles, the reduced contradiction matrix principles are analysed and a physical principle is studied. At this stage three possible scenarios could happen (Tab.1).

| TASKS | Scenario 1: Product Knowledge Reuse | Scenario 2: Physical Principle Reuse | Scenario 3: New Domain Problem |
|--|---|--|--|
| Control 1: In this step the methodology verifies if a similar product development scenario has been analysed in the past | There is a similar contradiction matrix already stored | There is no similar contradiction matrixes already stored | There is no contradiction matrixes already stored |
| Control 2: In this step the methodology verifies if a similar variable conflict happened in the past and which physical principle has been used | | There is some physical principles stored together with the inventive principles | There is no physical principle stored together with the inventive principles |
| | | | |
| SOLUTION | <i>The contradiction scenario has been already analyzed working on a previous product. It is possible to use all the physical principles already employed</i> | <i>The already stored physical principle are checked in order to verify if they fit the present contradiction. If they fit the principle is adopted, otherwise another is developed and stored</i> | <i>A new physical principle is proposed and after its validation, is stored in the company Data Base</i> |

Table 1. Proposed Methodology Scenarios

In the first scenario, the proposed methodology has been already employed for previous projects and consequently a certain number of reduced contradiction matrixes have been stored and a certain number of physical principles have been integrated with the inventive principles (figure 4x). In this situation, the designers define the reduced contradiction matrix of the new development product and this will be compared, with all the other already stored in the company database. If the comparison shows a difference lower than 10% the two matrixes are considered similar so the product development scenario that have been already faced and the previous product experience could be fully employed.

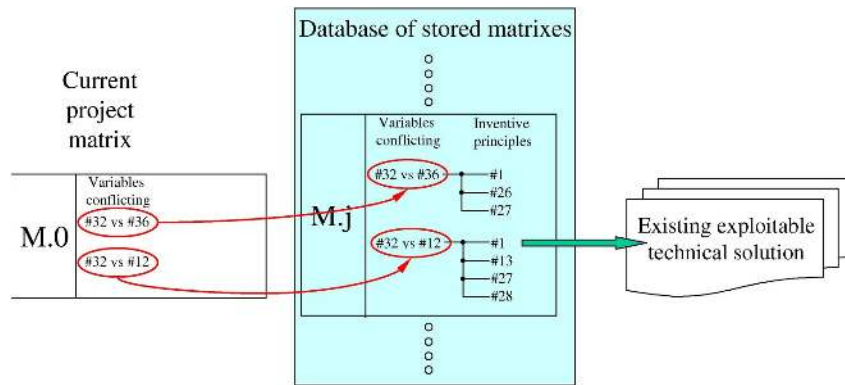

Figure 4x: Knowledge recovery from the enterprise PLM database when a similar matrix is found

In the second scenario, when similar conflict matrixes are not found in the database, it is necessary to work on a lower level, because it means that another similar product development scenario has not been analysed (figure 4y). So the comparison moves to the single inventive principles of the new reduced inventive matrix and the methodology proposes to verify if there is also a correspondent physical principle that could fit with the present variable conflict.

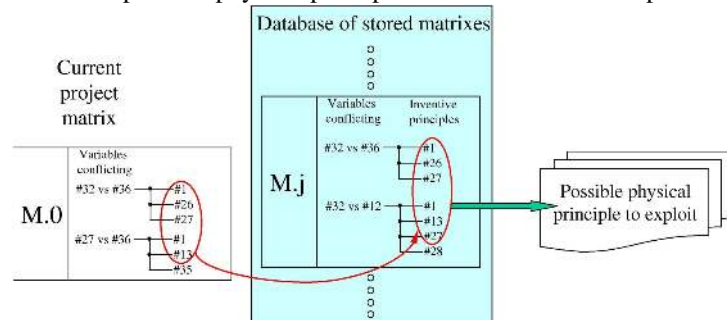

Figure 4y: Knowledge recovery from the enterprise PLM database, based on the inventive principles, when a full correspondence is not found

In the last scenario, no similar reduced conflict matrixes have been found and no fitting physical principles have been identified analysing the single inventive principles (figure 4z). This situation could occur when the company is working on a new domain or if the proposed methodology is employed for the first time. A new physical principle is proposed and if it solves the contradiction, and is accepted by the team, it will be stored together with the inventive principle.

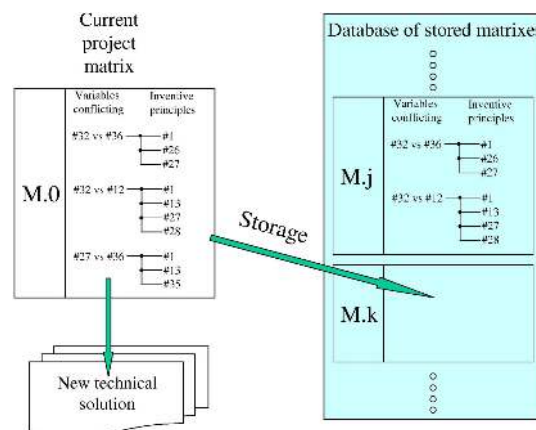

Figure 4z: Development of a new solution and storage of the matrix in the enterprise PLM database

With this methodology it is possible to store, organize and share the company knowledge, avoiding competence loss, and it's possible to make it available for searching and re-utilizing in future products, accordingly to the PLM basis. The key search will be the reduced matrixes arising from the TRIZ application, which provides a common semantics available to all the product characteristics. Moreover introducing this TRIZ translation QFD

Technical specifications (KPCs), specific of the designer and of the project, are moved to an higher level providing a more flexible behaviour that could be adapted to any product development typology.

3. Case of study

In order to understand the efficacy of the proposed methodology in the consumer packaged goods, it's proposed a new packaging solution in which waste materials are easy to dispose of, accordingly to the design for environment principles, so extending the enterprise design objectives to the end of the product's life.

This experimental validation moves in the scenario 3, so it is assumed that this kind of problem was never dealt with before in the enterprise, so it will not be possible to find a former similar contradiction matrix. This new problem can be solved using the TRIZ methodology and the results stored into PLM database for future reuse.

Many food and beverage packaging are very often made of poly laminate material (for milk, fruit juices, wine, soup and other liquid food), which is usually composed by aluminium alloy series 1000 (5%), polyethylene (20%) and paper (75%). The percentage of waste poly laminate package is continuously increasing in municipal solid waste. In 2007 more of 137 billion of poly laminate package were produced and used around the world [18].

The customers were proposed a questionnaire where they described freely their most important product attributes. The free answers were reworded considering similar statements of different users and then the reworded proposition were again subjected to the customers group which assigned a score on a scale form 1 to 5 to each of them. Figure 4 shows the resulting customer requirements list, of 11 entries and the corresponding importance values.

Design experts of packaging enterprises were asked to identify the package design attributes corresponding to the given customer requirements list and they also defined the weights of the relationship matrix.

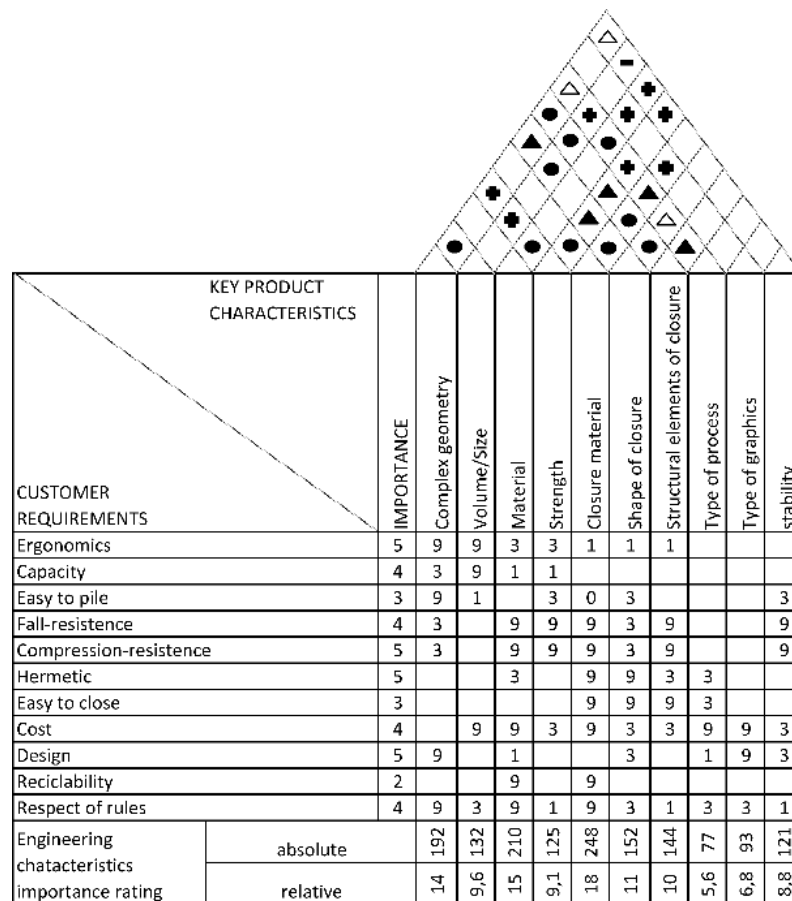

Figure 4: The House of Quality for the case of study

In the case of study, the last 2 rows of the QFD matrix show the importance ratings of the engineering characteristics. The main design attributes of packaging are: seal material, package material, geometry, seal shape and seal structural elements. It is clear how the most important issues are the material of the container and seal.

Starting from the TRIZ parameters that describe the package (container) material are: complexity (36), strength (14), durability of non moving object (16), ease to manufacture (32). In table 2 the reduced conflict matrix, relative to the issue of container material, is shown.

| | 14 | 16 | 32 | 36 |
|----|--------------|--------|----|---------------|
| 14 | - | | | 2, 13, 25, 28 |
| 16 | | - | | |
| 32 | 1, 3, 10, 32 | 35, 16 | - | 27, 26, 1 |
| 36 | 2, 13, 28 | | | - |

Table 2. The reduced conflict matrix. In the cells are listed the TRIZ inventive principles that can be applied to solve the contradictions.

The engineering parameters in conflict for the container material are "#32, ease to manufacturing" and "#36, device complexity". The feature to improve is the material eco-compatibility in row #32: "Ease to manufacturing" and the undesirable secondary effect is poly laminate material in column #36, "Device complexity". The intersecting cell in the Table of Contradictions suggests to use the inventive principles #27, 26, and #1 to solve the problem. Those principles are to be analysed to see if and how can be applied to the current problem.

The useful inventive Principle #1 is "Segmentation":

- a. Divide an object into independent parts
- b. Make an object sectional
- c. Increase the degree of an object's segmentation

The solution could be to divide the container in two independent parts: and external paperboard box and an internal aluminium bag. The external paperboard guarantees the required strength for the package handling while the internal bag guarantees the correct preservation of content.

It is important that the new packaging characteristic are the same of the poly laminate packaging: the internal bag must satisfy to the requirements of "Ease to fill". The TRIZ engineering parameters that characterize this requirement are: length of stationary (4), area of stationary (6), stability of the object (13), shape (12), ease to manufacture (32). The table 3 proposes the reduced conflict matrix relative of the issue of the internal bag.

| | 4 | 6 | 12 | 13 | 32 |
|----|------------------|------------------|------------------|-----------------|------------------|
| 4 | | 17, 7, 10, 40 | 13, 14, 15, 7 | 39, 37, 35 | 15, 17, 27 |
| 6 | 26, 7, 9, 39 | | | 2, 38 | 40, 16 |
| 12 | 13, 14, 10, 7 | | | 33, 1, 18, 4 | 1, 32, 17, 28 |
| 13 | 37 | 39 | 22, 1, 18, 4 | | 35, 19 |
| 32 | 15, 17, 27 | 16, 40 | 1, 28, 13, 27 | 11, 13, 1 | |

Table 3. The reduced conflict matrix.

The engineering parameters in conflict in the case of the internal bag are #32 "Ease to manufacturing", #12 "Shape" and #13 "Stability of the object". The feature to improve in the first conflict is the simplicity of production #32 and the undesirable secondary effect is a shape that is not simple to fill #12. Looking these up on the Table of Contradictions, the principles 1, 28, 13 and 27 can be found in the intersecting cell. The useful inventive Principle is #28 "Mechanics substitution":

- a. Replace a mechanical means with a sensory (optical, acoustic, taste or smell) means.
- b. Use electric, magnetic and electromagnetic fields to interact with the object.
- c. Change from static to movable fields, from unstructured fields to those having structure.
- d. Use fields in conjunction with field-activated (e.g. ferromagnetic) particles.

The solution may be create a mobile canal for filling the internal bag.

The feature to improve in the second conflict is the stability during the filling #13 "Stability of the object" and the undesirable secondary effect is a shape that is not simple to fill #12 "Shape". Looking these up on the Table of Contradictions, it's possible to identify the principles 22, 1, 18 and 4. The useful inventive Principle is again #1, "Segmentation" and the solution may be to divide the internal bag in four pieces to make it more stable. An example is showed in the figure 5. The 4 patches welded together provide more stiffness of the bag walls. The bottom is shaped like a plane so to obtain a large support surface. The approximatively square section of the bag will fit well into a

parallelepipedal cardboard box which will also provide additional support for the bag walls. Those contributes to the stability of the object once filled.



Figure 5. The possible shape of internal bag.

It is necessary to design a suitable sealing. The engineering parameters that describe a suitable sealing are: length of stationary (4), area of stationary (6), shape (12), stability of the object (13), reliability (27), ease to manufacture (32), device complexity (36). Table 4 proposes the reduced conflict matrix relative of the issue of the seal.

| | 4 | 6 | 12 | 13 | 32 | 36 |
|-----------|------------------|------------------|------------------|-----------------|------------------|------------------|
| 4 | | 17, 7, 10, 40 | 13, 14, 15, 7 | 39, 37, 35 | 15, 17, 27 | 1, 26 |
| 6 | 26, 7, 9, 39 | | | 2, 38 | 40, 16 | 1, 18, 36 |
| 12 | 13, 14, 10, 7 | | | 33, 1, 18, 4 | 1, 32, 17, 28 | 16, 29, 1, 28 |
| 13 | 37 | 39 | 22, 1, 18, 4 | | 35, 19 | |
| 32 | 15,17, 27 | 16, 40 | 1, 28, 13, 27 | 11, 13, 1 | | 27,26,1 |
| 36 | 26 | 6, 36 | 15,37,1,8 | | 26, 27, 1, 13 | |

Table 4. The reduced conflict matrix.

The conflicts with the features to improve and the undesired secondary effects are: the reliability against the complexity of the closure, the facility of manufacture against the device complexity and the stability and the possibility to reuse the closure against the complexity in the production. The TRIZ matrix proposes the following principles to solve the contradiction between improving #27 “Reliability” without the secondary effect of #36 “Device complexity”. The suggested principles are:

#13 “The other way round”:

- a. Invert the action(s) used to solve the problem (e.g. instead of cooling an object, heat it).
- b. Make movable parts (or the external environment) fixed, and fixed parts movable.
- c. Turn the object (or process) 'upside down'.

#35 “Parameter changes”:

- a. Change an object's physical state (e.g. to a gas, liquid, or solid.)
- b. Change the concentration or consistency.
- c. Change the degree of flexibility.
- d. Change the temperature.

and #1, “Segmentation”. Based on these inventive principles a possible solution of the conflicts is to segment the seal thereby to manufacture the seal of the internal bag separately from the closure of the container, using a different recyclable material. A possible solution is to use a clip similar the one showed in the figure 6 for sealing the internal bag.



Figure 6. A bag clip.

The last problem is the container closure, it must be functional and easy to use, once people opened the container, the bag closure must be accessible and the liquid inside must be easy to pour. According with TRIZ inventive principles the solution proposed is to create a movable paperboard canal linked with the bag clip.

According to the results of the methodology application, a possible solution to the waste disposal problem which eliminates the poly laminate packaging, is to manufacture the packaging in two different main parts: external paperboard container and internal aluminium bag. Figure 7 shows the net of the paperboard container, figure 8 the bag model and figure 9 explains the new packaging functioning. This can be summarized as follow:

- a. The beverage producer opens the paperboard container and
- b. places the aluminium bag into the open container, ready for filling.
- c. Once the bag is filled, it is sealed with the plastic clip, then
- d. the paperboard container is closed and it's handled, stocked and transported to the shop.
- e. The customer opens a smaller lid in the top surface of the container, extracts the bag neck, removes the plastic clip and pours the content. To seal again the bag it suffice to reclip it.

The container parallelepipedal shape also satisfies the requirements of ergonomics and ease to pile.

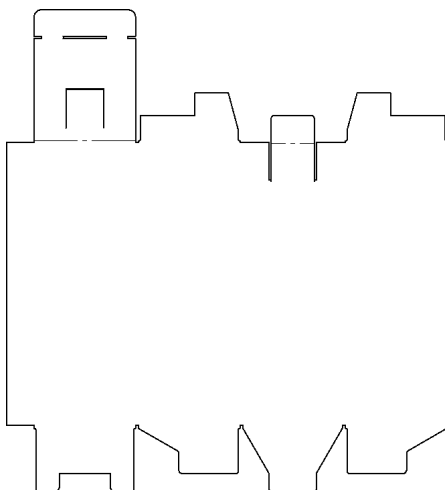

Figure 7. The net of paperboard container.

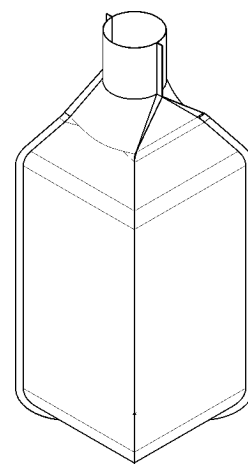

Figure 8. The internal bag model

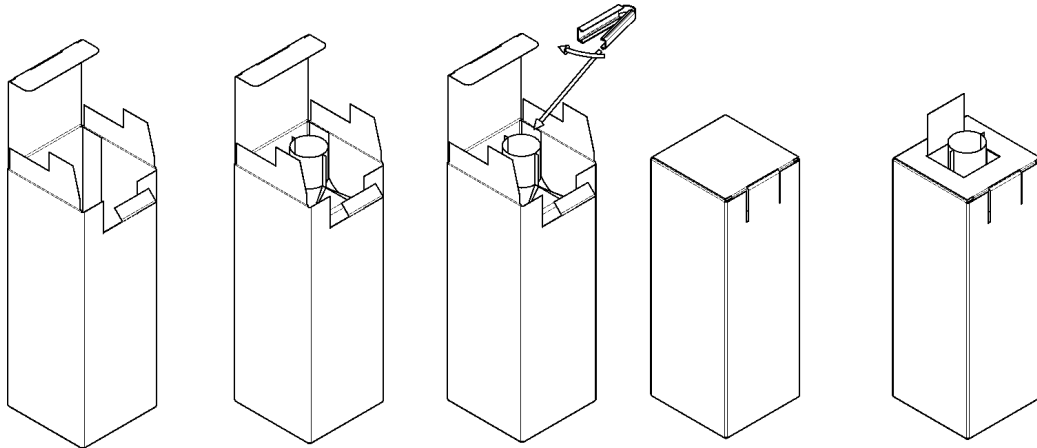

Figure 9. The functional principle of the new packaging.

The model of the internal bag (figure 8) has been analysed by FEM software to verify the load resistance. In the model, the bag was considered as filled with water and the walls of the bag were able to get contact with the external paperboard container and to be supported by it. The results of numerical analysis are shown in figure 10. The maximum equivalent tension calculated is 70 MPa, which is lower than the yielding stress of the aluminium material considered for the calculation (aluminum alloy 1145-H19, yield tensile strength 145MPa, 0.05mm thickness, EN601, EN602). This pre-design shows that it is possible to obtain an adequate strength by the combination of the internal bag and the external paperboard container and the sealing is assured by closing the bag neck with the plastic clip.

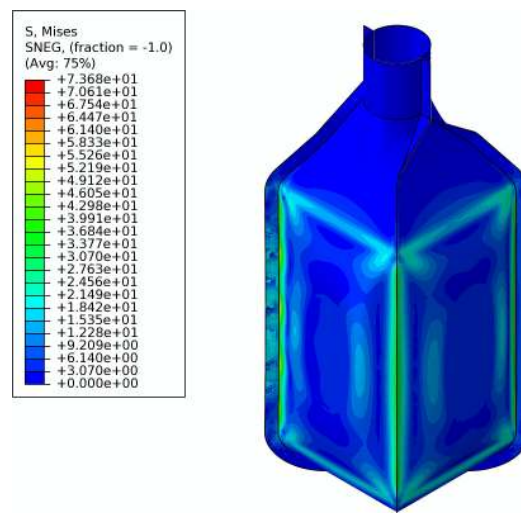

Figure 10. The FEM analysis of the internal bag.

For the next applications, the search of the contradiction matrixes into PLM database will be done using the TRIZ parameters. Once the designers had chosen the TRIZ parameters that describe the product, those can be used both to search contradictions and to browse into the database for search the TRIZ matrix that proposes a solution for the conflict.

The result of the technique application is a new package that could be implemented and assessed in the industrial practice, conforming to the customer requirements and to the environmental regulations.

4. Conclusions

The proposed methodology offers great potential for food&beverage product developers who want to develop innovative package at low cost, by reusing the historical knowledge of the enterprise, which is recorded and shared through the PLM database. Its implementation creates wide possibilities to reuse old design and solutions adopted in other similar fields or products, so reducing design costs, plant set-up costs and reaching a lesser time to market.

The QFD matrix helps designers to identify the key product characteristics starting from the customer requirements: the KPCs are a useful tools to highlight the new packaging objectives that must be satisfied during design phase. The TRIZ successfully examines the contradiction among the KPCs and proposes practical approaches to solve the problems found. Moreover, the TRIZ problem description with the contradiction matrixes is useful to index and search information into PLM database, so to share and reuse the enterprise knowledge.

The case of study resolves the conflict between key product characteristics when the design intent is extended to consider the packaging disposal and recycling at the end of its usefulness, conforming to design for environment regulations. It demonstrated the strength of the combined methodology to develop a new packaging design with completely recyclable materials: paperboard for the external container and aluminium for the internal bag.

References

- [1] Antti Saaksvuori, Anselmi Immonen. *Product Lifecycle Management*. Springer-Verlag Berlin 2004.
- [2] Günther Schuh, Henrique Rozenfeld, Dirk Assmus, Eduardo Zancul. Process oriented framework to support PLM implementation. *Computers in industry* 59 (2008). Pag. 210-218. DOI 10.1016/j.compind.2007.06.015
- [3] G. Schuh, D. Assmus, E. Zancul. Product structuring – the core discipline of product lifecycle management. *Proceedings of LCE2006 – 13th CIRP International Conference on Life Cycle Engineering*, Leuven May 31st, June 2nd, 2006. Pag. 393-398.
- [4] M. Eigner, R. Stelzer. *Produktdatenmanagement-Systeme: ein Leitfaden für Product Development und Life Cycle Management*. Springer 2009. ISBN 978-3-540-44373-5
- [5] X. Xu, J.L.Q. Chen, S.Q. Xie. Framework of a product lifecycle costing system. *J. Comput. Inf. Sci. Eng.*, March 2006. Volume 6, Issue 1, 69 (9 pages). DOI:10.1115/1.2161227
- [6] E. Abele, R. Anderl, H.Birkhofer. *Environmentally-Friendly Product Development*. Springer-Verlag 2005. ISBN-1-85233-903-9.
- [7] A. McKay, A. de Pennington, J. Baxter. Requirements management: a representation scheme for product specifications. *Computer-Aided Design*, Volume 33, Issue 7, June 2001, Pages 511-520, ISSN 0010-4485, DOI: 10.1016/S0010-4485(01)00050-1.
- [8] B. Eynard, T. Gallet, P. Nowak, L. Roucoules. UML based specifications of PDM product structure and workflow. *Computers in Industry*, Volume 55, Issue 3, Object-oriented modelling in design and production, December 2004, Pages 301-316, ISSN 0166-3615, DOI: 10.1016/j.compind.2004.08.006.
- [9] H. Aziz, J. Gao, P. Maropoulos, W. M. Cheung. Open standard. open source and peer-to-peer tools and methods for collaborative product development. *Computers in Industry*. Volume 56, issue 3, April 2005, pages: 260 – 271, ISSN:0166-3615
- [10] D. Kiritsis, A. Bufardi, P. Xirouchakis. Research issues on product lifecycle management and information tracking using smart embedded systems. *Advanced Engineering Informatics*, volume 17, issues 3-4, *Intelligent Maintenance Systems*, July-October 2003, Pages 189-202, ISSN 1474-0346, DOI: 10.1016/j.aei.2004.09.005.
- [11] <http://www.packagingblog.it/2009/09/coldiretti-il-costo-delle-confezioni-supera-quello-degli-alimenti/>
- [12] <http://www.knowthis.com/principles-of-marketing-tutorials/product-decisions/factors-in-packaging-decision/>
- [13] EC. Directive 94/62/EC on packaging and packaging waste.
- [14] Maria Cecilia Loschiavo dos Santos, Andréa Franco Pereira. Packaging: Function, Re-function, Malfunction. From Consumer Society to the Homeless Material Culture. *EcoDesign '99: First International Symposium On Environmentally Conscious Design and Inverse Manufacturing*, 1999. Page(s): 492 – 496. Proceedings. DOI 10.1109/ECODIM.1999.747662
- [15] Anna Meroni. Active Packaging as an opportunity to create package design that reflect the communicational, functional and logistical requirement of food product. *Packaging Technology and Science*. Volume 13, Issue 6, pages 243–248, November 2000. DOI: 10.1002/pts.524
- [16] Hang-wai Law, Meng Hua. Using Quality Function Deployment in Singulation Process Analysis. *Engineering Letters*, 2007, 14:1 EL_14_1_6
- [17] Hsin Rau, Yi-Tse Fang. Conflict Resolution of Product Package Design for Logistic Using the TRIZ Method, *Proceedings of 8th International Conference on Machine Learning and Cybernetics*, Baoding, 12-15 July 2009
- [18] Finch, H. Comparison of distance measures in cluster analysis with dichotomous data. *Journal of Data Science*, 2005, 3, 85-100