

A Prototype Ka-/Ka-Band Dichroic Plate With Stepped Rectangular Apertures

J. C. Chen, P. H. Stanton, and H. F. Reilly, Jr.
Communications Ground Systems Section

A prototype five-layer Ka-/Ka-band dichroic plate was fabricated and measured. This dichroic plate was designed to pass Ka-band uplink (34.2–34.7 GHz) and to reflect Ka-band downlink (31.8–32.3 GHz) for dual-frequency operation in the Deep Space Network to support the future Cassini mission. The theoretical calculation and the experimental measurement of the reflected resonant frequencies were within 0.24 percent for circular polarization. The computer program, which was used to design the dichroic plate with stepped apertures, was then verified.

I. Introduction

A dichroic plate was needed for simultaneous Ka-band uplink and downlink operation. In order to diplex two frequency bands with only a 1:1.07 ratio, stepped apertures were chosen for the Ka-/Ka-band dichroic plate design [1]. The stepped apertures, acting as resonator filters, pass the high-frequency band (Ka-band uplink, 34.2–34.7 GHz) and reflect the low-frequency band (Ka-band downlink, 31.8–32.3 GHz). The five-step aperture is a rectangular waveguide with two thin irises that divide the waveguide into three sections (Fig. 1).

II. Calculated Reflected and Transmitted Radiation Patterns and Power

The reflected and transmitted radiation patterns and power were calculated based on an incident horn pattern model at 32.0 and 34.5 GHz [2]. A 26-dB horn radiation pattern was used as the input pattern to the Ka-/Ka-band dichroic plate. The reflected and transmitted patterns were calculated at every $\phi = 12.25$ -deg interval and $\theta = 1$ -deg increment. The θ is the angle measured from the axis of rotation of the feedhorn (or its image in the case of a reflected pattern). The ϕ is the rotational angle around the above axis. The Cray supercomputer was used to perform this intensive calculation since 80 waveguide modes were required to ensure accuracy. The reflected and transmitted patterns are shown in Figs. 2 through 5 for the two linear polarizations that are orthogonal to each other at 32.0 and 34.5 GHz, respectively. The transmitted and reflected patterns of 32.0 GHz are similar to the incident horn pattern except that the peaks of the transmitted patterns are about -45 dB. The transmitted patterns of 34.5 GHz are similar to the incident horn pattern, while the peaks of the reflected patterns are about -20 dB.

The transmitted and reflected power can be calculated by integrating the transmitted and reflected patterns. It was found that 99.99 percent of the power is reflected and 0.01 percent leaks through the

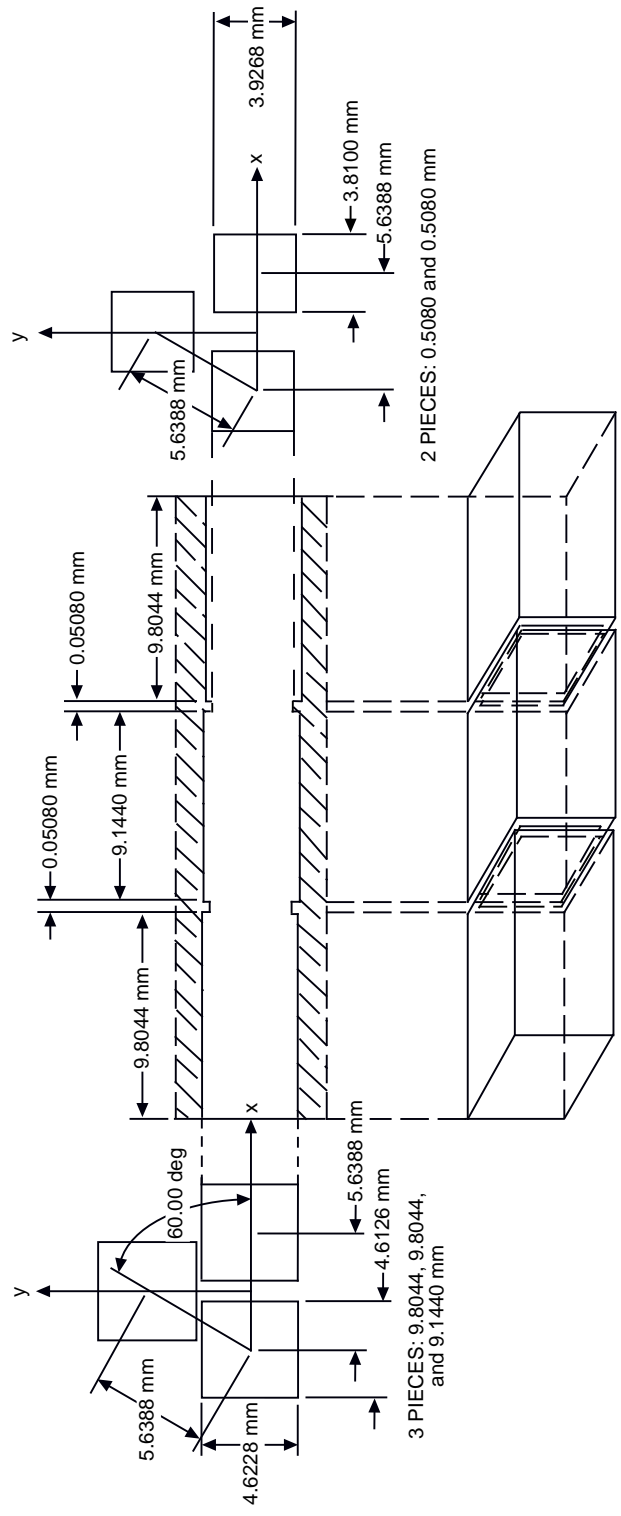

Fig. 1. Geometry of the aperture in the Ka-/Ka-band dichroic plate.

plate at 32 GHz. The power leakage may contribute 0.03 K of the noise temperature to the antenna system at DSS 13 at 34.5 GHz; 2.0 percent of the power is reflected and 98 percent is transmitted. The reflection and transmission coefficients versus frequencies were also calculated. The detailed information is in [1].

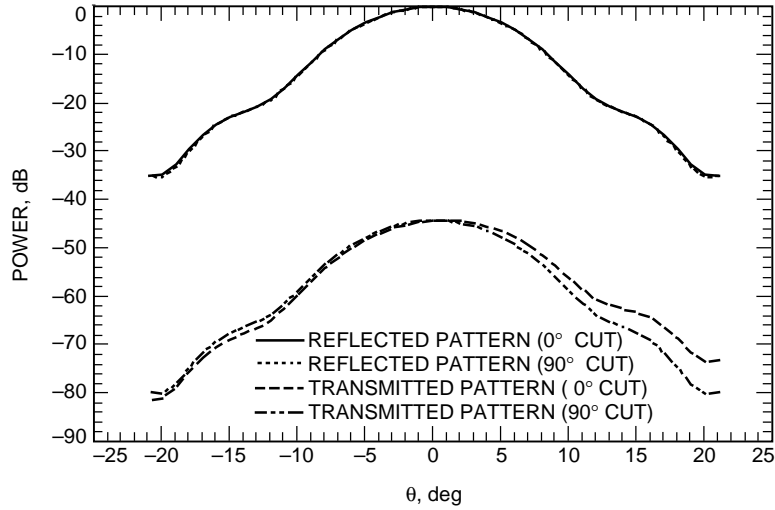

Fig. 2. Calculated reflected and transmitted radiation pattern of a Ka-/Ka-band dichroic plate at 32 GHz for linear polarization.

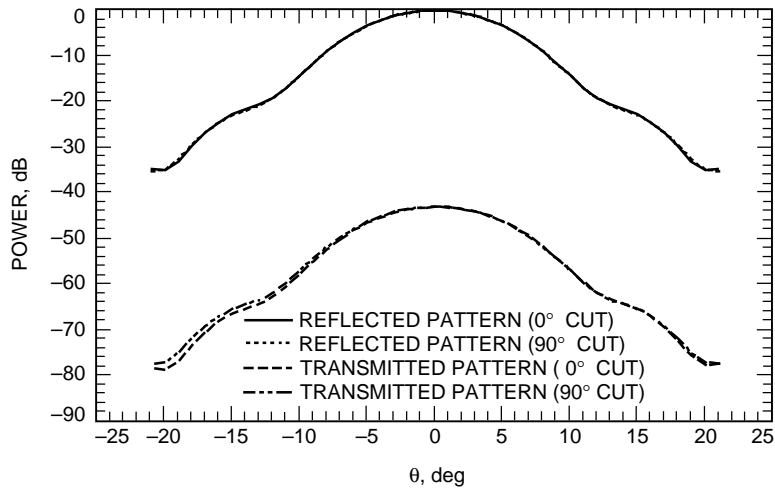

Fig. 3. Calculated reflected and transmitted radiation pattern of a Ka-/Ka-band dichroic plate at 32 GHz for the orthogonal linear polarization.

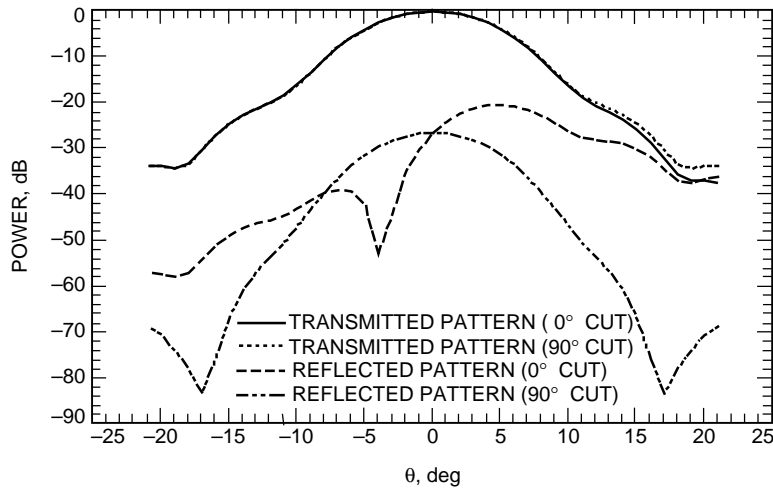

Fig. 4. Calculated reflected and transmitted radiation pattern of a Ka-/Ka-band dichroic plate at 34.5 GHz for linear polarization.

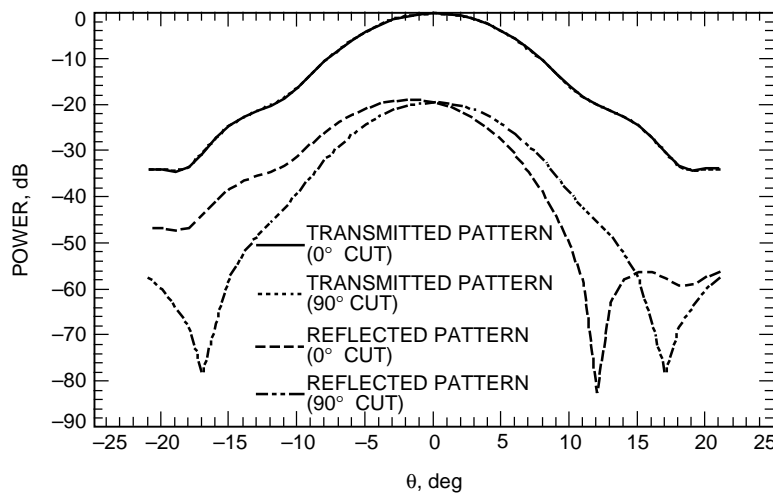

Fig. 5. Calculated reflected and transmitted radiation pattern of a Ka-/Ka-band dichroic plate at 34.5 GHz for the orthogonal linear polarization.

III. Fabrication

The prototype Ka-/Ka-band dichroic plate was a 177.8-mm-by-177.8-mm five-layer copper plate with a 152.4-mm-diameter perforated area (Fig. 6). The advantage of having only two different aperture sizes is a reduction of the fabrication cost. Since multiple metal sheets can be stacked together to be wire electrical-discharge machined when the sheets have an identical pattern, only two sets of sheets need to be run through the machine.

Previous dichroic plate fabrication dictated that, due to the tight tolerance and the cost, the wire electrical-discharge machine was the best way to fabricate rectangular apertures. The five-layer plate required a way to combine the layers into a solid structure. Holes in all four corners of the five plates were used to align the rectangular apertures and the five plates.

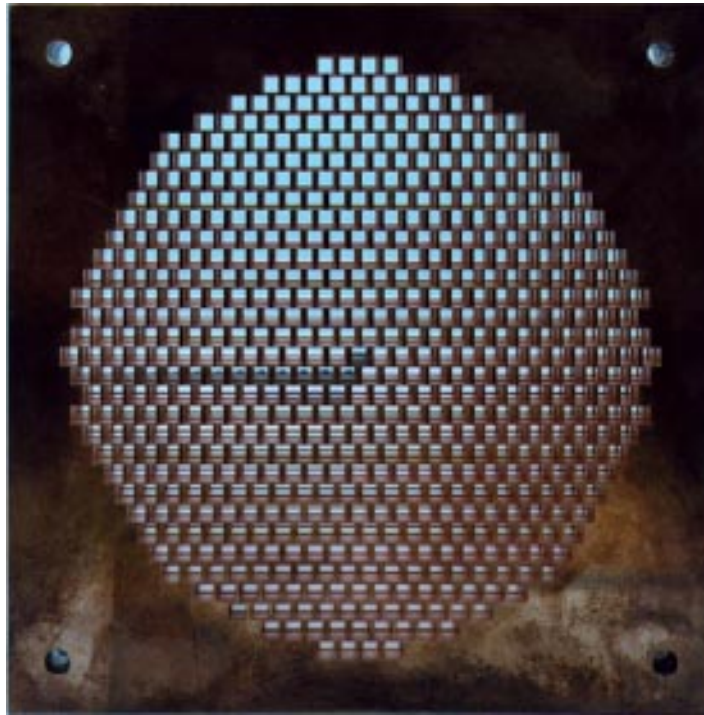

Fig. 6. Prototype Ka-/Ka-band dichroic plate.

Pure silver was deposited on both sides of the two thin plates in an electroless solution for a thickness of from 0.00508 to 0.00762 mm. The plates were then aligned with the four aligning pins originally used to locate the rectangular apertures. The fusing was accomplished in a reduced atmosphere of a hydrogen oven. A test sample made from regular copper was not adequate for this technique since the oxygen in the copper went to the surface during the brazing process. This test result dictated that only oxygen-free copper (less than 0.001 percent) was acceptable.

After visual inspection, the five-layer plate was mechanically inspected using the Monarch, Cortland, and Bafire Probe technique. Data points of the location and size of the rectangular apertures were recorded and averaged. The inspected dimensions of the apertures turned out to be 3.8331 mm by 3.9406 mm (design dimensions of 3.8100 mm by 3.9268 mm) for small apertures and 4.6200 mm by 4.6116 mm (design dimensions of 4.6126 mm by 4.6228 mm) for the large apertures. All dimensions were within a 0.0254-mm tolerance.

IV. Measurement

The reflection coefficients of the dichroic plate were measured on a Hewlett Packard 8510 network analyzer (Fig. 7). Two orthogonal linear polarizations, TE and TM, were measured. (When the electrical field of the wave is perpendicular to the plane of incidence, it is called TE polarized; if the magnetic field of the wave is perpendicular to the plane of incidence, it is called TM polarized.) A 22-dB corrugated horn was located 104-mm away from the dichroic plate along a 30-deg angle of incidence. A second horn was placed 1073 mm from the dichroic plate along the direction of the reflected beam. The reflection response curve shows two resonant frequencies for TE and TM linear polarizations, respectively (Figs. 8 and 9). The theoretical values were recalculated for the actual dimensions of the prototype dichroic plate. Results for circular polarization were computed by using the two orthogonal linear

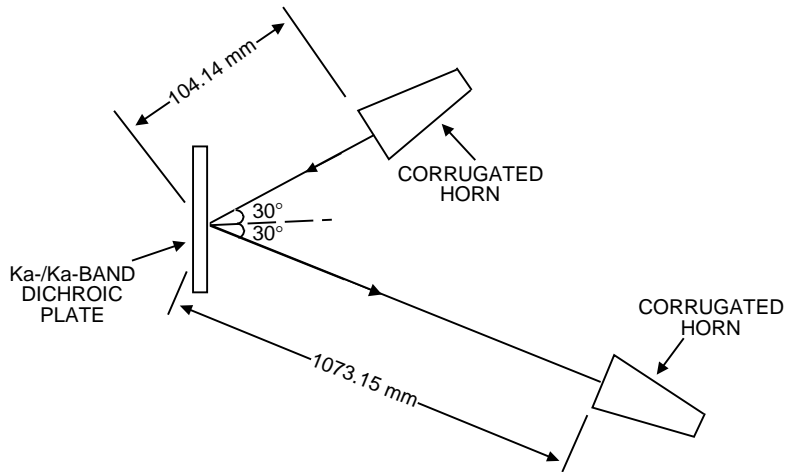

Fig. 7. Experimental setup for the reflection measurement.

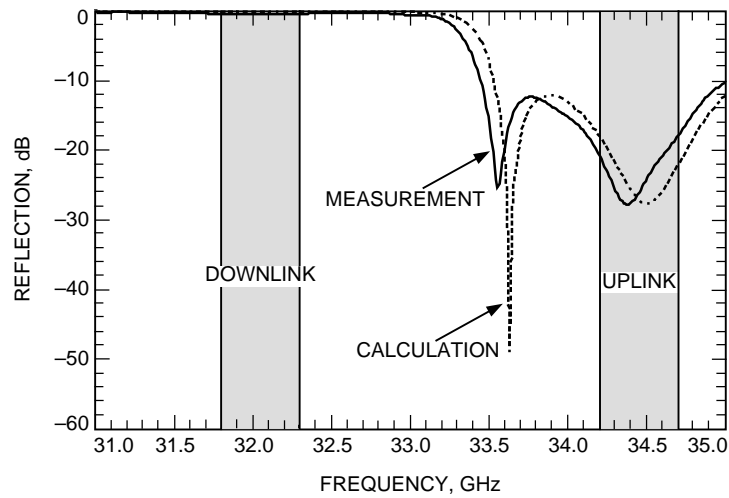

Fig. 8. Measured and calculated reflection coefficient versus frequency for TE linear polarization.

polarizations (TE and TM) and the phase difference between them (Fig. 10). The calculated and measured resonant frequencies are less than 0.25 percent in error for circular polarization (Table 1).

A transmission measurement for TE and TM polarizations was also made in order to check the performance of the reflecting band (31.8–32.3 GHz) (Fig. 11). The 22-dB transmit horn was located 127.0 mm away from the dichroic plate, which was tilted 30 deg from normal. The five-layer dichroic plate is approximately three times thicker than a one-layer dichroic plate such as the X-/Ka-band dichroic plate [3]. Therefore, the transmitted beam path was not the same as the incident beam path. Consequently, the receiving horn was offset 13.97 mm from the incident beam path. For reference, the transmission coefficients were first measured without the dichroic plate. Then the transmission coefficients were measured again with the dichroic plate between the two horns. The measured and calculated transmission coefficients showed good agreement for TE and TM polarizations, respectively (Figs. 12 and 13). The transmitted power was below -35 dB at the Ka-band downlink for circular polarization (Fig. 14).

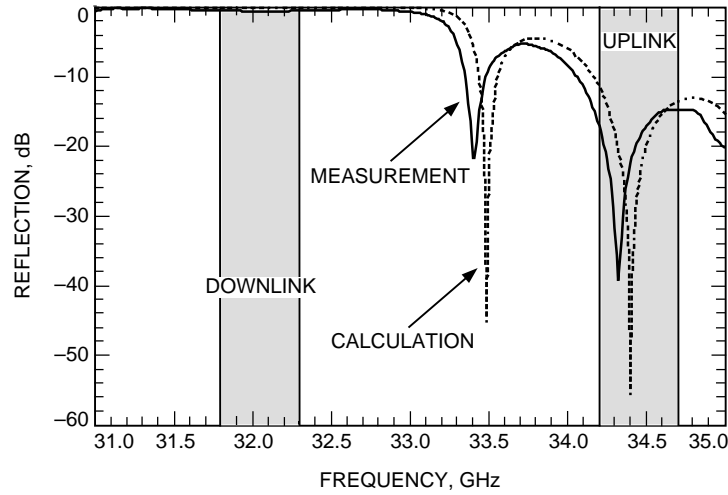

Fig. 9. Measured and calculated reflection coefficient versus frequency for TM linear polarization.

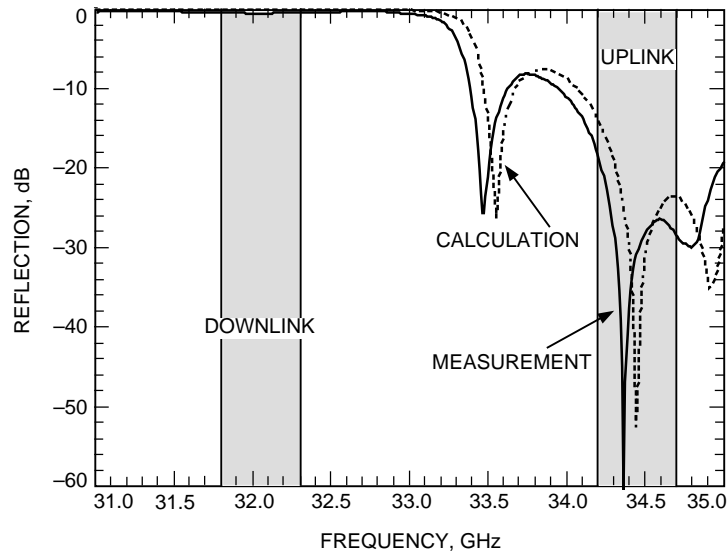

Fig. 10. Measured and calculated reflection coefficient versus frequency for circular polarization.

V. Conclusion

The prototype five-layer Ka-/Ka-band dichroic plate was successfully fabricated. The fabrication technique was proven adequate for the multilayer dichroic plate. The experimental results and theoretical predictions showed good agreement for the resonant frequency, within 0.25 percent. Furthermore, the computer code for analyzing the dichroic plate with stepped rectangular apertures was verified. A Ka-/Ka-band dichroic plate will be fabricated and implemented for an X-/X- to Ka-/Ka-band demonstration at DSS 13.

Table 1. The measured and calculated reflection resonant frequencies of the prototype Ka-/Ka-band dichroic plate.

Polarization	Resonant frequency	Measurement, GHz	Calculation, GHz	Error percentage
TE linear polarization	1st	33.56	33.625	0.19
	2nd	34.37	34.5	0.38
TM linear polarization	1st	33.41	33.485	0.22
	2nd	34.32	34.40	0.23
Circular polarization	1st	33.47	33.55	0.24
	2nd	34.36	34.44	0.23

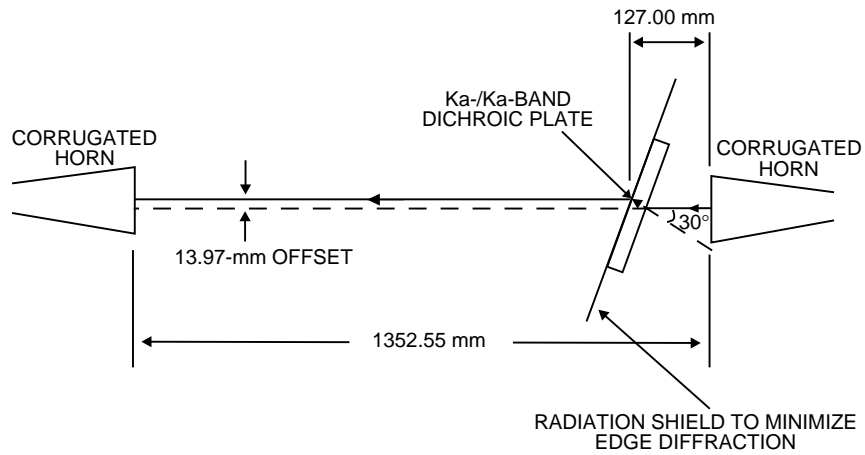

Fig. 11. Experimental setup for the transmission measurement.

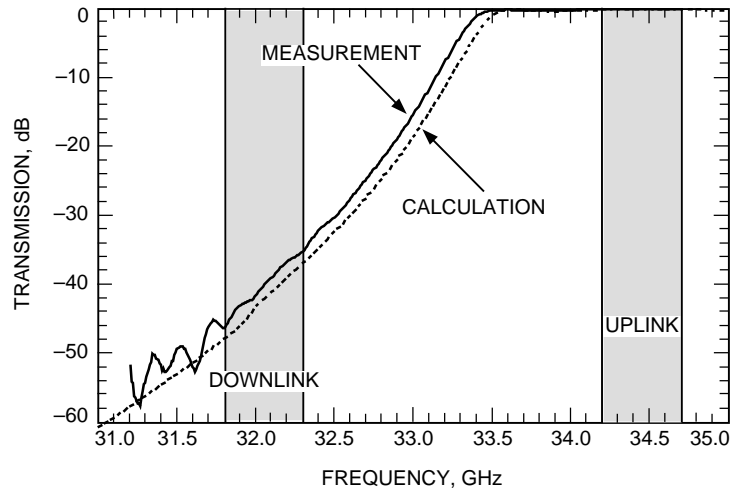

Fig. 12. Measured and calculated transmission coefficient versus frequency for TE linear polarization.

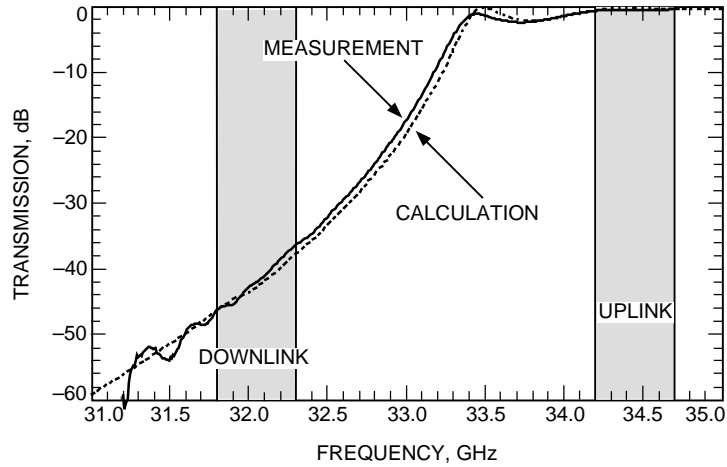

Fig. 13. Measured and calculated transmission coefficient versus frequency for TM linear polarization.

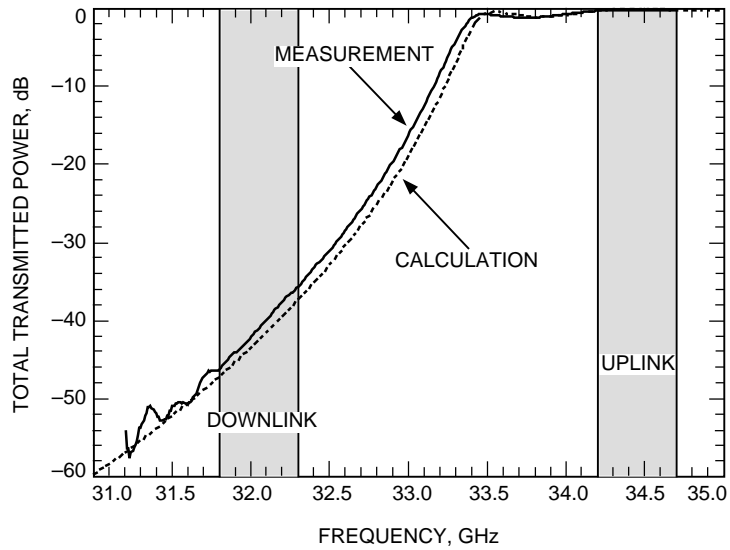

Fig. 14. Measured and calculated total transmitted power versus frequency for circular polarization.

Acknowledgment

The Cray supercomputer used in this investigation was provided by funding from the NASA offices of Mission to Planet Earth, Aeronautics, and Space Science.

References

- [1] J. C. Chen, "Feasibility Study of a Ka-/Ka-Band Dichroic Plate With Stepped Rectangular Apertures," *The Telecommunications and Data Acquisition Progress Report 42-112, October–December 1992*, Jet Propulsion Laboratory, Pasadena, California, pp. 1–7, February 15, 1993.
- [2] J. C. Chen, "Computation of Reflected and Transmitted Horn Radiation Patterns for a Dichroic Plate," *The Telecommunications and Data Acquisition Progress Report 42-119, July–September 1994*, Jet Propulsion Laboratory, Pasadena, California, pp. 236–254, November 15, 1994.
http://tda.jpl.nasa.gov/tda/progress_report/42-119/119N.pdf
- [3] J. C. Chen, P. H. Stanton, and H. F. Reilly "Performance of the X-/Ka-/KABLE-Band Dichroic Plate in the DSS-13 Beam Waveguide Antenna," *The Telecommunications and Data Acquisition Progress Report 42-115, July–September 1993*, Jet Propulsion Laboratory, Pasadena, California, pp. 54–64, November 15, 1993.