

N 70 15 22 4

NASA CR 107568

NATIONAL AERONAUTICS AND SPACE ADMINISTRATION

*Technical Report 32-1462*

*A Review of Aerodynamic Noise From Propellers,  
Rotors, and Lift Fans*

*Jack E. Marte*

*Donald W. Kurtz*

**CASE FILE  
COPY**

**JET PROPULSION LABORATORY  
CALIFORNIA INSTITUTE OF TECHNOLOGY  
PASADENA, CALIFORNIA**

January 1, 1970



NATIONAL AERONAUTICS AND SPACE ADMINISTRATION

*Technical Report 32-1462*

*A Review of Aerodynamic Noise From Propellers,  
Rotors, and Lift Fans*

*Jack E. Marte*

*Donald W. Kurtz*

**JET PROPULSION LABORATORY  
CALIFORNIA INSTITUTE OF TECHNOLOGY  
PASADENA, CALIFORNIA**

January 1, 1970

Prepared Under Contract No. NAS 7-100  
National Aeronautics and Space Administration

## **Preface**

The preparation of this report was carried out by the Environmental Sciences Division of the Jet Propulsion Laboratory for the United States Department of Transportation.



# Contents

<b>I. Introduction</b> . . . . .	1
<b>II. Elements of Aerodynamic Acoustics</b> . . . . .	2
A. Acoustic Radiator Models . . . . .	2
B. Sources of Aerodynamic Noise . . . . .	3
1. Rotational noise . . . . .	3
2. Interaction and distortion effects . . . . .	4
3. Vortex noise . . . . .	4
4. Turbulence-induced noise . . . . .	4
C. Attenuation . . . . .	5
1. Geometric attenuation . . . . .	5
2. Atmospheric attenuation . . . . .	5
<b>III. Propeller Noise</b> . . . . .	5
A. Introduction . . . . .	5
B. Polar Noise Patterns . . . . .	6
C. Ordered (Rotational) Noise . . . . .	6
D. Vortex Noise . . . . .	6
<b>IV. Rotor Noise</b> . . . . .	7
A. Introduction . . . . .	7
B. Characteristics of Rotor Noise . . . . .	7
1. Ordered (rotational) noise . . . . .	7
2. Broad-band (vortex) noise . . . . .	10
3. Modulation (blade slap) noise . . . . .	12
C. Rotor Noise Alleviation . . . . .	13
<b>V. Lift Fan Noise</b> . . . . .	14
A. Introduction . . . . .	14
B. Noise Sources of Fans . . . . .	14
C. Scaling Law . . . . .	15
<b>Appendix A. Explanation of Some Fundamental Terms</b> . . . . .	18
<b>Appendix B. Generalized Propeller-Noise Estimating Procedure</b> . . . . .	21
<b>Appendix C. Generalized Rotor-Noise Estimating Procedure</b> . . . . .	28
<b>Appendix D. Generalized Lift-Fan-Noise Estimating Procedure</b> . . . . .	35

## Contents (contd)

Appendix E. V/STOL-Noise Bibliography . . . . .	38
---	----

References . . . . .	47
----------------------	----

### Figures

1. Elementary sources of sound . . . . .	2
2. Theoretical noise patterns for rotors, propellers and fans . . . . .	2
3. Sources of aerodynamic noise . . . . .	3
4. Molecular attenuation coefficient for air-to-ground propagation at 70°F and 8 g/m <sup>3</sup> absolute humidity . . . . .	5
5. Noise level as a function of disc loading . . . . .	7
6. Acoustic contribution of loading harmonics 10 deg below rotor disc (adapted from Ref. 12) . . . . .	8
7. Comparison of theories with experimental data at the side of a helicopter . . . . .	8
8. Comparison of theory and experiment (adapted from Ref. 14) . . . . .	9
9. Noise spectrum; comparison of theory (adapted from Ref. 12) and experiment for a two-blade rotor (UH-1A and UH-1B) . . . . .	10
10. Octave band vortex noise spectrum below stall (a), and above stall (b), (adapted from Ref. 13) . . . . .	11
11. Comparison of computed SPLs vs harmonic number for various $K_L$ and $K_D$ , with measured SPLs for a UH-1A helicopter in hover, (adapted from Ref. 19) . . . . .	11
12. Typical blade-vortex intersections for a single rotor system (a), and a tandem rotor system (b) . . . . .	12
13. Tip vortex locus as a function of several operational modes . . . . .	13
14. Typical tip-turbine-driven lift fan . . . . .	15
15. Effect of rotor-stator spacing (adapted from Hickey, Ref. 23) . . . . .	15
16. Normalized overall power of compressor and fan noise (adapted from Ref. 26) . . . . .	16
17. Noise generated by STOL aircraft, 50,000 to 95,000 lb gross weight (adapted from Deckert, Ref. 23) . . . . .	17
B-1. Near-field axis system . . . . .	21
B-2. Reference level . . . . .	22
B-3. Correction for speed and radial distance . . . . .	22
B-4. Variation of over-all, free-space propeller noise levels with axial position $X/D$ fore and aft of propeller plane . . . . .	23
B-5. Effect of reflecting surfaces in pressure field . . . . .	23
B-6. Harmonic distribution of rotational noise . . . . .	23



## Contents (contd)

### Figures (contd)

B-7. Chart for combining noise levels . . . . .	23
B-8. Polar distribution of overall noise levels for propellers . . . . .	25
B-9. Molecular absorption of sound in air . . . . .	25
B-10. Far-field axis system . . . . .	26
C-1. Rotor rotational noise axis system . . . . .	28
C-2. Rotor noise harmonic sound pressure levels $I_n$ as functions of harmonic number, rotational Mach number, and angle from disc plane . . . . .	30
C-3. Sound pressure levels corresponding to harmonic numbers . . . . .	33
C-4. Results of vortex noise sample calculation . . . . .	34
D-1. Lift fan axis system . . . . .	35
D-2. Normalized power spectrum of compressor and fan noise . . . . .	36

## **Abstract**

Hand-calculation procedures for predicting aerodynamic noise from propellers, rotors and lift fans useful as first engineering approximations have been assembled from the literature. Considerable introductory material and a glossary of terms has been included to make the prediction procedures more meaningful. Current literature has been reviewed and a comprehensive bibliography on V/STOL aircraft noise is presented.

# A Review of Aerodynamic Noise from Propellers, Rotors, and Lift Fans

## I. Introduction

The problem of aircraft noise and its annoyance to the public has been one of increasing concern in recent years. The advent of turboshaft engines has, in most cases, left the rotor, propeller, and lift fan systems as the primary sources of aerodynamic noise in current and proposed V/STOL aircraft. The forecasted increased commercial use of these aircraft in close-in, heavily populated areas has made understanding these systems as noise sources an important technical objective. Discomfort, interruption of speech communication and other activities due to intermittent aircraft noise is expected to be realized by a wider segment of the public with the advent of broad utilization of low-flying V/STOL aircraft. In addition, high noise level inside currently flying STOL aircraft provides additional motivation for developing better abatement techniques.

This report is the product of a study of aircraft noise technology, by JPL for the United States Department of Transportation, particularly as it relates to V/STOL aircraft. No original research is included. It is the intention of this review to gather convenience material, useful for prediction of the aerodynamic noise generated by propellers, lift fans, and rotors; it is representative of the best methods available in the open literature at this time. Also included is sufficient background material to enable a reader without previous experience in acoustics to learn its terminology and some orientation in the field.

The bibliography included as Appendix E was assembled during the course of the study of V/STOL noise technology; it is much broader in scope, therefore, than the remainder of this report which is limited to rotors, lift fans, and propellers.

## II. Elements of Aerodynamic Acoustics

### A. Acoustic Radiator Models

In earlier work on acoustic theory, such as Ref. 1, many of the features of aerodynamic noise are discussed in terms of simple sources (monopoles), dipoles, and quadrupoles. These are the so-called elementary solutions of the equations of motion from classical acoustic theory of small disturbances to a gas at rest. The theory was developed by Lord Rayleigh before the end of the nineteenth century in his *Theory of Sound*. Such solutions describe the radiation generated at a point, while real sound is always generated over some area and can be described only by a continuous distribution of point singularities. Physical models, taken from Ref. 2, are shown in Fig. 1.

The simplest of these is the pulsating sphere, which is used to represent the simple point source where the sound is generated by the variation of mass outflow from the source. A simple example of this type of noise is the bursting balloon; none of the noise sources of rotors, fans, and propellers are of this type.

The next simplest elementary solution is the dipole, where sound is generated by the injection of momentum rather than mass. An acoustic dipole is equivalent to a force concentrated at a point and varied in magnitude and/or direction. Alternate models are shown in Fig. 1b.

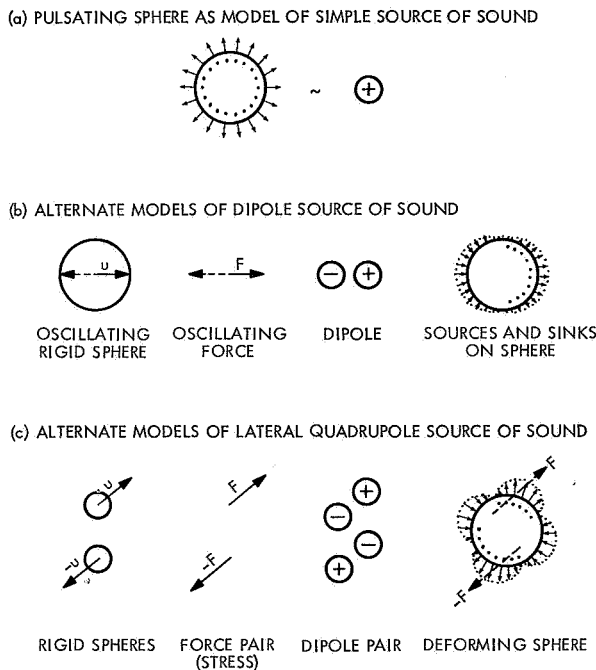

Fig. 1. Elementary sources of sound

Dipole strength is a vector term with direction as well as magnitude. Vortex noise is an example of dipole noise, as are noise due to torque (induced drag) and noise due to thickness (form drag).

In the appropriate acoustic equation, momentum transport appears in two parts: one represents direct convection of the momentum component by the velocity component; the other part, which equally transfers momentum, is the stress between adjacent elements of fluid. This second part can be represented by a quadrupole since an element of fluid under stress bears equal and opposite forces on opposite sides, each force being equivalent to a dipole and each pair to a quadrupole. Models for quadrupoles are shown in Fig. 1c. A turbulent jet is a noise source of this type, as also is thrust noise, because the wake from which the noise emanates is merely a low-speed turbulent jet.

Cancellation effects in the dipole and quadrupole cause progressively decreasing efficiencies of radiation at the lower frequencies. In an example from Ref. 3, which assumes a sphere deforming at a frequency having a wavelength of twice the circumference of the sphere, the efficiencies of a dipole and a quadrupole relative to a simple source are 1/13 and 1/1000, respectively. This suggests one means of reducing aerodynamic noise: that

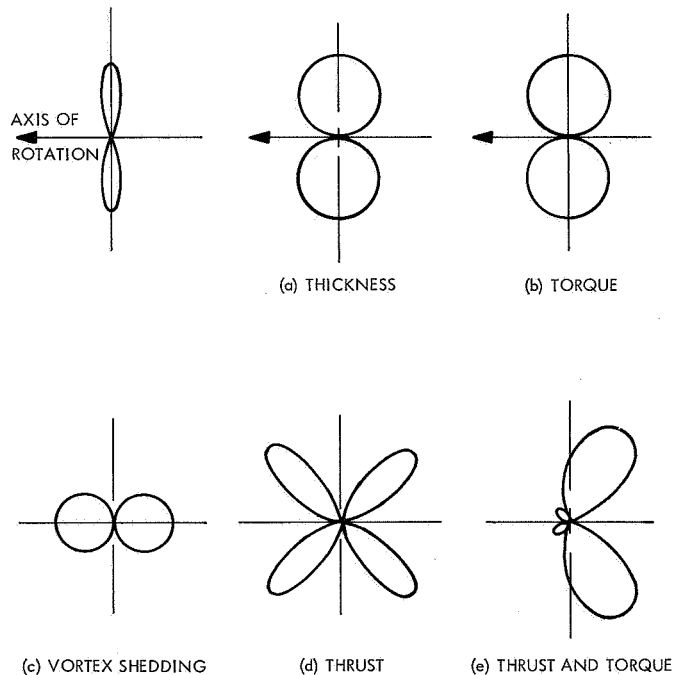

Fig. 2. Theoretical noise patterns for rotors, propellers and fans

as much as possible of the acoustic energy, which is the inevitable byproduct of the generation of the aerodynamic forces required for flight, be channeled into mechanisms which are inefficient quadrupole radiators.

Each type of radiator has its own polar distribution of acoustic energy. The simple source or monopole is non-directional, of course, while the dipole has the familiar two-lobed figure-8 pattern with the lobes aligned in the direction of the vector. The quadrupole has a symmetrical four-lobed pattern. These theoretical polar distribution patterns are to some degree distorted in practice. Theoretical noise patterns for various types of noise are shown in Fig. 2 (taken from Ref. 4).

### B. Sources of Aerodynamic Noise

Aerodynamic noise may be defined as sound which is generated as a direct result of relative motion between a solid body or stream of fluid and the surrounding medium. The mechanisms by which rotors, propellers and fans produce intense sound pressures have been the subject of much work, especially in recent years. Traditionally, noise generated by propellers has been separated into two parts called the *rotational* and the *vortex* components. Rotational or periodic noise here describes all sound which is identified with discrete frequencies occurring at harmonics of the blade passage frequency (number of blades

times the rotational frequency). Vortex or broad band noise describes the modulated sound produced by the unsteady pressure field associated with vortices shed from the trailing edge and tips of the blades as well as some of the noise sources associated with turbulence effects in the air stream. The helicopter rotor and single or multi-stage lift fans deserve separate consideration because, although much of their noise can be explained in terms of propeller noise sources, there are a number of other sources which are exclusive to, or of increased importance in, those devices to the point where they make significant contributions to the overall levels. For purposes of this discussion, the sources of aerodynamic noise have been structured as shown in Fig. 3. They include not only the traditional sources of noise in propellers but also those additional sources which can be important for rotors and fans.

#### 1. Rotational noise

*a. Thrust and torque noise.* All real rotating airfoils, i.e., those having thickness, have a pressure distribution when moving relative to the surrounding medium. This pressure distribution can be resolved into a thrust component normal to the plane of rotation and torque component in the plane of rotation. Conversely, the air in contact with the propeller has a force on it which can be resolved into the thrust and torque vectors. This pressure field on the

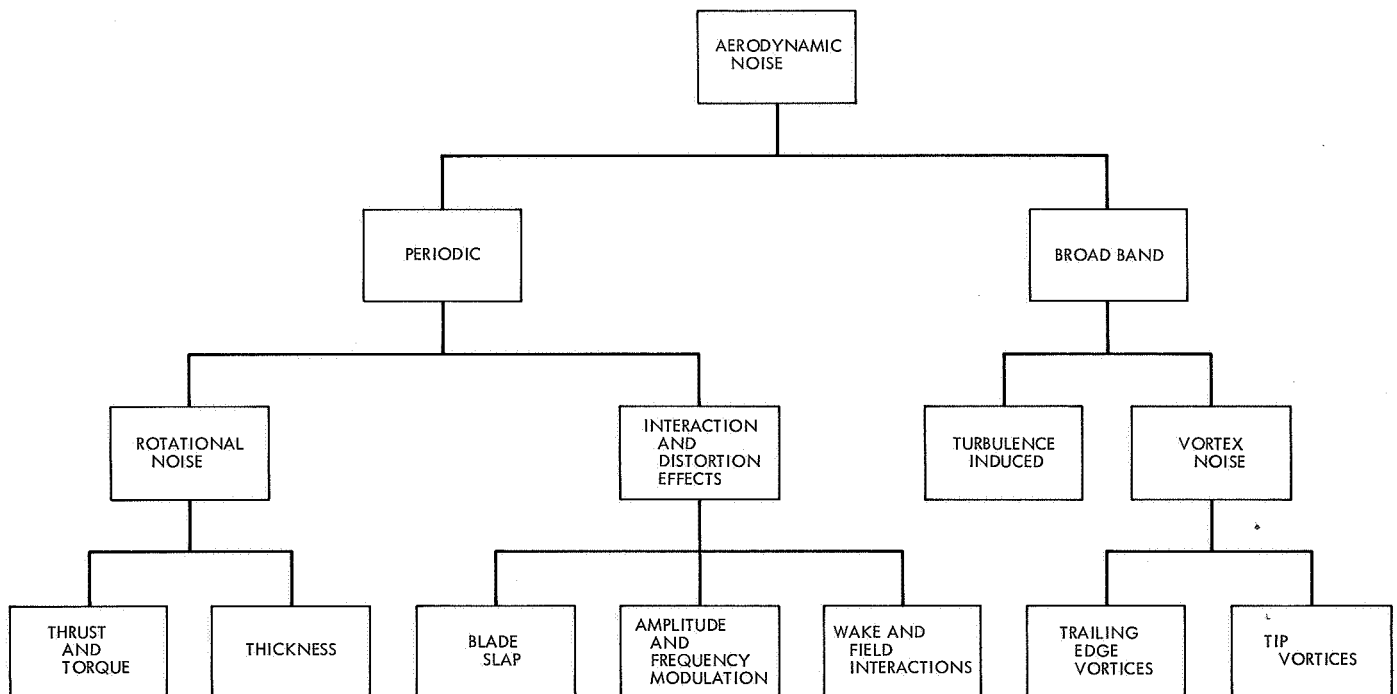

Fig. 3. Sources of aerodynamic noise

air is steady relative to the blade and rotates with it if operating under conditions of uniform inflow. For non-uniform inflow, for example a helicopter rotor in steady forward flight, the difference in relative blade speed during forward and backward motion of the blade relative to the flight path requires a cyclic incidence variation to provide a reasonably uniform lift over the disc. To a first approximation, the forces on the air next to the disc would be constant under these conditions; the effects of incidence changes would appear only as variations of chordwise loading over the blade. From a fixed point on the disc, the rotating field appears as an oscillating pressure. The frequency of the oscillation is the frequency with which a blade passes that point (blade passage frequency), and the wave form of the oscillating pressure is determined by the chordwise distribution of pressure on the blades. Analytically, rotating airfoils generating thrust and torque noise may be represented as an array of stationary dipole sources in the rotor disc which are activated during blade passage.

*b. Thickness noise.* In addition to experiencing a fluctuating force, an element of air in the disc will be physically moved aside by the finite thickness of the blade. In a fixed frame of reference this displacement is equivalent to a periodic introduction and removal of mass at each element of air near the disc. The rate of mass introduction at a point, which is determined by the blade profile, incidence and speed, can then be expressed as the strength of a simple source. Up to values of resultant tip speed approaching sonic, thickness noise is generally found to be small compared with the noise arising from torque and thrust. At higher tip speeds, however, it may assume equal importance.

**2. Interaction and distortion effects.** The following periodic effects are usually identified with helicopter rotors but may occur to a lesser degree in fans and propellers.

*a. Blade slap.* Impulsive noise, blade bang or blade slap may consist of high-amplitude periodic noise plus highly modulated vortex noise caused by impulsive fluctuating forces on the blades. The mechanisms by which these forces may arise are: (1) blade-vortex interaction, (2) periodic stalling and unstalling of a blade, and (3) shock wave formation and collapse due to unsteady periods of local supersonic flow. The first and second conditions (and possibly the third) may occur when a blade passes through or near a tip vortex or the unsteady wake generated by a preceding blade. Operation in this unsteady flow condition leads to strong fluctuating forces. Here, aeroelastic

properties may become significant parameters. The third mechanism may also result directly from operation of a blade at high tip speed (such as an advancing helicopter blade during high speed flight). When it occurs, blade slap is by far the dominant source of aerodynamic noise.

*b. Amplitude and frequency modulation.* Distortion effects of these types can significantly alter the character of the generated sound. Amplitude and frequency modulation resulting from the periodic advance and retreat of the source relative to a stationary observer effectively increases the detection and annoyance of a noise source. In addition, Doppler shift due to motion (flyover) of the aircraft relative to the fixed observer causes a frequency shift in the overall noise level which is proportional to the velocity of the aircraft.

*c. Wake and field interaction.* The angle of attack and hence the lift of a blade passing through a series of wakes, as in a lift fan with upstream stators, will be modulated at the fundamental frequency of the blade wake interaction and is thus a source of additional periodic noise radiation. The modulation of lift due to interaction of the pressure fields of two adjacent blade rows in relative motion can produce noise levels equal to wake interactions and at the same frequencies.

**3. Vortex noise.** The dominant source of broad band noise is called vortex noise which has been defined as that sound which is generated by the formation and shedding of vortices in the flow past a blade. For an infinite circular cylinder, normal to the flow and in the range of Reynolds numbers from  $10^3$  to  $10^5$ , it is well known that the vortices are shed in an orderly vortex street which is a function of cylinder diameter and flow velocity. The process in the case of a rotating airfoil is similar and since there is a different velocity associated with each chordwise station along the span, a broad band of shedding frequencies results. This produces a dipole form of acoustic radiation in which the strength of the source is proportional to the sixth power of the section velocity. Hence the frequencies associated with the area near the tip tend to be of greatest amplitude. Also, since a blade develops lift (thrust), tip and spanwise vorticity of strength proportional to the thrust gradients are generated and shed. Their dipole acoustic radiation combines with that from the trailing edge vortices to make up the so-called vortex noise.

**4. Turbulence-induced noise.** In flow fields containing shear layers such as boundary layers, random noise is produced directly by the motion of small-scale turbulence

which, since it is quadrupole in nature, is inefficiently radiated and inaudible in the presence of other noise sources. However, considerable amplification of the weak noise generation mechanism of turbulence results due to interaction with the pressure field of a moving blade. The induced acoustic radiation is of the more efficient dipole type.

### C. Attenuation

**1. Geometric attenuation.** As a sound wave travels through still homogeneous air, it loses energy in three ways. The first and usually most important process is that due to the geometric distance between the source and the observer. If one considers spherical wave spreading from a point source of uniform intensity, the sound pressure level registered at the observer varies inversely as the square of the distance from the source. This relationship is valid (to a first order approximation) for non-point sources if the observer is in the far field (i.e., if the distance from source to observer is great relative to the dimension of the source). Expressed in terms of the logarithmic decibel scale, the sound pressure level falls by 6 dB for every doubling of distance from the source.

**2. Atmospheric attenuation.** The other two processes by which a sound wave loses energy are functions of the atmosphere itself. The first mechanism arises through losses from heat conduction and radiation, viscosity, and diffusion. This is generally termed *classical absorption* and is proportional to the square of the sound frequency. The other process has to do with molecular relaxation in the air and, unlike classical absorption, is a function of humidity as well as frequency. Typically, this second effect is much more important in the audible range of frequencies, and classical absorption is generally neglected. Wind gradients and atmospheric turbulence can also be a significant factor. Attenuations measured upwind may exceed those measured downwind by 25 to 30 dB. Figure 4 shows the approximate molecular attenuation levels for air-to-ground sound propagation for an air temperature of 70°F and absolute humidity of 8 g/m<sup>3</sup> as determined by the technique given in Ref. 5. A detailed treatment of atmospheric attenuation is given in that reference. Similar curves for both classical and molecular attenuation for other values of atmospheric temperature and humidity can be obtained readily. It should be noted, however, that recent tests with turbofan aircraft have brought the present state of knowledge regarding atmospheric attenuation into dispute. The values of attenuation generally used (Ref. 5) for the high frequencies would appear to be too large based on these tests.

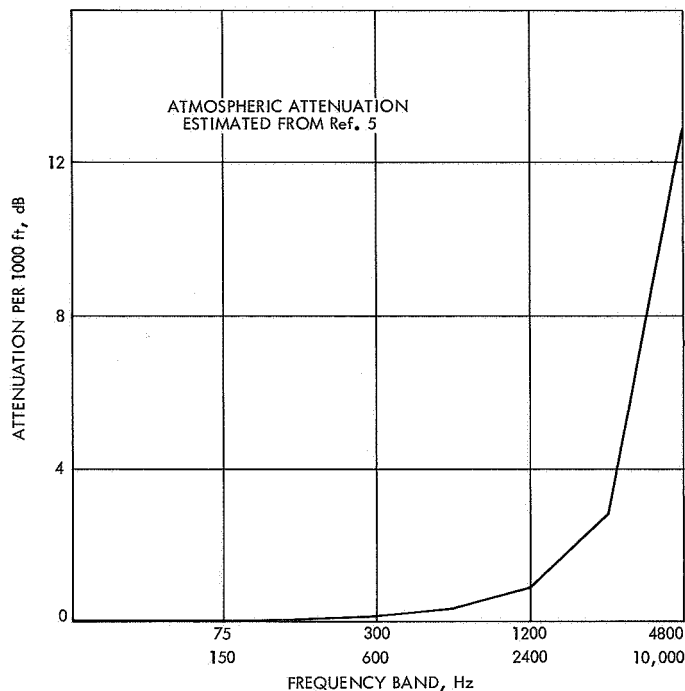

Fig. 4. Molecular attenuation coefficient for air-to-ground propagation at 70°F and 8 g/m<sup>3</sup> absolute humidity

## III. Propeller Noise

### A. Introduction

As discussed in Section II, the noise produced by an operating propeller has been an object of scientific interest for many years. All of the early work in the aeronautical noise field, both analytic and experimental, was concerned with the propeller noise problem or with allied configurations such as Yudin's work (Ref. 6) with rotating rods.

Although closely related to the noise produced by rotors and fans, the problem of propeller noise is, in some respects, simpler because of the configuration and operating conditions of the propeller. The small number of blades in a normal propeller together with the flow velocity through the propeller disc minimizes the interference effects due to operation in the wake of preceding blades. The structure and location of the propeller is such that noise due to blade flutter and asymmetrical induced flow are not normally encountered. At moderate tip speeds, i.e., slightly below the onset of compressibility effects, both vortex noise and rotational noise due to thickness are lower than the rotational noise due to thrust and torque. Consequently, most of the noise work on propellers, of both a theoretical and experimental nature, has concentrated on the effects of thrust and torque. In studies dealing with

the reduction of overall propeller noise, however, vortex noise has been shown to be an important contributor and, in the case of high-speed flight, the level of thickness noise may exceed that of thrust and torque noise.

## B. Polar Noise Patterns

The theoretical polar noise patterns for propeller noise were shown in Fig. 2 and discussed in Section II; however, a few additional details are noteworthy. While thickness, torque, and vortex noise show the dipole pattern, the former two have their maximums in the plane of rotation, while the latter has its maximum along the axis of rotation. While it is not shown in the figure, the two forward lobes of the quadrupole pattern of the thrust noise are 180 deg out of phase with the torque lobes. Figure 2e shows a combined thrust and torque polar noise pattern that is typical for a normal propeller. The relative magnitudes of the lobes are approximately correct. Theory indicates that the angle of maximum intensity for a stationary propeller is 120 deg, as measured from the forward axis of rotation. For a propeller in motion along the axis of rotation, this angle is reduced, because the contribution of the aft lobes of thrust noise becomes smaller as thrust itself becomes less. At 150 mph, the angle of maximum intensity might be 105 deg. Only the rear lobes contribute to this effect because of the out-of-phase relationship of the forward thrust lobes.

## C. Ordered (Rotational) Noise

The theoretical work of Gutin (Ref. 7) has been reduced to a suitable form for engineering use.

$$p_m = \frac{169.3 mBRM_t}{SA} \left[ \frac{0.76 P_h}{M_t^2} - T \cos \theta \right] J_{mB}(x) \quad (1)$$

where:

$p$  = rms sound pressure level ( $SPL$ )<sup>1</sup> in dynes/cm<sup>2</sup>

$m$  = order of the harmonic

$S$  = distance from propeller hub to observer, ft

$R$  = propeller radius, ft

$A$  = propeller disc area, ft<sup>2</sup>

$P_h$  = absorbed power, horsepower

$T$  = thrust, lb

$B$  = number of blades

<sup>1</sup>See Appendix A.

$M_t$  = tip Mach number

$J_{mB}$  = Bessel function of order  $mB$

$x$  = argument of Bessel function  $0.8 M_t mB \sin \theta$

$\theta$  = angle from forward propeller axis to observer

The expression gives reasonable agreement with experimental results for the first few harmonics of conventional propellers operating at moderate tip speeds and forward velocities. In these circumstances, summation of the square root of the sum of the squares of the solutions to the above expression for  $m = 1, 2, 3, 4$  will yield an adequate approximation of the overall sound pressure of the thrust and torque components. Under such conditions it is a suitable estimate of the total noise as well. Equation (1) is not of a form that makes the functional relationship between the basic geometric and operational parameters and rotational noise clear; however, Hubbard, in Ref. 8, constructed, from solutions to this equation, plots which show that the noise level increases with absorbed power, increased diameter, fewer blades, and especially with increased tip speed. In the case of the number of blades, the change in noise level is partially offset by the resulting shift in frequencies of the spectrum so that the change in loudness level<sup>1</sup> is small.

As tip Mach number is reduced to the range between 0.5 and 0.3, experimental results begin to diverge from the values predicted by Eq. (1) in the direction of higher levels. In this region, vortex noise, which originates in the variable forces acting on the medium during flow past the blade, makes itself known.

## D. Vortex Noise

An equation developed by Hubbard, which was based on Yudin's original work, additional work by Stowell and Deming (Ref. 9), and others, is frequently used to calculate vortex noise in terms of  $SPL$ .

$$SPL = 10 \log \frac{kA_b (V_{0.7})^6}{10^{-16}} \text{ (dB at 300 ft)} \quad (2)$$

where

$k$  = constant of proportionality (see Section II)

$A_b$  = propeller blade area, ft<sup>2</sup>

$V_{0.7}$  = velocity at 0.7 radius

The expression indicates that vortex noise is a strong function of blade velocity; doubling the blade velocity increases the  $SPL$  by 18 dB. The effect of doubling blade



area is less severe; the *SPL* is increased by 3 dB. This suggests that the way to reduced vortex noise is to minimize the tip velocity and to make up the required thrust by increasing blade area as far as possible within the constraints of efficiency and structure. It should be remembered, however, that the vortex noise of propellers does not become significant until the blade velocity is already below normal operational values.

Work on theoretical propeller noise prediction methods has progressed and is being continued at a relatively low level of effort at the present time. Despite the use of modern computers, which has permitted increasing degrees of sophistication, there does not seem to be a method presently available which is capable of adequate prediction of sufficient harmonics over an operating range that includes vortex noise at the low end and thickness and compressibility effects at the high end.

Although considerable experimental noise measurement work has been carried out on propellers, much of it is unsuitable for use as research material because the bandpass of the measuring equipment used was too wide to distinguish details of the spectrum at the higher frequencies. Only recently has suitable narrow bandpass equipment become generally available.

Studies with sub-scale propellers (see Ref. 10) have been used to investigate the effect on noise of such geometric parameters as the number of blades and activity factor. Even the older theories predict gross variations with geometric and operational parameters. However, the usefulness of such data in the prediction of full scale propeller noise characteristics has not yet been established. In particular, the importance of aeroelastic effects which are difficult to match between model and full scale should be studied. The results of some of the more useful experimental noise measurements on full scale propellers is summarized in Ref. 4.

Because theory has not proved to be fully adequate as a means of predicting propeller noise, a number of methods, based to some degree on experimental measurements, have evolved; these methods are intended to be either more general than presently possible with theory or to cover special conditions where the theory is inadequate. One of the most useful, judged by the criteria of simplicity of application and range of applicability, is the procedure developed at the Hamilton Standard Division of United Aircraft and presented in Ref. 4. It is reproduced here in Appendix B for the sake of convenience. The method, which is divided into two sections,

can be used to estimate either near-field or far-field noise. The accuracy of near-field estimates is given at +5 to -9 dB overall, in general, and better for certain conditions. The accuracy of far-field estimates is given as ±10dB overall at 500 ft, based on limited experimental data.

#### IV. Rotor Noise

##### A. Introduction

Aircraft employing lifting rotors presently represent the most efficient method of vertical takeoff and landing operation. Low disc loading rotorcraft may indeed represent the quietest present-generation aircraft with VTOL capability (Fig. 5). Although it may be the best system currently available, the rotor craft as a noise source will not achieve complete community acceptability. In order to make the required noise reductions for inter-city operation, it is important that the basic elements which produce the noise be fully understood. It is not, however, the purpose of this section to develop an original rotor noise prediction analysis, but merely to present some of the highlights of the current state of the art and the trends indicated.

##### B. Characteristics of Rotor Noise

1. *Ordered (rotational) noise.* The study of rotor noise has had the advantage of drawing on the knowledge gained from earlier interest in the propeller. It was found, however, that although propeller noise theory was fairly accurate in describing the sound level of the first harmonic of rotors, it was grossly in error for the higher harmonics. This is not altogether surprising when one considers the

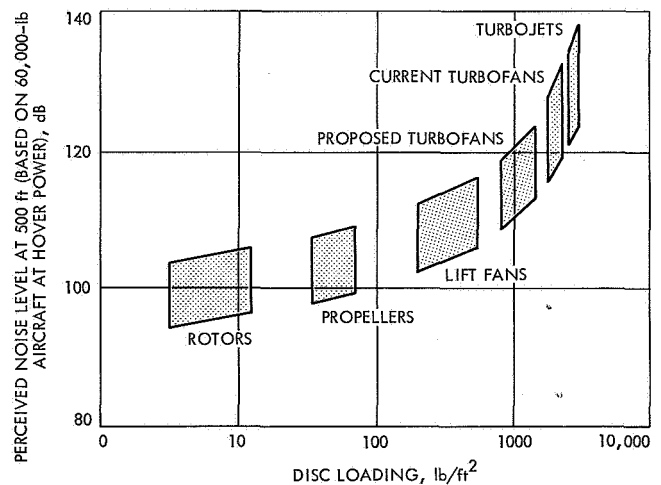

Fig. 5. Noise level as a function of disc loading

relative complexities of the two systems. The propeller that Gutin described was a rigid device rotating in steady, uniform flow. The modern rotor is quite a different system. The main feature of rotor aerodynamics is the lack of symmetry. In transitional and forward flight, the rotor disc encounters highly nonuniform inflow, and the mechanism by which forward thrust is obtained gives rise to cyclic pitch and fluctuating airloads on advancing and retreating blades. Cyclic pitch is the name given to the first harmonic variation applied to the blade pitch angle as it rotates. (For an introductory treatment of helicopter aerodynamics, see Ref. 11.) Reference 12 states that since the relative air velocity over the blade also has a first harmonic variation and since aerodynamic forces are proportional to the square of the relative velocity, one may expect to find at least three harmonics in the force fluctuations acting on the blades. However, this would be true if the flow through the rotor were uniform. Under real operating conditions, velocity fluctuations are induced which give rise to a multitude of blade loading harmonics. The calculation or experimental determination of these higher harmonic blade loads is extremely complex and has met with only limited success. Many authors (Refs. 12 through 14) are of the opinion that all the significant higher harmonic sound effects (except possibly at transonic or supersonic speeds) can be attributed to these unsteady higher harmonic loadings and, further, that any sound harmonic receives contributions from all loading harmonics. This effect is illustrated in Fig. 6, from Ref. 12, which shows Lawson's calculated contribution to a number of sound harmonics of the first 60 loading harmonics on a four-blade rotor.

Two modern rotor noise theories by Schlegel, et al. (Ref. 13), and Loewy and Sutton (Ref. 14) make use of the available harmonic loading data in their analyses. A comparison of the theoretical and experimental results from each report is presented in Figs. 7 and 8. Both investigations use substantially the same approach. The equations for sound generation from a point source are written, and expressions for the radiation from the complete rotor are obtained by integration over the rotor disc. Thickness noise and shear effects were ignored in both reports. A difference in form between the basic equations used results from the use of the Garrick and Watkins (Ref. 15) moving axis form by Loewy and Sutton and the more usual fixed axis form by Schlegel, et al. In each approach, the necessary integrals are evaluated on a computer. Both approaches retain the acoustic near-field terms in the point source radiation. (A fluctuating point force produces an acoustic pressure field that contains two components, one of which falls off as  $r^2$  and one as  $r$ ,

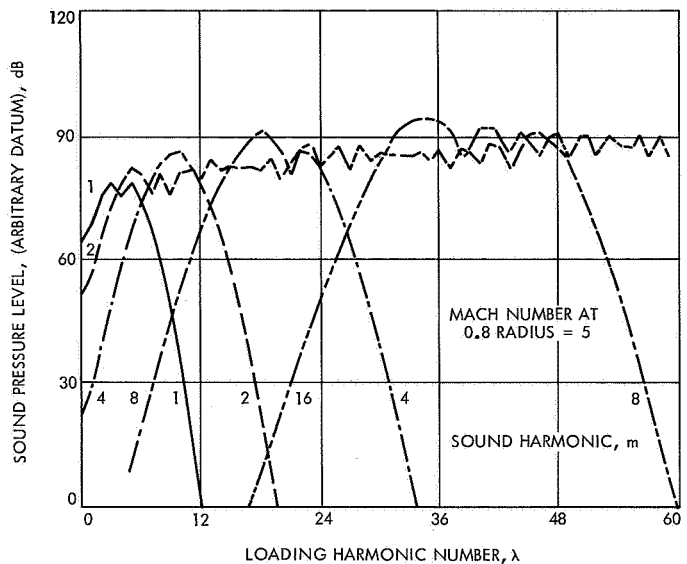

Fig. 6. Acoustic contribution of loading harmonics 10 deg below rotor disc (adapted from Ref. 12)

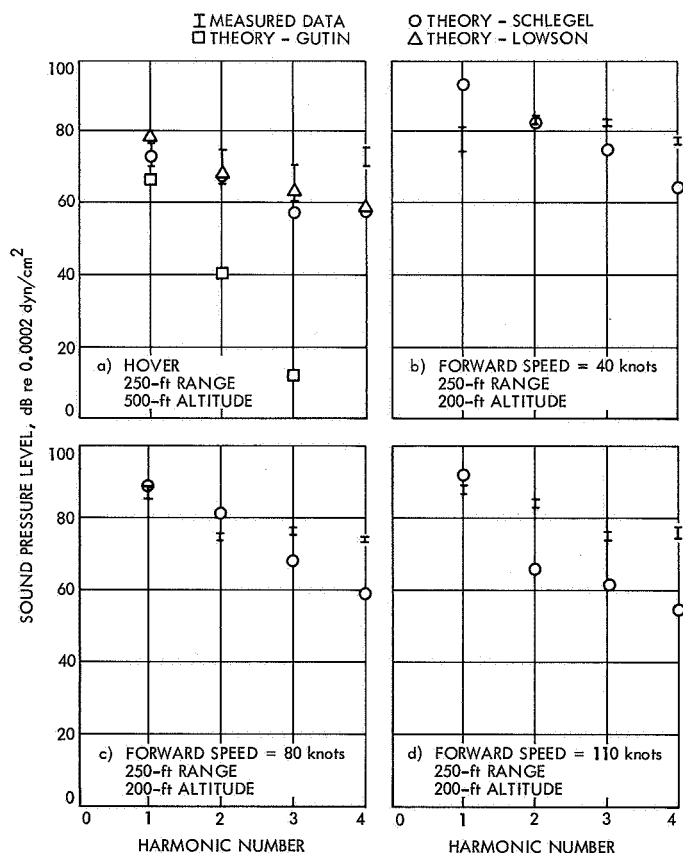

Fig. 7. Comparison of theories with experimental data at the side of a helicopter

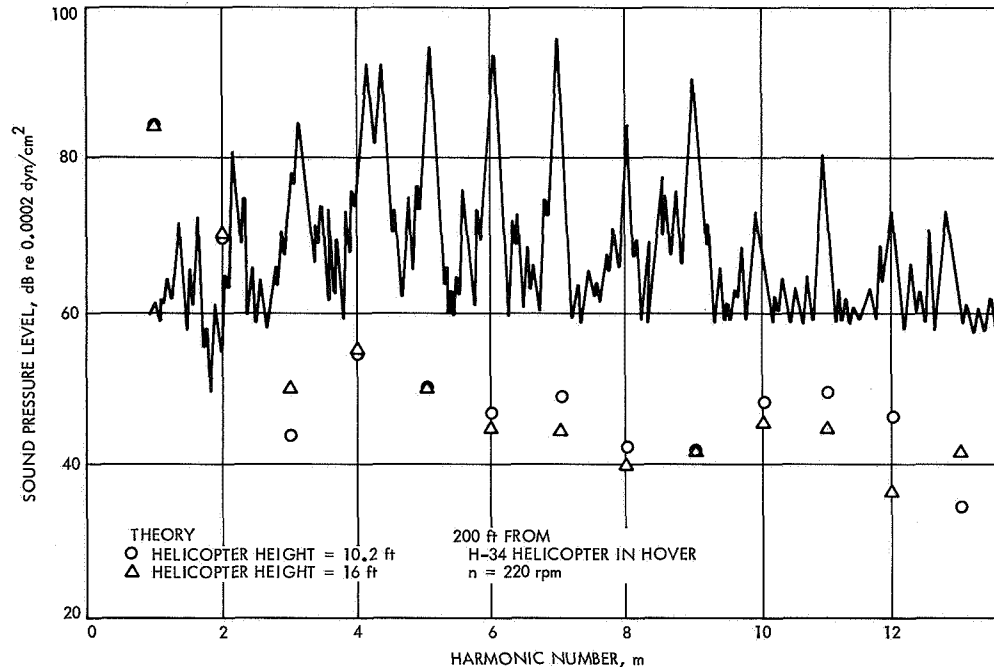

Fig. 8. Comparison of theory and experiment  
(adapted from Ref. 14)

where  $r$  is distance.) Clearly, sufficiently far away from the source, only the last (acoustic far-field) term is significant. For calculations near the source (say, a wavelength or so), the first (acoustic near-field) term must be retained. The Schlegel approach does assume a second "geometric" far-field approximation, whose terms of order  $(R/r)^2$ , where  $R$  is rotor radius, can be neglected, thus simplifying the integration. All far-field approximations will be valid sufficiently far from the rotor. Schlegel uses a rectangular distribution approximation to the chordwise loading pattern, while Loewy and Sutton use an analytic approximation. Schlegel shows detailed comparison with experimental results for only the first four harmonics. Fair agreement is found for the first two, but it is clear that underestimation of the fourth, and presumably higher, harmonics occurs. However, it should be noted that this is a substantial improvement over the use of Gutin's formula. This report shows clearly that the higher harmonics of the loading have important contributions to the higher harmonics of the noise. Loewy and Sutton came to the same general conclusions. The usefulness of these theories, then, depend on the availability of higher harmonics loading data. Rotor aerodynamics is an exceedingly complex three-dimensional problem; at the present time even the accurate prediction of low-frequency fluctuations, for the purposes of calculating blade vibration response, is a formidable task. Higher harmonic loading prediction is even more difficult, and the validity of theoretically or

experimentally generated data is very questionable at the present time.

Lowson and Ollerhead have undertaken to avoid the impasse by deriving empirical harmonic decay laws. A study of the available full-scale blade loading data revealed that the amplitudes of the airload harmonics decayed approximately as some inverse power of harmonic number, at least in the range which covered the first 10 harmonics. For steady flight out of ground effect, the optimum value for the exponent was found to be  $-2.0$  so that the amplitude of the  $\lambda$ th loading harmonic was proportional to  $\lambda^{-2.0}$ . This law was then extrapolated indefinitely to higher frequencies in order to provide some estimate of the higher harmonic airload levels. However, before this could be used as a basis for noise calculations, account had to be taken for phase variations around the rotor azimuth and along the rotor span. It was assumed that the phases could be randomized, in the case of the span wise loading variations, this was accomplished by the introduction of a "correlation length" concept such as commonly used in turbulence theory. By assuming that the correlation length was inversely proportional to frequency, this resulted in an approximate net effect of adding a further  $-0.5$  to the exponent of the loading power law. Also, an effective rotational Mach number concept is introduced which enables the effects of forward speed to be calculated directly from results for the hover case.

Using these approximations, the rotational noise spectrum for the Bell UH-1 helicopter was calculated for comparison with available measurements. The comparison is shown in Fig. 9. Because of uncertainties regarding the overall levels, they were normalized on the basis of power in the third and higher harmonics. Although for this reason, nothing can be said about overall levels; the agreement, insofar as spectral shape is concerned, is good up to the thirtieth harmonic. The calculated levels are shown for the hover case in Fig. 7a. They are only slightly better than Schlegel's theory at the fourth harmonic. Lowson made some simplifying assumptions to his closed-form analytic solution, which enabled him to develop a set of useful design charts. These charts allow the user to determine rotational noise levels for a rotor under any conditions of steady flight with a few simple hand calculations. The charts, with detailed instructions for their use and an example calculation, are shown in Appendix C. With careful use, the procedure can yield any reasonable number of noise harmonics at any point in the far field of the rotor to within 2 dB of the value obtained by computer techniques. Comparisons with experimental results indicate that, although the design charts may be in error for the overall levels, they should give the parameter trends quite accurately. The charts should be useful tools for design tradeoff studies.

**2. Broad-band (vortex) noise.** The fundamental generation mechanism of broad-band and, more particularly vortex noise from rotors is not yet fully understood. In Yudin's early work with rotating rods, vortex noise was considered to be a viscous wake-excited phenomenon and indeed it must be in that case. However, in the case of a lifting airfoil such as a rotor, the experimental evidence could support equally well the contention that it is caused by a random movement of the lifting vortex in the tip region. Stuckey and Goddard (Ref. 16) used a radial array of microphones in their rotor measurements, but were not able to locate the true center of dipole activity from their data. In view of the work by Spencer et al. (Ref. 17), Schlegel, et al., and others in reducing broad-band noise through modifications to rotor tips, it seems certain that the tip vortex does have a significant effect. Quite likely, both the tip vortex and the vortex sheet shed from the upper surface of the airfoil contribute in varying degrees depending on the configuration and operating conditions. There is evidence, however, that a portion of what was originally identified as broad-band, vortex noise may, in fact, be higher harmonic rotational noise. Lowson and Ollerhead report that the rotational noise of rotors may dominate the noise spectrum up to 400 Hz and higher. They explain this divergence from a generally held earlier

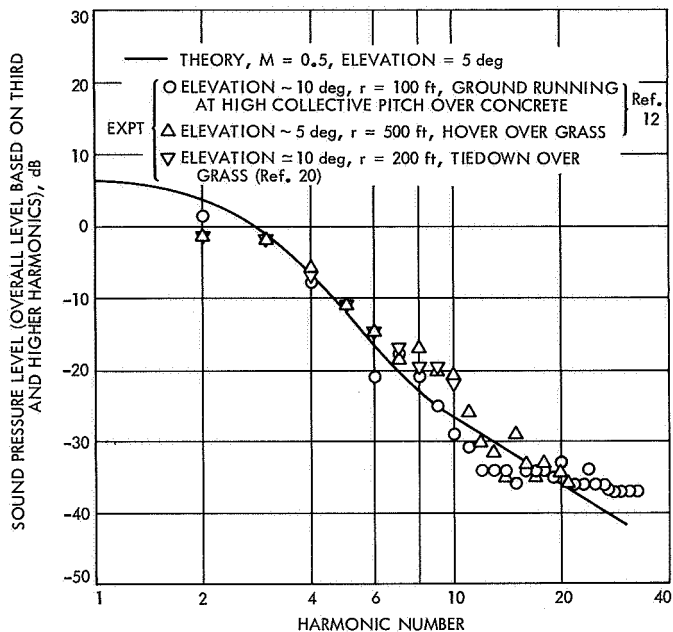

**Fig. 9. Noise spectrum; comparison of theory (adapted from Ref. 12) and experiment for a two-blade rotor (UH-1A and UH-1B)**

opinion that, above 100 Hz vortex noise became dominant by saying that the commonly used 1/3 octave analysis of experimental data does not distinguish the higher individual harmonics and that experimenters were prejudiced, since previous theoretical results predicted that rotational noise decayed more rapidly than, in fact, occurs. At any rate, broad-band noise is generated and can be dominant under some rotor operations, e.g., at very low rotational velocities with two or three bladed rotors where even higher harmonics of the blade passage frequency may be inaudible. Hubbard and Regier (Ref. 18) extended the work of Yudin and postulated that, for propellers with airfoil sections, as for rotating circular rods, the vortex noise energy was proportional to the first power of blade area and to the sixth power of the section velocity (see Section III). Hubbard's formula is based on a  $C_L = 0.4$ . Adjustment is made for other values of  $C_L$  by using an effective blade area. Schlegel reports that intensive analysis of experimental rotor test data indicated that greater accuracy could be attained by using actual blade area and coefficient of lift. He also suggests that the constant  $k$ , in Hubbard's equation (Section III, Part D) for rotor use, should be  $6.1 \times 10^{-27}$ . However, the value is not firmly established; experimental measurements, where they are available and reliable, should be used to evaluate the constant for a particular set of conditions. A systematic experimental program on vortex noise might reveal the effect of secondary variables which are at present

contained within the "constant"; the problem in evaluating the constant to a firm value may be due to the many measurement difficulties.

Variations in lift for the modified equation are accounted for by addition of the term  $20 \log C_L/0.4$ . Schlegel's resulting equation for vortex noise at 300 ft is

$$SPL = 10 \log \frac{6.1 \times 10^{-27} A_b (V_{0.7})^6}{10^{-16}} + 20 \log \frac{C_L}{0.4} \quad (3)$$

This equation yields an overall level only and has no provision in itself to indicate spectrum shape. Theoretically, frequencies of vortex noise form a continuous spectrum from near-zero to a cutoff frequency which depends upon the rotational speed of the tip. Schlegel has gained some insight by experimental methods into vortex octave band spectrum shape of a blade operating out of stall as shown in Fig. 10a. This condition is present at low angles of attack at the tip. The peak frequency  $f$  is defined as

$$f = \frac{St(V_{0.7})}{h}$$

and is the Strouhal frequency at the 0.7 radius station for a constant Strouhal number of 0.28. (This is satisfactory for the usual range of Reynold's numbers for a helicopter rotor.) When unsteady aerodynamic forces appear near the tip of a blade, due to the occurrence of either stall or drag divergence, there is a definite change in the spectrum shape. Figure 10b represents the general spectrum shape of a blade operating under these conditions,

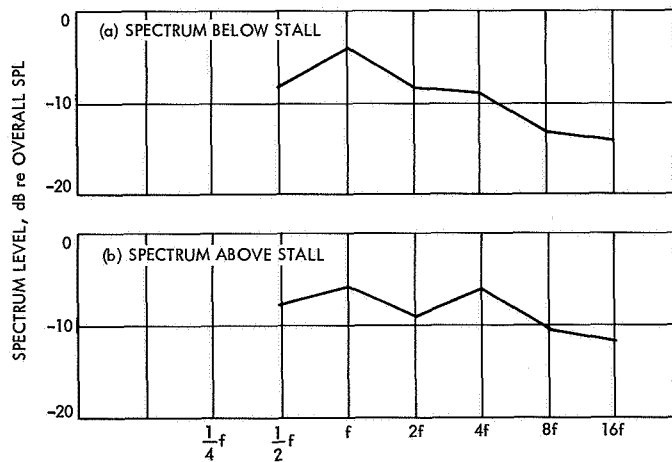

Fig. 10. Octave band vortex noise spectrum below stall (a), and above stall (b), (adapted from Ref. 13)

as presented by Schlegel. It is evident that the separated flow has caused a rise in the levels of the octaves above the peak octave. Therefore, from Eq. (3) and Fig. 10, one may predict the vortex noise octave band spectrum for a rotor blade operating in or out of stall. The method and an example problem is presented for convenience in Appendix C.

Sadler and Loewy (Ref. 19) have taken a unique view of the problem of rotor noise prediction. Their approach involves the simultaneous consideration of both the rotational and vortex shedding effects. While some improvement in predicted noise over Loewy and Sutton's earlier report is achieved, noise levels at harmonics of the blade passage frequency still were not predicted accurately. A comparison between the theory and measured data from a UH-1 helicopter in hover is presented in Fig. 11. The inaccuracy may be due to deficiencies in the theory, or it

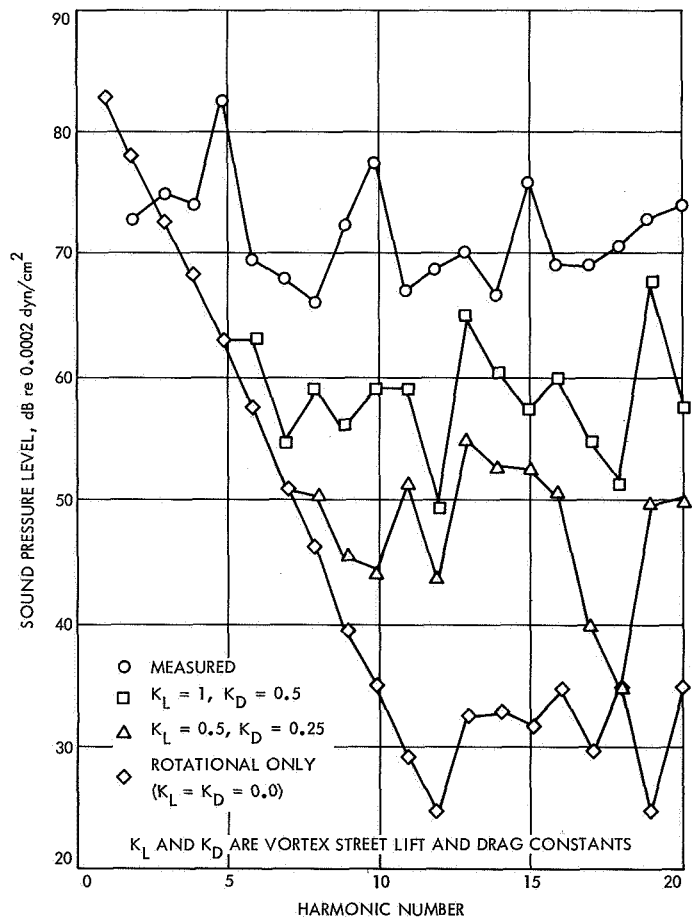

Fig. 11. Comparison of computed SPLs vs harmonic number for various  $K_L$  and  $K_D$ , with measured SPLs for a UH-1A helicopter in hover, (adapted from Ref. 19)

may be due to deficiencies in the experimental airload data, which are again required for the calculation of the higher harmonics of the rotational noise.

**3. Modulation (blade slap) noise.** Rotors suffer more from modulation and distortion noise than any other aerodynamic noise generator. Slowly rotating, large-diameter rotors typically exhibit recognizable amplitude modulation and Doppler effects due to source rotation with respect to a stationary observer. Neither this amplitude or frequency modulation generally adds to the disturbance or annoyance level of a helicopter, although it may lower the level of detectability. Blade slap, the colloquialism that has been applied to the sharp cracking sound associated with helicopter rotors, is by far the most annoying of any of the rotor noise sources. Until recently, only Ref. 20 has dealt with the problem of blade slap in any detail. A large section of Schlegel's work was devoted to blade slap; more recently, Spencer et al. presented a paper connected solely with the practical aspects of blade slap. To date the only attempt at a quantitative study of the problem seems to be the papers published by Leverton and Taylor (Refs. 21 and 22). In the latest, Leverton lists the three main mechanisms generally postulated for blade slap in the literature:

- (1) Fluctuating forces caused by blade-vortex interaction.
- (2) Fluctuating forces resulting from stalling and unstalling of the blade.
- (3) Shock wave formation due to local supersonic flow; it is suggested that this is either (a) a direct result of operating a blade at a high tip speed or (b) caused by a blade vortex interaction.

At the present time, detailed information on these mechanisms is still limited; therefore, it is almost impossible to state which is the most likely mechanism. However, a blade intersecting the tip vortex shed by a preceding blade could itself cause the other two mechanisms to occur. Leverton assumes that blade slap is the direct result of the fluctuating lift caused by the interaction of a blade and a vortex filament. This can either be an actual intersection when a blade cuts a vortex filament or the effect of a blade passing very close to a vortex filament.

Although it is easy to imagine a blade and a tip vortex intersecting, it is extremely difficult to visualize the details of such an encounter and practically impossible to describe it mathematically. As a blade intersects or comes near a vortex filament, the blade circulation, and hence the lift

profile, will become severely distorted. On a single rotor lift system, a blade will most likely pass near, or cut through, a tip vortex shed by a preceding blade (Fig. 12a). On a tandem rotor lift system, it is more likely that one rotor will cut the vortex filament generated by the other disc (Fig. 12b). The fact that large fluctuations in lift occur when a blade passes close to a vortex filament is obvious. Figure 13, taken from Ref. 23, is an attempt to depict the interference between the rotor blade and the tip vortex. When the aircraft is accelerating and climbing, it moves away from the tip vortex helix. Conditions are similar for autorotating descents. The intersection occurs when the aircraft is flying at a low descent rate or with the rotor unloaded. The rotor then moves through its own tip vortex system.

Leverton states that the "peak" velocity amplitude encountered by the blade will be practically independent of the type of interaction; thus, noise from any intersec-

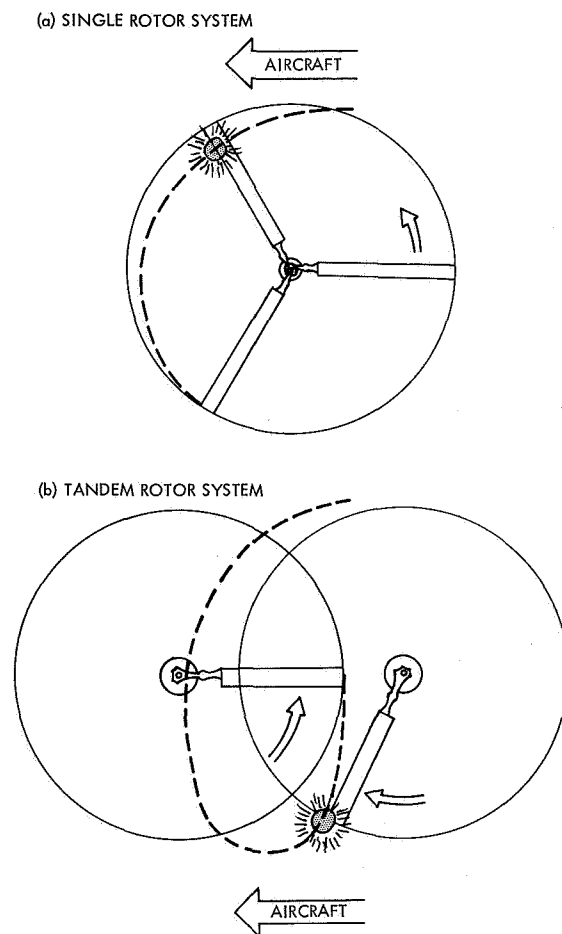

**Fig. 12. Typical blade-vortex intersections for a single rotor system (a), and a tandem rotor system (b)**

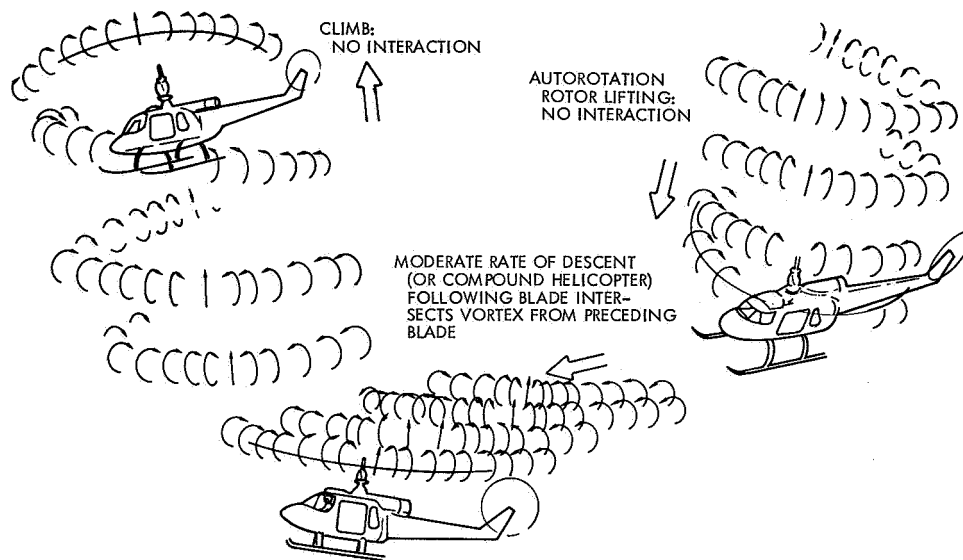

Fig. 13. Tip vortex locus as a function of several operational modes

tion, to a first approximation, will be dependent only on the vortex size and blade parameters. Spencer et al. experimented with various rotor tip designs to modify the induced velocity structure of the tip vortex. Results indicated that the maximum velocities induced within the vortex core could be reduced to about 12% of those for a standard tip. However, drag data indicated that most configurations adversely affected performance. Unfortunately, no acoustic measurements that would determine the quantitative effect on blade slap intensity were made.

Leverton has developed a blade-slap theory that has proved to be quite limited due to simplifying assumptions and lack of adequate vortex profile data. He assumes that the blade span and chord width effects of the vortex are small and that the blade does not deflect while intersecting a vortex filament. His results are compared with subjective assessments and are found to be indicative, at best, for only small chord rotor systems with less than three blades. A more detailed description of the strength and geometry of specific blade-vortex interactions is necessary before satisfactory prediction methods will be available.

### C. Rotor Noise Alleviation

Rotor noise technology and experience indicate several obvious and a few more subtle methods for reducing the noise generated by lifting rotor systems. Theory indicates that noise output is proportional to the product of thrust and disc loading. Eliminating thrust as a design variable,

the most obvious method of reducing disc loading is increasing the rotor diameter. Tip speed has been shown to be an important parameter in two ways: through the direct effects of Mach number (compressibility and drag divergence) and through blade-wake spacing. For a given rotor producing a given amount of thrust, the downward velocity of the blade wake is essentially constant, so that the vertical distance between a blade and the vortex trailing from the tip of the previous blade is increased by reducing the tip speed. To do this, collective pitch must be increased. Lowson (Ref. 12) shows that radiated sound rises substantially at both high and low values of collective pitch and suggests that an optimum collective pitch setting for minimum noise exists. The basic mechanism of increasing collective pitch is to increase the displacement of the shed vortex wake further beneath the oncoming blade so that harmonic airloads are substantially reduced. The use of high-lift airfoil sections on the rotor blades is another way of increasing wake displacement. Davidson and Hargest (Ref. 24) suggest another method of reducing boundary layer separation and turbulent wake interaction: A blade with direct circulation control would not depend on pitch for lift generation, and the higher its lift coefficient, the more stable its wake and boundary layer becomes, because the control of circulation naturally implies some control of the boundary layer. The jet flap rotor appears favorable in these respects although a trade-off of the jet noise itself must be made.

Another possible method of noise reduction is to decrease the activity factor by increasing the number of blades or distributing the load over a larger blade chord.

Tandem rotor lift systems exhibit some undesirable, as well as desirable, noise features. With two large-diameter, low-disc-loading counter-rotating rotors, the noisy tail rotor (more nearly a propeller) may be eliminated. The obvious and relatively serious problem is the rotor-wake interaction. If the two overlapping rotors can be separated to operate in a diffused wake region and vortex interactions can be minimized, a relatively low-noise vehicle could result. However, this represents a difficult design problem.

In an effort to improve the rotor efficiency with a spanwise elliptical lift distribution, Schlegel found that his trapezoidal tips resulted in vortex noise reductions of 7 to 10 dB. Apparently the tip vortex strength is a significant factor in the generation of vortex noise and may be effectively alleviated with proper design considerations. Spencer et al. showed that they could reduce the induced velocity in the tip vortex and proposed this as a method of reducing the intensity of blade slap. However, it appears that the easiest way to reduce blade slap is to operate under flight conditions that avoid blade-vortex interaction altogether.

Major design requirements for minimum noise can be summarized as follows:

- (1) Low tip speed.
- (2) Large number of blades.
- (3) Low disc loading.
- (4) Large blade chord.
- (5) Minimum interference with rotor flow.
- (6) Any features that will reduce the high-frequency airload fluctuations.

## V. Lift Fan Noise

### A. Introduction

The lift fan, in terms of disc loading, falls between the ducted propeller (low-disc loading) and the jet lift engine (high-disc loading). The ducted propeller consists of a relatively conventional propeller having a small number of blades which are enclosed at the tips by a surrounding shroud or duct supported by radial struts attached behind the propeller to the shaft housing or engine mount. Because it operates at very low pressure ratios, the ducted propeller does not require stators, and the main noise source is rotational noise. On the opposite boundary is the lift engine, which operates in the lift mode with its axis approximately vertical; it can be either a straight

turbojet or a bypass engine (fanjet). There is no sharp demarcation between this latter type and the hub-driven lift fan, but the lift fan does operate at higher bypass ratios. Bypass ratios of as much as 20 are under consideration for lift fans.

A second type of lift fan is the tip turbine driven fan, which might appear as shown in Fig. 14, taken from Ref. 23. The exhaust gas from the engine flows into the scroll; from there, it is distributed circumferentially around the fan to locations where it is exhausted through nozzles into the tip turbine, an integral part of the fan rotor. The number of turbine blades is typically much greater than the number of fan blades; the blade passage frequency of the turbine will fall near the upper limit of audibility, resulting in subjective noise, which is quite low, from this source. In any case, the pressure ratio of the lift fan is higher than that of the ducted propeller. When a stator is employed, it is usually close to the rotor in order to minimize engine volume and weight. Rotor-stator interaction may be the primary source of noise in that case. Lift fans of either the tip turbine-driven or the hub-driven types have many blades and may require stators if higher pressure ratios are desired.

### B. Noise Sources of Fans

The general form of the frequency spectrum of fan noise is a broad spectrum extending over a wide range of frequencies, with its maximum level usually at frequencies of the order of  $0.2 U/d$ , where  $U$  is the representative velocity (such as tip speed) and  $d$  is the representative length (such as motor diameter). Superimposed on the broad-band spectrum are discrete frequency peaks that occur at the fundamental blade passage frequency and its harmonics. The relative strength of the discrete frequency component diminishes, relative to the broad-band noise, as tip speed is decreased. It has been found that overall noise level from fans varies approximately as tip velocity to the sixth power.

There appear to be two possible sources of broad-band noise: (1) noise from vortex shedding at the blade trailing edges, and (2) noise from turbulent velocity fluctuations in the duct. When the flow into the duct is aligned with the fan axis of rotation, noise from turbulent velocity fluctuations is mainly confined to the duct boundary layer. Here it is quite possible that it makes a contribution to the over-all level, either directly or through enhancement, of the vortices shed from the blade trailing edges near the blade tips. However, when the flow into the duct enters at an angle of attack, as would be the case when a lift fan aircraft is in transition to forward flight, the turbulence



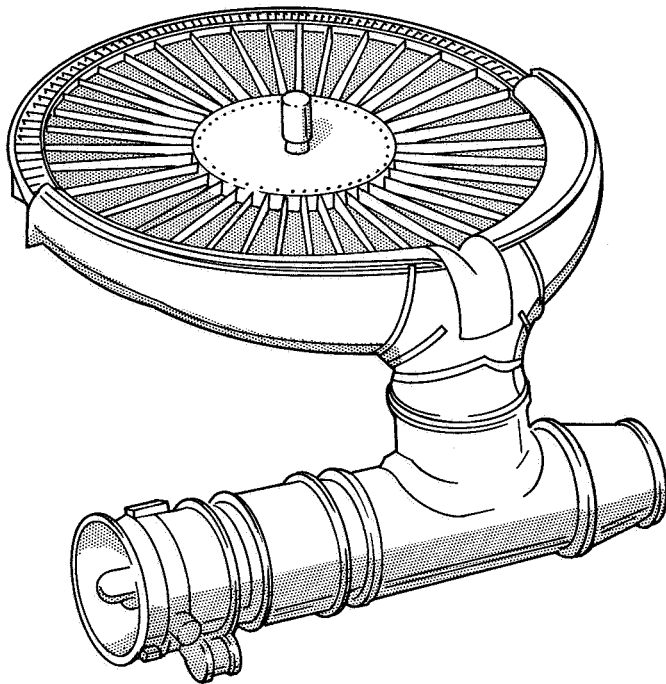

Fig. 14. Typical tip-turbine-driven lift fan

level of the flow throughout the duct will be increased. This will cause an increase in the overall sound level. Sharland, in Ref. 25, has shown that the sensitivity of noise to inflow angle increases with increasing blade tip speed.

One source of discrete frequency noise from a rotating propeller arises from the periodic excitation of an element of air at a fixed point which feels a force fluctuation each time a blade element with its associated pressure field passes by. The fundamental frequency is that blade passage frequency and a number of harmonics will also be present, dependent on the shape and duration of the pulse relative to the period of a complete cycle. The methods developed from theory for the prediction of propeller rotational noise may at first appear applicable to the case of a single fan rotor. However, propeller theory is not known to be accurate for configurations that do not have the small number of blades and high span-to-chord ratio of the conventional propeller. The close spacing of blades will lead to interactions between individual blade pressure fields and wakes. The boundary conditions of the duct wall, which are imposed on the fluctuating flow, suggest that the distribution and strengths of the acoustic sources on the blades may be altered. The use of conventional propeller rotational noise estimation methods to predict the rotational noise of a fan considered as a free running propeller of the same geometry led, in at least one case, to calculated noise levels far below the measured

values. Even if good agreement had been obtained, presently available data do not show what the effect of the ducting would be.

In propeller noise theory, the forces acting on a blade are considered to be steady; the periodic fluctuations occur at points fixed in space as the blade passes. In a fan, however, the aerodynamic forces acting on the blade itself can be periodically fluctuating because of passage of the blade through a periodically varying velocity field. This condition occurs when the rotor is operating in the wake of support struts, stators, or inlet guide vanes. Theoretical analysis and test data have shown that this unsteady blade loading is greater than the propeller type noise and is the dominate source of discrete frequency noise in fan systems using closely spaced stators. Reductions in noise levels of from 4 to 22 dB have been obtained experimentally through the removal of stator rows. Figure 15, taken from Ref. 23, shows the effect of rotor-stator spacing on perceived noise level.

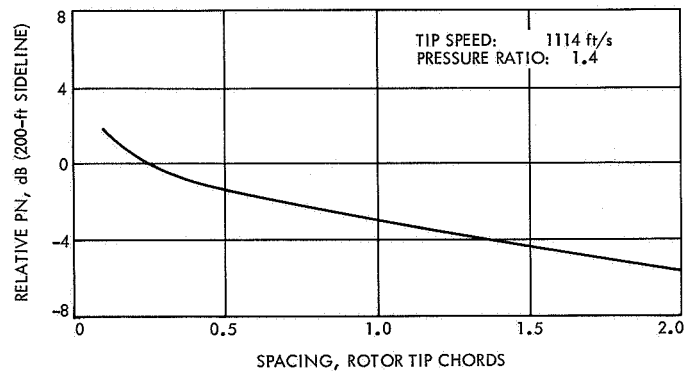

Fig. 15. Effect of rotor-stator spacing (adapted from Hickey, Ref. 23)

### C. Scaling Law

As an improvement over an older method of predicting compressor and fan noise by scaling on shaft horsepower, Sowers (Ref. 26) has developed a method that normalizes a large amount of experimental data into a single curve using an energy flux concept (Btu/s ft<sup>2</sup>) and the scaling parameter

$$10 \log \frac{A_a n}{B} \left( \frac{D_H}{D_T} \right)^2$$

where:

$A_a$  = rotor annulus area, ft<sup>2</sup>

$n$  = rotor rpm

$B$  = number of rotor blades

$$\frac{D_H}{D_T} = \text{ratio of rotor hub to rotor tip diameter}$$

The normalized acoustic performance curve from Ref. 26 is shown in Fig. 16. This empirical curve is based on a considerable amount of data on designs ranging from a 62-in. VTOL lift fan to scale model compressors. The abscissa represents the total energy of the air leaving the fan or compressor rotor stage on a per unit time and area basis. The ordinate of the curve was obtained by Sowers from a parametric study of various design parameters and associated noise data. Details of a noise prediction method using Fig. 16, as developed by Sower, are presented in Appendix D.

The method appears to normalize a large amount of available data within an acceptable degree of accuracy and is one means by which fan noise may be predicted. One common characteristic of all data shown in Fig. 16 is a relatively close rotor-stator spacing. Some effects of increasing this spacing have been shown in Fig. 15. As more data become available, the effect of this parameter in the terms of Fig. 16 should be investigated. Data from

the limiting case of no stators over a range of energy flux values should be used to determine if a family of curves for different rotor-stator spacing is required. For the present, the effect might be estimated by making a correction to the sound pressure level obtained by the method given above.

In a recent paper (Ref. 27) Hargest characterizes the problem of fan noise prediction as being extremely difficult to quantify and states that fan designs must be examined in fine aerodynamic and mechanical detail in order to make realistic noise estimates.

To illustrate the complexity of the situation, he lists the following potentially significant parameters:

- (1) Inlet pressure.
- (2) Inlet temperature.
- (3) Temperature rise.
- (4) Pressure rise.
- (5) Tip diameter.
- (6) Hub diameter.

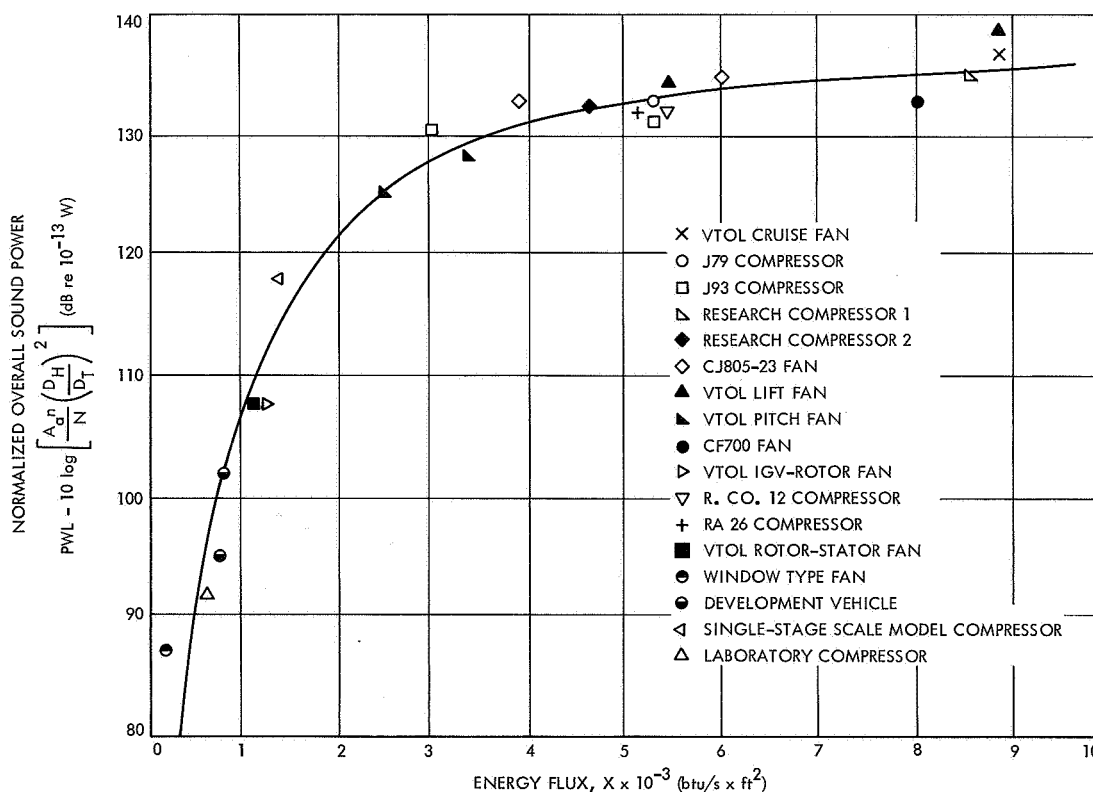

Fig. 16. Normalized overall power of compressor and fan noise (adapted from Ref. 26)

- (7) Number of blades.
- (8) Blade chord.
- (9) Rotor-stator spacing.
- (10) Number of stages.
- (11) Mass flow.
- (12) Deviation from optimum incidence.
- (13) Power.
- (14) Rotational velocity.

To which might be added, for a particular fan installation, effects of duct configuration, turbulence level, and guide vane effects.

Although it is clear that the present methods of estimating fan noise cannot be used for more than very preliminary purposes, and even then with caution, they are able to give indications of the direction which the design of quiet fans must take. Some workers (Ref. 28) expect advanced lift fans of practical design to be operating in the vicinity of 95 PNdB at 500 ft, by the mid-1970s. This represents a reduction in noise level over present multistage fans or single stage with inlet guide vane designs of 25 PNdB due to improved design.

The effects of atmospheric attenuation are worthy of discussion, since they may represent a significant advan-

tage which the lift fan has over other lift devices. Figure 17, taken from Deckert's paper in Ref. 23, shows the attenuation of noise levels for several STOL designs. The figure shows that the propeller-rotor-driven aircraft generate less perceived noise up to about 2,000 ft, but beyond that point the lift fan aircraft becomes appreciably more quiet. This occurs because a greater portion of the acoustic energy of the lift fan aircraft is generated at the higher frequencies where atmospheric attenuation is greater.

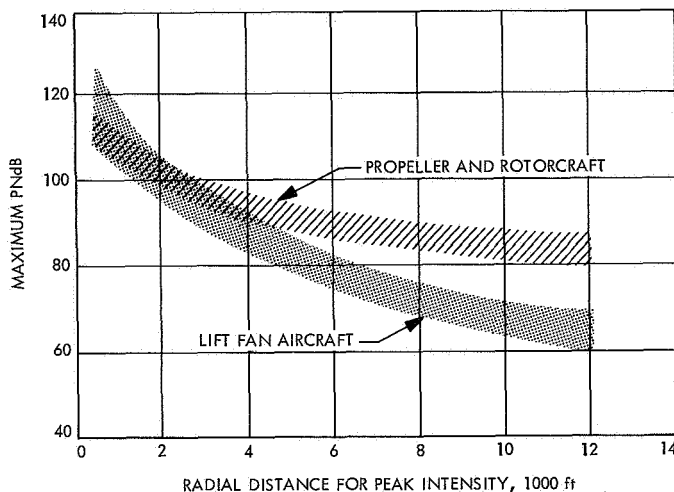

Fig. 17. Noise generated by STOL aircraft, 50,000 to 95,000 lb gross weight (adapted from Deckert, Ref. 23)

## Appendix A

### Explanation of Some Fundamental Terms

While no attempt at assembling a complete glossary of terms used in acoustics is intended, these explanations of some of the more important terms used here and elsewhere in the literature may be useful to the reader who is unfamiliar with the field.

#### Sound Power

One of the principal characteristics of a sound source is its ability to radiate power in the form of acoustic waves. If energy losses to the air are neglected, then all of the sound power  $W$  must pass through any surface completely enclosing the source, and therefore  $W$  is independent of distance from the source.

#### Sound Intensity

The intensity  $I$  of a sound is the average rate at which power is radiated through a unit area normal to the direction of wave propagation ( $W/m^2$ )

$$I = \frac{W}{S} \quad (A-1)$$

where  $S$  is total surface area. This term is difficult to measure directly.

#### Effective Sound Pressure

Because the voltage outputs of the microphones commonly used in acoustic measurements are proportional to pressure, sound pressure is the most readily measurable variable in a sound field. Effective sound pressure is defined as the square root of the mean-square (rms) of the instantaneous sound pressure at a point over a time interval according to the equation

$$p = \left[ \frac{1}{T} \int_0^T p'^2(t) dt \right]^{1/2} \quad (A-2)$$

where  $p'$  is the instantaneous sound pressure, i.e., the incremental change from atmospheric pressure caused by the passage of a sound wave over the point, and  $T$  is the time interval over which the sample is considered. For free progressive plane and spherical waves, there is a simple relationship between the mean-square sound pres-

sure and the intensity

$$I = \frac{p^2}{\rho c} (W/m^2) \quad (A-3)$$

where  $p^2$  is the mean-square sound pressure (microbar);  $\rho$  is the density of air ( $kg/m^3$ ), and  $c$  the speed of sound in air (m/s).

#### Sound Power Level

Because of the very wide range of radiated acoustic power from common sources (ranging, for instance, from a radiated sound power of  $10^7$  W for a large rocket engine to  $10^{-9}$  W for a soft whisper) a logarithmic scale which describes the ratio of a particular power relative to a reference power has been employed for convenience. The unit implying a given ratio between two powers is called the decibel (dB) and may be defined as

$$\text{Sound-power level} \equiv \text{PWL} = 10 \log \frac{W}{W_{ref}} \text{ dB re } W_{ref} \quad (A-4)$$

The term, level, added to any acoustically related quantity is used to indicate a logarithmic rather than linear scale. The reference power level is usually defined as having a value of  $10^{-13}$  W. Sound power level is conveniently used to determine overall noise magnitude regardless of the location of the noise, because it is not a function of distance from the noise source.

#### Sound Intensity Level

A decibel scale for sound intensity level can be defined by using a ratio of quantities proportional to sound power (Eq. A-4) just as was the sound power scale

$$\text{Intensity level} \equiv \text{IL} = 10 \log \frac{I}{I_{ref}} \text{ re } I_{ref} \quad (A-5)$$

The reference intensity  $I_{ref}$  is usually taken as  $10^{-12}$  W/m<sup>2</sup>.

#### Sound Pressure Level

Again, by means of Eqs. (A-1) and (A-3), a decibel scale for effective sound pressure can be defined as a ratio of quantities proportional to acoustic power as

$$\begin{aligned} \text{Sound pressure level} \equiv \text{SPL} &= 10 \log \frac{P^2}{P_{ref}^2} \\ &= 20 \log \frac{P}{P_{ref}} \text{ re } P_{ref} \end{aligned} \quad (\text{A-6})$$

where  $P_{ref}$  is commonly taken as 0.0002 dynes/cm<sup>2</sup> or equivalent. This value was chosen because it approximately represents the hearing threshold at 1000 Hz for a young man with normal hearing. The reference value for sound intensity was set at  $I_{ref} = 10^{-12}$  W/m<sup>2</sup> in order that the intensity level and sound pressure level would be nearly equal numerically for plane or spherical waves in air at room temperature and sea level pressure. Likewise, the reference sound power,  $W_{ref} = 10^{-13}$  W was chosen so that the sound power level and sound pressure level would be approximately but simply related to each other when the area of the surface being considered is in square feet. The relationship is

$$\text{SPL} \doteq \text{PWL} - 10 \log S \text{ dB re } 0.0002 \text{ dynes/cm}^2 \quad (\text{A-7})$$

where  $S$  is the surface area through which the sound power is radiated, ft<sup>2</sup>.

### Spectrum Level

The spectrum level at a specified frequency is the sound pressure level within a band 1-Hz wide centered at the frequency. The unit is the decibel.

### Overall Sound Pressure Level

This unit, which is a logarithmic measure expressed in decibels, is the simplest form of acoustical measurement. It merely expresses the maximum pressure experienced without regard to frequency or any other effect.

### Weighted Sound Pressure Level

Since human hearing does not have a flat frequency response, sound level meters incorporating weighting networks (which essentially provide the instrument with a hearing response more typical of the human ear) were designed. Sound level measurements made with such meters are usually referred to in terms such as dBA or dBB where A and B describe particular frequency weighting networks. The notation dBC is essentially that of a flat response and therefore is the same as overall sound pressure level.

### Octave Band Spectrum

Recognizing that noise must be described by both amplitude and frequency, a common measurement system used to describe the full range of frequencies is sound pressure level by octave band. In this case, the spectrum is analyzed through filters, each of whose center frequency is twice that of the preceding one. This describes the noise in terms of eight or nine sound pressure levels, each associated with its own center frequency. Although these measurements do describe both the amplitude and the frequency characteristics of a given sound, they are not convenient to use when one thinks of criteria or evaluation numbers, because they do not provide a single index that represents any specific characteristic of the particular sound.

### Loudness Level

In an effort to return to a single number rating which might be more indicative of the effect that a complete spectrum would have on an individual, the concept of loudness level was developed (Ref. 29) in which the sound pressure level in each octave band was given a weighting which was a function of hearing sensitivity in that octave band. This provides more emphasis on the middle frequency range in which hearing is most acute and de-emphasizes the extreme ends of the spectrum. The standard sound has been chosen to be a 1000-Hz tone. The loudness level of any other sound is defined as the sound pressure level of a 1000-Hz tone that sounds as loud as the sound in question. The unit of the loudness level is the phon. For example, if a 1000-Hz tone with a sound pressure level of 70 dB re 0.0002 microbar sounds as loud as a certain square wave, the square wave is said to have a loudness level of 70 phons.

### Perceived Noise Level

Recognizing that loudness level might not necessarily describe a more subjective reaction such as annoyance, Kryter (Ref. 30) introduced the concept of perceived noise level (PNdB). This method, which was originally used for jet aircraft noise ratings, is similar in application to loudness level, but the weighting scale developed was based on annoyance criteria rather than simply on equal loudness.

### Effective Perceived Noise Level

Recent research, still in progress, has further refined the perceived noise level concept by inclusion of factors to express the added annoyance due to time duration to which a subject is exposed to the noise, and the presence

of pure tones, which prove more irritating than broad-band noises of the same sound pressure level. The unit of effective perceived noise level is the decibel EPNdB.

A more detailed discussion of the subjective corrections and associated terms together with methods of computation is contained in a recent report by Sperry (Ref. 31).

## Appendix B

### Generalized Propeller-Noise Estimating Procedure<sup>2</sup>

In order to fulfill the increasing need for a simple generalized method of estimating near- and far-field propeller-noise levels during the design of military or civilian aircraft, a method, based in part on information in the referenced literature, has been developed. The method is divided in two parts: (1) estimate of near-field propeller noise (defined as noise at locations within one propeller diameter of the propeller tip), and (2) estimate of far-field propeller noise (defined as noise at locations greater than one propeller diameter from the propeller tip). In each case, a sample estimate follows the description of the estimating procedure.

The accuracy of near-field estimates was determined from a comparison of estimated levels with measured levels of various propellers of several diameters during test stand and in-flight operation. In general, the accuracy of estimated near-field overall and fundamental frequency noise levels were found to be within +5 to -9 dB of measured levels. However, for propellers up to 15 ft in diameter, where the tip Mach number to horsepower ratio is less than 0.003 (i.e.,  $M_t/HP < 0.003$ ), estimated overall and fundamental frequency noise levels were within  $\pm 3$  dB of measured levels.

Only limited, measured far-field data were available for comparison with estimated levels; however, for the few comparisons made (at distances up to 500 ft) estimated overall levels were within  $\pm 10$  dB of measured overall levels. For distances greater than 500 ft, the accuracy of far-field noise estimates is limited even further by variable atmospheric parameters such as temperature distribution, wind direction, wind velocity, atmospheric absorption and humidity. Therefore, estimates of noise at great distances from a propeller using the attached method should be considered only as first approximations under ideal conditions.

#### A. Estimate of Near-Field Propeller Noise

The steps in determining near-field propeller-noise levels on the fuselage (see Fig. B-1a) during static and dynamic conditions are:

<sup>2</sup>The procedure was extracted as a unit from Ref. 4 and is presented here for convenience.

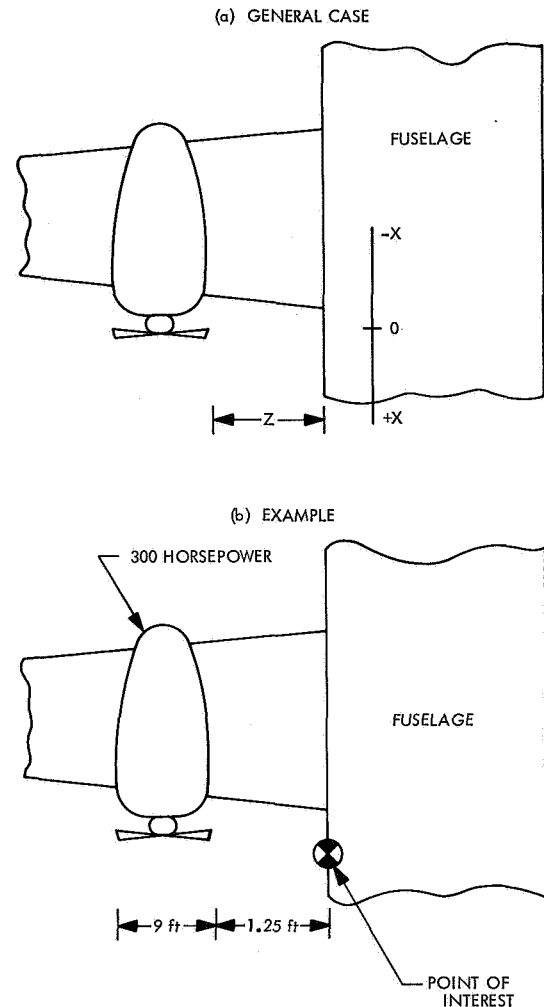

**Fig. B-1. Near-field axis system**

- (1) Obtain a reference level  $L_1$  from Fig. B-2. This gives a partial level based on the power input to the propeller.
- (2) Calculate the correction to the partial level for number of blades and propeller diameter; add  $20 \log 4/B$  where  $B$  is the number of blades; and add  $40 \log 15.5/D$  where  $D$  is the propeller diameter in feet.
- (3) Obtain the correction factor from Fig. B-3. This accounts for the rotational speed of the propeller ( $M_t =$  in-plane tip Mach number) as well as the

distance from the point of interest to the propeller disc.

- (4) Obtain the correction factor from Fig. B-4. This corrects for fore and aft (with reference to the plane of propeller rotation) fuselage position.
- (5) Obtain the correction factor from Fig. B-5. This accounts for the effect of a reflecting surface (fuselage) in the sound field.
- (6) Sum the data from steps 1 through 5 to estimate the overall sound pressure level at the point of interest.
- (7) The harmonic distribution of the noise estimated in steps 1 through 6 is found in Fig. B-6. ( $M_h$  = true tip Mach number, including the forward flight component.)
- (8) The harmonic levels of step 7 are combined using the chart in Fig. B-7 to derive octave band levels.

### B. Sample Calculation of Near-Field Noise

A sample calculation of near-field noise (see Fig. B-1b), using the method described in the preceding paragraphs, is presented here.

Aircraft speed $V_f$	125 knots = 210 ft/s
Propeller diameter $D$	9 ft
Power to propeller	300 hp
Propeller speed $n$	1584 rpm
Number of blades $B$	3
Radial distance $Z$ from propeller to interest point	1.25 ft
Fore/aft distance $X$ from propeller to interest point	0 ft
Speed of sound $c$	1125 ft/s

	Partial noise level, dB
Step 1. From Fig. B-2, $L_1$	121.0
Step 2. Add $20 \log(4/3)$	+2.5
Add $40 \log(15.5/9)$	+9.5

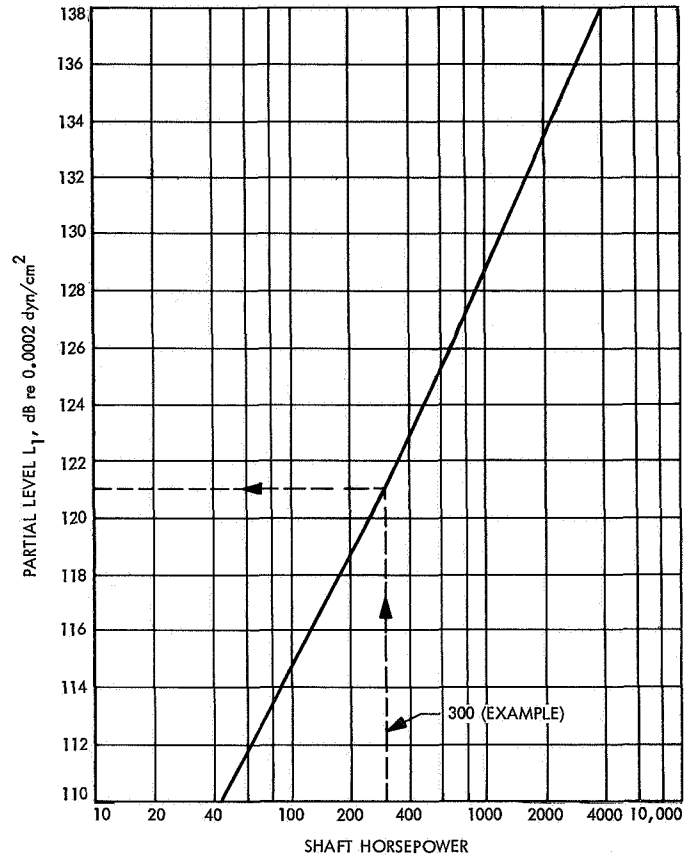

Fig. B-2. Reference level

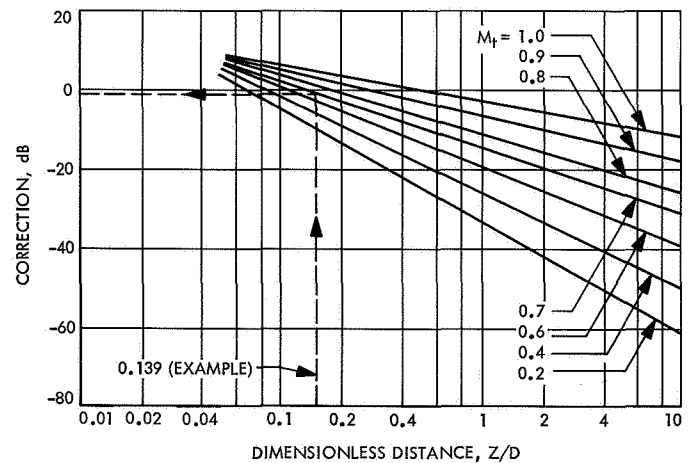

Fig. B-3. Correction for speed and radial distance

Step 3.  $Z/D = 1.25/9 = 0.139$   
 $V = \pi \cdot D \cdot n/60 = 3.14 \cdot 9 \cdot 1584/60 = 746 \text{ ft/s}$   
 $M_t = V_t/c = 746/1125 = 0.66$   
 Then, from Fig. B-3, the correction is:

-1



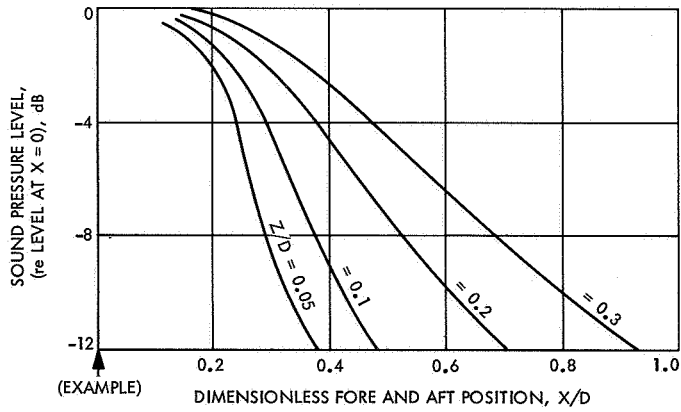

Fig. B-4. Variation of over-all, free-space propeller noise levels with axial position X/D fore and aft of propeller plane

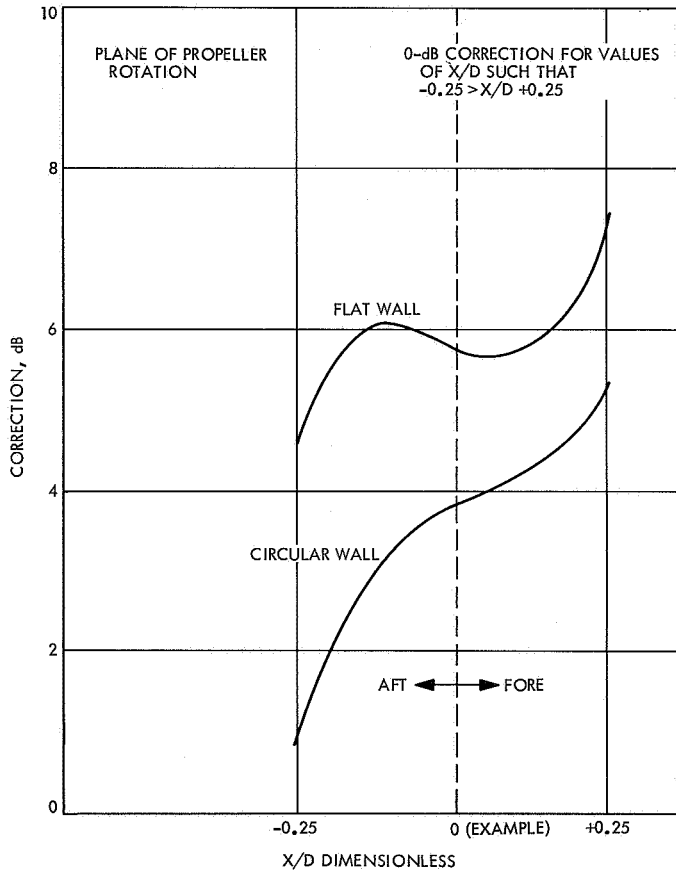

Fig. B-5. Effect of reflecting surfaces in pressure field

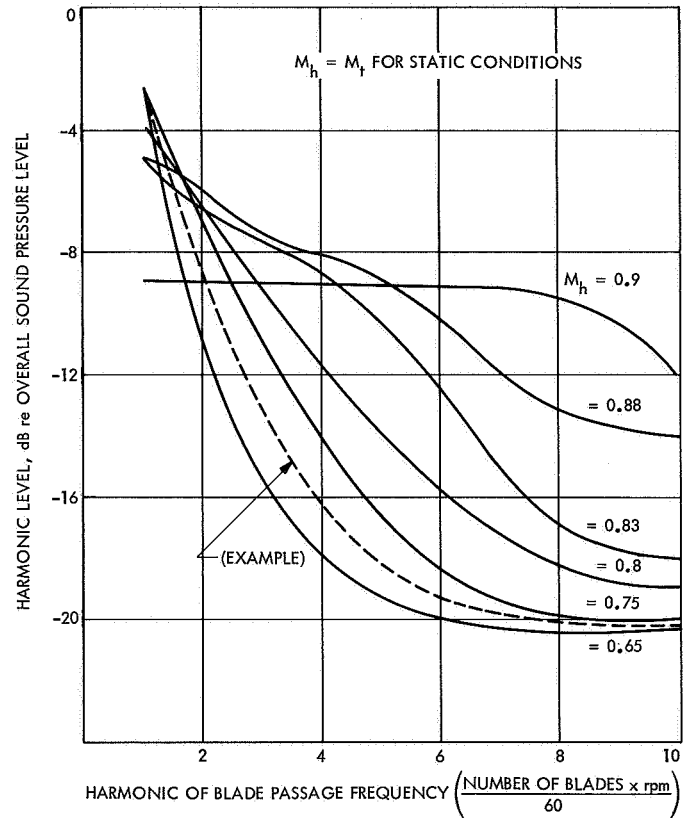
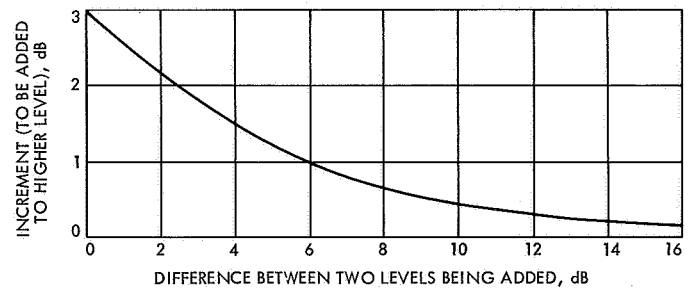

Fig. B-6. Harmonic distribution of rotational noise

Fig. B-7. Chart for combining noise levels



Step 4.  $Z/D = 0.139$   
 $X/D = 0$   
 Then, from Fig. B-4, the correction is: 0

Step 5.  $X/D = 0$   
 The fuselage has a circular wall,  
 Then, from Fig. B-5, the correction is: +4

Step 6. The summation of steps 1 through 5 gives the overall sound pressure level on the fuselage at location  $Z = 1.25$  ft,  $X = 0$  ft 136.0

Step 7. Overall sound pressure level = 136.0  
 The fundamental blade passage frequency =  $B \cdot n/60 = 79$  Hz

1	2	3	4
Preferred octave passbands, Hz	Harmonics of blade passage frequency (step 7, column 2)	Harmonic levels, dB (step 7, column 4)	Octave band level, dB <sup>3</sup>
45-90	79	134.0	134.0
90-180	158	127.0	127.0
180-355	237, 316	123.0, 120.0	124.7
355-710	395, 474, 553, 632	118.0, 117.0, 116.0, 116.0	123.0
710-1400	711, 790	116.0, 116.0	119.0
1400-2800	—	—	—
2800-3600	—	—	—
3600-11,200	—	—	—
Overall			135.4

$$M_h = \frac{(V_i^2 + V_j^2)^{1/2}}{c} = \frac{(746^2 + 210^2)^{1/2}}{1125} = 0.69$$

1	2	3	4
Harmonic order	Frequency, Hz	Harmonic level, dB re overall SPL (from Fig. B-6)	Harmonic level, dB
Fundamental	79	-2	134.0
2	158	-9	127.0
3	237	-13	123.0
4	316	-16	120.0
5	395	-18	118.0
6	474	-19	117.0
7	553	-20	116.0
8	632	-20	116.0
9	711	-20	116.0
10	790	-20	116.0

### C. Estimate of Far-Field Propeller Noise

The steps in determining far-field propeller noise levels during static and dynamic conditions are:

- (1) Obtain a reference level  $L_1$  from Fig. B-2. This gives a partial level, based on the power input to the propeller.
- (2) Calculate the correction to the partial level for number of blades and propeller diameter; add

<sup>3</sup>When more than two levels are to be added, add in pairs using Fig. B-7, i.e.,

1	2	3	4
Levels to be combined, dB	Difference between pairs in column 1, dB	Value from Fig. B-7 for difference of column 2, dB	Sum of value in column 3 and higher level from pair of column 1, dB
118.0 ] 117.0 ]	1	2.6	120.6 ]
116.0 ] 116.0 ]	0	3.0	119.0 ]
5	6	7	
Difference between pairs in column 4, dB	Value from Fig. B-7 for difference of column 5, dB	Sum of value in column 6 and higher level from column 4, dB	
1.6	2.4	123.0	

$20 \log 4/B$ , where  $B$  is the number of blades; and add  $40 \log 15.5/D$ , where  $D$  is the propeller diameter in ft.

- (3) Obtain the correction factor from Fig. B-3. This accounts for the rotational speed of the propeller ( $M_t =$  tip Mach number) as well as the distance from a radial reference point to the propeller disc. Always use  $Z = 1$  ft.
- (4) Obtain the correction factor from Fig. B-8. This accounts for the directional characteristics of sound propagation from a propeller.
- (5) Correct for attenuation due to the normal spherical spreading of sound. Subtract  $20 \log (r - 1)$ , where  $r$  is the distance, in ft, from the center of the propeller.
- (6) Sum the data of steps (1) through (5). This gives the overall sound pressure level at the point of interest.
- (7) The harmonic distribution of the noise estimated in steps 1 through 6 is found in Fig. B-6.
- (8) The harmonic levels of step 7 are combined using the chart in Fig. B-7 to derive octave band levels.

- (9) Correct for attenuation due to molecular absorption of sound in air using the values in Fig. B-9. Mid-frequency corrections for ground absorption, when the source and receiver are located near the ground, have not been included in this estimating method.

#### D. Sample Calculation of Far-Field Noise

A sample calculation of far-field noise (see Fig. B-10), using the method described in the preceding paragraphs, is presented here.

Propeller diameter $D$	9 ft
Power to propeller	300 hp
Propeller speed $n$	1584 rpm
Number of blades $B$	3
Speed of sound $c$	1125 ft/s
Distance to far-field point of interest $r$	1000 ft
Azimuth angle $\theta$	90 deg
Distance to reference point $Z$	1 ft

Partial noise level, dB

Step 1. From Fig. B-2,  $L_1$

121

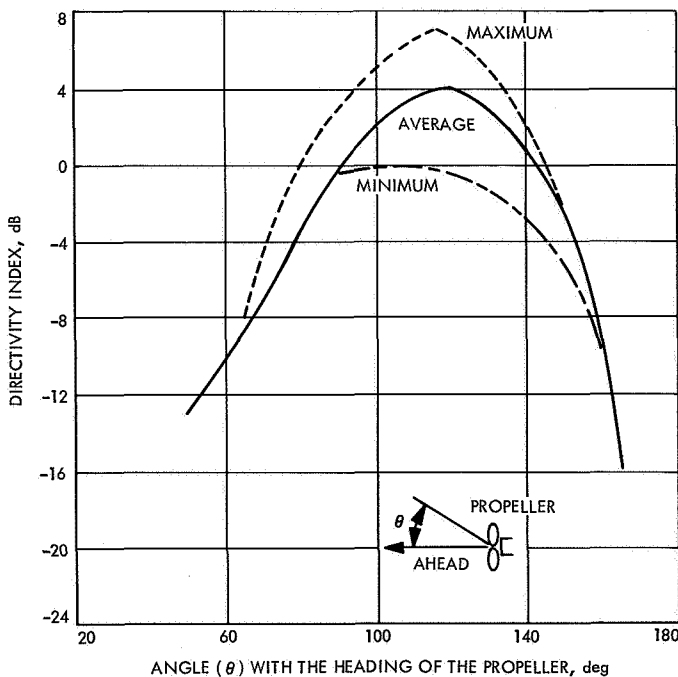

Fig. B-8. Polar distribution of overall noise levels for propellers

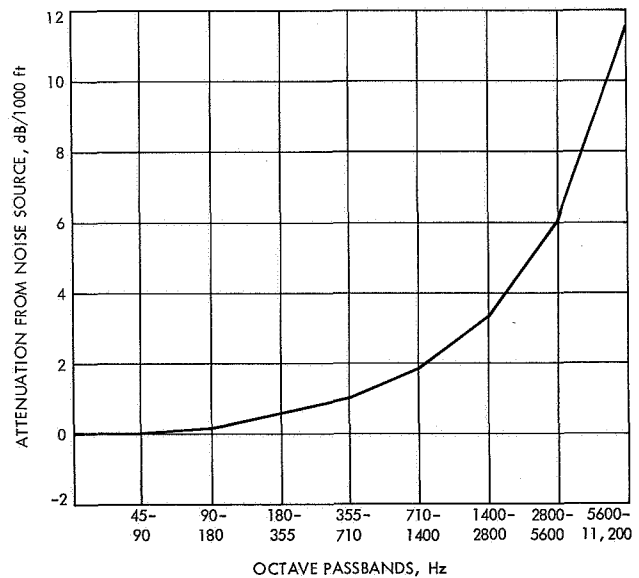

Fig. B-9. Molecular absorption of sound in air

Step 2. Add  $20 \log(4/3)$  2.5  
 Add  $40 \log(15.5/9)$  +9.5

$$\frac{B \cdot n}{60} = 79 \text{ Hz}$$

Step 3.  $Z/D = 1/9 = 0.111$

$$V_t = \frac{\pi \cdot D \cdot n}{60} = \frac{3.14 \cdot 9 \cdot 1584}{60} = 746 \text{ ft/s}$$

$$M_t = \frac{V_t}{c} = 746/1125 = 0.66$$

Then, from Fig. B-3, the correction is: -1.0

Step 4. From Fig. B-8, for  $\theta = 90$  deg, the average correction is: 0

Step 5. Subtract  $20 \log(999)$  -59.2

Step 6. The summation of steps 1 through 5 72.8

Step 7. Overall sound pressure level (SPL) = 72.8 dB  
 The fundamental blade passage frequency

1	2	3	4
Harmonic order	Frequency, Hz	Harmonic level, dB re overall SPL (from Fig. B-6)	Harmonic level, dB
Fundamental	79	-2	70.8
2	158	-9	63.8
3	237	-13	59.8
4	316	-16	56.8
5	395	-18	54.8
6	474	-19	53.8
7	553	-20	52.8
8	632	-20	52.8
9	711	-20	52.8
10	790	-20	52.8

Step 8. The octave band levels are derived by grouping the harmonics (step 7, column 4) of the blade passage frequency within the associated preferred octave bands and combining the levels using Fig. B-7.

1	2	3	4
Preferred octave pass-bands, Hz	Harmonics of blade passage frequency (step 7, column 2)	Harmonic levels, dB (step 7, column 4)	Octave band level, dB <sup>4</sup>
45-90	79	70.8	70.8
90-180	158	63.8	63.8
180-355	237, 316	59.8, 56.8	61.5
355-710	395, 474, 553, 632	54.8, 53.8, 52.8, 52.8	59.8
710-1400	711, 790	52.8, 52.8	55.8
1400-2800	—	—	—
2800-5600	—	—	—
5600-11,200	—	—	—
Overall			72.3

<sup>4</sup>When more than two levels are to be added, add in pairs (see step 8 of the sample calculation of near-field noise).

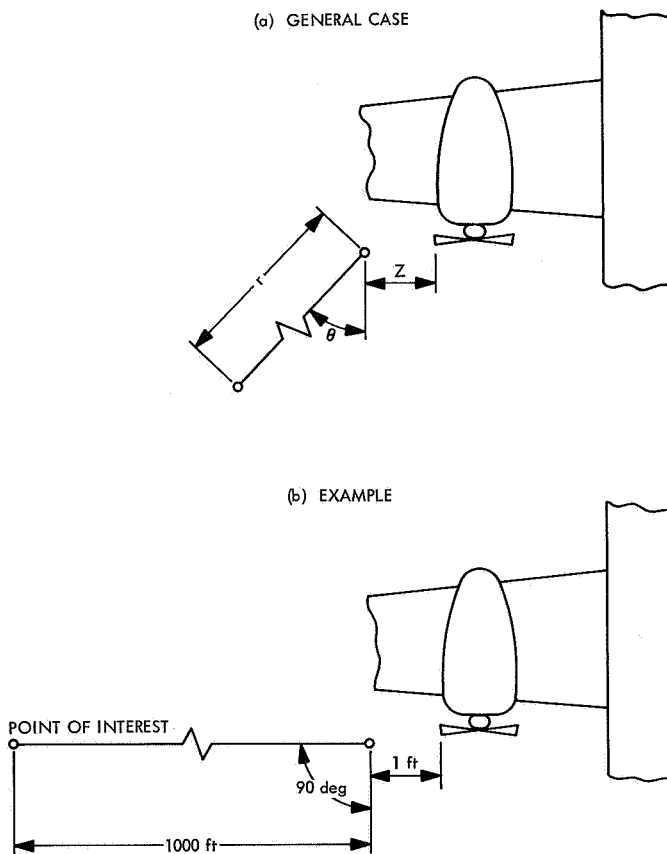

Fig. B-10. Far-field axis system

Step 9.

1	2	3
Preferred octave pass-bands, Hz	Octave band level, dB (step 8, column 4)	Octave band levels, dB, corrected for molecular absorption of sound (from Fig. B-9)
45-90	70.8	70.8
90-180	63.8	63.6
180-355	61.5	60.9
355-710	59.8	58.7
710-1400	55.8	54.0
1400-2800	—	—
2800-5600	—	—
5600-11,200	—	—
Overall		72.2

## Appendix C

### Generalized Rotor-Noise Estimating Procedure

Most current rotor-noise prediction analyses are cumbersome and require tedious computer operations. Largely limited by the accuracy of air load input data and transient conditions, these arduous processes result in far-field rotational noise predictions no better than  $\pm 8$  dB of actual measurements in most cases. Simplified hand calculations, which reduce the accuracy by only a few percent then, become valuable tools for cursory analyses and studies of parametric trends. Step-by-step procedures are presented for the calculation of both rotational and vortex noise emanating from rotors. No simple analysis has been developed for prediction of blade slap noise.

Lowson (Ref. 12) has made simplifying assumptions to his closed-form analytic solution which enabled him to develop a set of charts useful for predicting parametric trends associated with the rotational noise generated by a rotor in steady flight. With careful use, the procedure can yield any reasonable number of noise harmonics, at any point in the far field, to within 2 dB of the value obtained by computer techniques.

When treated separately, overall vortex noise has traditionally been predicted by simple hand calculations. Schlegel (Ref. 13) has refined the method somewhat and developed (by empirical means) a procedure by which

spectral shape over the first few harmonics may be simply generated. For the case of steady uniform inflow, comparison with experiment indicates that the accuracy is within  $\pm 2$  dB and appears to demonstrate valid parametric trends.

#### A. Estimate of Rotor Rotational Noise<sup>5</sup>

The following parameters are required in the rotational-noise calculations using the design charts (see Fig. C-1):

- $x, y, z$  Field point coordinates relative to helicopter measured in ft, with  $x$  measured positive in the direction of motion (parallel to ground in hover),  $y$  measured at 90 deg to  $x$  in the plane of the disc,  $z$  measured downward from helicopter. (Results for  $+y$  equal results for  $-y$ .)
- $A$  Disc area, ft<sup>2</sup> (or  $T/A$  = disc loading in lb/ft<sup>2</sup>)
- $n$  Rotor angular velocity, rad/s ( $n = \text{rpm} \times 2\pi/60$ )
- $V$  Flight velocity, ft/s
- $c$  Speed of sound in free air, ft/s
- $i_d$  Disc incidence (angle between disc and  $x$ -axis), deg

<sup>5</sup>The procedure was extracted as a unit from Ref. 12 and is presented here for convenience.

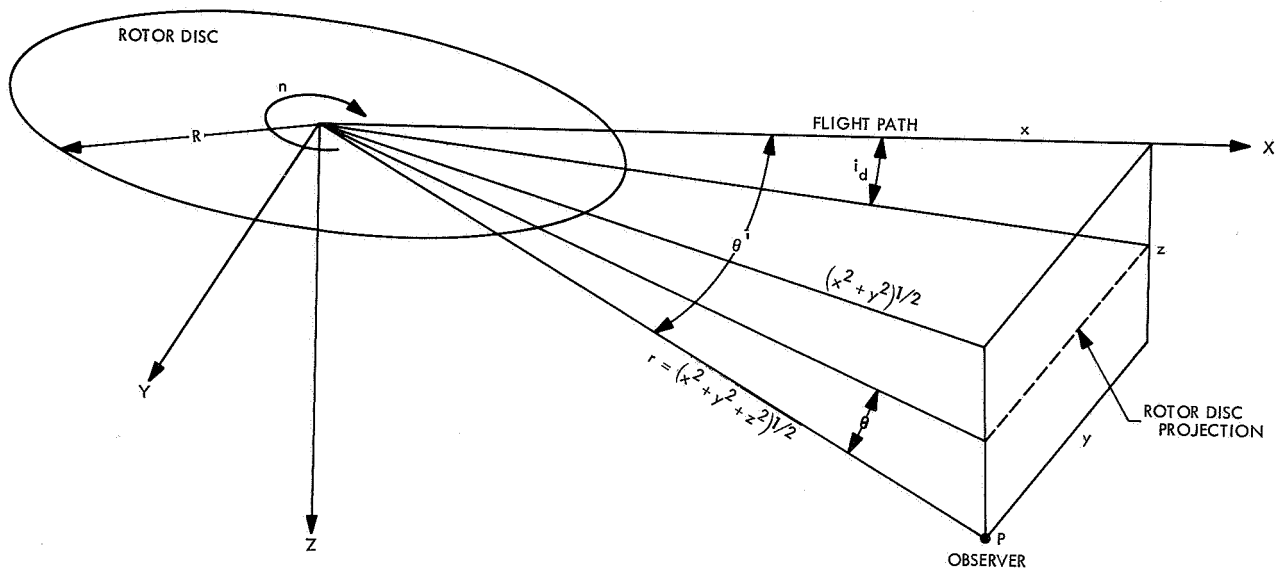

Fig. C-1. Rotor rotational noise axis system

- $m$  Sound harmonic (equals 1 for fundamental, 2 for second harmonic, etc.)
- $B$  Number of blades
- $T$  Thrust, lb
- $R$  Rotor radius, ft

**1. Instructions for use of design charts (a-l of Fig. C-2).**

To calculate the rotational noise spectrum occurring instantaneously at any point  $P$ , relative to the rotor center and its direction of motion, perform the following steps:

- (1) Calculate range  $r = (x^2 + y^2 + z^2)^{1/2}$
- (2) Calculate the rotational Mach number  $M$ ;  $M = 0.8nR/c$
- (3) Calculate the flight Mach number  $M_F = V/c$
- (4) Calculate the angle  $\theta'$  between the flight direction and the line joining the rotor and the field point  $\theta' = \cos^{-1}(x/r)$
- (5) Calculate the effective rotational Mach number  $M_E = M/(1 - M_F \cos \theta')$
- (6) Calculate the angle  $\theta$  between the rotor plane and the line  $r$ . If the disc incidence is  $i_d$ , this is given by

$$\theta = \tan^{-1} \left[ \frac{z}{(x^2 + y^2)^{1/2}} \right] - i_d \left[ \frac{x}{(x^2 + y^2)^{1/2}} \right]$$

- (7) Using the values of  $M_E$  and  $\theta$ , see appropriate sheet of Fig. C-2 to obtain values of the harmonic sound pressure level  $I_N$  for  $N = 2, 3, 4, 6, 8, 10, 12, 16, 20, 30, 40$ , and  $60$ .
- (8) Correct the values obtained for thrust, disc loading, and distances according to

$$SPL_N = \left[ I_N + 11 + 10 \log \frac{T}{r^2} \left( \frac{T}{A} \right) \right]$$

dB re 0.0002, dyne/cm<sup>2</sup>

- (9) Plot the sound pressure level spectrum  $SPL_N$  against  $N$  and fit a smooth curve.
- (10) The sound pressure levels from the above curve for  $N = B, 2B, 3B, \dots$  give the required harmonic level at the point  $x, y, z$ .
- (11) The fundamental frequency is

$$nB/[2\pi(1 - M_F \cos \theta)] \text{ Hz.}$$

**2. Sample calculation of rotor rotational noise.** Calculate the rotational noise spectrum 1000 ft from a three-blade rotor at an angle of 20 deg below the flight path in the steps following for the following parameters:  $T = 10,000$  lb,  $T/A = 7$  lb/ft<sup>2</sup>,  $V = 200$  ft/s,  $i_d = 5$  deg,  $R = 21.4$  ft,  $n = 28$  rad/s and  $c = 1117$  ft/s

- (1)  $r = 1000$  ft
- (2)  $M = 0.8 \times 600/1117 = 0.429$
- (3)  $M_F = 200/1117 = 0.179$
- (4)  $\theta' = 20$  deg
- (5)  $M_E = 0.429/(1 - 0.179 \times 0.938) = 0.516$
- (6)  $\theta = 20 - 5 = 15$  deg
- (7) From charts:

$N$	2	3	4	6	8	10	12	16	20	30	40	60
$I_N$	84.5	82.5	81.5	76.5	71	66	62	57	54	48	44.5	38.5

$$(8) \text{ Correction} = 10 \log \left( \frac{10,000}{1000^2} 7 \right) + 11 = +0.5 \text{ dB}$$

$N$	2	3	4	6	8	10	12	16	20	30	40	60
$SPL_N$	85	83	82	77	71.5	66.5	62.5	57.5	54.5	48.5	45	39

- (9 and 10) The results of steps 9 and 10 can be seen in Fig. C-3.
- (11) The fundamental frequency in this case is

$$\frac{nB}{2\pi(1 - M_F \cos \theta)} = \frac{(28)(3)}{2\pi[1 - (0.179)(0.966)]}$$

$$= 16.1 \text{ Hz}$$

**B. Estimate of Rotor Vortex Noise**

**1. Procedure for calculations.** The procedure for calculating the sound pressure level of vortex noise<sup>6</sup> from a rotor under conditions of uniform inflow is presented below. Schlegel's equation for overall vortex noise at 300 ft is

$$SPL_{300} = 10 \log \frac{6.1 \times 10^{-27} A_b (V_{0.7})^6}{10^{-16}} + 20 \log \frac{C_L}{0.4}$$

Here,  $A_b$  is the blade area in ft<sup>2</sup> and  $C_L$  is the effective lift coefficient based on the velocity of the 0.7 radius station.

<sup>6</sup>See Ref. 13.

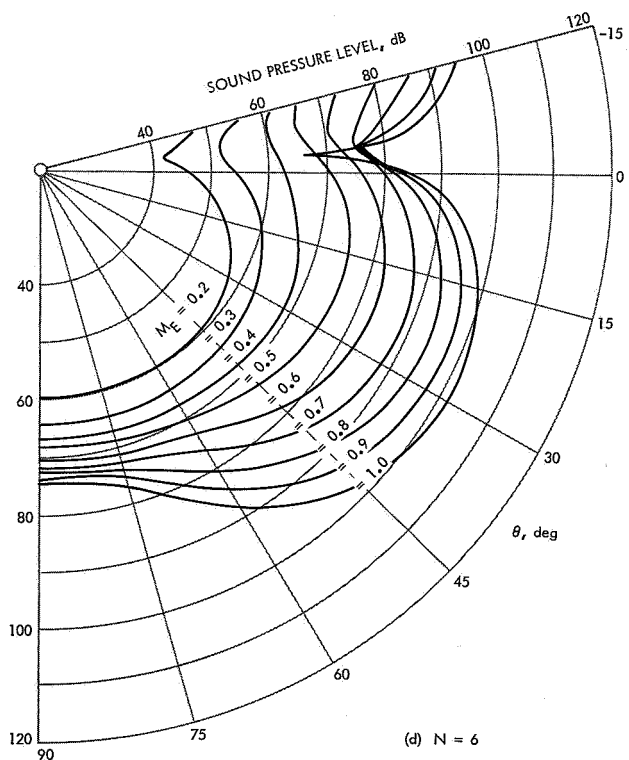
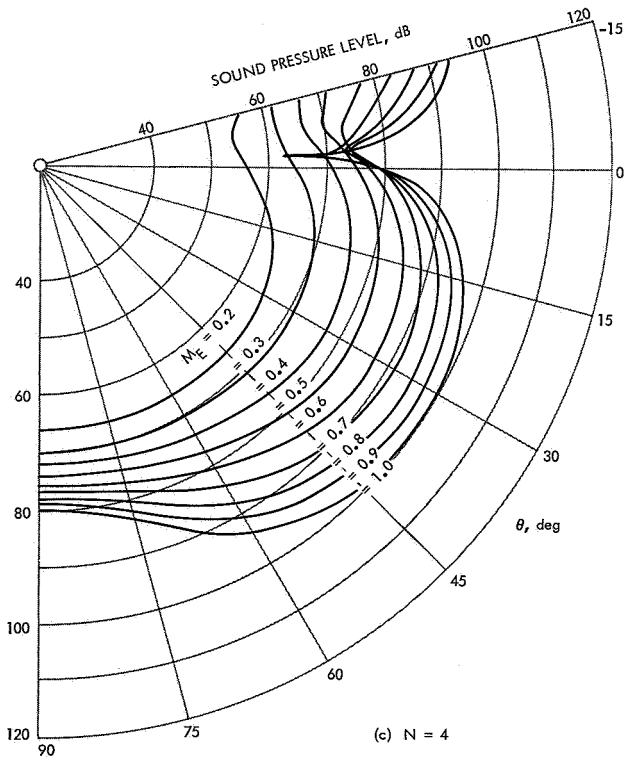
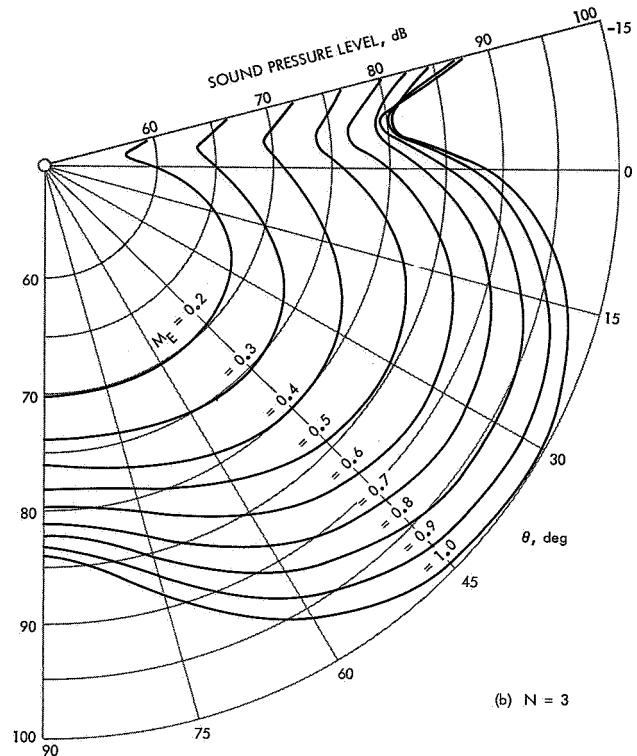
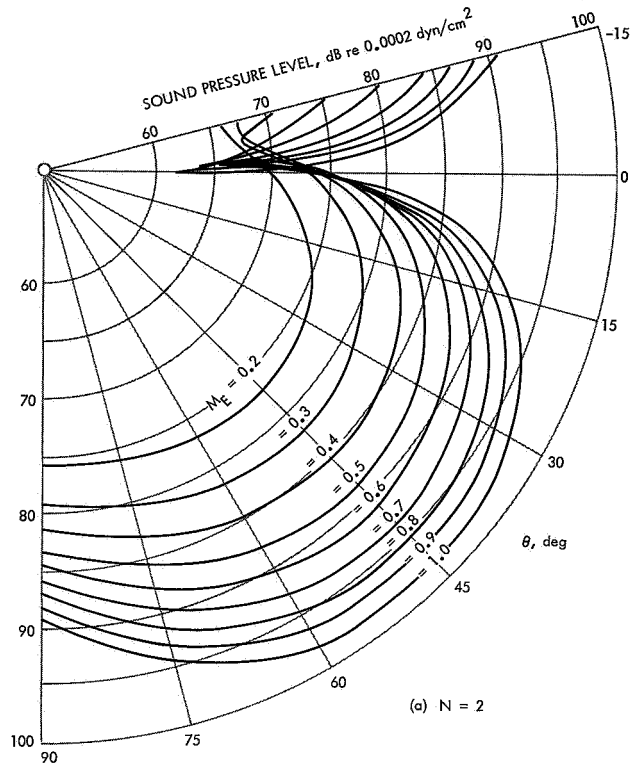

**Fig. C-2. Rotor noise harmonic sound pressure levels  $I_n$  as functions of harmonic number, rotational Mach number, and angle from disc plane**



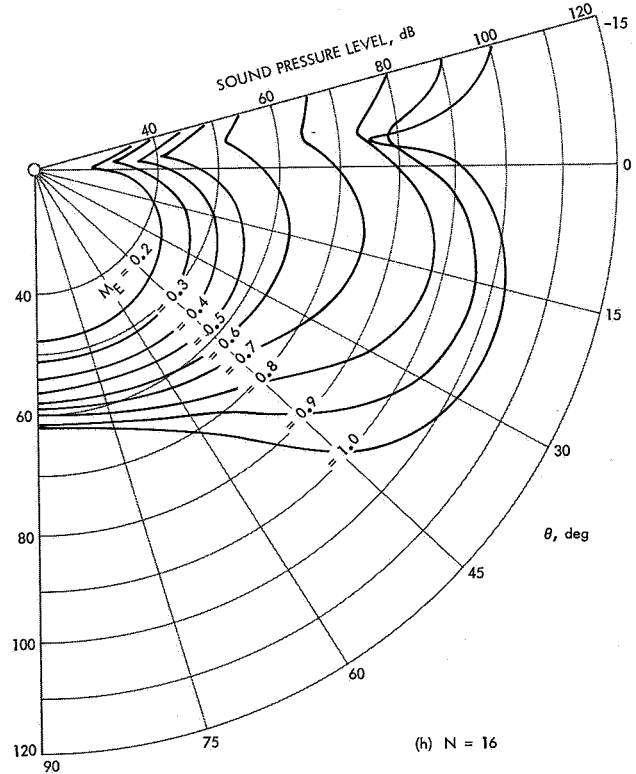
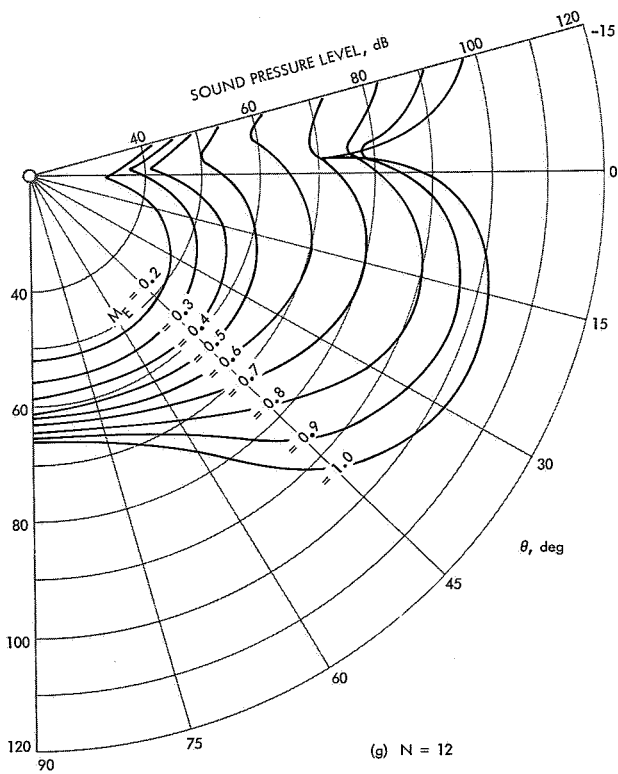
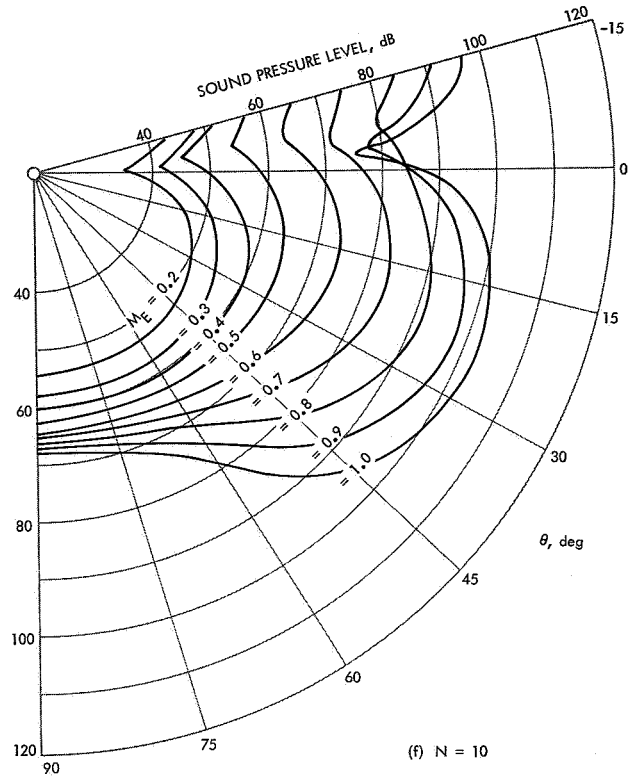
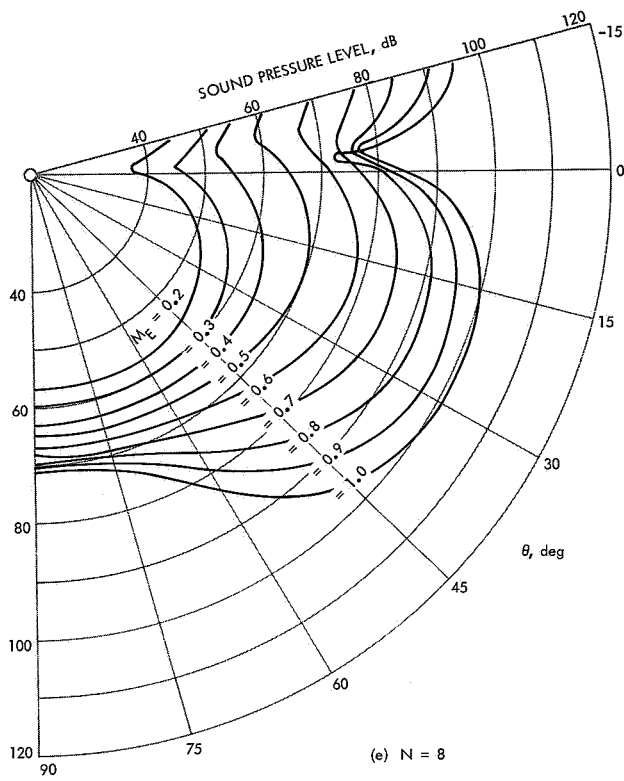

Fig. C-2 (contd)

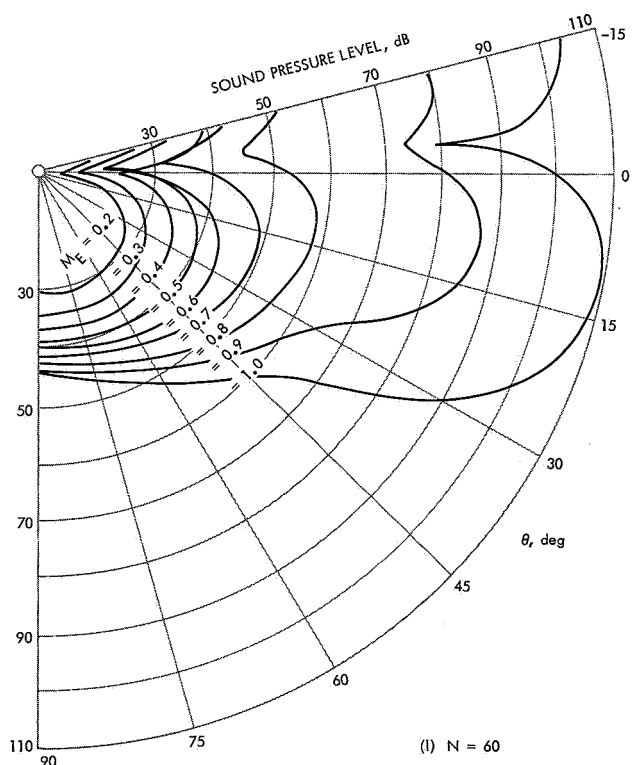
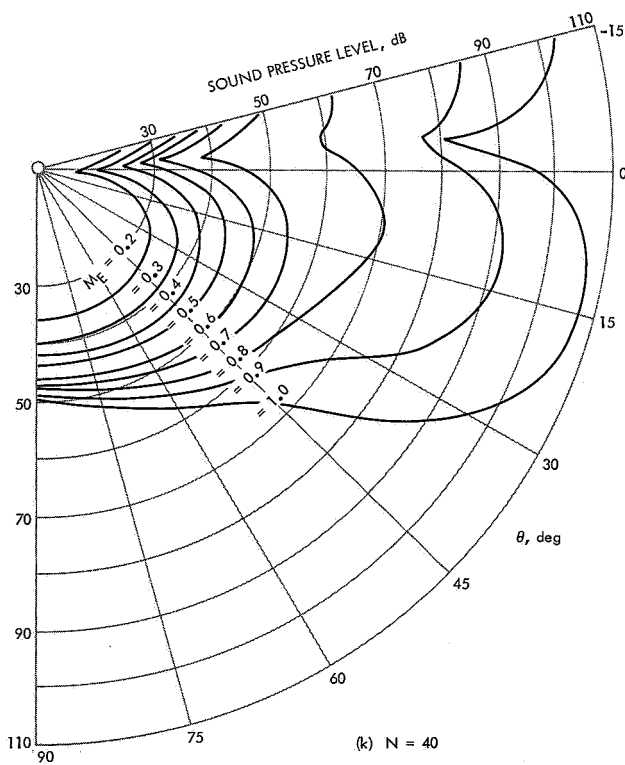
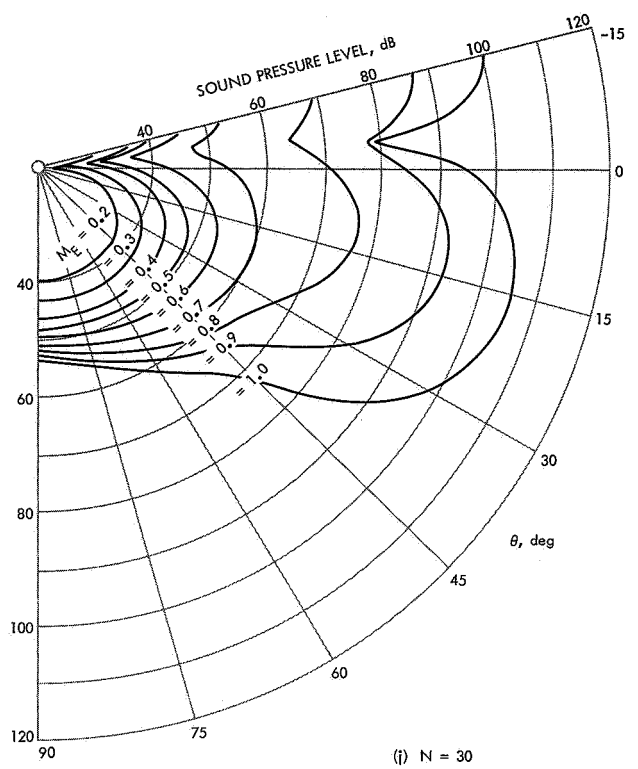
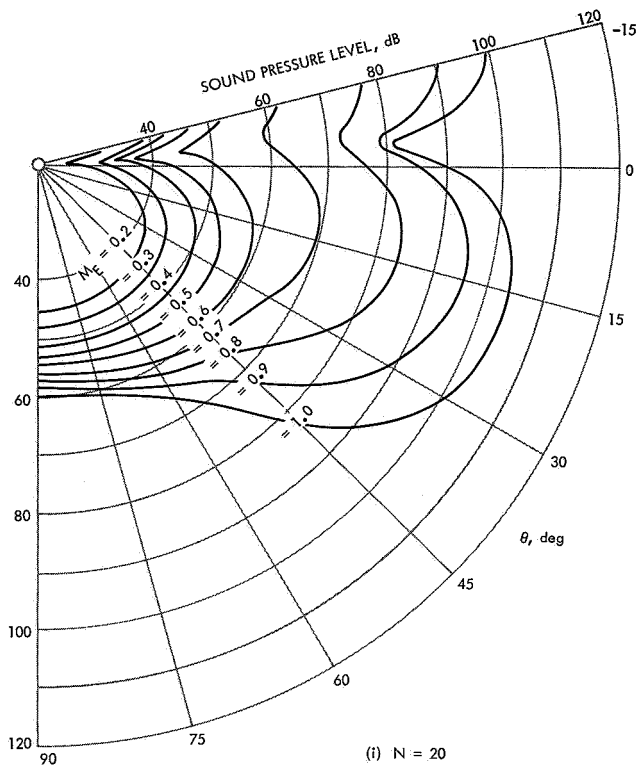
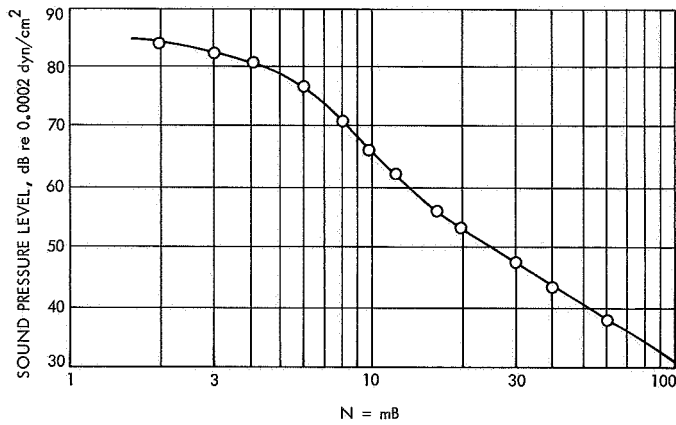

Fig. C-2 (contd)



**Fig. C-3. Sound pressure levels corresponding to harmonic numbers**

More conveniently, this equation may be written for sea level 70°F conditions as

$$SPL_{300} = 10 (2 \log V_{0.7} + 2 \log T - \log A_b - 3.57)$$

To calculate the overall SPL of vortex noise from this equation, use the following steps:

- (1) Calculate the linear velocity of the 0.7 radius section of the rotor

$$V_{0.7} = 0.7 \frac{n\pi D}{60}$$

- (2) Determine the thrust, if not given, in a hover condition as equal to the weight of the aircraft.
- (3) Calculate blade plan form area and multiply by the number of blades for total blade area,  $A_b$ .
- (4) Substitution into the vortex sound-pressure level equation yields the overall vortex noise SPL at 300 ft. Neglecting atmospheric attenuation, the SPL at any other distance,  $x_2$  may be computed from the inverse square law

$$SPL_{x_2} = SPL_{300} - 20 \log \frac{x_2}{300}$$

- (5) An approximation to the vortex spectrum shape may be determined by first calculating the peak frequency from the modified Strouhal equation

$$f = \frac{(V_{0.7}) St}{h}$$

In the usual Reynolds number range for a helicopter rotor, the Strouhal number ( $St$ ) may be taken to be 0.28.

The projected blade thickness  $h$  is defined by

$$h = b \cos \alpha + a \sin \alpha$$

where  $b$  is the blade thickness,  $a$  the chord length, and  $\alpha$  the angle of attack.

- (6) With  $f$  and the overall SPL determined, plot a vortex noise octave band spectrum with the help of Figs. 10a or 10b.

**2. Sample calculation of rotor vortex noise.** Calculate and sketch the vortex noise spectrum 1000 ft from a three-blade rotor in the following steps, for the following parameters:  $T = 10,000$  lb,  $R = 21.3$  ft,  $n = 270$  rpm,  $a = 1.0$  ft, and  $b = 0.16$  ft

$$(1) V_{0.7} = 0.7 \frac{n\pi D}{60} = 0.7 \cdot \frac{270}{60} (3.14) (42.6) = 421 \text{ ft/s}$$

$$(2) T = 10,000 \text{ lb}$$

$$(3) A_b = B \cdot R \cdot a = 3 (21.3) (1.0) = 64 \text{ ft}^2$$

$$(4) SPL_{300} = 10 (2 \log V_{0.7} + 2 \log T - \log A_b - 3.57)$$

$$= 10 (2 \log 421 + 2 \log 10,000 - \log 64 - 3.57)$$

$$= 78.7 \text{ dB re } 0.0002 \text{ dynes/cm}^2$$

and

$$SPL_{1000} = SPL_{300} - 20 \log \frac{1000}{300}$$

$$= 68.2 \text{ dB re } 0.0002 \text{ dynes/cm}^2$$

$$(5) h = b \cos \alpha + a \sin \alpha = (0.16) (0.999) + (1.0) (0.052) = 0.212 \text{ ft}$$

so

$$f = V_{0.7} St/h = \frac{421 (0.28)}{0.212} = 556 \text{ Hz}$$

(6) With the overall *SPL* and peak frequency determined, the spectrum for an unstalled blade may be constructed from Fig. 10a as follows

At $\frac{1}{2}f$	$SPL = 68.2 - 8.0 = 60.2$
$f$	$SPL = 68.2 - 4.0 = 64.2$
$2f$	$SPL = 68.2 - 8.0 = 60.2$
$4f$	$SPL = 68.2 - 9.0 = 59.2$
$8f$	$SPL = 68.2 - 13.0 = 55.2$
$16f$	$SPL = 68.2 - 14.0 = 54.2$

Results are shown in Fig. C-4.

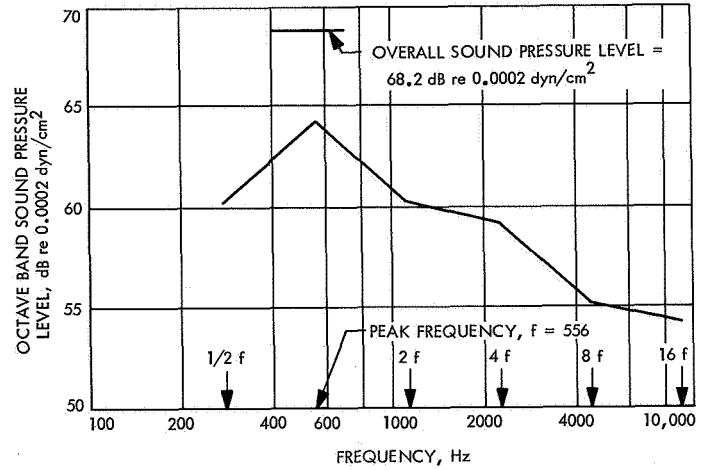

Fig. C-4. Results of vortex noise sample calculation

## Appendix D

### Generalized Lift-Fan-Noise Estimating Procedure<sup>7</sup>

Since the curve of Fig. 16 is based on sound power, the fundamental acoustic parameter, it allows the designs of various vehicles to be compared directly. This type of analogy is useful from both a research viewpoint and a design viewpoint. For research, the normalized curve eliminates many of the irregularities presently found in fan and compressor noise measurements. For the designer, the normalized curve provides a basis on which the various design parameters (rotor annulus area  $A_a$ , rotor speed  $n$ , rotor blade number  $B_r$ , hub-tip ratio  $D_H/D_T$ , fan air flow  $W$ , and discharge total temperature  $T_T$ ) may be evaluated to determine the optimum combination for minimum noise generation.

The evaluation of advanced designs may be extended from the sound power level, determined by the normalized power curve, to a sound pressure level  $SPL$ , by using additional normalized or average results from the test data. This is particularly important when the advanced design must conform to an  $SPL$  far-field acoustic requirement.

#### A. Calculation of Fan Noise

The steps in determining fan noise from a given set of geometric parameters (see Fig. D-1a) and operating conditions are as in the following steps:

- (1) Calculate the rotor annulus area  $A_a$  from the known hub and tip diameters.

$$A_a = (\pi/4) (D_T^2) \left[ 1 - \left( \frac{D_H}{D_T} \right)^2 \right] \text{ (ft}^2\text{)}$$

- (2) Calculate the discharge total temperature as the sum of the known inlet total temperature and the known temperature rise per stage.

$$T_T = T + \Delta T \quad (\text{°R})$$

- (3) Obtain the discharge total enthalpy  $H_T$  from gas tables, knowing  $T_T$ .
- (4) Calculate the energy flux per unit area as the product of the discharge total enthalpy and the known

weight flow rate  $W$  divided by the rotor annulus area

$$E = \frac{H_T \times W}{A_a} \quad \left( \frac{\text{Btu}}{\text{s-ft}} \right)$$

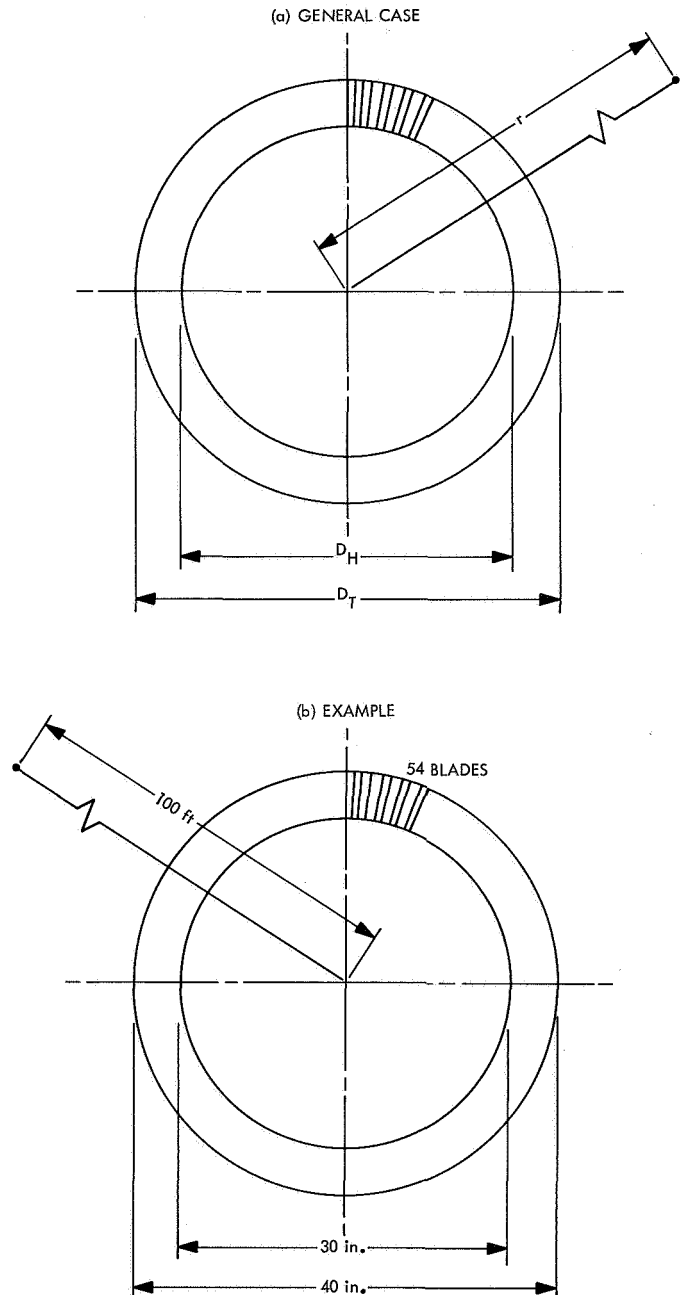

Fig. D-1. Lift fan axis system

<sup>7</sup>The procedure was extracted as a unit from Ref. 12 and is presented here for convenience.

- (5) From Fig. 16, knowing the energy flux per unit area, obtain a value for

$$PWL = 10 \log \frac{A_a n}{B} \left( \frac{D_H}{D_T} \right)^2$$

which is the normalized overall sound power.

- (6) Solve the expression obtained in step 5 for overall sound power by substituting given or computed values for rotor annulus area,  $A_a$ , rotor speed  $n$ , hub-tip diameter ratio ( $D_H/D_T$ ), and rotor blade number  $B$ .
- (7) The harmonic distribution of the sound power estimated in steps 1 through 6 is found in Fig. D-2 which is the result of averaging the measurements taken on various flow configurations although a considerable spread is found in the harmonic power spectrum data.
- (8) Obtain sound pressure levels from sound power levels, knowing the directivity index  $DI$  and the distance from the source  $r$  by the following equation:

$$SPL = PWL + DI - 20 \log r - 10.5$$

A value of 5 for the directivity index  $DI$  can be used since this corresponds to an average  $DI$  at the angle of maximum noise for a number of experimental measurements.

The angle of maximum noise or directivity was not normalized; thus, the  $SPL$  calculated can only be assumed to be in the vicinity of 30 to 60 deg from the inlet or exhaust of the vehicle. This range for the angle of maxi-

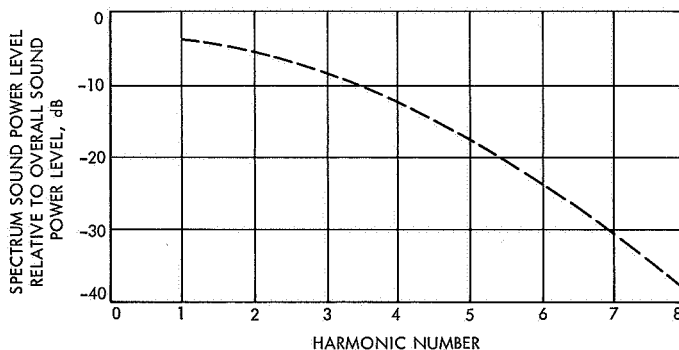

Fig. D-2. Normalized power spectrum of compressor and fan noise

imum noise is a reasonable value based on experimental data. If a design is to be considered that is similar to one on which a polar plot of noise level is available, a more realistic value for the angle of maximum noise may be determined.

### B. Sample Calculation of Fan Noise

As an illustration of the procedure discussed, assume the following fan design parameters:

Outer diameter	$D_T = 40$ in.
Inner diameter	$D_H = 30$ in.
Weight flow	$W = 150$ lb/s
Stage temperature rise	$\Delta T = 15^\circ\text{R}$
Rotational velocity	$n = 8,000$ rpm
Number of rotor blades	$B = 54$
Inlet temperature	$T = 520^\circ\text{R}$

Perform the following steps:

- (1) Compute the rotor annulus area

$$A_a = \frac{\pi}{4} \times (D_T)^2 \left[ 1 - \left( \frac{D_H}{D_T} \right)^2 \right] = \frac{\pi}{4} \times \left( \frac{40}{12} \right)^2 [1 - 0.562]$$

$$A_a = \frac{\pi}{4} \times 11.2 \times 0.438 = 3.85 \text{ ft}^2$$

- (2) Compute the total temperature at the discharge, assuming a single stage fan

$$T_r = T + \Delta T = 520^\circ\text{R} + 15^\circ = 535^\circ\text{R}$$

- (3) Obtain the total enthalpy at the discharge from gas tables

$$H_r = 128 \frac{\text{Btu}}{\text{lb}} \text{ at } 535^\circ\text{R}$$

- (4) Calculate the energy flux per unit area

$$E = \frac{H_r \times W}{A_a} = \frac{128 \times 150}{3.85} = 4.99 \times 10^3 \frac{\text{Btu}}{\text{s-ft}^2}$$

- (5) Obtain the normalized overall sound power from Fig. 16.

$$\text{At } E = 4.99 \times 10^3 \frac{\text{Btu}}{\text{s-ft}^2}$$

$$PWL = 10 \log \frac{A_a n}{B} \left( \frac{D_H}{D_T} \right)^2 = 133 \text{ dB}$$

- (6) Solve the expression obtained in step 5 for overall sound power

$$\begin{aligned}
 10 \log \frac{A_n}{B} (D_H/D_T)^2 &= 10 \log \frac{3.86 \times 8000}{54} \times 0.562 \\
 &= 10 \log 321 \\
 &= 10 \times 2.507 = 25
 \end{aligned}$$

$$PWL = 133 + 25 = 158 \text{ dB overall}$$

- (7) Obtain the sound power spectrum from Fig. D-2, knowing the overall sound power from step 6. (Only the first and second harmonics are computed here.)

$$\begin{aligned}
 \text{First harmonic} &= PWL - 3.5 = 158 - 3.5 \\
 &= 154.5 \text{ dB}
 \end{aligned}$$

$$\begin{aligned}
 \text{Second harmonic} &= PWL - 5.5 = 158 - 5.5 \\
 &= 152.5 \text{ dB}
 \end{aligned}$$

- (8) Calculate the sound pressure level at the angle of maximum noise and at a distance  $r$  of 100 ft.

$$SPL = PWL + DI - 20 \log r - 10.5$$

$$SPL = 158 + 5 - 20 \log 100 - 10.5$$

$$= 163 - 40 - 10.5 = 163 - 50.5$$

$$SPL = 112.5 \text{ dB at 100 ft, angle of maximum noise}$$

The above procedure allows a direct analysis of the acoustic performance of a development vehicle based on the fan design parameters. The question of installation effects, however, requires further analysis.

## Appendix E

### V/STOL-Noise Bibliography

The material contained in this bibliography was collected during a review of noise technology as related to V/STOL aircraft and is, therefore, considerably broader in scope than the main body of this paper. Placement of references within the various divisions used for the sake of convenience are necessarily quite arbitrary in some cases, but an attempt was made to place each reference in its category of major emphasis. A very brief description of the scope of the division is included at the beginning of each section.

#### I. Rotors, Propellers, and Lift Fans

Included are references covering all types of noise produced by these devices, together with closely related aerodynamic studies.

"Aerodynamic Problems Associated with V/STOL Aircraft," *CAL/USAVLABS Symposium Proceeding*, Vol. 1, Propeller and Rotor Aerodynamics, Buffalo, N. Y., June 1966.

Arnoldi, R. A., *Propeller Noise Caused by Blade Thickness*, United Aircraft Report R-0896-1, E. Hartford, Conn., Jan. 1956.

Cheesman, I. G., and Seed, A. R., "The Application of Circulation Control by Blowing to Helicopter Rotors," *J. Roy. Aeronaut. Soc.*, Vol. 71, pp. 451-467, July 1967.

*Conference on STOL Transport Aircraft Noise Certification, Sponsored by the Federal Aeronautics Administration of the Dept. of Transportation*, Report No. FAA-NO-69-1, TR 550-003-03H, Washington, D. C., Jan. 30, 1969.

Cox, C. R., *Full-Scale Helicopter Rotor Noise Measurements in Ames 40 x 80 Foot Wind Tunnel*, Bell Helicopter Report No. 576-099-052, U. S. Army Aeronautical Research Laboratory, Ames Research Center, Moffett Field, Calif., Sept. 27, 1967.

Cox, C. R., "Helicopter Noise and Passive Defense," Bell Helicopter Co, *Am. Helicopter Soc. 19th Annual National Forum*, A63-18693, pp. 156-163, New York, 1963.

Cox, R. C., and Lynn, R. R., *A Study of the Origin and Means of Reducing Helicopter Noise*, Rept. 299-099-180, TCREC-TR-62-73, N63-11749, Nov. 1962. Ft. Eustis, Va.

Curle, N., "The Influence of Solid Boundaries Upon Aerodynamic Sound," *Proc. of Royal Soc., Ser. A*, Vol. 231, London, 1955.

Davidson, I. M., and Hargest, T. J., "Helicopter Noise," *J. Roy. Aeronaut. Soc.*, Vol. 69, No. 5, pp. 325-336, May 1965.

Davis, D. O. and Coplin, J. F., "Some VTOL Powerplant Design and Development Experience," *J. Roy. Aeronaut. Soc.*, Vol. 70 p. 671, Nov. 1966.

Dodd, K. N., and Roper, G. M., *A Deuce Program For Propeller Noise Calculations*, RAE TN No. M.S. 45, Farnsbrough, Hants, England, Jan. 1958.

Fage, A., and Johansen, F. C., "On The Flow of Air Behind an Inclined Flat Plate of Infinite Span," *Royal Soc. Proc., Ser. A*, Vol. 116, p. 7, May 1927.

Fricke, F. R. and Stevenson, D. C., "Pressure Fluctuations in a Separated Flow Region," *J. Acoust. Soc. of Am.*, Vol. 44, No. 5, pp. 1189-1200, 1968.

Garrick, I. E., and Watkins, C. E., *A Theoretical Study of the Effect of Forward Speed on the Free-Space Sound-Pressure Field Around Propellers*, NACA Report 1198, Washington, D. C., 1953.

Gutin, L., *On the Sound Field of a Rotating Propeller*, NACA TM No. 1195, Washington, D.C., Oct. 1948.

Hafner, R., "Domain of the Convertible Rotor," *J. Aircraft*, Vol. 1, No. 6, pp. 350-359, Nov-Dec., 1964.

Hafner, R., "Symposium on the Noise and Loading Actions on Helicopter, V/STOL Aircraft, and Ground Effect Machines," *J. Sound Vib.*, Vol. 3, pp. 336-339, May 1966.



- Hargest, T. J., "Noise of VTOL Aircraft," *J. Sound Vib.*, Vol. 4, No. 3, pp. 378-387, Mar. 1966.
- Hargest, T. J., "V/TOL Aircraft Noise," *Fluid Dynamics of Rotor and Fan Supported Aircraft at Subsonic Speeds*, AGARD CP 22, Paris, France, Sept. 1967.
- Healy, Gerold J., "Propeller/Rotor Rotational Noise Analysis Including Time-Varying Blade Forces," Paper FF5, 76th Meeting of Acoustical Society of America, Cleveland, O., Nov. 18-22, 1968.
- Helicopter and V/STOL Noise Generation and Suppression*, Nov. 1968 Report of the Results of a Joint U. S. Army, National Academy of Sciences, National Academy of Engineering Conference, Washington, D. C., July 30-31, 1968.
- Hicks, C. W., and Hubbard, H. H., *Comparison of Sound Emission From Two-Blade, Four-Blade, and Seven-Blade Propellers*, NACA TN 1354, Washington, D. C., July 1947.
- Hubbard, H. H., *Propeller Noise Charts for Transport Airplanes*, NACA TN 2968, Washington, D. C., June 1953.
- Hubbard, H. H., and Maglieri, D. J., "Noise Characteristics of Helicopter Rotors at Tip Speeds Up to 900 Feet Per Second," *J. Acoust. Soc. Am.*, Vol. 32, No. 9, Sept. 1960.
- Hubbard, H. H., and Regier, A. A., *Free Space Oscillating Pressures Near the Tips of Rotating Propellers*, NACA Report 996, Washington, D. C., 1950.
- Hubbard, H. H., and Regier, A. A., *Propeller-Loudness Charts for Light Airplanes*, NACA TN 1358, Washington, D. C., July 1947.
- Kramer, M., "The Aerodynamic Profile as Acoustic Noise Generator," *J. Aero Sci.*, Vol. 20, pp. 280-282, Apr. 1953.
- Krzywoblocki, M. R., "Investigation of the Wing-Wake Frequency with Application of the Strouhal Number," *J. Aero Sci.*, Vol. 21, No. 1, pp. 51-62, Jan. 1945.
- Leverton, J. W., *Helicopter Noise-Blade Slap, Part I—Review and Theoretical Study*, NASA CR-1221, Washington, D. C., Oct. 1968.
- Leverton, J. W., and Taylor, F. W., "Helicopter Blade Slap," *J. Sound Vib.*, Vol. 4, pp. 345-357, 1966.
- Loewy, R. G., and Sutton, L. R., "A Theory for Predicting the Rotational Noise of Lifting Rotors in Forward Flight Including a Comparison with Experiment," *J. Sound Vib.*, Vol. 4, No. 3, Nov. 1966.
- Lowson, M. V., *Basic Mechanisms of Noise Generation by Helicopters, V/STOL Aircraft and Ground Effect Machines*, Wyle Lab., Report WR 65-9, Huntsville, Ala., May 1965; Also *J. Sound Vib.*, Vol. 3, No. 5, pp. 454-466, May 1966.
- Lowson, M. V., and Ollerhead, J. B., *Studies of Helicopter Noise*, USAVLABS TR 68-60, Ft. Eustis, Va., Jan. 1969.
- Metzger, F. B., Magliozzi, B., Towle, G. B., and Gray, L., *A Study of Propeller Noise Research*, Hamilton Standard, SP 67148, Rev. A, Winsor Locks, Conn., 1961.
- Ollerhead, J. B., and Lowson, M. V., *Problems of Helicopter Noise Estimation and Reduction*, Paper 69-195, AIAA/AHS VTOL Research, Design, and Operations Meeting, Atlanta, Ga., Feb. 17-19, 1969.
- Ollerhead, J. B., and Taylor, R. B., *Description of a Helicopter Rotor Noise Computer Program*, USAVLABS TR 68-61, Ft. Eustis, Va., Jan. 1969.
- Potter, R. C., *An Experiment to Examine the Effect of Porous Trailing Edges on the Sound Generated by Blades in an Airflow*, Wyle Laboratories, Report WR 68-6, Huntsville, Ala., Mar. 1968.
- Powell, A., Theory of Vortex Sound, *J. Acoust. Soc. of America*, Vol. 36, p. 1, Jan. 1964.
- Richards, E. J., and Sharland, I. J., "Hovercraft Noise and Its Suppression," *J. Roy. Aeronaut. Soc.*, Vol. 69, No. 6, pp. 387-398, June 1965.
- Rosen, George, *Advanced Propeller Developments for V/STOL Aircraft*, SAE National Aeronautic Meeting, Washington, D. C., Apr. 1965.
- Sadler, S. G., and Loewy, R. G., *A Theory for Predicting the Rotational and Vortex Noise of Lifting Rotors in Hover and Forward Flight*, Rochester Applied Science Associates Report 68-11, Rochester, N. Y., 1968 (to be published as NASA contract report).

- Schlegel, R., King, R., and Mull, H., *Helicopter Rotor Noise Generation and Propagation*, USAVLABS T. R. 66-4, Ft. Eustis, Va., Oct. 1966.
- Schlegel, R. G., and Bausch, "Helicopter Rotor Noise Prediction and Control," *J. Am. Helicopter Soc.*, Vol. 14, No. 3, July 1969.
- Sharland, I. J., "Sources of Noises in Axial Flow Fans," *J. Sound Vib.*, Vol. 1, No. 3, pp. 302-322, 1964.
- Simons, I. A., et al; "The Movement, Structure and Breakdown of Trailing Vortices from a Rotor Blade," *CAL/USAVLABS Symposium Proceedings: Aerodynamic Problems Associated with V/STOL Aircraft, Vol. I, Propeller and Rotor Aerodynamics*, Buffalo, N. Y., June 1966.
- Sowers, H. D., *Investigation of Methods for the Prediction and Alleviation of Lift Fan Noise*, TRECOM TR 65-4, Ft. Eustis, Va., Apr. 1965.
- Spencer, R., Sternfeld, H., and McCormick, B. W., *Tip Vortex Core Thickening for Application to Helicopter Rotor Noise Reduction*, USAVLABS TR 66-1, Ft. Eustis, Va., Sept. 1966.
- Sternfeld, H., *Influence of the Tip Vortex on Helicopter Rotor Noise*, AGARD CP No. 22, Paris, France, Sept. 1967.
- Sternfeld, H., "New Techniques in Helicopter Noise Reduction," *Noise Control*, Vol. 7, pp. 4-10, May 1961.
- Stowell, E. Z., and Deming, A. F., *Vortex Noise from Rotating Cylindrical Rods*, NACA TN No. 619, Washington, D. C., Feb. 1935.
- Stuckey, T. J., and Goddard, J. O., "Investigation and Prediction of Helicopter Rotor Noise," *J. Sound Vib.*, Vol. 5, No. 1, pp. 50-80, Jan. 1967.
- Theodorsen, Theodore, and Regier, A. A., *The Problem of Noise Reduction with Reference to Light Airplanes*, NACA TN 1145, Washington, D. C., Aug. 1946.
- Trillo, R. L., "An Empirical Study of Hovercraft Noise," *J. Sound Vib.*, Vol. 3, No. 5, pp. 476-509, May 1966.
- Tyler, E., "Vortex Formation Behind Obstacles of Various Sections," *Phil. Mag. S. 7*, Vol. 11, No. 72, Apr. 1931.
- Vogeley, A. W., *Sound-Level Measurements of a Light-Airplane Modified to Reduce Noise Reaching the Ground*, NACA Report 926, Washington, D. C., Feb. 1948.
- Wilde, G. L., and Coplin, J. F., "Lift Turbo-Fans," *J. Roy. Aeronaut. Soc.*, Vol. 69, p. 656, Aug. 1965.
- Zandbergen, P. J., *On the Calculation of the Propeller Noise Field Around Aircraft*, National Aero- and Astronautical Research Institute, NLR-TM G. 23, p. 46, Amsterdam, Netherlands, June 1962.

## II. Engines

This material covers all forms of turbine engines noise including that from compressor rotors, stators and guide vanes, from inlets; from fans; and from exhaust jets.

*Aircraft Engine Noise*, NASA Literature Search Number 7268, Part I, Washington, D. C., Oct. 14, 1968.

*Aircraft Engine Noise*, NASA Literature Search Number 7268, Part II (Limited Distribution References), Washington, D. C., Oct. 14, 1968.

Bradshaw, P., Ferriss, D. H., and Johnson, R. F., "Turbulence in the Noise Producing Region of a Circular Jet," *Fluid Mech.*, Vol. 19, No. 8, pp. 591-624, Aug. 1964.

Bradshaw, P., and Flintoff, J. L., "Unexplained Scale Effects in Ejector Shroud Howling," *J. Sound Vib.*, Vol. 3, No. 1, pp. 183-190, Mar. 1968.

Bragg, S. L., and Bridge, R., "Noise From Turbojet Compressors," *J. Roy. Aeronaut. Soc.*, Vol. 68, Jan. 1964.

Cawthorn, J. M., Hayes, C., and Morris, G. J., *Measurement of Performance, Inlet Flow Characteristics, and Radiated Noise for a Turbojet Engine Having Choked Inlet Flow*, NASA TN D-3929, Washington, D. C., Mar. 1967.

Clark, L. T., *Noise Generation by Turbomachines*, D6-20393, Boeing Co., Seattle, Wash., Apr. 1968.

Davies, D. O., and Coplin, J. F., "Some VTOL Powerplant Design and Development Experience," *J. Roy. Aeronaut. Soc.*, Vol. 70, pp. 977-986, Nov. 1966.

- Eldred, K. M., White, R. W., Mann, M. A., and Cottis, M. G., *Suppression of Jet Noise with Emphasis on the Near Field*, ASD-TDR-62-578 Wright-Patterson AFB, Dayton, O., Feb. 1963.
- Elias, I., Frasca, R. L., Hoehne, J. C., Marsh, A. H., *A Study of Turbo-Engine Compressor Noise Suppression Techniques*, NASA CR 1056, Washington, D. C., June 1968.
- Fundamental Study of Jet Noise Generation and Suppression, Vol. I. Experimental and Theoretical Investigations of Model Jet Exhaust Stream Noise and The Development of Normalizing Parameters for Size and Temperature*, Report, for Apr. 1962 to Mar. 1963, IR-6067, Illinois Institute of Technology, Armour Research Foundation, Chicago, Ill., Mar. 1963.
- Fundamental Study of Jet Noise Generation and Suppression, Vol. II, Bibliography*, Report for Apr. 1961 to Dec. 1962, IR-6066, AD-407793, Illinois Institute of Technology, Armour Research Foundation, Chicago, Ill., Mar. 1963.
- Gordon, C. G., *Turbofan Engine Noise-Mechanisms and Control*, Acoustic Society of America Meeting, Philadelphia, Pa., Apr. 1969.
- Grande, E., *Possibilities and Devices for the Suppression of Jet Noise*, D6-20609, Boeing Co., Seattle, Wash., 1968.
- Hulse, B., Pearson, C., Abbona, M., and Anderson, A., *Some Effects of Blade Characteristics on Compressor Noise Level*, FAA-ADS-82, Washington, D. C., Oct. 1966.
- Jet Engine Noise Deflection or Suppression*, A DDC Report Bibliography, Report No. ARB 10541, Cameron Station, Alexandria, Va.
- Kester, J. D., and Slaiby, T. G., *Designing the JT9D Engine To Meet Low Noise Requirements for Future Transports*, Paper 670331 S. A. E. National Aeronautics Meeting, New York, Apr. 24-27, 1967.
- Kobrynski, M., *General Method for Calculating the Sound Pressure Field Emitted by Stationary or Moving Jets*, Symposium on Aerodynamic Noise, ONERA, TP No. 578, Toronto, Canada, May 20-21, 1968.
- Lighthill, M. J., *Jet Noise*, AGARD Report 448, Paris, France, Apr. 1963.
- Lowson, M. V., *Compressor Noise Analysis*, NASA SP-189, Washington, D. C., Oct. 1968.
- Lowson, M. V., *Reduction of Compressor Noise Radiation*, *J. Acoust. Soc. of Am.*, Vol. 43, 1, pp. 37-50, Jan. 1968.
- Lowson, M. V., *Theoretical Studies of Compressor Noise*, NASA CR 1287, Washington, D. C., Aug. 1968.
- Lowson, M. V., and Ollerhead, J. B., *Visualization of Noise from Cold Supersonic Jets*, *J. Acoust. Soc. of Am.*, Vol. 44, No. 2 pp. 624-630, Feb. 1968.
- Marsh, A. H., Elias, I., Hoehne, J. C., and Frasca, R. L., *A Study of Turbofan-Engine Compressor-Noise-Suppression Techniques*, NASA CR-1056, Washington, D. C., June 1968.
- McKaig, M. B., et al, *Procedures for Jet Noise Prediction*, Revision A, Document D6-2357 TN, Boeing Co., Seattle, Wash., Feb. 1965.
- Moore, H. B., and Clinck, J. M., "Measurement of Jet Noise Suppression Using A Small Turbojet Engine," Paper 670157 SAE, *Automotive Engineering Congress*, Detroit, Jan. 9-13, 1967.
- Morgan, W. V., Sutherland, L. C., and Young, K. J., *The Use of Acoustic Scale Models for Investigating Near Field Noise of Jet and Rocket Engines*, Boeing Co., Scientific Research Labs., Seattle, Wash., Apr. 1961.
- Morley, C. L., "How to Reduce the Noise of Jet Engines," *Engineering*, Vol. 198, pp. 782-783, Dec. 1964.
- Noise Generation and Suppression in Aircraft*, Proceedings of a Short Course at the University of Tennessee Space Institute, Tullahoma, Tenn., Jan.-Feb. 1968.
- Pendley, R. E., and Marsh, A. H., *Turbo-Fan-Engine Noise Suppression*, Paper 67-389, AIAA Commercial Aircraft Design and Operation Meeting, Los Angeles, June 12-14, 1967.
- Progress of NASA Research Relating to Noise Alleviation of Large Subsonic Jet Aircraft*, NASA SP-189, Washington, D. C., Oct. 1968.

- Research on Jet Noise Generation and Suppression*, Phase I, Final Report IR-9631, General Electric Co., Cincinnati, O., Apr. 1964.
- Ribner, H. S., "The Generation of Sound by Turbulent Jets," *Advances in Applied Mechanics*, Vol. VIII, pp. 103-182. Academic Press, New York, 1964.
- Semrau, W. R., *Research on Jet Noise Generation and Suppression*, General Electric Co., Cincinnati, O., Apr. 1, 1964.
- Sharland, I. J., *Recent Work at Southampton University on Sources of Noise in Axial Flow Fans*, Paper F33, 5th International Congress on Acoustics, Liege, Belgium, 1965.
- Sharland, I. J., "Sources of Noise in Axial Flow Fans," *J. Sound Vib.*, Vol. 3, No. 1, pp. 302-322, 1964.
- Silverstein, A., *Progress in Aircraft Gas Turbine Development*, NASA-TM-X-52240, Washington, D. C., 1966.
- Slutsky, A. L., *An Investigation of Jet Noise and its Abatement*, NASA CR-95553, Washington, D. C., June 1968.
- Sperry, W., Peter, A., and Hams, R., *Fundamental Study of Jet Noise Generation and Suppression*, Vol. I—*Experimental and Theoretical Investigations of Model Jet Exhaust Stream Noise and the Development of Normalizing Parameters for Size and Temperature*, ASD-TDR-63-326, Wright-Patterson AFB Propulsion Lab., Dayton, O., Mar. 1963.
- Wilde, G. L., and Taylor, P. A., "Factors Governing the Design of Tip Jet Engines," *AGARD Helicopter Development*, pp. 387-400, Paris, France, 1966.
- Williams, J. E. F., *Some Open Questions on the Jet Noise Problem*, N68-33764, DI-82-0730, Boeing Flight Sciences Lab., Seattle, Wash., June 1968.
- "Aural Detection of Helicopters in Tactical Situations," *J. Am. Helicopter Soc.*, Vol. 8, Oct. 1963.
- Bishop, D. E., *Descriptions of Fly-Over Noise Signals Produced by Various Jet Transport Aircraft*, FAA-DS-67-18, Washington, D. C., Aug. 1967.
- Bishop, D. E., *Frequency Spectrum and Time Duration Descriptions of Aircraft Fly-Over Noise Signals*, FAA-DS-67-6, Washington, D. C., May 1967.
- Bishop, D. E., *Helicopter Noise Characteristics for Heliport Planning*, FAA-ADS-40, Washington, D. C., Mar. 1965.
- Carmichael, R. F., and Pelke, D. E., *In-Flight Noise Measurements on the X-21A Laminar Flow Aircraft*, NOR-64-81, Northrop Corporation, NORAIR Div., Hawthorne, Calif., Apr. 1964.
- Cole, J. N., and England, R. T., "Evaluation of Noise Problems Anticipated with Future VTOL Aircraft," *Beyond the Horizon-Flight in the Atmosphere*, 1975-1985, Air Force Systems Command Report, Wright-Patterson AFB, Dayton, O., Jan. 1967.
- Cole, J. N., and England, R. T., *Evaluation of Noise Problems Anticipated with Future VTOL Aircraft*, AMRL-TR 66-245, May 1967.
- Conference on STOL Transport Aircraft Noise Certification Sponsored by the FAA of the DOT*, Report No. FAA-No-69-1, TR 550-003-03H, Washington, D. C., Jan. 30, 1969.
- Cox, C. R., *Helicopter Noise and Passive Defense*, pp. 156-163, American Helicopter Society 19th Annual National Forum, New York, 1963.
- Cox, R. C., and Lynn, R. R., *A Study of the Origin and Means of Reducing Helicopter Noise*, TCREC-TR-62-73, Ft. Eustis, Va., Nov. 1962.

### III. Aircraft

This section includes those references concerned with the total overall noise and the noise components produced by a particular aircraft type or by a general class of aircraft.

*Aircraft Noise and Sonic Boom*, Bibliographic List No. 13, FAA, Washington, D. C., Oct. 1966.

Dygart, K. D., *Allocating the Costs of Alleviating Subsonic Jet Aircraft Noise*, Inst. of Trans and Traffic Engr., University of California, Berkeley, Cal., Feb. 1967.

*Effects of Noise on Commercial V/STOL Aircraft Design and Operation*, A68-44938, Boeing Co., Seattle, Wash., 1968.

- Franken, P. A., and Kerwin, E. M., Jr., *Methods of Flight Vehicle Noise Prediction*, ASTIA Document No. AD 205 776, Wright-Patterson AFB, Dayton, O., 1958.
- Greatrex, "The Economics of Aircraft Noise Suppression," *Aerospace Proceedings*, ICAS 66-5, 1965.
- Hafner, R., "Domain of the Convertible Rotor," *J. Aircraft*, Vol. 1, No. 6, pp. 350-359, Nov. 1964.
- Helicopter and V/STOL Noise Generation and Suppression*, Report of the Results of a Joint U. S. Army, National Academy of Sciences, National Academy of Engineering Conference held July 30-31, 1968, Washington, D. C., Nov. 1968.
- Maglieri, D. J., "Shielding Flap Type Jet Engine Noise Suppressor," *J. Acoust. Soc. Am.*, Vol. 4, Apr. 1959.
- Maglieri, D. J., Hilton, D. A., and Hubbard, H. H., *Noise Considerations in the Design and Operation of V/STOL Aircraft*, NASA TN D-736, Washington, D. C., Apr. 1961.
- Maglieri, D. J., and Hubbard, H. H., *Preliminary Measurements of the Noise Characteristics of Some Jet-Augmented-Flap Configurations*, NASA TM 12-4-58L, Washington, D. C., Jan. 1959.
- Miller, R. H., *Notes on Cost of Noise Reduction in Rotor/Prop Aircraft*, Conference on V/STOL Noise Generation and Suppression, MIT Memo Report FTL-M68-9, Cambridge, Mass., Aug. 1968.
- Noise Bibliography*, TIL/BIB/73/Vol. 4, p. 32, Ministry of Aviation, Great Britain, July 1965.
- Pickerell, D. J., and Cresswell, R. A., "Power Plant Aspects of High-Speed, Inter-City VTOL Aircraft," *J. Aircraft*, Vol. 5, No. 5, Sept. 1968.
- Rabenhorst, D. W., *The Turbo-Electric V/TOL Aircraft*, TM TG-1013, John Hopkins University, Silver Spring, Md., July 1968.
- Ribner, H. S., Noise of Aircraft, Paper 65-545, UTIAS Rev. 24, *International Council of the Aeronautical Sciences*, 4th Congress, Paris, France, Aug. 24-28, 1964.
- Richards, R. E., *Problems of Airplane Noise in the 1970's*, 3rd International Congress of the International Council of the Aeronautical Sciences, Stockholm, Sweden, August 27-31, 1962, Proceedings A65-15539 06-34, pp. 569-618. Spartan Books, Inc., Washington, D. C.; The Macmillan Co. Ltd., London, England, 1964.
- Rosen, G., *Advanced Propeller Developments for V/STOL Aircraft*, S.A.E. National Aeronautic Meeting, Washington, D. C., Apr. 12-15, 1965.
- Spencer, R. H., "The Effect of Noise Regulations on VTOL Aircraft of the Future," *Vertiflite*, Vol. 14, No. 10, pp. 2-8, Oct. 1968.
- Sternfeld, H., "New Techniques in Helicopter Noise Reduction," *Noise Control*, Vol. 7, pp. 4-10, May 1961.
- Sternfeld, H., and Hinterkeuser, E., *Effects of Noise on Commercial V/STOL Aircraft Design and Operation*, Paper 68-1137, AIAA 5th Annual Meeting, Philadelphia, Pa., Oct. 21-24, 1968.
- Tanner, Carole S., and McLeod, Norman J., *Preliminary Measurements of Take-Off and Landing Noise from a New Instrumented Range*, NASA Conference on Aircraft Operating Problems, Langley, Va., NASA SP-83, pp. 83-90, May 10-12, 1965.
- Watter, M., *Progress Report on the Reduction of External Helicopter Noise with Proceedings of the ARPA Workshop*, IDA Research Paper, Washington, D. C., May 24-25, 1968.

#### IV. Operational

This section contains references relating to the effects of variations in aircraft operations such as flight path, throttling, flight frequency, etc.

"Aircraft Noise," *Report of an International Conference on the Reduction of Noise and Disturbance Caused by Civil Aircraft*. Lancaster House, London, England, Nov. 1966.

*Alleviation of Jet Aircraft Noise Near Airports*, A Report of the Jet Aircraft Noise Panel, Office of Science and Technology, Washington, D. C., Mar. 1966.

Bishop, D. E., *Analysis of Community and Airport Relationships/Noise Abatement*, FAA-RD-65-130, Washington, D. C., Dec. 1965.

- Bishop, D. E., and Haronjeff, R. D., *Procedures for Developing Noise Exposure Forecast Areas for Aircraft Flight Operations*, FAA-DS-67-10, Washington, D. C., May 1967.
- Bishop, D. E., and Haronjeff, R. D., 1965, 1970, 1975 *Noise Exposure Forecast Areas for Chicago O'Hare International Airport*, FAA-DS-67-12, Washington, D. C., Aug. 1967.
- Bishop, D. E., and Haronjeff, R. D., 1965, 1970, 1975 *Noise Exposure Forecast Areas for John F. Kennedy Airport*, FAA-DS-67-11, Washington, D. C., Aug. 1967.
- Bishop, D. E., and Haronjeff, R. D., 1965, 1970, 1975 *Noise Exposure Forecast Areas for Los Angeles International Airport*, FAA-DS-67-13, Calif., Washington, D. C., Aug. 1967.
- Bolt, Beranck and Newman, Inc., *Noise Environment of Urban and Suburban Areas, Results of Field Studies*, HUD, Washington, D. C., Jan. 1967.
- Cohen, A., "Location-Design Control of Transportation Noise," *Urban Planning and Development Division, Proc. of the Am. Soc. of Civil Engrs.*, pp. 63-86, Dec. 1967.
- Galloway, et al., *Study of the Effect of Departure Procedures on the Noise Produced by Jet Aircraft*, FAA-ADS-41, Washington, D. C., Mar. 1965.
- Hoover, I. H., *A System Solution to the Aircraft Noise Problem, Paper 67-761, AIAA/RAES/CASI 10th Anglo-American Aero. Conference*, Los Angeles, Calif., Oct. 18-20, 1967.
- Hubbard, H. H., Maglieri, D. J., and Copeland, W. I., "Research Approaches to Alleviation of Airport Community Noise," *J. Sound Vib.*, Vol. 5, No. 2, pp. 377-390, Feb. 1967.
- Land Use Planning with Respect to Aircraft Noise*, Air Force Manual 86-5, Washington, D. C., Oct. 1964.
- Noise Exposure Forecasts for J. F. Kennedy International Airport*, FAA-DS-67-15, S. A. E. Research Proj. Comm., R 2.5, Documentation of Noise Exposure Around Airports, Washington, D. C., Aug. 1967.
- Noise Exposure Forecasts for Los Angeles International Airport*, FAA-DS-17, S. A. E. Research Project Committee R 2.5, Documentation of Noise Exposure Around Airports, Washington, D. C., Aug. 1967.
- Noise Exposure Forecasts for O'Hare International Airport*, FAA-DS-67-16 S. A. E. Research Proj. Comm., R. 2.5 Documentation of Noise Exposure Around Airports, Washington, D. C., Aug. 1967.
- Noise Study in Manhattan, New York City for the Evaluation of Dominant Noise Sources Including Helicopter Traffic*, Bolt, Beranek and Newman Rept. 1610, Aug. 1967.
- Paulin, R. L. and Miller J. S. F., "Aircraft Noise Abatement—The Prospects for a Quieter Metropolitan Environment," *AIAA Aircraft Design and Operations Meeting*, Paper No. 69-800, Los Angeles, July 14-16, 1969.
- Pietrasanta, A. C., *Factors Influencing the Noise Exposure Under the Landing Path for Jet Aircraft*, FAA-ADS-39, Washington, D. C., Mar. 1965.
- Shapiro, N., and Healy, G. J., "A Realistic Assessment of the Vertiport/Community Noise Problem," *J. Aircraft*, Vol. 5, No. 4, p. 407, July-Aug. 1958.
- Technique for Developing Noise Exposure Forecasts*, FAA-DS-67-14, SAE Research Project Committee R 2.5, Washington, D. C., Aug. 1964.

## V. Subjective

This material is related to the response of humans to noise from aircraft.

*Definitions and Procedures for Computing the Perceived Noise Level of Aircraft Noise*, SAE, ARP 865, New York, N. Y., Oct. 1964.

Hecker, M. H. L., and Kryter, K. D., *Comparisons Between Subjective Ratings of Aircraft Noise and Various Objective Measures*, FAA 68-33, Washington, D. C., Apr. 1968.

Hinterkeuser, E. G., and Sternfield, H., Jr., *Subjective Response to Synthesized Flight Noise Signatures of Several Types of V/STOL Aircraft*, Document D8-0907A, Boeing, Vertol Div., Philadelphia, Pa., Jan. 1968.

Hubbard, H. H., and Maglieri, D. J., *An Investigation of Some Phenomena Relating to Aerial Detection of Airplanes*, NACA TN 4337, Washington, D. C., Sept. 1958.

- Human Aural Response to Noise*, NASA Literature Search Number 7398, Washington, D. C., Nov. 1968.
- Kryter, K. D., "Concepts of Perceived Noisiness, Their Implementation and Application," *J. Acoust. Soc. Am.* Vol. 43, pp. 344-361, 1968.
- Kryter, K. D., "Scaling Human Reactions to the Sound from Aircraft," *J. Acoust. Soc. Am.*, Vol. 31, No. 11, 1959.
- Kryter, K. D., and Williams, C. E., *Some Factors Influencing Human Response to Aircraft Noise*, FAA-ADS-42, Washington, D. C., June 1965.
- Nagel, D. C., Parnell, J. E., and Parry, H. J., *The Effects of Background Noise on Perceived Noisiness*, FAA-DS-67-22, Washington, D. C., Dec. 1967.
- Ollerhead, J. B., *Subjective Evaluation of General Aviation Aircraft Noise*, FAA 68-35, Washington, D. C. Apr. 1968.
- Parnell, J. E., Nagle, D. C., and Parry, H. J., *Growth of Noisiness for Tones and Bands of Noise at Different Frequencies*, FAA-DS-67-21, Washington, D. C., Dec. 1967.
- Pearsons, K. S., *Noisiness Judgments of Helicopter Flyovers*, FAA-DS-67-1, Washington, D. C., Jan. 1967.
- Pearsons, K. S., *The Effect of Duration and Background Noise Level on Perceived Noisiness*, FAA-ADS-78, Washington, D. C., Apr. 1966.
- Pearsons, K. S., and Haronjeff, R. D., *Category Scaling Judgment Tests on Motor Vehicle and Aircraft Noise*, FAA-DS-67-8, Washington, D. C., July 1967.
- Robinson, D. W., "The Subjective Basis for Aircraft Noise Limitation," *J. Roy. Aeronaut. Soc.*, No. 678, 11, pp. 396-500, June 1967.
- Sperry, W. C., *Aircraft Noise Evaluation*, FAA-No-68-34, Washington, D. C., Sept. 1968.
- Standard Values of Atmospheric Absorption as a Function of Temperature and Humidity for Use in Evaluating Aircraft Fly-Over Noise*, SAE, ARP 865, New York, N. Y., Aug. 1964.
- Stevens, S. S., "Calculation of the Loudness of Complex Noise," *J. Acoust. Soc. Am.*, Vol. 28, No. 9, pp. 807-832, Sept. 1956.
- Williams, C. E., Stevens, K. N., Heckler, M. H., and Pearsons, K. S., *The Speech Interference Effects of Aircraft Noise*, FAA-DS-67-19, Washington, D. C., Sept. 1967.

## VI. General

This section contains material related to research programs, federal policy and regulation, and handbooks. Also included are references concerning fundamental acoustic theory and acoustic instrumentation.

*A Brief Guide to Noise Measurements and Analysis*, Research and Development Report 609, U. S. Navy Electronics Lab., San Diego, Calif., May 16, 1955.

*Aircraft Noise Abatement Regulation, Hearing Before the Aviation Sub-Committee of the Committee on Commerce, United States Senate Nineteenth Congress*, Serial No. 90-76, Washington, D. C., June 17, 1968.

*Alleviation of Jet Aircraft Noise Near Airports, A Report of the Jet Aircraft Noise Panel*, Office of Science and Technology, Washington, D. C., Mar. 1966.

*An Aerodynamics Bibliography*, Supplement No. 2, AD-614-594, Supplement to Engineering Report 63-51, 64-20, UCLA, Los Angeles, Calif., Apr. 1965.

Beranek, L. L., *Noise Reduction*. McGraw-Hill Book Company, Inc., New York, 1960.

Bolt, R. H., Beranek, L. L., and Newman, R. B., *Handbook of Acoustic Noise Control*, Vol. 1, Physical Acoustics, WADC TR 42-204, Dayton, O., Dec. 1952.

Bscham, C., *Analysis of Jet and Boundary Layer Noise*, Paper 68-35, International Council of the Aeronautical Sciences 6th Congress, Munich, Germany, Sept. 9-13, 1968.

*Civil Aviation Research and Development, An Assessment of Federal Government Involvement*, Summary Report of the Aeronautics and Space Engineering

- Board, National Academy of Engineering, Washington, D. C., Aug. 1968.
- Colovin, N. E., "Alleviation of Aircraft Noise," *Astronaut and Aeronaut*, Jan. 1967.
- Lighthill, M. J., "Sound Generated Aerodynamically," The Bakerian Lecture, 1961, *Proc. Roy. Soc. London, Ser. A*, Vol. 267, pp. 147-182, 1962.
- Lukasik, S. J., and Nolle, A. W., editors, *Handbook of Acoustic Noise Control, Vol. 1, Physical Acoustics*, Supplement 1, WADC TR 52-204, Dayton, O., Apr. 1955.
- Muller, E. A., and Okermeier, F., *The Spinning Vortices as a Source of Sound*, AGARD CP 22, Paris, France, Sept. 1967.
- Peterson, A. P. N., and Gross, E. E. Jr., *Handbook of Noise Measurement*, General Radio Co., W. Hartford, Conn., 1960.
- Report of ASEB AD HOC Committee on Noise*, National Academy of Engineering, Washington, D. C., Dec. 1968.
- Richards, E. J., "Aeronautical Research at Southampton University," *J. Roy. Aeronaut. Soc.*, Vol. 69, pp. 505-541, Aug. 1965.
- Richards, E. J., "Aircraft Noise, Mitigating the Nuisance," *Astronaut and Aeronaut*, Vol. 5, No. 1, pp. 34-43, Jan. 1967; also *Aircraft Engineering*, Feb. 1967.
- Southampton University Institute of Sound and Vibration Research Annual Report*, Year Ending June 1966, N67-10476, Southampton, England.
- Sperry, W. C., Powers, J. O., and Oleson, S. K., *The Federal Aviation Administration Aircraft Noise Abatement Program*, Presented at ASME Annual International Gas Turbine Conference, Washington, D. C., Mar. 17-21, 1968.
- The Aircraft/Airport Problem and Federal Government Policy*, FAA Office of Noise Abatement, Systems Analysis Staff, Washington, D. C., Dec. 1967.
- von Gierke, H. E., *Handbook of Noise Control*, Chapt. 33, pp. 33-34. Harris, C. M., Editor. McGraw-Hill Book Co., New York, 1957.



## References

1. Lighthill, M. J., "Sound Generated Aerodynamically," The Bakerian Lecture, 1961, *Proc. Roy. Soc. London, Ser. A*, Vol. 267, pp. 147-182, 1962.
2. Ribner, H. S., "The Generation of Sound by Turbulent Jets," *Advances in Applied Mechanics*, Vol. VIII, pp. 103-182. Academic Press, New York, 1964.
3. von Gierke, H. E., *Handbook of Noise Control*, Chapter 33, pp. 33-34. Harris, C. M., Editor. McGraw-Hill Book Co., New York, 1957.
4. Metzger, F. B., Magliozzi, B., Towle, G. B., and Gray, L., *A Study of Propeller Noise Research*, SP 67148, Rev. A., Hamilton Standard, Winsor Locks, Conn., 1961.
5. *Standard Values of Atmospheric Absorption as a Function of Temperature and Humidity for Use in Evaluating Aircraft Noise*, SAE Aerospace Recommended Practice ARP 866, New York, 1964.
6. Yudin, E. Y., *On The Vortex Sound From Rotating Rods*, NACA TM 1136, Washington, D. C., Mar. 1947.
7. Gutin, L., *On The Sound Field of a Rotating Propeller*, NACA TM 1195, Washington, D. C., Oct. 1948.
8. Hubbard, H. H., *Propeller Noise Charts for Transport Airplanes*, NACA TN 2968, Washington, D. C., June 1953.
9. Stowell, E. A., and Deming, A. F., *Vortex Noise From Rotating Cylindrical Rods*, NACA TN 619, Washington, D. C., Feb. 1935.
10. Hicks, C. W., and Hubbard, H. H., *Comparison of Sound Emission From Two-Blade, Four-Blade, and Seven-Blade Propellers*, NACA TN 1354, Washington, D. C., July 1947.
11. Gessow, A., and Myers, G. C., Jr., *Aerodynamics of the Helicopter*, 3rd printing. Frederick Ungar Publishing Co., New York, 1967.
12. Lowson, M. V., and Ollerhead, J. B., *Studies of Helicopter Rotor Noise*, USAVLABS TR 68-60, Ft. Eustis, Va., Jan. 1969.
13. Schlegel, R., King, R., and Mull, H., *Helicopter Rotor Noise Generation and Propagation*, USAVLABS TR 66-4, Ft. Eustis, Va., Oct. 1966.
14. Loewy, R. G., and Sutton, L. R., "A Theory for Predicting the Rotational Noise of Lifting Rotors in Forward Flight, Including a Comparison with Experiment," *J. Sound Vib.*, Vol. 4, No. 3, Nov. 1966.
15. Garrick, I. E., and Watkins, G. E., *A Theoretical Study of the Effect of Forward Speed on the Free-Space Sound Pressure Field Around Propellers*, NACA Rept. 1198, Washington, D. C., 1953.
16. Stuckey, T. J., and Goddard, J. O., "Investigation and Prediction of Helicopter Rotor Noise," *J. Sound Vib.*, Vol. 5, No. 1, pp. 50-80, Jan. 1967.
17. Spencer, R., Sternfield, H., and McCormick, B. W., *Tip Vortex Core Thickening for Application to Helicopter Rotor Noise Reduction*, USAVLABS TR 66-1, Ft. Eustis, Va., Sept. 1966.

## References (contd)

18. Hubbard, H. H., and Regier, A. A., *Propeller Loudness Charts for Light Airplanes*, NACA TN 1358, Washington, D. C., July 1947.
19. Sadler, S. G., and Loewy, A., *A Theory for Predicting the Rotational and Vortex Noise of Lifting Rotors in Hover and Forward Flight*, Rochester Applied Science Associates Rept. 68-11, Rochester, N. Y., 1968 (to be published as a NASA contract report).
20. Cox, R. C., and Lynn, R. R., *A Study of the Origin and Means of Reducing Helicopter Noise*, TCREC-TR 62-73, Ft. Eustis, Va., Nov. 1962.
21. Leverton, J. W., and Taylor, F. W., "Helicopter Blade Slap," *J. Sound Vib.*, Vol. 4, No. 3, pp. 345-357, 1966.
22. Leverton, J. W., *Helicopter Noise—Blade Slap, Part I—Review and Theoretical Study*, NASA CR 1221, Washington, D. C., Oct. 1968.
23. *Conference on STOL Transport Aircraft Noise Certification Sponsored by Federal Aviation Administration of the Department of Transportation*, FAA 69-1, TR 550-003-03H, Washington, D. C., Jan. 30, 1969.
24. Davidson, I. M., and Hargest, T. J., "Helicopter Noise," *J. Roy. Aeronaut. Soc.*, Vol. 69, No. 5, pp. 325-336, May 1965.
25. Sharland, I. J., "Sources of Noise in Axial Flow Fans," *J. Sound Vib.*, Vol. 1, pp. 302-322, 1964.
26. Sowers, H. D., *Investigation of Methods for the Prediction and Alleviation of Lift Fan Noise*, TRECOTM TR 65-4, Ft. Eustis, Va., 1965.
27. Hargest, T. J., "V/STOL Aircraft Noise," *Fluid Dynamics of Rotor and Fan Supported Aircraft at Subsonic Speeds*, AGARD CP 22, Paris, France, Sept. 1967.
28. Pickerell, D. J., and Cresswell, R. A., "Power Plant Aspects of High-Speed Inter-City VTOL Aircraft," *J. Aircraft*, Vol. 5, No. 5, Sept. 1968.
29. Stevens, S. S., "The Measurement of Loudness," *J. Acoust. Soc. Am.*, Vol. 27, No. 5, 1955.
30. Kyter, K. D., "Scaling Human Reactions to the Sound From Aircraft," *J. Acoust. Soc. Am.*, Vol. 31, No. 11, 1959.
31. Sperry, W. C., *Aircraft Noise Evaluation*, FAA 68-34, TR 550-003-03H, Washington, D. C., Sept. 1968.