

A Review Of Energy Efficient Clustering Algorithm For Connecting Wireless Sensor Network Fields

S. R. Boselin Prabhu, Assistant Professor

*Department of Electronics and Communication Engineering,
SVS College of Engineering, Coimbatore, Tamilnadu, India.*

R. Mahalakshmi, S. Nithya, P.D.Manivannan, Final Year Students

*Department of Electronics and Communication Engineering,
SVS College of Engineering, Coimbatore, Tamilnadu, India.*

S. Sophia, Professor

*Department of Electronics and Communication Engineering,
Sri Krishna College of Engineering and Technology, Coimbatore, India.*

Abstract—Wireless Sensor Network has various characteristics such as feasibility of rapid deployment, self-organization and fault tolerance. Such networks are constructed by randomly but densely scattered tiny sensor nodes. Various algorithms have been developed to minimize the energy consumption of sensor nodes. Among them, Low Energy Adaptive Clustering Hierarchy (LEACH) is considered to be more efficient. In this paper, a review of energy efficient Optical Low Energy Adaptive Clustering Hierarchy algorithm has been compared with existing Low Energy Adaptive Clustering Hierarchy algorithm, between two wireless sensor network fields. The comparison is based on the parameters: data rate and network lifetime. To overcome the drawbacks of Optical Fiber Sensor (OFS) link, few concepts has been investigated.

Keywords— *Distributed fiber sensor, clustering, cluster head, energy efficiency, network lifetime.*

I. INTRODUCTION

Wireless Sensor Network (WSN) is major and very interesting technology applied to different applications like monitoring the accessible conditions in a specific area [1]. A WSN consists of number of distributed nodes which are connected without the use of wires. Each node is connected with one or more sensors. Each sensor node consists of a wireless transmitter/receiver, a microcontroller and a battery. The major advantages of these networks: self organization, fault tolerance characteristics, energy efficient, they avoid wiring problems and it can be accessed through a centralized control. A WSN system incorporates a gateway that provides wireless connectivity back to the wired world and distributed nodes. The components of a wireless sensor node are condensed in figure 1. The wireless algorithm depends on various application requirements. Some of the available standards include 2.4 GHz radio based on either IEEE 802.15.4 or IEEE 802.11 (Wi-Fi) standards or proprietary radios, which are usually 900 MHz [1]. WSN has applications on the areas including health care, utilities, and remote monitoring. In case

of health care, wireless devices make less invasive patient monitoring and health care possible. In order to decrease the data transmission time and energy consumption [6], the sensor nodes are grouped into many clusters. The grouping of sensor nodes is known as clustering (figure 2). In cluster formation, every cluster has a leader which is known as cluster head (CH). A CH is also one of the sensor nodes which have advanced capabilities than other sensor nodes. The CH is selected by the sensor nodes in the relevant cluster and may also possible by the user to pre-assign the CHs. The main advantage of clustering is that, the CH is used to transmit the aggregated data [5] to the sink or Base Station (BS) [3]. Clustering can be classified into three types: centralized clustering, distributed clustering and hybrid clustering. The centralized clustering is one in which the fixed CH is assigned for clusters. The remaining nodes in the cluster act as a member nodes. Distributed clustering [2] is one in which the CH is not fixed. The CH keeps on shifting form node to node based on some parameters. Hybrid clustering is one which is formed by the combination of the centralized clustering and the distributed clustering.

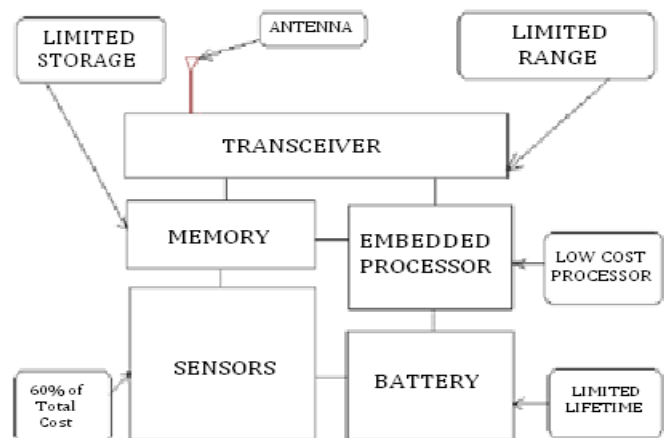

Figure 1. Components of a wireless sensor network.

Distributed clustering is widely used in WSNs node grouping because it provides enhanced collection of data [4, 7] and reliability. In addition to clustering algorithms, there are many routing algorithms presented in wireless sensor networks. The routing algorithms are divided into flat-based routing, hierarchical-based routing and location-based routing depending upon the network structure (Few examples are: MCFA, IDSQ, CADR, COUGAR, ACQUIRE, MECN, SOP, VGA, HPAR, TTDD, GAF, GEAR, MFR, DIR, GEDIR, GOAFR, SPAN, etc.).

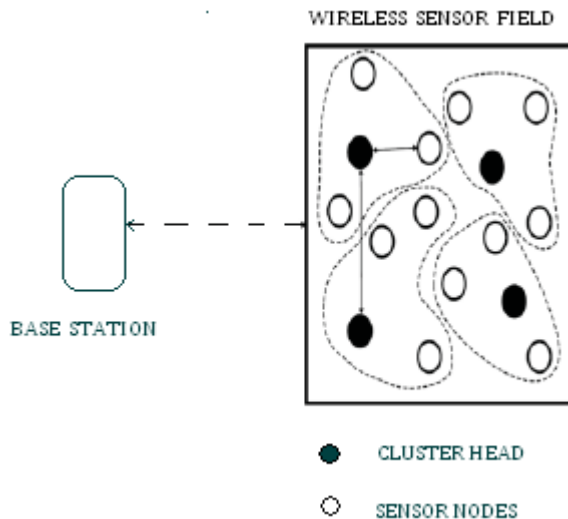

Figure 2. Cluster based wireless sensor network.

II. REVIEW OF EXISTING DISTRIBUTED CLUSTERING ALGORITHMS

Distributed clustering is the one in which the CH rotates from one node to another depending on the resources of the nodes. In this section, a comparative study of various available decentralized clustering algorithms for WSNs is presented. LCA and HC are some of the cluster formation algorithms used for collision avoidance in WSN [8]. DWEHC and HEED are some of the algorithm which selects CH based on residual energy and communication cost. RECA is an algorithm, which evenly distributes the workload among the nodes within a cluster. CLUBS is an algorithm that allows the overlapping of cluster among WSN field. FLOC is a decentralized non-overlapping clustering algorithm which is suitable for clustering in large-scale WSNs.

Low Energy Adaptive Clustering Hierarchy (LEACH): LEACH [9, 11] is a clustering mechanism that distributes energy consumption all along its network, the network being divided into clusters, CHs which are purely distributed in manner and the randomly elected CHs collect the information from the nodes which are coming under its cluster. It forms clusters based on the received signal strength (RSS) and uses the CH nodes as routers to the BS. All the data processing such as data fusion and aggregation are local to the cluster.

LEACH forms clusters by using a distributed algorithm [8], where nodes make autonomous decisions without any centralized control. Initially a node decides to be a CH with a probability 'p' and broadcasts its decision. Each non-CH node determines its cluster by choosing the CH that can be reached using the least communication energy. The role of being a CH is rotated periodically among the nodes of the cluster in order to balance the load. The rotation is performed by getting each node to choose a random number 'T' between 0 and 1. A node becomes a CH for the current rotation round if the number is less than the threshold. The main disadvantage of this algorithm is that, when node dies, the whole cell becomes dysfunctional. It is not applicable to large scale networks.

The O-LEACH Algorithm

In O-LEACH algorithm, an infrastructure of a sensor network that is composed of a DFS link and two separated WSNs, is shown in figure 3. The DFS link is situated at the center of the sensor fields and can cover a certain area. The two WSN fields are filled with randomly scattered nodes and these nodes can or cannot communicate with each other depending on the required applications. Unlike simple WSNs, since the DFS provide data processing (as an active sensor "link" without energy restriction), at one end of the DFS link, the sink or the base station (BS) for all WSN nodes is located.

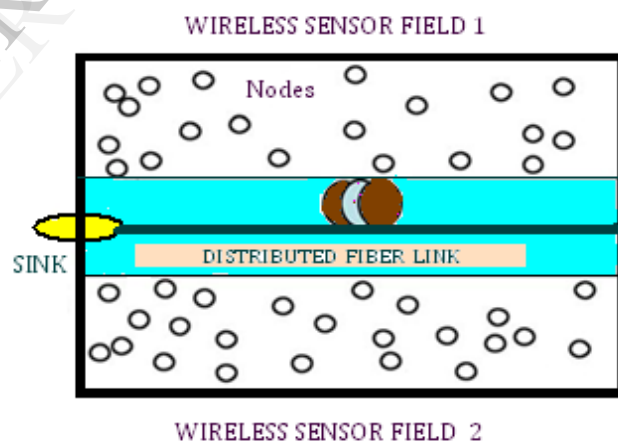

Figure 3. Sensor field consisting of a DFS link and two WSN fields (I and II).

Although the performance (lifetime) of the DFS may have to be considered as well, an assumption that the lifetime of such a sensor network is mainly determined by the WSN. It results that clustering based algorithm still exhibits good energy efficiency in the sensor network, especially when two WSNs are not reachable to each other. In addition, as the DFS may cover a long rectangular area (up to tens of kilometers), O-LEACH algorithm is used to investigate the lifetime of the hybrid sensor network with rectangular topology by dividing and linking a series of WSNs around the DFS.

III. O-LEACH ALGORITHM FOR TWO WSN

As only nodes of two WSNs are energy or power limited, the algorithm is mainly dealing with these nodes, starting from random node positioning outside the DFS coverage area, while inside the phenomenon. As LEACH is a cluster-based algorithm, the sensor nodes in the network organize themselves into local clusters, in each cluster one of the sensor nodes is selected randomly as the cluster head (CH) and this role is rotated to evenly distribute the energy load among nodes in the network. The CH nodes compress data arriving from nodes that belong to the relevant cluster, and send an aggregated packet to the BS in order to further reduce the amount of information that must be transmitted to the BS, thus reducing energy dissipation and enhancing system lifetime. After a given interval of time, to maximize the uniformity of energy dissipation of the network randomized rotation of the role of CH is conducted. Sensors elect themselves to be local cluster heads at any time with a certain probability. LEACH uses a TDMA/CDMA MAC to reduce intercluster and intracluster collisions. As data collection is centralized and performed periodically, this algorithm is most suitable when there is a need for constant monitoring by the sensor network.

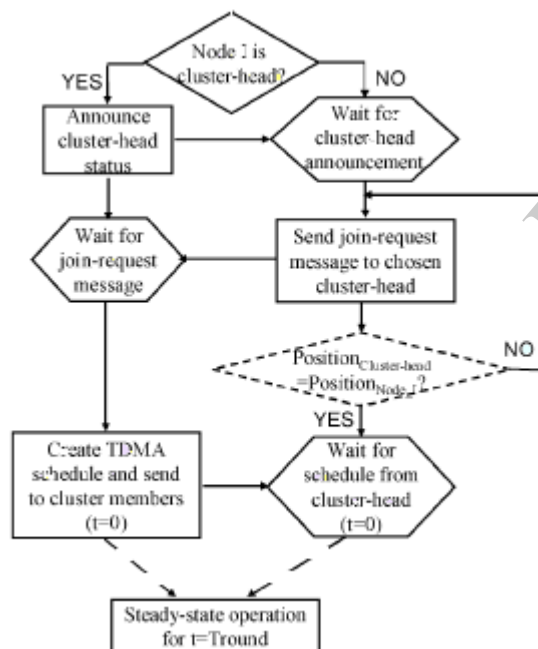

Figure 4. Flowchart of O-LEACH algorithm [1]

As the operation of the standard LEACH algorithm is separated into the setup phase and the steady phase, O-LEACH (figure 4) operation [10] is also separated into two phases, and the steady phase is as same as the LEACH. During the setup phase, the selection of the cluster head follows the similar criteria as LEACH, but there are two major differences between O-LEACH and LEACH: (i) nodes of WSNs cannot be deployed in the DFS coverage area (first check) and (ii) the cluster head and the node should be within the same WSN field if two WSNs cannot communicate with each other (i.e., checking if in the flowchart). For most applications, it is better

to assume that two WSN fields are isolated due to the following reasons: (i) saving information transfer energy since

longer data transfer distance over the DFS terrain ends with higher energy consumption and (ii) wireless communication over the DFS area is not even allowed for some applications. From the flow chart of the O-LEACH algorithm, the fact that this algorithm is only a fairly incremental modification to the original LEACH is admitted.

IV. SIMULATION RESULTS

Based on the O-LEACH algorithm, the network performance in terms of the data rate and network lifetime has been simulated. In the simulation model: 1) most of parameters (e.g., Time of simulation end, data packet length, control packet length, etc.) are listed in table 1; 2) In O-LEACH, the sink is assumed to be at the same position for all the cases, i.e., in the middle of one edge of the sensor field (i.e., the center of one end of the DFS); 3) as the network energy dissipation is totally a statistical behavior due to the random distribution of WSN nodes, every case for 1000 independent iterations (it takes days to get such statistical results) has been simulated; and 4) as the ONS (DFS) is totally active (i.e., no energy constraint), the lifetime of the DFS is not considered.

Table 1. Simulation Setup

Topology	500x500 m ²
Data packet size	4000 bytes
Control packet size	550 bytes
Initial energy	100 Joules
Transmitter power	31.32 mW
Receiver power	35.28 mW
Ideal power	712 mW
Sleep power	144 mW

First, the network performance in terms of the lifetime has been compared. The cases are simulated: O-LEACH with those two WSNs can or cannot communicate with each other. Different parameters to evaluate the lifetime is followed by many researchers, in this paper the parameters of energy and number of rounds has been considered. Here the reduced communication reliability may happen during the energy depletion. It is to be noted that in most practical applications, the DFS coverage is very specific and cannot be freely varied. While sometimes parallel DFS links may be deployed to cover more broad areas, therefore, the DFS coverage width is varied in the simulation for the purpose of comparison.

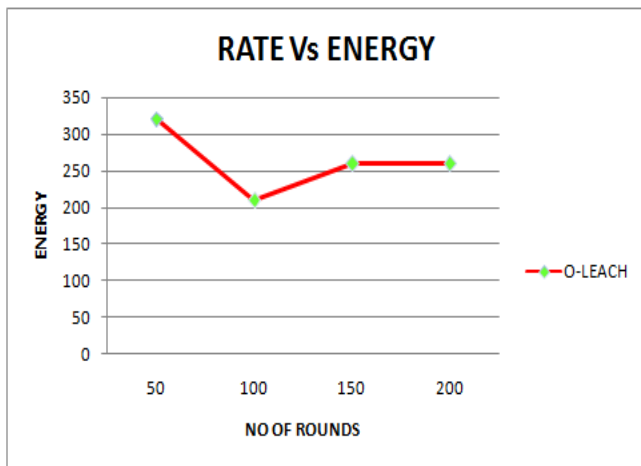

Figure 5. Data rate versus Energy of O-LEACH

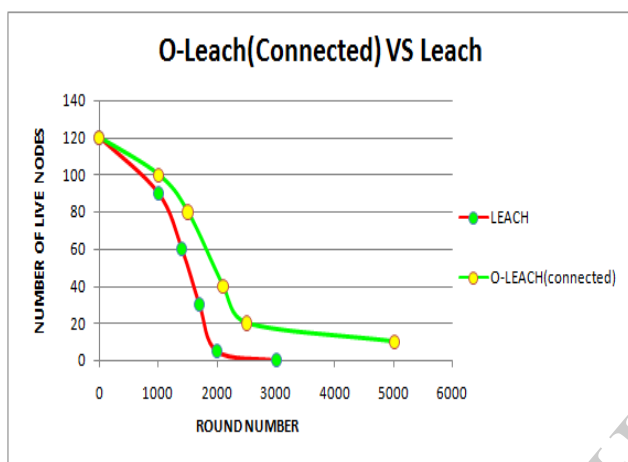

Figure 6. Number of live nodes versus Round number (O-LEACH connected and LEACH)

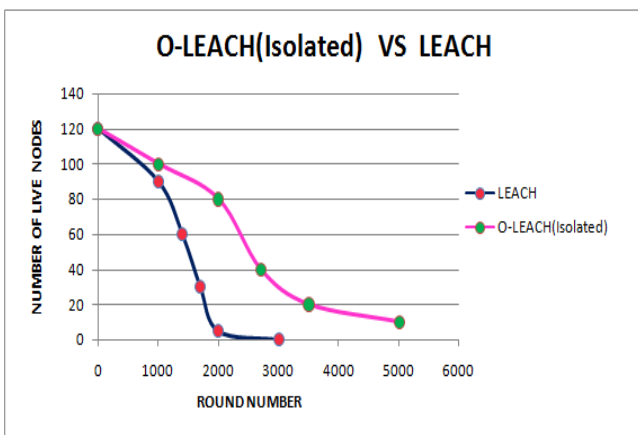

Figure 7. Number of live nodes versus Round number (O-LEACH isolated and LEACH)

For O-LEACH simulation (figure 5), the energy level of nodes is considered as invariable with respect to the no of rounds up to 50. After 50th round, the energy level of total field is linearly decreased till 100th round. The representation of decay energy is the cluster groups are destroyed due to energy dissipation of nodes. After 100th round energy level will be improved

because the number of clusters decreases and again cluster formations have occurred in WSN fields. Then energy level is maintained at the end of simulation. The typical lifetime evolutions are compared as well in Figures 6 and 7. Results of LEACH algorithm are also included. The results further demonstrate that the hybrid sensor network incorporating DFS with the O-LEACH algorithm can evenly distribute the energy load among nodes, thereby extending the overall lifetime of the network.

V. PROPOSED ALGORITHM

As the optical fiber links leads to various disadvantages like: 1) Scattering losses, it is not applicable to use the link for efficient long haul communications. 2) The changes on the light properties usually happen in the sensor. 3) Need for more expensive optical transmitters and receivers. 4) More difficult and expensive to splice than wires and 5) Cannot carry electrical power to operate terminal devices. These drawbacks could be overcome by changing the optical fiber link with alternate medium for communication.

VI. CONCLUSION

Wireless Sensor Networks are a type of Adhoc networks that tends to be one of the very attractive platforms for researchers. Clustering is the most significant issue for networks when resources are restricted. The growth of WSN with high computation capability needed the sensor nodes must be designed in order to deal with very complex clustering functions. Every sensor is usually restricted in their energy level, processing power and sensing capability. It is required to make use of the available energy efficiently. In this paper, a review of energy efficient Optical Low Energy Adaptive Clustering Hierarchy algorithm has been compared with existing Low Energy Adaptive Clustering Hierarchy algorithm between two wireless sensor network fields. The comparison is based on the parameters: data rate and network lifetime. Future research will be carried out in development of a clustering algorithm for achieving energy efficiency

References

- [1] Chia Hung Tsai, Yu Chee Tseng, (2012), "A path-connected-cluster wireless sensor network and its formation, addressing, and routing algorithms", IEEE Sensors Journal, Volume 12, Number 6.
- [2] S.R.Boselin Prabhu, S.Sophia, (2011), "A survey of adaptive distributed clustering algorithms for wireless sensor networks", International Journal of Computer Science and Engineering Survey, Volume 2, Number 4, Pages 165-176.
- [3] C.T. Cheng, C.K. Tse, and F. C. M. Lau, (2011), "A clustering algorithm for wireless sensor networks based on social insect colonies," IEEE Sensors Journal, Volume 11, Number 3, Pages 711-721.

[4] Pedro A. Forero, Alfonso Cano, Georgios B.Giannakis, (2011), "Distributed clustering using wireless sensor networks", IEEE Journal of Selected Topics in Signal Processing, Volume 5, Number 4, Pages 707-724.

[5] Yajie Ma, Yike Guo, Xiangchuan Tian, and Moustafa Ghanem, (2011)," Distributed clustering-based aggregation algorithm for spatial correlated sensor networks", IEEE Sensors Journal, Volume 11, Number 3.

[6] Yang Yang, Rick S. Blum, and Brian M. Sadler, (2010)," A distributed and energy-efficient framework for neyman-pearson detection of fluctuating signals in large-scale sensor networks", IEEE Journal, Volume 28, Number 7.

[7] Y. Yang, R. S. Blum, and B. M. Sadler, (2009), "Energy-efficient routing for signal detection in wireless sensor networks", IEEE Transactions on Signal Processing, Volume 57, Number 6, Pages 2050-2063.

[8]S.R.Boselin Prabhu, S.Sophia, P.D.Manivannan, S.Nithya, R.Mahalakshmi, (2012), "A research on decentralized clustering algorithms for dense wireless sensor networks", International Journal of Computer Applications (0975 – 8887) Volume 57, Number 20.

[9] W.B. Heinzelman, A.P. Chandrakasan, H. Balakrishnan, (2002), "Application specific algorithm architecture for wireless microsensor networks", IEEE Transactions on Wireless Networking.

[10] B. Huttner, J. Reeht, N. Gisin, R. Passy, and J. P. von derWeid, (1998), "Local birefringence measurements in single-mode fibers with coherent optical frequency-domain reflectometry," IEEE Photon Technology Letters, Volume 10, Number 10, Pages 1458–1460.

[11] S.R.Boselin Prabhu, S.Sophia, (2013), "Mobility Assisted Dynamic Routing for Mobile Wireless Sensor Networks", International Journal of Advanced Information Technology (IJAIT), Volume 3, Number 1.