

# A Robust Control Strategy for Shunt and Series Reactive Compensators to Damp Electromechanical Oscillations

Mojtaba Noroozian, *Senior Member, IEEE*, Mehrdad Ghandhari, *Student Member, IEEE*, Göran Andersson, *Fellow, IEEE*, J. Gronquist, *Member, IEEE*, and I. Hiskens, *Senior Member, IEEE*

**Abstract**—This paper examines the enhancement of power system stability properties by use of thyristor controlled series capacitors (TCSCs) and static var systems (SVCs). Models suitable for incorporation in dynamic simulation programs used to study angle stability are analyzed. A control strategy for damping of electromechanical power oscillations using an energy function method is derived. Using this control strategy each device (TCSC and SVC) will contribute to the damping of power swings without deteriorating the effect of the other power oscillation damping (POD) devices. The damping effect is robust with respect to loading condition, fault location and network structure. Furthermore, the control inputs are based on local signals. The effectiveness of the controls are demonstrated for model power systems.

**Index Terms**—Control strategy, energy function, interaction, local variables, POD, power swings, SVC, TCSC.

## I. INTRODUCTION

**D**AMPING of electromechanical oscillations has been recognized as an important issue in electric power system operation. Application of power system stabilizers (PSSs) has been one of the first measures to enhance the damping of power swings. With increasing transmission line loading over long distances, the use of conventional power system stabilizers might in some cases, not provide sufficient damping for inter-area power swings [1], [2]. In these cases, other effective solutions are needed to be studied.

The basic power flow equation through a transmission line shows that modulating the voltage and reactance influences the flow of active power. In principle, a thyristor-controlled series capacitor (TCSC) and a static-var system (SVC) could provide fast control of active power through a transmission line. The possibility of controlling the transmittable power implies the potential application of these devices for damping of power system electromechanical oscillations. SVCs are mainly used to perform voltage or reactive power regulation. However, there has been a growing trend to use SVCs to aid system stability. In general, a compensator maintaining constant terminal voltage is not effective in damping of power oscillations. To damp power

oscillations a supplementary control signal should be added to the SVC regulator. Damping effect of an SVC has the following features [3]–[5]:

- SVC becomes more effective for controlling power swings at higher levels of power transfer.
- The effectiveness of SVC for power swing damping is dependent on SVC placement. In general damping is most effective when SVC is located near the electrical midpoint of the intertie.
- When an SVC is designed to damp the inter-area modes, it might excite the local modes.
- SVC damping effect is dependent on load characteristics.

Reducing the tieline reactance with a series capacitor to improve the angle stability is well known. In 1966, Kimbark showed that the transient stability of an electric power system can be improved by a switched series capacitor [6]. Later work has explored the benefits of the controllable series capacitor for improving small disturbance stability [7]. The damping effect of TCSC has the following features [3], [5], [8]:

- TCSC becomes more effective for controlling power swings at higher levels of power transfer.
- The location of a TCSC on an intertie does not affect the damping effect.
- The damping effect is not sensitive to the load characteristic.
- When a TCSC is designed to damp the inter-area modes, it does not excite the local modes.
- The effectiveness of a TCSC for damping of power swings is higher than that of an SVC.

A question of great importance is the selection of the input signals for the TCSC and SVC in order to damp power oscillations in an effective and robust manner. From control design and practical consideration, a desirable input signal should have the following characteristics:

- The swing modes should be observable in the input signal.
- A desirable level of damping should be achieved.
- The damping effect should be robust with respect to changing operating conditions.
- The input signal should preferably be local.

Valuable work on the selection of input signals and control strategies to enhance power swing damping have been reported [4], [9]–[13]. The works have provided useful insights and experiences in power swing damping. However, it is still difficult to handle the robustness issues in a desirable manner.

Manuscript received July 23, 1997.

M. Noroozian is with ABB Power Systems, S-721 64 Västerås, Sweden.

M. Ghandhari and G. Andersson are with the Royal Institute of Technology, S-100 Stockholm, Sweden.

J. Gronquist is with Bios Group, LP, 317 Paseo de Peralta, Santa Fe, NM 87501 USA.

I. Hiskens is with the University of Newcastle Australia.

Publisher Item Identifier S 0885-8977(01)08501-6.

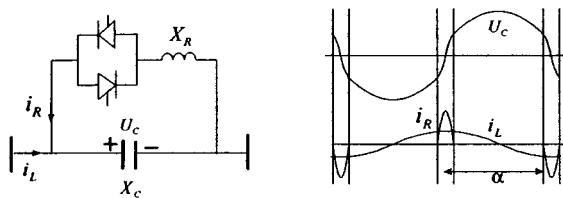

Fig. 1. TCSC circuit with voltage and currents waveforms.

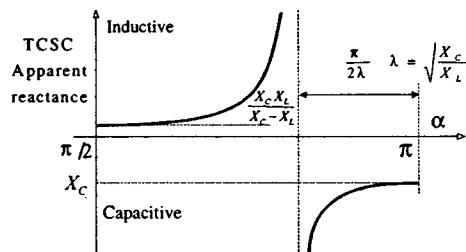

Fig. 2. TCSC steady-state reactance characteristic.

This paper develops control strategies for these devices based on energy function methods. The derived controls use local input signals. The damping effect is robust with respect to loading condition, direction of power flow, fault location and type of faults. The emphasis of this paper is to show that the damping effect of a TCSC and an SVC can be added using the developed control strategies. In other words, each component can contribute to the damping of power swings without any coordination with the other power swing damping devices. This work is in the line with [14]–[16] and complementary to the previous work [17], in which energy function approaches were used for power swing damping. The outline of this paper is as follows:

Section II examines modeling of TCSCs and SVCs for power swing damping. Section III develops power swing damping control strategies. Section IV demonstrates through simulations the performance of the devices for damping of power oscillations.

## II. MODELING

This section discusses the models of TCSC and SVC which can be used for power swing studies.

### A. TCSC

Fig. 1 shows the main circuit of a TCSC in the steady state:

The capacitor voltage varies by controlling the current pulses through the thyristor branch. Steady state relation of the apparent reactance of TCSC can be deduced by determining the fundamental frequency component of  $U_c$  and dividing by  $I_L$ . Fig. 2 shows the characteristic of the TCSC apparent reactance at fundamental frequency.

For power swing damping studies, a TCSC can be modeled as a variable reactance. Fig. 3 shows the general block diagram of the TCSC model used for power swing studies:

Based on a control strategy a signal  $X_{ref}^{TCSC}$  is determined. This signal is passed through a delay block. The time constant  $T$  approximates the delay due to the main circuit characteristics and control systems. The output of the model is restricted by two limits.

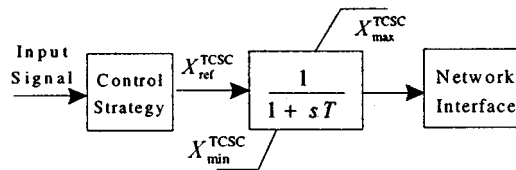

Fig. 3. TCSC model as damping controller.

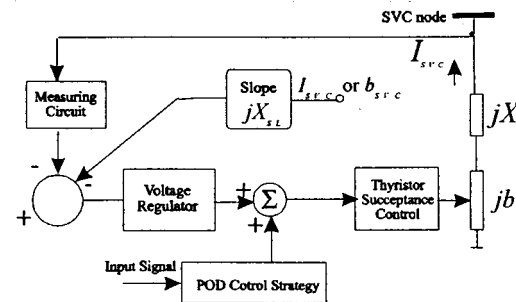

Fig. 4. Block diagram of SVC.

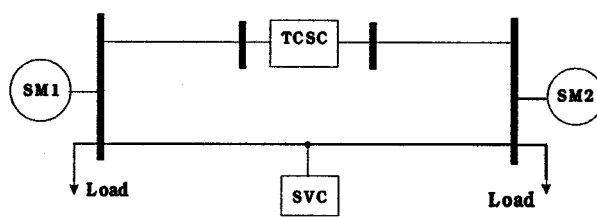

Fig. 5. A two-machine system with TCSC and SVC.

- 1) Fixed limit: The maximum apparent reactance.
- 2) Variable limit: The voltage across the TCSC.

### B. SVC

Fig. 4 shows the block diagram of an SVC model which is used for stability analysis [18]. The voltage regulator is normally of integrator type. The slope of the steady state characteristic is adjusted by  $X_{SL}$ . The delays associated with thyristor firing is modeled in the thyristor susceptance control module. The supplementary signals can be added to the reference voltage or to the output of the voltage regulator. The POD control strategy determines the damping control signal. This signal is added to the output signal from the voltage regulator module. The choice of the input signal and the control strategy are discussed in the next section.

## III. CONTROL STRATEGY

This section develops control strategies for TCSCs and SVCs for damping of electromechanical oscillations. First the model of the controllers are incorporated in an energy function. Then the time derivative of the energy function is determined to yield the control laws.

### A. Derivation of Control Laws

Fig. 5 shows a two-machine system. A TCSC and an SVC are located on this network.

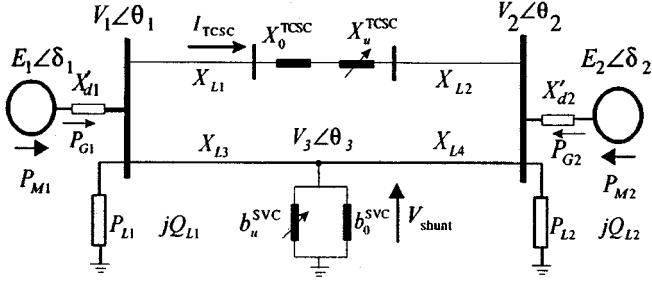

Fig. 6. The equivalent model of the two-machine system.

In a power system with  $N_G$  generators and  $N_L$  loads, the energy function is defined as [19], [20]:

$$\nu = \sum_{k=1}^{N_G} \left( \frac{1}{2} M_k \dot{\omega}_k^2 - P_{Mk} \tilde{\delta}_k \right) + \sum_{k=1}^{N_L} \left( P_{Lk} \tilde{\theta}_k + \int \frac{Q_{Lk}}{V_k} dV_k \right) + \frac{1}{2} \sum Q_{\text{series}} \quad (3.1)$$

where  $Q_{\text{series}}$  is the generated reactive power in series branches. The angles and speeds are measured with respect to the center of inertia (COI) reference frame. TCSC is modeled as a series combination of a fixed reactance,  $X_0^{\text{TCSC}}$  and a controlled part,  $X_u^{\text{TCSC}}$ . The SVC is modeled as a parallel combination of a fixed shunt admittance  $b_0^{\text{SVC}}$  and a controlled part  $b_u^{\text{SVC}}$ . We assume a reduced model (classical model) of the synchronous machines. Fig. 6 shows the equivalent of the two-machine system:

The apparent reactance of TCSC is:

$$X^{\text{TCSC}} = X_0^{\text{TCSC}} + X_u^{\text{TCSC}}.$$

If we define:  $X_L = X_{L1} + X_{L2}$ , the energy function for the system shown in Fig. 6 becomes:

$$\begin{aligned} \nu = & \frac{1}{2} M_1 \dot{\omega}_1^2 + \frac{1}{2} M_2 \dot{\omega}_2^2 - (P_{M1} \tilde{\delta}_1 + P_{M2} \tilde{\delta}_2) \\ & + (P_{L1} \tilde{\theta}_1 + P_{L2} \tilde{\theta}_2) + \int \frac{Q_{L1}}{V_1} dV_1 \\ & + \int \frac{Q_{L2}}{V_2} dV_2 + \int \frac{b_0^{\text{SVC}} V_3^2}{V_3} dV_3 \\ & + \frac{1}{2X'_{d1}} [V_1^2 + E_1^2 - E_1 V_1 \cos(\tilde{\theta}_1 - \tilde{\delta}_1)] \\ & + \frac{1}{2X'_{d2}} [V_2^2 + E_2^2 - E_2 V_2 \cos(\tilde{\theta}_2 - \tilde{\delta}_2)] \\ & + \frac{1}{2X_{L3}} [V_3^2 + V_1^2 - V_3 V_1 \cos(\tilde{\theta}_3 - \tilde{\theta}_1)] \\ & + \frac{1}{2X_{L4}} [V_3^2 + V_2^2 - V_3 V_2 \cos(\tilde{\theta}_3 - \tilde{\theta}_2)] \\ & + \frac{1}{2(X_L + X_0^{\text{TCSC}})} [V_1^2 + V_2^2 - V_1 V_2 \cos(\tilde{\theta}_1 - \tilde{\theta}_2)]. \end{aligned} \quad (3.2)$$

Note that in (3.2),  $Q_{\text{series}}$  for TCSC is equal to  $X_0^{\text{TCSC}} I_{\text{TCSC}}^2$ . To damp the electromechanical oscillations, the total level of the energy function must decrease and therefore the series and the

shunt components must be controlled in such a way that:  $\dot{\nu} \leq 0$ . The time derivative of the energy function yields:

$$\begin{aligned} \dot{\nu} = & (M_1 \dot{\omega}_1 + P_{G1} - P_{M1}) \dot{\tilde{\delta}}_1 + (M_2 \dot{\omega}_2 + P_{G2} - P_{M2}) \dot{\tilde{\delta}}_2 \\ & + \sum_{n=1}^3 \dot{\tilde{\theta}}_n P_n^{\text{inj}} + \sum_{n=1}^3 \frac{\dot{V}_n}{V_n} Q_n^{\text{inj}} - \frac{1}{2} b_u^{\text{SVC}} \frac{d}{dt} V_{\text{shunt}}^2 \\ & - \frac{1}{2} \frac{X_u^{\text{TCSC}}}{(X_L + X^{\text{TCSC}})(X_L + X_0^{\text{TCSC}})} \frac{d}{dt} V_{\text{series}}^2 \end{aligned} \quad (3.3)$$

where  $V_{\text{series}}$  is the magnitude of the voltage across the compensated line and is given by:

$$V_{\text{series}}^2 = V_1^2 + V_2^2 - 2V_1 V_2 \cos(\theta_1 - \theta_2). \quad (3.4)$$

The first and the second expressions are the generators power balance equation and are zero. The terms  $P_n^{\text{inj}}$  and  $Q_n^{\text{inj}}$  are the active and reactive power balance equations at the three nodes and are zero.

It is observed that  $\dot{\nu}$  is dependent on the derivative of the square of voltage across the shunt compensator the compensated line.

Furthermore:

$$\begin{aligned} X_L + X^{\text{TCSC}} &> 0 \\ X_L + X_0^{\text{TCSC}} &> 0. \end{aligned}$$

Thus, a sufficient condition to satisfy  $\dot{\nu} \leq 0$  is that each term in (3.3) is nonpositive.

This gives the following control laws:

- Control law for SVC:

$$\begin{cases} b_u^{\text{SVC}} = k_{\text{SVC}} \frac{d}{dt} (V_{\text{shunt}})^2 & k_{\text{SVC}} > 0 \\ b_{\text{min}} < b^{\text{SVC}} < b_{\text{max}}. \end{cases}$$

The voltage across SVC is used as input signal.

- Control law for TCSC:

$$\begin{cases} X_u^{\text{TCSC}} = k_{\text{TCSC}} \frac{d}{dt} (V_{\text{series}})^2 & k_{\text{TCSC}} > 0 \\ X_{\text{min}}^{\text{TCSC}} < X^{\text{TCSC}} < X_{\text{max}}^{\text{TCSC}}. \end{cases}$$

The information about  $V_{\text{series}}$  is available locally since:  $V_{\text{series}} \cong I_{\text{TCSC}} X_L + U_{\text{TCSC}}$ . The voltage across TCSC and the current through TCSC are used as input signals.

### B. Robustness

Since the controls do not include any parameter which is dependent on the network condition, the control response is robust with respect to:

- System loading.
- Network topology.
- Fault type and location.

The control is effective both for damping of small and large signal disturbances.

### C. Interaction of SVCs and TCSCs

The mathematical approach for deriving the developed control strategies can be extended to multiple shunt and series

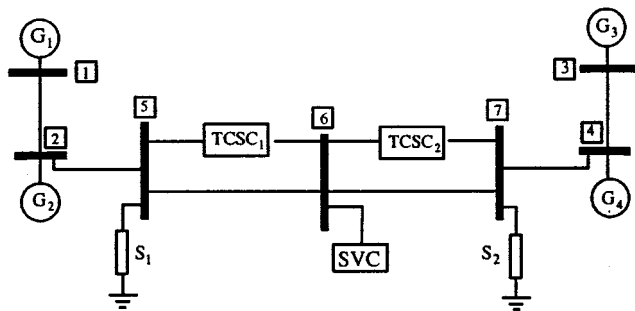

Fig. 7. Four-machine test system.

TABLE I  
SIMULATION SCENARIOS FOR THE FOUR-MACHINE SYSTEM

Case	SVC (V.R.)	SVC (POD)	TCSC1 (POD)	TCSC2 (POD)
i	No	No	No	No
ii	Yes	No	No	No
iii	Yes	Yes	No	No
iv	Yes	No	Yes	No
v	Yes	No	No	Yes
vi	Yes	No	Yes	Yes
vii	Yes	Yes	Yes	Yes

compensators. Suppose that there are totally  $m_1$  SVCs and  $m_2$  TCSCs in a power system. In this case the derivative of energy function is extended to:

$$\dot{v} = -\frac{1}{2} \sum_1^{m_1} b_u^{SVC} \frac{d}{dt} V_{shunt}^2 - \frac{1}{2} \sum_1^{m_2} X_u^{TCSC} \frac{d}{dt} V_{series}^2 \leq 0. \tag{3.5}$$

A sufficient condition to make  $\dot{v}$  negative is that each device fulfills the controls laws derived above. In this way, each device will contribute to the decrease of the total energy without deteriorating the impact of the other controllers. An outstanding feature of this control strategy is de-centralization, i.e., each device is controlled without any coordination with any other controller or a control center. This argument is valid if the system includes PSSs or other damping devices.

#### IV. SIMULATION RESULTS

The proposed control strategy is tested in the power system shown in Fig. 7. The data of the network is given in [21]. This system demonstrates both local mode and inter-area oscillations when a disturbance occurs in the system.

The size of SVC and TCSC is 200 Mvar. The maximum boost of TCSC apparent reactance is  $\pm 15\%$  of the inertia reactance. Table I shows different studied cases:

The response of the system to a 80 ms three phase fault at node 6 is shown below. The speed of generator 1 is taken as reference and the speed between generator 3 and generator 1 (representative of the inter-area mode) and the difference between

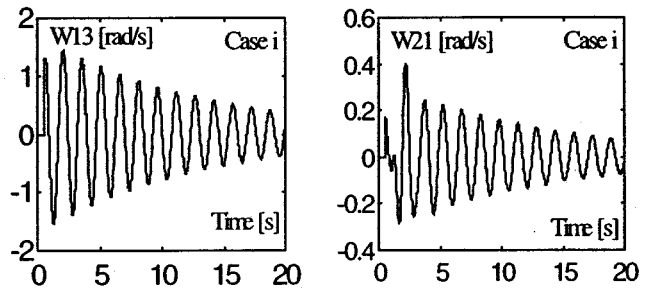

Fig. 8. Case i.

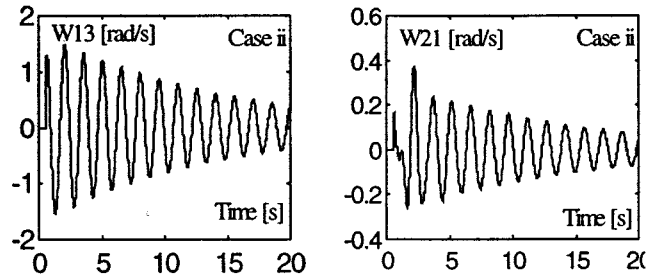

Fig. 9. Case ii.

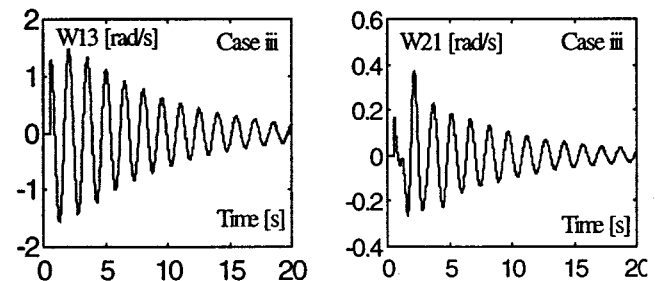

Fig. 10. Case iii.

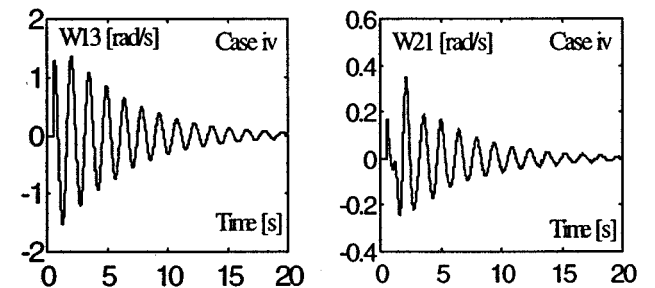

Fig. 11. Case iv.

the speed of generator 2 and 1 (representative of the local mode) for different cases are shown through Figs. 8–14.

The simulation results show the effectiveness of the proposed control strategies. Fig. 9 (case ii) shows that the voltage regulating function of provides a very little damping contribution. Fig. 10 (case iii) shows that the supplementary POD control of SVC is effective. Figs. 12 and 13 show the effectiveness of TCSC for damping of power swings. We note that the impact of TCSCs on damping is higher than SVC. Fig. 14 shows that the damping effect of SVC and the TCSC are additive.

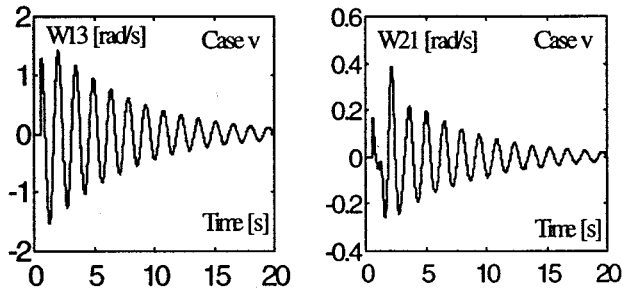

Fig. 12. Case v.

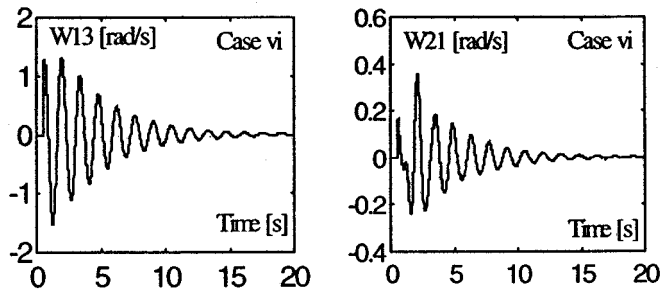

Fig. 13. Case vi.

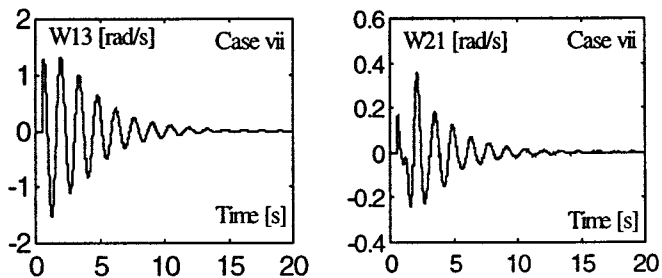

Fig. 14. Case vii.

### A. Experiment on Large Systems

The proposed control laws have been successfully tested in a 300 bus, 60 machines model of Nordel System.

## V. CONCLUSION

This paper has developed control laws for damping electromechanical oscillations using SVCs and TCSCs. The conclusions of this paper can be summarized as follows:

- The proposed control strategy based upon local input signals can be used for series and shunt compensator devices (TCSC, and SVC) to damp power swings. The performance of such a controller is robust with respect to network structure, fault location and system loading.
- Using the proposed control strategies, the series and shunt connected compensators can be located in several locations. The total effect on damping power swings is larger than the impact of the individual devices.
- The control structure is decentralized and does not need any coordination with the other POD devices.

## REFERENCES

- [1] J. F. Hauer, "Reactive power control as a means for enhanced inter-area damping in the Western U.S. power system," *IEEE Tutorial Course 87TH0187-5-PWR*, 1987.
- [2] M. Noroozian, P. Halvarsson, and H. Othman, "Application of controllable series capacitors for damping of power swing," in *Proceedings of V Symposium of Specialists in Electric Operational and Expansion Planning*, vol. 1, Recife, Brazil, May 1996, pp. 221–225.
- [3] M. Noroozian and G. Andersson, "Damping of power system oscillations by controllable components," *IEEE Trans. Power Delivery*, vol. 9, no. 4, pp. 2046–2054, Oct. 1994.
- [4] E. Larsen and J. H. Chow, "Application of static var systems for system dynamic performance," *IEEE Tutorial Course 87 TH0187-5 PWR*, 1987.
- [5] M. Noroozian and G. Andersson, "Damping of inter-area and local modes by controllable components," *IEEE Trans. Power Delivery*, vol. 9, no. 4, pp. 2046–2054, Oct. 1994.
- [6] E. W. Kimbark, "Improvement of system stability by switched series capacitors," *IEEE Trans. Power Apparatus and Systems*, vol. PAS-85, pp. 180–188, Feb. 1966.
- [7] Å. Ölwegård *et al.*, "Improvement of transmission capacity by thyristor control reactive power," *IEEE Trans. Power Apparatus and Systems*, vol. PAS-100, no. 8, pp. 3933–3939, Aug. 1981.
- [8] L. Ångquist, B. Lundin, and J. Samuelsson, "Power oscillation damping using controlled reactive power compensation," *IEEE Trans. Power Systems*, pp. 687–700, May 1993.
- [9] E. Lerch, D. Povh, and L. Xu, "Advanced SVC control for damping power system oscillation," *IEEE Trans. Power Systems*, vol. 6, no. 2, pp. 524–535, May 1991.
- [10] A. E. Hammad, "Analysis of power system stability enhancement by static var compensators," *IEEE Trans. Power Systems*, vol. PWRS-1, no. 4, pp. 222–227, Nov. 1986.
- [11] G. N. Taranto, J. H. Chow, and H. A. Othman, "Robust design of power system damping controller," in *Proceedings of the 32nd Conference on Decision and Control*, San Antonio, TX, Dec. 1993.
- [12] L. Rouco and F. L. Pagola, "An eigenvalue sensitivity approach to location and controller design of controllable series capacitors for damping power system oscillations," *IEEE Trans. Power Systems*, vol. 12, no. 4, pp. 1660–1666, Nov. 1997.
- [13] T. Smed and G. Andersson, "Utilizing HVDC to damp power oscillations," *IEEE Trans. Power Delivery*, vol. 8, no. 2, pp. 620–627, Apr. 1993.
- [14] G. D. Galanos *et al.*, "Advanced static compensator for flexible AC transmission," *IEEE Trans. Power Systems*, vol. 8, no. 1, pp. 113–121, Feb. 1993.
- [15] J. F. Gronquist *et al.*, "Power oscillation damping control strategies for FACTS devices using locally measurable quantities," in *IEEE 1995 Winter Meeting*, Paper no. 95 WM 185-9 PWRS.
- [16] J. Machowski *et al.*, "Damping of power swings by optimal control of series compensators," in *Proceedings of 10th International Conference on Power System Automation and Control*, Bled, Slovenia, Oct. 1997.
- [17] M. Noroozian, L. Ångquist, M. Ghandhari, and G. Andersson, "Improving power system dynamics by series-connected FACTS devices," *IEEE Trans. Power Delivery*, vol. 12, no. 4, pp. 1635–1641, Oct. 1997.
- [18] IEEE Special Stability Controls Working Group, "Static var compensator models for power flow and dynamic performance simulation," *IEEE Trans. Power Systems*, vol. 8, no. 1, pp. 113–121, Feb. 1994.
- [19] M. A. Pai, *Energy Function Analysis for Power System Stability*. Boston: Kluwer Academic Publishers, 1989.
- [20] I. Hiskens and D. Hill, "Incorporation of SVCs into energy function methods," *IEEE Trans. Power Systems*, vol. 7, no. 1, pp. 133–140, Feb. 1992.
- [21] P. Kundur, *Power System Stability and Control*. New York: McGraw-Hill, 1993.

**Mojtaba Noroozian** received the B.Sc. degree in electrical engineering from Arya-Mehr (Sharif) University in Tehran, the M.Sc. degree in power systems from University of Manchester and the Ph.D. degree from Royal Institute of Technology, Sweden. He has been with ASEA (ABB) since 1984. He is now with ABB Power Systems AB, Reactive Power Compensation Division.

**Mehrdad Ghandhari** is a graduate student at the Royal Institute of Technology, Sweden. His interest is power system dynamics.

**Göran Andersson** received the M.Sc. and Ph.D. degrees from the University of Lund. In 1980, he joined ASEA. In 1986, he was appointed Professor in Electric Power Systems at the Royal Institute of Technology, Stockholm. He is a member of the Royal Swedish Academy of Engineering Sciences and the Royal Swedish Academy of Sciences.

**J. Gronquist** received the B.S. degree from the University of Colorado in 1990, and the M.S. and Ph.D. degrees from the University of Wisconsin in 1993 and 1997. He is presently employed with the Bios Group, LP, a scientific consulting firm in Santa Fe, NM, USA.

**I. Hiskens** received the B.Eng. (Elec) and B.App.Sc. (Math) degrees from the Capricornia Institute of Advanced Education, Rockhampton, Australia in 1980 and 1983, respectively, and the Ph.D. degree from the University of Newcastle, in 1990. He worked in the Queensland Electricity Supply Industry from 1980 to 1992. Dr. Hiskens is currently a Senior Lecturer in the Department of Electrical and Computer Engineering at the University of Newcastle.