

A techno-economic model for optimising component sizing and energy dispatch strategy for PV-diesel-battery hybrid power systems

Tawanda Hove

Department of Mechanical Engineering, University of Zimbabwe, Zimbabwe

Henerica Tazvinga

Department of Electrical, Electronic and Computer Engineering, University of Pretoria, South Africa

Abstract

This paper presents the development and application of a simple spreadsheet-based simulation model for sizing, energy performance evaluation and economic analysis of PV-diesel-battery power supply systems. The model is employed to generate a set of sizing curves that define the design space for hybrid systems using dimensionless generator component size variables, for a specified supply reliability and diesel energy dispatch strategy. The component size combination with the least unit cost of energy is selected among the many possible combinations satisfying a desired loss-of-load probability. Storage battery and diesel generator lifespan, as well as generator fuel efficiency, which depend on the operational loading stress of these components, are recognised as important variables in the economics of the system. The lifespan of the battery is premised to depend on the depth and rate of discharge of the operating cycles, while both the diesel generator lifespan and fuel efficiency are dependent on the degree and frequency of partial loading. The choice of diesel generator dispatch strategy was shown to be another important factor influencing the energy performance and economics of the system. The outputs of the model reveal several important sizing, operational and economic characteristics of the systems, and enables appraisal of comparative advantage of different types of designs and operational strategies. The merits of the hybrid concept are well demonstrated by the study results.

Keywords: PV-diesel hybrid systems; optimal sizing; loss of load fraction; energy cost; dispatch strategy

1. Introduction

Decentralised power generation systems based on renewable energy can play an important role in hastening the arrival of electricity to many households and commercial enterprises in the rural areas of Southern Africa. This is because decentralised systems can be more cost-effective than central grid extension for supplying power to distant, low-population-density, scattered settlements, characterising most rural areas (Karekezi and Ranja, 1997). Traditionally, diesel generators have been the favoured solution for decentralised electricity supply because of their low initial capital cost. However, besides environmental concerns, the diesel generator exhibits high operating costs, as a result of high consumption of fuel and high maintenance costs, (Donaldson, 2005). These operational problems result in a high overall end-use energy cost for diesel-only power systems.

Incorporating battery storage and a renewable energy source, to form a hybrid power supply system, can alleviate most of the problems mentioned for the diesel-only power system. When compared to mono-sourced energy systems, hybrid systems based on renewable energy sources have many advantages including increased reliability of power supply; mitigation of environmental damage; reduced generator component sizes; increased average diesel load factor and associated benefits; and possibly lower unit energy costs. A solar-photovoltaic-based (PV-diesel-battery system) is a sustainable choice of a hybrid system in many Southern African countries, since solar radiation is incidentally ubiquitous in abundant quantities in most of these countries.

In the design of a PV-diesel-battery hybrid system, the problem is to select a suitable size blending of generator components, PV array; diesel genera-

tor; and storage battery, and an appropriate dispatch strategy for the diesel generator, which will result in a least-cost system. This normally requires the use of sophisticated commercial computer simulation software, e.g. HYBRID2, Baring-Gould *et al.* (1996); RAPSIM, Jennings (1996); and others, which are ordinarily not affordable by system designers in developing countries. Recently, some authors (Suryoatmoyo *et al.* 2009, and Akyuz *et al.* 2009) described methods for the optimum design of Wind//PV-Diesel-Battery systems in which the optimisation is based on both energy cost and technical performance.

This paper reports about the development and application of a simple spreadsheet-based mathematical model for sizing, performance prediction and economic analysis of a PV-diesel-battery autonomous power supply system. It outlines how the model is used to determine the optimum-sized hybrid system to satisfy a given load profile at a desired power supply reliability, with energy cost as the objective function. It also investigates the effect and importance of diesel dispatch strategy on system performance and energy cost, in order to recommend the appropriate dispatch strategy. Compared to some previous models, the present model has added attributes of a wider scope of parameters (different diesel dispatch strategies and variable system reliability), and incorporation of battery and diesel generator lifespan models in the economic analysis.

2. PV-diesel-battery hybrid system and energy flow logic

Figure 1 shows a schematic of the PV-diesel-battery hybrid system to be analysed. The system comprises an AC load; power-generating components-solar PV array and diesel generator (DG); battery storage; power conditioning or regulation components- DC-AC inverter, solar controller, and battery charger. Electrical energy generated by the solar PV array and the diesel generator can either be consumed by the load, supplied to the battery, or wast-

ed (dumped energy), depending on the instantaneous magnitude of the load and state of charge of the storage battery. The operation of the system simulated for discrete hourly periods can be modelled as shown in Table 1 (overleaf).

In Table 1, d is the hourly-average energy demand [kWh/h]; Q_{DG} [kW], is the rated power output of the diesel generator; Q_{PV} is the hourly-average PV array output [kWh/h]; and η_{INV} is the DC-AC inverter efficiency. The load can take any value in the categories; $d < Q_{DG}$; $Q_{DG} \leq d \leq Q_{DG} + \eta_{INV}Q_{PV}$; or $d > Q_{DG} + \eta_{INV}Q_{PV}$, resulting in a different energy flow logic for each load category. If $d < Q_{DG}$, the DG can more than satisfy the load on its own; and the excess energy goes to charging the battery. The hourly DG energy accepted by the battery, B_{ch_DG} , is equal to whichever is the less of, the battery charge deficit (equal to the battery depth of discharge, DOD , multiplied by the battery capacity, B_{cap}), and the excess DG energy, $(Q_{DG} - d)$, multiplied by the battery charge efficiency, η_{ch} . The excess DG energy, over that supplied to the load and accepted by the battery, goes to waste (Q_{DG_dump}). In this load category, the available PV energy goes to charging the battery, provided that it is not already fully charged by previous charge events, with the excess PV energy also going to waste (Q_{PV_dump}).

If $Q_{DG} \leq d \leq Q_{DG} + \eta_{INV}Q_{PV}$, the load can be satisfied by the combined output of the DG and the PV array. All of the DG output is consumed by the load with the deficit, if any, supplied by the PV array through the inverter. The excess PV energy (over that supplied to the inverter) goes to the battery and/or to waste; the amounts going either way depend on the state of charge of the battery relative to the available excess energy.

Finally, if $d > Q_{DG} + \eta_{INV}Q_{PV}$, the combined output of the DG and the PV array is not enough to satisfy the load, hence there is no energy dumped. The energy deficit is met by the battery, which can discharge energy only when its depth of discharge is less than the maximum allowed - DOD_{max} . It is

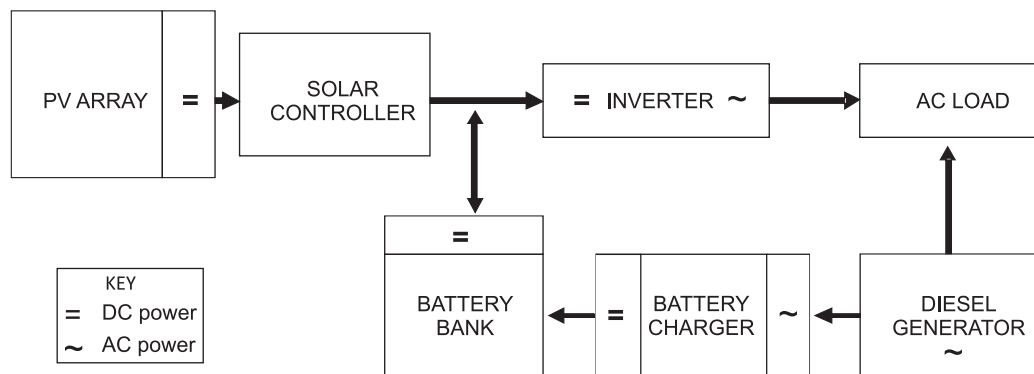

Figure 1: Schematic of a typical PV-diesel-battery hybrid power supply system

Table 1: Energy flow modelling of the PV-diesel-battery hybrid power system

Energy flow parameter	Parameter value for different loading conditions		
	$d < Q_{DG}$	$Q_{DG} \leq d \leq Q_{DG} + \eta_{INV} Q_{PV}$	$d > Q_{DG} + \eta_{INV} Q_{PV}$
Battery charge by DG, B_{ch_DG}	$MIN\left(\frac{\eta_{ch} * (Q_{DG} - d)}{DOD * B_{cap}}\right)$	0	0
Battery charge by PV, B_{ch_DG}	$MIN\left(\frac{\eta_{ch} * Q_{PV}}{DOD * B_{cap} - B_{ch_DG}}\right)$	$MIN\left(\frac{\eta_{ch} * \left(Q_{PV} + \frac{Q_{DG} - d}{\eta_{INV}}\right)}{DOD * B_{cap} - B_{ch_DG}}\right)$	0
Battery discharge, B_{disch}	0	0	$MIN\left(\frac{\left(d - Q_{DG} - \eta_{INV} Q_{PV}\right)}{\eta_{INV}}\right)$ $\left((DOD_{max} - DOD) * B_{cap}\right)$
Inverter delivery to load, Q_{INV_d}	0	$MIN\left(\eta_{INV} * Q_{PV}\right)$	$MIN\left(\eta_{INV} (B_{disch} + Q_{PV})\right)$ $(d - Q_{DG})$
DG delivery to load, Q_{DG_d}	d	Q_{DG}	Q_{DG}
PV energy dumped, Q_{PV_dump}	$Q_{PV} - \frac{B_{ch_PV}}{\eta_{ch}} - \frac{Q_{INV_d}}{\eta_{INV}}$	$Q_{PV} - \frac{B_{ch_PV}}{\eta_{ch}} - \frac{Q_{INV_d}}{\eta_{INV}}$	0
DG energy dumped, Q_{DG_dump}	$Q_{DG} - \frac{B_{ch_DG}}{\eta_{ch}} - Q_{DG_d}$	0	0
DG load factor, r_L	$\frac{(Q_{DG} - Q_{DG_dump})}{Q_{DG}}$	$\frac{(Q_{DG} - Q_{DG_dump})}{Q_{DG}}$	$\frac{(Q_{DG} - Q_{DG_dump})}{Q_{DG}}$
Satisfied load, d_{sat}	$Q_{INV_d} + Q_{DG_d}$	$Q_{INV_d} + Q_{DG_d}$	$Q_{INV_d} + Q_{DG_d}$

possible under this load category for the combined hourly output of the battery, PV array and DG to fall short of the hourly load. The system is defined to experience ‘loss of load’ under these circumstances. At this point, the system controller will intentionally disconnect the load from the battery, thereby avoiding a severe discharge that could damage the battery.

The hourly value of d depends on the energy demand profile for the particular application. A typ-

ical load profile for residential and some institutional applications in Zimbabwe, is the ‘double-hump’ variation shown in Figure 2.

3. Energy output of generator components

The models used for determining the diurnal variation of energy output for the two generating components of the hybrid system; PV array and diesel generator, are outlined in this section.

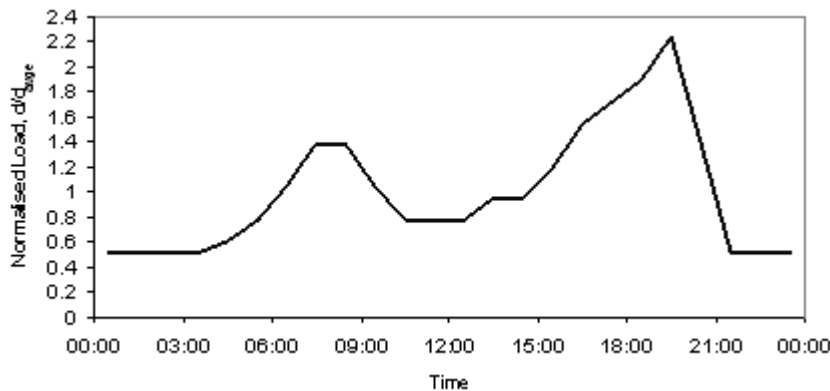

Figure 2: Load demand profile

3.1 PV array output

The PV array energy output varies with time of the day, season and weather conditions. It is given by the product of the solar radiation received on the plane of the array, I_{PV} [KWh/m²/h]; the PV solar-to-electrical efficiency, η_{PV} and the area of the array, A [m²], i.e.

$$Q_{PV} = \eta_{PV} I_{PV} A \quad (1)$$

In this study, the solar irradiation collected by the PV array, I_{PV} , for a given hour is calculated from measured or stochastically generated values of hourly global and diffuse irradiation using the simplified tilted-plane model of Collares-Pereira and Rabl, 1979, and assuming that the irradiation is concentrated at the middle of the hour. Figure 3 shows the distribution of I_{PV} calculated over all hours of the year 2005 for a Zimbabwean location, Harare (latitude 17.8°S). The I_{PV} values are calculated from measured meteorological records of hourly global and diffuse radiation. There are 8 760 dots in Figure 3, each representing the calculated value of I_{PV} for an hour of the year, with the vertical strings representing the distribution of collected irradiation for each hour of the day.

The PV electrical efficiency is a function of collected solar radiation, I_{PV} , and ambient temperature, T_a , and given by Hove, 2000.

$$\eta_{PV} = \eta_r \left[1 - 0.9 \frac{I_{PV}}{I_{PV,NOCT}} (T_{C,NOCT} - T_{a,NOCT}) - \beta (T_a - T_r) \right] \quad (2)$$

In Equation (2), η_r is the manufacturer-rated efficiency of the modules making up the PV array and T_r is the reference cell temperature at which η_r is measured; $T_{C,NOCT}$ and $T_{a,NOCT}$ are respectively the PV cell temperature and ambient temperature at nominal operating cell temperature (NOCT) condi-

tions (i.e. when $\eta_{PV}=0$, $I_{PV}= 800$ W/m², $T_a = 20^\circ\text{C}$ and wind speed = 1 m/s); and β is a temperature coefficient for cell efficiency, that is also provided by the PV manufacturer.

3.2 Diesel generator output

For any given hour, the DG output is either zero or the rated DG power, Q_{DG} , depending on whether the DG is switched off or on, respectively, for the hour in question. The conditions for switching on or off depend on the DG energy dispatch strategy adopted by the system designers and/or operators. In the present study, two different dispatch strategies are analysed.

1. The Night dispatch strategy assumes that the DG will be switched on only at night (when there is no solar radiation). This strategy allows a simple operation that can be done manually without the need for sophisticated electronic control, but might be wasteful for load profiles exhibiting low night energy usage. For this strategy, the DG hourly output is modelled as:

$$\begin{aligned} DG \text{ output} &= Q_{DG} \text{ if } \omega \geq \omega_s \\ &= 0 \text{ if } \omega < \omega_s \end{aligned} \quad (3)$$

where ω is the hour angle, and ω_s is the sunset hour angle.

2. In the load-following strategy the DG is switched on when the load equals or exceeds a certain prescribed threshold, d_{ON} . This strategy, depending on the correct choice of d_{ON} , may result in a more economical usage of DG energy, since it is dispatched only when really needed, and the DG is likely to operate at high load factors, resulting in low specific fuel consumption and longer DG lifespan. However, its implementation entails the use of electronic controls that may be costly to acquire and maintain, increase system sophistication, and hence

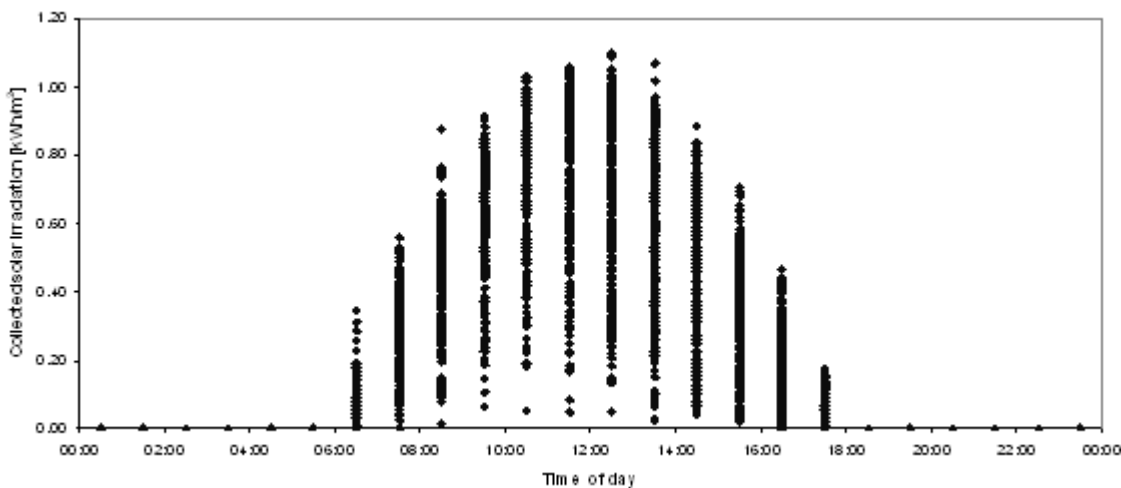

Figure 3: Hourly distribution of I_{PV} for Harare calculated from solar radiation data for the year 2005

less appropriate for the rural setting in most developing countries.

$$\begin{aligned} \text{DG output} &= Q_{DG} \text{ if } d \geq d_{ON} \\ &= Q_{DG} \text{ if } d < d_{ON} \end{aligned} \quad (4)$$

The switch-on load value, d_{ON} , can take any value prescribed by the system designer and/or operator, between zero and peak demand. For a varying load, the higher the prescribed value of d_{ON} , the lower is the DG runtime.

4. System sizing and optimisation

4.1 Objective function and constraints

For a given load and diurnal profile, the principal variables controlling the energy performance of the system are the PV array size; the DG rated power; the battery capacity; and the strategy employed for dispatching DG energy. A reasonable objective function used for the optimisation problem is minimising the unit cost of energy. The main constraint is that the chosen combination of component sizes should always be able to deliver enough energy to attain a certain prescribed degree of supply reliability. The degree of supply reliability is measured in this study by the loss of load fraction (LLF). The LLF is defined here as the fraction of annual hours when the power supply system fails to completely satisfy the load. A prescribed LLF can be attained by any of an infinite number of combinations of system-component sizes (PV array, battery and DG size) and DG dispatch strategies. The combination resulting in the least energy cost is the optimum system.

4.2 System sizing curves

The procedure used is to define the hybrid system design space by generating a family of system sizing curves that plot PV array size required to attain a prescribed LLF, against battery size, for different discrete values of DG size. To generalise the sizing curves for all magnitudes of daily loads with the same diurnal profile, the hybrid system component sizes are represented by dimensionless variables. The PV array size is characterised by the normalised variable A/A_o , where A is the actual installed PV array area [m^2] and A_o is a hypothetical area conceptualised by Hove (2000) as the PV array area required for satisfying a daily electrical load of D [kWh] if the array is operated at reference efficiency, η_r , and reference solar irradiance ($1 \text{ kW}/m^2$) constantly throughout the day. Hence,

$$A_o [m^2] = \frac{D}{24\eta_r} \quad (5)$$

The DG size is characterised by the normalised variable, Q_{DG}/\bar{d} , where \bar{d} is the daily average load,

equal to $D/24$; and the battery size is represented by the variable B_{cap}/D .

An Excel spreadsheet calculator, based on the logic of Table 1, was developed for computing, among other things, the LLF from inputs of the three dimensionless variables, A/A_o , B_{cap}/D and Q_{DG}/\bar{d} ; as well as inputs defining the diesel generator dispatch strategy. For a chosen dispatch strategy, each sizing curve is generated by fixing the DG size, Q_{DG}/\bar{d} ; and the combinations of B_{cap}/D and A/A_o that just yield the prescribed LLF are the required coordinates of the sizing curve. The DG size is then varied in discrete increments say from $Q_{DG} = 1.0\bar{d}$ (average daily power) to $Q_{DG} = \text{peak load power}$, to generate the complete family of sizing curves.

Examples of sizing curves generated this way, using meteorological data for Harare and load profile of Figure 2, are shown in Figures 4 and 5, for different dispatch strategies and level of supply reliability (LLF). The following can be observed from the sizing curves. The PV array area required to achieve a chosen level of reliability (LLF) decreases with increase in the battery size (along each sizing curve), and with increase in DG size (among different sizing curves). Greater supply reliability (decreased LLF) of course calls for larger sizes of the hybrid system components and a correspondingly larger system cost. The prescribed system component size combinations differ from one DG dispatch strategy to the other.

Once constructed, the sizing curve can be used as a design tool for the system. First, they can be used to determine all possible combinations of component size variables A/A_o , B_{cap}/D and Q_{DG}/\bar{d} , that satisfies a given load and diurnal profile to a desired degree of reliability. The compliant size combinations can then be subjected to optimisation scrutiny to select the optimum combination. Second, given any two of the size variables, one can fix the third variable. For example, suppose that an existing DG-battery system, with $B_{cap}/D = 1.0$ and $Q_{DG}/\bar{d} = 1.8$, and supplying a load of 42 kWh/day, is to be upgraded to a PV-diesel-battery system in order to reduce fuel costs. The required PV array can be easily determined from the sizing curves. Assuming that a load-following strategy is adopted and that a 100% supply reliability is desired, A/A_o can be read from Figure 5 (b), i.e. $A/A_o = 3.4$. The reader can confirm that the required array area, calculated via Equation (5) and assuming 14% PV efficiency, is 42.5 m^2 .

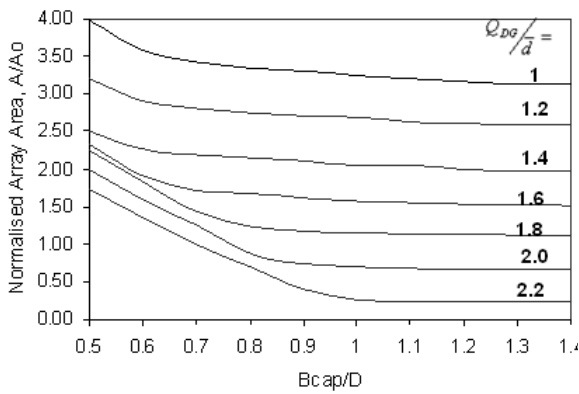

Figure 4 (a): Sizing curves for a PV-diesel-battery hybrid system on night dispatch strategy, for LLF = 1%

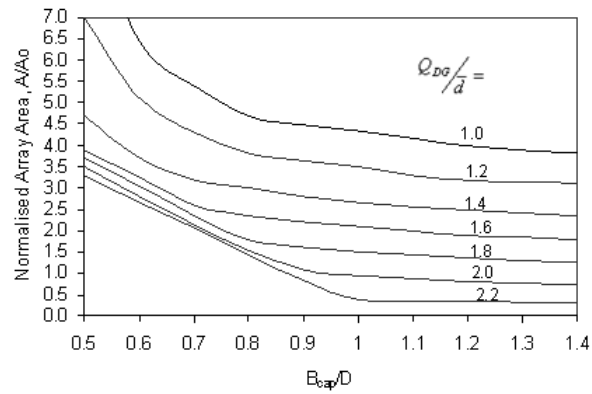

Figure 4 (b): Same as 4(a) but for LLF = 0%

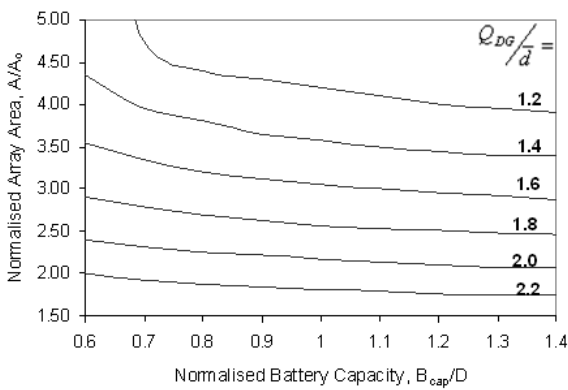

Figure 5 (a): Sizing curves for system on load-following dispatch strategy, dON = 1.1d, for LLF = 1%

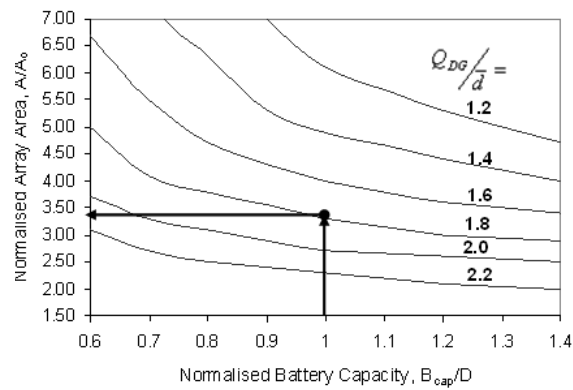

Figure 5 (b): Same as 5(a) but for LLF = 0%

5. Economic cost model

The costs incurred during the life (based on economic life of the PV array) of the hybrid system can be categorised into initial costs; operation and maintenance costs; and replacement costs. Initial costs (I_o) include the cost of purchasing and installing system components, PV array; battery bank; diesel generator; inverter; solar controller; battery charger; etc., at the onset of the project. Operating and maintenance costs (OMC) include the cost of fuel to run the DG as well as the cost of maintaining the DG, PV array, battery and all the other system components. Replacement costs (RC) are incurred in replacing all those system components whose lifespan is shorter than that of the PV array.

The net present cost (NPC) of each component is calculated as the sum of lifecycle discounted costs (less residual value in the case of replaced components) according to the formula:

$$NPC = I_o + \sum_{n=1}^{N_{PV}} \frac{OMC}{(1+r)^n} + \sum_{m=1}^M \frac{RC}{(1+r)^{mt_R}} - \frac{(M+1)t_R - N_{PV}}{t_R} \frac{RC}{(1+r)^{N_{PV}}} \quad (6)$$

In Equation (6), r is the discount rate, N_{PV} is the economic lifespan of the PV array (assumed to be the component with the longest lifespan) and t_R is the economic life of a component that needs to be replaced during the life of the project. M is the number of times the component has to be replaced during the life of the project. It is given by the integer component of the quotient N_{PV}/t_R .

$$M = INT \left(\frac{N_{PV}}{t_R} \right) \quad (7)$$

The last term on the right hand side of Equation (6) is the residual value of the replaced component. For the PV array, $t_R = N_{PV}$ and $M = 1$, so that the last two terms on the right hand side of the equation disappear.

The annualised cost (AC) of the hybrid system is obtained by multiplying the NPC by the capital recovery factor (CRF); and the unit energy cost, C_E , is the annualised cost divided by the annual energy delivered to the load, E_A . That is,

$$AC = NPC \times CRF \quad (8)$$

and,

$$C_E = \frac{AC}{E_A} \quad (9)$$

The capital recovery factor is given by:

$$CRF = \frac{r}{1 - (1 + r)^{-N_{PV}}} \quad (10)$$

The unit energy cost, C_E , is used as the yardstick to compare the economic merits of differently sized hybrid systems. Hence, the optimum hybrid system should satisfy the energy performance criterion set by the system sizing curves of the previous section, as well as have the minimum C_E among its peers.

6. Economic parameters

Table 2 lists the economic parameters used in this study for evaluating the economic model described in the previous section. The parameters battery life, DG life and DG fuel consumption, indicated in Table 2 as 'model calculated' will need special explanation given in the following sub-sections.

Table 2: Economic parameters

Economic parameter	Value
Discounting and lifespan parameters	
Discount rate	5%
PV array life, N_{PV} [years]	20
Battery life[years]	model-calculated
DG life[years]	model-calculated
Inverter life [years]	10
Solar controller life [years]	10
Battery charger life [years]	10
Capital cost parameters	
PV array cost [\$/m ²]	840
Battery cost [\$/kWh]	220
Inverter cost [\$/kW]	750
Diesel genset cost [\$/kW]	550
Solar controller cost [% of PV capital cost]	5%
Battery charger [% of Battery capital cost]	10%
O&M cost parameters	
DG fuel consumption[litres p/a]	model-calculated
Fuel cost [\$/litre]	1.00
DG regular service cost [% DG capital cost]	5%
DG overhaul cost [% DG capital cost]	70%
PV array maintenance [% of capital cost]	0.5%
Inverter maintenance [% of capital cost]	5%
Battery maintenance [% of capital cost]	10%
Solar controller maintenance [% of capital cost]	5%
Battery charger maintenance [% of capital cost]	5%

6.1 Diesel generator fuel consumption model

Fuel consumption data as well as recommended maintenance schedules for diesel generators operating at full load, are usually provided manufacturers. However, during the operation of the hybrid system, the diesel generator frequently operates at less than full load. It is already well known that when the diesel engine is operated for long periods at a partial load, a condition known as 'wet-stacking' occurs (Donaldson, 2005). This is mainly attributed to incomplete combustion of fuel when the engine runs at low operating temperature. This results in reduced fuel efficiency and, simultaneously, shortening of engine operating life, and the time interval between routine maintenance calls. These effects have important implications on the operation, maintenance and replacement costs of the DG, and should be accounted for in the economic model.

The present model calculates the specific fuel consumption, SFC , for the diesel generator operating at any load ratio, r_L , relative to the specific fuel consumption at 100% load, $SFC_{100\%}$, using an expression of the following form:

$$\frac{SFC}{SFC_{100\%}} = \exp\left(a_4 r_L^4 + a_3 r_L^3 + a_2 r_L^2 + a_1 r_L + a_0\right) \quad (11)$$

The coefficients a_0 to a_4 in Equation (11) were obtained by curve-fitting data read from a chart found in the RETScreen® Software Online User Manual, RetScreen International, 2005. The values of these coefficients, together with full-load specific fuel consumption, for different DG power ranges, are given in Table 3. The fuel consumption for each hour of operation of the DG is then the product of r_L , SFC and the rated DG output.

6.2 DG maintenance and replacement model

To account for the effect of partial loading on DG life and the time interval between maintenance calls, the concept of DG effective running time (ERT) is introduced. The ERT is supposed to provide a measure of the engine life actually expended when the engine runs at a load ratio, r_L in a given time interval. If the engine runs for t clock hours at full load ($r_L = 1$), then ERT would be exactly t hours. However, if the engine runs for t clock hours at partial load, the engine would be expected to have aged by more than t hours. An adjustment should be made to the running time to account for the fact that the engine is now aging at a faster rate due wet-stacking. It is presumed that a simple relationship exists between, relative engine aging/deterioration due to wet-stacking and relative specific fuel efficiency; since both are related to poor combustion of the fuel when the engine is operating at

Table 3: Diesel generator specific fuel consumption parameters

DG power range	$SFC_{100\%}$ [litre/kWh]	a_0	a_1	a_2	a_3	a_4
3 to 12 kW	0.39	2.7722	-11.952	22.006	-19.232	6.4053
15 to 30 kW	0.36	2.5912	-13.983	30.979	-31.081	11.493
35 to 100 kW	0.33	2.5613	-15.581	36.452	-37.320	13.887

less than optimum temperature under partial loading.

The effective running time for an engine operated for one clock hour is then given simply by:

$$ERT(r_L) = \frac{SFC(r_L)}{SFC_{100\%}} \quad (12)$$

The annual cumulative engine effective running time, ERT_a [hours] is obtained by summing the hourly ERT values over all clock hours of the year when the engine is running. That is:

$$ERT_a = \sum_{i=1}^{i=8760} \left(\frac{SFC(r_L)}{SFC_{100\%}} \right)_i \quad (13)$$

where $SFC(r_L)$ is obtained from Equation (11) and is equal to 0 when the DG is not running.

The time interval in years required before a scheduled maintenance call on the DG, or before its replacement, is then obtained by dividing manufacturer's recommended values for DG running hours before maintenance activity by ERT_a . Table 4 is an example of manufacturer's recommended schedule for DG maintenance and replacement.

Table 4: Typical diesel generator maintenance schedule

Maintenance activity	DG running hours before call
Regular service	500
Overhaul	6000
Replacement	12000

6.3 Battery life model

The battery life prediction model used in this paper is similar to the one described by Drouilhet and Johnson (1997). They assume that, among all other factors that affect battery health and life, the depth of discharge and rate of discharge are primary. The battery cell is assumed to have a finite life (charge life) as measured by the sum of the effective ampere-hours throughput during its useful life. The battery's rated charge life, f_R , is defined as:

$$\phi_R = L_R DOD_R C_R \quad (14)$$

where C_R is the rated amp-hour capacity at rated

discharge current I_R , DOD_R is the depth of discharge for which rated cycle life was determined, and L_R is the battery cycle life at rated depth of discharge DOD_R and discharge current I_R .

However, under actual operation, the battery is often discharged to varying depths and at varying discharge rates, different from the rated values, resulting in an increased or decreased charge life. This fact is accounted for by adjusting the battery charge life expended on each discharge event during the battery operating life with respect to the actual periodic discharge depth and rate. The effective ampere-hour discharge, d_{eff} , in a given discharge event is obtained by multiplying the actual observed or modelled discharge, d_{actual} , by two modifiers representing, respectively, the effects of modified DOD and rate of discharge.

$$d_{eff} = d_{actual} * f_{DOD} * f_I \quad (15)$$

The modifier f_{DOD} accounts for the effect of depth-of-discharge on battery charge life expended, and is obtained from a best-fit curve of manufacturer's cycle life versus depth of discharge data. The modifier f_I accounts for the effect of rate of discharge on the battery charge life expended for each discharge event, and is obtained from a best-fit curve of actual ampere-hour capacity versus actual discharge current, with data inferred from manufacturer's Amperes-on-Discharge data. For instance, for a Trojan® T105 lead acid battery, analysed in this study, the following curve-fitting expressions were obtained:

$$f_{DOD} = 0.7742 \frac{DOD_A}{DOD_R} + 0.2864 \quad (16)$$

and,

$$f_I = 0.9644 \left(\frac{I_A}{I_R} \right)^{0.1883} \quad (17)$$

In Equations (16) and (17), DOD_A and I_A are, respectively the actual depth of discharge and rate of discharge (current) during a given discharge event.

When the cumulative total of the individual effective discharges corresponding to a series of discharge events equals the rated charge life of the cell (Equation (14)), the battery will have reached its useful life. However, in practice the battery may

require decommissioning well before its charge life is finished because of physical deterioration caused by aging effects such as corrosion of plates or contamination of electrolyte. So, in this paper the battery life used in the economic analysis is calculated by the model described above, but limited to 10 years, representing the warranty life given by some manufacturers.

7. Results and discussion

The model was used to compute the energy performance and cost of systems with different combinations of component sizes, for two different DG dispatch strategies (Load-following and Night dispatch strategies). The model also has scope to evaluate autonomous power supply systems falling outside the domain of strictly 'PV-diesel-battery', such as diesel-only, diesel-battery-inverter and PV-battery-inverter systems. These systems can be treated by the model as PV-diesel-battery systems with some missing components, and are included in the results presentation to allow a broader comparative perspective.

Table 5 shows the model-deduced sizes of system components and performance parameters of different types of optimised power systems with an LLF of 0%. Figure 6 is a pictorial comparison of the contributions to total energy cost of PV array costs (initial and maintenance PV costs); battery costs (initial, maintenance and replacement); DG costs (initial, maintenance and replacement); fuel cost; and life-cycle costs for the remainder of the system components, called balance of system (BOS) components.

The presentation in Table 5 allows an appraisal of the relative merits of the different types of systems. The types of systems considered in Table 5 are:

- i) Diesel-only system, ($A/A_o = 0$; $B_{cap}/D = 0$).
- ii) A system comprising a DG, battery storage and an inverter (DG/battery/inverter), ($A/A_o = 0$).
- iii) A hybrid power system, comprising a DG, PV array, battery and inverter, and operated on the Night energy dispatch strategy (PV/DG/battery/inverter Night dispatch).
- iv) A system with similar components as in (iii), but operated on the Load-following DG dispatch strategy (PV/DG/battery/inverter Load-following dispatch).
- v) A solar-powered system comprising a PV array, battery storage and an inverter ($Q_{DG}/\bar{d} = 0$).

The hybrid PV/DG/battery/inverter systems, iii and iv, cost significantly less than either diesel or solar energised systems. This is mainly because these systems have lower DG runtime and higher load ratios (resulting in lower average specific fuel consumption and DG maintenance) when compared to entirely diesel-driven systems. They can be designed with smaller battery and PV array size than can the entirely solar-driven system. The diesel-only system is the worst economic performer as a result of its high fuel and DG maintenance and replacement cost. This is due to a very low load factor and the necessity for continuous running of the DG. Incorporating battery storage (DG/battery/inverter) greatly improves economic performance of the diesel-based system to an extent that it

Table 5: Component sizes, performance characteristics and economics of optimised systems

System characteristic	Diesel-only inverter	DG/battery/inverter	PV/DG/battery/inverter Night dispatch	PV/DG/battery/Load-following dispatch	PV/battery/inverter
Normalised PV array, A/A_o	–	–	3.8	3.3	7.2
Battery capacity, B_{cap}/D	–	0.50	0.8	1.0	2.9
Genset rated power, Q_D/\bar{d}	2.24	1.2	1.2	1.8	–
Loss of load fraction	0	0	0	0	0
Genset dispatch strategy	24 hr/day	$d_{ON} = 0$	At night only	$d_{ON} = 1.1\bar{d}$	–
Solar fraction	–	–	45.1%	44.4%	100%
Diesel fraction	100%	100%	54.9%	55.6%	–
Average specific fuel consumption [l/kWh]	0.59	0.43	0.24	0.23	0.00
PV dumped energy	–	–	36.7%	22.6%	44.5%
Genset dumped energy	124%	16.0%	2.0%	2.9%	–
Average DG load factor	0.45	0.87	0.97	0.95	–
Nominal genset run time [hours/yr]	8760	8760	4539	2920	–
Effective genset run time [hours/yr]	16137	9731	4773	3075	–
Battery life [years]	–	7.83	6.99	6.84	10.0
Energy cost [\$/kWh]	1.051	0.787	0.768	0.757	0.932

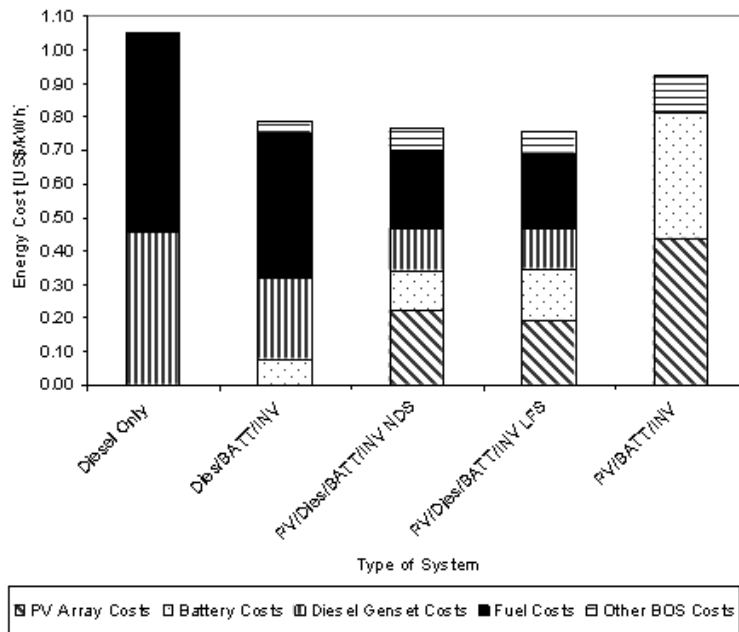

Figure 6: Comparison of total and disaggregated unit energy cost for different systems

becomes more viable than the entirely solar-driven system.

The importance of DG energy dispatch strategy in influencing optimal-system component sizing and operational parameters is well illustrated by the system information in Table 1. For instance, it can be observed that, compared with its Load-following counterpart, the hybrid system employing a Night DG dispatch strategy required smaller battery and DG components; can achieve a higher solar fraction, operates with a higher DG load factor; and resulted in a slightly longer battery life. However, on a negative note, this dispatch strategy required a larger PV array; had a higher average specific fuel consumption; dumped more PV energy; and operated with longer DG runtime. Comparing the economics of the two hybrid PV-diesel systems, the Load-following DG energy dispatch strategy shows slight superiority (about 2% less energy cost) over the Night dispatch strategy, for the load profile considered. This slight economic advantage of the Load-following strategy over the Night dispatch strategy may, however, not be enough to justify the greater control-system sophistication that comes with the former strategy.

8. Summary and conclusion

The paper described the elements and application of a techno-economic model for the optimal design and performance analysis of hybrid power supply systems based on solar and/or diesel energy, with or without battery storage. The model can simulate the time-series energy flow in a hybrid system of any selected combination of system component sizes, and mode of operation as characterised by the strategy of dispatching diesel energy.

Five system types with solar fraction ranging from zero (diesel-only) to 100% (solar-only), with or without battery storage, were analysed using the study model and had their relative merits compared. The merits of the hybrid concept are well demonstrated by the study results. The energy cost for hybrid systems was significantly less than that for systems driven solely by solar, on the one extreme, or by diesel energy, on the other. Diesel energy dispatch strategy is an important consideration in determining the component sizes and operational as well as economic characteristics of the hybrid system. A validation for the present model is planned and will be the subject of a follow-up paper.

References

- Akyuz, E., Oktay, Z. And Dincer, I. (2009). The techno-economic and environmental aspects of a hybrid PV-diesel-battery power system for remote farm houses. *Int. J. Global Warming*, 1(1/2/3), pp.392–404.
- Ashok D.S. (2007). Optimised model for community-based hybrid energy system. *Renewable Energy*, 32 pp. 1155–1164.
- Baring-Gould, E.I. Green, H.J. van Dijk, V.A.P. and Manwell, J.F. (1996). Hybrid2- The Hybrid Power System Simulation Model. *Proc. AWEA Wind Power*, 96, pp 497–506.
- Collares-Pereira, M. and Rabl, A. (1979). Derivation of method for predicting long term average energy delivery of non-concentrating and concentrating solar collectors. *Solar Energy*, 22 (2), pp. 155-170.
- Donaldson, A.B., (2005). Wet-stacking avoidance in internal combustion engines [online]. US patent 6848419. Available from: www.patentstorm.us/

- patents/6848419-description.html (Accessed 10/12/07).
- Drouilhet, S. Johnson, B. L. (1997). Battery life prediction method for hybrid power applications [online]. National Renewable Energy Laboratory, NREL Report No. 23281. Available from: www.nrelpubs.nrel.gov (Accessed 22 / 11/ 07).
- Hove, T, (2000). A method for predicting long-term average performance of photovoltaic systems. *Renewable Energy*, 21(4), pp. 207-229.
- Jennings, S.U. (1996). Development and Application of a Computerised Design Tool for Remote Area Power Supply Systems. PhD Thesis, Murdoch University.
- Karekezi, S. and Ranja, T. (1997). *Renewable energy technologies in Africa*. London: Zed Books in association with African Energy Policy Research Network and Swedish Environment Institute.
- RETScreen International, (2005). *RETScreen® Softwareonlineuser manual, Photovoltaic project model* [online]. Natural Resources Canada. Available from: www.retscreen.net (Accessed 2/12/ 07).
- Suryoatmoyo H., Hiyama T. and Ashari M. (2009). Optimum Design of Wind-PV-Diesel-Battery System using Generic Algorithm. *IEEJ Transactions on Power and Energy*, 129 (3), pp. 413-420.

Received 17 December 2010; revised 26 July 2012