

A Virtual-Reality-Based Telerehabilitation System with Force Feedback

Viorel G. Popescu, *Student Member, IEEE*, Grigore C. Burdea, *Senior Member, IEEE*, Mourad Bouzit, *Member, IEEE*, and Vincent R. Hentz

Abstract—A PC-based orthopedic rehabilitation system was developed for use at home, while allowing remote monitoring from the clinic. The home rehabilitation station has a Pentium II PC with graphics accelerator, a Polhemus tracker, and a multipurpose haptic control interface. This novel interface is used to sample a patient's hand positions and to provide resistive forces using the Rutgers Master II (RMII) glove. A library of virtual rehabilitation routines was developed using WorldToolKit software. At the present time, it consists of three physical therapy exercises (DigiKey, ball, and power putty) and two functional rehabilitation exercises (peg board and ball game). These virtual reality exercises allow automatic and transparent patient data collection into an Oracle database. A remote Pentium II PC is connected with the home-based PC over the Internet and an additional video conferencing connection. The remote computer is running an Oracle server to maintain the patient database, monitor progress, and change the exercise level of difficulty. This allows for patient progress monitoring and repeat evaluations over time. The telerehabilitation system is in clinical trials at Stanford Medical School (CA), with progress being monitored from Rutgers University (NJ). Other haptic interfaces currently under development include devices for elbow and knee rehabilitation connected to the same system.

Index Terms—Client-server system, haptic feedback, orthopedic rehabilitation, telerehabilitation, virtual reality.

I. INTRODUCTION

THE RESEARCH planning report of the National Center for Medical Rehabilitation Research indicates that in 1993 there were approximately 40 million disabled Americans [14]. This staggering number includes people with restricted mobility, with reduced sensorial capacity, or with communication and intellectual deficits. The aging of the American population, coupled with the negative impact age has on disabilities (including recurrence of previously controlled conditions) has increased the number of disabled in recent years. Societal cost has similarly increased to \$300 billion, according to a report of the Institute of Medicine [2]. The above cost does not account for the psychological impact on the disabled, their family, and the environment. While the number of patients needing rehabilitation (including long-term therapy) has increased, the

resources available to them have unfortunately diminished, in part due to restrictions in managed healthcare agreements.

The reduction in the covered duration of therapy thus has a negative impact on the patient's condition and on the recovery process. The duration of the rehabilitation therapy is important, as is timeliness of treatment. Indeed, assessment and therapy have to occur early on, or else the same therapy duration will have diminished results. Timeliness and duration of rehabilitative therapy are problematic for those in remote rural locations or living in depressed urban areas. In such instances, generally there are no clinics in the vicinity of the patient's home. Avoiding travel to the clinic altogether would mean that adequate therapeutic intervention can be done at home, after an initial assessment at the clinic. However, therapists may not be able to travel to the patient's remote home or may be unwilling to do so.

The leading cause of activity limitations for Americans is orthopedic impairments. Such patients typically follow a regimen of combined clinic and home rehabilitation exercises. Home exercises are done on simple mechanical systems that are loaned to the patient or constructed for them. Since these mechanical devices are not networked, there is no way a therapist can either monitor a patient's progress or change exercise difficulty levels remotely. There is also no way to verify that the patient has actually done the prescribed home rehabilitation exercises. Therefore, there is a need for a home telerehabilitation system that will record data from a patient's rehabilitation routines and will allow the therapist to remotely monitor the patient's progress.

Historically, computer-based biomechanical evaluation tools were first used for monitoring the rehabilitation process. Greenleaf Medical developed "Eval" and "Orca" systems for orthopedic evaluation [9], [8]. The systems offer easy data collection and storage and tools for analyzing the patient information stored in the database. Other companies (Lafayette Instrument Company¹ and Electronic Healthcare Systems Inc.²) are offering software for patient monitoring and evaluation. Data is stored in custom databases and patient reports can be displayed. The systems described above were designed to be used in the clinic so that they do not include either a networking or a rehabilitation component. No forces are applied to the patient by these devices.

Prototype systems that do provide forces for manual therapy have been developed by Hogan at MIT [10], Luecke at Iowa State University [12], Takeda and Tsutsul at Nagasaki Institute Applied Science [24], and, more recently, Rovetta at the Milano Politechnic Institute [22]. All of these prototypes have certain advantages versus the clinical practice. For example, the MIT

Manuscript received July 7, 1999; revised September 8, 1999. This work was supported by the National Science Foundation under Grant BES-9708020 and by Rutgers University (CAIP Center Grant, and Special Research Opportunity Award).

V. G. Popescu, G. C. Burdea, and M. Bouzit are with the CAIP Center, Rutgers University, Piscataway, NJ 08854 USA.

V. R. Hentz is with the Division of Hand Surgery, Department of Functional Restoration, Stanford Medical School, Stanford, CA 94304 USA.

Publisher Item Identifier S 1089-7771(00)02131-2.

¹[Online]. Available: <http://www.licmef.com/assessme1.htm>

²[Online]. Available: <http://dm3host.com/websites2/ehs/charttrad.html>

system showed faster upper limb motor rehabilitation for stroke patients who exercised with a robot. The Iowa State system allowed independent force control for each finger, while the Nagasaki system was extremely light and powerful through the use of pneumatic “muscle” actuators. The Milano Politechnic system is portable (uses a laptop) and is intended for patients that need neuromotor rehabilitation (such as those with Parkinson’s disease). However, all the systems cited above also have drawbacks, due mainly to their complexity (for example, the use of robot manipulators), making them difficult for use at home. In the case of the Milano Politechnic system, forces to only one finger are measured, and only one virtual finger is shown. Furthermore, there is no networking component in either of these systems, so that at-home monitored rehabilitation is not possible.

A virtual-reality(VR)-based system for hand rehabilitation was also developed by Burdea and colleagues [5], [6]. The system differs from the other prototypes mentioned above as it includes a diagnosis module (with standard diagnosis instruments), a rehabilitation module using VR simulations, and the Rutgers Master I haptic glove [3]. Proof of concept trials done with a small group of patients were promising, especially in regard to the subjective evaluation of the system by the patients. Problems remained due to the DataGlove technology used at the time for hand readings, as well as the slow graphics workstation used (Sun 10-Zx). This system, like the ones before, was not networked, as it was intended for clinic rather than at-home use.

An example of a system for computer-based patient monitoring and remote evaluation is the “electric house call” (EHC) [18] developed by researchers at the Georgia Institute of Technology in collaboration with the Medical College of Georgia and the Eisenhower Army Medical Center. Six at-home patient measurements were demonstrated, with data stored at the clinic using a client/server database architecture. In the area of home rehabilitation, Ward and Bullinger recently patented a system where a remote clinician can monitor and set the range of motion of body joints through a “dual-plane joint monitor” [26]. There is no VR component to their proposed system and no forces are measured or applied by the patented apparatus.

This paper describes another client/server telemedicine application in orthopedic rehabilitation. This telerehabilitation system contains a PC workstation, a novel multipurpose haptic control interface, the Rutgers Master II (RMII) force feedback glove, a microphone array for hands-free voice input, and videoconferencing hardware. The system is in clinical trials at Stanford Medical School (client site), with rehabilitation progress being monitored from Rutgers University (server site). Section II describes the telerehabilitation system hardware. Section III presents the VR rehabilitation library of exercises. The deformation and haptic rendering models are detailed in Section IV. Section V describes the patient database, the client/server architecture, and the network system setup. Concluding remarks are given in Section VI.

II. TELEREHABILITATION SYSTEM HARDWARE

The prototype of the home orthopedic rehabilitation system is shown in Fig. 1(a) [20]. It consists of a Powerdigm Pentium II PC equipped with an InsideTrack 3-D tracker [19], a FireGL



(a)

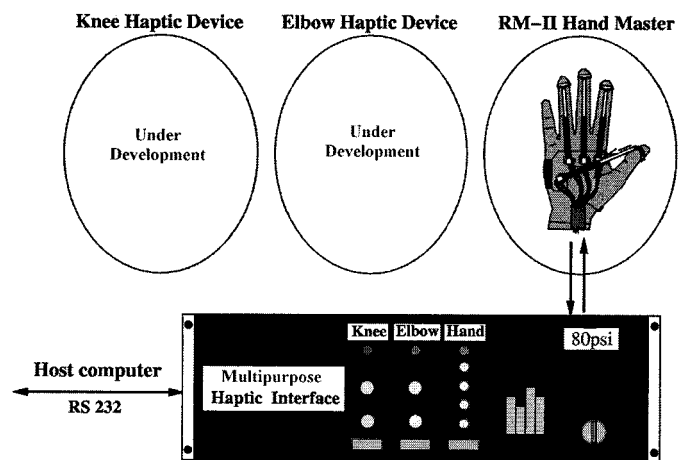

(b)

Fig. 1. Telerehabilitation workstation. (a) Experimental prototype. (b) The RMII connected to the MHCI [20].

4000 graphics accelerator, a custom microphone array, and a net camera. The Pentium PC is connected to a novel multipurpose haptic control interface (MHCI) which can drive several rehabilitation haptic interfaces (for the hand, elbow, and knee). The MHCI is a redesigned version of the RM-II Smart Controller Interface, with a new haptic control loop, an upgraded imbedded PC, and multiplexing capabilities. It can switch between the hand, elbow, and knee haptic devices seamlessly, as required by the VR exercise routine to be executed. The system is self-configurable, depending on the patient’s needs, without any hardware changes (connect, disconnect, etc.).

Currently the system is used with the RM-II haptic glove while the elbow and knee units are under development. As shown in Fig. 1(b), the RM-II glove is an exoskeletal structure that provides forces at the patient’s fingertips and contains its own noncontact position sensors [7]. Thus, the system is simplified (no need for a separate sensing glove) and light (about 100 g). The feedback actuators have glass/graphite structures with very low static friction. The combination of high, sustained feedback forces (16 N at each fingertip) and low friction provides high dynamic range (300). This makes the RM-II capable of high sensitivity and resolution in the feedback forces it can produce. The pistons have protective metallic

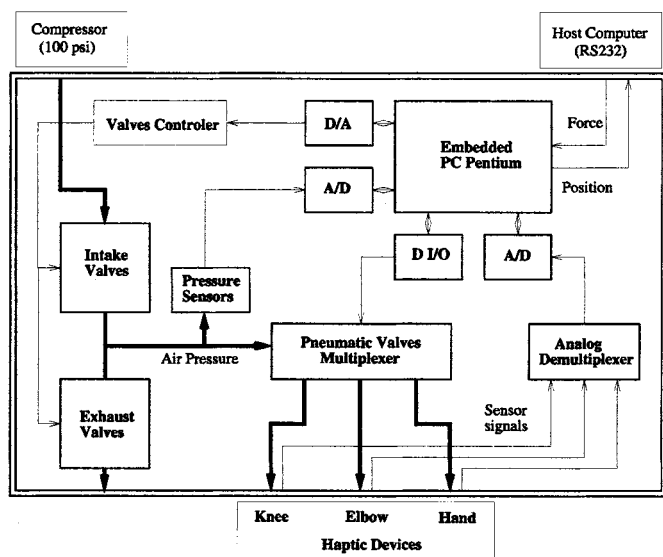

Fig. 2. The multipurpose haptic control interface.

caps at the top to prevent overextending patients' fingers. The patient-RM-II device interaction benefits from air compliance which augments patient's safety. Additional safety features are included in the software exercises, allowing patients to shut off the system in case of emergency. The InsideTrak measures the patient's wrist position 60 times/s, while the RM-II provides 187 finger position updates/s.

The internal view of the prototype multipurpose haptic control interface is shown in Fig. 2. It consists of high-bandwidth pneumatic valves, a pneumatic multiplexer, an embedded Pentium board, several other electronic boards, and a power supply. The pneumatic valves were carefully selected for their response time and air flow in order to maximize the haptic device bandwidth. The solenoid valves operate at a frequency of 500 Hz with a flow of 200 NI/min and an opening (or closing) response time of less than 2 ms. The MHCI pressure regulator was built with two of these fast valves, one each for exhaust and intake. The embedded Pentium (100 MHz) controls the valves using pulsewidth modulation (PWM) based on feedback from pressure sensors installed on the valve output pipes. Experimental results showed that the resulting closed-loop control assures a precise and stable output pressure control with a mechanical feedback bandwidth of 10–20 Hz [17]. This is approximately four times larger than the corresponding bandwidth of the off-the-shelf Buzmatics controller used in the previous RM-II electronics interfaces. Additionally, the real-time software running on the embedded Pentium reads and filters data from the RM-II sensors through an analog demultiplexer and A/D board and transforms it into the patient's joint angles. The transformation needs user calibration data transferred during the initial calibration stage of the rehabilitation routines.

The communication between the MHCI and the host is through a standard RS232 serial port, which brings total hardware independence (the system was tested on a SGI Infinite Reality, on a Sun Ultra 60, and on several Pentium PC's). Data sent to the host contain joint angles, measured forces, or device state, while received data from the host include commands or forces to be displayed to the patient. At a rate of 57 500 bit/s,

the RS232 line can transmit up to 187 RM-II position data sets/s or 166 data sets that contain both position and finger force readings every second.

A microphone array [11] provides hands-free voice input by focusing on the patient's head sitting approximately 3 ft in front of the monitor. Additionally, a net color camera connected to the PC parallel port is used for teleconferencing with the clinic. It can provide up to 15 fps QCIF images when running on a local machine.

III. THE VIRTUAL REALITY EXERCISE LIBRARY

The high-level software used by the telerehabilitation system has three components: the VR exercises routines, the database of patients' files, and the networking component. The rehabilitation exercises were developed using the commercial World-ToolKit graphics library [23], with a simple virtual environment in order to keep the patient focused. All exercises contain a high-resolution virtual hand from Viewpoint DataLabs [25] and several objects (DigiKey, peg board, rubber ball, power putty) created with AutoCAD [1] or WTK Modeler.

Several hand gestures allow patients to interact with the virtual objects: whole-hand grasping, two-finger grasping (lateral pinch), selecting (pointing), and releasing. Contact detection between hand segments and the objects triggers a grasping gesture. Objects stay "attached" to the virtual hand until a release gesture is executed by the patient. The "select" gesture is executed with the index finger touching a virtual object. This gesture is used only at the beginning of each exercise to interactively set the rehabilitation routine level of difficulty and object stiffness.

The rehabilitation routines are broadly classified into two categories: physical therapy (PT) and functional rehabilitation. PT exercises use force feedback to improve the patient's motor skills (exercise muscles and joints). Functional rehabilitation is done to regain lost skills (such as those needed in activities of daily living or job-related skills). Functional rehabilitation exercises, therefore, have much greater diversity and their output depends on each exercise design. The essential feature of these exercises is the patient's interactivity with the VE. Each therapy exercise has several levels of difficulty corresponding to the maximum force that can be applied, the time allowed, and other parameters.

The first PT exercise models a rubber ball squeezing routine, as illustrated in Fig. 3(a). The ball stiffness is color-coded and can be selected by the patient at the beginning of the exercise. Ball dynamics simulate gravity and Newtonian laws. Once it is grasped, the ball deforms in contact with the virtual hand while force feedback is displayed to the patient and recorded in the database. The exercise terminates when either the patient presses an exit key or the allowed time was exhausted. The second PT exercise implements a virtual version of the DigiKey [15], which is an individual finger exerciser, illustrated in Fig. 3(b), [5]. The model was modified to include the thumb instead of the pinky due to the RM-II kinematics configuration. The DigiKey maximum force levels were color-coded to match the commercially available set. After grasping the selected DigiKey, contact detection is checked between fingers and the corresponding cylinder ends; while in contact, the virtual cylinders are driven by the patient's finger movements. Forces proportional to the displacement of

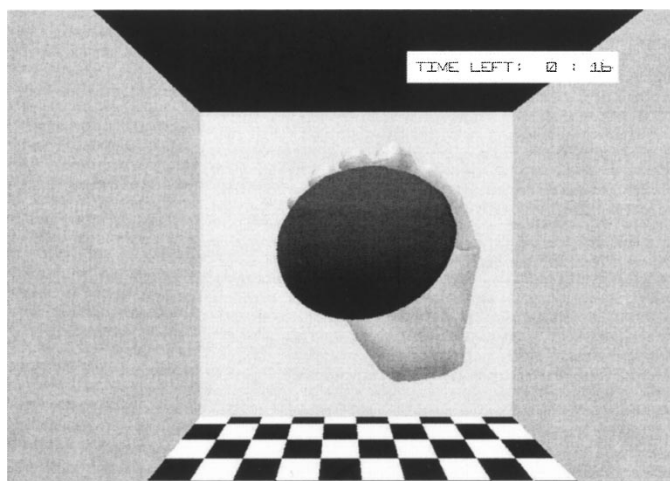

(a)

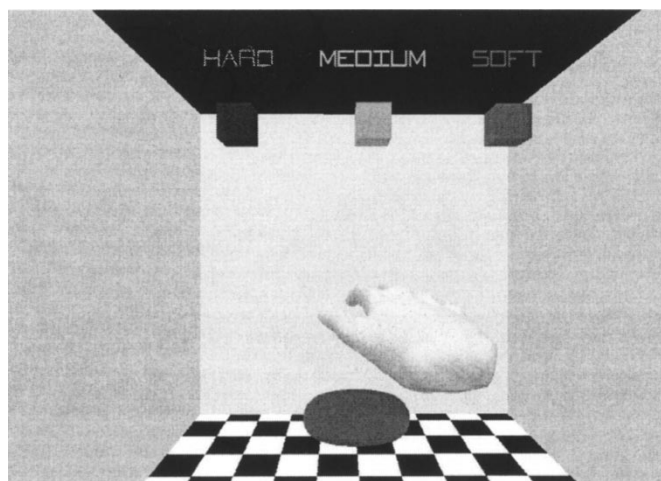

(a)

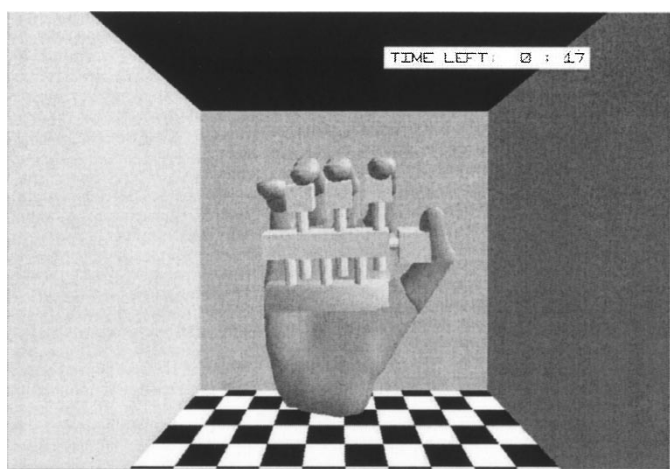

(b)



(b)

Fig. 3. Virtual PT exercises: (a) rubber ball squeezing and (b) DigiKey model (adapted from [5]).

Fig. 4. Virtual power putty molding PT exercise. (a) Putty selection. (b) Full grip. [21] © IEEE.

the DigiKey cylinders are fed back to the patient and stored transparently and simultaneously in the database.

The third PT exercise is a molding of virtual "power putty," as illustrated in Fig. 4(a) and (b). The patient selects either an ellipsoid or sphere unmolded putty shape, each with three selectable hardness levels. The ellipsoidal premolded putty is used for full grip, fingers only, thumb press only, or wrist rotation exercises. The spherical premolded putty is used for finger pinch, where the putty is squeezed between the thumb and fingers. A "reshape" button allows the patient to reset the putty to its premolded shape before repeating the exercise.

The first functional rehabilitation exercise is a peg board insertion task, illustrated in Fig. 5(a) [5]. The simulation uses a virtual peg board with nine holes and a corresponding number of pegs. The exercise has three levels of difficulty: "novice," "intermediate," and "expert," each with a different clearance between the peg and hole (smallest for the "expert" level). The amount of time allowed to complete the exercise is set by the therapist. Visual and auditory cues increase the simulation realism and help the patient overcome visual distortions. Pegs are grasped with a lateral pinch gesture and change color when in a correct insertion position. Exercise results are stored in the form of number

of holes filled, time spent to perform the exercise, and number of errors made (missed hole or an attempt to put two pegs in one hole). The second functional rehabilitation exercise is the ball game shown in Fig. 5(b). The patient has to throw the ball so that it hits the target wall above a marked area. When the ball bounces back, the patient has to catch it after at most one bounce off the ground. The ball speed parameter ("fast" or "slow" ball) is selected at the beginning of the exercise. Any correct catch increases the patient "catch" counter, while a miss will increase the "miss" counter. The ball deforms when caught by the patient and loses energy while bouncing. This exercise is useful to train feedforward ballistic-type movements and hand-eye coordination. Throwing and catching movements help improve accuracy and speed control.

IV. DEFORMATION AND HAPTIC RENDERING MODELS

Virtual objects which correspond to real rehabilitation devices deform when grasped by the patient, as described above. The deformation model uses the displacement vector of the mesh points (see [4] for a review of physical deformation methods). The method is simple, can be executed in real time, and fits well

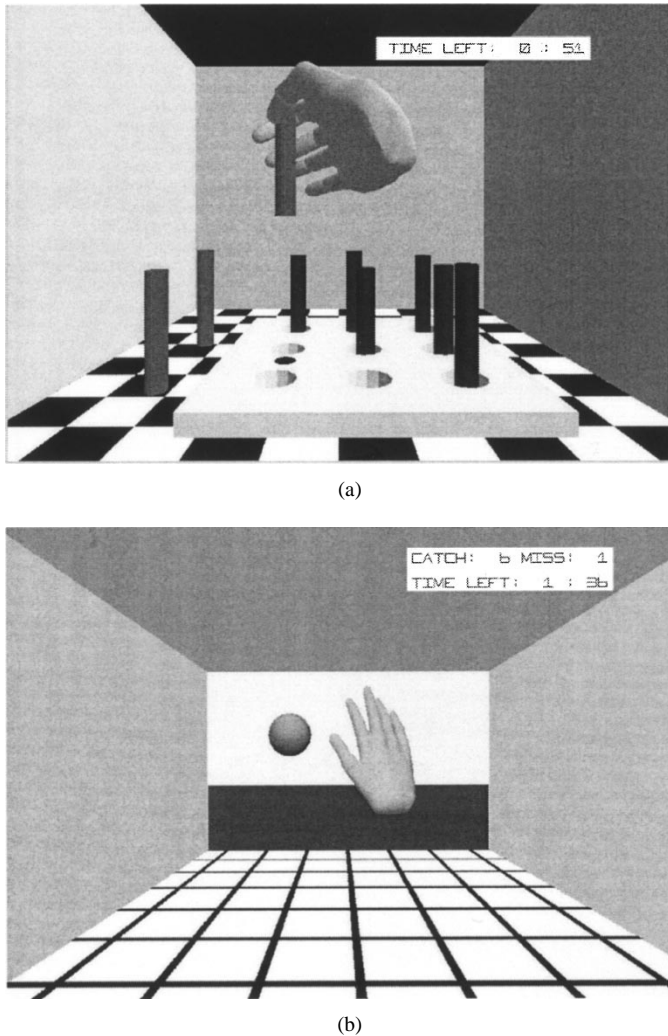

Fig. 5. Functional rehabilitation exercises. (a) Peg board (adapted from [5]). (b) Ball game. [21] © IEEE.

with the haptic rendering approach described below. The model allows for both elastic as well as plastic deformations. The elastic deformation model uses a nondeformed reference object, while the plastic deformation model updates the reference object after each simulation frame. The elastic deformation is modeled as a superposition of a global and a local deformation. The global deformation model uses a morphing technique. The position, normal, and color of all object vertices are interpolated linearly between a normal state (corresponding to an opened hand) and a maximum deformation state (corresponding to fully closed hand). The interpolation parameter α is the normalized mean of finger joint angles

$$\alpha = \frac{\sum_{i=0}^{\text{joints \#}} \theta_i}{\sum_{i=0}^{\text{joints \#}} \theta_{i \max}}. \quad (1)$$

The local deformation model is controlled by a 3×3 mesh of points placed on the surface of the fingertip. Contact distances are calculated between these points and the closest vertices of the intersecting object surface within a certain radius of influence. The radius of influence is typically the size of the largest dimension of the fingertip bounding box. The penetration distance relative to the reference object is weighted with a second

degree polynomial

$$D = k * u \cdot \left(\langle \vec{P}_{\text{surface point}} - \vec{P}_{\text{fingertip}}, \vec{N}_{\text{surface point}} \rangle \right),$$

where

$$k = 1 - (d/\text{radius of influence})^2, \quad (2)$$

$$d = \left\| \vec{P}_{\text{fingertip}} - \vec{P}_{\text{surface point}} \right\|$$

and $u(\cdot)$ is the unity step function (deformations are calculated only for positive penetration distances). The deformations from different points of the haptic interaction mesh are not summed up but a maximum value is calculated to obtain vertex displacement.

The haptic control loop in the MHCI runs at a much higher rate (500 Hz) than the graphics refresh rate (currently set at 20 fps in this application). Two models were used to implement the haptic control loop. In the first case used for DigiKey, peg board, and ball game exercises, the haptic rendering loop runs entirely on the MHCI, and the host PC only commands the beginning and the end of haptic feedback. Haptic interaction parameters (spring, friction, and dumping constants + intervals where the model applies) are transmitted by the host when the force feedback loop is activated. Forces are calculated locally on the MHCI using Hooke's deformation law. More complex deformation models can be implemented using dumping and friction parameters. This local model works well for grasping objects with a simple shape.

In the second case for ball and power putty exercises, the haptic rendering model resides entirely on the PC workstation. Here the PC host calculates and sends 20 force targets per second (synchronized with the graphics loop) to be displayed by the MHCI to patient fingers. The forces are based on the displacement vector calculated for the deformation model. The force vector is determined by the formula

$$\mathbf{F} = k_{\text{stiffness}} * u \cdot \left(\langle \vec{P}_{\text{surface point}} - \vec{P}_{\text{fingertip}}, \vec{N}_{\text{surface point}} \rangle \right). \quad (3)$$

V. THE CLINICAL DATABASE AND CLIENT/SERVER ARCHITECTURE

Patient data is stored during the therapeutic exercises and organized in several tables: patient table (personal data), index table (exercise index, type and date), and exercise tables. The database Graphical User Interface (GUI) was designed using Oracle Forms, Reports, and Graphics [16]. The patient entry form provides the graphical interface to input data, query, update, browse, or delete records. The exercise form displays a listing of sessions of specified type performed by the patient.

“Raw data” corresponding to the forces exerted by the patient's fingers are displayed when pressing the “show” button. Fig. 6(a) is a sample graph for the thumb forces during a DigiKey exercise [20]. Finger forces “raw data” is, however, of little use to the clinician. These data are therefore processed in order to extract meaningful information for patient remote assessment. The finger force mean, standard deviation, and effort (force integral) for each session are computed and displayed. A time history of these parameters over several rehabilitation sessions is subsequently created, as shown in Fig. 6(b). The graph shows a target (goal) parameter, which is set by the therapist. The patient

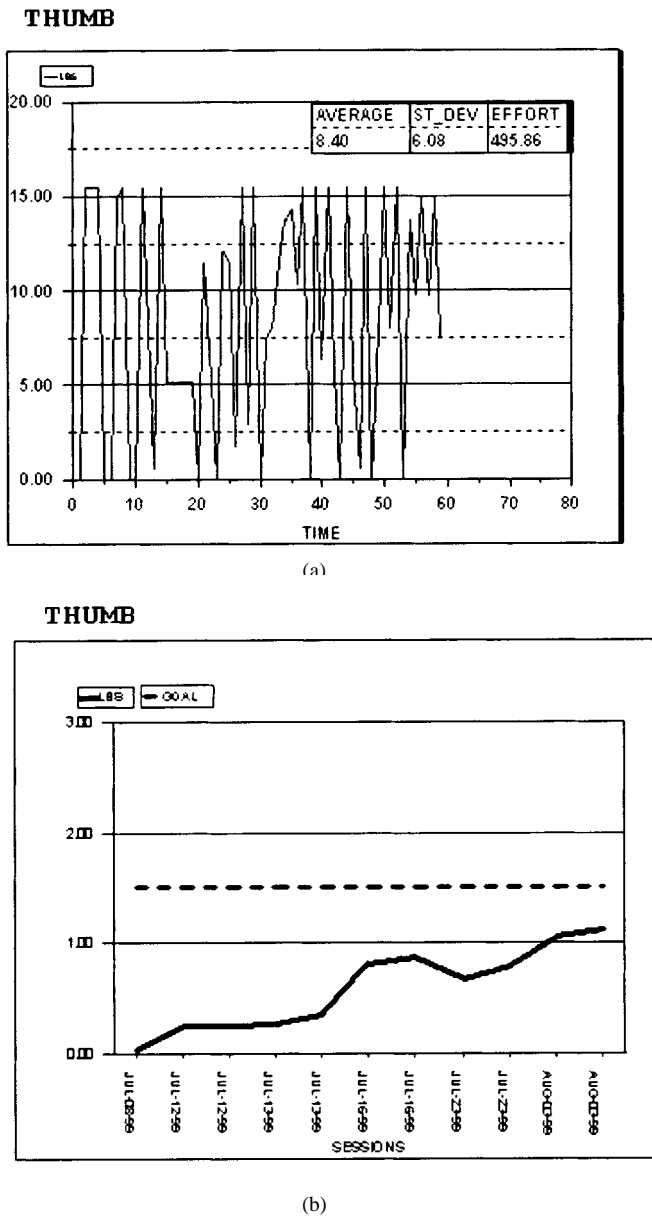

Fig. 6. Clinical database. (a) Graph containing “raw data” for a given session. (b) A patient’s progress history versus the set goal [20].

has to achieve this goal over a specified number of sessions, if the rehabilitation therapy is effective when implemented at home. This goal can be remotely modified by the clinician after assessing patient progress in order to fine tune the treatment to a particular patient’s speed of recovery.

The above database is stored at the server side (clinic), as illustrated in Fig. 7 [20]. The therapist has remote access to the patient’s exercise routines without having to travel to the patient’s home. After looking at the graphs, the therapist can also judge whether the routine was performed in a satisfactory fashion or not. A client server networking component has a menu style GUI developed on a WinNT platform. The database update module written using ProC transfers data from VR rehabilitation exercises into the clinic database. The asynchronous transfer uses a TCP/IP connection and transfers local files stored subsequent to each exercise routine. The data file transferred contains exercise type, patient ID, execution time, and exercise raw data.

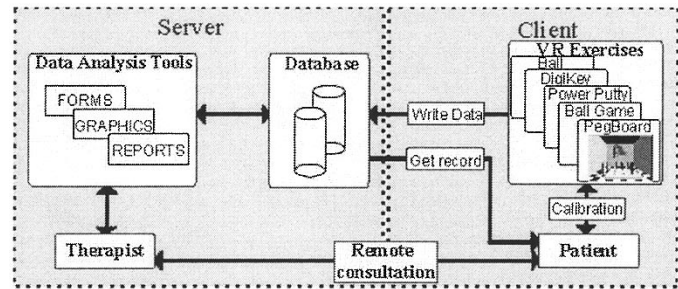

Fig. 7. Telerehabilitation system software architecture [20].

The client site (the patient’s home) is running the real-time VR exercises previously described. While wearing the rehabilitation haptic devices, the patient controls the system using voice commands. The speech interface uses a Microsoft speech recognition engine [13], with a small grammar implemented for our application. Care has to be taken when programming all software components to share a single processor machine. The VR exercises thus run with higher priority to allow a maximum graphics frame rate. Videoconferencing tools installed at the server and client sites use CuSeeMe videoconferencing software [27]. The graphical interface thus allows a patient to start VR exercises and open a video channel for consultation with the therapist; it also includes documentation in the form of help and mpeg tutorial movies for correct execution of the rehabilitation routines. During several teleconferencing system trials, we obtained uneven performances, in some cases with only 2–3 frames/s. Internet2 became available for the project in late 1999 and allowed about 10 frames/s.

The quality of network services is very important for the system reliability and performance. Several parameters affect the network services: data file size, time to transfer, and failure rate. The amount of data collected from the exercise depends on its type and duration. For physical therapy exercises, we are recording forces applied by the patient at a sampling rate of five reads/s. For a 1-min exercise, that means about 10 kbit of data. Functional rehabilitation exercises need only tens of bytes to be transferred to the database. Transfer time and failure rates need to be measured experimentally. A recovering procedure was designed to prevent patient data loss. Failures are recorded in a log and transfer is reinitiated for each failure. The client server communication was tested in a LAN before the actual start of clinical trials. The average time for data transfer and failure rate were measured in an experiment with 1000 database updates over the LAN. It took an average of 2.01 s for a DigiKey exercise to be stored in the remote database. There were no failures over these 1000 database updates. Networking data collected so far from the experiment involving Stanford University and Rutgers University sites showed an average transfer time of 30 s for the DigiKey exercise and 4 s for PegBoard.

VI. CONCLUSION AND FUTURE RESEARCH

A PC-based telerehabilitation system using virtual reality and force feedback interfaces was developed for home use. The haptic hardware used to apply forces on the patient’s body includes a novel multipurpose haptic control interface and the RM-II glove.

A library of VR exercises was modeled after standard rehabilitation routines. This simulation library contains both physical therapy and functional rehabilitation routines. Data collected during the exercises is stored remotely at the server site (clinic) using the Internet. Here the therapist can analyze it, evaluate the patient's progress, and modify VR exercise parameters or rehabilitation goals over the network. Remote consultation is supported using a videoconferencing system.

Developing new haptic devices for rehabilitation is an ongoing research effort in our laboratory. Elbow, knee, and ankle interfaces are currently being designed and built for control by the same multipurpose haptic control interface hardware. Elbow and knee units are one-degree-of-freedom systems using symmetrically mounted pneumatic actuators to oppose flexion extension motion. The Rutgers ankle interface uses a Stewart platform with six double acting pneumatic actuators. Clinical trials with the telerehabilitation system described here are underway at Stanford Medical School.

The system is currently being extended to include several client sites (patient homes with rehabilitation workstations) and a central server clinic. This configuration, called multiplexed telerehabilitation, should allow the testing of the full potential of telerehabilitation technology. Additional issues of patient identification, data security, and remote consultation multiplexing have to be addressed. A new web-based distributed architecture for the multiplexed telerehabilitation system is under development. This innovative design assumes fast speed networks (Internet2) and takes advantage of newly developed Internet technologies (Java3D) to create a distributed system (database, multimedia, VR exercises) which resides entirely on the web.

REFERENCES

- [1] *AutoCAD User's Manual*, Sausalito, CA, 1994.
- [2] E. Brandt and A. Pope, Eds., *Enabling America*. Washington, DC: National Academy Press, 1997.
- [3] G. Burdea, N. Langrana, E. Roskos, D. Silver, and J. Zhuang, "A portable dextrous master with force feedback," *Presence*, vol. 1, no. 1, pp. 18–28, 1992.
- [4] G. Burdea, *Force and Touch Feedback for Virtual Reality*. New York, NY: Wiley, 1996.
- [5] G. Burdea, S. Deshpande, V. Popescu, N. Langrana, D. Gomez, D. DiPaolo, and M. Kanter, "Computerized hand diagnostic/rehabilitation system using a force feedback glove," in *Proc. MMVR 5*, 1997, pp. 141–150.
- [6] G. Burdea, S. Deshpande, B. Liu, N. Langrana, and D. Gomez, "A Virtual reality-based system for hand diagnosis and rehabilitation," *Presence*, vol. 6, no. 2, pp. 229–240, 1997.
- [7] D. Gomez, G. Burdea, and N. Langrana, "Integration of the Rutgers Master II in a Virtual Reality Simulation," in *Proc. VRAIS'95*, 1995, pp. 198–202.
- [8] Greenleaf Medical Systems, Business Overview. (1997), Palo Alto, CA. [Online] <http://www.greenleafmed.com/Products/pointofcare.html>
- [9] S. Fox, "EVAL-revolutionizing hand exams," *ADVANCE for Occupational Therapists*, vol. 7, no. 3, pp. 7–7, 1991.
- [10] H. Krebs, N. Hogan, M. Aisen, and B. Volpe, "Application of robotics and automation technology in neuro-rehabilitation," in *Japan-USA Symposium on Flexible Automation*, vol. 1, NY, 1996, pp. 269–275.
- [11] Q. Lin, C.-W. Che, D.-S. Yuk, and J. Flanagan, "Robust distant talking speech recognition," in *Proc. ICASSP'96*, Atlanta, GA, 1996, pp. 21–24.
- [12] G. Luecke, Y. Chai, J. Winkler, and J. Edwards, "An exoskeleton manipulator for application of electro-magnetic virtual forces," in *Proc. ASME WAM*, vol. DSC-58, 1996, pp. 489–494.
- [13] Microsoft Corp, "Whisper Speech Recognizer," <http://research.microsoft.com/msrinfo/demodwnf.htm>, 1998.

- [14] National Center for Medical Rehabilitation Research, "Research plan for the national center for medical rehabilitation research," NIH Publication no. 93-3509, 1993.
- [15] North Coast Medical Inc., "Digi-Key," San Jose, CA, 1994.
- [16] *Oracle User's Manual*, Redwood City, CA, 1995.
- [17] G. Patounakis, M. Bouzit, and G. Burdea, "Study of the electromechanical bandwidth of the Rutgers master," Rutgers University, Tech. Rep. CAIP-TR-225, May 22, 1998.
- [18] J. Peifer, A. Hooper, and B. Sudduth, "A patient-centric approach to telemedicine database development," in *Proc. MMVR 6*. Amsterdam: IOS Press, 1998, pp. 67–73.
- [19] *Fastrak User's Manual*, McDonnell Douglas Electronics Co., Colchester, VT, 1993.
- [20] V. Popescu, G. Burdea, M. Bouzit, M. Girone, and V. Hentz, "PC-based telerehabilitation system with force feedback," in *Proc. MMVR 7*. Amsterdam, 1999, pp. 261–267.
- [21] V. Popescu, G. Burdea, and M. Bouzit, "Virtual reality modeling for a haptic glove," in *Proc. Computer Animation '99*, Geneva, Switzerland, 1999, pp. 195–200.
- [22] A. Rovetta, F. Lorini, and M. Canina, "A new project for rehabilitation and psychomotor disease analysis with virtual reality support," in *Proc. MMVR 6*. Amsterdam, 1998, pp. 180–185.
- [23] *WorldToolKit User's Manual*, Sausalito, CA, 1994.
- [24] T. Takeda and Y. Tsutsul, "Development of a virtual training environment," in *Advances in Robotics, Mechatronics, and Haptic Interfaces, Proc. ASME WAM*, vol. DSC-49, 1993, pp. 1–10.
- [25] *Viewpoint Catalog*, 3rd ed., Orem, UT, 1994.
- [26] F. Ward and M. Bullinger, "Joint monitor," U.S. Patent 5 754 121, May 19, 1998.
- [27] *CuSeeMe User Guide*, Nashua, NH, 1997.

Viorel G. Popescu (S'93) received the B.S. and M.S. degrees from the University "Politehnica" of Bucharest in 1993. He is currently working toward the Ph.D. degree at the Electrical and Computer Engineering Department, Rutgers University, New Brunswick, NJ.

His research involves haptic display systems and medical application of virtual reality.



Grigore C. Burdea (S'87–M'87–SM'90) received the Ph.D. degree from New York University, New York, NY, in 1987.

He is presently an Associate Professor of Computer Engineering at Rutgers University, New Brunswick, NJ. He has authored the books *Virtual Reality Technology* (New York: Wiley, 1994) and *Force and Touch Feedback for Virtual Reality* (New York: Wiley, 1996) and co-edited the book *Computer-Aided Surgery* (Cambridge, MA: MIT Press, 1996).

Dr. Burdea will chair the upcoming IEEE Virtual Reality 2000 Conference.

Mourad Bouzit (M'99) received the Ph.D. degree in robotics and computer science from the University of Paris VI, Paris, France, in 1996.

He is presently a Post-Doctoral Fellow at the Center for Advanced Information Processing, Rutgers University, Piscataway, NJ. His research topics include teleoperation, dextrous telemanipulation, artificial hand and force feedback systems for virtual reality applications. He prototyped the LRP Master, the first French force feedback data glove for virtual reality.



Vincent R. Hentz received the M.D. degree from the University of Florida, Gainesville, in 1968.

He is presently Professor of Functional Restoration at Stanford University School of Medicine, Stanford, CA. He has authored four books and 25 book chapters.

Dr. Hentz is currently President of the American Society for Surgery of the Hand.