

A WIRELESS SENSOR NETWORK FOR INTELLIGENT BUILDING ENERGY MANAGEMENT BASED ON MULTI COMMUNICATION STANDARDS – A CASE STUDY

SUBMITTED: December 2010.

REVISED: January 2012.

PUBLISHED: May 2012 at <http://www.itcon.org/2011/3>

EDITOR: Ghang L.

*Hanne Grindvoll, Research Scientist,
Department of Communication Systems, SINTEF ICT, Norway;
Hanne.Grindvoll@sintef.no, <http://www.sintef.no/Home/>*

*Ovidiu Vermesan, Chief Scientist,
Department of Communication Systems, SINTEF ICT, Norway;
Ovidiu.Vermesan@sintef.no, <http://www.sintef.no/Home/>*

*Tracey Crosbie, Dr,
Centre for Construction Innovation Research, Teesside University, UK;
t.crosbie@tees.ac.uk, <http://sst.tees.ac.uk/ccir/>*

*Roy Bahr, Research Scientist,
Department of Communication Systems, SINTEF ICT, Norway;
Roy.Bahr@sintef.no, <http://www.sintef.no/Home/>*

*Nashwan Dawood, Professor,
Centre for Construction Innovation Research, Teesside University, UK;
n.n.dawood@tees.ac.uk, <http://sst.tees.ac.uk/ccir/>*

*Gian Marco Revel, Assistant Professor,
Department of Industrial Engineering and Mathematical Sciences, Univerit  Politecnica delle Marche, Italy;
gm.revel@univpm.it, <http://www.univpm.it/English/Engine/RAServePG.php>*

SUMMARY: *This paper presents a case study of a wireless sensor network (WSN) to support energy management utilizing Web services and middleware technologies. The approach presented proposes the integration of WSNs with Ethernet/Internet/XML/Web Service communications into a 'knowledge and information services' platform to support energy management which can be accessed via a Web service to support inhabitant actions to reduce energy demand. It is based on the idea of collecting energy information using various wireless devices operating with different communication standards. This is important as there are various communication standards developed for WSNs including ZigBee, 6LoWPAN, Wi-Fi, WirelessHART and ISA100.11a. The hardware components which are needed for a system using one specific communication standard cannot be used directly within another system, due to differences in firmware, radio components, communication standards, and in some cases profile parameters. This is problematic because the components of different systems cannot be mixed and used in combination in order to take advantage of the most useful aspects of products from multiple vendors. The concept and initial testing of the WSN presented in this paper goes beyond current approaches as it uses various wireless devices operating with different communication standards, which can support Web based services for building managers, owners and inhabitants.*

KEYWORDS: *Wireless sensor networks, communication standards, energy management, building*

REFERENCE: Hanne Grindvoll, Ovidiu Vermesan, Tracey Crosbie, Dr, Roy Bahr, Nashwan Dawood, Gian Marco Revel (2012) A wireless sensor network for intelligent building energy management based on multi communication standards – a case study, *Journal of Information Technology in Construction (ITcon)*, Vol. 17, pg. 43-62, <http://www.itcon.org/2011/3>

COPYRIGHT: © 2012 The authors. This is an open access article distributed under the terms of the Creative Commons Attribution 3.0 unported (<http://creativecommons.org/licenses/by/3.0/>), which permits unrestricted use, distribution, and reproduction in any medium, provided the original work is properly cited.



1. INTRODUCTION

The pledge of the European Union (EU) to cut the annual consumption of primary energy by 20% by the year 2020 (European Commission, 2008) has contributed an increased demand to reduce the energy consumption of buildings. This implies the necessity of a conscious way of thinking and actions regarding efforts to reduce energy consumption throughout the whole lifecycle of buildings (Crosbie et al, 2010). To this end European Commission funds research projects in this area. The work presented in this paper is part of the output of one such project entitled IntUBE – ‘Intelligent use of buildings energy information’ (IntUBE, 2009). The overall aim of the IntUBE project is to intergrate the information and communication technologies (ICTs) used in the design and operation of buildings to support improvements in the energy performance of buildings and the measurement of that performance. Within this field of research the exploitation of the potential of wireless sensor networks (WSNs) to facilitate intelligent energy management in buildings, which increases occupant comfort while reducing energy demand, is highly relevant. In addition to the obvious economic and environmental gains from the introduction of such intelligent energy management in buildings other positive effects will be achieved. Not least of which is the simplification of building control; as placing monitoring, information feedback equipment and control capabilities in a single location will make a buildings’ energy management system easier to handle for the building owners, building managers, maintenance crews and other users of the building. Using the Internet together with energy management systems also offers an opportunity to access a buildings’ energy information and control systems from a laptop or a SmartPhone placed anywhere in the world. This has a huge potential for providing the managers, owners and inhabitants of buildings with energy consumption feedback and the ability to act on that information.

In recent years, wireless sensor networks (WSNs) used for environmental monitoring, health monitoring (Lynch and Loh, 2006) and industrial monitoring has been widely recommended as a means of reducing the energy consumption and CO₂ emissions (Srivastava, 2010). WSNs are also highly flexible. Thus they rapidly enable the deployment of temporary infrastructures in a retrofit scenario to perform measurements for a predefined time period in order to monitor energy usage and improve energy efficiency (Guinard et al, 2009). This recent interest in WSNs has resulted the development of various communication standards to support them, including ZigBee, 6LoWPAN, Wi-Fi, WirelessHART and ISA100.11a. The hardware components which are needed for a system using one specific communication standard cannot be used directly within another system due to differences in firmware, radio components, communication standards, and in some cases profile parameters (Baronti et al, 2007). This is problematic because the components of different systems cannot be mixed to take advantage of the most useful aspects of products from multiple vendors. The research underpinning this paper attempts to overcome this problem. It involves a case study of the development and initial testing of a WSN to support energy management using wireless devices operating with different communication standards. The basic idea is to collect information related to building energy performance, using various wireless devices from different vendors operating with different communication standards, that is stored on distributed repositories accessed via a Web service. This research is motivated by the demand for energy reduction, the lack of interoperability between different sensor systems, and a desire to explore how to use Web services to present inhabitant energy feedback.

The remainder of this paper is organised as follows: Section 2 contextualises the research presented in this paper by outlining the role of wireless sensing in intelligent buildings and discussing some recent advances in this area. Section 3 introduces the reader to the approach adopted in the research by outlining some requirements for WSNs and presenting a description of the hardware utilised for the test setup including an overview of the

sensors and the sensing parameters. A description of how the sensor data are collected and presented is given in section 4 and 5, respectively. The tested WSN is evaluated in section 6 and finally, section 7 concludes the paper and presents the future research avenues these conclusions suggest.

2. WIRELESS SENSING AND INTELLIGENT BUILDINGS

2.1 The current situation

Present day intelligent buildings are highly adaptable to changing environmental conditions. They have automated systems, including wireless sensor monitoring, to facilitate energy efficient, comfortable and cost effective environments by optimising structure, systems, services, building management and their interrelationships (Grondzik et al 2010). In the context of the future 'Internet of Things', Intelligent Building Management Systems can be considered part of a much larger information system. This system is used by facilities managers in buildings to manage energy use and energy procurement and to maintain buildings systems. It is based on the infrastructure of the existing Intranets and the Internet, and therefore utilises the same standards as other IT devices. Within this context reductions in the cost and reliability of WSNs are transforming building automation, by making the maintenance of energy efficient healthy productive work spaces in buildings increasingly cost effective.

Wireless sensing in commercial and office buildings has led to a greater awareness of the condition of buildings and their systems: As it provides information necessary for those in charge of building operation and maintenance to recognise limits and non-functioning equipment and systems and prioritise building maintenance tasks etc. based on costs and other important factors (Brambley et al, 2005, Menzel et al, 2008). The main benefits of this are:

- An increased lifespan for equipment/electric appliances;
- An improved building environment for occupants;
- Economies of scale gained from monitoring, tracking and responding to the status of multiple building assets from centralised or regional locations;
- The ability to detect impending faults and therefore minimise energy usage associated with facility assets and increase reliability while reducing costs;
- Lower energy and operating costs leading to an advantageous return on investment. For example energy management systems based on WSNs can save an average of 10 % in overall building energy consumption and the energy savings can be as high as 30% depending on occupancy (Lun-Wu Yeh et al, 2009).

2.2 Recent advances

The WSNs used in intelligent building management systems consist of different types of sensor nodes measuring parameters such as temperature, humidity, light, asphyxiating gases/smoke, occupancy, and energy consumption. In addition, the systems may include actuators, gateways, servers and communication and application software on different levels as well as different home appliances. A large amount of research has been conducted focusing on different aspects of WSN for building management and control.

The IEEE 1451 is a set of smart transducer interface standards developed to increase the interoperability and speed up the expansion of smart sensors and actuators usage within the area of wired and wireless network. The IEEE 1451.0 standard defines a common set of operations and transducer electronic data sheet (TED) formats of the transducer interface module (TIM). The IEEE 1451.5 standard, published in 2007 (IEEE 1451.0 compatible), defines the interface between the transducer and the network capable application processor (NCAP), and TED formats for wireless transducers. The IEEE 1451.5 standard adopts wireless communication protocols within the IEEE 802 family, such as WiFi (802.11), Bluetooth (802.15.1), ZigBee (802.15.4), and the 6LoWPAN, but still only few implementations have been reported (Higuera et al. 2009). However; Kang Lee, chair of IEEE IMS TC-9 Sensor Technology, presented already in 2006 implementation examples of the proposed IEEE 1451.0/1451.5 standards. The three examples discussed consist of a sensor node and a network node which communicate with each other using the proposed standard interfaces through the 802.11 wireless communication modules (Song and Lee, 2006). The same year David Sweetser et al. presented an implementation of a smart

sensor based on the proposed IEEE 1451.5 and Bluetooth communication interface (Sweetser et al. 2006). The proposed ZigBee network, compliant with the IEEE 1451-5 standard proposed by Jorge Higuera in 2009, is probably the first IEEE 1451-5-ZigBee protocol implemented and tested in a real deployment. A proposal to enhance the physical TED is also presented (Higuera et al. 2009).

Work carried out by Menzel et al (2008) presents the design and setup of a wireless platform that supports building performance and energy management. The communication between the sensor nodes and a zone controller is implemented using a modified IEEE802.14.4/ZigBee protocol. Schor and Sommer et al (2009) developed an approach using Web services to integrate sensor and actuator nodes into IP-based networks. They implemented an application programming interface (API) using the principles of Representational State Transfer (REST) for accessing services on the sensor nodes. Using WSNs to monitor conditions in buildings has also been investigated by Jang et al (2008). This research includes hardware programming of sensor nodes and processing of signals from the wireless sensor nodes using a Java program. As part of their research they also developed a Web-based system that allows users to mine the database using parameters such as the type of data, location of sensor and the time of data acquisition. Performance of WSN has been investigated in an experimental study of link quality distribution of a WSN in a four-storey building with a network hub placed in an adjacent building to overcome obstructions between floors and improve the radio communication (Halgamuge et al, 2009). A study of critical WSN performance metrics to predict the reliability in building applications has been conducted by Jang and Healey (2010). Their experiments were used to determine a distance between transmitter and receiver to ensure a reliable data transfer. Energy savings of 7.1% -14.6% by using a WSN with multicast communication protocol, controllers, sensors and a control algorithm that switches a relay on or off according to room occupancy have been presented in (Marchiori and Han, 2010). A WSN for building monitoring based on cluster formation of nodes in a room, inspired by LEACH (Low Energy Adaptive Cluster Hierarchy) method is demonstrated in (Dong et al, 2010). This system aggregates temperature, humidity and light sensitivity data, displays curves and stores data in a database. An approach to operate a ZigBee based WSN in a way that is energy autonomous and maintenance-free, using indoor light energy harvesting, and a system level model for energy harvesting is presented in (Wang et al, 2010).

According to Neves et al. (2010) a common suitable application for general public adaption of WSN is still absent, mainly due to the lack of auto configuration tools and corresponding APIs, which allow plug and play. They suggest the IPv6 technology to integrate WSNs into ubiquitous computing, providing a complete sensing system and uses the transport layer protocol UDP over IPv6, with 6LoWPAN and IEEE 802.15.4 wireless communication between the sensor network and the sink node (coordinator), which are USB connected to a computer. As future work they suggest to replace the sink node with a Bluetooth enabled sensor node, to extend the wireless connection to mobile devices and not only to computers.

In summary the findings of this previous have illustrated that the implementation of a WSN based on heterogeneous embedded systems, sensors and communication protocols requires the following:

- It must be easy to use and therefore the WSN must be self-configurable to keep the effort and costs involved in its maintenance at a realistic level;
- It must have high levels of fault tolerance and therefore in cases of intermediate node failure the WSN must be able to identify alternative routes and thereby avoid node isolation;
- The WSN needs to be as extensive as possible therefore sensor nodes must be located in as many different areas of the building as is feasible;
- The operation of the WSN should not 'defeat the object' by consuming a large proportion of the energy saved through the automation of building systems it supports;
- To support systems flexibility periodicity must be an independently configurable parameter in every node and its modification must be possible at all times, even when the node is sleeping;
- The WSN must be reliable and therefore it must deliver data with a low error rate;
- Systems latency must be kept to a minimum therefore data delivery must have as short time delay as possible;
- Nodes must be repositionable to support systems flexibility;
- Systems safety and privacy are essential and therefore the WSN must be immune to malicious attacks.

The recent advances in hardware and software within the area of WSN are important and necessary steps towards holistic system integration, but also reflect the complex scene of standards and interoperability. These challenges are also stated in the new report from IDTechEx 'Wireless Sensor Networks 2011-2021'; no single standard has emerged as a clear winner, many vendors offer only hardware, various sensor vendors may not interplay, and lack of scalability (Das, 2011). Today, the WSN system technologies suffer from non-flexibility and proprietary solutions. It is necessary to come to an understanding and bridging the gap to overcome these obstacles and achieve success within the WSN area. The approach to WSN presented in the remainder of this paper seeks to build on the findings of the earlier work in this area, outlined above, to support the development of a WSN that goes beyond current approaches.

3. AN INTEGRATED APPROACH

3.1 Integrating WSNs with Ethernet/Internet/XML/Web Service communications

The approach to WSN presented in this paper seeks to integrate WSNs with Ethernet/Internet/XML/Web Service communications into a 'knowledge and information services' platform to support energy management, that can be accessed via a Web service to support actions to reduce energy demand. This system is piloted by the deployment of WSNs in an office building using the communication standards ZigBee and 6LoWPAN. These standards are embedded into a large number of products suitable for home automation and building automation. The WSNs consists of commercially available low cost devices with small size and low power, which are integrated with computation, sensing, and radio communication capabilities. In the approach presented in this paper these elements include nodes with integrated sensors measuring temperature, light, and humidity and combined power switches and energy meters. The latter are used both as remote power control switches and as devices to measure voltage, current, frequency, load and power consumption associated with the electronic equipment to which it is attached. Data from the sensors are stored in distributed repositories, such as a gateway and internal/external servers. The two sensor networks do not have the interoperability to communicate with one another, but the possibility of controlling switches and gathering, analysing and presenting sensor data from both of the installed wireless sensor networks on Web user interfaces accompanying the WSNs, as well as on an adapted Web site makes the system function as a whole.

3.2 Overview of sensing and sensing parameters

3.2.1 6LoWPAN Wireless Sensor Network

The 6LoWPAN subsystem is formed by one server, two routers, and ten battery driven sensor nodes, see Fig. 1. The server, which stores both sensor data and network information, is connected to the Local Area Network (LAN) and provides a Web Interface, which displays data from the sensors and the network. Through this interface the user is able to manage and control the wireless network.

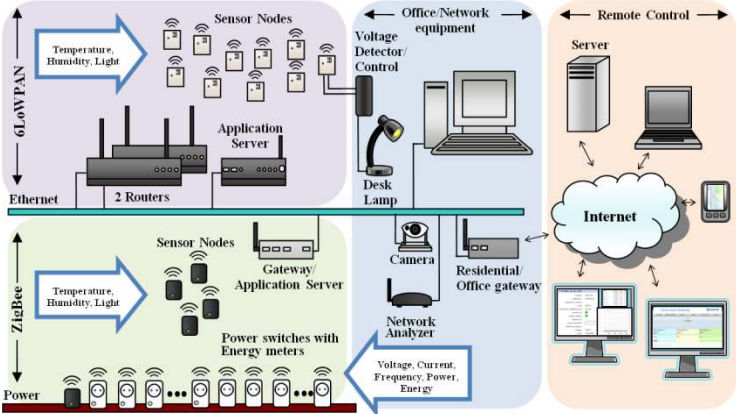

FIG. 1: The wireless sensor network concept

Access to the network from the server goes through the two parallel working routers. These routers manage the routing between the sensor nodes and the IP network connected to the server. Deploying two routers in the same network of sensor nodes will scale the throughput of the network. Each router is able to take over the other router's tasks in cases of a non-operational router, which increases the redundancy and reliability of the network.

All the ten sensor nodes include integrated temperature, humidity and light sensors, and communicate with routers and each other using mesh routing protocols. The indoor operation range is approximately 50 metres. Built-in expansion ports make it possible to connect the sensor nodes to different external sensors, switches, and actuators. To utilize this range of use one of the 6LoWPAN sensors in the pilot network was connected to a device functioning as a relay controlling the mains to a desk lamp, as can be seen in Fig. 1. From the server's Web interface the lamp was remotely switched on and off.

An example of the connectivity in the 6LoWPAN network as shown in the relevant Web interface of the 6LoWPAN equipment is illustrated in Table 1. Here the sensor nodes are listed under their parent nodes and router, and the information regarding the communication between the network elements is displayed.

TABLE 1: Example of the connectivity in the 6LoWPAN wireless sensor network

Name	MAC Address	IP Address	Short	Signal	Link	Duty	Updated
ict-energy							
Router_01	00173b0011e5b8cf	10.10.0.8	8	--	--	--	3:00:03 pm
H 310	00173b000ed59bab	10.10.0.176	176	-55 dBm	100%	0.69%	3:07:36 pm
SERVER 312A	00173b000ed85af4	10.10.0.251	251	-78 dBm	100%	0.64%	3:08:23 pm
KJ 313	00173b000ed83a7f	10.10.0.224	224	-63 dBm	100%	0.48%	3:08:03 pm
LAB 301	00173b000ed7dea3	10.10.0.187	187	-86 dBm	100%	0.64%	3:07:24 pm
Router_02	00173b0011e57c74	10.10.0.1	1	--	--	--	3:11:23 pm
B 308A	00173b000ed81865	10.10.0.128	128	-72 dBm	93%	0.5%	3:07:55 pm
J 310B	00173b000ed7e698	10.10.0.202	202	-68 dBm	100%	0.64%	2:58:55 pm
M 306	00173b000ed84853	10.10.0.239	239	-74 dBm	97%	0.77%	2:55:59 pm
LAB2 301	00173b000ed839b8	10.10.0.183	183	-76 dBm	100%	0.6%	2:53:53 pm
O 309	00173b000ed81f09	10.10.0.69	69	-78 dBm	100%	0.63%	3:00:36 pm
R 308	00173b000ed81a88	10.10.0.98	98	-78 dBm	98%	0.57%	3:10:44 pm

3.2.2 ZigBee Wireless Sensor Network

The ZigBee WSN depicted in Fig. 1 is composed of devices from different vendors. The gateway functions both as a server storing network data and a connection point between the network nodes, the LAN and the external server. It has the coordinator role in the ZigBee network. A Web user interface running on the gateway enables the user to set up and manage the gateway and the WSN.

Several battery-driven wireless sensor nodes with internal sensors to measure temperature, light and humidity are deployed in the network. These nodes are able to form mesh networks and can operate within an indoor range of about 40 metres. They function as end-devices in the ZigBee WSN. Another sensor node is equipped with a power socket and has a router function in the network.

A number of remotely controlled ZigBee devices with relays are used as switches to power external equipment, such as table fans, desk lamps, etc. These devices, which act as routers in the WSN, are plugged into power points. They are also used as meters for measuring the voltage, current, frequency, power consumption and load of the attached equipment.

For testing purpose to actually see what's happening when controlling the switches from the Web site, a network camera has been connected to the LAN. This camera displays on the Web site live monitoring of the electronic equipment connected to the power lines by wireless controlled switches.

All the wireless network devices belonging to both sub-networks are located in various rooms at the same floor in the office building, as can be seen in Fig. 2. The room 301 is a laboratory, 313 is a kitchen, 312A functions as a server room, and the others are small offices. Most of the walls are non loadbearing walls and glass, but the server room are surrounded by brick walls.

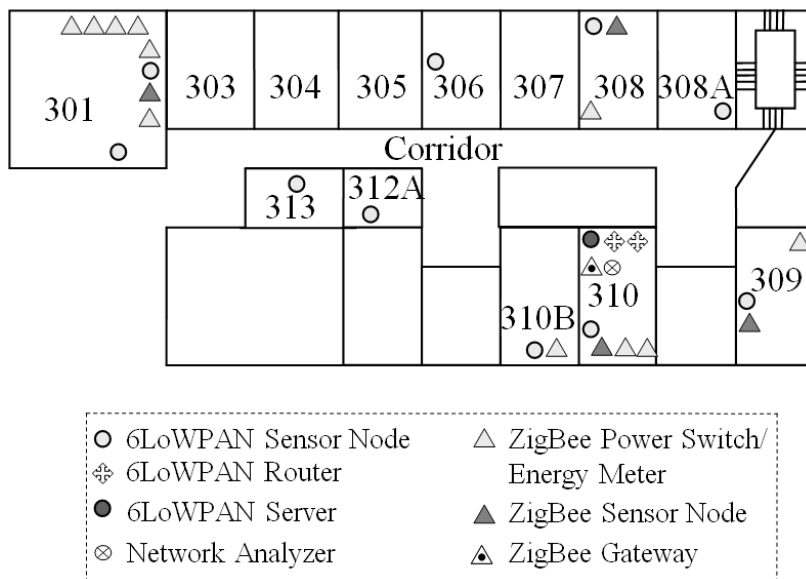

FIG. 2: Deployment map of the wireless sensor network

3.2.3 Measurement Parameters and Sensor Node Data

Environmental parameters (i.e. temperature, humidity and light) are important factors for deciding whether equipment (such as fans, electric heaters or lamps) should be switched on or off in a wireless monitoring network used for energy management in buildings. The 6LoWPAN sensor nodes include a sensor for measuring temperature and relative humidity. This sensor has a temperature range of -40°C to 123°C with an accuracy of approximately $\pm 0.5^{\circ}\text{C}$ at 25°C , and a relative humidity (RH) accuracy of $\pm 3.5\%$ at 20-80% RH. Another sensor measures the illuminance in visible range and has a maximum photosensitivity of approximately 0.3 A/W at a 550 nm wavelength at 25°C .

The sensor nodes used in the ZigBee WSN have a temperature sensor operating in the range of -18°C to $+55^{\circ}\text{C}$ with an accuracy of $\pm 2^{\circ}\text{C}$. The integrated ambient light sensor operates with a 360 nm to 970 nm spectral bandwidth and with peak sensitivity at a wavelength of 570 nm. The humidity sensor has an operating range of 0 to 100% RH and an accuracy of $\pm 3.5\%$ RH.

An example of sensor parameters from the Web user interface of the 6LoWPAN WSN is shown in Table 2. Each sensor node is listed with the accompanying information of the latest sensor data as well as the time of the sensor readings.

TABLE 2: Sensor node readings

Name	Last Data	External	Temperature	Humidity	Light
● B 308A	10:44:17 am		21.9 °C	28.5 %	98 lux
● H 310	10:44:01 am		22.5 °C	27 %	355 lux
● J 310B	10:38:58 am		18.9 °C	34.1 %	307 lux
● KJ 313	10:44:12 am		22.8 °C	27.3 %	84 lux
● LAB 301	10:44:09 am		22.8 °C	27.7 %	29 lux
● LAB2 301	10:34:05 am		23.8 °C	24.6 %	135 lux
● M 306	10:44:10 am		21.9 °C	27.6 %	120 lux
● O 309	10:34:02 am		18.9 °C	31.7 %	47 lux
● R 308	10:44:54 am		17.7 °C	37.3 %	776 lux
● SERVER 312A	10:44:06 am		12.4 °C	45.6 %	7 lux

Fig. 3 shows a chart of the temperature information from all sensor nodes in the 6LoWPAN wireless network over a period of 6 hours. The "high" frequency variation of temperature in the server room 312A is due to server functioning and ventilation fans. The temperature data are shown with a maximum, current, and minimum value. In a similar way the humidity information for the sensor nodes may be presented.

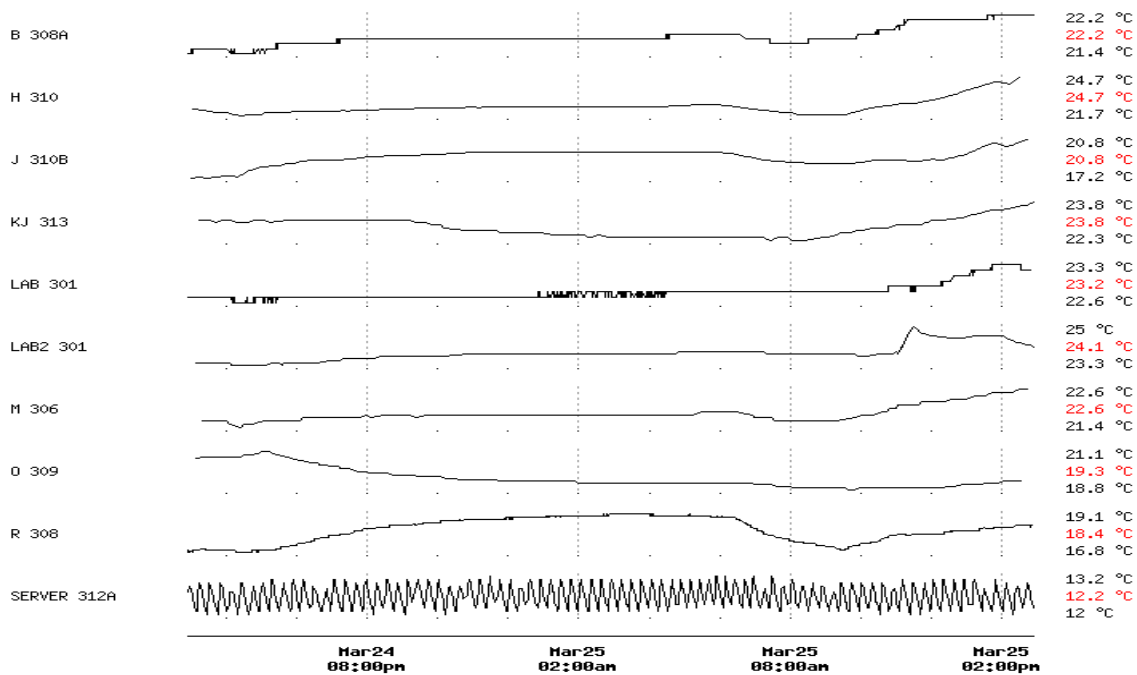

FIG. 3: Temperature readings of 6LoWPAN Sensor Nodes

Readings from the light sensors are shown in Fig. 4. The curve representing illuminance data from node LAB2 301 shows a pronounced change in the shape at a point in time between 10:00 am and 00:00 pm. In this relevant period a desk lamp was switched on and off. The lamp was controlled remotely from the Web user interface using this particular sensor node in combination with an external relay attached to the node.

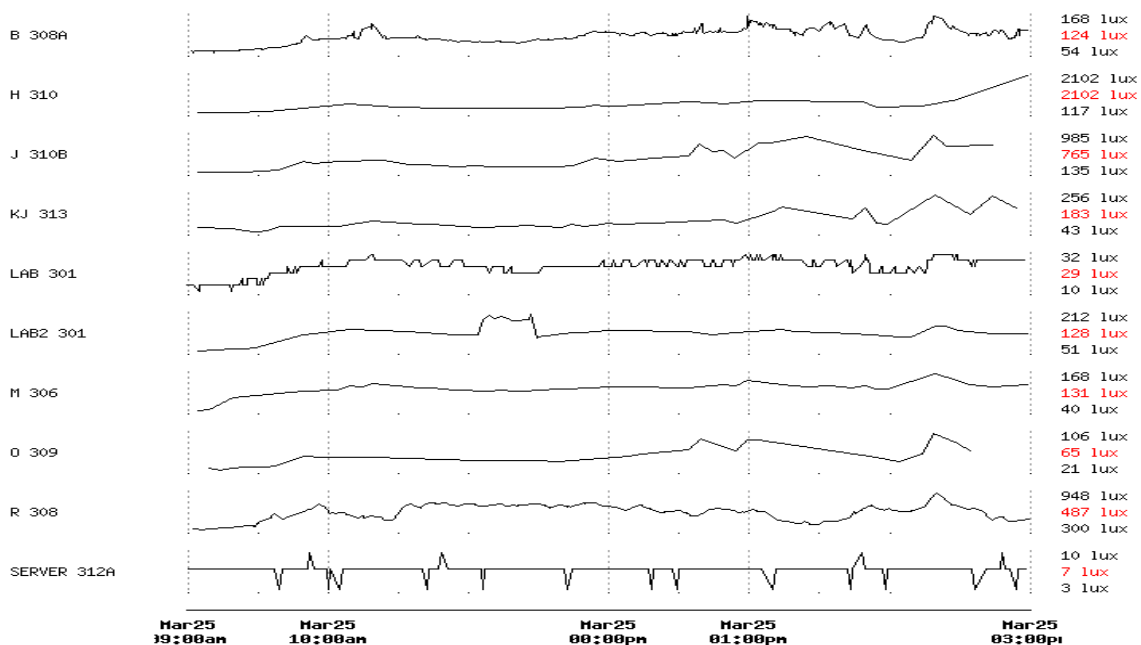

FIG. 4: Illuminance readings of 6LoWPAN sensor nodes

An example of sensor data such as humidity, light and temperature from a selection of the ZigBee nodes is given in Fig. 5. These types of data may be used for decisions whether actions to reduce energy should be taken or not.

Other ZigBee node data, presented in right part of Fig. 5, are offered by a combined power switch and energy meter that supplies information associated with the electrical equipment plugged into this ZigBee device. The information includes current consumption (A), frequency (Hz), load (W), voltage level (V), and power consumption (work) (Wh).

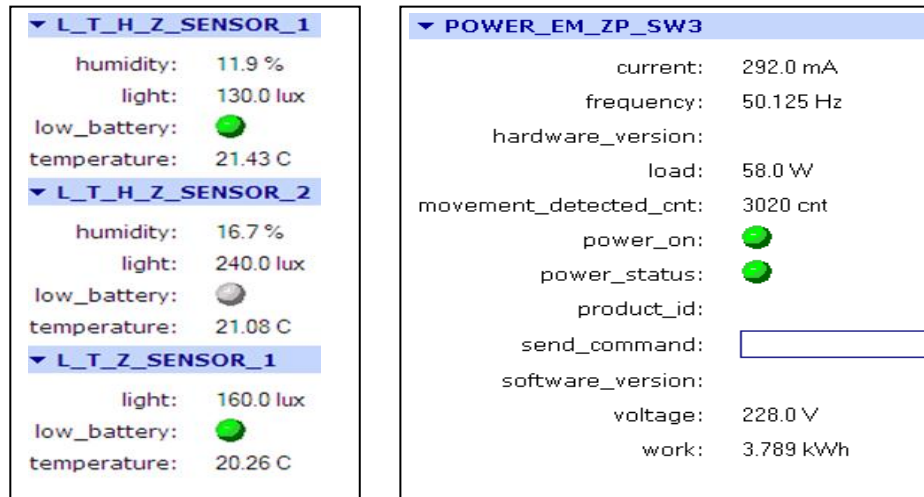

FIG. 5: Sensor data and energy measurements from ZigBee node

3.3 Network Monitoring

In order to monitor and maintain the condition of the WSN it is necessary to have access to information about the actual network and the communications between the different elements of the network. Important information for the setup of the system, deployment of the network, connectivity, health and reliability of the communication can be accessed from the Web user interface of each sub-network.

TABLE 3: Communication traffic for 6LoWPAN nodes

6LoWPAN Node Names	Traffic					
	Radio Packets Sent			Radio Packets Received		
	Total Packets	Current packets/min	Average packets/min	Total Packets	Current packets/min	Average packets/min
All Nodes	924206	22.45	62199083.52	775223	22.34	63352929.97
B 308A	132216	2.9	3.33	21237	0.29	0.57
H 310	91217	1.08	2.3	68041	0.41	1.72
J 310B	70265	1.21	1.76	44287	0.66	1.1
KJ 313	60569	1.11	1.56	27824	0.2	0.74
LAB 301	120618	3.14	3.02	12310	0	0.33
LAB2 301	82072	1.04	2.06	54432	0.22	1.36
M 306	73967	3.02	1.84	47917	2.44	1.19
O 309	49114	1.05	1.23	18673	0.38	0.47
R 308	126935	2.85	3.17	24355	0.35	0.61
Router_01	2903	0	0.6	74151	5.45	7.39
Router_02	4360	0.03	0.23	335822	8.69	10.45
SERVER 312A	109961	5.02	2.83	46174	3.24	1.22

Network information about the communication traffic in the 6LoWPAN WSN is shown in Table 3. Data concerning sent and received radio packets are shown for each node in the table. The reliability of the 6LoWPAN network represented by event success rate and link success rate is shown in Table 4. The data in these two tables were collected from the Web user interface of the system.

TABLE 4: Reliability information of 6LoWPAN network

6LoWPAN Node Names	Reliability						
	Success Rate			Events Received		Events Missed	
	Event Success Rate [%]	Current Link Success Rate [%]	Average Link Success Rate [%]	Current Events/min	Average Events/min	Current Events/min	Average Events/min
All Nodes	67.668			31.4	36339385.75	18.4	17502938.83
B 308A	49.081	98.43	98.48	6.8	4.3	2	4.42
H 310	49.358	100	99.42	1.6	0.8	5.6	0.83
J 310B	79.732	100	97.85	0.4	1.28	0.4	0.33
KJ 313	68.726	100	97.59	0.8	1.1	0.8	0.5
LAB 301	67.623	100	97.73	4	5.86	6.4	2.8
LAB2 301	53.432	100	99.43	0.4	0.86	0.8	0.75
M 306	70.525	97.76	98.44	0.4	1.12	0	0.47
O 309	48.667	100	98.65	0.4	0.78	0	0.83
R 308	67.668	98.04	98.38	2.8	5.97	2	2.84
Router_01	77.674	0	98.53	2.4	5.14	0	1.46
Router_02	95.244	100	99.47	9.4	10.31	0	0.53
SERVER 312A	72.067	90.48	97.22	2	3.46	0.4	1.33

In addition to the statistical network information given through the Web user interface, the Network Analyzer connected to the LAN shown in Fig. 1 gives information about the connectivity and packet traffic in the sub-systems. This commercially available analyzer, which can be used for analysing, testing, commissioning, and maintaining wireless embedded networks, is deployed in the system. It is able to capture and perform active analysis of the ZigBee or the 6LoWPAN WSN when joining either of the sub-networks.

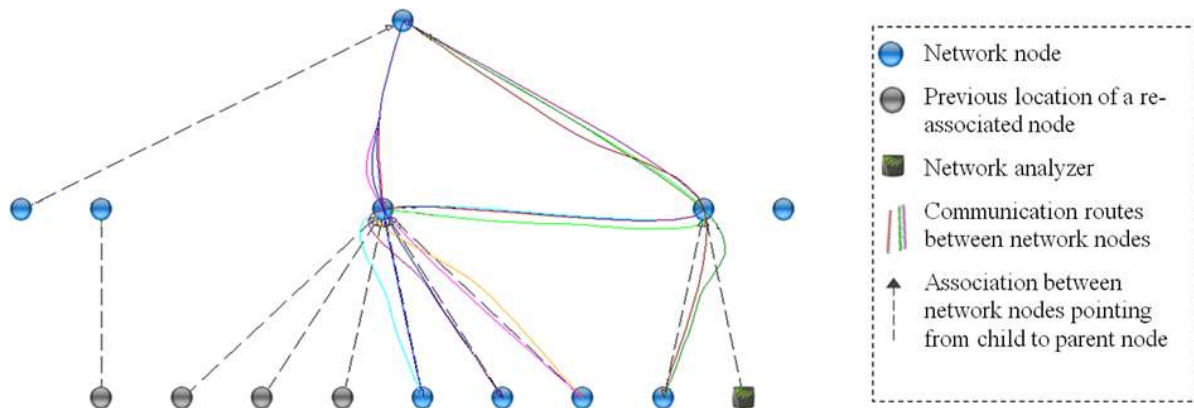

FIG. 6: Network topology and traffic routes (Please note that node names and MAC addresses were excluded from this figure to improve readability).

The network topology in Fig. 6 presents a figure from the ZigBee WSN. The coordinator, i.e. the ZigBee gateway, is placed at the top, then some router nodes are displayed in the middle layer, and sensor nodes (end devices) are placed at the bottom of the topology. The lines represent communication paths between these nodes at a particular point in time with an optional possibility (not used here) of showing the number of packets transmitted/received. The purpose of the line colours is to distinguish between the various communication routes. At this specific time the two blue nodes not connected to the coordinator do not have an association link to a child or parent. The grey nodes represent the previous location of a node that has lost its association in the network. The grey arrows from those nodes point to the new location of the node that has re-associated with another device. When placing the mouse cursor in the analyser software over one of the nodes in such a network topology, more information related to health and measurements of this particular element are presented. Observation of the nodes and the packet routes, as shown in Fig. 6 supports an understanding of the behaviour of

the network, thus simplifying systems troubleshooting. Other measurements from the analyser supply information about transmitted and received packets in the MAC and the Network Layer, latency, lost packets of the Network Layer, and transmitted and received packets from the Application Support Sub-Layer (APS). This information may also be used to analyse the health and operability of the network.

Other issues important for the network operation include energy information related to the power level of the sensor node batteries. Each of the 6LoWPAN sensor nodes needs two 1.5V AA batteries. When the battery level becomes lower than 2.7V a warning related to that specific sensor node shows up at the Web user interface. The sampling rate was set to one sample every five minutes and the sensor nodes were placed in offices as close as possible to the routers. The reason for this was to avoid, as far as possible, multiple hops between the nodes and the routers, which is more energy intensive. In a similar way the sensor node information regarding the battery level of the three AA 1.5V batteries in the ZigBee nodes is illustrated on the Web page, as can be seen in Fig. 5. The low battery indicator turns from grey to green when it is time to change the sensor node's batteries. These nodes are programmed to sleep between the sensor readings to reduce power consumption.

3.3.1 Connectivity and Reliability Survey

To succeed in deploying the wireless sensor network in the offices, it is important to make sure that the packets of data are successfully delivered between the nodes in the system. The distance between the transmitter and receiver, building structure and interference are some of the issues affecting the signal attenuation in the wireless sensor network communication. In literature several researchers (e.g. Guinard et al, 2009) presented optimization methods for optimal WSN deployment in the built environment. Interesting metrics for assessing reliability in building applications are RSSI (Received signal strength indication), LQI (Link quality indication), Packet delivery rate (PDR), and packet error rate (PER) (Jang and Healey, 2010). The reliability of the 6LoWPAN WSN has been investigated with one router and 9 sensor nodes deployed in the network since the other router and one sensor node stopped functioning. The server and router were moved from room 310 to the laboratory 301, see Fig. 2. The measurements are obtained from the Web user interface of the network. Two types of tests are presented. First seven sensor nodes were placed at the same table as the router to not interfere in the communication with the two sensor nodes used in the test. These were placed in the same distance from the router, but in different locations. Sensor node B was located in one of the offices while sensor node A was located in the corridor outside the particular office. The Signal Strength [dBm] of the sensor nodes and the Link Success [%] which is defined as the number of successfully sent packets divided by the number of send attempts between a node and its parent were measured. The results are presented in Table 5. The distance between the router and the two sensor nodes were increased, and the signal strength was seen to be weaker the larger distance, and the more walls the radio signal were passing through. At a distance of 20m the sensor nodes were out of range for communication and a new sensor node, C, were placed in the corridor between the router and the nodes A and B. This sensor node was then passing signals from Router_01 to A and B and we also saw the multi-hop communication when the sensor node inside the office, B, was receiving its signals from both A and C. More sensor nodes were placed out in the corridor to study the connectivity between the nodes.

In the second test the server and router were still placed in the laboratory 301. The sensor nodes were located in the offices, kitchen, and server room as can be seen from Fig. 2, except for the one not functioning (room 310). The distance from the router to each sensor node were measured and is showed in Table 6. This table also shows information of current, minimum and maximum values obtained during 1 day of measurements from the Web user interface regarding Parent signal strength, Link success rate (number of successfully sent packets divided by the number of send attempts) and distance from the sensor node to its parent. Not surprisingly, the results showed that the longer distance between the transmitter and receiver, the weaker Average Parent Signal Strength. However the number and types of walls and building equipment also affects the signal strength. As an example, the "Server 312A" with a distance of 9m from the router has poorer signal strength than the "M 306" with a 10 m distance. The reason for this is that the Room 312A is a server room with brick walls, ventilation equipment and metal racks containing servers. According to Jang and Healey, 2010, metallic materials and brick walls create an environment with lower range of reliability than for instance plywood, and gypsum. As previously stated, optimization methods can be used to determine the best node location once environment design is available e.g. from a BIM (Building Information Modeling).

TABLE 5: Signal Strength and Link Success for sensor nodes placed in varying distance from the router.

Sensor node	A	B	C	D	E	Comments
Distance to router [m]	6	6				A is in the corridor. B is in an office (304).
Signal Strength [dBm]	-66	-64				
Link Success [%]	96	95				
Distance to router [m]	10	10				A is in the corridor. B is in an office (306).
Signal Strength [dBm]	-72	-80				
Link Success [%]	95	92				
Distance to router [m]	15	15				A is in the corridor. B is in an office (307). B is now routed through A.
Signal Strength [dBm]	-72	-55				
Link Success [%]	95	80				
Distance to router [m]	20*	20*	10			A is in the corridor. B is in an office (308A). * The sensor nodes are out of range. Solution: placed C in the corridor at a distance of 10 m. A is routed through C, and B is routed through C and A.
Signal Strength [dBm]	-71	-52	-80			
Link Success [%]	74	82	100			
Distance to router [m]	20	20	10	5		A is in the corridor. B is in an office (308A). C and D are in the corridor. A is routed through C and B is routed through C and A.
Signal Strength [dBm]	-71	-52	-81	-70		
Link Success [%]	86	85	84	100		
Distance to router [m]	20	20	10	5	15	A is in the corridor. B is in an office (308A). C, D and E are in the corridor. A and E are routed through C. B is routed through C and D.
Signal Strength [dBm]	-70	-68	-81	-69	-64	
Link Success [%]	89	89	83	88	84	

A survey option on the Web user interface of the network was used to make each active node broadcast a stream of packets to its neighbours. Information was obtained from the neighbours regarding the received percentage of the packets and average signal strength, and the whole operation of getting these measurements from all sensor nodes lasted for 1 minute and 15 seconds. Metrics from this survey are:

- Success Rate (%) of packets which shows the network reliability on application level and is defined as the number of received events divided by the number of received events plus missed events plus events dropped at the source;
- Mean Signal Strength (dBm) between sensor nodes;
- Link Quality Indication (LQI), showing the strength of the communication link between the nodes. The calculation is based on signal-to-noise ratio or energy density of the signal in the frequency band, and the value has no unit (Jang and Healey, 2010).

The survey measurements between sensor nodes are presented in Table 7, Table 8 and Table 9. The shadowed numbers in the tables indicate the destination nodes with respectively best success rate, mean signal strength or mean LQI for each source node.

TABLE 6: Distance between sensors and router/parent node, and 1-day min/max and current values of measurements of Parent Signal Strength and Link Success Rate.

Sensor Node	Distance [m] to Router_01 / Distance [m] to Parent* node	Current Parent Signal Strength (Min/max values during 1 day) [dBm]	Current Link Success Rate (Min/max values during 1 day) [%]	Parents* during 1 day (current parent)
LAB2 301	0.5/0.5	-53 (-54/-50)	100 (71.4/100)	Router_01
LAB 301	4/4	-56 (-58/-53)	100 (71.4/100)	Router_01
KJ 313	7/7	-77 (-79/-72)	71.4 (50/100)	Router_01
Server 312A	9/9	-80 (-83/-75)	100 (54.6/100)	Router_01
M 306	10/10	-64 (-68/-64)	86.8 (63.6/100)	Router_01
J 310B	16/(9/ 12 /16)	-78 (-84/-71)	100 (83.3/100)	Server 312A/ M 306 /LAB2 301
R 308	17/7.5	-78 (-87/-74)	100 (83.3/100)	M 306
B 308A	21.5/(15/ 11.5 /21.5)	-67 (-85/-66)	90 (68.2/100)	Server 312A/ M 306 /LAB2 301
O 309	24.5/(7.5/ 7.5 /12.5)	-72 (-83/-75)	100 (71.4/100)	J 310B/ B 308A /R 308

TABLE 7: Success Rate (%) of packets obtained from the survey.

Success Rate (%)	Destination Node									
	Source Node	B 308A	J 310B	KJ 313	LAB 301	LAB2 301	M 306	O 309	R 308	Server 312A
B 308A			98		100		100	94	100	72
J 310B	100				94		98			100
KJ 313	100				100	100	100	98	38	100
LAB 301	100	80	100		100	100				100
LAB2 301	40		100	98						100
M 306	100	100	100	96	100			100		100
O 309	100	100						100		
R 308	100	96	100	34		100	98			
Server 312A		100	100	100	100	100				

TABLE 8: Mean Signal Strength (dBm) obtained from the survey.

Mean Signal Strength (dBm)	Destination Node									
	Source Node	B 308A	J 310B	KJ 313	LAB 301	LAB2 301	M 306	O 309	R 308	Server 312A
B 308A			-82		-84		-68	-74	-73	-89
J 310B	-78				-90		-77	-78		-78
KJ 313	-85				-75	-68	-73		-87	-47
LAB 301	-79	-90	-74		-54	-85				-70
LAB2 301	-87		-67	-55						-77
M 306	-66	-80	-75	-88	-76				-77	-85
O 309	-69	-80							-76	
R 308	-69	-88	-86	-92		-74	-76			
Server 312A		-86	-50	-74	-79	-85				

TABLE 9: Mean LQI (Link Quality Indicator) obtained from the survey.

Mean LQI Source Node	Destination Node								
	B 308A	J 310B	KJ 313	LAB 301	LAB2 301	M 306	O 309	R 308	Server 312A
B 308A		105		105		106	107	106	80
J 310B	104			93		106	106		106
KJ 313	88			106	107	106		103	106
LAB 301	104	87	106		107	102			106
LAB2 301	74		106	106					106
M 306	107	106	107	101	106			106	102
O 309	106	106						106	
R 308	107	99	101	80		106	106		
Server 312A		102	107	107	106	103			

4. DATA COLLECTION

The buildings' various temperature, humidity and light values sensed by the sensor nodes and the parameters measured by the energy meters (voltage, current, frequency, power consumption and load) are transmitted to the ZigBee gateway or 6LoWPAN routers and server. These devices are connected to the LAN and the office gateway makes the connection to Internet, see the illustration in Fig. 7.

The 6LoWPAN server stores data from the sensor nodes and statistical information about the WSN. The server is also able to load data into a local or remote PostgreSQL database. The number of sensor nodes in the network, the number of enabled internal sensors in the nodes, and sampling period are important for the quantity of data collected by the WSN. The network information and sensor data stored at the 6LoWPAN server may also be exported in HTML and CSV formats for use in external Web based or other application reports. Settings at the Web user interface control the type and amount of data to be stored or exported.

To make the possibility of remote monitoring of the ZigBee sensor nodes and sensor applications a program written in Python language is used in a Microsoft Windows OS. Using this program, applications may be written in Python scripts where decisions related to issues such as which devices to collect data from and the presentation of the data are made. The applications are then uploaded to the gateway, which acts as a coordinator in the ZigBee network. The gateway stores sensor data from the ZigBee nodes. A Python application running on the gateway connects the gateway to an external server, situated at the vendor's site. This server is then allowed to store the sensor data as XML files.

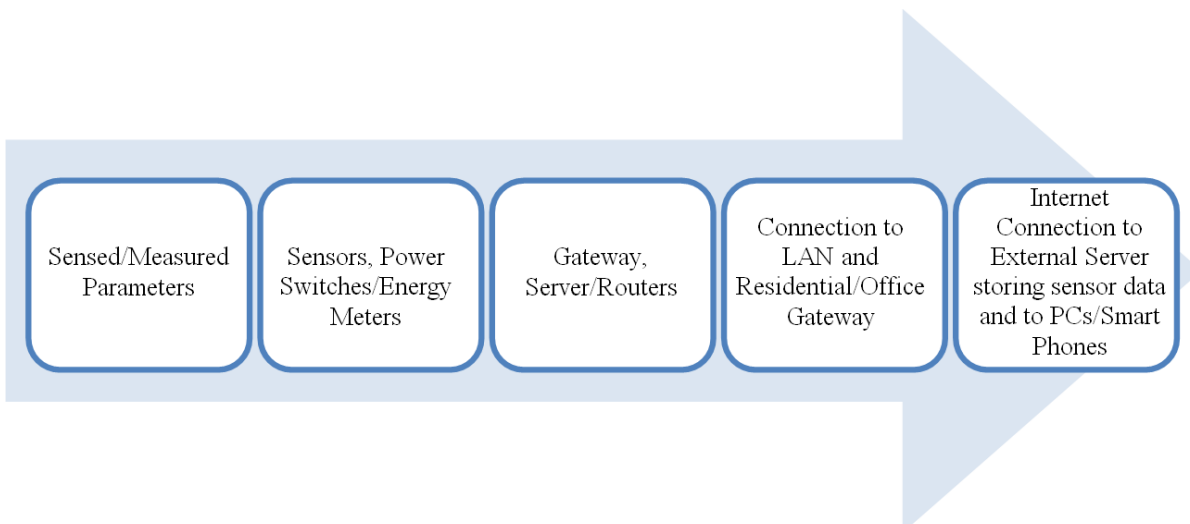

FIG. 7: Simplified data collection flow in the sensor network

5. DATA PRESENTATION

Connecting the IP networking capabilities with sensing devices, actuators and meters enable data exchanges over Web services. It enables building managers to define an architectural model that benefits from the scalability, high availability and open standards already available through the Internet. For smart buildings the use of 'Intranet of Things' can be used to manage communication among (CERP-IoT, 2009):

- 'Things' (e.g. sensors, actuators) to 'things';
- 'Things' to servers, and distributed data repositories;
- 'Things' to end user browsers on computers or Smartphones.

The sensor data from the experimental WSN can be presented in different formats, including charts on the web user interfaces, tables on a Web page and Excel spreadsheets. The sensor network allows building performance data to be gathered, grouped, and analyzed in different profiles.

Fig. 3, Fig. 4 and Fig. 5 show examples of sensor data presentations from the Web user interfaces and application programs. An experimental Web page established to present some sensor data and energy measures is shown in Fig. 8. From this Web page it is possible to control a power switch/energy meter connected to a desk lamp, and the energy measures shown in Fig. 8 are related to this desk lamp. The Web page may also give information from several sensor nodes, and has the ability to present parts of the experimental WSN using a Web camera. The Web page is based on HTML and XML files, and could be expanded to display data from several sensor and energy metering devices. Sensor node data has also been visualized using Google gadgets placed on a PC's desktop to create Web services.

The data captured by the WSN can be used to present an aggregated view of energy consumption data for the monitored area, as well as its maintenance and operation costs (Menzel et al, 2008). In addition the sensor information about energy consumption can be disaggregated and the results can be compared.

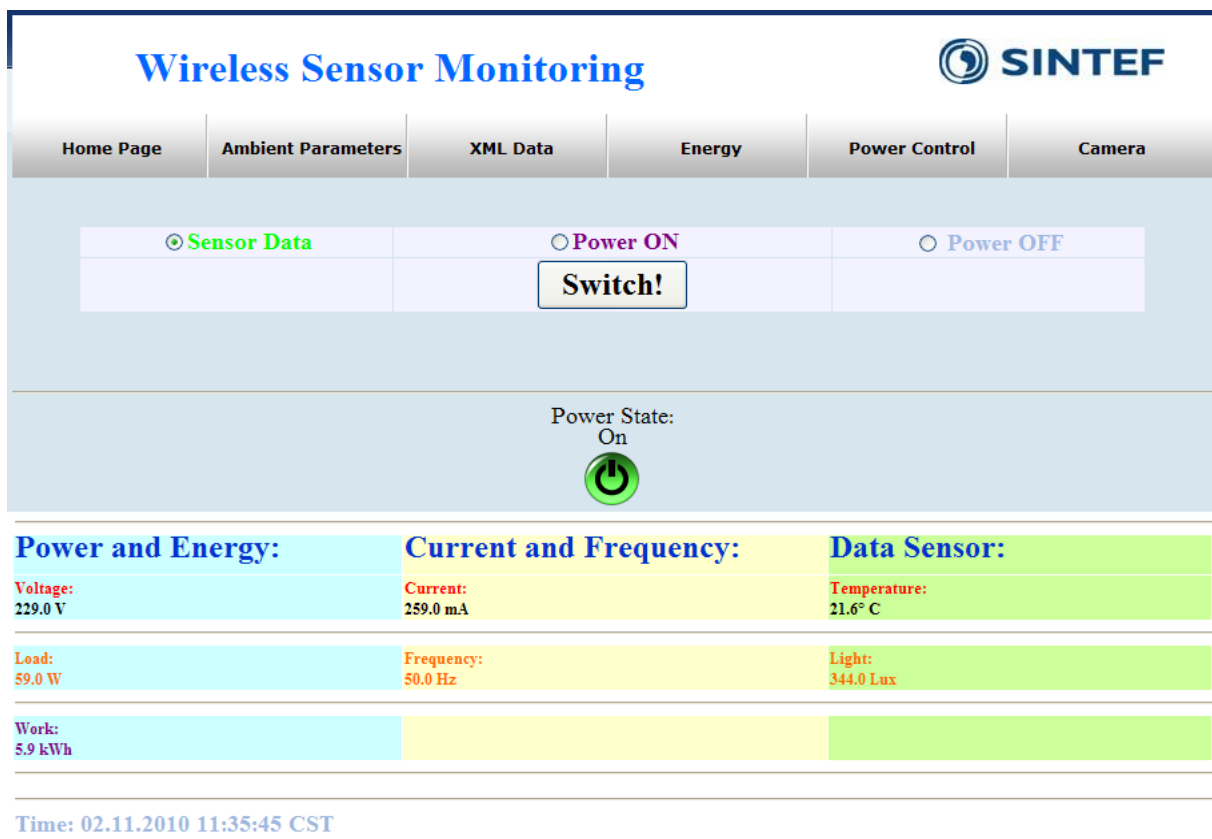

FIG. 8: Web site presenting sensor node data

6. SYSTEM EVALUATION

Setting up the WSN was not that straight forward as one could hope for. Starting with the 6LoWPAN WSN problems were experienced when trying to connect the routers to the deployment. Examination showed that the firmware originally installed in the server, routers and sensor nodes were of different versions with no compatibility. From the manufacturer's support group the latest firmware versions were downloaded and using the Web UI we managed to install new firmware for the server, the two routers and the ten sensor nodes. This was quite time-consuming, especially when upgrading the sensor nodes over-the-air. Installing the ZigBee WSN showed similar problems with the deployment as experienced with the 6LoWPAN WSN, when trying to associate the sensor nodes in the network. The latest firmware for the gateway and for the sensor node modules were downloaded from an ftp-server at the support group. The files were uploaded to the gateway via the Web UI. From support we also got an installer tool for the network connected PC to configure the sensor nodes. The controller module was removed from the five ZigBee sensor nodes, and one at a time were mounted on a serial board, suitable for the purpose, connected to the USB port on the computer via a serial to USB converter cable. The installer tool were used to change the settings of firmware, function set, version, device type parameter and PAN ID for all the modules before they were replaced in the sensor nodes. The ten ZigBee power switches/energy meters from a different manufacturer also needed upgrading of the firmware. The files received were uploaded to the gateway and a command written in the terminal window of the PC started the over-the-air update of the devices. The whole process of changing parameters and upgrading the firmware for the sensor nodes and power switches/energy meters were time-consuming.

With wireless systems, it can be difficult to predict the propagation of radio waves and detect the presence of interfering signals. Therefore the work and costs related to the installation and setup of the pilot WSN discussed here involved an RF survey to determine the original setup of the server, router and gateway devices, which specified the number and ID numbers of the sensors, and the physical connection of the different modules.

The pilot system was implemented and tested using one local server, two routers, which during the test period were reduced to one, ten 6LoWPAN sensor nodes, one gateway, one external server and fifteen ZigBee (normal and PRO) nodes which are distributed on one floor as shown in Fig. 2. A building floor plan was imported into the web interface of one of the networks to support the analysis conducted to determine how to distribute the sensor nodes. Connectivity and reliability measurements using metrics such as Signal Strength, Success Rate, Link Success Rate and Link Quality Indicator (LQI), such as the examples from the test of the 6LoWPAN WSN reported in section 3.3.1 showed that the sensor node placements affected the link quality and signal strength both due to the distance between the router and the sensor nodes, the distance between the sensor node locations, the number of sensors in the network, and physical obstructions such as walls, metal racks etc. Moving the sensor nodes closer to the router or extending the network with more sensor nodes increased the reliability of communication. Possible interference from other wireless communication using the same frequency was not investigated in this case study.

The case study of the WSN focused on parameter measurements, network operation and routine reporting, and tests and measurements observations were conducted several times a week. The parameters and consumption values are updated several times per hour and the time interval can be programmed. Challenges due to the battery usage of the sensor nodes which led to frequently battery replacements, were solved by programming the ZigBee sensor nodes to sleep between the sensor readings and specify the sampling rate of the 6LoWPAN sensor nodes to be five minutes. The two wireless sensor networks used in this case study have, with exception of a few periods of downtime of the Local Area Network due to maintenance, been running continuously after the implementation and the sensor nodes have delivered their measurements. Remote access to the measurement values enables completely new services, such as accurate daily billing, diagnoses or statistics for the area/building that is monitored. Exportation of sensor data from the servers and gateway to the adapted experimental Web page shows a possible method of viewing sensor data on a single Web site. The system also allows the use of Google gadgets to present the information on the PC/Smartphone desktop, and monitor and visualise the sensor data and/or control the actuators. Mobile devices such as the Smartphones provide interaction capabilities for Web browser applications that could be used for energy awareness applications. These could be used to provide playful access to detailed and real time information on the energy consumption of different appliances in households, buildings or offices.

The test results show that the system can:

- Report the temperature, humidity and light, in the monitored area;
- Report the current, voltage, frequency, power use, and energy consumption of electrical appliances;
- Control the actuators/switches for measuring energy consumption;
- Monitor in real time;
- Switch different electric appliances on or off;
- Self organize;
- Export sensor data for use with external applications.

Home automation applications demand simple control and monitoring, and very low cost and low power solutions. Typical data rates are in the range of 1-250 kbps. The concept proposed can easily include 50-200 sensors/actuators and smart metering wireless nodes, that can be used for applications such as energy measurement, remote lighting control and remote heating control.

7. CONCLUSIONS

This paper presented the case study and initial testing of a wireless sensor network (WSN) to support energy management utilizing Web services and middleware technologies. The experimental work presented illustrates that a combination of commercially available WSN from different vendors operating with several communication standards can be employed to monitor and measure real time data such as temperature, light, humidity and power consumption. A single Web site was developed to illustrate the concept of how monitoring sensor parameters and energy measures stored in different repositories could be used. This demonstration illustrated that it is possible to remotely switch on/off electrical appliances from this Web site utilizing the integrated Web user interfaces of each of the WSNs. The open architecture of the concept allows for easy and continuous updates and unlimited expandability. Therefore, the model's design allows for its application in a large number of building categories.

The capabilities offered by the type of wireless sensor system presented in this paper are vast. They provide the managers, owners and inhabitants of buildings feedback on the energy consumption of buildings to support improved building control and inhabitant behavioural change. Improvements in the systems sensors could also be integrated into the type of WSN discussed in this paper to supply more detailed information to building occupants. For example, as part of the IntUBE project a new IR vision monitoring system for radiating temperatures and heat fluxes based on infrared imaging has also been developed (Revel et al, 2012). This could be integrated in similar WSN to provide additional information and remote functionalities such as number of occupants, appliances and window opening, allowing a real-time evaluation of the energy balance of a room. A WSN using the IR vision system, developed within the IntUBE project, is capable of supporting energy saving initiatives designed to encourage changes in inhabitants' behaviours. Such initiatives could include supplying information (e.g. displayed on a Web interface) about the use of mechanical ventilation systems and window opening and /or by making visible the energy used by appliances and equipment needlessly left running.

However, currently we lack an understanding of why building inhabitants given the same direct energy feedback in the same format can react very differently, with some increasing their energy consumption and some reducing it by almost 40% (Parker et al, 2008, Wood and Newborough, 2003). This gap in knowledge is related to a lack of research exploring the role of graphic design in the presentation of energy feedback (Fischer, 2008) and which types of data comparisons provide the best motivation to reduce energy demand (Wood and Newborough, 2007). This suggests that further research is required in order to make the best use of the information offered by the types of innovative sensor network presented in this paper. Answers to issues such as frequency and content of energy feedback, level of granularity, visual design, and recommendations for energy efficient actions will be required if these types of WSN are to be used to successfully inform the managers, owner and inhabitants of building about how to reduce their energy consumption.

8. ACKNOWLEDGEMENTS

The research presented in this paper is part of the work of an EU FP7 funded project entitled 'IntUBE – Intelligent Use of Buildings' Energy Information' and SINTEF's financed project 'MODERATES'. The authors would like to thank Lars-Cyrl Julin Blystad, Research Scientist at SINTEF, for valuable comments.

9. REFERENCES

- Baronti P., Pillai P., Chook V. W. C., Chessa S., Gotta A. and Hu Y.F. (2007). Wireless sensor networks: A survey on the state of the art and the 802.15.4 and ZigBee standards, *Computer Communications*, Vol. 30, No. 7, 1655-1695.
- Brambley M. R., Kintner-Meyer M. and Katipamula S. (2005). Wireless Sensor Applications for Building Operation and Management, *Web based energy information and control systems: case studies and applications*, chap 27, edited by Capehart B, L. and Capehart L. C. Fairmont Press, ISBN 0-88173-502-7 (elec.), accessed at <http://www.buildingsystemsprogram.pnl.gov/wireless/publications/PNNL-SA-43465.pdf> [18/11/2010].
- CERP-IoT (2009), Internet of Things Strategic Research Roadmap, accessed at http://ec.europa.eu/information_society/policy/rfid/documents/in_cerp.pdf [18/11/2010].
- Crosbie T., Nashwan D. and Dean J. (2010). Energy profiling in the life-cycle assessment of buildings, *Management of Environmental Quality*, Vol. 21, No.1, 20-31.
- Das, R. (2011), Wireless sensor networks: creating a \$2 billion market in 2021. *Energy Harvesting Journal*, August 2011, accessed at <http://www.energyharvestingjournal.com>.
- Dong Q., Yu L., Lu H., Hong Z. and Chen Y. (2010). Design of Building Monitoring Systems Based on Wireless Sensor Networks. *Wireless Sensor Network*, Vol. 2, No. 9, 703-709.
- European Commission (2008). *Communication from the Commission to the European Parliament, the Council, the European Economic and Social Committee and the Committee of the Regions - 20 20 by 2020 - Europe's climate change opportunity*, accessed at <http://eurlex.europa.eu/LexUriServ/LexUriServ.do?uri=COM:2008:0030:FIN:EN:PDF> [01/4/2010].
- European Commission (2009). *Energy efficiency: What do we want to achieve?*, accessed at http://ec.europa.eu/energy/efficiency/index_en.htm [31/3/2010].
- Fischer C. (2008). Feedback on household electricity consumption: a tool for saving energy? *Energy Efficiency*, Vol. 1, No. 1, 79–104.
- Grondzik W. T., Kwok A. G., Stein B. and Reynolds J. S. (2010). *Mechanical and Electric Equipment for Buildings*, 426, J.Wiley & Sons, ISBN 978-0-470-19565-9
- Guinard A., McGibney A. and Pesch D. (2009). A Wireless Sensor Network Design Tool to Support Building Energy Management, *Proceedings of the First ACM Workshop on Embedded Sensing Systems for Energy-Efficiency in Buildings*, 25-30, Berkeley, CA, accessed at <http://delivery.acm.org/10.1145/1820000/1810286/p25-guinard.pdf?key1=1810286&key2=9224000921&coll=DL&dl=ACM&CFID=114587789&CFTOKEN=66213838>, [17/11/2010].
- Halgamuge M.N., Chan T-K and Mendis P. (2009). Improving Multi-storey Building Sensor Network with an External Hub. *World Academy of Science, Engineering and Technology*, 52, 420-423.
- Higuera J., Polo J. and Gasulla M. (2009). A ZigBee wireless sensor network compliant with the IEEE 1451 standard, *IEEE Sensors Applications Symposium*. New Orleans, LA, USA, February 2009.
- IntUBE (*Intelligent use of Buildings' energy information*) (2009). Project in European Commission, CORDIS, FP7, accessed at ftp://ftp.cordis.europa.eu/pub/fp7/ict/docs/sustainable-growth/fp7-intube_en.pdf [31/3/2010].

- Jang W.-S., Healy W. M. and Skibniewski M. J. (2008). Wireless sensor networks as part of a Web-based building environmental monitoring system, *Automation in Construction*, Vol. 17, No. 6, 729-736.
- Jang W.S. and Healy W.M. (2010). Wireless sensor network performance metrics for building applications, *Energy and Buildings*, Vol. 42, Issue 6, 862-868.
- Kushalnagar N., Montenegro G. and Schumacher C. (2007). *IPv6 over Low-Power Wireless Personal Area Networks (6LoWPANs): Overview, Assumptions, Problem Statement, and Goals*, RFC4919, accessed at <http://datatracker.ietf.org/doc/rfc4919/>, [31/3/2010].
- Lynch J. P. and Loh. K. J. (2006). A summary review of wireless sensors and sensor networks for structural health monitoring, *Shock and Vibration Digest*.
- Lun-Wu Yeh, You-Chiun Wang, Yu-Chee Tseng (2009), iPower: an energy conservation system for intelligent buildings by wireless sensor networks, *International Journal of Sensor Networks*, Volume 5, Number 1 / 2009, pp. 1-10.
- Marchiori A. and Han Q. (2010). Distributed Wireless Control for Building Energy Management. *BuildSys 2010 November 2*, Zurich, Switzerland.
- Menzel K., Pesch D., O'Flynn B., Keane M. and O'Mathuna C. (2008). Towards a Wireless Sensor Platform for Energy Efficient Building Operation, *Tsinghua Science and Technology*, Vol. 13, No.1, 381-386.
- Neves P.A.C.S., Vaidya B. and Rodrigues J.J.P.C. (2010). User-Centric Plug-and-Play Functionality for IPv6-enabled Wireless Sensor Networks. *IEEE International Conference on Communications*. Cape Town, South Africa, May 2010.
- Parker D., Hoak D. and Cummings J. (2008). Evaluating user feedback devices, *Home Energy*, July/ August.
- Ploennigs, J., Vasyutynskyy, V. Kabitzsch, K., Comparison of energy-efficient sampling methods for WSNs in building automation scenarios, *IEEE Conference on Emerging Technologies & Factory Automation*, 2009. ETFA 2009, 22-25 Sept. 2009, Mallorca.
- Revel G.M., Sabbatini E. and Arnesano M. (2012). Development and experimental evaluation of a thermography measurement system for real-time monitoring of comfort and heat rate exchange in the built environment, *Measurement Science & Technology*, 23 (2012) 035005.
- Schor L., Sommer P. and Wattenhofer R. (2009). Towards a Zero-Configuration Wireless Sensor Network Architecture for Smart Buildings, *Proceedings of the First ACM Workshop on Embedded Sensing Systems for Energy-Efficiency in Buildings*, 31-36, Berkeley, CA, accessed at <http://www.disco.ethz.ch/publications/BuildSys09.pdf>, [13/9/2010].
- Song E.Y. and Lee K. (2006). An Implementation of the Proposed IEEE 1451.0 and 1451.5 Standards, *IEEE Sensors Applications Symposium*. Houston, Texas, USA, February 2006.
- Srivastava N. (2010). Challenges of Next-Generation Wireless Sensor Networks and its impact on Society, *Journal of Telecommunications*, Vol. 1, No.1, 128 -133.
- Sweetser D., Sweetser V. and Nemeth-Johannes J. A Modular Approach to IEEE-1451.5 Wireless Sensor Development. *IEEE Sensors Applications Symposium*. Houston, Texas, USA, February 2006.
- Wang W., Wang N., Jafer E., Hayes M., O'Flynn B. and O'Mathuna C. (2010). Autonomous Wireless Sensor Network based Building Energy and Environment Monitoring System Design. *2010 2nd Conference on Environmental Science and Information Application Technology*, Vol. 3, 367-372.
- Wood G. and Newborough M. (2003). Dynamic energy-consumption indicators for domestic appliances: environment, behaviour and design, *Energy and Buildings*, Vol. 35, No. 8, 821-84.
- Wood G. and Newborough M. (2007). Energy-use information transfer for intelligent homes: Enabling energy conservation with central and local displays', *Energy and Buildings*, Vol. 39, No. 4, 495-503.

BLANK PAGE