

MICROCOPY RESOLUTION TEST CHART  
NATIONAL BUREAU OF STANDARDS-1963-A

AD A094172

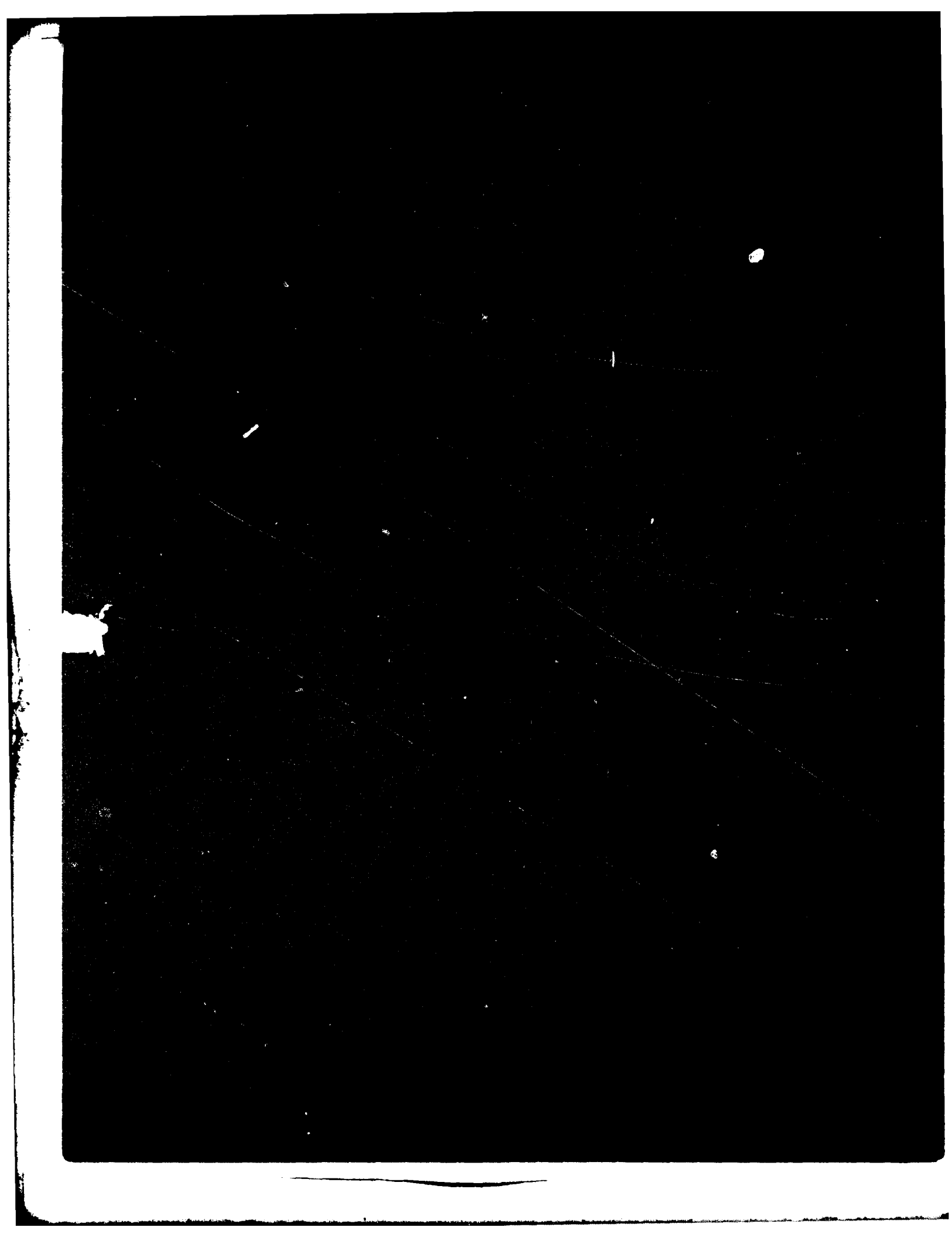

1. Report No. FAA-BU-88-127	2. Government Accession No. AP-A094177	3. Recipient's Catalog No. 11
4. Title and Subtitle Active Beacon Collision Avoidance System (BCAS) Functional Overview	5. Performing Organization Name and Address J.D. Welch and V.A. Orlando Massachusetts Institute of Technology Lincoln Laboratory P.O. Box 73 Lexington, MA 02173	6. Performing Organization Report No. ATC-108
7. Author(s)	8. Sponsoring Agency Name and Address Department of Transportation Federal Aviation Administration Systems Research and Development Service Washington, DC 20591	9. Work Unit No. (TRAILS) Project No. 054-241-04 Contract or Grant No. DOT-FA72 WAI-817
10. Distribution Statement Collision Avoidance DABS Data Link	11. Supplementary Notes The work reported in this document was performed at Lincoln Laboratory operated by Massachusetts Institute of Technology under Air Force Contract F19628-87-C-0002	12. Type of Report and Period Covered 12 44
13. Security Classif. (of this report) Unclassified	14. Abstract The Active Beacon Collision Avoidance System (BCAS) is a beacon-based airborne collision avoidance system that provides for cooperative threat resolution between BCAS and conflicting aircraft and coordination with the ground ATC control function through the DABS data link. All beacon-equipped aircraft in the vicinity of the BCAS are detected. ATCRBS-equipped aircraft are interrogated using a special Mode C interrogation. DABS aircraft are initially detected passively. Those aircraft that represent a possible threat are discreetly interrogated to maintain a range/altitude track. This document provides a functional overview of BCAS including operational features, a description of the avionics package, and examples of surveillance data obtained with experimental BCAS equipment. The results show that reliable surveillance performance is achieved in low and medium density airspace.	15. Sponsoring Agency Code DOT-FA72 WAI-817
16. Security Classif. (of this page) Unclassified	17. Key Words Collision Avoidance DABS Data Link	18. Distribution Statement Document is available to the public through the National Technical Information Service, Springfield, Virginia 22151
19. Security Classif. (of this report) Unclassified	20. Security Classif. (of this page) Unclassified	21. No. of Pages 42
22. Price		23. Price

Accession For	NTIS GRA&I <input checked="" type="checkbox"/>
	DTIC TAB <input type="checkbox"/>
	Unannounced <input type="checkbox"/>
	Justification
By	
Distribution	
Availability Codes	
Dist	A

WAI

207650

SUMMARY

An active airborne beacon-based collision avoidance system (Active BCAS) is being developed by the Massachusetts Institute of Technology Lincoln Laboratory for the Federal Aviation Administration. This effort has led to new techniques for air-to-air interrogation and for processing of replies from existing air traffic control radar beacon transponders to overcome the effects of ground-bounce multipath and signal interference. Experimental Active BCAS units incorporating these techniques have been built and are currently undergoing flight testing. Results indicate that highly reliable surveillance performance is achieved in low and medium density airspace.

## INTRODUCTION

In recent years the development of airborne collision avoidance systems has focused on concepts that make use of the transponders carried for ground ATC purposes and hence do not impose the need for special avionics on board the detected aircraft. Such systems have the advantage that they can provide immediate protection against collisions involving a significant and growing fraction of the aircraft population.

The simplest way of using ATC transponders for airborne collision avoidance is to transmit air-to-air interrogations. The system based on this technique, known as Active BCAS, is designed to provide protection against aircraft equipped with both the current (ATCRBS) and planned (DABS) air traffic control transponders.

#### AIR TRAFFIC CONTROL RADAR BEACON SYSTEM

The operation of the current Air Traffic Control Radar Beacon System (ATCRBS) is illustrated schematically in the figure. ATCRBS uses simple two-pulse interrogations transmitted from a rotating antenna. Two types of interrogations are used for civil transponders: Mode A which elicits one of 4096 identity codes; and Mode C which elicits a similar 12-bit code containing the aircraft's barometric altitude, referenced to standard atmospheric conditions.

Since all equipped aircraft in the antenna mainbeam respond to each ATCRBS interrogation, it is common for replies from aircraft at nearly the same ranges to overlap each other at the interrogator receiver. This phenomenon is called synchronous garble. It is controlled in the ground system by using a narrow antenna beamwidth and by restricting each sensor to the absolute minimum range required for air traffic control purposes.

At short ranges, the signal strength may be sufficient to interrogate transponders via leakage through the antenna sidelobes. To control this phenomenon, aircraft in the antenna sidelobes are prevented from replying by a technique known as transmit sidelobe suppression. The P2 pulse of the interrogation is transmitted on an omni-directional antenna at a slightly higher power level than the interrogator power produced by the antenna sidelobes. Transponders are designed to reply only if the received P1 pulse is greater than the received P2 pulse. This condition is not satisfied in the sidelobes of the antenna.



# AIR TRAFFIC CONTROL RADAR BEACON SYSTEM ATCRBS

104573-N

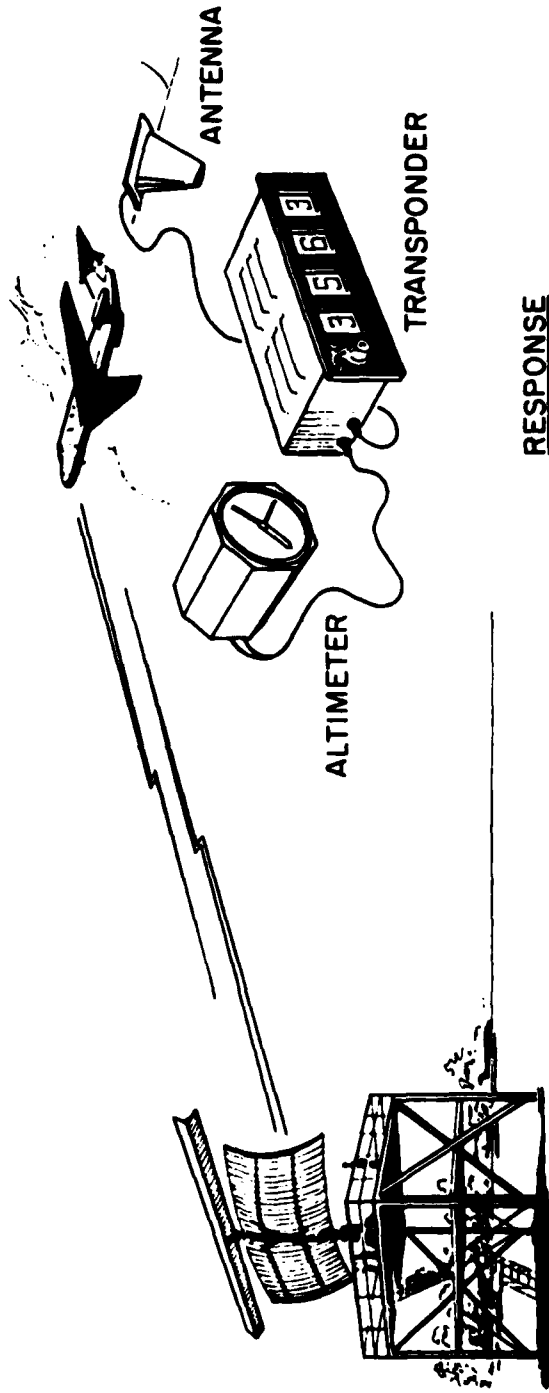

## INTERROGATION

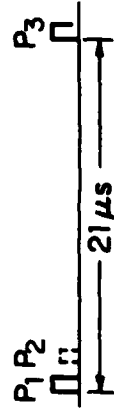
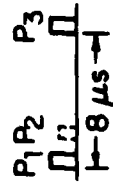

## RESPONSE

### IDENTIFICATION CODE

3563

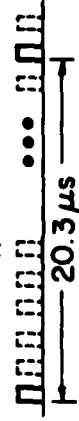

### ALTITUDE

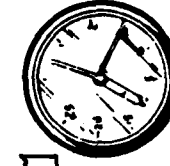

#### DISCRETE ADDRESS BEACON SYSTEM

The discrete address beacon system [1] was developed as an evolutionary improvement to the ATRCBS system to enhance air traffic control surveillance reliability and to provide a ground-air-ground digital data communication capability. Each aircraft is assigned a unique address code which permits data link messages to be transferred along with surveillance interrogations and replies.

Like ATRCBS, DABS will locate an aircraft in range and azimuth, report its altitude and identity, and provide the general surveillance service currently available. However, because of its ability to selectively interrogate only those aircraft within its area of responsibility, DABS can avoid the interference which results when replies are generated by all the transponders within the beam. Even more importantly, if DABS schedules its interrogations appropriately, responses from aircraft will not overlap each other at the receiver.

The DABS signal formats are illustrated in the figure. DABS uses the same frequencies as ATRCBS for interrogations and replies (1030 and 1090 MHz, respectively). The DABS interrogation consists of a two-pulse preamble plus a string of 56 or 112 data bits (including the 24-bit address) transmitted using binary differential phase shift keying (DPSK) at a 4 Mbps rate. The preamble pulses are 0.8  $\mu$ sec wide and are spaced 2.0  $\mu$ s apart. An ATRCBS transponder which receives the interrogation interprets this pulse pair as an ATRCBS sidelobe suppression, causing it to be suppressed for the remainder of the DABS interrogation. Without such suppression, the following DABS data block would, with high probability, trigger ATRCBS transponders causing spurious replies.

The reply also comprises 56 or 112 bits including address, and is transmitted at 1 Mbps using binary pulse-position modulation (PPM). The four-pulse reply preamble is designed to be easily distinguished from an ATRCBS reply sequence. It can be reliably recognized and used as a source of reply timing even in the presence of an overlapping ATRCBS reply, while at the same time achieving a low rate of false alarms arising from multiple ATRCBS replies.

The DABS parity coding scheme is designed so that an error occurring anywhere in an interrogation or a reply will modify the decoded address. If there is an error on the uplink, the transponder will not accept the message and will not reply, as the interrogation does not appear to be addressed to it. If there is an error on the downlink, the interrogator will recognize that an error has occurred, since the reply does not contain the expected address. This error detection feature along with the ability to reinterrogate a particular aircraft if a reply is not correctly received gives DABS the required high surveillance and communications reliability.

# DABS INTERROGATION AND REPLY WAVEFORMS

104558-N-01

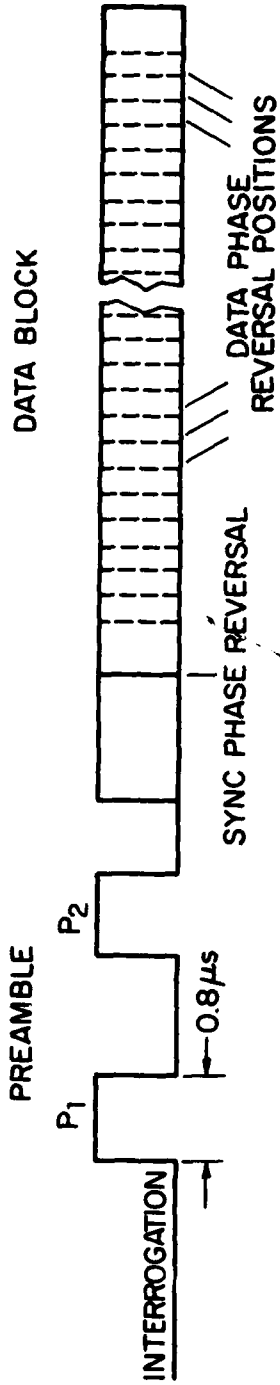

## INTERROGATION

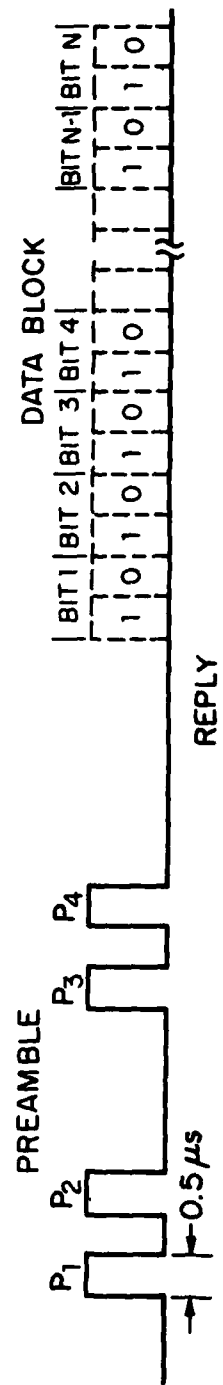

### ACTIVE BCAS

Active BCAS [2] alternates between DABS and ATRCBS surveillance modes. In its simplest form the Active BCAS equipment uses non-directional antennas; hence surveillance data consist of range and altitude information only. Because of this, the threat detection and resolution logic must limit its pilot maneuver advisories to the vertical dimension. These include CLIMB, DESCEND, DON'T CLIMB, DON'T DESCEND, LIMIT ALTITUDE RATE and MAINTAIN ALTITUDE RATE advisories.

The availability of an air-air link allows Active BCAS to interact differently with the three classes of detectable aircraft, depending on how the aircraft is equipped.

If the detected aircraft is BCAS equipped, it is possible to prevent ties in the selection of an escape maneuver, thereby insuring that both aircraft maneuver in a complementary way to give the greatest separation for a given threat warning time.

If the detected aircraft is equipped with a DABS transponder, the DABS data link provides knowledge of the speed capability of the detected aircraft and allows the BCAS-equipped aircraft to transmit its own maneuver intent.

If the detected aircraft is only equipped with an ATRCBS Mode C transponder, there is no way to coordinate maneuvers. Thus separation is the entire responsibility of the BCAS-equipped aircraft; and there is a possibility of an unexpected maneuver by the ATRCBS aircraft.

The operation of Active BCAS does not require ground equipment. However, where appropriate ground units are available, the operation of airborne BCAS equipment can be automatically coordinated with the air traffic control system. The DABS transponder on board the BCAS aircraft is used for communicating with DABS ground sensors and is the principal means for coordinating with ground air traffic control (ATC) in areas of DABS coverage. Where there is no DABS ground sensor, BCAS can communicate with a special unit on the ground known as an RBX. The RBX may be used for coordination with air traffic control facilities. The Automatic Traffic Advisory and Resolution Service (ATARS) is a ground-based collision avoidance service which employs a DABS ground sensor for aircraft surveillance and ground-air communications. Provisions are included in the BCAS airborne equipment for coordinating with ATARS when in areas of ATARS coverage.

# ACTIVE BCAS SYSTEM DESCRIPTION

104574-N

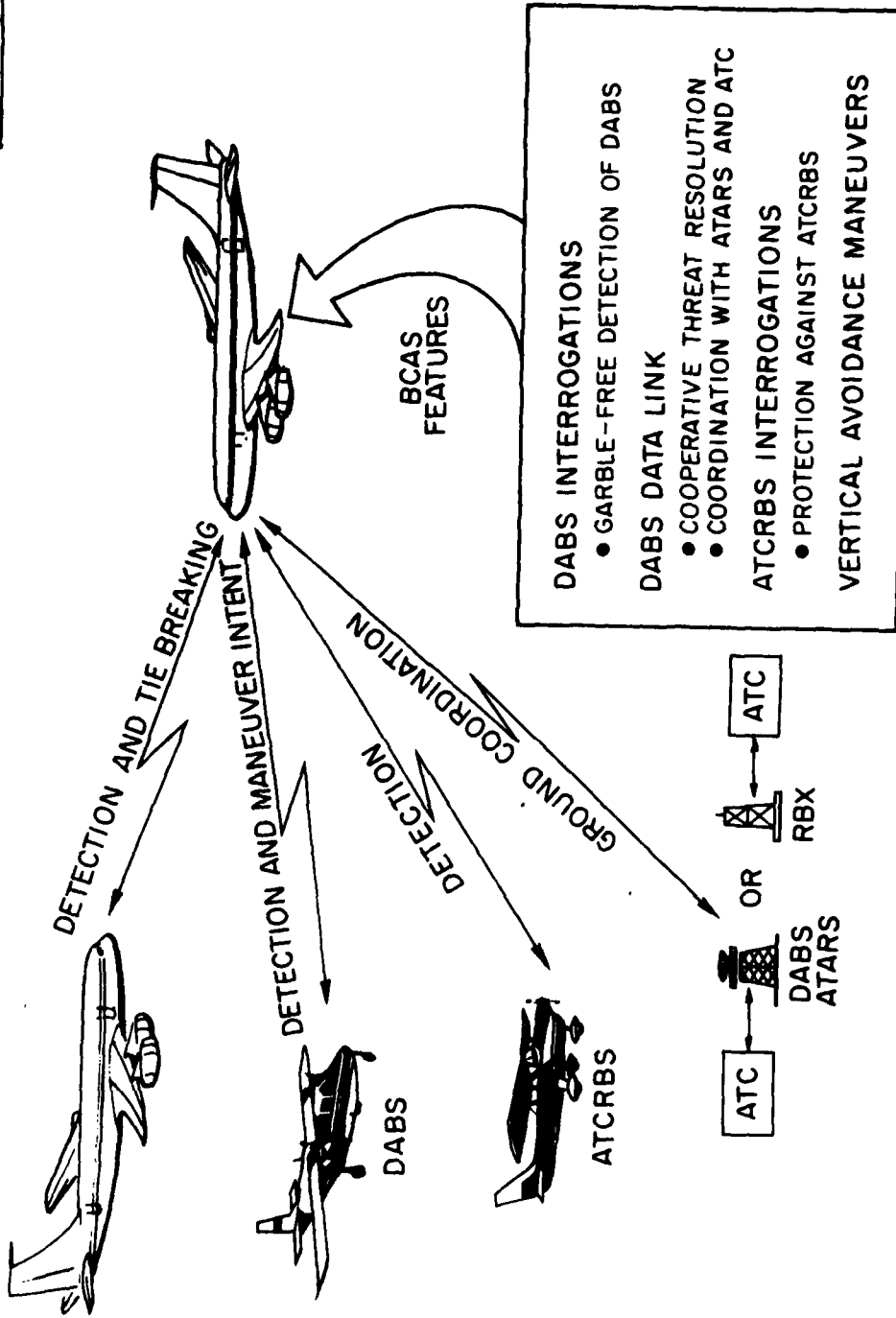

## ACTIVE BCAS AVIONICS

The Active BCAS avionics package has the capability of detecting nearby aircraft, evaluating their threat potential, and then resolving declared conflicts. Specific functions required to do this are shown in the figure.

Dual Antenna Installation - The BCAS unit and the DABS transponder both employ top and bottom-mounted antennas.

DABS Transponder - Supports ATC surveillance, detection and coordination with other BCAS aircraft and ATARS and ATC coordination .

ATCRBS Surveillance - Active transmission of special Mode C interrogations elicits replies from ATCRBS transponders and tracks them to develop range and altitude rates.

DABS Surveillance - DABS aircraft are acquired passively through spontaneous (squitter) transmissions emitted periodically by all DABS transponders. Potentially threatening aircraft are discretely interrogated to develop a track in range and altitude.

Air-Air Data Link - This link is used for tie prevention and the transmission of maneuver intent. Other uses include transmission of aircraft speed capability for use in reducing the interrogation rate for distant (non-threatening) aircraft.

Collision Avoidance Algorithms - Surveillance and data link information developed as described above is evaluated by the collision avoidance algorithms to determine the presence of potential collision threats. Declared threats are resolved by means of altitude maneuver advisories presented to the pilot on the BCAS display. This process is performed cooperatively with BCAS and DABS aircraft and with ATARS in ATARS coverage zones.

Cockpit Display - A common display may be used for BCAS and ATARS maneuver advisories. The nature of the advisories differs for the two modes. Display of target parameters such as range, altitude, and bearing is also feasible.

# ACTIVE BCAS ELEMENTS



BCAS ON BOARD AVIONICS

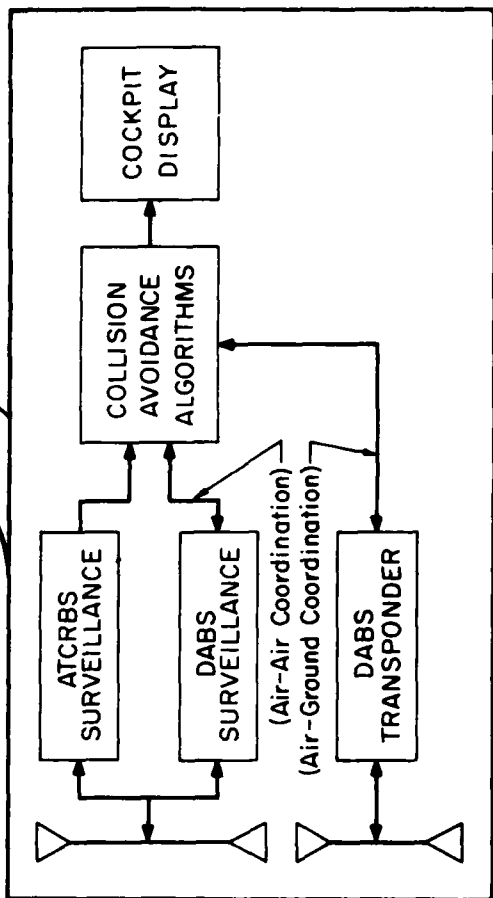

### SENSITIVITY LEVEL CONTROLLED

- MANUALLY
- BY DABS ON GROUND
- BY RBX

### BCAS ADVISORIES

- DESCEND
- CLIMB
- DON'T DESCEND
- DON'T CLIMB
- LIMIT ALTITUDE RATE
- MAINTAIN ALTITUDE RATE

### ACTIVE BCAS OPERATION

In operation, Active BCAS alternates between DABS and ATRBS interrogations to provide updates to the collision avoidance algorithms. At any moment, the BCAS performs surveillance on aircraft in several threat categories; from simple detection of non-conflicting aircraft to full range/altitude tracking for potentially threatening aircraft. The collision avoidance parameter values to be applied for conflict declaration may be adjusted manually by the pilot, or automatically by an on-board aircraft control, or under ground control to conform to the traffic situation. In the event of a detected threat, the sequence of events is conditioned by the type of equipment on board the threat.

A typical sequence of events for a BCAS/DABS encounter is presented in the figure. In this illustration, one or both of the aircraft are outside of the ATARS coverage zone, allowing the airborne BCAS system to assume responsibility for resolving the conflict.



EXAMPLE OF BCAS - DABS ENCOUNTER

104568-N

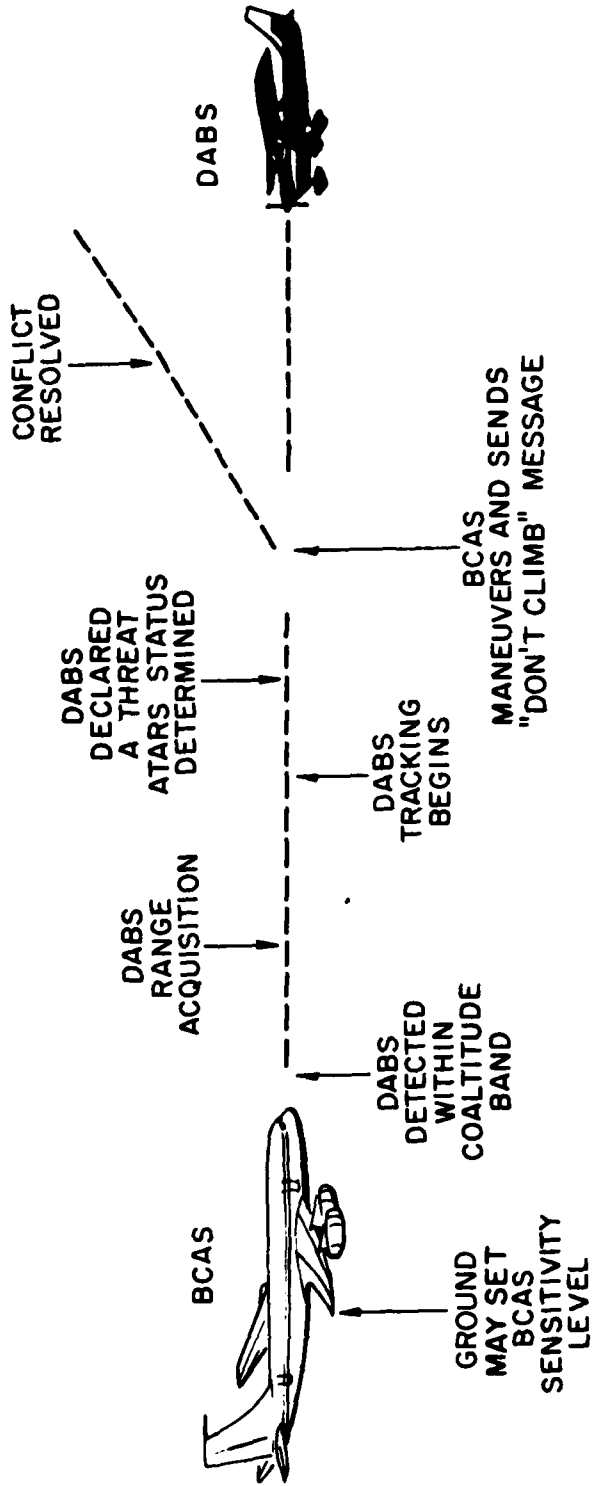

### COLLISION AVOIDANCE ALGORITHMS\*

The principal functions of the BCAS collision avoidance algorithms are threat detection, resolution, and communication and coordination [3].

All aircraft which are tracked by BCAS are considered intruders and potential collision threats. BCAS evaluates each intruder through a prescribed sequence of tests to declare the intruder a threat or a non-threat. The characteristics of an intruder which are examined to determine if it is a threat are its altitude and altitude rate, its range and range rate, and the current sensitivity level of own BCAS.

BCAS generates resolution advisories for all intruders declared threats. Each threat is processed individually for selection of the minimum safe resolution advisory based on track data and coordination with other BCAS-equipped aircraft.

BCAS airborne units communicate with BCAS aircraft and ATARS aircraft via resolution advisory registers (RAR) which store all current advisories by source. Coordination communications involve the air-to-air transmission of RAR data. Comparison of own RAR data with that of the threat assures the selection of compatible resolution advisories.

\* The collision avoidance algorithms are being developed by the MITRE Corporation.

104567-N BCAS COLLISION AVOIDANCE ALGORITHMS

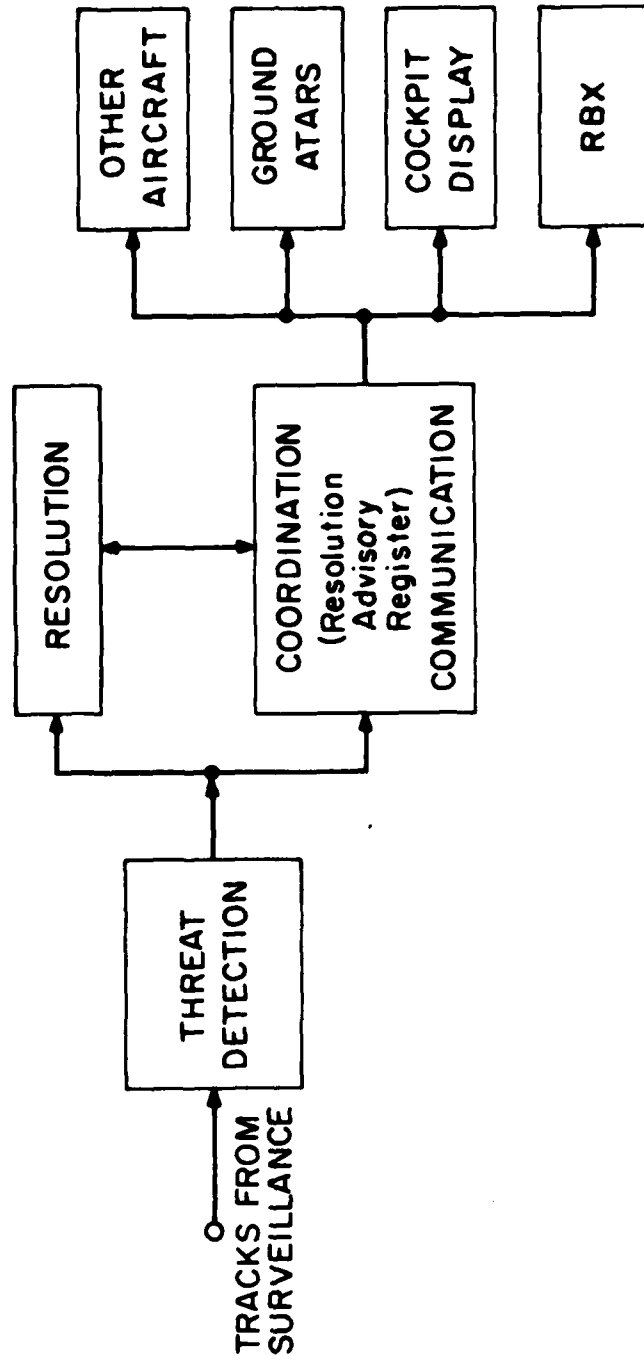

### RBX GROUND STATIONS

Control of the BCAS threat detection parameter values or "sensitivity level" can be accomplished automatically by RBX ground stations.

The figure illustrates the sequence of events and information transfers that occur between the RBX and a BCAS aircraft. The RBX transmits squitters every 4 seconds to indicate its presence and announce its address to the BCAS aircraft. The squitter transmissions elicit no replies from the airborne equipment. When a BCAS-equipped aircraft first receives a squitter transmission it initiates track acquisition by discretely interrogating the RBX.

The reply from the RBX enables the BCAS aircraft to compute its range to the RBX. Each RBX is assigned a range threshold value which is encoded in its replies. If the measured range indicates that the BCAS aircraft could soon penetrate the RBX range threshold, BCAS establishes track and continues interrogating the RBX at 4-second intervals.

All subsequent interrogations to the RBX contain range data computed from the previous interrogation and reply transaction. They also include the current BCAS altitude and all displayed resolution advisories. Based on the range and altitude reports in each interrogation, the RBX selects the appropriate sensitivity level from a stored map and includes the associated command in the reply to the BCAS aircraft.

The BCAS resolution advisories received by the RBX are relayed to the appropriate air traffic control facility for display to the controller.

INTERROGATION-REPLY SEQUENCE BETWEEN BCAS AND RBX

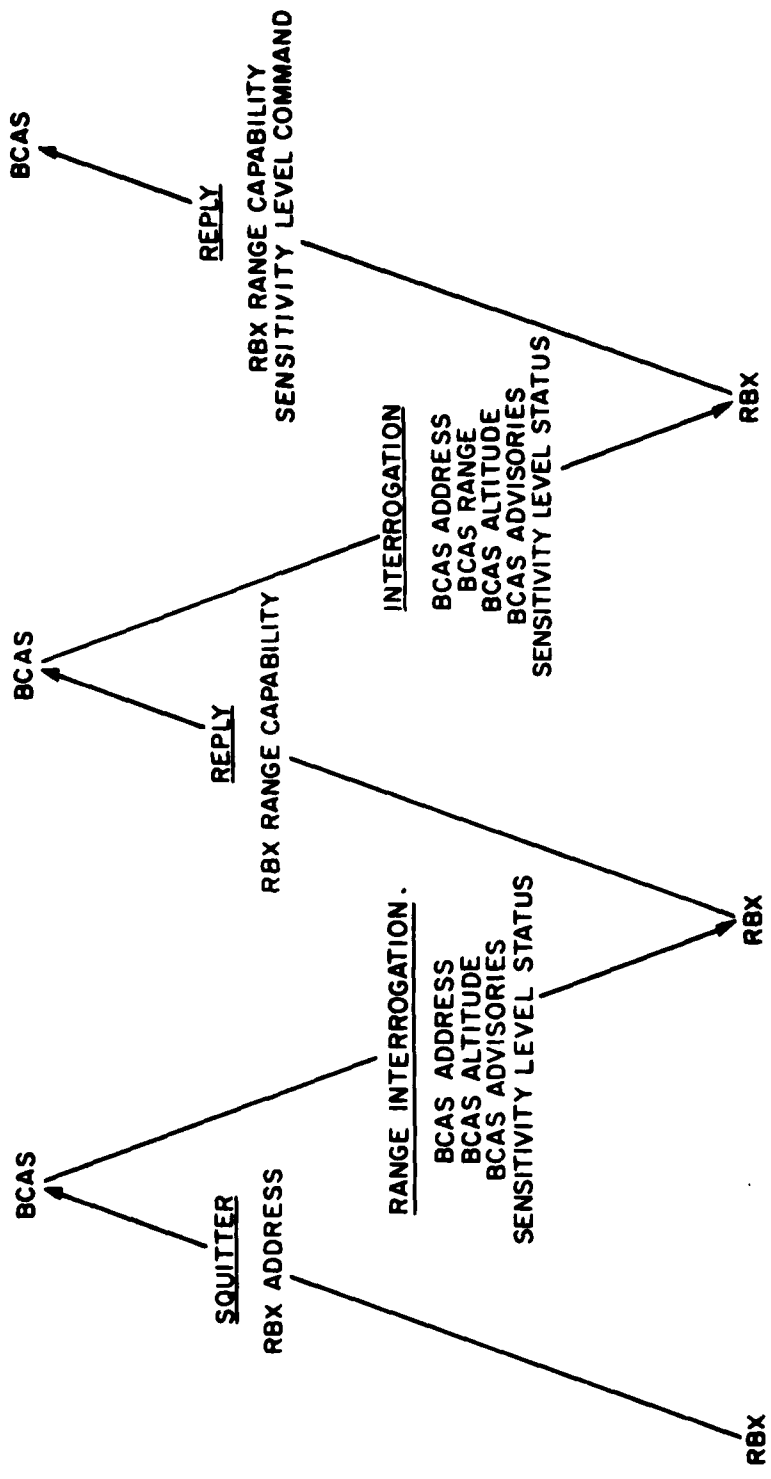

#### BCAS ACQUISITION OF DABS-EQUIPPED AIRCRAFT

The DABS surveillance subsystem uses a passive technique to determine the addresses of DABS-equipped aircraft. Passive address acquisition prevents unnecessary interference with other elements of the beacon system [4]. BCAS listens to squitters and to replies generated by DABS transponders in response to ground interrogations in order to determine DABS aircraft altitudes and addresses. If a DABS transponder has not transmitted a reply in response to an interrogation within the previous one-second interval, it spontaneously transmits (or squitters) a DABS surveillance reply.

After BCAS has received two replies with the same address, it compares the altitude of the target against its own altitude to determine whether the target should be ignored or interrogated to determine its range. If the measured range and the reported speed capability indicate that it is or could soon be a collision threat, the target is regularly interrogated and the resulting track data are fed to the collision avoidance logic. An aircraft at longer range is interrogated only as often as necessary to assure that it will be tracked before it becomes a collision threat. Until this occurs, its address is declared "dormant" and interrogations to that address are temporarily suspended.

The use of passive detection in combination with altitude filtering and dormant addresses minimizes the number of DABS transmissions required by the BCAS system. Provision is also included to automatically limit the DABS interrogation rate when the local density of DABS transponders becomes very high.

EXAMPLE OF DABS ACQUISITION BY BCAS

104571-N

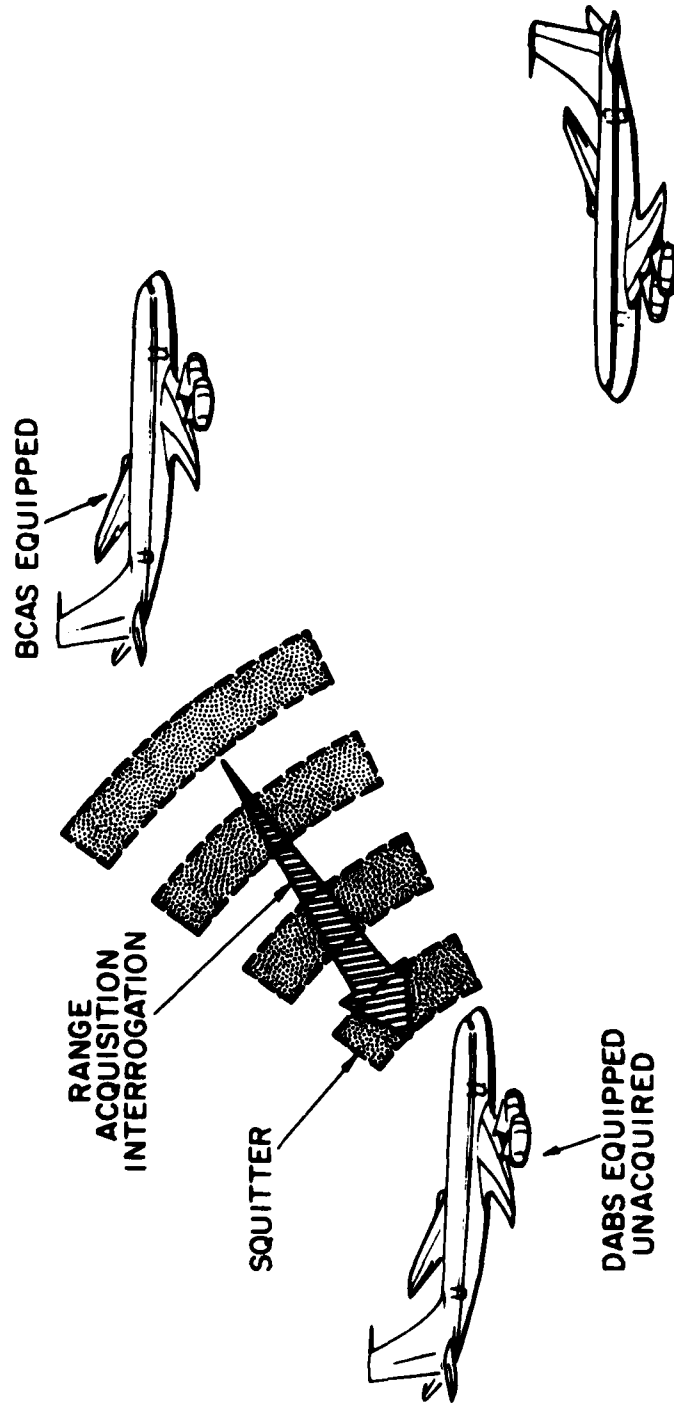

#### ACTIVE BCAS SURVEILLANCE OF DABS EQUIPPED AIRCRAFT

Air-to-air surveillance of DABS targets is inherently easier than tracking ATCRBS targets. Since each transponder has a well protected and unique address, the probability of establishing a false track is negligible. The DABS modulation formats were chosen to be resistant to interference since it was recognized that the DABS ground system would operate in a heavy ATCRBS environment for a number of years. The only real challenge to the DABS air-to-air link arises from ground-bounce multipath.

The DABS interrogation is protected against multipath both by the inherent interference resistance of the binary phase modulation process and by the echo rejection circuitry in the transponder (which protects the DABS interrogation preamble.) The DABS reply waveform is also protected against multipath. A dynamic thresholding scheme similar to the transponder echo rejection circuit is used in the DABS reply processor in BCAS to protect the reply preamble. Like the interrogation data block, the reply data block is also naturally resistant to multipath since the pulse position demodulation process uses a differential amplitude comparison scheme.

Thus, DABS link failures occur only when the multipath signal strength is almost equal to or greater than the direct signal strength. This occurs relatively rarely, especially when the BCAS unit transmits and receives through a top-mounted antenna. By using dual antennas and a reinterrogation capability in the BCAS unit, and by using dual antennas on the DABS aircraft, it is found that near perfect tracking of DABS threats is achieved for all combinations of aircraft types, attitudes, and altitudes and over all types of terrain. If the DABS intruder is equipped with only a bottom-mounted antenna, surveillance performance is somewhat degraded.



# EXAMPLE OF DABS ROLL-CALL TRACKING

104570-W

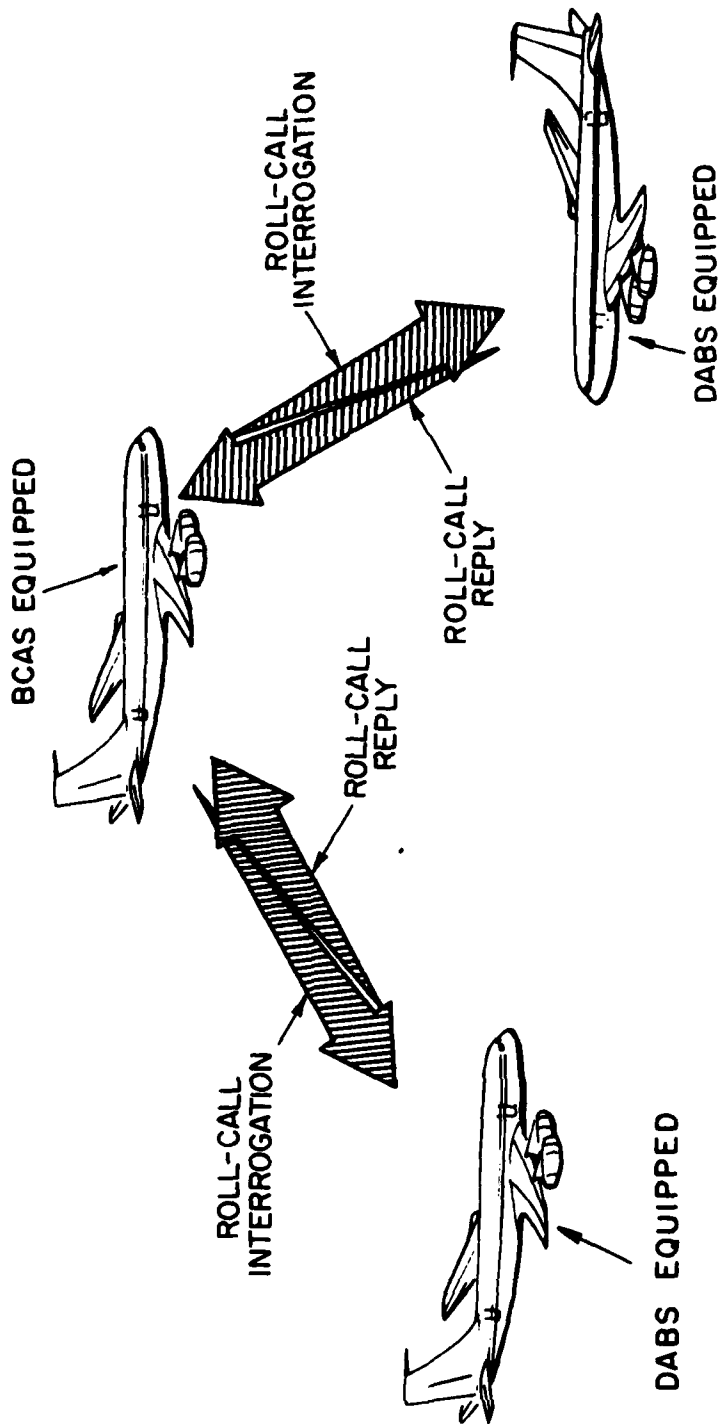

BCAS DETECTION OF ATRCBS-EQUIPPED AIRCRAFT

ATCRBS detection is accomplished by the transmission of modified Mode C interrogations at approximate 1-sec update intervals. Mode C is used because the collision avoidance logic requires measurement of range and altitude.

A modified Mode C interrogation elicits Mode C replies from ATRCBS transponders and no replies from DABS transponders; this is achieved by transmitting an 0.8- $\mu$ sec wide P<sub>4</sub> pulse following the P<sub>3</sub> pulse by 2  $\mu$ sec. DABS transponders are designed to ignore such interrogations. In this way, as aircraft become DABS-equipped, they are removed from the ATRCBS population and do not contribute to the ATRCBS synchronous garble environment.

EXAMPLE OF ATCRBS DETECTION BY BCAS

104572-N

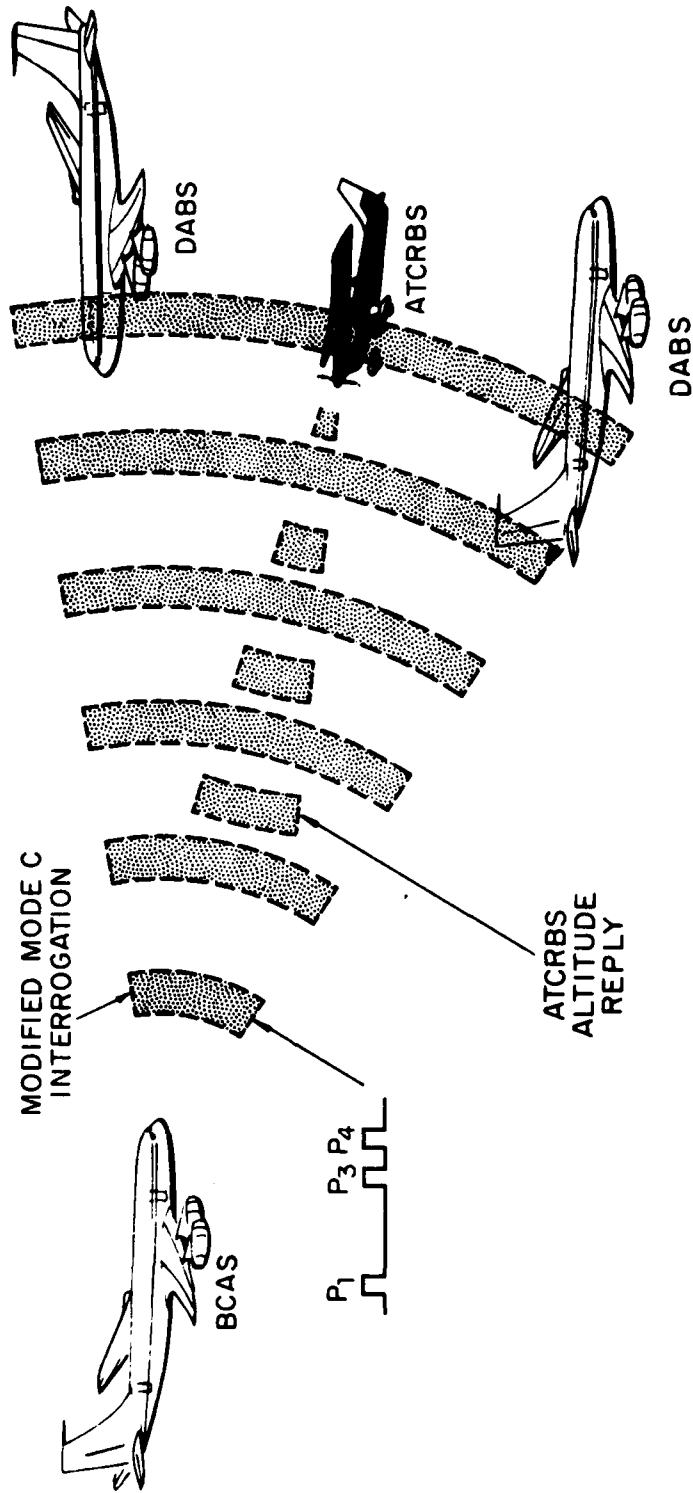

#### TECHNIQUES TO IMPROVE ATRCBS DETECTION: GARBLE SUPPRESSION

The major obstacles to the operation of the ATRCBS mode on the air-to-air BCAS link are ground bounce multipath and synchronous garble. Multipath is controlled by the use of top and bottom antennas on the BCAS aircraft, by the use of dynamic thresholding in both the transponder and the BCAS reply processor and by varying the power level of the Mode C interrogations. Synchronous garble is controlled by a technique of alternating Mode C interrogations and suppression pairs at varying power levels. This "whisper-shout" scheme is intended to reduce the population of ATRCBS transponders replying to each interrogation [5].

The whisper-shout interrogation sequence is illustrated in the figure. A population of ATRCBS transponders at any given range can have up to 20 dB spread in link margin due to variations in receiver sensitivity and antenna gain due to shielding and altitude differences. The BCAS equipped aircraft first transmits a modified Mode C interrogation at a power level about 18 dB below its maximum transmit power level. This interrogation elicits replies only from those transponders with the most favorable link margins.

After the replies to this first interrogation have been received, an ATRCBS suppression waveform consisting of a pair of ATRCBS interrogation pulses with 2  $\mu$ sec spacing is transmitted with about 2 dB less power than the first interrogation. This is followed immediately by a second Mode C interrogation at a 6 dB greater power level than the first interrogation. Most of the transponders which detected the first Mode C interrogation will have sufficient link margin to detect the PI-P2 pair and will be suppressed so that they are unable to detect the second Mode C interrogation. Those which do not detect either the suppression or the second interrogation will not reply. Thus, only a subset of the transponders at any range will respond to the Mode C interrogation. By repeating the sequence with the proper succession of power levels, all of the targets will eventually reply. Most of the replies will be overlapped by fewer synchronous replies than would have occurred in response to a single full-power interrogation.

In addition to dividing the transponder population into subgroups, whisper-shout simultaneously reduces the effect of interrogation-link multipath by assuring that each transponder only replies to interrogations which are received within a few dB of its minimum triggering level. In most situations, this causes the multipath echo to be received below the minimum triggering level of the transponder.



TECHNIQUES TO IMPROVE ATCRBS DETECTION: MULTIPATH SUPPRESSION

Dynamic thresholding is used in the detection of ATCRBS replies as a means of rejecting low level multipath. Variable thresholds have usually been avoided in ATCRBS reply processors because they tend to discriminate against weak replies. However, when used in conjunction with the whisper-shout technique, this disadvantage of dynamic thresholding is largely overcome. Although on any given step of the whisper-shout sequence it is possible for a strong reply to raise the threshold and cause the rejection of a weaker overlapping reply, most overlapping replies received in response to whisper-shout interrogations are of approximately equal amplitudes since the whisper-shout process sorts the targets into groups by signal strength. Experiments indicate that very few replies are lost by the mechanism of threshold capture when dynamic thresholding is used along with whisper-shout. Thus these two techniques provide a very useful degree of multipath resistance to the ATCRBS interrogation and reply links.

# DYNAMIC THRESHOLDING OF ATCRBS REPLIES

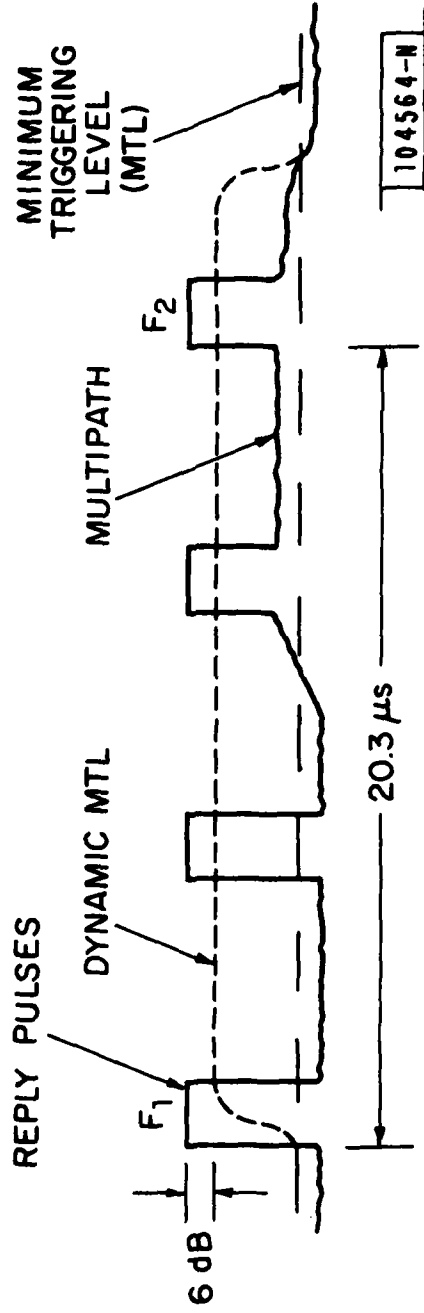

### BCAS TRACKING OF ATCRBS EQUIPPED AIRCRAFT

The first step in ATCRBS tracking is to correlate the replies received from the four whisper shout interrogations via the top and bottom antennas. The replies are compared in range and altitude and duplicate replies are merged so that only one report per scan is produced for each ATCRBS aircraft under surveillance.

Reports are correlated in range and altitude with the predicted position of existing tracks. Reports that successfully correlate are used to extend the position of the corresponding track. Reports that fail to correlate with old tracks are compared to previously uncorrelated reports to start new tracks. Before a new track can be started, the replies that lead to its initiation must agree in all of the most significant altitude bits. A geometric calculation is performed to identify and suppress specular false targets caused by reflection from the sea. New and extended tracks are then merged and checked to see if they qualify for dissemination (as established tracks) to the collision avoidance algorithms.

Tracks become established by meeting a minimum track life requirement. The purpose of this test is to filter spurious tracks caused by garble and multipath that are generally characterized by short track life. The techniques employed for ATCRBS tracking have permitted the use of a track establishment time of 5 seconds rather than the 30 seconds needed for the tracker used in earlier experimental ATCRBS BCAS equipment [6].

This reduction in acquisition time is most significant in that it allows a corresponding reduction in required transmitter power and will have a beneficial effect on the BCAS avionics cost. Using a 5-sec acquisition time, it is calculated that, in the absence of interference, a BCAS unit with transmitter power and receiver sensitivity specifications identical to those of an air carrier transponder will be able to detect all threatening ATCRBS-equipped aircraft closing at up to 1200 kt with at least 95% probability of success [7].





### THE BCAS EXPERIMENTAL UNIT

The final proof of the design of the BCAS surveillance functions is being obtained with the BCAS Experimental Unit, a real-time implementation of a complete Active BCAS airborne unit.

The BEU uses a minicomputer for all of its software functions. This machine contains 32K of core and has a 1-microsecond cycle time. The DABS transponder is physically independent of the BEU and uses a separate pair of antennas. A single 1090-MHz receiver is used by the BEU for the detection of transponder replies. BCAS interrogations are transmitted from the antenna which successfully communicated with the target on the last scan and the same antenna is used for receiving the reply. The modulation control unit formats both ATCRBS and DABS interrogations. The ATCRBS/DABS reply detector includes video pulse processing and reply decoding circuits for both types of replies. False DABS preambles are rejected by the DABS reply decoder which decodes the DABS PPM format and the DABS parity code. The ATCRBS reply decoder searches the received pulse train for framing pulse pairs and decides which altitude code pulses are present in each reply. It also determines the target range, flags those code pulses which are potentially garbled, and rejects all phantoms (bracket pairs which could be code pulses belonging to other replies). All further reply processing and tracking is performed in software.

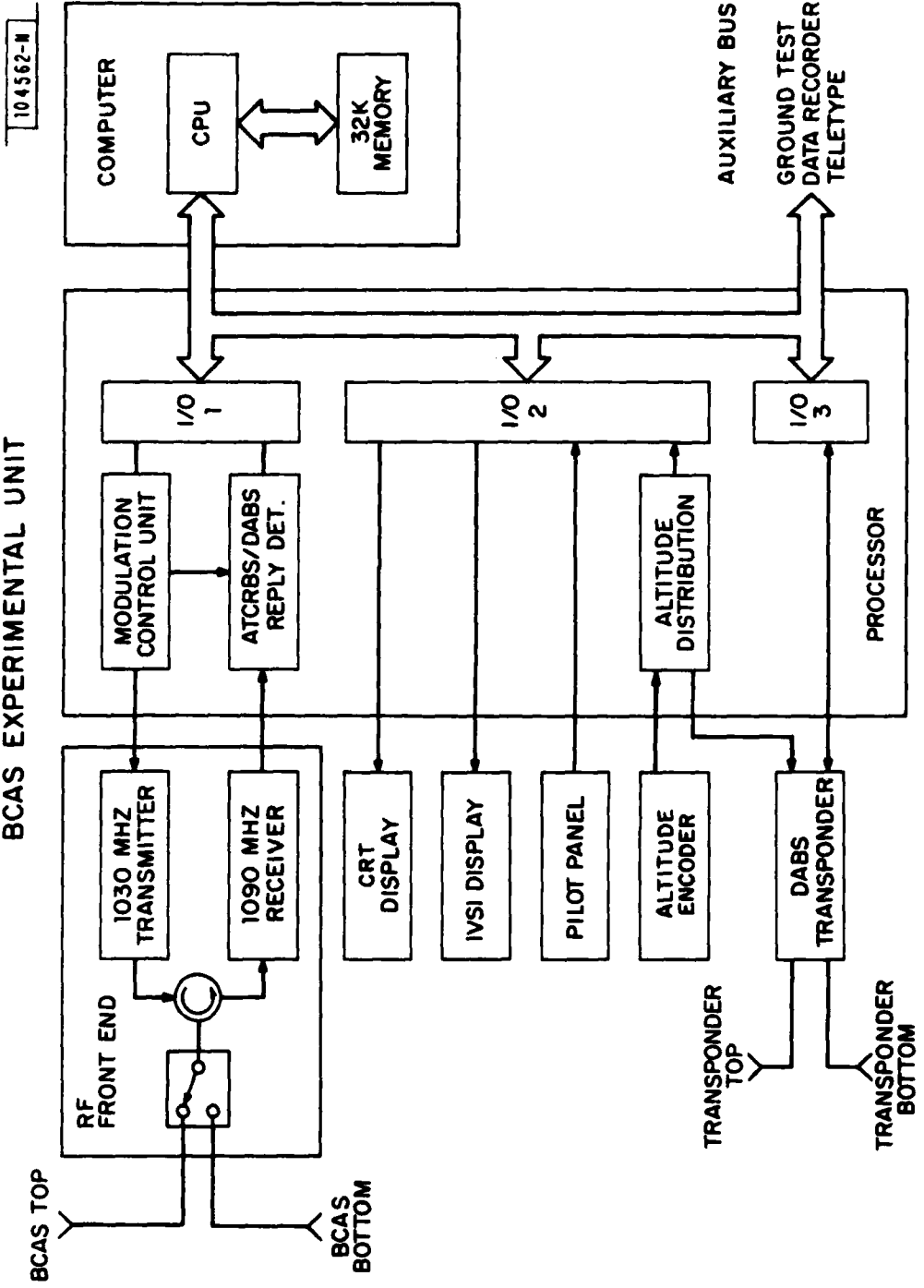

104562-N

### BCAS EXPERIMENTAL UNIT CHARACTERISTICS

The BEU surveillance characteristics are summarized in the following table:

Peak Transmit Power (at RF Port):	500 W
Receiver Sensitivity (at RF Port):	-77 dBm (16 dB S/N)
Maximum Range:	14 nautical miles*
Track Capacity:	50 targets, total ATCRBS and/or DABS
Antennas:	Omni, top and bottom
Whisper/Shout Sequence	
Top antenna:	4 steps, 6 dB difference
Bottom antenna:	4 steps, 6 dB difference
Nominal Traffic Density:	0.02 transponders/nmi <sup>2</sup> , average
Maximum Target Closing Speeds	
Range:	1200 kt
Altitude:	12,000 ft/min

\*Receiver range gate setting; BEU is capable of 20-nmi serviceable range.

A photo of the BEU is shown in the figure. From left to right are shown the computer, the processor, the modified instantaneous vertical speed indicator which is used for display of maneuver advisories, and the RF front end.

PROCESSOR

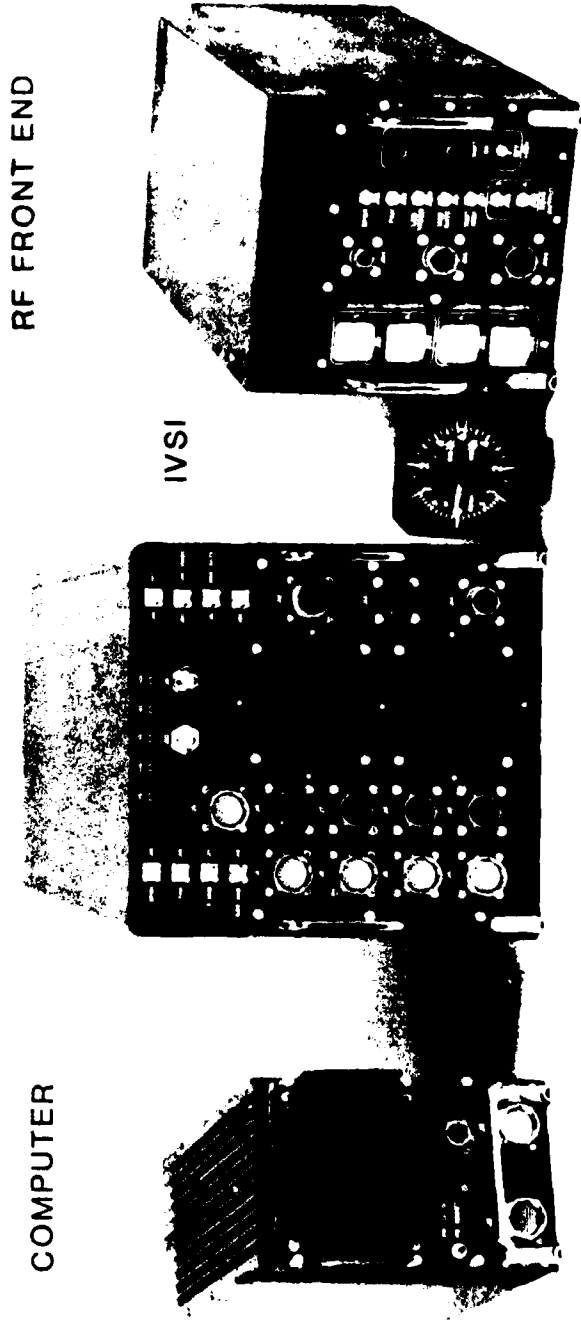

RF FRONT END

IVSI

COMPUTER

BCAS EXPERIMENTAL UNIT

#### DABS SURVEILLANCE PERFORMANCE

Flight tests of controlled encounters were conducted using the BEU to verify surveillance performance in operationally interesting geometries. Tests were conducted with the Active BCAS equipment mounted in several different aircraft, including a Boeing 727. Test scenarios were usually flown at low altitude over land and water to achieve the worst case multipath environment. The figure shows an example of DABS surveillance using the 727 as the BCAS aircraft and a Beechcraft Bonanza as the conflicting aircraft. The dots are plotted at 1-second intervals and indicate a successful track update each scan. The range and relative altitude are plotted as seen from the BCAS aircraft. As the aircraft converge, time proceeds from right to left. The level altitude track was begun at a range of more than 11 miles. The target was kept dormant until it was 7 miles away. The symbol ② indicates the location of the target 25 seconds before closest approach. In all three encounters the tracks were established well in advance of this time. The results are typical of the performance seen in all of the encounters run to date, i.e., near perfect performance against an aircraft equipped with a DABS diversity transponder. The bottom-most trajectory is particularly interesting since it represents a reenactment of the geometry of the collision that occurred at San Diego in 1978. The closing speed for this encounter is sufficiently slow that the dots merge into a solid line.

104561-N DABS PERFORMANCE EXAMPLE -- (WITH DIVERSITY)

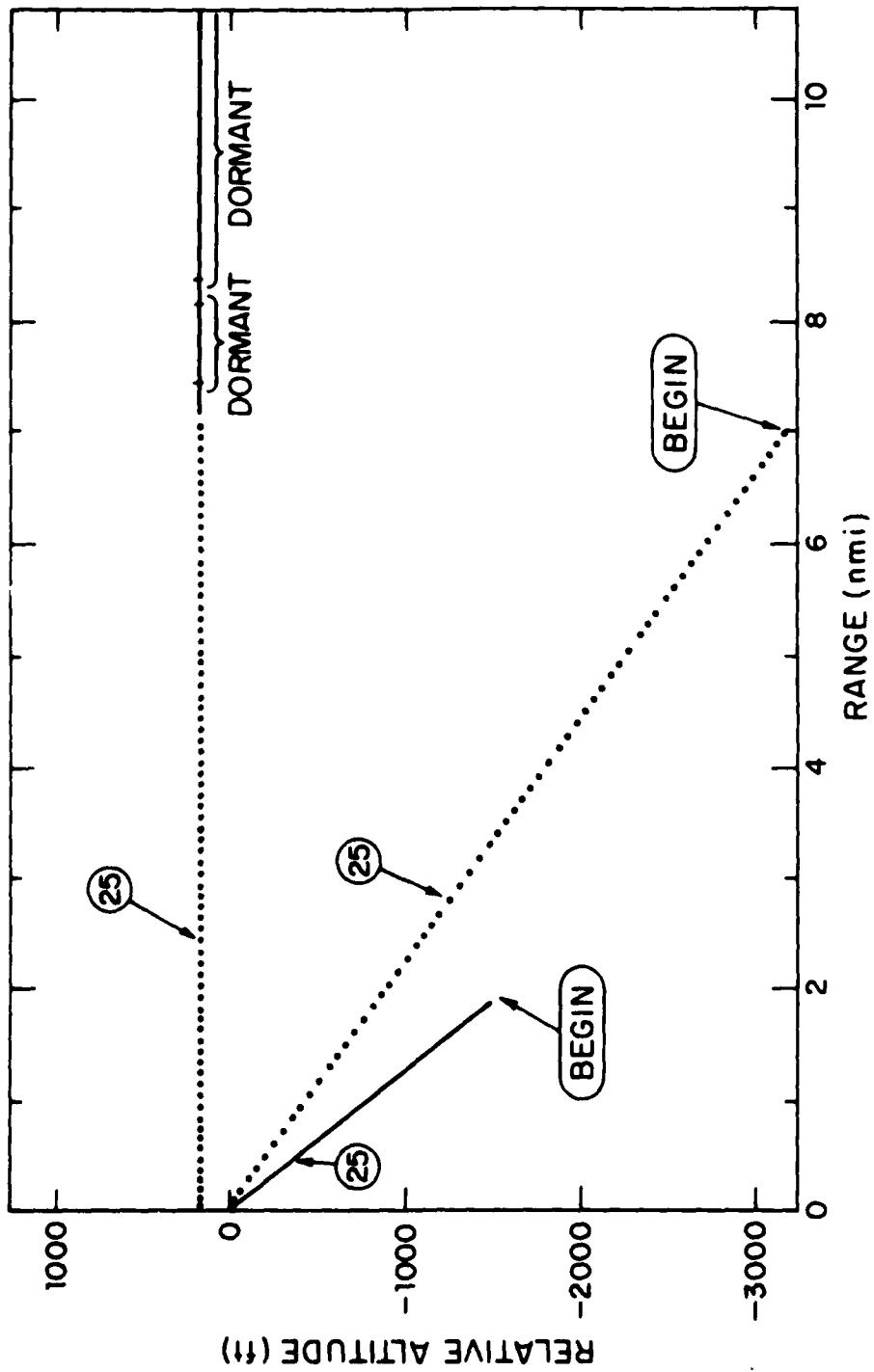

ATCRBS SURVEILLANCE PERFORMANCE - CONTROLLED ENCOUNTERS

The performance of the ATCRBS surveillance mode has also been tested in the San Diego collision geometry. The results presented in the figure show a range-versus-time plot in one of the staged encounters. The surveillance data for the Cessna 172 aircraft (equipped with a conventional ATCRBS transponder with bottom-only antenna) shows reliable performance down to the point of closest approach.

The other tracks in the figure represent chance targets in the area at the time the test was conducted. The short false tracks exhibited are typical of surveillance performance at the low altitude of the encounter. These multipath-induced tracks always occur at greater range than the real target track and rarely lead to false alarms.



ATCRBS PERFORMANCE EXAMPLE - SAN DIEGO COLLISION GEOMETRY

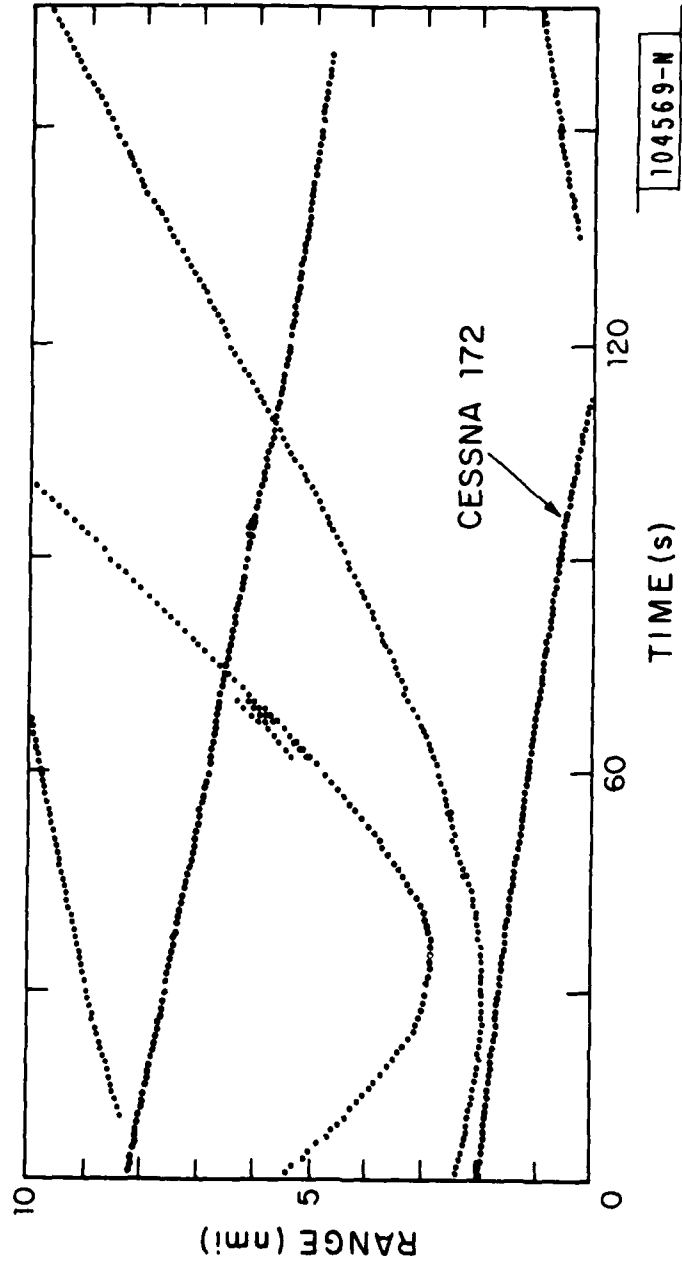
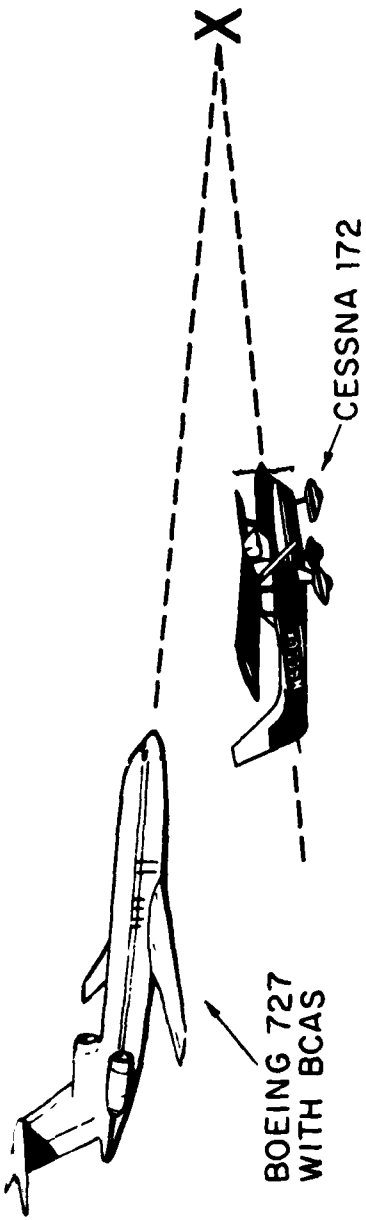

ATCRBS SURVEILLANCE PERFORMANCE - TARGETS OF OPPORTUNITY

In addition to staged encounters, flights have been conducted to collect ATCRBS surveillance data on chance targets. An example of the result of this type of test is shown in the figure and represents the performance of BCAS in head-on high-speed encounters. Encounter conditions and surveillance performance for the plots labelled A and B were as follows:

CASE	BCAS ALTITUDE (FT)	OTHER ALTITUDE (FT)	CLOSING SPEED (KT)	POINT OF CLOSEST APPROACH (NMI)	ACQUISITION RANGE (NMI)	ACQUISITION TIME*
A	30,300	28,800	990	0.3	11.2	43
B	30,300	32,700	960	0.4	9.3	36

\*Seconds prior to point of closest approach.

ATCRBS PERFORMANCE EXAMPLE -- CHANCE HIGH SPEED ENCOUNTERS

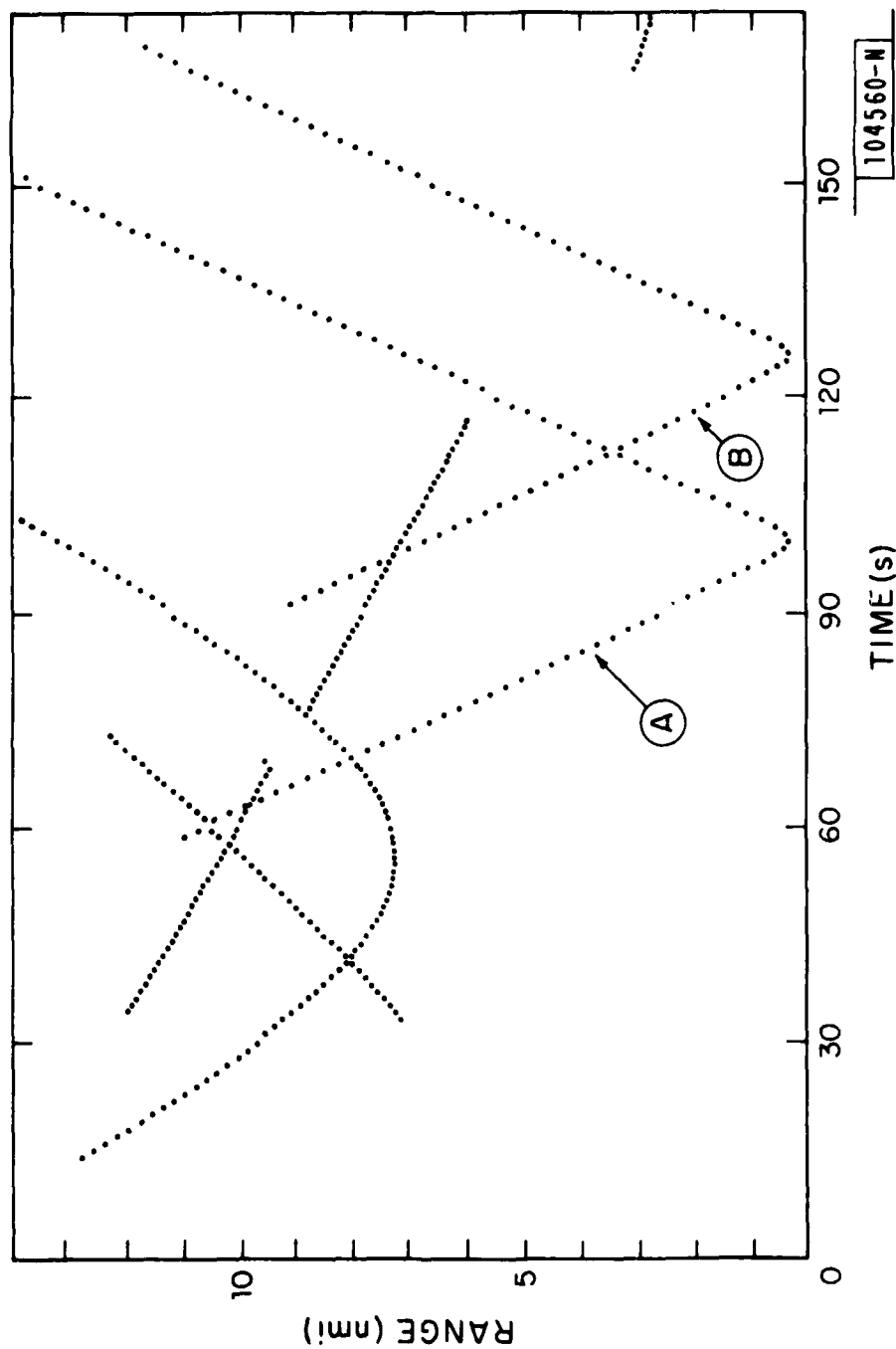

### CONCLUSION

An airborne collision avoidance unit must detect other aircraft, evaluate collision hazards, determine the proper pilot maneuver, and coordinate with other equipment. Techniques have been described for accomplishing the first of these tasks with high reliability for a significant fraction of the aircraft population without requiring special equipment other than standard-air traffic control transponders and encoding altimeters on board the detected aircraft. Although this report has focused on the surveillance task exclusively, there has also been significant development activity addressing the remaining tasks [8,9,10,11]. Three BCAS Experimental Units have been delivered to the FAA for further evaluation. Preliminary results of these evaluations have been published [12, 13].

#### REFERENCES

- [1] V.A. Orlando and P.R. Drouilhet, "Discrete Address Beacon System Functional Description", DOT/FAA Report FAA-RD-80-41 (April 1980).
- [2] V.A. Orlando and J.D. Welch, "Beacon CAS (BCAS) An Integrated Air/Ground Collision Avoidance System", Project Report ATC-62, M.I.T. Lincoln Laboratory, FAA-RD-76-2 (23 March 1976).
- [3] J.A. Grupe, et al, "Detailed Collision Avoidance Algorithms", MTR-80W286, The MITRE Corp. (October 1980).
- [4] P.H. Mann, "Simulation of Surveillance Processing Algorithm Proposed for the DABS Mode of BCAS", Project Report ATC-82, M.I.T. Lincoln Laboratory, FAA-RD-77-138 (16 February 1978).
- [5] P.M. Ebert, L.T. Moses and N.A. Spencer, "Results of an Active Beacon Collision Avoidance Experiment Conducted in the Los Angeles Airspace", MTR-79W00158, The MITRE Corp. (May 1979).
- [6] J.E. Clark, "Active Beacon Collision Avoidance System Computer Algorithms - ATCRBS Mode", MTR-7280, The MITRE Corp. (August 1976).
- [7] W.H. Harman, "Effects of RF Power Deviations on BCAS Link Reliability", Project Report ATC-76, M.I.T. Laboratory, FAA-RD-77-78 (7 June 1977).
- [8] N.A. Broste, D.C. Patterson, A.D. Zeitlin, "Preliminary Evaluation of Active Beacon Collision Avoidance System Performance (Simulated): Protection and Alarms", MTR-79W00135, The MITRE Corp. (April 1979).
- [9] A. Adkins, B. Billmann, R. Strack, J. Windle, "Air Traffic Control/Active Beacon Collision Avoidance System Knoxville Simulation", DOT/FAA Report FAA-RD-80-5 (May 1980).

REFERENCES (Con't)

- [10] T.P. Berry, B. Morgenstern, "An Evaluation of Aircraft Separation Assurance Concepts Using Airline Flight Simulators", ARINC Research Report 1343-01-3-2058 (November 1979).
- [11] D.C. Greenlaw, A.L. McFarland, "Interim Results of Analysis of Active BCAS Alert Rules Using Real Houston Data", MTR-79W293, The MITRE Corp. (June 1980).
- [12] W.H. Harman, R.R. LaFrey, J.D. Welch, M.L. Wood, "Active BCAS: Design and Validation of the Surveillance Subsystem", Project Report ATC-103, M.I.T. Lincoln Laboratory, FAA-RD-80-134 (17 December 1980).
- [13] R. Tornese, A.L. McFarland, "BCAS Collision Avoidance Logic Performance During Operational Flight Tests", MTR-80W352, The MITRE Corp. (December 1980).