

Active Filters with Zero Transfer Function Sensitivity with Respect to the Time Constants of Operational Amplifiers

ARAM BUDAK, MEMBER, IEEE, GERHARD WULLINK, AND RANDALL L. GEIGER

Abstract—Most second-order RC active filters show a marked dependence on the gain-bandwidth product (GB) of operational amplifiers (OA's) when the ω_0 to be realized is greater than 1 percent of GB and $Q > 10$. Here designs are given that are virtually independent of OA's when $\omega_0 < 0.01$ GB and $Q < 10$. Even for $\omega_0 = 0.05$ GB and $Q = 10$, the center frequency shift due to OA's is less than 0.1 percent. This desirable result is achieved by designing filter amplifiers which have zero first-order sensitivities with respect to the time constant $\tau = 1/\text{GB}$ of the OA's used in the design. As a result, the filter transfer function has also zero first-order sensitivity with respect to τ . *General criteria* for such designs are given. Experimental results show excellent agreement with theory.

I. INTRODUCTION

IT IS well known that active filter designs based on ideal operational amplifiers result in actual characteristics that depart from the ideal particularly when high pole- ω_0 and pole- Q 's are to be realized. In the active filter literature, there are many studies [1]–[11] that show how the gain-bandwidth product (GB) of operational amplifiers (OA's) affect the desired ω_0 and Q values. In most circuits discussed in the literature so far, the main thrust has been directed toward obtaining filters that depend to a lesser extent on the GB of OA's than circuits used previously.

Here, we approach the active filter design problem from a different viewpoint. Instead of considering the *entire* filter circuit and then deciding what is to be done to minimize the effect of GB, we focus our attention to the *design of the amplifier* itself with the aim of making its effect, at least to a first-order approximation, zero on the resulting filter transfer function. This is a much easier task than working on the entire filter transfer function to minimize its sensitivity. Some work along these lines, restricted to finite gain amplifiers, can be found in the recent literature [10]–[14]. Particularly noteworthy is Reddy's work [10]. These amplifiers are designed using two or more operational amplifiers (such as $\mu\text{A}741$) and resistors.

Manuscript received November 28, 1978; revised January 22, 1980.

A. Budak is with the Department of Electrical Engineering, Colorado State University, Fort Collins, CO 80523.

G. Wullink is with the Hewlett-Packard, P.O. Box 301, Loveland, CO 80537.

R. L. Geiger is with the Department of Electrical Engineering, Texas A & M University, College Station, TX 77843.

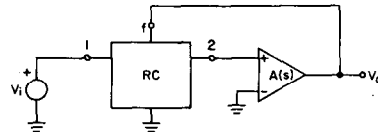

Fig. 1. The active RC filter.

II. GENERAL DISCUSSION

Consider the active filter arrangement shown in Fig. 1. With this configuration, all widely used second-order filter functions can be realized. See [18] for details. Assuming that the amplifier has infinite input and zero output impedance, the following transfer function can be obtained:

$$T(s) = \frac{V_0}{V_i} = - \frac{T_{21}(s)}{T_{2f}(s) - \frac{1}{A(s)}} \quad (1)$$

where

$$T_{21}(s) = \left. \frac{V_2}{V_1} \right|_{V_f=0}, \quad T_{2f}(s) = \left. \frac{V_2}{V_f} \right|_{V_1=0}$$

To see how the amplifier would affect the transfer function, we take the derivative of $T(s)$ with respect to τ where τ is a parameter in $A(s)$

$$\frac{\partial T(s)}{\partial \tau} = \frac{-T_{21}(s) \frac{\partial}{\partial \tau} \left[\frac{1}{A(s)} \right]}{\left[T_{2f}(s) - \frac{1}{A(s)} \right]^2}$$

If the sensitivity of $T(s)$ with respect to τ is to be zero, then the sensitivity of $1/A(s)$ with respect to τ must be zero. Before we turn our attention to the design of such amplifiers, it should be stated that the negative terminal of the amplifier need not be grounded. Furthermore, $A(s)$ need not even be a difference amplifier; that is, it could have gains $A^+(s)$ and $A^-(s)$ associated with the + and - inputs, respectively. In the latter case, we require that the sensitivities of $1/A^+(s)$ and $1/A^-(s)$ with respect to τ be zero.

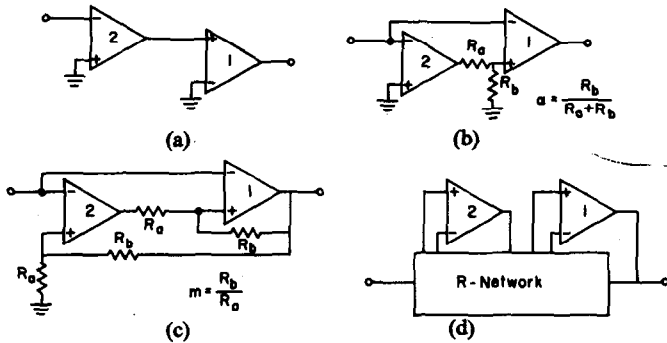

Fig. 2. Amplifiers with zero first-order sensitivity and general realization.

III. AMPLIFIERS WITH ZERO $\partial/\partial\tau[1/A(s)]$.

In its simplest form, $A(s)$ can represent the gain of a one-pole rolloff OA. Such an amplifier can be modeled quite accurately by [9]

$$A(s) = -\frac{GB}{s} = -\frac{1}{s\tau}$$

where GB of the OA is in radians per second. The constant τ , henceforth called the time constant of the OA, is a parameter that can be used instead of GB to characterize the OA. Ideally $\tau=0$. The derivative of $1/A(s)$ with respect to τ is

$$\frac{\partial}{\partial\tau} \frac{1}{A(s)} = -s.$$

Since this derivative is nonzero, *active filters employing a single one-pole rolloff OA, cannot be rendered insensitive to the τ of the OA.*

We now consider the circuit of Fig. 2(a) where $A(s)$ is formed by cascading two one-pole rolloff OA's. With τ_1 and τ_2 representing the respective time constants of the OA's, we obtain

$$A_a(s) = -\frac{1}{s^2\tau_1\tau_2} \tag{2}$$

$$\frac{\partial}{\partial\tau_1} \frac{1}{A_a(s)} = -s^2\tau_2 \quad \frac{\partial}{\partial\tau_2} \frac{1}{A_a(s)} = -s^2\tau_1. \tag{3}$$

When τ_1 and τ_2 assume their ideal values of zero, the derivatives become zero. Therefore, we conclude that when the amplifier of Fig. 2(a) is used in the active filter of Fig. 1, the transfer function will be, to a first-order approximation, insensitive to τ 's as τ 's take on values different from zero.

Consider next the two OA arrangement shown in Fig. 2(b). Here, we have

$$A_b(s) = -\frac{\alpha + s\tau_2}{s^2\tau_1\tau_2} \tag{4}$$

$$\frac{\partial}{\partial\tau_1} \frac{1}{A_b(s)} \Big|_{\tau_1=\tau_2=0} = \frac{\partial}{\partial\tau_2} \frac{1}{A_b(s)} \Big|_{\tau_1=\tau_2=0} = 0. \tag{5}$$

As (5) shows, the derivatives at the ideally zero values of τ_1 and τ_2 are zero. The parameter α can be used to control the zero of $A_b(s)$.

Similarly, for the amplifier circuit of Fig. 2(c), we obtain

$$A_c(s) = -\frac{s\tau_2 + \frac{m}{1+m}}{s^2\tau_1\tau_2 - s\tau_2} \frac{1}{1+m} \frac{m}{(1+m)^2} \tag{6}$$

$$\frac{\partial}{\partial\tau_1} \frac{1}{A_c(s)} \Big|_{\tau_1=\tau_2=0} = \frac{\partial}{\partial\tau_2} \frac{1}{A_c(s)} \Big|_{\tau_1=\tau_2=0} = 0. \tag{7}$$

Again the derivatives at the ideal values are zero. For $R_2 = \infty$ and $R_1 = 0$ ($m = \infty$), the amplifier of Fig. 2(c) reduces to the amplifier of Fig. 2(b) with $\alpha = 1$.

It is important to observe that $A_a(s)$ and $A_b(s)$ have infinite dc gain, whereas $A_c(s)$ has a dc gain of $1+m$.

We now derive the condition for zero sensitivity for any amplifier circuit using two one-pole rolloff OA's and resistors. The general configuration, which includes the special cases of Fig. 2(c), is shown in Fig. 2(d). See also [17]. The resulting gain can be shown [6] to be

$$A(s) = \frac{a_1's\tau_2 + a_0}{b_2s^2\tau_1\tau_2 + b_1s\tau_1 + b_1's\tau_2 + b_0}. \tag{8}$$

The derivatives with respect to τ_1 and τ_2 are

$$\frac{\partial}{\partial\tau_1} \frac{1}{A(s)} = \frac{s^3\tau_2^2a_1'b_2 + s^2\tau_2(a_0b_2 + a_1'b_1) + sa_0b_1}{(a_1's\tau_2 + a_0)^2} \tag{9}$$

$$\frac{\partial}{\partial\tau_2} \frac{1}{A(s)} = \frac{s^2\tau_1(a_0b_2 - a_1'b_1) + s(a_0b_1' - a_1'b_0)}{(a_1's\tau_2 + a_0)^2} \tag{10}$$

Although these derivatives can be minimized or made zero for a given τ_1 and τ_2 , here we consider the simpler case of making them zero at $\tau_1 = \tau_2 = 0$. Thus we direct our attention to departures from ideal characteristics only

$$\frac{\partial}{\partial\tau_1} \frac{1}{A(s)} \Big|_{\tau_1=\tau_2=0} = 0 \rightarrow a_0b_1 = 0 \tag{11}$$

$$\frac{\partial}{\partial\tau_2} \frac{1}{A(s)} \Big|_{\tau_1=\tau_2=0} = 0 \rightarrow a_0b_1' - a_1'b_0 = 0. \tag{12}$$

Using (11) and (12) in (8) we obtain the general expression for gain.

$$A(s) = \frac{a_1's\tau_2 + a_0}{b_2s^2\tau_1\tau_2 + \frac{b_0}{a_0}(a_1's\tau_2 + a_0)}, \quad a_0 \neq 0. \tag{13}$$

If a two OA is to have the zero sensitivity property, then its gain function must have denominator and numer-

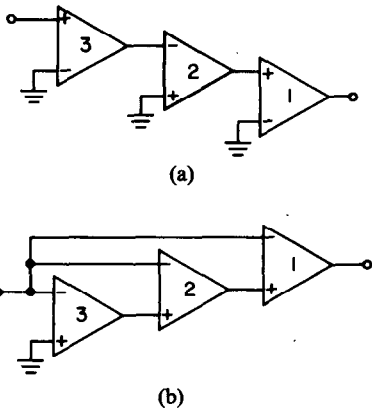

Fig. 3. Amplifiers with zero first- and second-order sensitivities.

ator polynomials that track as shown in (13). (In case $b_0=0$, no tracking is required.) The phase characteristics of these amplifiers for ω small can be approximated by

$$\theta(\omega) \cong -\frac{\tau_1 \tau_2^2 a_1' b_2}{a_0 b_0} \omega^3.$$

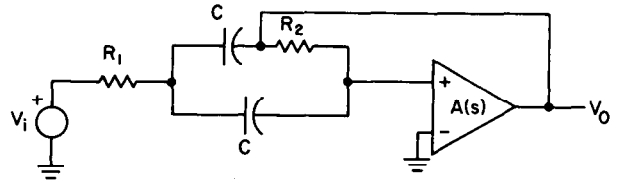

Fig. 4. Bandpass filter.

sensitivity with respect to OA time constants.

Another amplifier with the zero sensitivity property was discussed by Reddy [10] and Geiger [11]. Their amplifier can be obtained from the circuit given in Fig. 2(c) by interchanging the + and - terminals of the second OA and is therefore stable. The topology of the external RC feedback structure determines which amplifier is to be used in order to obtain a stable filter.

IV. ACTIVE FILTER REALIZATION

Consider the bandpass circuit shown in Fig. 4. The transfer function is given by

$$T(s) = \frac{V_0}{V_i} = \frac{-\frac{1}{R_1 C} s}{s^2 + s \frac{2}{R_2 C} + \frac{1}{R_1 R_2 C^2} - \frac{1}{A(s)} \left[s^2 + s \frac{1}{C} \left(\frac{2}{R_2} + \frac{1}{R_1} \right) + \frac{1}{R_1 R_2 C^2} \right]} \quad (14)$$

Note the absence of any term involving ω . The gains of all the amplifiers shown in Fig. 2 are all special cases of (13). It should also be clear that except for the circuit of Fig. 2(c) where only resistor ratios need to be matched, the zero sensitivity property is not dependent on component values. Furthermore, there is no requirement for matching OA's. Other circuit configurations can be used to construct amplifiers that obey (13).

Using the amplifier of Fig. 2(c) and letting

$$\omega_0 = \frac{1}{C \sqrt{R_1 R_2}} \quad Q = \frac{1}{2} \sqrt{\frac{R_2}{R_1}} \left[\frac{1}{1 - \frac{1}{2m} \frac{R_2}{R_1}} \right] \quad (15)$$

we obtain

$$T_c(s) = \frac{-\frac{1+m}{m} \left(\sqrt{\left(\frac{m}{2Q} \right)^2 + 2m} - \frac{m}{2Q} \right) \omega_0 s \left(\frac{m}{m+1} + s\tau_2 \right)}{\left(s^2 + s \frac{\omega_0}{Q} + \omega_0^2 \right) \left(\frac{m}{1+m} + s\tau_2 \right) + s^2 \tau_1 \tau_2 \left(\frac{1+m}{m} \right) \left\{ s^2 + s \left[\left(\frac{1+m}{m} \right) \left(\sqrt{\left(\frac{m}{2Q} \right)^2 + 2m} - \frac{m}{2Q} \right) + \frac{1}{Q} \right] \omega_0 + \omega_0^2 \right\}} \quad (16)$$

The method presented here can also be extended to amplifier circuits using three one-pole rolloff OA's so as to make not only the first but also the second derivatives equal to zero. The amplifier circuits shown in Fig. 3 have this property.

So far nothing has been said about the characteristics of amplifiers that have the zero sensitivity property. Referring to (6), note that except for $m=\infty$, the amplifier of Fig. 2(c) by itself is unstable. Even with external resistive feedback, the circuits given in Figs. 2 and 3 may have high Q 's if not right half-plane poles. Hence, these amplifiers are not intended to be used to provide straightforward amplification. Rather, they are to be used with RC structures to realize transfer functions that have zero

Had we used the infinite-dc-gain amplifiers of Fig. 2(a) and (b), large resistor ratios would have been required to obtain high Q 's. Such is not the case when the finite-dc-gain amplifier of Fig. 2(c) (see (15)) is used. This latter filter circuit is a special case of the Friend [15] and Deliyannis [16] configurations and it can be designed with reasonable component spread and relatively low passive sensitivities.

Since the amplifier has the zero sensitivity property, it follows that

$$\frac{\partial T_c(s)}{\partial \tau_1} \Big|_{\tau_1=\tau_2=0} = \frac{\partial T_c(s)}{\partial \tau_2} \Big|_{\tau_1=\tau_2=0} = 0. \quad (17)$$

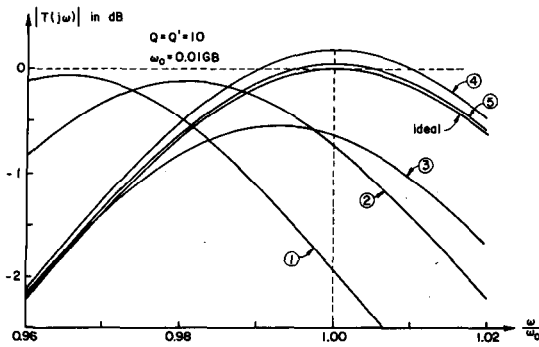

Fig. 5. Comparison of magnitude characteristics at ω_0 .

This result is to be expected since the transfer function reduces to the ideal if the higher order time-constant terms (those involving the $\tau_1\tau_2$ product) are neglected. See (16).

To see how much better the filter circuit using the amplifier of Fig. 2(c) is, its theoretical magnitude characteristic around ω_0 is compared in Fig. 5 with four other bandpass circuits which are considered to have good performance characteristics. Also plotted is the ideal characteristic. In all cases $Q=10$, $\omega_0=0.01$ GB, and the peak magnitude is normalized to 0 dB when evaluated for $\tau=0$. The most departure from the ideal characteristic is exhibited by curve 1 which is due to Deliyannis [16], Friend [15]. The center frequency shifts downward by more than 3 percent resulting in a response that is almost 2 dB lower than the ideal curve at ω_0 . Curve 2 is due to the optimum circuit discussed by Sedra and Espinoza [7, figs. 2-15], and it shows almost 2-percent shift in the center frequency. Curve 3 represents the characteristic of the circuit given by Michael and Bhattacharyya [8]. Although its shift in center frequency is less than the previous two circuits, it shows the most reduction in its peak magnitude. Curve 4 represents the circuit with zero pole sensitivity discussed recently by Geiger and Budak [6, fig. 4]. There is no noticeable shift in center frequency, but there is a slight increase in the peak magnitude. Curve 5 represents the characteristics of the circuit using the amplifier of Fig. 2(c) with $m=6$. The superior characteristics of this circuit for $Q=10$ and $\omega_0=0.01$ GB is thus demonstrated. As discussed later, this fact is also born out experimentally. Indeed, this circuit could be used in mass production without worrying about differences in individual operational amplifiers of the same type or, for that matter, of another type. It also means that actual designs can be based on the assumption that the operational amplifiers are ideal, the usual situation, and carried out with the full expectation that the circuit will work as predicted. Fig. 5 also gives graphical credence to the zero sensitivity property in that a change of τ from 0 to $0.01/\omega_0$ does hardly effect the magnitude characteristic. Thus, $\mu A741$ OA's can be used to construct filters with $f_0 < 10$ kHz and $Q < 10$ with almost ideal performance characteristics.

Further insight into the characteristics of the bandpass filter can be gained by studying the loci of the desired and

parasitic poles as a function of OA time constants. In multi-OA circuits, it is particularly important to show that the parasitic poles are confined to the left half-plane. Otherwise, we may end up with an unstable system even though the desired poles are rendered insensitive to the τ of the OA's. With $\omega_0\tau_1=\omega_0\tau_2=\tau_n$ and $s/\omega_0=s_n$, the normalized characteristic equation of the bandpass circuit is obtained from (16) as

$$s_n^4\tau_n^2\left(\frac{1+m}{m}\right) + s_n^3\tau_n^2\left(\frac{1+m}{m}\right) \cdot \left[\frac{1+m}{m} \left(\sqrt{\left(\frac{m}{2Q}\right)^2 + 2m} - \frac{m}{2Q} \right) + \frac{1}{Q} \right] + \tau_n \cdot \left[\frac{1+m}{m} \left(\sqrt{\left(\frac{m}{2Q}\right)^2 + 2m} - \frac{m}{2Q} \right) + \frac{1}{Q} \right] + s_n^2 \left[\tau_n^2 \left(\frac{1+m}{m} \right) + \frac{m}{1+m} + \frac{\tau_n}{Q} \right] + s_n \left[\frac{1}{Q} - \left(\frac{m}{1+m} \right) + \tau_n \right] + \frac{m}{1+m} = 0. \quad (18)$$

By differentiation, it can be shown that the desired pole derivatives are zero for $\tau_n=0$, that is

$$\left. \frac{dp}{d\tau} \right|_{p=p_d, \tau_n=0} = 0 \quad (19)$$

where

$$p_d = -\frac{\omega_0}{2Q} \pm j\omega_0 \sqrt{1 - \frac{1}{4Q^2}}.$$

As a result, to a first-order approximation, the desired poles for $\omega_0\tau \ll 1$ are given by p_d , that is they do not change. This fact allows us to approximate the location of the undesired parasitic poles p_u for $\omega_0\tau \ll 1$ by referring to (18) and using the coefficients of the s^3 and s^0 terms which are respectively the negative sum and the product of all the poles.

$$\left\{ \begin{aligned} -\sum \frac{p_u}{\omega_0} &\cong \left[\sqrt{\left(\frac{m}{2Q}\right)^2 + 2m} - \frac{m}{2Q} \right] \left(\frac{1+m}{m} \right) + \frac{m}{1+m} \frac{1}{\tau_n} \\ \prod \frac{p_u}{\omega_0} &\cong \left(\frac{m}{1+m} \right)^2 \frac{1}{\tau_n^2} \end{aligned} \right\}$$

$$p_u \cong -\frac{m}{1+m} \left(\frac{1 \pm j\sqrt{3}}{2} \right) \frac{1}{\tau}. \quad (20)$$

The corresponding undesired pole Q is 1 and is thus independent of τ . Hence the pole loci start out at constant Q at an angle of 60° with the real axis.

To see the larger scale changes, the desired and parasitic upper half plane poles are plotted in Fig. 6 for $Q=10$ as a function of τ_n using $m=6$. The constant m is chosen 6 to increase the ω_0 of the parasitic poles (see (20)). It should also be mentioned that m can be assigned other values without noticeably affecting the desired response near ω_0 . As τ_n is increased from zero, the desired poles move to the right keeping ω_0 practically constant (see Fig. 6(a)). Thus, there is an extremely small change in the center frequency and a decrease in bandwidth. The normalized ω_0 and Q values of the desired poles are listed

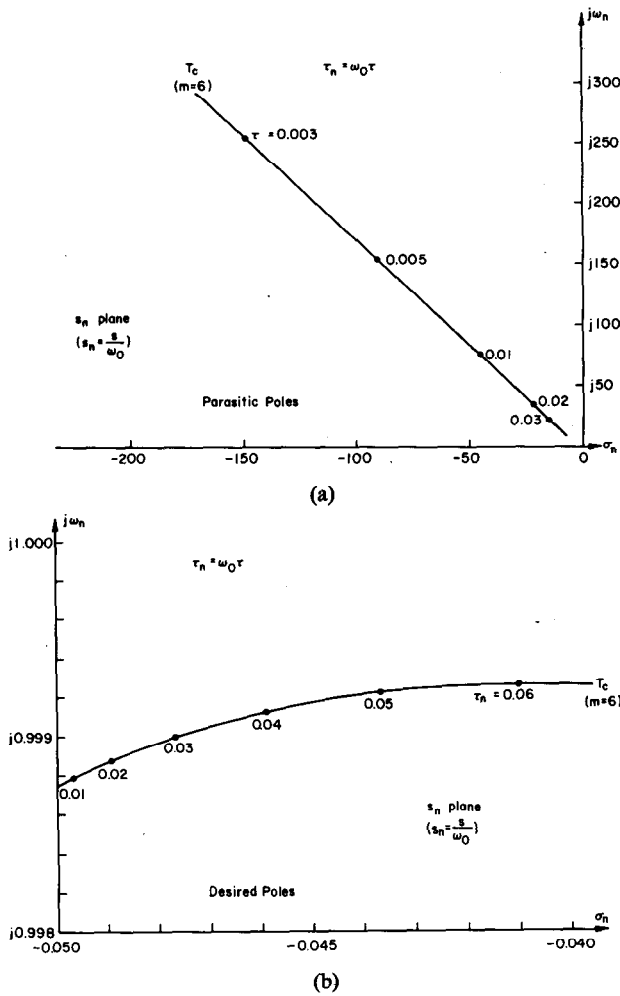

Fig. 6. (a) Loci of desired poles as a function of τ_n . (b) Loci of parasitic poles as a function of τ_n .

below for $\tau_n = \omega_0\tau = 0.01$ as well as for 0.05. Also listed are the ω_{0n} and Q values for several popular existing designs which ideally realize the same normalized transfer function. Details of these general circuits can be found in the references cited; specifics for $Q=10$ with various values of τ_n are summarized in [6]. As the table shows, a five-fold decrease in GB (or a five-fold increase in ω_0) has the least effect on T_c .

Circuit	$\tau_n = 0.01$		$\tau_n = 0.05$	
	ω_{0n}	Q	ω_{0n}	Q
T_c (see (16))	1.0001	10.0508	1.0003	11.4513
Geiger and Budak [6, fig. 4]	1.0003	10.2126	1.0000	20.0491
Sedra and Espinoza [7, fig. 2-15]	0.9806	9.9633	0.9127	9.2626
Michael and Bhattacharyya [8]	0.9925	10.0988	0.9629	10.9967
Deliyannis [16], Friend [15]	0.9650	10.2912	0.8545	10.2814

In Fig. 6(b), the parasitic poles are given as a function of τ_n . It is interesting to note that the poles not only start out with $Q=1$ but also maintain this value over a large range of values of τ_n . The normalized ω_0 and Q values for the parasitic poles are given below for $\tau_n = 0.01$.

$$\omega_{0n} = 85.7142 \quad Q = 0.9968. \quad (21)$$

As (21) shows the parasitic poles are in the left half-plane and are almost two orders of magnitude further out from

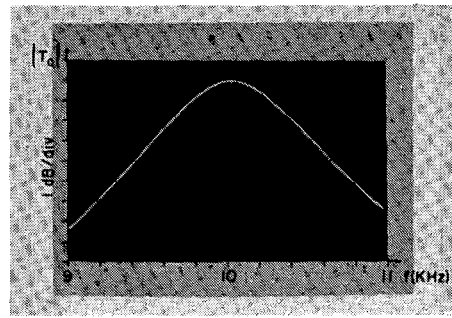

Fig. 7. Experimentally obtained bandpass responses using $\mu A741$ and LF356 OA's.

the origin than the desired poles. Hence, they have negligible effect on the bandpass characteristics.

V. EXPERIMENTAL RESULTS

The bandpass circuit of Fig. 4 with $f_0 = 10$ kHz was constructed using the amplifier of Fig. 2(c) with $m=6$. Two experimental runs were made: one $\mu A741$, the other with LF356 operational amplifiers. The measured GB's were 1.2 MHz for the $\mu A741$'s and 4.9 MHz for the LF356's. All components were bridged to within 0.1 percent of design values and great care was exercised to obtain repeatable results with precision instruments. As voltage source, a synthesizer with 50- Ω output resistance was used. Therefore, R_1 in Fig. 4 was reduced by 50 Ω from the design value. Mica capacitors with $Q > 700$ were used for all the circuits. Power supply voltages were ± 15 V.

The theoretical and experimental results are shown below.

	Center Frequency (kHz)		Gain at Center Frequency	
	Theoretical	Experimental	Theoretical	Experimental
Ideal OA	10.0	—	36.97	—
LF 356	10.0	10.0	36.97	37.55
$\mu A741$	10.0	10.0	37.16	37.46

No shift in center frequency could be detected when the $\mu A741$'s were replaced with LF356's.

Fig. 7 is a photograph of the magnitude curves obtained experimentally for $f_0 = 10$ kHz and $Q=10$. There are actually two traces on top of each other in the photo, obtained with $\mu A741$ and LF356 OA's, respectively. Thus, even though the LF356 has a GB product four times larger than the $\mu A741$, the difference between the two response curves is not discernible (even though the entire ω -axis spans only 2 kHz). Indeed, had we also plotted the ideal curve, we would not have been able to separate it from the other two. Thus the zero sensitivity property is remarkably demonstrated.

To see the effect of the parasitic poles, the magnitude characteristic was experimentally obtained and plotted in Fig. 8 for frequencies extending to 4 MHz. A very small secondary peak was observed at 3.068 MHz with LF356 OA's having a GB product of 4.9 MHz. With $\tau_n = \omega_0/GB = 10^4/4.9 \times 10^6 = 0.00204$, the calculated ω_0 and Q of the parasitic poles are $420\omega_0$ and 1, respectively. With such low Q , the peak occurs at $420f_0/\sqrt{2} \approx 3$ MHz which is in

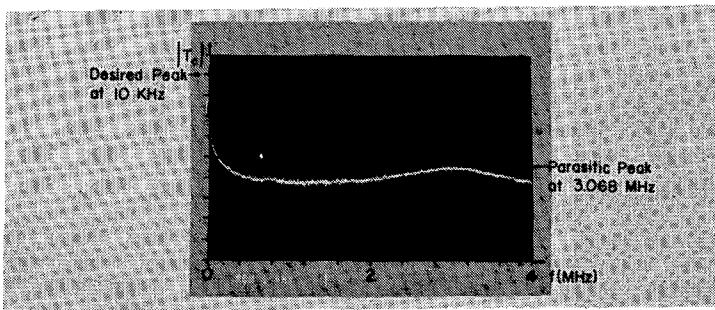

Fig. 8. Experimentally obtained bandpass response with LF356 OA's showing desired as well as parasitic peaks.

agreement with the experimental result. This undesired peak is 53.4 dB down from the desired peak at 10 kHz.

VI. CONCLUSIONS

Active filters can be successfully operated at higher frequencies if the amplifiers are designed to produce zero transfer-function sensitivity. The experimental performance of such a filter is shown to be extremely close in agreement with theory. Other passive RC networks can be used in conjunction with amplifiers having the zero sensitivity property to achieve zero transfer function sensitivity. One such network is the bridged-twin-T RC network with which high Q 's can be achieved with low spread in resistance and capacitance values. Thus, high resistance ratios or high passive Q sensitivities can be avoided. Also the bridged-twin-T network, just like T_c , results in a small coefficient for the s term in the second-order polynomial following the $s^2\tau_1\tau_2$ factor thereby making the bandpass circuit less sensitive with respect to τ when τ is not zero.

REFERENCES

- [1] R. Srinivasagopalan and G. O. Martens, "A comparison of a class of active filters with respect to the operational-amplifier gain-bandwidth product," *IEEE Trans. Circuits Syst.*, vol. CAS-21, pp. 618-626, Sept. 1974.
- [2] D. Akerberg and K. Mossberg, "A versatile active RC building block with inherent compensation for the finite bandwidth of the amplifier," *IEEE Trans. Circuits Syst.*, vol. CAS-21, pp. 75-78, Jan. 1974.
- [3] R. Tarmy and M. S. Ghausi, "Very high- Q insensitive active RC networks," *IEEE Trans. Circuits Theory*, vol. CT-17, pp. 358-366, Aug. 1970.
- [4] P. E. Allen, "Increased frequency capability for a given active filter configuration," *IEEE Trans. Instrum. Meas.*, vol. IM-25, pp. 18-27, Mar. 1976.
- [5] P. E. Fleisher, "Sensitivity minimization in a single amplifier biquad circuit," *IEEE Trans. Circuits and Syst.*, vol. CAS-21, pp. 45-55, Jan. 1976.
- [6] R. Geiger and A. Budak, "Active filters with zero amplifier sensitivity," *IEEE Trans. Circuits Syst.*, vol. CAS-26, pp. 277-288, Apr. 1979.
- [7] A. S. Sedra and J. L. Espinoza, "Sensitivity and frequency limitations of biquadratic active filters," *IEEE Trans. Circuits Syst.*, vol. CAS-22, pp. 122-130, Feb. 1975.
- [8] W. B. Mikhael and B. B. Bhattacharyya, "A practical design for insensitive RC-active filters," *IEEE Trans. Circuits Syst.*, vol. CAS-22, pp. 407-414, May 1975.
- [9] A. Budak and D. M. Petrela, "Frequency limitations of active filters using operational amplifiers," *IEEE Trans. Circuit Theory*, vol. CT-19, pp. 322-328, July 1972.
- [10] M. A. Reddy, "Operational-amplifier circuits with variable phase shift and their application to high- Q active RC-filters and RC-oscillators," *IEEE Trans. Circuits Syst.*, vol. CAS-23, pp. 384-389, June 1976.
- [11] R. Geiger, "Zero sensitivity active filters employing finite gain voltage amplifiers," in *Proc. 1978 IEEE Int. Symp. Circuits and Systems* (New York), pp. 1064-1068, May 1978.

- [12] —, "Amplifiers with maximum bandwidth," *IEEE Trans. Circuits Syst.*, vol. CAS-24, pp. 510-512, Sept. 1977.
- [13] S. Natarajan and B. B. Bhattacharyya, "Design and some applications of extended bandwidth finite gain amplifiers," in *Proc. 1978 IEEE Int. Symp. Circuits and Systems* (New York), pp. 700-701, May 1978.
- [14] B. B. Bhattacharyya and S. Natarajan, "An improved design of voltage follower circuits using operational amplifiers," in *Proc. 21st Midwest Symp. Circuits and Systems* (Ames, IA), pp. 188-192, Aug. 1978.
- [15] J. J. Friend, "A single operational-amplifier biquadratic filter section," in *IEEE Int. Symp. Circuit Theory*, pp. 189-190, 1970.
- [16] T. Deliyannis, "High- Q factor circuit with reduced sensitivity," *Electron. Lett.*, vol. 4, no. 26, pp. 577-578, Dec. 27, 1968.
- [17] C. F. Ho and P. L. Chin, "Realization of active-R filters using amplifier pole," *Proc. Inst. Elec. Eng.*, vol. 123, no. 5, pp. 406-410, May 1976.
- [18] A. Budak, *Passive and Active Network Analysis and Synthesis*. Boston, MA: Houghton Mifflin 1974.

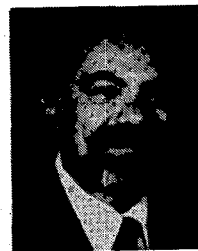

Aram Budak (M'58) was born in Istanbul, Turkey, on February 12, 1929. He received the B.S.E.E. degree from Robert College, Istanbul, the M.E.E. degree from Rensselaer Polytechnic Institute, Troy, NY, and the Ph.D degree from the University of Colorado, Boulder, in 1951, 1954, and 1964, respectively.

He has taught at the University of Washington, Seattle, The University of New Hampshire, Durham, and, since 1957, at Colorado State University, Fort Collins, where he is now Professor of Electrical Engineering. In the last thirteen years, he has been heavily involved with videotaped instruction for engineers in Colorado industry. He has also made a series of videotapes on Operational Amplifiers and Active Filters that are available nationally. He is the author of two textbooks: *Passive and Active Network Analysis and Synthesis* (1974), and *Circuit Theory Fundamentals and Applications* (1978).

Dr. Budak is a member of Sigma Xi and Eta Kappa Nu.



Gerhard Wullink was born in The Netherlands. He received the engineering degree from the University of Wyoming, Laramie, in 1972.

Prior to studying at the University of Wyoming, he lived in Canada, where he worked for an insurance company. Presently he is employed as a Production Engineer by Hewlett-Packard, Loveland, CO.



Randall L. Geiger was born in Lexington, NB, on May 17, 1949. He received the B.S. degree in electrical engineering and the M.S. degree in mathematics from the University of Nebraska, Lincoln, in 1972 and 1973, respectively. He received the Ph.D degree in electrical engineering from Colorado State University, Fort Collins, in 1977.

He joined the Faculty of the Department of Electrical Engineering at Texas A & M University, College Station, in September 1977 and is currently an Assistant Professor in the Department. His present area of research is in the active circuits field.

Dr. Geiger is a member of Eta Kappa Nu, Sigma Xi, Pi Mu Epsilon, and Sigma Tau.