

Acyl-Lipid Metabolism

Authors: Li-Beisson, Yonghua, Shorrosh, Basil, Beisson, Fred, Andersson, Mats X., Arondel, Vincent, et al.

Source: The Arabidopsis Book, 2010(8)

Published By: The American Society of Plant Biologists

URL: <https://doi.org/10.1199/tab.0133>

BioOne Complete (complete.BioOne.org) is a full-text database of 200 subscribed and open-access titles in the biological, ecological, and environmental sciences published by nonprofit societies, associations, museums, institutions, and presses.

Your use of this PDF, the BioOne Complete website, and all posted and associated content indicates your acceptance of BioOne's Terms of Use, available at www.bioone.org/terms-of-use.

Usage of BioOne Complete content is strictly limited to personal, educational, and non - commercial use. Commercial inquiries or rights and permissions requests should be directed to the individual publisher as copyright holder.

BioOne sees sustainable scholarly publishing as an inherently collaborative enterprise connecting authors, nonprofit publishers, academic institutions, research libraries, and research funders in the common goal of maximizing access to critical research.

First published on June 11, 2010: e0133. 10.1199/tab.0133

Acyl-Lipid Metabolism

Yonghua Li-Beisson,^{*} Basil Shorrosh, Fred Beisson, Mats X. Andersson, Vincent Arondel, Philip D. Bates, Sébastien Baud, David Bird, Allan DeBono, Timothy P. Durrett, Rochus B. Franke, Ian A. Graham, Kenta Katayama, Amélie A. Kelly, Tony Larson, Jonathan E. Markham, Martine Miquel, Isabel Molina, Ikuo Nishida, Owen Rowland, Lacey Samuels, Katherine M. Schmid, Hajime Wada, Ruth Welti, Changcheng Xu, Rémi Zallot, and John Ohlrogge

^{*}Correspondence to yonghua.li@cea.fr

Acyl lipids in *Arabidopsis* and all other plants have a myriad of diverse functions. These include providing the core diffusion barrier of the membranes that separates cells and subcellular organelles. This function alone involves more than 10 membrane lipid classes, including the phospholipids, galactolipids, and sphingolipids, and within each class the variations in acyl chain composition expand the number of structures to several hundred possible molecular species. Acyl lipids in the form of triacylglycerol account for 35% of the weight of *Arabidopsis* seeds and represent their major form of carbon and energy storage. A layer of cutin and cuticular waxes that restricts the loss of water and provides protection from invasions by pathogens and other stresses covers the entire aerial surface of *Arabidopsis*. Similar functions are provided by suberin and its associated waxes that are localized in roots, seed coats, and abscission zones and are produced in response to wounding. This chapter focuses on the metabolic pathways that are associated with the biosynthesis and degradation of the acyl lipids mentioned above. These pathways, enzymes, and genes are also presented in detail in an associated website (ARALIP: <http://aralip.plantbiology.msu.edu/>). Protocols and methods used for analysis of *Arabidopsis* lipids are provided. Finally, a detailed summary of the composition of *Arabidopsis* lipids is provided in three figures and 15 tables.

1. INTRODUCTION

The reactions of *Arabidopsis* acyl-lipid metabolism require at least 120 enzymatic reactions and more than 600 genes to encode the proteins and regulatory factors involved. These pathways can be grouped in many ways, but in this chapter we have organized them into 12 sections based on the types of lipids produced and their subcellular localization. To cover such a broad scope of biochemical pathways, structures, and functions is difficult for most researchers, who specialize in one or a few of the pathways or functions. Therefore, we decided to select a larger group of experts who could provide the detailed knowledge and the time needed to identify as many as possible of the *Arabidopsis* enzymes and genes that are known or suspected to participate in *Arabidopsis* acyl-lipid metabolism. The names and contact information of each contributor are provided with the sections they wrote so that others can contact the appropriate expert with corrections, updates, or questions. To better organize all these data, we also decided to link this chapter to a web-based community resource that could provide even more detailed information than possible in a chapter of *The Arabidopsis Book*. This website (ARALIP), <http://aralip.plantbiology.msu.edu/>, has evolved from the site developed in 2003 and described by Beisson et al. (2003), which in turn evolved from Mekhedov et al. (2000). Basil Shorrosh¹ created the new site, the pathway figures, and the un-

derlying relational database so that they could be updated easily to reflect new information. A key feature of the ARALIP website is that each of the figures that describe the pathways includes hyperlinks for all reactions and proteins involved in the pathways. These hyperlinks are activated by clicking on any of the red letters in the figure and will lead to a page of information on the genes that encode the proteins, rich annotations provided by the authors of this chapter, key references, known mutants, links to expression and coexpression data, and other information.

When the 2003 database was published (Beisson et al., 2003), only ~15% of the 600 genes cataloged had functions that were confirmed by heterologous expression, mutant analysis, or similar strong evidence. The other 85% were identified as only “putative” based on sequence similarity to well-characterized genes from plants, animals, or microbes. Over the past 7 years, much progress has been made! In our current catalog, almost 40% of the genes are in the category of “function indicated/confirmed by mutant, heterologous expression, etc.” Approximately 20% of the genes in our catalog are represented by defined and characterized mutants.

We had three other goals in the production of this chapter. First, we asked authors of each pathway section to end with a list of major unanswered questions for their topic. We hope these will help focus work in the future. Second, in 11 additional sections, we include descriptions of methods and protocols for *Arabidopsis* lipid analysis. To our knowledge, no similar resource has previously been available for *Arabidopsis* lipid research. This will provide an especially important guide for researchers who have not worked previously on lipids and may help standardize procedures

¹ Wirestone, L.L.C., 1235 Riverside Ave, Fort Collins, CO 80524-3218. Email: basil.shorrosh@wirestone.com

for our field. Third, we have provided a summary of lipid composition of Arabidopsis that provides easy access to data that are often difficult to find. Fifteen tables and three figures provide detailed data on the composition of membrane, storage, and surface lipids of Arabidopsis, including compositions at the organ, tissue, and subcellular levels.

We do not include in this chapter the very important roles of acyl lipids in signaling because this would involve more than 50 additional enzymes and hundreds of genes. We hope other authors will take up the challenge to include a chapter on Arabidopsis lipid signaling in *The Arabidopsis Book*.

A Brief Synopsis and History of Arabidopsis Acyl-Lipid Metabolism

Perhaps the best overview of plant acyl-lipid synthesis is provided in the textbook chapter by Somerville et al. (2000), which will be available in updated version in 2010. Other more specialized reviews can be found in the Reference section of this chapter, where they are designated with the term “Review” after the reference.

Based in large part on elegant radiolabeling studies of peas and spinach, Roughan and Slack (1982) of New Zealand first proposed that there are two distinct pathways for membrane synthesis in higher plants and named these the “prokaryotic pathway” and the “eukaryotic pathway.” The prokaryotic pathway refers to the synthesis of lipids within the plastid. The eukaryotic pathway refers to the sequence of reactions involved in synthesis of lipids in the endoplasmic reticulum (ER), transfer of some lipids between the ER and the plastid, and further modification of the lipids within the plastid. Glycerolipids synthesized by the prokaryotic pathway can be distinguished by the presence of 16:0 at the *sn-2* position of the glycerol backbone, whereas eukaryotic lipids have predominantly 18 carbon unsaturated fatty acids at *sn-2* and 16:0 is found at *sn-1*. A radiolabeling study by Browse et al. in 1986b allowed an estimate of acyl chain fluxes through the two pathways in Arabidopsis leaves. Approximately 40% of fatty acids (FAs) synthesized in chloroplasts enter the prokaryotic pathway, whereas 60% are exported to enter the eukaryotic pathway. About half of these exported FAs return to the plastid after they are desaturated in the ER and then support galactolipid synthesis for the thylakoid membranes. Thus, trafficking of lipids between chloroplasts and the ER and back is a major activity of leaf cells and an active area of research (Benning, 2009). An abbreviated scheme showing these fluxes and the mutants known at that time is shown in Figure 1 of Browse and Somerville (1991) and at www.wsu.edu:8080/IBC/faculty/jb.thefig.html.

Less well understood are the reactions of mitochondrial lipid metabolism, and these deserve more attention, particularly considering the recent evidence of a key role of mitochondria in major pathways of biosynthesis of ER lipids in yeast (Riekhof et al., 2007) and triacylglycerol (TAG) in animals (Hammond et al., 2002; Linden et al., 2006).

Sphingolipids are critical components and one of the few complex lipids in which disrupted synthesis results in lethality (Dietrich et al., 2008). Sphingolipid synthesis has been difficult to study because of the more complex techniques needed for extraction and analysis. Fortunately, major advances have occurred in the

past 5 to 10 years, including identification of genes for most of the pathway members, in most cases by homology to other organisms followed by reverse genetics.

Progress on cutin and suberin biosynthesis also was slow because of the complex nature of the structures involved and difficult analytical procedures. Early progress followed the forward genetic identification of several cuticle mutants with altered morphology. Between 2004 and 2009 the number of genes with experimental evidence for function and assignable to lipid polyester biosynthesis increased from 3 to 24, an indication of the recent rapid progress in this area. Likewise, many new genes are now assignable to the production and control of surface lipids (see Section 2.8).

Lipid degradation has received less attention than lipid biosynthesis. The genes for fatty acid β -oxidation are mostly known, but the pathways have primarily been studied during seed germination and reserve mobilization. The fact that the expression of these genes occurs in all cell types and at levels often similar to the expression of biosynthetic genes is puzzling, considering that fatty acid degradation occurs at only ~2% of the rate of synthesis in leaves (Bao et al., 2000; Bonaventure et al., 2004a; Yang and Ohlrogge, 2009). Another major enigma of any survey of genes involved in plant lipid metabolism is that there are almost as many genes that are apparently involved in lipid turnover as in lipid biosynthesis. This includes more than 200 genes annotated as lipases or acyl-hydrolases or involved in β -oxidation. However, only a small proportion of these genes have been characterized experimentally, and therefore their further exploration may be a path toward new insights.

2. SUMMARY AND PERSPECTIVES ON MAJOR PATHWAYS OF ACYL-LIPID METABOLISM IN ARABIDOPSIS

2.1. Fatty Acid Synthesis and Export (Sébastien Baud²)

Unlike in other eukaryotes, plant *de novo* fatty acid synthesis does not occur in the cytosol but in the plastid. This biosynthetic pathway of prokaryotic type is not restricted to specific tissues or organs but found in every cell of the plant. Since no transport of acetyl-coenzyme A (CoA) between subcellular compartments could be demonstrated in plant cells, plastidial acetyl-CoA is probably the unique building block used for fatty acid production. Measurements carried out in spinach and pea leaves have shown that the concentration of this two-carbon molecule in chloroplasts is low (sufficient to supply the needs of fatty acid synthesis for only a few seconds; Post-Beittenmiller et al., 1992) but fairly constant (Ohlrogge and Browse, 1995). In Arabidopsis, the most straightforward pathway that rapidly generates acetyl-CoA to maintain the pool is through the action of the plastidial pyruvate dehydrogenase complex (PDHC, Figure 1A). The PDHC is a large multienzyme structure catalyzing the oxidative decarboxylation of pyruvate to produce acetyl-CoA, CO₂, and NADH. (Johnston et al., 1997). The PDHC contains three components: E1 (pyruvate dehydrogenase, PDH, composed of E1 α and E1 β subunits), E2

² Institut Jean-Pierre Bourgin, INRA-AgroParisTech, 78026 Versailles Cedex, France. Email: sebastien.baud@versailles.inra.fr

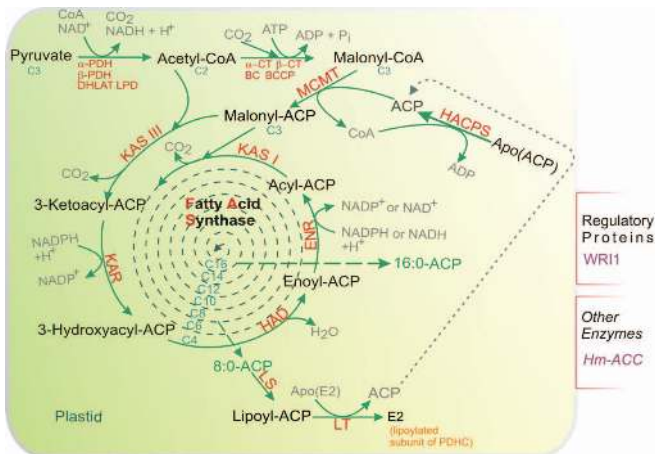

Figure 1. Fatty Acid Synthesis and Export.

(A) De Novo Fatty Acid Synthesis in Plastids of *Arabidopsis thaliana*.

The plastidial pyruvate dehydrogenase complex generates acetyl-coenzyme A that is used as a building block for fatty acid production. Fatty acids are grown by sequential condensation of two-carbon units by enzymes of the fatty acid synthase complex. During each cycle, four reactions occur: condensation, reduction, dehydration, and reduction. Acyl carrier protein is a cofactor in all reactions. Synthesis of a C16 fatty acid requires that the cycle be repeated seven times. During the first turn of the cycle, the condensation reaction is catalyzed by ketoacyl-ACP synthase (KAS) III. For the next six turns of the cycle, the condensation reaction is catalyzed by isoform I of KAS. Finally, KAS II is used during the conversion of 16:0 to 18:0.

Abbreviations: ACC, acetyl-CoA carboxylase; ACP, acyl carrier protein; BC, biotin carboxylase; BCCP, biotin carboxyl carrier protein; CT, carboxyltransferase; DHLAT, dihydrolipoamide acetyltransferase; ENR, enoyl-ACP reductase; HACPS, holo-ACP synthase; HAD, hydroxyacyl-ACP dehydratase; KAR, ketoacyl-ACP reductase; KAS, ketoacyl-ACP synthase; LPD, dihydrolipoamide dehydrogenase; LS, lipoate synthase; LT, lipoyltransferase; MCMT, malonyl-CoA: ACP malonyltransferase; PDH, pyruvate dehydrogenase; PDHC, pyruvate dehydrogenase complex.

For additional details on genes involved in these reactions, please see http://aralip.plantbiology.msu.edu/pathways/fatty_acid_synthesis.

(dihydrolipoyl acyltransferase, DHLAT), and E3 (dihydrolipoamide dehydrogenase, LPD). The E2 protein is covalently bound via an amide linkage to lipoic acid (6,8-thioctic acid or 1,2-dithiolane-3-pentanoic acid), a sulfur-containing coenzyme that is required for the catalytic activity of E1 (Lin et al., 2003). The attached lipoyl moiety functions as a carrier of reaction intermediates among the active sites of the components of the complex. E3, which belongs to a large family of flavoprotein oxidoreductases, completes the catalytic cycle by reoxidizing the lipoamide cofactor (Drea et al., 2001). Lipoic acid is synthesized from octanoic acid (see below) by the addition of two sulfur atoms into the octanoyl group bound to acyl carrier protein (ACP). This reaction is catalyzed by lipoic acid synthase (LS; Yasuno and Wada, 2002). A lipoyltransferase (LT) then transfers the lipoyl group from lipoyl-ACP to apoproteins such as E2 (Wada et al., 2001b) A PDHC bypass pathway exists in *Arabidopsis* and other plants that results in the activation of free acetate into acetyl-CoA by plastidial acetyl-CoA synthetase (ACS; Lin and Oliver, 2008). This bypass might have a role in the detoxification of ethanol, acetaldehyde, and/or acetate in veg-

etative organs. However, acetyl-CoA made from acetate by ACS is probably not a major substrate for bulk fatty acid biosynthesis (Bao et al., 2000; Oliver et al., 2009).

The first committed step in fatty acid synthesis is the formation of malonyl-CoA from acetyl-CoA and bicarbonate by acetyl-CoA carboxylase (ACC; Konishi et al., 1996). This ATP-dependent reaction takes place in two steps, which are catalyzed on two physically and kinetically distinct catalytic sites of a multisubunit heteromeric enzyme complex of prokaryotic type (Harwood, 1996). In the first step, catalyzed by the biotin carboxylase (BC) domain of ACC, CO₂ from bicarbonate is transferred to a biotin prosthetic group attached to a conserved lysine residue of biotin carboxyl carrier protein (BCCP, second domain of ACC). In the second reaction, catalyzed by the carboxyltransferase (CT) domain of ACC, the carboxyl group from carboxy-biotin is transferred to acetyl-CoA to yield malonyl-CoA. Interestingly, the CT domain of ACC is composed of associated nonidentical α-CT and β-CT subunits, the second one being plastome encoded. This is the only component of plant lipid metabolism known to be encoded by the plastid genome (Ohlrogge and Browse, 1995). Assembly of a complete ACC consequently requires coordination of cytosolic and plastid production of subunits. To date, little is known about this coordination (Ohlrogge and Jaworski, 1997). Before entering the fatty acid synthesis pathway, the malonyl group of malonyl-CoA produced by ACC has to be transferred from CoA to ACP. This transfer is catalyzed by a malonyl-CoA:acyl carrier protein malonyltransferase (MCMT).

The production of 16- or 18-carbon fatty acid is performed by fatty acid synthase (FAS), an easily dissociable multisubunit complex consisting of monofunctional enzymes (Brown et al., 2006). Acetyl-CoA is used as the starting unit, and malonyl-ACP provides two-carbon units at each step of elongation. The malonyl-thioester enters into a series of condensation reactions with acetyl-CoA, then acyl-ACP acceptors. These reactions are catalyzed by condensing enzymes called 3-ketoacyl-ACP synthases (KAS) and result in the formation of a carbon-carbon bond and in the release of one molecule of CO₂ from the malonyl-ACP. Three KAS isoforms have been identified that are required to produce an 18-carbon fatty acid. The initial condensation reaction of acetyl-CoA and malonyl-ACP is catalyzed by KAS isoform III (KASIII), yielding a four-carbon product (3-ketobutyl-ACP). Subsequent condensations (up to 16:0-ACP) require a second enzyme, namely KASI, whereas the final elongation of the 16-carbon palmitoyl-ACP to the 18-carbon stearoyl-ACP is catalyzed by a third condensing enzyme, KASII (Pidkowich et al., 2007; Figure 1B). In addition to the condensing reaction, the successive addition of two-carbon units to the growing fatty acyl chain requires the participation of two reductases and a dehydratase. The 3-ketoacyl-ACP is first reduced by a 3-ketoacyl-ACP reductase (KAR), which uses NADPH as the electron donor; 3-hydroxyacyl-ACP is then subjected to dehydration by the enzyme hydroxyacyl-ACP dehydratase (HAD), and the enoyl-ACP thus obtained is finally reduced by the enzyme enoyl-ACP reductase (ENR), which uses NADH or NADPH to form a saturated fatty acid (Mou et al., 2000). Whereas some 16:0-ACP is released from the FAS machinery, molecules elongated to 18:0-ACP are efficiently desaturated by a stromal Δ⁹ stearoyl-ACP desaturase (SAD). Long-chain acyl groups are then hydrolyzed by acyl-ACP thioesterases that release fatty acids. These fatty acids are ultimately activated to CoA esters by a long-chain

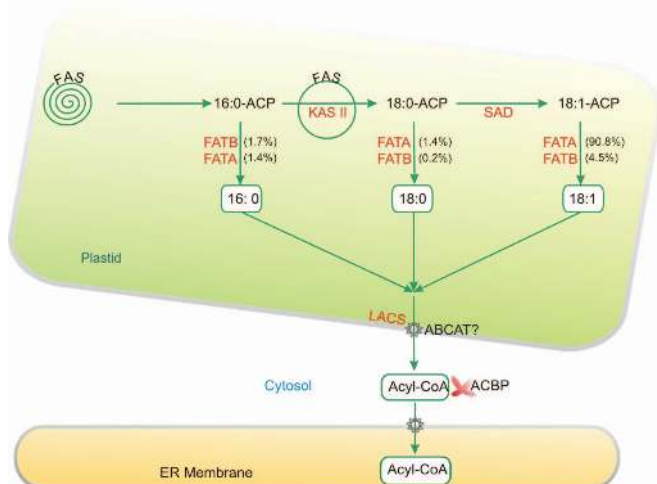

Figure 1. (continued)

(B) Fatty Acid Elongation, Desaturation, and Export From Plastid.

C16:0 fatty acids produced by the pathways shown in Figure 1A can enter three possible reactions. First, they can be elongated by an additional cycle of fatty acid synthesis. In these cases, KAS II is used during the conversion of 16:0 to 18:0. Alternatively, C16:0 can enter the prokaryotic glycerolipid pathway as shown in Figure 2. Finally, 16:0-ACP can be hydrolyzed by FATA thioesterase to release free fatty acids that are exported from the plastid. Most 18:0-ACP produced by elongation is desaturated by the stearyl-ACP desaturase. The resulting 18:1-ACP can either enter the prokaryotic glycerolipid pathway (Figure 2) or be hydrolyzed by FATA for export from the plastid.

Abbreviations: ABCAT, ABC acyl transporter; ACBP, acyl-CoA binding protein; ACP, acyl carrier protein; FAS, fatty acid synthase; FATA (B), fatty acyl thioesterase A (B); KAS, ketoacyl-ACP synthase; LACS, long-chain acyl-CoA synthetase; SAD, stearyl-ACP desaturase.

For additional details on genes involved in these reactions, please see http://aralip.plantbiology.msu.edu/pathways/fatty_acid_elongation_desaturation_export_from_plastid.

acyl-CoA synthetase (LACS) and exported to the endoplasmic reticulum or possibly enter PC at the plastid envelope by the action of lysophosphatidylcholine acyltransferase (LPCAT; Kjellberg et al., 2000; Bates et al., 2007).

The use of DNA microarrays has provided detailed expression patterns for genes involved in plant metabolic processes like fatty acid biosynthesis (Schmid et al., 2005). These data indicate that a number of genes encoding core fatty acid synthesis enzymes are likely to be coregulated at the transcriptional level (Mentzen et al., 2008). For instance, these genes are induced in a coordinated manner at the onset of seed maturation in embryonic tissues storing oil to high levels (Girke et al., 2000; Ruuska et al., 2002; Baud and Lepiniec, 2009). Transcription factors or proteins regulating mRNA turnover can control these changes in mRNA levels. So far, a single transcription factor has been isolated that constitutes a good candidate for the transcriptional regulation of the fatty acid biosynthetic pathway: It is called WRINKLED1 (WR1) and belongs to the APETALA2-ethylene responsive element-binding protein (AP2-EREBP) family (Cernac and Benning, 2004; Baud et al., 2007). Beyond transcriptional regulations, control of fatty acid

biosynthesis also relies on optimization of enzyme activity (Buckhout and Thimm, 2003). For instance, experimental data obtained with spinach leaves or tobacco suspension cells have pointed out a modulation of ACC activity by light/dark and feedback regulation by exogenous fatty acid supply (Post-Beittenmiller et al., 1991; Shintani and Ohlogge, 1995). However, data concerning the posttranscriptional regulations affecting fatty acid biosynthesis in Arabidopsis are scarce.

Major unanswered questions:

1. Where exactly in the stroma are the enzymes involved in fatty acid biosynthesis localized? Does any substrate channeling occur between the different complexes involved in the pathway?
2. Are all the genes involved in de novo fatty acid biosynthesis controlled by the same transcriptional regulatory complex? What are the components of this complex?
3. What are the posttranscriptional and metabolic controls regulating fatty acid biosynthesis? What are the cross talks between metabolic, transcriptional, and posttranscriptional regulatory networks?

2.2. Plastid Glycerolipid Synthesis

(Mats X. Andersson³ and Amélie A. Kelly⁴)

The photosynthetic membranes of higher plant chloroplasts consist of four main classes of glycerolipids: mono- (MGDG) and digalactosyldiacylglycerol (DGDG), the phospholipid phosphatidylglycerol (PG), and the sulfolipid sulfoquinovosyldiacylglycerol (SQDG). The thylakoid membrane is more or less exclusively composed of these lipids. The inner envelope is similar in lipid composition to the thylakoid, although it harbors significantly fewer membrane-spanning proteins. The outer envelope membrane contains a higher proportion of typical eukaryotic lipids such as the phospholipid phosphatidylcholine (PC). Chloroplast galactolipids contain a large proportion of trienoic fatty acids (Moreau et al., 1998; Andersson and Dörmann, 2008). The functional roles of the thylakoid lipids also go beyond their purely structural function (Dörmann and Benning, 2002). Specific lipids are deeply embedded into the photosynthetic complexes (Jordan et al., 2001; Loll et al., 2005, 2007), and fatty acids derived from plastid lipids function as precursors for potent signaling molecules (Feussner and Wasternack, 2002). Much of what is known about chloroplast lipid biosynthesis relies on biochemical studies on isolated chloroplast fractions, and most of the pathways were quite well established by the early 1990s. The advent of molecular genetics saw the cloning and identification of most major enzymes in Arabidopsis.

Most of the different membrane lipids in the chloroplast are assembled in the envelope membranes. The diacylglycerol backbones for chloroplast lipid synthesis are derived from two different

³Department of Plant- and Environmental Sciences, University of Gothenburg, Box 461, SE-405 30 Göteborg, Sweden. Email: mats.andersson@dpes.gu.se

⁴Warwick HRI, University of Warwick, Wellesbourne, Warwickshire, CV35 9EF, UK. Email: a.a.b.kelly@warwick.ac.uk

pathways, the ER-localized eukaryotic pathway and the inner-envelope-localized prokaryotic pathway (Ohlrogge and Browse, 1995). These are easily distinguished on the basis of the fatty acid specificity of the *sn*-2 acyltransferases. The ER-localized enzyme has a high specificity for C18 fatty acids, whereas the plastid-localized enzyme has a strong preference for C16 fatty acids. Thus, a C16 fatty acid on the *sn*-2 position is a signature for plastidial origin of a diacylglycerol backbone. All plants rely on the plastid pathway for assembly of thylakoid PG, but some plants, like Arabidopsis, also use the plastidial pathway for synthesis of the plastid galactolipids. Thus, Arabidopsis chloroplast galactolipids contain a high proportion of 16:3 fatty acids. Arabidopsis is referred to as a 16:3 plant, whereas other plants not using the plastidial pathway for plastid galactolipid synthesis are referred to as 18:3 plants. To feed the eukaryotic galactolipid synthesis, diacylglycerol (DAG) backbones derived from ER-localized lipid biosynthesis are transported by a still unknown mechanism to the chloroplast envelope (Moreau et al., 1998; Andersson and Dörmann, 2008). The exact identity of the transported lipid has been a matter of debate; however, as a minimum requirement there has to be a transfer mech-

anism for PC, as this phospholipid is synthesized in the ER but also present in the outer chloroplast envelope. The exact transport mechanism is not well understood, although much recent progress has been made (Benning, 2008, 2009; see Section 2.7).

The prokaryotic diacylglycerol backbones are assembled by the two inner-envelope-localized proteins acyltransferase 1 (ATS1) (Kunst et al., 1988; C.C. Xu et al., 2006) and ATS2 (Kim et al., 2004; Bin et al., 2004). Loss of ATS2 activity is embryo lethal, whereas loss of ATS1-activity seems to be less serious. The phosphatidic acid (PA) produced in the inner envelope can be directly used for PG synthesis in the inner envelope. This requires the three enzymes CDP-DAG synthase, PG-phosphate synthase, and PG-phosphate phosphatase (Andrews and Mudd, 1985). Of these three, the identity of the Arabidopsis gene encoding only the PG-phosphate synthase is known to date (Muller and Frentzen, 2001; Babiychuk et al., 2003). PA not channeled into

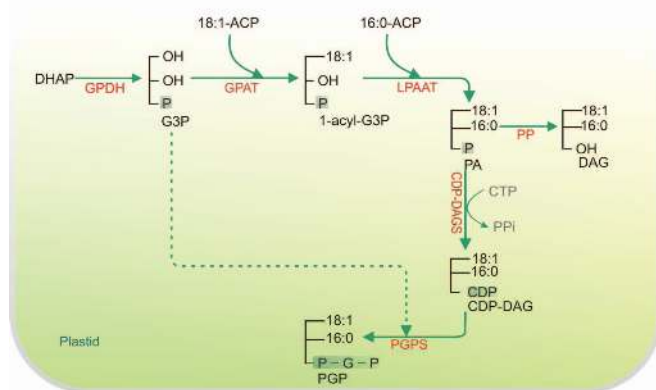

Figure 2. Prokaryotic Galactolipid, Sulfolipid, and Phospholipid Synthesis.

(A) The pool of diacylglycerol (DAG) backbones for the so-called prokaryotic lipid synthesis is generated exclusively and entirely inside the plastid: Dihydroxyacetonephosphate (DHAP) is reduced to glycerol 3-phosphate (G3P), which is then first acylated at the *sn*-1 position with an activated fatty acid (18:1 ACP) by glycerol-3-phosphate acyltransferase (GPAT) to lysophosphatidic acid (LPA). LPA in turn is then acylated at the *sn*-2 position with 16:0 by the lysophosphatidic acid acyltransferase (LPAAT) to phosphatidic acid (PA). The specificity of this particular acyltransferase for C16 fatty acids distinguishes the prokaryotic from the eukaryotic lipids. PA is either dephosphorylated by PA phosphatase (PP) to DAG, which serves as precursor for galactolipid and sulfolipid biosynthesis (see diagram B), or a CDP-DAG synthase (CDP-DAGS) uses PA to synthesize activated CDP-DAG, which—together with G3P—is required for phosphatidylglycerol phosphate (PGP) synthesis, the precursor of phosphatidylglycerol (PG).

Abbreviations: CDP-DAGS, CDP-DAG synthase; DAG, diacylglycerol; DHAP, dihydroxyacetonephosphate; G3P, glycerol 3-phosphate; GPAT, glycerol-3-phosphate acyltransferase; LPA, lysophosphatidic acid; LPAAT, lysophosphatidic acid acyltransferase; PA, phosphatidic acid; PP, PA phosphatase; PGP, phosphatidylglycerol phosphate; PG, phosphatidylglycerol.

For additional details on genes involved in these reactions, please see http://aralip.plantbiology.msu.edu/pathways/prokaryotic_galactolipid_sulfolipid_phospholipid_synthesis

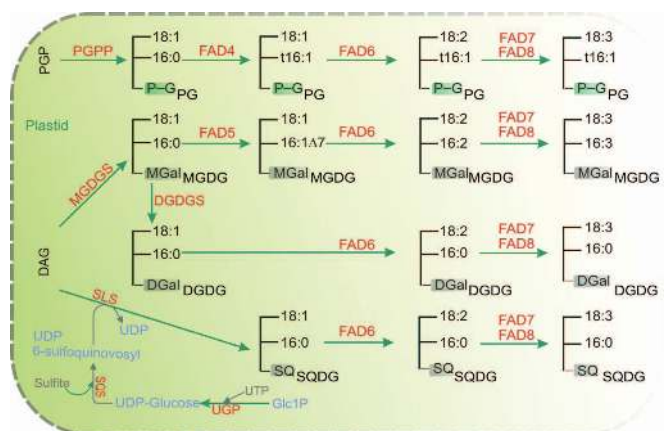

Figure 2. (continued)

(B) PGP is dephosphorylated by the PGP phosphatase (PGPP) to phosphatidylglycerol (PG), which is subjected to several desaturation steps. The relevant fatty acid desaturases (FADs) insert *cis* (or *trans* Δ^3 for 16:0 at the *sn*-2 position of PG) double bonds at specific sites in the acyl groups at the *sn*-1 or *sn*-2 position. The monogalactosyldiacylglycerol transferase (MGDGS) transfers a galactose moiety from UDP-galactose to DAG, thus generating monogalactosyldiacylglycerol. A small proportion of this MGDG is subsequently glycosylated by the also UDP-galactose-dependent digalactosyldiacylglycerol synthase (DGDGS) to digalactosyldiacylglycerol (DGDG) carrying two galactose molecules in its headgroup. Both MGDG and DGDG acyl chains are also characterized by a high degree of desaturation introduced by the various FAD (fatty acid desaturase) enzymes. The first step of sulfoquinovosyldiacylglycerol (SQDQG) synthesis is performed by the UDP-glucose pyrophosphorylase (UGP), which catalyzes the formation of UDP-glucose from glucose-1-phosphate and UTP (UGP3Glc1P). UDP-Sulfoquinovose Synthase (SQS) then condenses UDP-Glucose with sulfite to generate UDP 6-sulfoquinovosyl, which is then transferred by the sulfolipid synthase (SLS) on to DAG to serve as sugar donor for the headgroup. Again, the acyl chains in SQDQG are desaturated by the various FAD enzymes.

Abbreviations: FAD, fatty acid desaturases; MGDGS, monogalactosyldiacylglycerol transferase; PG, phosphatidylglycerol; PGPP, PGP phosphatase; SLS, sulfolipid synthase; SQDQG, sulfoquinovosyldiacylglycerol; SQS, UDP-sulfoquinovose synthase.

For additional details on genes involved in these reactions, please see http://aralip.plantbiology.msu.edu/pathways/prokaryotic_galactolipid_sulfolipid_phospholipid_synthesis_2

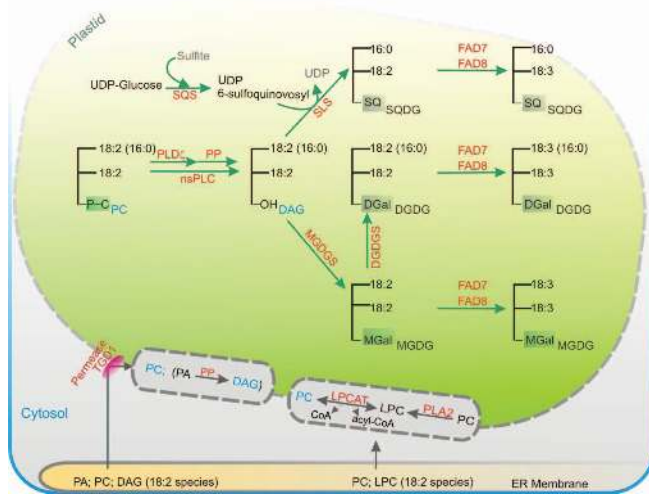

Figure 3. Eukaryotic Galactolipid and Sulfolipid Synthesis.

The eukaryotic galactolipid and sulfolipid pathway differs from its prokaryotic version with regard to the DAG backbone, which is derived from eukaryotic PC and is characterized by a C18 acyl chain in the *sn*-2 position as well as C16:0 at the *sn*-1 position in some cases. The exact route and identity of the transported lipid moiety or moieties from the ER is still unknown, yet several possibilities have been discussed: DAG precursors are transported into the plastid involving TGD1, a permease-like protein of the inner chloroplast envelope. Other possibilities involve transport of PC to the chloroplast, where it is then either dephosphorylated by a nonspecific phospholipase C (nsPLC) to DAG or first hydrolyzed to PA by phospholipase D (PLD ζ) and then dephosphorylated to DAG by PA phosphatase (PP). Instead of a direct transport, lysophosphatidylcholine (LPC), generated by the phospholipase A2 (PLA2), has also been suggested as a possible intermediate for PC transport into the chloroplast, where acylation by the lysophosphatidylcholine acyltransferase (LPCAT) would revert it to PC. Starting from DAG, the prokaryotic and eukaryotic pathways share the same activities, but they are sometimes encoded by an extra/different set of genes (see text). Note that when a C16:0 acyl chain is present at the *sn*-1 position, it is not desaturated.

Abbreviations: DAG, diacylglycerol; FAD, fatty acid desaturase; LPCAT, lysophosphatidylcholine acyltransferase; nsPLC, nonspecific phospholipase C; PC, phospholipid choline; PLD ζ , phospholipase D; PA, phosphatidic acid; PP, PA phosphatase; PP, phosphatidate phosphatase; PLA2, phospholipase A2; TGD1, permease-like protein of inner chloroplast envelope.

For additional details on genes involved in these reactions, please see http://aralip.plantbiology.msu.edu/pathways/eukaryotic_galactolipid_sulfolipid_synthesis

PG synthesis is dephosphorylated to DAG by an inner-envelope-localized PA-phosphatase (Ohlrogge and Browse, 1995). Again, the identity of this enzyme remains elusive, although a family of bacterial-derived PA-phosphatases (PPs) localized in the envelope was recently demonstrated (Nakamura et al., 2007).

The galactolipids are synthesized in the envelope by two different galactosyltransferase activities, each transferring a galactose moiety from UDP-Gal to the head group of DAG or MGDG (Kelly and Dörmann, 2004; Andersson and Dörmann, 2008). The anomeric configuration of the resulting galactolipids is always a β -glycosidic linkage to the first sugar and an α -glycosidic linkage to the second. Additionally, in isolated chloroplasts (Wintermans et al., 1981; Heemskerk et al., 1988; Kelly et al., 2003) and cer-

tain mutants (C.C. Xu et al. 2003; Awai et al., 2006; B.B. Lu et al., 2007; C.C. Xu et al., 2008) there is also a processive galactosyl transferase activity, resulting in all β di, tri- and tetragalactosyl diacylglycerol. Before the cloning of DGD1 and 2, this was thought to be the major pathway in DGDG synthesis. The acidic sulfolipid SQDG can to a certain degree compensate for loss of PG, and this probably has a role under phosphate efficiency (Yu and Benning, 2003). SQDG is assembled in the chloroplast envelope in much the same way as MGDG (Benning, 2008). Sulfoquinovosyl is transferred from a UDP conjugate onto the head group of DAG. UDP-sulfoquinovosyl is assembled in the plastid stroma from sulfite and UDP-glucose, which in turn is synthesized by the recently discovered UDP-glucose pyrophosphorylase 3 (Okazaki et al., 2009). Acyl lipids synthesized in the plastid envelope are subject to further desaturation by envelope or thylakoid-bound desaturases (Shanklin and Cahoon, 1998). These are responsible for the typical plastid lipid fatty acid desaturation signature, including 16:3 and 16:1 Δ^3 , which are generally considered as exclusively plastidial. All the genes encoding chloroplast-localized lipid desaturases (*FAD5*, *6*, *7* and *8*) have been identified or cloned, along with the recent identification of *FAD4*, which introduces the *trans*-3 double bond in palmitic acid in plastid PG (Gao et al., 2009). Two other “FAD4-like” genes are in the Arabidopsis genome, but their function has not yet been identified. In addition, several “FAD5-like” desaturases, also previously referred to as “acyl-CoA desaturase-like,” are of uncertain function and subcellular location (Heilmann et al., 2004).

In contrast to MGDG (a non-bilayer-prone lipid), DGDG is a bilayer-forming lipid like most phospholipids. DGDG can therefore act as surrogate lipid to ensure membrane homeostasis during phosphate-limited growth. During these conditions DGDG is also exported from the chloroplast and replaces phospholipids in several other organelles and membranes (Härtel et al., 2000) such as the plasma membrane (Andersson et al., 2003, 2005), tonoplast (Andersson et al., 2005), and mitochondria (Jouhet et al., 2004). Galactolipid synthesis for extraplastidial membranes and in several other nongreen tissues is mediated by an additional set of galactolipid synthases, MGD2 and 3 (Awai et al., 2001; Kobayashi et al., 2004, 2009) and DGD2 (Kelly and Dörmann, 2002; Klaus et al., 2002). The synthesis of exported DGDG likely takes place in the outer envelope, and the exported DGDG has a lipid species composition resembling that of extraplastidial phospholipids (16:0 at the *sn*-1 position and 18:2 at the *sn*-2 position, Härtel et al., 2000; Kelly et al., 2003). Two PPs from the eukaryotic phospholipid metabolism have been identified recently, and it has been suggested that they are involved in generating DAG for eukaryotic galactolipid synthesis during phosphate-limited growth (Nakamura et al., 2009).

Major unanswered questions:

1. What are the molecular details of the ER-to-plastid lipid transport, and what is the main precursor for eukaryotic DAG in the plastid?
2. What is the function of the FAD4-like and FAD5-like sequences in the Arabidopsis genome?
3. How is plastid lipid synthesis regulated?
4. How is transport of membrane lipids inside the plastid mediated, and what is the molecular function of vesicle-induced protein in plastids 1 (*VIPP1*; see Section 2.7)?

2.3. Eukaryotic Phospholipid Synthesis

(Ikuo Nishida⁵ and Philip D. Bates⁶)

2.3.1. Eukaryotic lipid molecular species

The ER is the major site for phospholipid biosynthesis. PA, the common precursor to phospholipids, is synthesized via serial reactions catalyzed by acyl-CoA:glycerol-3-phosphate acyltransferase (GPAT) and acyl-CoA:lysophosphatidic acid acyltransferase (LPAAT). PAs that originate from the ER pathway exclusively contain C18 fatty acids in the *sn*-2 position (eukaryotic molecular species), whereas PAs synthesized in plastids exclusively contain C16 fatty acids in the *sn*-2 position (prokaryotic molecular species).

2.3.2. Enzymes required for phospholipid biosyntheses

Eight plant-specific and membrane-bound GPAT family members - GPAT1 to GPAT7 (Zheng et al., 2003) and GPAT8 (Beisson et al., 2007) - were originally considered as candidates for the first reaction of membrane glycerolipid assembly. However, GPAT1 to GPAT3 have putative mitochondrial targeting signals, but only GPAT1 is shown to be targeted to mitochondria and exhibit GPAT activity (Zheng et al., 2003). GPAT4 to GPAT7 also exhibit GPAT activity (Zheng et al., 2003). However, *gpat5* is altered in suberin and not membrane lipids (Beisson et al., 2007), whereas *gpat4* *gpat8* mutants show defects in cutin biosynthesis (Y.H. Li et al., 2007a). Recent results have also identified GPAT6 as involved in cutin biosynthesis in flowers (Li-Beisson et al., 2009). It now appears this family may be primarily involved in the synthesis of extracellular lipids. The GPAT(s) that initiate the eukaryotic phospholipid biosynthetic pathway remains elusive but may include "GPAT9," a member of the membrane bound *O*-acyl transferase (MBOAT) family and a homolog of animal GPATs (Gidda et al., 2009). ER-localized LPAATs are homologs of yeast SLC1 (Nagiec et al., 1993). Arabidopsis LPAAT2 is a ubiquitous ER-localized LPAAT, whereas LPAAT3 is predominantly expressed in pollen (Kim et al., 2005). The identity of LPAAT4 and LPAAT5 as LPAATs remains to be elucidated.

DAG is the substrate for PC and phosphatidylethanolamine (PE) biosynthesis via the CDP-choline (CDP-Cho) and CDP-ethanolamine (CDP-Etn) pathways, respectively. DAG is produced by PPs. Yeast has Mg²⁺-dependent soluble PPs (Carman, 1997); one such gene, PAH1, commits PA → DAG conversion for TAG biosynthesis (Han et al., 2006). Arabidopsis contains two orthologs of yeast PAH1 (AtPAH1 and AtPAH2), which have recently been shown to be involved in the phospholipase D-mediated pathway to produce DAG from ER phospholipids for eukaryotic galactolipid synthesis in the plastid. The double knockout of AtPAH1 and AtPAH2 is partially impaired in the turnover of ER phospholipids during times of phosphate stress (Nakamura et al., 2009). Yeast also contains Mg²⁺-independent membrane-bound phospholipid

phosphatases (PLPs), which convert PA and diacylglycerol pyrophosphate (DGPP) to DAG (Carman 1997). *AtLPP1–AtLPP3* (Pierrugues et al., 2001) and *AtLPP4* (Katagiri et al., 2005) appear to be regulators of PA and/or DGPP signaling rather than of lipid biosynthesis.

Eukaryotes synthesize PE via the CDP-ethanolamine pathway and/or the phosphatidylserine (PS) decarboxylation pathway. In Arabidopsis, PS decarboxylase 1 (PSD1) is localized in mitochondria, whereas PSD2 and PSD3 are localized in endomembranes (Nerlich et al., 2007). The CDP-ethanolamine pathway includes serial reactions catalyzed by ethanolamine kinase (EK), CTP:phosphorylethanolamine cytidyltransferase (PECT), and CDP-ethanolamine:DAG ethanolaminephosphotransferase (EPT). Arabidopsis contains a single gene for a putative EK (At2g26830; Tasseva et al., 2004). EKs purified from other plants have been shown to be specific for Etn (Macher and Mudd, 1976; Wharfe and Harwood, 1979). Arabidopsis PECT1 is localized in the outer layer of mitochondria, and the embryonic lethality of the null mutant *pect1-6* suggests that Arabidopsis synthesizes PE via the CDP-ethanolamine pathway (Mizoi et al., 2006).

In eukaryotes, PC is synthesized via the CDP-choline pathway and/or PE methylation pathway. No homolog is found in Arabidopsis for a novel PC synthase found in some bacteria (Sohlenkamp et al., 2000; López-Lara and Geiger, 2001). The CDP-choline pathway includes serial reactions catalyzed by choline kinase (CK), CTP:phosphorylcholine cytidyltransferase (CCT), and CDP-choline:DAG cholinephosphotransferase (CPT). Arabidopsis contains three genes for CK—CK1 (At1g71697), At1g74320, and At4g09760 (Tasseva et al., 2004). The homologous genes from soybean have been shown to strictly utilize choline (Monks et al., 1996). *CK* (At4g09760) responds relatively strongly to salt stresses (Tasseva et al., 2004). Arabidopsis contains the two *CCT* genes *CCT1* and *CCT2* (Inatsugi et al., 2002). The knockout mutants *cct1* and *cct2* grow indistinguishably from the wild type (WT), indicating that either of the isogenes is sufficient for PC biosynthesis at ambient temperature (Inatsugi and Nishida, unpublished data).

The PE methylation pathway to PC biosynthesis includes PE methylase and *N*-methylphospholipid methyltransferase (PLMT). Arabidopsis has no homolog for PE methylase. AtPLMT methylates monomethyl- and dimethyl-PE, as revealed by yeast mutant complementation (Keogh et al., 2009). The knockout mutant *plmt* accumulates monomethyl-PE with no effect on PC levels, suggesting a bypass role of PLMT in PC biosynthesis. Arabidopsis may synthesize CDP-monomethylethanolamine by CCTs and/or PECT1.

In yeast and mammals, CPT and EPT are distinct enzymes. In plants, however, aminoalcoholphosphotransferases (AAPT) play a dual role for CPT and EPT (Dewey et al., 1994). Arabidopsis and Chinese cabbage (*Brassica campestris*) contain *AAPT1* and *AAPT2* (Min et al., 1997; Goode et al., 1999; Choi et al., 2000), and *Brassica napus* *AAPT1* utilizes both CDP-Cho and CDP-Etn with some preference for CDP-Cho (Qi et al., 2003). *AAPT2* may also show dual substrate specificity, although it remains unclear if *AAPT2* shows some preference toward CDP-Etn. Because AAPTs are ER-localized enzymes and PECT1 is associated with mitochondria, coordination between ER and mitochondria may exist in Arabidopsis for PE biosynthesis via the CDP-Etn pathway.

⁵ Division of Life Science, Graduate School of Science and Engineering, Saitama University, Shimo-Okubo 255, Sakura-ku, Saitama, 338-8570, Japan. Email: nishida@molbiol.saitama-u.ac.jp

⁶ Institute of Biological Chemistry, Washington State University, Pullman, WA. Email: phil_bates@wsu.edu

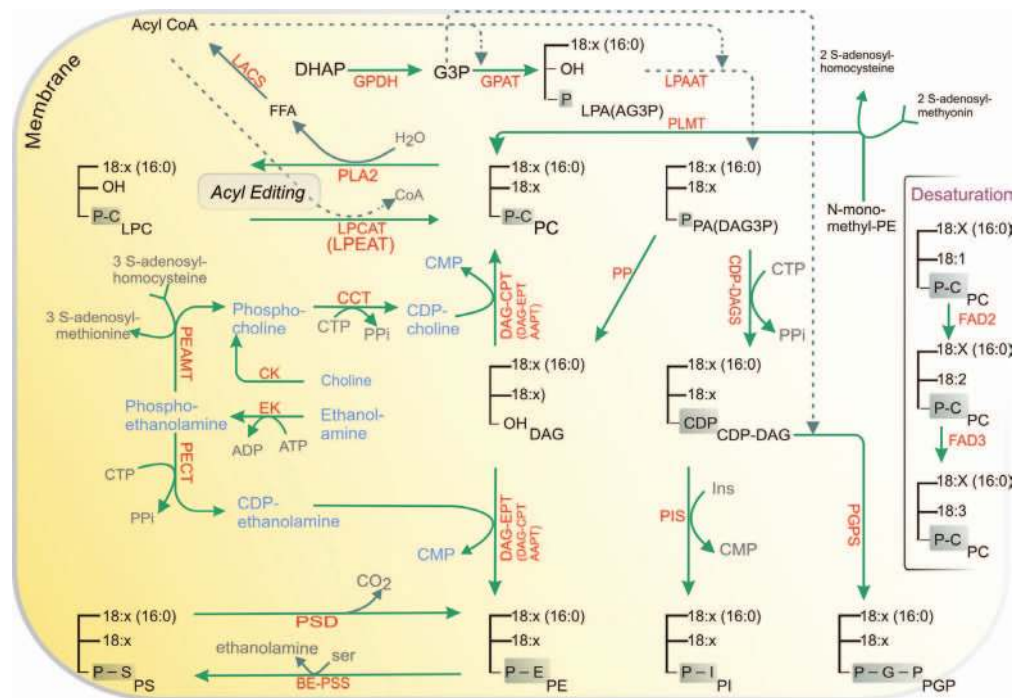

Figure 4. Eukaryotic Phospholipid Synthesis and Editing.

G3P produced by GPDH is converted to PA by sequential acylation reactions regulated by GPAT and LPAAT. PA is converted to CDP-DAG, from which PI is produced by PIS. Alternatively, the PA is hydrolyzed to DAG by PP. DAGs are combined with CDP-choline and CDP-ethanolamine to produce PC and PE, respectively; the enzyme responsible for these reactions (AAPT) may have dual substrate specificity. Phosphoethanolamine produced by EK is an important intermediate for PE and PC biosyntheses. Cytosolic CKs also provide phosphocholine for PC biosynthesis from free choline, which may be recovered from PC by PLDs or derived from other tissues by phloem translocation. Phosphoethanolamine is converted to PE via CDP-ethanolamine, whereas the same substrate is methylated to phosphocholine by PEAMT and then converted to PC via CDP-choline. PE is a substrate for PS biosynthesis by BE-PSS, whereas PS is converted to PE by PSD. PC is the major substrate for desaturation and acyl editing. Acyl editing involves a dynamic exchange of fatty acids predominantly between the *sn*-2 (but also *sn*-1) position of PC and acyl-CoA pools, which may be regulated by PLA2 and LPCAT. PLMT catalyzes a putative pathway to PC via methylation of methyl-PE. In addition to the above pathways, the conversion of PGP to PG by PGP phosphatase (PGPP) is not shown.

Abbreviations: AAPT, aminoalcoholphosphotransferase; BE-PSS, base-exchange-type phosphatidylserine synthase; CCT, CTP:phosphorylcholine cytidyltransferase; CDP-DAGS, CDP-diacylglycerol synthetase; CK, choline kinase; DAG, diacylglycerol; DAG-CPT, CDP-choline:diacylglycerol cholinephosphotransferase; DAG-EPT, CDP-ethanolamine:diacylglycerol cholinephosphotransferase; DHAP, dihydroxyacetone phosphate; EK, ethanolamine kinase; FAD2, oleate desaturase; FAD3, linoleate desaturase; G3P, glycerol-3-phosphate; GPAT, glycerol-3-phosphate acyltransferase; GPDH, glycerol-phosphate dehydrogenase; LACS, long chain acyl-CoA synthetase; LPA, lysophosphatidic acid; LPAAT, lysophosphatidic acid acyltransferase; LPC, lysophosphatidylcholine; LPCAT: lysophosphatidylcholine acyltransferase; PA, phosphatidic acid; PC, phosphatidylcholine; PE, phosphatidylethanolamine; PEAMT, phosphoethanolamine N-methyltransferase; PECT, CTP:phosphorylethanolamine cytidyltransferase; PG, phosphatidylglycerol; PGP, phosphatidylglycerophosphate; PGPS, phosphatidylglycerophosphate synthase; PI, phosphatidylinositol; PIS, phosphatidylinositol synthase; PLA2, PLMT, N-methylphospholipid methyltransferase; phospholipase A2 (Cytosolic); PLD, phospholipase D; PP, phosphatidate phosphatase; PS, phosphatidylserine; PSD, phosphatidylserine decarboxylase.

For additional details on genes involved in these reactions, please see http://aralip.plantbiology.msu.edu/pathways/eukaryotic_phospholipid_synthesis_editing

2.3.3. Biosynthesis of acidic phospholipids

CDP-DAG synthase (CDP-DAGS) catalyzes $\text{CTP} + \text{PA} \rightarrow \text{CDP-DAG} + \text{PPi}$ (Kopka et al., 1997). In eukaryotes, CDP-DAG serves as a substrate for phosphatidylinositol (PI), PG, and PS biosyntheses. Arabidopsis, however, does not contain CDP-DAG-dependent PS synthase. In *Escherichia coli* and yeast, PS is exclusively synthesized by CDP-DAG-dependent PS synthase. In mammals, PS is synthesized by base-exchange-type PS synthase (BE-PSS): PSS1 catalyzes $\text{PC} + \text{serine (Ser)} \rightarrow \text{Cho} + \text{PS}$, whereas PSS2 catalyzes $\text{PE} + \text{Ser} \rightarrow \text{Etn} + \text{PS}$

(Kuge and Nishijima, 2003). Arabidopsis has an ortholog of BE-PSS (AtPSS1); preliminary experiments using a recombinant AtPSS1 expressed in *E. coli* suggested that PE may serve as a substrate for PS biosynthesis in Arabidopsis (Yamaoka and Nishida, unpublished data).

PI is synthesized from CDP-DAG and *myo*-inositol (Ino). Two types of PI synthase (PIS), designated PIS1 and PIS2, have been identified (Xue et al., 2000; Löffke et al., 2008). Both isozymes are localized in ER and Golgi membranes (Löffke et al., 2008). PIS1 expressed in *E. coli* catalyzes the reversible reaction $\text{CMP} + \text{PI} \rightarrow \text{CDP-DAG} + \text{Ino}$ (Justin et al., 2002). The catalytic activity requires

Mg²⁺ (Xue et al., 2000) or Mn²⁺ (Justin et al., 2002). PIS2 prefers unsaturated CDP-DAG molecular species, whereas PSI1 prefers saturated CDP-DAG molecular species (Löffke et al., 2008). PIS1 overexpression increases PI molecular species with saturated fatty acids as well as PE and DAG, whereas PIS2 overexpression increases PI and phosphoinositides, both of which contain unsaturated fatty acids (Löffke et al., 2008).

PG synthesis proceeds in two steps: phosphatidylglycerol phosphate (PGP) synthase (PGPS) catalyzes CDP-DAG + glycerol-3-phosphate (G3P) → PGP + CMP, and PGP phosphatase (PGPP) catalyzes dephosphorylation of PGP to produce PG. PGPS1 and PGPS2 are responsible for PG biosynthesis in Arabidopsis (Müller and Frentzen, 2001; Hagio et al., 2002; C.C. Xu et al., 2002); PGPS1 shows dual localization in plastids and mitochondria (Babiychuk et al., 2003), whereas PGPS2 is targeted to ER in yeast cells (Müller and Frentzen, 2001).

2.3.4. Fatty acid desaturation and acyl editing

Acyl groups esterified to PC are the site of extraplastidic FA desaturation (Sperling et al., 1993). The FAD2 (Okuley et al., 1994) and FAD3 (Browse et al., 1993) enzymes convert PC-bound oleate to linoleate and then linolenate, respectively. However, the GPAT and LPAAT reactions of phospholipid synthesis (or triacylglycerol synthesis) utilize a mixed pool of acyl-CoA substrates (16:0, 18:1-3, etc.) that in many tissues is produced mostly from a PC acyl editing cycle. The PC acyl editing cycle involves rapid deacylation of PC, generating lyso-PC and releasing the FA or acyl-CoA to the mixed acyl-CoA pool. Reacylation of lyso-PC with a different acyl-CoA from the mixed pool completes the cycle. *Acyl editing*, also termed *remodeling*, is defined as any process that exchanges acyl groups between polar lipids (mostly different PC molecular species) but that does not by itself result in the net synthesis of the polar lipids. Since the acyl editing cycle does not result in net synthesis of glycerolipids, the total flux is not constrained by the rate of FA synthesis or G3P acylation. The total rate of PC acyl editing has been estimated to be 4x and 20x the rate of FA synthesis in developing seeds and leaves, respectively (Bates et al., 2007, 2009). Newly synthesized FA exported from the plastid (16:0, 18:1) enter the mixed pool of acyl-CoA involved in acyl editing and because of the high acyl editing flux are more rapidly incorporated into PC than esterified to G3P by the GPAT and LPAAT reactions of de novo glycerolipid synthesis (Bates et al., 2007, 2009). The integration of FA synthesis and PC acyl editing limits accumulation of relatively saturated membrane lipid molecular species (e.g., 16:0/18:1 and 18:1/18:1), which may affect membrane fluidity, especially at cold temperatures (Tasseva et al., 2004). Acyl editing may proceed by CoA:PC acyl exchange, producing lyso-PC and acyl-CoA (Stymne and Stobart, 1984), or by phospholipase cleavage of FA from the *sn*-1 or *sn*-2 position of PC, generating lyso-PC and an FA that is reesterified to CoA by LACS. Completion of the acyl editing cycle involves re-esterification of lyso-PC by LPCAT at the *sn*-1 or *sn*-2 position (Sperling and Heinz, 1993). PC acyl editing has been demonstrated through in vivo radiolabeling experiments in expanding pea leaves (Bates et al., 2007), mature *B. napus* leaves (Williams et al., 2000), developing safflower and sunflower cotyledons (Griffiths et al., 1988), developing soybean embryos (Bates et al.

2009), and developing Arabidopsis seeds (Bates, unpublished data). The Arabidopsis enzymes involved in acyl editing have not been identified yet, but they may include the family of lysophospholipid acyltransferases that have recently been characterized (LPLAT1 and LPLAT2; Stahl et al., 2008). Two other LPLATs with preference for lysophosphatidylethanolamine have also been identified in Arabidopsis (Stalberg et al., 2009).

2.3.5. Soluble substrates for phospholipid biosynthesis

G3P is synthesized either from reduction of dihydroxyacetone phosphate (DHAP) by G3P dehydrogenases (GPDH; At2g40690 and At2g41540) or by phosphorylation of glycerol by glycerol kinase (GKI; At1g80460). Ethanolamine is produced from L-serine by serine decarboxylase (SDC, Rontein et al., 2001). Phosphorylcholine is produced by phosphorylethanolamine *N*-methyltransferase (PEAMT; Mou et al., 2002). A silencing line for *PEAMT*, which contains ~64% of the WT choline levels, shows temperature-sensitive male sterility and salt hypersensitivity (Mou et al., 2002). Another *peamt* mutant called *xipotl* develops unusual roots with disturbed epidermal integrity (Cruz-Ramírez et al., 2004).

Major unanswered questions:

1. How are the genes and enzymes involved in phospholipid biosynthesis regulated during membrane biogenesis of plants?
2. What are the roles of phospholipid biosynthetic genes in lipid signaling?
3. What is the mechanism of acyl editing (transacylase or lipase mediated), and which genes are responsible for acyl editing?
4. Is the same acyl editing pathway in glycerolipid biosynthesis involved in the remodeling of phospholipid acyl groups due to stress conditions (e.g., cold) or to FA damage (e.g., oxidation)?

2.4. Sphingolipid Synthesis

(Jonathan E. Markham⁷)

Until recently, the synthesis of plant sphingolipids had not been studied at the genetic level or in any appreciable detail in one plant species, with most research focusing on the structural identification of glucosylceramides (GlcCer; Imai et al., 1995, 2000; Sullards et al., 2000) or the characterization of enzyme activities (Lynch, 2000) from a wide variety of species. However, upon completion of the Arabidopsis genome, Dunn and coworkers (2004) identified many open-reading frames with homology to the known genes of sphingolipid metabolism in yeast. Since then, reverse genetics and yeast complementation have been used to characterize and identify many genes and mutants of the sphingolipid biosynthetic pathway in Arabidopsis (Chen et al., 2006, 2008; Tsegaye et al., 2007; Dietrich et al., 2008; Wang et al., 2008; Michaelson et al., 2009).

Sphingolipid biosynthesis in Arabidopsis begins in the ER with

⁷ Donald Danforth Plant Science Center, St. Louis, MO 63132. Email: jmarkham@danforthcenter.org

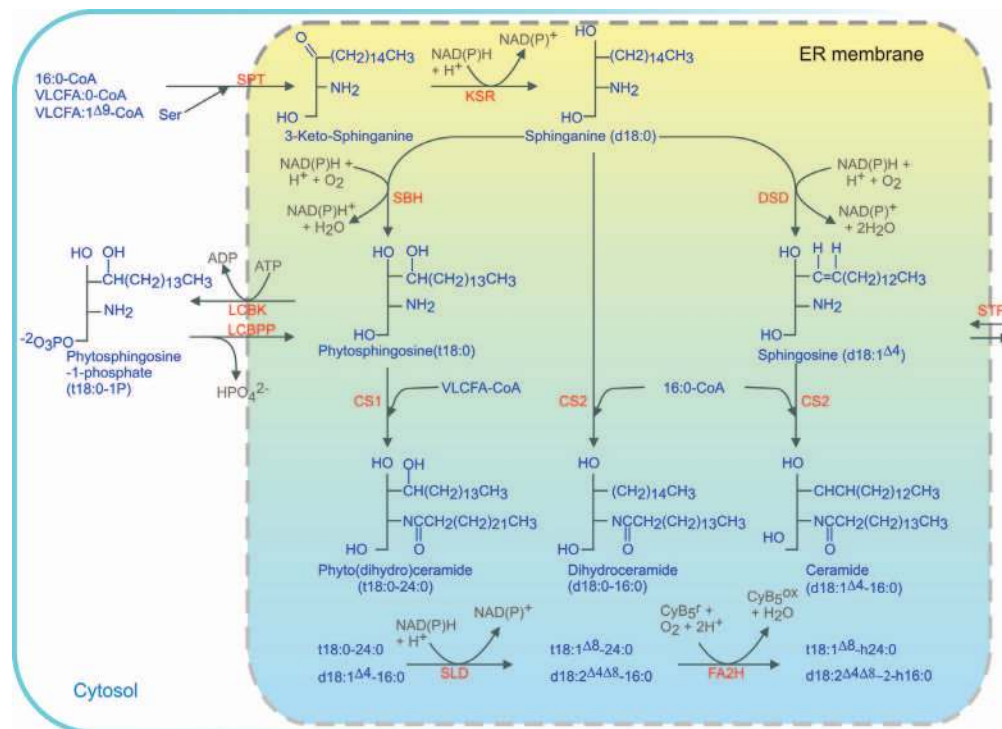

Figure 5. Sphingolipid Biosynthesis in Arabidopsis.

(A) Biosynthesis of Sphingobases and Ceramides in the ER. Palmitoyl-CoA for the serine-palmitoyl transferase (SPT) reaction and ceramide synthesis is captured by SPT at the cytosolic face of the ER membrane. Very long chain fatty acids (VLCFA) also generated by elongation at the cytosolic face of the ER are incorporated into ceramides by ceramide synthase (CS). Phosphorylation of sphingobases by long-chain base kinase (LCBK) may facilitate their increased solubilization in the cytosol.

Abbreviations: DSD, dihydrosphinganine $\Delta 4$ -desaturase; FA2H, fatty acid 2-hydroxylase; KSR, 3-ketosphinganine reductase; LCBPP, long-chain base phosphate phosphatase; SBH, sphingoid base hydroxylase; SLD, sphingolipid $\Delta 8$ -desaturase; STP, sphingosine transfer protein.

For additional details on genes involved in these reactions, please see http://aralip.plantbiology.msu.edu/pathways/sphingolipid_biosynthesis

the condensation of serine and palmitoyl-CoA to form 3-keto-sphinganine, which is then reduced to form the long-chain base sphinganine (d18:0). This is a committed step in sphingolipid biosynthesis, yet little is known about its regulation. A small, activating subunit, TSC3p, is known in yeast (Gable et al., 2000), and a similar small subunit has recently been identified in mammals (Han et al., 2009), but characterization of a similar subunit from plants awaits more research.

Long-chain bases (LCBs) can undergo several modifications in plants, such as 4-hydroxylation, 4-desaturation, and 8-desaturation, but it is not always clear what the substrates are for the enzymes performing these modifications, and hence the stage at which they occur in the pathway is not obvious. In Arabidopsis, at least 4-hydroxylation appears to precede the synthesis of ceramide as knockout of the two enzymes responsible for 4-hydroxylation, *SBH1* and 2, causes a drastic increase in the synthesis of sphingolipids containing palmitic acid (M. Chen et al., 2008). A competing reaction, 4-desaturation, introduces *trans* double bonds but is largely absent from Arabidopsis (Michaelson et al., 2009), but in tomato the $\Delta 4$ -unsaturated LCB is as abundant as the 4-hydroxy LCB (Markham et al., 2006). Interestingly, both

in tomato and Arabidopsis, almost all non-4-hydroxy LCB ends up in GlcCer, suggesting that 4-hydroxylation or desaturation is a branch point in the sphingolipid biosynthetic pathway. The $\Delta 8$ desaturation in plants typically occurs in either *cis* or *trans* configuration.

Further evidence for the branching of sphingolipid biosynthesis comes from the distribution of fatty acids in sphingolipids. Sphingolipids may contain either very long chain fatty acid (VLCFA) (mostly 24 carbons) or palmitic acid, but the fatty acid content of GlcCer and glycosylinositolphosphoryl-ceramide (GIPC) are quite different. In general, GlcCer is enriched in (2-hydroxy) palmitic acid and low in VLCFA, while GIPC is enriched in VLCFA and low in (2-hydroxy) palmitic acid (Sullards et al., 2000; Markham and Jaworski, 2007). Together, these data point to a bifurcation of sphingolipid biosynthesis, in which one ceramide synthase (CS1) combines 4-hydroxy LCBs with VLCFA to produce ceramides for GIPC biosynthesis and another, CS2, combines non-4-hydroxy LCBs with palmitic acid to produce ceramides for GlcCer biosynthesis. The functional significance of this bifurcation has still not been deciphered.

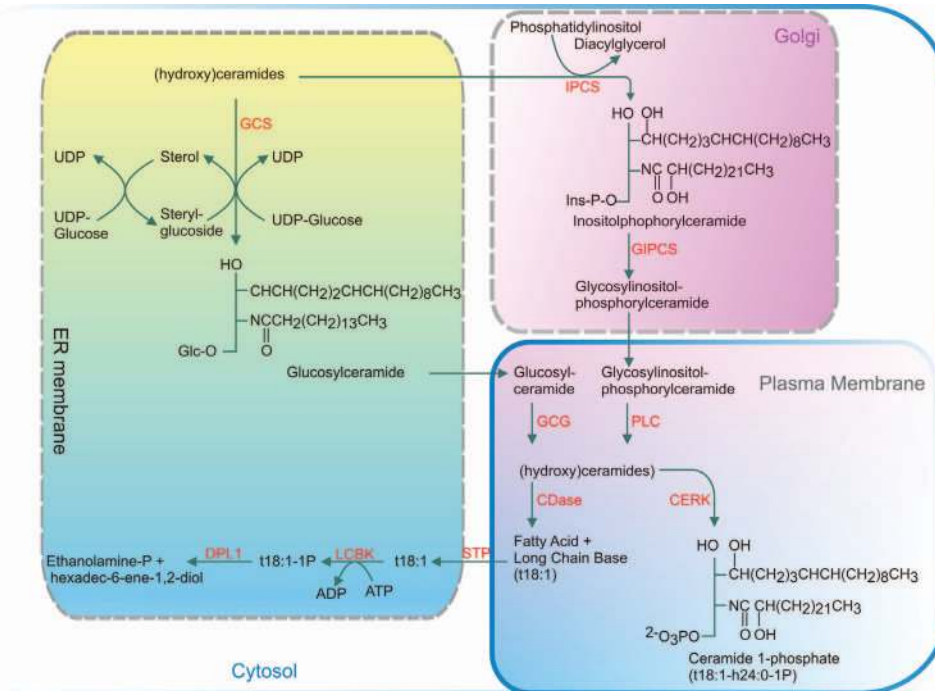

Figure 5. (continued)

(B) Fate of Ceramide Within the Cell.

Synthesis of ceramide in the ER results in two distinct pools of ceramide. One pool is glycosylated by glucosylceramide synthase (GCS). The other pool is transported to the Golgi apparatus, where it received a phosphorylinositol headgroup from phosphatidylinositol through the action of inositolphosphorylceramide synthase (IPCS). Both complex sphingolipids end up in the plasma membrane where they are eventually turned over by hydrolysis.

Abbreviations: CERK, ceramide kinase; CES, ceramidase; DPL1, dihydroshingosine phosphate lyase; GCG, glucosylceramide glucosidase; GIPCS, glycosylinositolphosphorylceramide synthase; LCBK, long-chain base kinase; PLC, phospholipase C; STP, sphingosine transfer protein.

For additional details on genes involved in these reactions, please see http://aralip.plantbiology.msu.edu/pathways/sphingolipid_biosynthesis_2

Although all plants contain monohexosylceramides, there is some diversity with respect to the structure of the GIPC headgroup. Certain species, such as tobacco and soybean, make very complex headgroup structures with up to six glycosyl groups (Hsieh et al., 1978; Kaul and Lester, 1978), whereas Arabidopsis synthesizes a single GIPC structure consisting of three glycosyl groups (Markham et al., 2006). The enzymes responsible for the synthesis of the complex GIPC structures have yet to be identified, as has the functional significance of such complex headgroup structures.

Turnover and breakdown of sphingolipids is also a poorly understood area, and neither the GlcCer glucosidase (GCG) nor the GIPC phospholipase C have been identified. Assuming that these enzymes work in a manner analogous to sphingomyelinase in animals, they may generate free ceramide in the plasma membrane where a recently identified ceramide kinase may generate ceramide-1-phosphate that is somehow involved in regulating the intercellular level of free ceramide and programmed cell death (PCD; Liang et al., 2003). Ceramide generated by the turnover of complex SL is presumably then hydrolyzed to free fatty acid and LCB. Free LCB is broken down at the ER by phosphorylation and hydrolysis to ethanolamine

and hexadecenal (Tsegaye et al., 2007). Interestingly, disruption of the enzyme responsible for this reaction in Arabidopsis, long-chain base phosphate (LCBP) lyase, led only to the accumulation of t18:1-P, suggesting that other LCBPs are processed by the LCBP phosphatase even though the LCBP lyase is capable of hydrolyzing all LCP phosphates.

Overall, this suggests a complex picture of sphingolipid metabolism that we have only just begun to decipher. Given the link between sphingolipids and induction of PCD (Brodersen et al., 2002; Liang et al., 2003; Townley et al., 2005), a complex organization might be predicted. Due to the immature nature of research into plant sphingolipids, many problems remain unresolved, including the identification of several enzymes of sphingolipid biosynthesis, the absolute structures of many plant sphingolipids, and the mechanism of transport of sphingolipid metabolites within the cell.

Major unanswered questions:

1. What functions of cell biology are facilitated by sphingolipids? How do the different structures of sphingolipids contribute to these functions?

- How are sphingolipid synthesis and metabolism regulated and coordinated with other cellular processes and metabolic pathways (e.g., sterol biosynthesis)?
- How is sphingolipid metabolism organized within the cell to allow for the generation of distinct ceramide and LCB(P) pools?
- How do sphingolipid metabolites regulate programmed cell death?

2.5. Mitochondrial Lipid Synthesis

(Hajime Wada^{*} and Kenta Katayama⁸)

Mitochondria consist of an outer membrane and an inner membrane that surrounds the matrix and forms the cristae (Logan, 2006). The major components of the mitochondrial membranes are glycerolipids and proteins. The acyl groups in the glycerolipids originate mainly from fatty acids synthesized in plastids. However, mitochondria possess their own FAS, which differs from that of plastids (Wada et al., 1997; Gueguen et al., 2000). Plant mitochondria, except those from the Poaceae (Focke et al., 2003; Heazlewood et al., 2003), lack acetyl-CoA carboxylase and require malonate for fatty acid synthesis (Wada et al., 1997; Gueguen et al., 2000). Malonate transported from the cytosol to mitochondria can be converted into malonyl-CoA by malonyl-CoA synthetase and then into malonyl acyl carrier protein (malonyl-ACP) by malonyl-CoA:ACP malonyltransferase or malonyl-ACP synthase (Gueguen et al., 2000). The synthesized malonyl-ACP is used as the primer and the acyl donor. The initial condensation of malonyl-ACP with acetyl-ACP, which is synthesized by the decarboxylation of malonyl-ACP, is catalyzed by 3-ketoacyl-ACP synthase (KAS, Yasuno et al., 2004). The subsequent steps in fatty acid synthesis are catalyzed by 3-ketoacyl-ACP reductase, 3-hydroxyacyl-ACP dehydrase, and enoyl-ACP reductase. The mitochondrial KAS catalyzes not only the initial condensation but also subsequent condensation steps. The genes for mitochondrial ACP (At2g44620 and At1g65290) and KAS (At2g04540) have been identified in Arabidopsis (Shintani and Ohlrogge, 1994; Yasuno et al., 2004; Meyer et al., 2007), while those of the other components of mitochondrial FAS have not been identified. Experiments with isolated mitochondria showed that mitochondria effectively synthesize octanoyl-ACP from exogenously supplied malonate (Wada et al., 1997; Gueguen et al., 2000). Octanoyl-ACP synthesized in mitochondria is used for the biosynthesis of lipoic acid (Wada et al., 1997; Gueguen et al., 2000). Lipoic acid is an essential sulfur-containing cofactor that is covalently bound via an amide bond to the ϵ -amino group of a specific lysine residue of the H protein of the glycine decarboxylase complex and the E₂ subunits of pyruvate dehydrogenase, α -ketoglutarate dehydrogenase, and branched chain α -ketoacid dehydrogenase complexes (Kim and Oliver, 1990; Macherel et al., 1990; Perham, 1991). The octanoyl group in octanoyl-ACP synthesized by mitochondrial FAS is transferred to the lysine residue of H protein and the E₂ subunits by lipoyl (octanoyl) transferase (Wada et al., 2001a, b). Then the transferred octanoyl group is

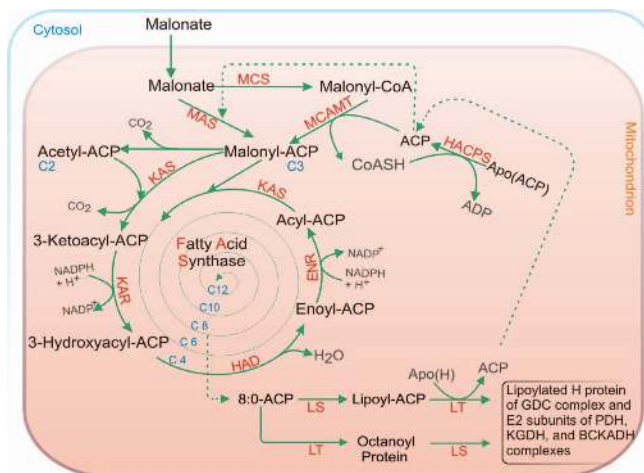

Figure 6. Mitochondria Fatty Acid Synthesis.

(A) Mitochondrial Fatty Acid and Lipoic Acid Synthesis.

In mitochondria, fatty acids are synthesized by type II fatty acid synthase located in the matrix using malonate as a precursor. Octanoic acid, which is a major fatty acid synthesized in mitochondria, is used for biosynthesis of lipoic acid that is bound to the H protein of the GDC complex and the E₂ subunits of PDH, KGDH, and BCKADH complexes as a cofactor.

Abbreviations: BCKADH, branched chain α -keto acid dehydrogenase; ENR, enoyl-ACP reductase; GDC, glycine decarboxylase; HAD, 3-hydroxyacyl-ACP dehydrase; HACPS, holo-ACP synthase; KAR, 3-ketoacyl-ACP reductase; KAS, 3-ketoacyl-ACP synthase; KGDH, α -ketoglutarate dehydrogenase; LS, lipoic acid synthase; LT, lipoyltransferase; MAS, Malonyl-ACP synthetase; MCAMT, malonyl-CoA: ACP malonyltransferase; MCS, malonyl-CoA synthetase; PDH, pyruvate dehydrogenase.

For additional details on genes involved in these reactions, please see http://aralip.plantbiology.msu.edu/pathways/mitochondrial_fatty_acid_lipoic_acid_synthesis

converted into a lipoyl group by lipoic acid synthase (Yasuno and Wada, 1998).

Mitochondrial membranes contain phosphatidylcholine, phosphatidylethanolamine, phosphatidylinositol, phosphatidylglycerol, and cardiolipin (CL) as the major glycerolipids (Caiveau et al., 2001; Jouhet et al., 2004). CL is a unique glycerolipid with a tetraacyl structure that, in eukaryotes, is found only in mitochondrial membranes. Under phosphate-limited conditions, the degradation of PC and PE is induced, and they are replaced by digalactoyldiacylglycerol, which is transported from plastids (Jouhet et al., 2004). Although mitochondrial membranes contain PC, PE, and PI, these are synthesized mainly in the ER and transported to the mitochondria, presumably via the mitochondria-associated membrane (MAM) domains of the ER (Kornmann et al., 2009). Phosphatidylserine synthesized in the ER is also transported to mitochondria and is used for the biosynthesis of PE by PS decarboxylase (Rontein et al., 2003; Nerlich et al., 2007).

The de novo biosynthesis of CL in mitochondria was investigated using isolated mitochondria, and the authors suggested that mitochondria are capable of synthesizing CL (Frentzen and Griebau, 1994; Griebau and Frentzen, 1994). In the first reaction in the biosynthesis of CL, glycerol-3-phosphate acyltransferase transfers an acyl group from acyl-ACP to the *sn*-1 position of glycerol

⁸ Department of Life Sciences, Graduate School of Arts and Sciences, University of Tokyo, Komaba 3-8-1, Meguro-ku, Tokyo 153-8902, Japan. *Email: hwada@bio.c.u-tokyo.ac.jp

tissues. Molecular species of CL differ appreciably from those of PG, although CL is synthesized from PG and CDP-DAG. The substrate specificities of CL synthase cannot explain the typical molecular species of CL (Frentzen and Griebau, 1994; Nowicki et al., 2005). Therefore, it is likely that systems for remodeling CL exist in plant mitochondria, as in those of other eukaryotes (Schlame, 2008).

Major unanswered questions:

1. Are mitochondria really able to synthesize CL from G3P?
2. How are glycerolipids transported from the ER to mitochondria? Are they transported through the MAM domains of the ER?

2.6. Triacylglycerol Synthesis

(Timothy P. Durrett⁹)

Because of their highly reduced state, triacylglycerols (TAG) represent a compact molecule for energy and carbon storage in organisms. Thus, these neutral lipids represent a major component of seed oil in Arabidopsis. In addition to seeds, other tissues such as senescing leaves, floret tapetosomes, and pollen grains also accumulate TAGs (Kaup et al., 2002; Kim et al., 2002).

TAG biosynthesis occurs at the ER and probably also involves reactions at the oil body (Huang, 1992). In its simplest form, the pathway consists of the sequential acylation and subsequent dephosphorylation of glycerol-3-phosphate (G3P), which is formed by the reduction of dihydroxyacetonephosphate. This pathway is often referred to as the *Kennedy pathway* or the *glycerol phosphate pathway*; most of its early steps are common to the synthesis of membrane lipids.

The first acylation of G3P at the *sn*-1 position is catalyzed by glycerol-3-phosphate acyltransferase (GPAT; EC 2.3.1.15). Initial attempts to isolate the genes encoding this enzymatic activity based on similarity to yeast GPAT and other acyltransferases led to the discovery of an eight-member gene family in Arabidopsis (Zheng et al., 2003; Beisson et al., 2007). However, further characterization of this family suggested that at least several of these GPATs play a role in the production of cutin and suberin instead of in seed oil synthesis in Arabidopsis (Beisson et al., 2007; Y.H. Li et al., 2007a, 2007b; Li-Beisson et al., 2009). Therefore, the GPAT important for TAG and membrane glycerolipid synthesis remains to be identified. However, the closest Arabidopsis homolog (At5g60620) of the recently discovered microsomal GPAT important for TAG production in mice and humans (Cao et al., 2006) provides an obvious candidate for further study.

Similar to the situation with Arabidopsis GPAT activity, the Arabidopsis 2-lysophosphatidic acid acyltransferase (LPAAT; EC 2.3.1.51) responsible for the second acylation during TAG synthesis remains to be definitely identified. Five Arabidopsis LPAAT genes have been identified based on sequence similarity to characterized LPAATs from other organisms (Kim and Huang, 2004); the LPAAT activity of the enzymes encoded by two of these genes,

AtLPAAT2 and *AtLPAAT3*, has been confirmed (Kim et al., 2005). The most highly expressed member of the family, *LPAAT2*, is necessary for female gametophyte development; thus, homozygous mutants abort during seed development. In this case the haploid dies and the homozygous mutant is never created. This lethality of the *lpat2* mutation has prevented the confirmation of the role of this enzyme in TAG synthesis and illustrates one of the difficulties in studying a pathway shared with the synthesis of membrane lipids.

After the second acylation, the dephosphorylation of the resultant PA is catalyzed by phosphatidate phosphatase (PP; EC 3.1.3.4) to form DAG. In other eukaryotic systems, two classes of PP enzymes have been identified as Mg²⁺ dependent and Mg²⁺ independent (reviewed in Carman and Han, 2006). The latter class, also referred to as *PP2 enzymes*, is involved in lipid signaling. In contrast, the former class (referred to as *PP1 enzymes*) appear to play a role in the synthesis of lipids. Yeast *pah1Δ* mutants with reduced PP1 activity accumulate PA and contain reduced amounts of DAG and TAG (Han et al., 2006). The two close Arabidopsis homologues of PAH1 (*AtPAH1*, At3g09560; *AtPAH2*, At5g42870) possess Mg²⁺-dependent PP activity when expressed in yeast (Nakamura et al., 2009) and therefore are the obvious candidates for further study.

DAG represents an important branch point between storage and membrane lipid synthesis. The final acylation reaction, converting DAG to TAG, is therefore unique to the TAG biosynthetic pathway. At least three mechanisms differing in their acyl donor sources have been identified as contributing to this step.

In the first of these reactions, catalyzed by diacylglycerol acyltransferase (DGAT; EC 2.3.1.20) enzymes, DAG is acylated on the *sn*-3 position using a fatty acyl-CoA molecule. Pioneering work has identified two different classes of DGAT enzymes (Cases et al., 1998, 2001; Lardizabal et al., 2001), orthologs of which have been isolated in various plants. DGAT1 and DGAT2 enzymes are unrelated, differing not only in their sequence and membrane topology, but also in terms of their substrate discrimination. Additionally, DGAT1 and DGAT2 from tung tree (*Vernicia fordii*) appear to localize to different subdomains of the ER (Shockey et al., 2006). While Arabidopsis possesses both DGAT1 and DGAT2 orthologs, so far only DGAT1 has been shown to play a role in seed oil accumulation in Arabidopsis. For example, mutations in the *DGAT1* gene led to reduced TAG content (Katavic et al., 1995; Routaboul et al., 1999; Zou et al., 1999). In contrast, the role of DGAT2, if any, in Arabidopsis TAG synthesis remains to be confirmed. While DGAT2 possesses very weak activity in vitro (Lardizabal et al., 2001), unlike DGAT1, expression in yeast fails to complement a mutant defective in its ability to synthesize TAG, and T-DNA insertions in the gene locus have no apparent phenotype (Zhang et al., 2009). This apparent lack of involvement of AtDGAT2 in TAG production is surprising given the importance of DGAT2 orthologs in other organisms (reviewed in Yen et al., 2008). A third, soluble class of DGAT enzyme has been reported in peanut (Saha et al., 2006), but similar activity has yet to be identified in other systems.

DAG can also be acylated using PC as the acyl donor. This reaction is catalyzed by a phospholipid:diacylglycerol acyltransferase (PDAT; EC 2.3.1.43). PDAT activity has been detected in yeast and developing oil seeds (Dahlqvist et al., 2000) and the gene encoding such activity identified in Arabidopsis (Stahl et al., 2004). T-DNA insertion mutants of PDAT1 lacked a distinct

⁹ Department of Plant Biology, Michigan State University, East Lansing, MI 48824. Email: tdurrett@msu.edu

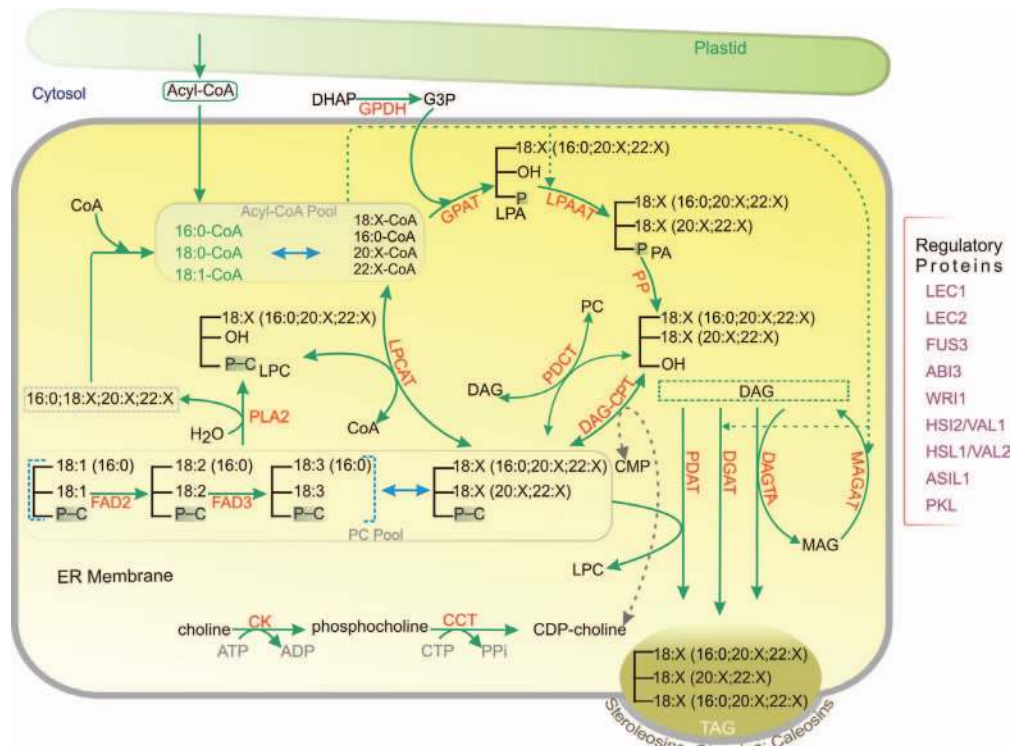

Figure 7. Triacylglycerol Synthesis in Arabidopsis.

Newly synthesized acyl-CoAs (shown in green) are exported from the plastid to the endoplasmic reticulum (ER) membrane, where they join a larger acyl-CoA pool. A series of reactions adds the fatty acids to a glycerol backbone to form triacylglycerol (TAG). TAG molecules coalesce to form oil droplets that bud out of the ER membrane. Additional reactions integrate the synthesis of TAG with that of phosphatidylcholine (PC), an important membrane lipid. Fatty acids can be further desaturated when they are part of the PC pool.

Abbreviations: CCT, choline-phosphate cytidyltransferase; CK, choline kinase; DAG, diacylglycerol; DAG-CPT, diacylglycerol cholinephosphotransferase; DAGTA, diacylglycerol transacylase; DGAT, acyl-CoA: diacylglycerol acyltransferase; DHAP, dihydroxyacetone phosphate; FAD2, oleate desaturase; FAD3, linoleate desaturase; G3P, glycerol-3-phosphate; GPAT, glycerol-3-phosphate acyltransferase; GPDH, glycerol-3-phosphate dehydrogenase; LPA, 2-lysophosphatidic acid; LPAAT, 2-lysophosphatidic acid acyltransferase; LPC, 2-lysophosphatidylcholine; LPCAT, 2-lysophosphatidylcholine acyltransferase; MAG, monoacylglycerol; MAGAT, monoacylglycerol acyltransferase; PA, phosphatidic acid; PDAT, phospholipid:diacylglycerol acyltransferase; PDCT, phosphatidylcholine:diacylglycerol cholinephosphotransferase; PLA2, phospholipase A2; PP, phosphatidate phosphatase.

For additional details on genes involved in these reactions, please see http://aralip.plantbiology.msu.edu/pathways/triacylglycerol_biosynthesis

phenotype (Mhaske et al., 2005). However, double mutants of *PDAT1* and *DGAT1* are lethal, and RNAi suppression of either gene in a mutant background lacking the other gene results in severe defects in pollen and seed development, including greatly reduced oil bodies and oil content (Zhang et al., 2009). Thus, the absence of *PDAT1* is evidently compensated by *DGAT1*, explaining the relatively minor reduction in oil content in *dgat1* mutants.

Work with developing safflower seeds has suggested the existence of diacylglycerol:diacylglycerol transacylase activity, providing a third possible reaction mechanism to acylate DAG to form TAG (Stobart et al., 1997). However, the identity of enzymes catalyzing such activity in Arabidopsis has yet to be identified.

In addition to the Kennedy pathway, other reactions are important for TAG synthesis in plants. In this regard, PC clearly functions as a key intermediate. It has long been known that additional desaturation of fatty acids occurs when they are esterified to TAG

(reviewed in Ohlrogge and Jaworski, 1997). A phosphatidylcholine:diacylglycerol cholinephosphotransferase (*PDCT*), encoded by the *ROD1* gene, catalyzes the transfer of the phosphocholine headgroup from PC to DAG and is thus important for the flux of more desaturated fatty acids into DAG and subsequently into TAG (C. Lu et al., 2009). Additionally, work with developing soybean embryos has demonstrated that about 60% of newly synthesized acyl chains are incorporated directly into the *sn*-2 position of PC through an acyl-editing mechanism rather than through the sequential acylation of G3P (Bates et al., 2009). Such a flux pattern still has yet to be demonstrated in Arabidopsis, but the identification of the presumptive lysophosphatidylcholine acyltransferases (LPCATs) and lipases required for such an acyl editing mechanism will represent an important step forward in our understanding of TAG production in Arabidopsis.

Once synthesized, TAG molecules coalesce to form structures referred to as *oil bodies* or *lipid droplets*. These organelles

consist of a TAG core surrounded by a phospholipid monolayer decorated with a number of different proteins. The most abundant of these are the oleosins, but others such as caleosins and steroleosins are also present (Jolivet et al., 2004). Oleosins contain a hydrophobic oil body-binding domain flanked by two amphipathic domains. Mutant analysis has confirmed that oleosins determine the size of oil bodies and thus facilitate mobilization of the TAG storage reserves during seed germination by maximizing the surface-to-volume ratio of the oil bodies (Siloto et al., 2006; Shimada et al., 2008). Caleosins also appear to play a role in TAG mobilization during germination, possibly by facilitating interactions with vacuoles (Poxleitner et al., 2006). Steroleosins, in addition to an oil body-anchoring domain, possess a sterol-binding dehydrogenase that might play a role in signal transduction (L.J. Lin et al., 2002).

Numerous transcription factors are involved in a complex and hierarchical system integrating TAG production with other aspects of seed and embryo development (Santos-Mendoza et al., 2008; Suzuki and McCarty, 2008). The transcription factor WRINKLED1 functions downstream in this regulatory cascade (Cernac and Benning, 2004; Baud et al., 2007; Mu et al., 2008). However, putative targets of WRI1 include genes important for glycolysis, fatty acid synthesis, and the biosynthesis of biotin and lipoic acid, but not those required for TAG assembly (Ruuska et al., 2002; Baud et al., 2007). Presumably, therefore, additional factors that regulate the transcription of the genes necessary for TAG synthesis in Arabidopsis remain to be discovered.

As mentioned previously, TAGs also accumulate in plant tissues outside of seeds. A role for these TAGs remains to be elucidated, but involvement in membrane lipid remodeling has been proposed. For example, senescing Arabidopsis leaves synthesize TAGs enriched in the fatty acids hexadecatrienoate (16:3) and linolenate (18:3) usually abundant in thylakoid galactolipids (Kaup et al., 2002). It is thought that this accumulation of TAG might serve to temporarily sequester the fatty acids derived from the breakdown of senescing thylakoid membranes. DGAT1 appears to play an important role in this process: Increased DGAT1 transcript and protein levels have been detected in senescing Arabidopsis leaves (Kaup et al., 2002), and mutations in *DGAT1* reduce the accumulation of TAGs in senescing leaves (Slocombe et al., 2009).

Major unanswered questions:

1. What are the specific identities of remaining enzymes involved? Only *DGAT1*, *PDAT1*, and *ROD1* (PDCT) have been confirmed by mutant analysis to be involved in vivo in TAG biosynthesis.
2. How is TAG synthesis regulated? While a picture of the regulatory network controlling TAG synthesis is starting to emerge, much remains unknown. For example, little is known about posttranslational control. In this regard, recent work has suggested that the activity of DGAT1 from nasturtium (*Tropaeolum majus*) might be regulated by the phosphorylation state of the protein (J. Xu et al., 2008).
3. How important is the acyl editing pathway for acyl flux into TAGs in Arabidopsis? What enzymes catalyze the reactions of this pathway?

2.7. Lipid Trafficking (Changcheng Xu¹⁰)

The biosynthesis of lipids occurs in discrete subcellular compartments and often involves spatially separated enzymatic reactions. Therefore, the intracellular trafficking of lipids is essential for the biogenesis of membrane systems.

In higher plants, the quantitatively largest flux of lipids is between the two major sites of glycerolipid assembly, namely the ER and the plastid (Somerville and Browse, 1996; Benning et al., 2006). Almost all the acyl chains that form the core of the plant membranes are first produced by fatty acid synthase in the plastid. In most plants these acyl chains are then exported to the ER, where they become esterified to glycerol, are desaturated while they are part of phosphatidylcholine, and then are returned to the plastid. The exact mechanisms for the export and return of acyl chains are still uncertain, although much has been learned. The export of newly synthesized fatty acids from plastids across the chloroplast envelope membranes is known to involve a free fatty acid intermediate and probably is a channeled or facilitated process rather than free diffusion because only a tiny pool of free fatty acid is ever detected (Koo et al., 2004). An acyl-CoA synthetase on the envelope membrane is believed to quickly convert the exported fatty acid to a thioester form that is then a substrate for acyltransferases. Transfer of acyl groups to the ER may occur via diffusion of the acyl-CoAs; however, recent evidence suggests this initial acyl transfer reaction involves acylation of lysophosphatidylcholine, and it might occur at the chloroplast envelope (Bates et al., 2007).

The plastid and ER compartments cooperate in the synthesis of thylakoid lipids in the plastid and the majority of extraplastidic phospholipids in the ER and other extracellular membranes. Although mitochondria also harbor enzymes for phospholipid biosynthesis, recent genetic and biochemical evidence suggests that the biogenesis of mitochondrial membranes depends to a large extent on the import of various phospholipids from the ER (Babychuk et al., 2003; Nerlich et al., 2007). Other intracellular membranes have a limited or no capacity to synthesize their own membrane lipids (Bishop and Bell, 1988) and therefore rely primarily on import from the ER to generate their own full complement of lipids.

Although most phospholipids are synthesized in the ER, the membranes of intracellular organelles differ in their lipid compositions. Furthermore, for some membranes, different lipid species are distributed asymmetrically between the two leaflets of the lipid bilayer. A notable example is PC, which is restricted to the cytosolic leaflet of the outer envelope bilayer of chloroplasts (Dorne et al., 1985). In addition, the asymmetric syntheses of phospholipids in the ER (Bell et al., 1981) and galactolipids in the envelope membranes of plastids (Benning, 2008), with the active sites of enzymes restricted to one leaflet, necessitate the existence of efficient transport mechanisms to maintain the bilayer structure of the membrane. Thus, a key challenge in the cell biology of lipids is understanding how newly synthesized lipids are transported and sorted into various intracellular membrane systems and how these processes are regulated to ensure correct assembly for normal cellular function.

¹⁰ Biology Department, Brookhaven National Laboratory, Upton, NY 11973-5000. Email: cxu@bnl.gov

Most of our knowledge about biochemical processes and molecular mechanisms underlying intracellular lipid transport comes from studies in yeast and mammalian cells, and our understanding of how lipids are moved and sorted in plant model systems is rather limited. Conceptually, the mechanisms of lipid transport can be broadly classified as vesicular and nonvesicular. The latter encompasses intermembrane lipid movement and intracellular lipid transport.

Vesicular transport plays a central role in the trafficking of membrane proteins and certain lipids between organelles of the secretory pathways via the budding and fusion of membrane vesicles (van Meer et al., 2008; Figure 8, Process 1a). This mechanism was long thought to mediate the trafficking of lipids from the inner plastid envelope to thylakoid membranes (Figure 8, Process 1b) based on ultrastructural studies (Carde et al., 1982) and experiments using classical inhibitors of vesicular transport (Westphal et al., 2001b). A protein component involved in this trafficking mechanism, vesicle-inducing protein in plastids, was identified in both cyanobacteria and Arabidopsis (Westphal et al., 2001a; Kroll et al., 2001). Disruption of the *VIPP1* locus in Arabidopsis abolished thylakoid biogenesis and the ability to generate vesicles in chloroplasts incubated at low temperature. In contrast to the situation inside the plastid, much of the available data suggest that the transport of phospholipids between organelles follows some specialized and poorly defined routes independent of vesicular trafficking.

The movement of polar lipids between the two membrane leaflets does not happen spontaneously but requires catalysis by lipid transporter or flippase proteins (Figure 8, Process 2). Compelling evidence exists for the involvement of ATP-dependent flippases in asymmetric distribution of lipids across the bilayer in yeast and mammalian cells. These types of flippases include ATP binding cassette transporter (ABC) transporters and P-type ATPases that use ATP hydrolysis to move specific lipids against a concentration gradient. One member of a gene family of P-type ATPases in Arabidopsis has been implicated in generating membrane lipid asymmetry and contributing to cold tolerance (Gomes et al., 2000). Plant ABC lipid transporters involved in cutin and wax secretion in the plant epidermis have been described (see Samuels et al., 2008). A putative Arabidopsis ABC lipid transporter consisting of the TGD1, 2, and 3 proteins was identified recently (Benning, 2008, 2009). This protein complex is localized in the inner chloroplast envelope membrane and is proposed to mediate the transfer of phosphatidate across this membrane. Inactivation of this transporter blocks the lipid trafficking between the ER and the plastids. In contrast to these energy-dependent flippases, biogenic membranes are equipped with ATP-independent flippases that facilitate a passive equilibration of lipids between the two membrane halves, but the molecular identity of such flippases remains largely unclear.

Another mechanism proposed to be involved in intracellular lipid transport is lipid transfer through membrane contact sites (Levine and Loewen, 2006; Jouhet et al., 2007; Benning, 2008; Figure 8, Process 3). In plants, close interactions by membrane contacts or a continuum between ER and other subcellular compartments including plastids, mitochondria, plasma membrane, nuclear envelope, and vacuoles were observed in many early studies (see Staehelin et al., 1997). The presence

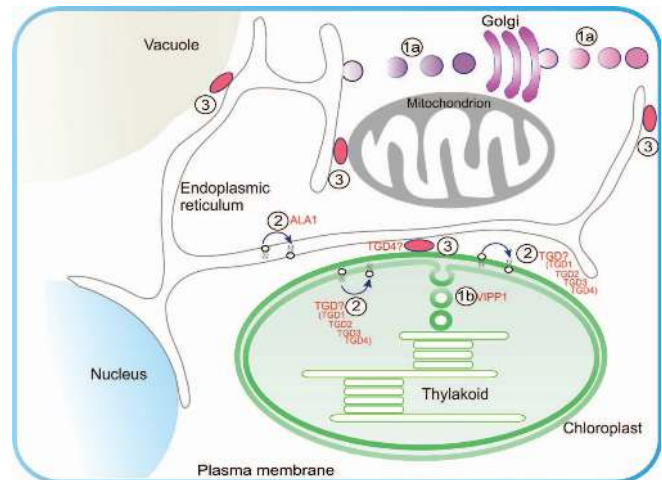

Figure 8. Summary of Intracellular Lipid Transport Processes in Arabidopsis.

Process 1a. A vesicular mechanism is proposed for trafficking of membrane proteins and certain lipids between cellular organelles in the secretory pathways.

Process 1b. The vesicular transfer of lipids from the inner chloroplast envelope to the thylakoids.

Process 2. Polar lipid flipping across the ER and outer and inner chloroplast envelope membranes.

Process 3. Lipid transfer through membrane contact sites between ER and plastids, mitochondria, plasma membrane, or vacuoles.

Abbreviations: ALA1, aminophospholipid ATPase; TGD1, permease-like protein of inner chloroplast envelope; TGD2, phosphatidic acid-binding protein; TGD3, ATPase; TGD4, protein involved in lipid transport; VIPP1, vesicle-inducing protein in plastids.

For additional details on genes involved in these reactions, please see http://aralip.plantbiology.msu.edu/pathways/lipid_trafficking

of strong physical interactions between the ER and the plastid were demonstrated in vivo (Andersson et al., 2007). However, the exact roles of membrane contact sites in lipid transport still need to be demonstrated in plants, and the structural components of such a transport system are not clear. Recently, a novel Arabidopsis protein, TGD4, was identified by a genetic approach (C.C. Xu et al., 2008). Inactivation of TGD4 locus blocks lipid transfer from the ER to plastids. It remains to be seen, however, whether TGD4 is functionally associated with membrane contact sites in lipid trafficking. Interestingly, Arabidopsis lipins have recently been implicated in the eukaryotic pathway of thylakoid lipid biosynthesis and lipid remodeling (Nakamura et al., 2009).

Lipid transfer proteins (LTPs) are small abundant proteins that were originally assumed to be involved in intracellular lipid transport based on their ability to transfer lipids in vitro between membranes. However, these proteins have secretory peptides and are known to be extracellular. There is now almost no reason to believe they are involved in intracellular lipid trafficking, but they may be involved in movement of surface lipids such as waxes or cutin precursors through the cell wall.

Major unanswered questions:

1. What genes and proteins are involved in the export of fatty acids from plastids?
2. To what extent are vesicular trafficking versus membrane contact sites responsible for movement of lipids to various organelles and plasma membrane?

2.8. Cuticular Waxes(Owen Rowland¹¹ and David Bird¹²)

The aerial surfaces of plants are coated with a protective cuticle that comprises primarily cutin and waxes. Cutin forms a polyester matrix overlaying the cell wall and serves as the main structural component of the cuticle (see Section 2.9). Intracuticular waxes are embedded in the cutin matrix, and epicuticular waxes, often in the form of crystals, cover the outer surface.

Molecular genetic studies in *Arabidopsis* have identified many genes involved in cuticular wax synthesis and deposition (Samuels et al., 2008). Forward genetic studies identified wax-deficient mutant loci, often termed *eceriferum* mutants, by their glossy stems. Additional candidate genes for wax biosynthesis were revealed in a DNA microarray study that identified *Arabidopsis* genes upregulated in the epidermis (Suh et al., 2005). This facilitated the identification of loci that affect wax load and/or composition but that, when mutated, do not have a visible phenotype (Greer et al., 2007; F. Li et al., 2008; DeBono et al., 2009; Lee et al., 2009).

The first step in wax biosynthesis is an elongation cycle converting C16:0 and C18:0 fatty acyl-CoAs, produced in the plastid (see Section 2.1), to generate VLCFA wax precursors between 20 and 34 carbons in length. Malonyl-CoA is the carbon donor in this cycle and is produced by cytosolic ACC1, which adds carbon dioxide to acetyl-CoA (Baud et al., 2003).

Fatty acid elongation is catalyzed by an ER-associated, multi-enzyme complex known as fatty acid elongase (Joubes et al., 2008). Each elongation cycle involves four successive reactions. The first step involves condensation of malonyl-CoA with an acyl-CoA catalyzed by a β -ketoacyl-CoA synthase (KCS). The β -ketoacyl-CoA is then reduced by a β -ketoacyl-CoA reductase (KCR). The resulting β -hydroxyacyl-CoA then undergoes dehydration by a β -hydroxyacyl-CoA dehydratase (HCD). In the final step, the enoyl-CoA is reduced to an acyl-CoA by enoyl-CoA reductase (ECR). This cycle results in an acyl chain extended by two carbons, and the cycle can be repeated. The KCS enzyme determines the substrate and tissue specificity of fatty acid elongation (Millar and Kunst, 1997). Five KCSs have thus far been associated with cuticle formation: CER6(CUT1), KCS1, KCS2(DAISY), KCS20, and FDH (Millar et al., 1999; Todd et al., 1999; Yephremov et al., 1999; Fiebig et al., 2000; Pruitt et al., 2000; Lee et al., 2009; Voisin et al., 2009), although only CER6 has been shown to be specific for cuticular wax synthesis. The *Arabidopsis* genes encoding KCR, HCD, and ECR have been identified, but mutations

in these genes are pleiotropic, affecting, for example, sphingolipids and seed triacylglycerols in addition to cuticular wax (Zheng et al., 2005; Bach et al., 2008; Beaudoin et al., 2009).

Once saturated VLCFA-CoA chains are synthesized in the ER, they are converted to cuticular waxes by the coordinated activities of additional enzymes. A proportion of the VLCFA-CoAs are hydrolyzed by a putative thioesterase to release free fatty acids destined for the cuticle (Lü et al., 2009). *Arabidopsis* CER8/LACS1 is a VLCFA-CoA synthetase that reactivates VLCFAs for further modification by the wax pathway (Lü et al., 2009; Weng et al., 2010). The balance of thioesterase and synthetase activities may be an important control point in wax biosynthesis. Most of the epidermal VLCFA-CoAs enter one of two ER-localized pathways: an acyl reduction pathway that produces primary alcohols and wax esters, and an alkane-forming pathway (also known as the *decarbonylation pathway*) that produces aldehydes, alkanes, secondary alcohols, and ketones.

The enzymes of the acyl reduction pathway are relatively well characterized. *Arabidopsis* CER4 is the fatty acyl-CoA reductase that generates the vast majority of cuticular C24:0-C30:0 primary alcohols in stem and leaf cuticles (Rowland et al., 2006). In stems, a proportion of these fatty alcohols enter a condensation reaction with mainly C16:0 acyl-CoAs to form wax esters (Lai et al., 2007), which is catalyzed by a bifunctional wax synthase/acyl-CoA:diacylglycerol acyltransferase (WS/DGAT) enzyme called WSD1 (F. Li et al., 2008).

Products of the alkane-forming pathway represent the majority of stem (84%) and leaf (60%) wax loads of *Arabidopsis* plants. A midchain alkane hydroxylase 1 (MAH1) hydroxylates odd-chain alkanes to secondary alcohols and likely performs a second hydroxylation to yield ketones (Greer et al., 2007). The beginning of the pathway, however, remains unclear. Two sequential steps are proposed to form odd-chain alkanes: the production of fatty aldehydes from fatty acyl-CoA precursors by an aldehyde-forming fatty acyl-CoA reductase (Vioque and Kolattukudy 1997), followed by decarbonylation by an aldehyde decarbonylase (Cheesbrough and Kolattukudy, 1984). However, these enzymes have not been identified. *CER1* has been proposed to code for an aldehyde decarbonylase (Aarts et al., 1995), but biochemical support for this is lacking. In addition, *cer1* mutants are also deficient in primary alcohols, suggesting an upstream or more general role (Jenks et al., 1995). *Arabidopsis cer3* mutants have significantly lower stem wax levels of aldehydes, alkanes, secondary alcohols, and ketones and higher levels of C30 primary alcohols, indicating a key role in the alkane-forming pathway. The predicted CER3/WAX2/YRE/FLP1 protein is related to CER1, and both contain a di-iron-binding motif characteristic of a class of membrane desaturases (Shanklin et al., 1994), but demonstration of their biochemical activities remains elusive (Chen et al., 2003; Rowland et al., 2007).

Once synthesized, there are three possible routes for trafficking from the ER to the plasma membrane (PM): vesicular trafficking, transport by cytosolic carrier proteins, or direct transfer through membrane contact sites (ER-PM junctions). Cuticular lipids may preferentially associate with lipid rafts microdomains enriched in sphingolipids and sterols to allow for targeted secretion to the PM (Kunst and Samuels, 2003). Acyl-CoA binding proteins (ACBPs) might act as carrier proteins for cuticular lipids (Leung et al., 2006; Xiao and Chye, 2009). However, the role, if any, of ACBPs in cuticular lipid trafficking is not known. Finally,

¹¹ Department of Biology and Institute of Biochemistry, Carleton University, Ottawa, ON K1S 5B6, Canada. Email: owen_rowland@carleton.ca

¹² Department of Chemical and Biological Sciences, Mount Royal University, Calgary T3E 6K6, Canada. Email: dbird@mtroyal.ca

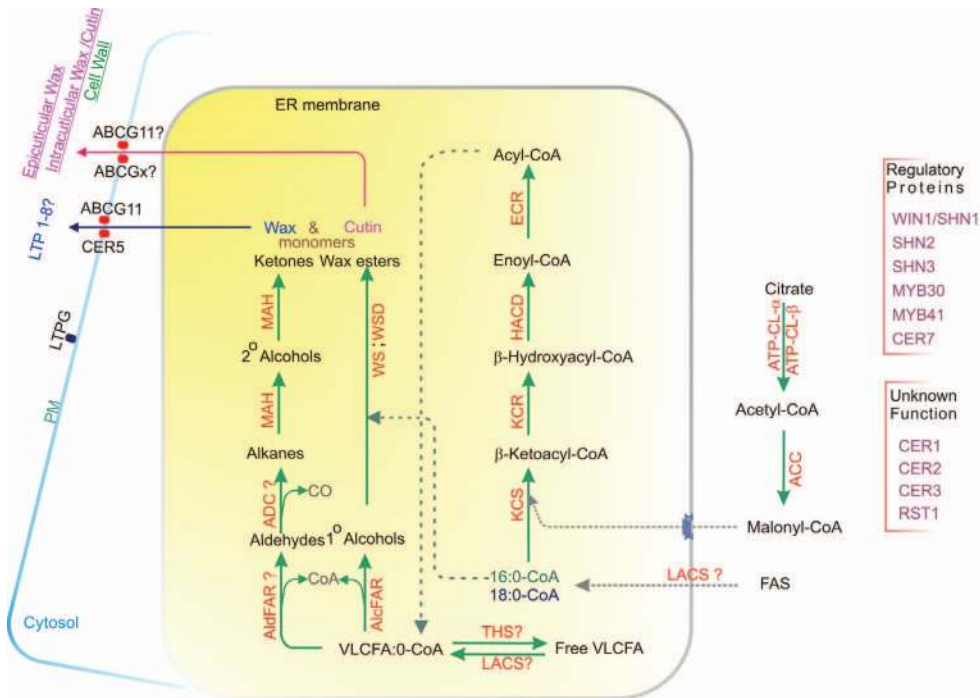

Figure 9. Fatty Acid Elongation and Cuticular Wax Biosynthesis

Pathways for the formation in epidermal cells of very long chain fatty acyl-CoAs (VLCFAs) and cuticular waxes. Analogous FA elongation pathways occur in all cells to produce VLCFA for sphingolipids, and in seeds for elongation of 18:1 to 20:1 and 22:1. Saturated C16 and C18 fatty acids, produced in the plastid (FAS), are esterified to coenzyme A (CoA) by LACS. 16:0- and 18:0-CoA esters are elongated by reiteratively adding a two-carbon unit to the carboxy terminal to generate VLCFA wax precursors between 20 and 34 carbons in length. The endoplasmic reticulum (ER)-associated fatty acid elongase consists of four enzymatic activities (KCS, KCR, HACD, and ECR) that work sequentially to elongate the fully saturated acyl-CoA chains. Once the VLCFAs are synthesized, they are converted to cuticular waxes by the coordinated activities of a number of enzymes. A proportion of the elongated acyl-CoAs are hydrolyzed by a thioesterase to release free fatty acids. Conversely, free VLCFAs can be reactivated into CoA esters by LACS1. However, most of the elongated fatty acyl-CoAs enter one of two wax biosynthetic pathways: an alkane-forming pathway (also known as the *decarbonylation pathway*) that produces aldehydes, alkanes, secondary alcohols, and ketones, and a primary alcohol forming pathway (also known as the *acyl reduction pathway*) that produces primary alcohols and wax esters. The waxes are transported to the plasma membrane (PM) by an unknown mechanism, and transport across the PM is facilitated by ABC transporters (CER5 and ABCG). Lipid transfer proteins (LTPs) may be involved in transport of waxes across the cell wall in order to reach the final destination at the cuticle.

Abbreviations: ABCG, ATP-binding cassette transporter G subfamily; ACC, acetyl-CoA carboxylase (Cytosolic; Homomeric); ADC, aldehyde decarbonylase; AlcFAR, alcohol-forming fatty acyl-CoA reductase; AldFAR, aldehyde-forming fatty acyl-CoA reductase; ATP-CL- α (β), ATP citrate lyase α (β) subunit; CER5, ECERIFERUM 5; ECR, enoyl-CoA reductase; HACD, hydroxyacyl-CoA dehydrase; KCS, ketoacyl-CoA synthase; KCR, ketoacyl-CoA reductase; LACS, long-chain acyl-CoA synthetase; LTP, lipid transfer protein; LTPG, GPI-anchored lipid transfer protein; MAH, midchain alkane hydroxylase; MAO, midchain alkanol oxidase; MCD, malonyl-CoA decarboxylase; THS, acyl-CoA thioesterase; VLCFA, very long-chain fatty acid; WS, wax synthase; WSD, bifunctional wax ester synthase/diacylglycerol acyltransferase.

For additional details on genes involved in these reactions, please see http://aralip.plantbiology.msu.edu/pathways/fatty_acid_elongation_wax_biosynthesis

contact sites between the plasma membrane and endoplasmic reticulum have been suggested to function as lipid transport sites, directly translocating the lipids between two closely associated membranes (Levine, 2004; see Section 2.7.). Movement of cuticular waxes from the PM to the apoplast involves at least two ABC transporters of the ABCG subfamily. Disruption of either or both *ABCG12/CER5* or *ABCG11/COF1/DSO* results in a 50% reduction of surface wax (Pighin et al., 2004; Bird et al., 2007; Panikashvili et al., 2007; Ukitsu et al., 2007; Luo et al., 2007). This suggests that ABCG11 and 12 interact and also that there are additional transporters involved in wax secretion (Bird et al., 2007). ABCG11 is likely involved in the transport of cutin precursors as well, since the *abcg11* mutation results in epidermal fusions and

a 30% reduction in cutin monomers (Bird et al., 2007; Panikashvili et al., 2007; Ukitsu et al., 2007). Lipid transfer proteins have been suggested to be involved in the transport of cuticular lipids from the PM through the cell wall and to the cuticle (Somerville et al., 2000). One member of this family, LTPG, appears to be involved in wax transport and is localized to the exterior face of the PM (DeBono et al., 2009; Lee et al., 2009). However, LTPG is a glycosylphosphatidylinositol (GPI)-anchored, LTP and it is unclear if this protein moves across the cell wall with wax cargo after cleavage of the GPI anchor or has a different function in wax export.

Cuticular wax biosynthesis is controlled, at least in part, at the level of transcription. Overexpression of AP2/EREBP-type transcription factors SHN1/WIN1, SHN2, or SHN3 upregulates

many wax biosynthetic genes and causes significant increases in all cuticular wax components (Aharoni et al., 2004; Broun et al., 2004). The MYB-type transcription factors MYB30 and MYB41 directly or indirectly modulate genes involved in fatty acid elongation and cuticle metabolism (Cominelli et al., 2008; Raffaele et al., 2008). Wax accumulation in Arabidopsis is also controlled by the mRNA stability of a repressor of transcription that controls the expression of *CER3* (Hooker et al., 2007). Furthermore, drought or high-salt treatments stimulate cuticular lipid accumulation in Arabidopsis with a correlative increase in cuticular lipid-related gene transcripts (Kosma et al., 2009). Overall, though, the regulatory mechanisms by which cuticular wax formation is developmentally regulated or in response to environmental cues (e.g., drought) are currently unknown.

Major unanswered questions:

1. How are alkanes synthesized? What enzymes are involved?
2. How are waxes transported from the endoplasmic reticulum to the plasma membrane and then across the cell wall to the surface?
3. What are the regulatory mechanisms controlling cuticular wax biosynthesis?

2.9. Biosynthesis of Cutin Polyesters

(Fred Beisson and Yonghua Li-Beisson¹³)

The cuticle of land plants is a noncellular hydrophobic layer that covers and seals the epidermis of most aerial organs (e.g., leaves, stems, floral organs, fruits). It is composed of an insoluble polymer matrix (cutin) embedded and covered with a complex mixture of hydrophobic molecules (waxes, see Section 2.8). One of the largest biological interfaces in nature, the cutin-based cuticle is a major barrier against water loss and the first physical barrier encountered by most phytopathogens (Jetter et al., 2006).

Because of its polymeric and insoluble character, cutin has been much less studied than its associated waxes (Kolattukudy, 2001a; Nawrath, 2006; Pollard et al., 2008). The cutin polymer is known to be composed of mostly C16 and C18 fatty acid derivatives (such as hydroxy-fatty acids and fatty diacids) that are esterified to each other and to glycerol, hence the term *polyester*. Cutin monomer composition can be determined by delipidation of isolated cuticles or whole organs, chemical cleavage of ester bonds, monomer extraction in organic phase, and gas chromatography mass spectrometry (GC-MS) analysis [see Section 3.8]. In many species, including Arabidopsis, a residue with a high aliphatic content called *cutan* often remains after delipidation and depolymerization of isolated cuticles. Cutan could be a polymer distinct from cutin or might correspond to a fraction of the cutin polymer in which monomers are linked by ether or C-C bonds in addition to ester bonds.

¹³ Department of Plant Biology and Environmental Microbiology, CEA/CNRS/Aix-Marseille University, Cadarache, France. Email: frederic.beisson@cea.fr or yonghua.li@cea.fr

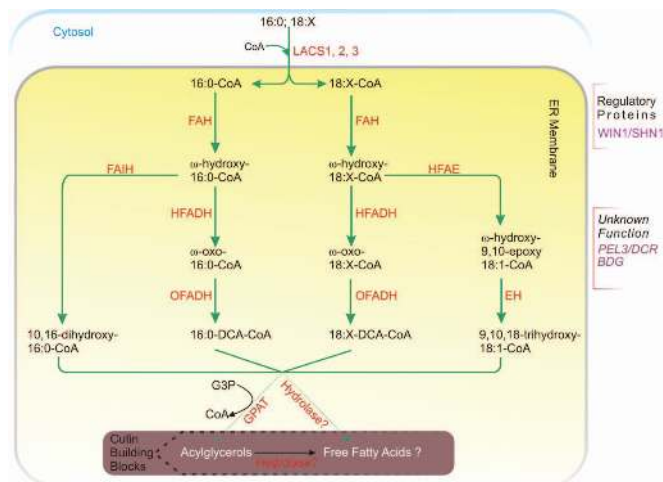

Figure 10. Proposed Pathways for the Synthesis of the Cutin Polyester.

(A) This biosynthetic scheme represents one possible scenario for the synthesis of cutin building blocks (possibly acylglycerols and free fatty acids) and their assembly. It is assumed that the sequential order of reaction on acyl chains is activation to coenzyme-A by LACS, oxidation by P450s, and esterification to glycerol-3-phosphate by GPATs.

Abbreviations: EH, epoxide hydrolase; FAH, Fatty acyl ω-hydroxylase; FAIH, Fatty acyl in-chain hydroxylase; G3P, glycerol-3-phosphate; GPAT, glycerol 3-phosphate acyltransferase; HFADH, ω-hydroxy fatty acyl dehydrogenase; HFAE, ω-hydroxy fatty acyl epoxygenase; LACS, long-chain acyl-coA synthetase; LTP, lipid transfer proteins; OFADH, ω-oxo fatty acyl dehydrogenase; PS, polyester synthase.

For additional details on genes involved in these reactions, please see http://aralip.plantbiology.msu.edu/pathways/cutin_synthesis_transport

While Arabidopsis stems and leaves have an atypical cutin composition rich in unsaturated diacids (Bonaventure et al., 2004b), Arabidopsis flowers are rich in the typical cutin monomer 10,16-dihydroxypalmitate (Beisson et al., 2007). Early insights into the enzymes and reactions involved in lipid polyester biosynthesis came mostly from the work of Kolattukudy's group in the 1970s and 1980s (Kolattukudy, 2001a), as well as biochemical studies of fatty acid oxidases (Kandel et al., 2006). Major progress in cutin research has long been hampered by the fact that Arabidopsis cutin mutants are not easily identified.

In the past 5 years, significant progress has been made in our understanding of cutin synthesis and secretion in Arabidopsis. This includes the isolation by genetic screens of mutants affected in cuticle (permeability, pathogen resistance, or epidermal fusions), the development of methods to analyze and quantify lipid polyesters in Arabidopsis (Bonaventure et al., 2004b; Franke et al., 2005; Molina et al., 2006), the identification of candidate genes for biosynthesis of cutin and associated waxes by transcriptomic studies (Suh et al., 2005), and the generation and characterization of Arabidopsis cutin mutants by reverse genetics (reviewed in Pollard et al., 2008).

Genetic and biochemical studies have led to the identification of several proteins required for the synthesis of cutin: fatty acyl oxidases (cytochrome P450 - CYP86 family; Benveniste et al., 1998; Wellesen et al., 2001; Xiao et al., 2004; Y.H. Li et al., 2007a; Rupasinghe et al., 2007; Molina et al., 2008), acyl-activating en-

zymes (LACS family; Schnurr et al., 2004; Bessire et al., 2007; Lü et al. 2009; Weng et al. 2010) and acyltransferases (GPAT family, Y.H. Li et al., 2007a; Li-Beisson et al., 2009). Recently, the in-chain hydroxylase responsible for the formation of 10,16-dihydroxypalmitate was identified as CYP77A6, a member of a family of cytochrome P450s with no previously described biological function (Li-Beisson et al., 2009). The biochemical activity of all these proteins has been partially characterized, but the exact substrates have not yet been determined. The sequential order of action of most enzymes is thus still unknown. For example, the substrate of the hydroxylases could be free fatty acids, the product of acyl-activating enzymes (acyl-CoAs), or the products of GPAT acyltransferases (acylglycerols). In the case of 10,16-dihydroxypalmitate biosynthesis, genetic and biochemical evidence has indicated that the in-chain hydroxylase CYP77A6 acts after the ω -hydroxylase CYP86A4 (Li-Beisson et al., 2009). Recent results show that GPAT4 and GPAT6 esterify acyl groups predominantly to the *sn*-2 position of glycerol and possess a phosphatase activity (Yang et al., 2010). Such a bifunctional activity has not previously been described in any organism and may be specific to the biosynthesis of extracellular glycerolipid polymers. GPAT5 and other members of this family also are *sn*-2 acyltransferase but do not appear to have phosphatase activity. Transfer to the *sn*-2 position may help the cell bifurcate the typical membrane/storage glycerolipids from extracellular acylglycerol polyesters.

Three other proteins with no demonstrated biochemical activity have been tentatively mapped to reactions of cutin biosyn-

thesis: HOTHEAD (HTH; Kurdyukov et al., 2006b) to diacid formation and BODYGUARD (BDG; Kurdyukov et al., 2006a) and DCR (Panikashvili et al., 2009) to polymer assembly. None of the proteins affecting cutin biosynthesis have been localized at the subcellular level except BDG, which is localized in the cell wall, and DCR, which is mostly localized to the cytosol.

Several enzymes catalyzing major steps required for biosynthesis still need to be identified. These include epoxygenase, epoxide hydrolases, diacid-forming oxidases, and the polyester synthetase, which is the enzyme(s) catalyzing the esterification of hydroxyacids to each other and to diacids (i.e., the elongation of polyester chains). It is important to note that it is not even known if this key step of polyester assembly is intracellular or occurs in the apoplast.

The similar hydroxyacid and fatty acid-based chemical composition of cutin and the aliphatic part of suberin (see Section 2.10) is reflected in the fact that some enzymes of biosynthesis are encoded by the same gene families (e.g., GPAT acyltransferases and CYP86A fatty acid oxidases) or that the same protein (e.g., GPAT4) is involved in the synthesis of both polyesters (Li-Beisson, unpublished data). The similarity of the cutin and suberin biosynthetic machineries (enzymes and transport mechanisms) is further substantiated by the fact that the ectopic coexpression in Arabidopsis of suberin-related proteins (GPAT5 and CYP86A1, GPAT5 and CYP86B1) results in the production of suberin-like monomers in the cutin layer of stems (Y.H. Li et al., 2007a; Molina et al., 2009).

One of the greatest challenges of cutin research is to understand how a hydrophobic polymer or its precursors can be efficiently transported through aqueous compartments (cytosol, cell wall) to be secreted at the epidermal surface. This path represents a major carbon flux at the level of epidermal cells because it has been estimated that the flux of acyl chains exported to the cell wall (cutin and waxes) can represent up to 60% of the total flux of fatty acid synthesis in epidermal cells of rapidly elongating stems (Suh et al., 2005). The fact that the overexpression of the acyltransferase GPAT5 results in the accumulation of monoacylglycerols and free fatty acids in the cuticle (Y.H. Li et al., 2007b) supports the view that acylglycerols and fatty acids are important intermediates in polyester biosynthesis and are possibly the components that are transported. Transport of cutin precursors through the plasma membrane could involve the ABC transporter WBC11, which was recently found to be important for both wax and cutin accumulation (Bird et al., 2007; Luo et al., 2007; Panikashvili et al., 2007; Ukitsu et al., 2007). This scenario might imply an extracellular polymerization of cutin precursors. However, it cannot be ruled out that large oligomers or the whole polymer of cutin could be assembled intracellularly and secreted through the cell wall.

The only regulatory protein known in the cutin biosynthesis pathway is WIN1/SHN1, a transcription factor belonging to a clade of the AP2-domain/ethylene response element binding protein super family of Arabidopsis (Aharoni et al., 2004), which has been shown to bind to the *LACS2* promoter (Kannangara et al., 2007). WIN1 over-expression activates the expression of other genes known to be involved in cutin synthesis such as *GPAT4* and *CYP86A4*. Characterization of other genes induced by WIN1 overexpression might lead to discovery of new players in the cutin biosynthesis pathway.

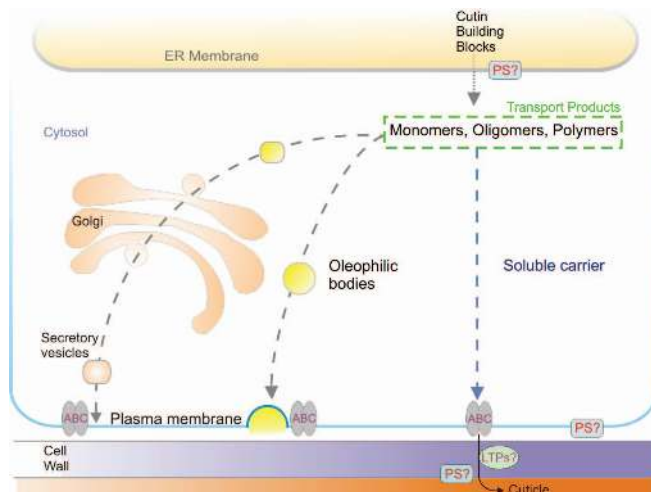

Figure 10. (continued)

(B) The site of polymerization (intra- or extracellular) and, thus, the nature of the molecules transported across the cytoplasm and cell wall remain unknown (adapted from Pollard et al., 2008).

Abbreviations: EH, epoxide hydrolase; FAH, Fatty acyl ω -hydroxylase; FAIH, Fatty acyl in-chain hydroxylase; G3P, glycerol-3-phosphate; GPAT, glycerol 3-phosphate acyltransferase; HFADH, ω -hydroxy fatty acyl dehydrogenase; HFAE, ω -hydroxy fatty acyl epoxygenase; LACS, long-chain acyl-coA synthetase; LTP, lipid transfer proteins; OFADH, ω -oxo fatty acyl dehydrogenase; PS, polyester synthase.

For additional details on genes involved in these reactions, please see http://aralip.plantbiology.msu.edu/pathways/cutin_synthesis_transport_2

Major unanswered questions:

1. Which steps in cutin assembly occur inside the cell, and which occur outside the cell?
2. How do the presumably insoluble precursors or partially assembled cutin structures exit the cell and travel through the cell wall to reach the surface of epidermal cells?
3. Is cutin insoluble due to its large size or cross-links to the cell wall or to other factors?
4. What is the structural and metabolic relationship between cutin and cutan?

2.10. Biosynthesis of Suberin Polyesters(Isabel Molina¹⁴ and Rochus B. Franke¹⁵)

Suberin is a complex hydrophobic polymer deposited close to the plasma membrane in the cell wall of plant–environment interfaces. It functions as a barrier against uncontrolled water and nutrient loss and microbial aggression (Kolattukudy, 2001b). Suberin is typically found in the periderm of secondary shoots and roots and in the hypodermis and endodermis of primary roots (Franke and Schreiber, 2007; Pollard et al., 2008). Suberin depositions have also been detected in floral abscission zones and seed coats (Espelie et al., 1980; Molina et al., 2006, 2008). Furthermore, suberization is locally induced upon wounding and environmental stress conditions.

Suberin is generally described as a glycerol-based, aliphatic polyester associated with cross-linked polyaromatics and embedded waxes (Bernards, 2002; Graça and Santos, 2007). Here, we limit our scope to the biosynthesis of the suberin polyester. Monomers released by transesterification of Arabidopsis suberin are mainly ω -oxygenated and partially unsaturated fatty acid derivatives, namely ω -hydroxyacids and α,ω -dicarboxylic acids (α,ω -DCAs), plus carboxylic acids, primary alcohols, and ferulate. While root suberin is dominated by C16, C18:1, and C22 monomers (Franke et al., 2005), the predominant chain lengths in the seed coat are C22 and C24 (Molina et al., 2006). Glycerol, which forms mono- and diesters with ω -hydroxyacids and α,ω -DCAs in suberized bark periderms (Graça and Pereira, 2000; Graça and Santos, 2006a, 2006b), was also identified in depolymerization products of Arabidopsis suberin. Furthermore, monoacylglycerols (MAGs) have been found in extracts of periderm-containing Arabidopsis roots (Y.H. Li et al., 2007b). These soluble components resemble proposed structural constituents of the polyester and may represent biosynthetic intermediates (Y.H. Li et al., 2007b). In structural models of potato and cork suberin, ester-bound hydroxycinnamates, mainly ferulate, are proposed to link polyaliphatics to polyaromatics and cell wall carbohydrates (Bernards, 2002; Graça and Santos, 2007).

Progress in understanding the biosynthesis and structure of suberin has been slow, and many aspects remain unknown. In the late 1970s, Kolattukudy and coworkers characterized fatty acid ω -hydroxylation and ω -hydroxyacid oxidation activities from

cutinizing and suberizing tissues (Agrawal and Kolattukudy 1977, 1978; Soliday and Kolattukudy, 1977). Further progress of biochemical approaches was probably limited because suberin catalysts are associated with membrane systems and/or enzyme complexes. The biochemical characterization of recombinant fatty acid ω -hydroxylases has been advanced (Kandel et al., 2006) but largely without assignments to specific biological processes. With the molecular genetic tools available for Arabidopsis and the development of quantitative methods for the chemical analysis of Arabidopsis suberin (Franke et al., 2005; Molina et al., 2006), molecular genetic approaches were initiated. As no suberin-targeted forward genetic screen has yet been developed, bioinformatics-guided reverse genetics has emerged as a successful strategy to identify suberin-involved genes, and significant progress has been made in the past few years.

The C16 and C18 acyl precursors for suberin aliphatic biosynthesis are provided by plastidial FA biosynthesis and/or acyl editing of membranes (Bates et al., 2007). These fatty acids undergo acyl-oxidation and acyl-transfer reactions to produce suberin building blocks (i.e., acyl glycerols). Alternatively, fatty acyl-CoAs are elongated by enzymes of the fatty acid elongation (FAE) complex to produce C20-C24 acyl-CoAs, which are also oxygenated and transferred to G3P. The biosynthetic scheme shown in Figure 11 represents one possible scenario where we assume that acyl oxidation occurs after elongation and before esterification to glycerol. At present, the order of such reactions remains unclear.

Despite differences in composition and localization, the synthesis of cutin and aliphatic suberin precursors involve proteins of the same enzyme families, namely the CYP86 subfamily of P450 monooxygenases, acyl-CoA synthetases of the LACS family, and acyl-transferases of the GPAT family (Figure 1). Compositional analysis of suberin from insertion mutants uncovered chain-length-specific changes demonstrating that the fatty acid ω -hydroxylases CYP86A1 (Y.H. Li et al., 2007a; Höfer et al., 2008) and CYP86B1 (Compagnon et al., 2009; Molina et al., 2009) are required for the biosynthesis of C16-C18 and C22-C24 ω -oxygenated fatty acids in suberin, respectively. Whether these oxidases are multifunctional and can catalyze all ω -oxidation steps to form α,ω -DCAs, as shown for CYP94 members (Kandel et al., 2006, 2007), is still unknown. The alternative is a two-step oxidation by dehydrogenases including proteins related to the cutin-involved HTH (Kurdyukov et al., 2006a). Similar reverse genetics approaches demonstrated that the FAE component KCS2 (Franke et al., 2009) and the G3P acyltransferase GPAT5 (Beisson et al., 2007) are involved in the biosynthesis and transfer of C20-C24 monomers, respectively. The moderate chemical phenotypes suggest the involvement of partially redundant enzymes of the CYP, GPAT, and KCS families. Other catalysts such as LACS, HTH-like ω -hydroxyacid dehydrogenases, fatty acid desaturases (FAD), CER4-like alcohol-forming fatty acyl-CoA reductases (AlcFAR), can be deduced by analogy to cutin (Figure 10) or wax biosynthesis (Figure 9). In fact, chemical analyses of loss-of-function mutants of the cutin-related *LACS2* (Molina, unpublished data) and *GPAT4* (Li-Beisson, unpublished data) genes indicate additional roles in suberin formation. Mutant analysis also allowed the discovery of an acyltransferase of the family of Benzyl alcohol acetyltransferase, Anthocyanin-O-hydroxycinnamoyltransferase, anthranilate-N-Hydroxycinnamoyl/benzoyltransferase, and Deacetylindoline 4-O-acetyltransferase (BAHD) family that func-

¹⁴ Department of Biology, Algoma University, Sault Ste Marie, Ontario, Canada. E-mail: isabel.molina@algomau.ca

¹⁵ Institut für Zelluläre und Molekulare Botanik, Universität Bonn, Bonn, Germany. Email: rochus.franke@uni-bonn.de

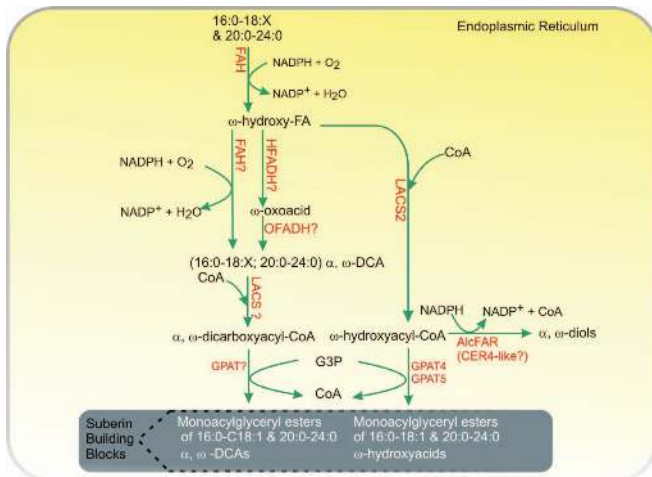

Figure 11. Proposed Pathways for the Synthesis of Suberin Aliphatic Polyester.

This biosynthetic scheme represents one possible scenario for the synthesis of suberin building blocks (i.e., acyl glycerols), where we assume that acyl oxidation occurs after elongation and before esterification to glycerol (or G3P). So far, the order of such reactions remains unclear. Likewise, subcellular compartments where these pathways may take place are unknown, but fatty acid modification and acyl glycerol synthesis steps are believed to take place in the ER membranes. Transport mechanisms required to transfer monomers or oligomers/polymers to the site of polyester assembly remain hypothetical (Pollard et al., 2008). ABC transporters and a membrane-bound LTP (LTPG1) have been associated with cuticular wax synthesis (DeBono et al., 2009), and homologous proteins could be involved in suberin assembly. Polyester synthase(s), required to link monomers to produce high molecular weight polyesters, as well as polymerization site(s) remain unknown, although an extracellular protein (BDG) belonging to the $\alpha\beta$ -hydrolase superfamily has been proposed as a cutin synthase (Kurdyukov et al., 2006).

(A) Synthesis of aliphatic suberin monomers.

Abbreviations: 4CL, 4-coumarate ligase; ABC, ATP binding cassette transporter; AlcFAR, alcohol-forming fatty acyl-CoA reductase; ASFT, aliphatic suberin feruloyl transferase; BDG, BODYGUARD; DCR, DEFECTIVE IN CUTICULAR RIDGES; CCoAOMT, caffeoyl coA O-methyltransferase; FAH, Fatty acyl ω -hydroxylase; G3P, glycerol-3-phosphate; GPAT, glycerol 3-phosphate acyltransferase; HFADH, ω -hydroxy fatty acyl dehydrogenase; LACS, long chain acyl-coA synthase; LTP, lipid transport protein; LTPG, glycosylphosphatidylinositol (GPI)-anchored protein; OFADH, ω -oxo fatty acyl dehydrogenase; ω -hydroxy-FA, ω -hydroxy fatty acid, PS, polyester synthase

For additional details on genes involved in these reactions, please see http://aralip.plantbiology.msu.edu/pathways/suberin_synthesis_transport

tions as an aliphatic suberin feruloyl transferase (ASFT; Molina et al., 2009). Heterologous protein expression experiments confirmed that ASFT catalyzes the acyl transfer from feruloyl-CoA to ω -hydroxyfatty acids and fatty alcohols (Molina et al., 2009). In addition, mutant phenotypes may also facilitate our understanding of suberin structure. Indeed, the compositions of both *asft* and *cyp86b1* knockout (KO) mutants question two aspects of the current models for suberin, namely esterified ferulate as a linker between the aliphatic and aromatic domains and the existence of an extended aliphatic polyester (Molina et al., 2009). Other reactions presented in Figure 11 are still unknown.

Ectopic expression of fluorescent protein fusions demonstrated that key enzymes in suberin aliphatic biosynthesis, CYP86A1 (Höfer et al., 2008) and CYP86B1 (Compagnon et al., 2009), are associated with the ER. Membrane targeting predictions for GPAT5, GPAT4, and HTH (Schwacke et al., 2003) and subcellular localization of FAE components tagged with green fluorescent proteins (GFP; Kunst and Samuels, 2003; Zheng et al., 2005; Bach et al., 2008) imply that the bulk of suberin monomer biosynthesis takes place at the ER. Furthermore, P450 monooxygenases in ferulic acid formation are also ER-membrane associated (Boerjan et al., 2003). Thus, most of the reactions shown in Figure 11 are predicted to take place on the ER membranes.

Completely unknown are the intermediates being transported and the reactions required for export, interlinkage of precursors, and macromolecular assembly that finally give rise to the highly organized lamellar structure of suberin depositions observed by transmission electron microscopy (TEM; Bernards, 2002; Graça and Santos, 2007). Exported suberin building blocks might be fatty acids, MAGs, or preformed oligomeric esters (Pollard et al., 2008). Plasma membrane-localized ABC transporters (Bird, 2008) and LTPs (DeBono et al., 2009, Lee et al., 2009) have been demonstrated to be required for apoplastic cuticular lipid deposition. Peridermal transcriptome (Soler et al., 2007) and transcript coexpression analyses suggest a role for these transporters in suberin synthesis. Alternatively, exocytotic export mechanisms involving secretory vesicles or oleophilic bodies could facilitate transport of suberin intermediates. Because fungal lipases can polymerize suberin monomers in vitro (Olsson et al., 2007), candidate(s) for an unknown polyester synthase include extra-

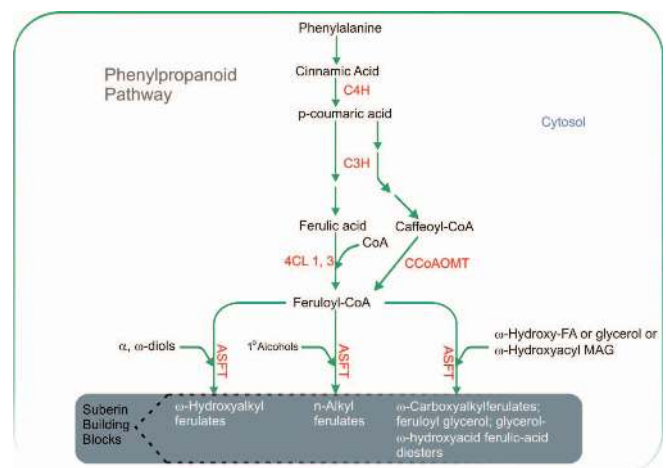

Figure 11. (continued)

(B) Synthesis of aromatic suberin monomers for the aliphatic domain.

Abbreviations: 4CL, 4-coumarate ligase; ASFT, aliphatic suberin feruloyl transferase; C3H, Coumarate 3-hydroxylase; C4H, Cinnamate 4-hydroxylase; CCoAOMT, caffeoyl coA O-methyltransferase; MAG, monoacylglycerol.

For additional details on genes involved in these reactions, please see http://aralip.plantbiology.msu.edu/pathways/suberin_synthesis_transport_2

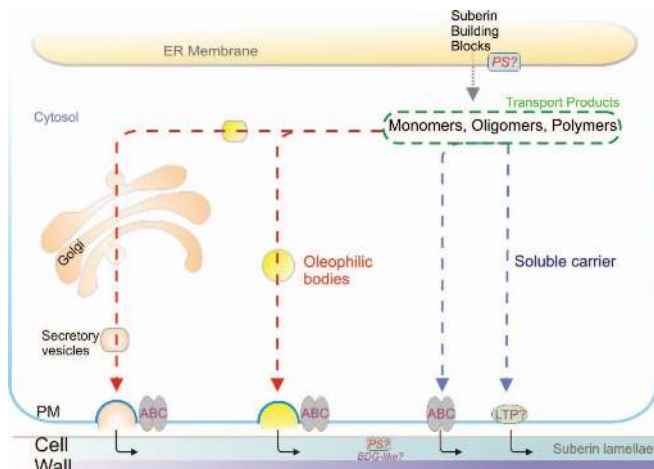

Figure 11. (continued)

(C) Potential transport mechanisms involved in the assembly of suberin polyesters.

Abbreviations: ABC, ATP binding cassette transporter; BDG, BODYGUARD; DCR, DEFECTIVE IN CUTICULAR RIDGES; CCoAOMT, caffeoyl coA O-methyltransferase; FAH, Fatty acyl ω -hydroxylase; G3P, glycerol LTP, lipid transport protein; PS, polyester synthase

For additional details on genes involved in these reactions, please see http://aralip.plantbiology.msu.edu/pathways/suberin_synthesis_transport_3

cellular BDG-like esterases of the α , β -fold hydrolase family and GDSL lipases (named for the GDSL amino acid sequence of their active site).

The restriction of suberin depositions to specific, often mono-cellular tissue layers; the localized deposition in certain cell wall domains (e.g., Casparian bands); and the induction upon environmental stresses indicate that suberin biosynthesis must be tightly regulated at the tissue and cellular level. Additional regulatory complexity is given by the coordination of acyl and phenylpropanoid metabolism. To date, no regulators in suberin biosynthesis have been identified. Interestingly, mutations in the functionally unknown *ENHANCED SUBERIN* gene (*ESB1*) led to a twofold increase in aliphatic root suberin (Baxter et al., 2009). *ESB1* has similarity with dirigent proteins, which are proposed to be involved in the stereochemistry and apoplastic arrangement of aromatics prior to polymerization (Davin and Lewis, 2005).

Major unanswered questions:

1. What are the *in vivo* substrates for suberin aliphatic oxidation enzymes? Are they free or conjugated (CoA, MAG) acyl donors?
2. How is the temporal and spatial control of suberization regulated?
3. How is the organized lamellar structure of suberin depositions, as observed by TEM, generated at the molecular level?
4. What is the function of aromatics in suberin structure and cross-linking?

2.11. Triacylglycerol Lipases

(Vincent Arondel* and Rémi Zallot¹⁶)

2.11.1. Background

Triacylglycerol lipases are enzymes that hydrolyze long-chain, insoluble TAGs. Their biochemical properties and structure–function relationships have been extensively studied in mammals, fungi, and bacteria (Woolley et al., 1994; Schmid and Verger, 1998). Their most important features are summarized in this section.

All possess the same fold, called α / β hydrolase fold (Ollis et al., 1992). This fold is not specific for TAG lipases, as other carboxylesterases unable to hydrolyze lipids share the same fold. The active site is made of a catalytic triad (ser, asp/glu, his). Despite this structural homology, several families of lipases have been described. Their sequences can diverge widely, and only a loose consensus around the catalytic serine (Prosite PS00120) can be noted. Not all known TAG lipases contain this consensus, while a few non-lipolytic esterases do. Therefore, it is not possible to predict a TAG lipase based on sequence information only. Recently, TAG lipases responsible for the mobilization of intracellular stores in yeast, mammals, insects, and plants have been identified (Zechner et al., 2009). They differ from previously characterized TAG lipases: They resemble calcium-independent phospholipase A2 (iPLA2), they contain a so-called patatin domain, and their active site is made of a catalytic dyad.

TAG lipases can be capable of hydrolyzing other substrates. For instance, most of them can hydrolyze DAG and, more rarely, MAG. In addition, some of them can hydrolyze phospholipids at the *sn*-1 position, cutin polymer, polyhydroxyalkanoates, steryl esters, and CoA esters. It is likely that widening the range of substrates used to characterize TAG lipases would show several other possible substrates. Actually, lipases used in bioconversions can act on numerous substrates (Schmid and Verger, 1998). Therefore, it is not because an enzyme hydrolyzes TAGs that it acts necessarily as a TAG lipase *in vivo*. Actually, there are about 50 to 70 putative TAG lipases (based on sequence similarity) in Arabidopsis; it is unlikely that all these enzymes are physiological TAG lipases (aside from the fact that these might be non-lipolytic esterases). For instance, the ‘Defective In Anther Dehiscence1’ (*DAD1*) (Ishiguro et al., 2001) encodes a lipase that hydrolyzes both TAGs and glycerolipids; it is likely that only the last function is physiologically relevant (i.e., release of linolenic acid for jasmonate synthesis; Acosta and Farmer, 2010); the activity of recombinant *DAD1* on TAGs represents 6% than that on phosphatidylcholine. Furthermore, many enzymes have been sometimes hastily classified as lipases based on partial biochemical characterization. This is the case for the so-called GDSL family of lipases (Akoh et al., 2004). Because insoluble substrates such as TAGs are not convenient to handle, numerous enzymatic studies have been carried out using soluble chromogenic substrates (Huang, 1993; Beisson et al., 2000) such as short-chain esters of paranitrophenol (e.g., para-nitrophenyl acetate or butyrate). Unfortunately, these substrates can be hydrolyzed by esterases that are unable to hydrolyze true lipids. Only the GDSL lipase purified from sunflower has been quantitatively characterized (Teissere et al., 1995) with regard to true lipase activity:

¹⁶ Laboratoire de Biogenèse Membranaire, CNRS/University of Bordeaux, CNRS UMR5200, Bordeaux, France. *Email: vincent.arondel@u-bordeaux2.fr

The specific activity on long-chain TAGs (15 nmol fatty acids min⁻¹ mg⁻¹) is five orders of magnitude below the one of pure human pancreatic lipase (3000 μmol min⁻¹ mg⁻¹) and 3000 times less than pure recombinant SDP1. Recently, a pure GDSL lipase from *B. napus* was found to hydrolyze sinapoyl-choline (Clauss et al., 2008) with a specific activity of 10 μmol min⁻¹ mg⁻¹. Therefore, it is clear that GDSL "lipases" are esterases. Whether some of them can indeed hydrolyze lipids and can be physiological lipolytic enzymes cannot be excluded, but this remains to be firmly demonstrated.

2.11.2. TAG lipases in Arabidopsis

Biochemical data are available on several TAG lipases from higher plants, most of them obtained from non-pure fractions (Huang, 1993; Mukherjee, 1994). One of the most studied enzymes is castor bean acid lipase, cloned in 2004 (Eastmond, 2004). Only seed and seedling lipases have been studied, except for lattices and the fruit of oil palm. However, TAGs are likely to be present in trace amounts in all tissues (W.L. Lin and Oliver, 2008) and can be abundant in other tissues/organelles than seed oil bodies.

In Arabidopsis, four possible lipases have been cloned and the corresponding recombinant enzymes characterized. AtLIP1 (El-Kouhen et al., 2005) resembles lysosomal acid lipase. It hydrolyzes TAGs with a specific activity estimated at 45 μmol min⁻¹ mg⁻¹. It appears to hydrolyze neither phospho- and galactolipids nor cholesterylolate. The knockout mutant does not show any obvious phenotype and is not impaired in post-germinative fat storage breakdown. SAG101 (He and Gan, 2002) is a lipase-like protein that plays a role in leaf senescence: Senescence is delayed in antisense plants while over-expression of the gene leads to premature senescence. SAG101 recombinant protein exhibits a weak TAG lipase activity (about 4 nmol min⁻¹ mg⁻¹). At2g31690 codes for a protein that resembles fungal lipases (Padham et al., 2007). It locates to the plastid and is most abundant in 6-week-old leaves. Confocal microscopy studies suggest that neutral lipids are more abundant in antisense plants. Ultrastructure of plastids is modified when compared to WT and the antisense plants show delayed senescence. A purified recombinant protein hydrolyzes TAGs with a low specific activity (about 10 nmol min⁻¹ mg⁻¹). Actually, it appears to be much more active on galactolipids than on TAGs (Seo et al., 2009). A soluble enzyme (At4g24140) with acyltransferase, phospholipase, and TAG lipase activities has been described recently (Ghosh et al., 2009). Specific activities of the recombinant protein are low (pmol min⁻¹ mg⁻¹) on all substrates. Overexpression in yeast leads to a 1.5-fold increase in phospholipid content. Interestingly, At4g24140 shares sequence homology to CGI-58, a known cofactor to the mammalian lipase responsible for intracellular TAG breakdown (Zechner et al., 2009). Sugar dependant 1 (SDP1) is a lipase involved in fat storage breakdown during post germinative growth (Eastmond, 2006); it is discussed below.

2.11.3. TAG lipases involved in Arabidopsis fat storage breakdown

An ethyl methanesulfonate (EMS) mutant screen was performed to select seedlings with impaired growth on minimal media that could be rescued by transfer to a sucrose-contain-

ing medium. Among the mutants isolated, *sdp1* was found to be affected in a gene that codes for a lipase that controls fat storage breakdown (Eastmond, 2006). The gene was identified by positional cloning and characterized in depth. The evidence presented is fairly strong: Only 20% of the mutant oil is hydrolyzed in 5-day-old seedlings (vs. 98% in WT). Electron microscopy data show that lipid bodies are fairly abundant in mutant 5-day-old seedlings, while they are totally absent from WT control. While lipase activity from a mutant crude extract is reduced by about 20%, the lipase activity specifically bound to oil bodies fell by 75% when compared to WT. An SDP1-GFP fusion protein associates to oil-bodies hemi-membrane in vivo. Recombinant SDP1 protein hydrolyzes triolein with a reasonably high specific activity (50 μmol min⁻¹ mg⁻¹), which is probably underestimated due to experimental conditions (limiting substrate).

SDP1 sequence relates more to iPLA2 than to most TAG lipases. It contains a patatin domain and probably hydrolyzes its substrate through a catalytic dyad. Arabidopsis contains another related gene called SDP1-like (At3g57140). Five-day-old seedlings from a double SDP1-SDP1-like knockout contain exactly the same amount of TAGs as at day 0, strongly suggesting that SDP1-like is responsible for the weak hydrolysis of TAGs detected in the SDP1 mutant (Quettier and Eastmond, 2009).

Major unanswered questions:

1. How are TAG lipases regulated?
The lipolysis step is under regulation as the oil is not degraded in β-oxidation mutants (Graham, 2008). Also, the oil is not mobilized when plantlets are grown on a high-sucrose-low-nitrogen media (Graham, 2008). Because SDP1 transcript is predominantly detected in maturing seeds and levels are much lower during postgerminative growth, it is likely that regulation occurs at a posttranscriptional level. A few hints have been suggested (Quettier and Eastmond, 2009): A mutant affected in caleosin, an oil body protein, exhibits delayed TAG breakdown (Poxleitner et al., 2006).
2. How are DAG and MAG hydrolyzed during postgerminative growth?
SDP1 recombinant lipase shows no activity on MAG and little activity on DAGs (Eastmond, 2006). This suggests the possible involvement of other lipases capable of hydrolyzing these substrates. There are no obvious candidates, as Atlip1 does not hydrolyze MAGs, either. In mammals, MAG lipases have been described (Karlsson et al., 1997). There are about 15 proteins in Arabidopsis that resemble this enzyme (BLAST scores from 75 to 123). Again, as for TAG lipases, similarity of sequence does not necessarily mean identical function.
3. Are there other physiological TAG lipases?
The studies on TAGs have been focused mostly on seed oil bodies of oleaginous plants. However, TAGs can be found in pollen grain, tapetum cells (Hsieh and Huang, 2004), and leaves treated with ozone or in the process of senescence. Therefore, it is likely that other physiological TAG lipases exist.

2.12. Fatty Acid β -Oxidation

(Ian A. Graham¹⁷)

2.12.1. Context and location

The fatty acid β -oxidation spiral is a ubiquitous process that breaks down fatty acids derived primarily from either membrane lipid turnover or the mobilization of triacylglycerol storage reserves. In higher plants and most fungi, straight-chain fatty acid catabolism via the β -oxidation spiral is located in the peroxisomes, whereas breakdown of branched-chain amino acids via the β -oxidation spiral is distributed between the mitochondria and peroxisomes (reviewed in Graham and Eastmond, 2002; Penfield et al., 2006).

Fatty acids released by lipolysis of TAG or membrane lipids are transported across the single membrane of the peroxisome by an ABC transporter protein identified in three different genetic screens in Arabidopsis and independently named as *PEROXISOMAL ABC TRANSPORTER 1* (*PXA1*; Zolman et al., 2001), *PEROXISOME DEFICIENT 3* (*PED3*; Hayashi et al., 2002), and *COMATOSE* (*CTS*; Footitt et al., 2002). In Arabidopsis, two peroxisomal LACS enzymes act in the same pathway as the ABC transporter and are essential for the uptake of fatty acids, which raises still unanswered questions regarding the mechanism of import (Fulda et al., 2004; Penfield et al., 2006).

2.12.2. Core activities of the β -oxidation spiral

The esterification of fatty acids to acyl-CoAs by the LACS enzymes results in their activation for oxidative attack at the C-3 or β -carbon position. In each round of the β -oxidation spiral, acetyl-CoA (C_2) is cleaved from acyl-CoA (C_n), and the remaining acyl-CoA (C_{n-2}) re-enters the β -oxidation spiral to repeat the process (Figure 12). This core pathway requires the enzymes acyl-CoA oxidase (ACX), multifunctional protein (MFP), and 3-ketoacyl-CoA thiolase (KAT) to catalyze oxidation, hydration and dehydrogenation, and thiolytic cleavage, respectively, of acyl-CoA. The complete degradation of long-chain acyl-CoAs to C_2 acetyl units requires the enzymes responsible for catalyzing each step to accept substrates with diminishing carbon chain length with each passage through the β -oxidation spiral. The core group of β -oxidation enzymes has evolved two alternate strategies to cope with this range of substrates: either multiple isoforms with different chain-length specificities or enzymes with broad substrate specificity (low carbon chain length substrate selectivity).

2.12.3. Acyl-CoA oxidases

The ACXs (EC 1.3.3.6) catalyze the first step of peroxisomal β -oxidation of acyl-CoA to 2-*trans*-enoyl-CoA. Six ACX genes have been identified in Arabidopsis (Adham et al., 2005; Graham, 2008), and of these ACX1 (C12:0 to C16:0), ACX2 (C14:0 to C20:0), ACX3 (C8:0 to C14:0), and ACX4 (C4:0 to C8:0) have been characterized biochemically and shown to encode proteins with overlapping but distinct substrate specificities (Hooks et al.,

1999; Eastmond et al., 2000; Froman et al., 2000; Hayashi et al., 1999). The *ACX1*, *ACX2*, *ACX3*, and *ACX4* genes are all upregulated coordinately during Arabidopsis seed germination and early postgerminative growth (Rylott et al., 2001), which correlates with the period of most rapid breakdown of fatty acids derived from storage TAG. Compromised seed germination and seedling establishment are observed in Arabidopsis double mutants disrupted in both *ACX1* and *ACX2*, with seedling establishment but not seed germination being rescued by exogenous sucrose (Pinfield-Wells et al., 2005).

2.12.4. Multifunctional protein

MFP contains two of the core β -oxidation pathway reactions, 2-*trans*-enoyl-CoA hydratase (EC 4.2.1.17) and L-3-hydroxyacyl-CoA dehydrogenase (EC1.1.1.35), as well as additional auxiliary activities necessary for the β -oxidation of some unsaturated FAs (reviewed in Graham, 2008; Poirier et al., 2006). Arabidopsis contains two isoforms of MFP, the first of which was characterized genetically as abnormal inflorescence meristem1 (*aim1*) since it exhibits aberrant vegetative and reproductive development—a unique phenotype among the β -oxidation mutants, and one for which we still do not have a mechanistic explanation (Richmond and Bleecker, 1999; Baker et al., 2006). The second isoform, MFP2, is strongly induced during postgerminative seedling growth (Eastmond and Graham, 2000). The *mfp2* mutant requires an exogenous supply of sucrose for seedling establishment and is compromised in storage oil breakdown, but not as severely as the *acx1 acx2* double mutant or the *kat2* mutant (Rylott et al., 2006). Interestingly, the MFP2 2-*trans*-enoyl-CoA hydratase is only active against long-chain (C18:0) substrates, whereas the L-3-hydroxyacyl-CoA dehydrogenase is active on C6:0, C12:0, and C18:0 substrates (Rylott et al., 2006).

2.12.5. 3-Ketoacyl-CoA thiolase

In the β -oxidation spiral the KAT enzyme (EC 2.3.1.16) catalyzes the final thiolytic cleavage of 3-ketoacyl-CoA to acyl-CoA and acetyl-CoA. The Arabidopsis genome contains three loci that encode KAT enzymes, annotated as KAT1, KAT2, and KAT5 (At1g04710, At2g33150, and At5g48880, respectively), with KAT5 producing two polypeptides, KAT5.1 and KAT5.2, apparently as a consequence of alternate RNA splicing (Germain et al., 2001; Carrie et al., 2007). KAT2 is the only one of the three KAT genes expressed at significant levels during seed germination in Arabidopsis. *kat2* mutants are blocked in storage oil breakdown and are dependent on exogenous sucrose for seedling establishment (Germain et al., 2001). Extensive substrate specificity experiments have not been performed for the KAT proteins due to the difficulty of synthesizing long-chain substrate.

2.12.6. Auxiliary activities of the β -oxidation spiral

Many fatty acids, particularly those found in seed storage oils, have unsaturated bonds in the *cis*-configuration at even-numbered positions or unsaturated bonds at odd-numbered positions

¹⁷ Centre for Novel Agricultural Products, Department of Biology, University of York, Heslington, York, YO10 5YW, UK. Email: iag1@york.ac.uk

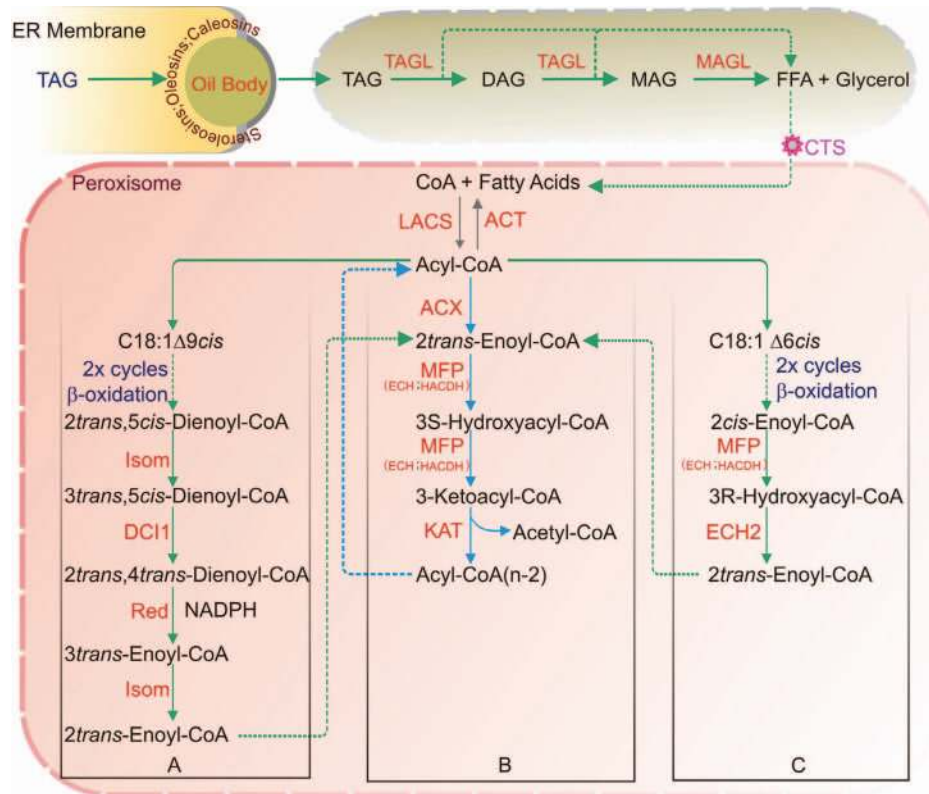

Figure 12. Triacylglycerol and Fatty Acid Degradation.

Triacylglycerols are first degraded by cellular lipases to release free fatty acids from glycerol. Then reactions involved in the β -oxidation of straight-chain fatty acids occur in the peroxisome (adapted from Goepfert and Poirier, 2007). “2x cycles” indicates that the molecule undergoes two successive rounds through the β -oxidation cycle. CTS is an ABC transporter involved in the import of oleic acid (C18:1 Δ 9*cis*).

(A) Examples of the involvement of auxiliary activities in the degradation of oleic acid (C18:1 Δ 9*cis*).

(B) The core β -oxidation cycle.

(C) Example of the involvement of the monofunctional type 2 enoyl-CoA hydratase (ECH2) in the degradation of fatty acids with a *cis* double bond on an even-numbered carbon (C18:1 Δ 6*cis*, petroselinic acid).

Abbreviations: ACT, acyl-CoA thioesterase; ACX, acyl-CoA oxidase; DCI1, D3,5,D2,4-dienoyl-CoA isomerase; Isom, D3,D2-enoyl-CoA isomerase; KAT, 3-ketothiolase; LACS, long chain acyl-CoA synthetase; MAGL, monoacylglycerol lipase; MFP, multifunctional protein containing a 2E-enoyl-CoA hydratase (ECH) and a 3S-hydroxyacyl-CoA dehydrogenase (HACDH); Red, 2,4-dienoyl-CoA reductase; TAGL, triacylglycerol lipase.

For additional details on genes involved in these reactions, please see http://aralip.plantbiology.msu.edu/pathways/triacylglycerol_fatty_acid_degradation

on the carbon chain. Both of these arrangements result in metabolic blocks for the β -oxidation pathway if only the core set of enzymes is considered.

β -oxidation of unsaturated FAs with a *cis* double bond on an even-numbered carbon eventually produces the intermediate 2-*trans*, 4-*cis*-dienoyl-CoA (Figure 12). Two alternative pathways were proposed for the continued β -oxidation of this intermediate (Schulz and Kunau, 1987). In the hydratase/epimerase pathway, 3R-Hydroxyacyl-CoA is converted to 3S-Hydroxyacyl-CoA either by an epimerase activity or an auxiliary enzyme, enoyl-CoA hydratase/epimerase (ECH2/Hydratase) (Goepfert et al., 2006), and the resulting 2-*trans*-enoyl-CoA then re-enters the normal set of core reactions of β -oxidation.

Our understanding of the complete breakdown of fatty acids with *cis* double bonds at odd-numbered carbons such as C18:1D9

cis (oleic acid) has been improved by the functional characterization of the D3,5, D2,4-dienoyl-CoA isomerase (DCI/Isomerase) and the D3, D2,-enoyl-CoA isomerases from Arabidopsis (Goepfert et al., 2005, 2008).

2.12.7. Additional roles for the fatty acid β -oxidation spiral

Arabidopsis mutants disrupted in the core steps in the β -oxidation spiral have revealed additional roles beyond the catabolism of straight-chain fatty acids, including the conversion of indole butyric acid to the phytohormone indole acetic acid (IAA; Zolman et al., 2000) and the production of the fatty acid signalling molecule jasmonic acid (Theodoulou et al., 2005). A comprehensive analysis of the biosynthesis and roles of jasmonates in Arabidopsis is provided

in another chapter of *The Arabidopsis Book* (Acosta and Farmer, 2010). A major challenge now is to understand how the flux of these different metabolites through the β -oxidation spiral is regulated, particularly since they exist at very different concentrations in the cell, with straight fatty acid metabolites being at much higher levels than substrates and intermediates giving rise to signalling molecules.

Major unanswered questions:

1. What is the exact mechanism by which fatty acids are imported and activated through the combined action of the peroxisomal ABC transporter and LACS enzymes?
2. What regulates the flux through the shared β -oxidation spiral of substrates ranging from relatively abundant straight-chain fatty acids (derived from membrane lipids and storage TAG) to much less abundant precursors for signalling molecules (such as jasmonic acid and indole acetic acid)?
3. Why does oil body TAG persist in mutants disrupted in peroxisomal fatty acid β -oxidation?
4. What is the mechanism for the coordinated regulation of expression of genes encoding enzymes of the core reactions of β -oxidation during postgerminative seedling growth?
5. What is the functional significance of genes encoding proteins with various "auxiliary" β -oxidation activities, particularly with respect to their in vivo substrates?

3. METHODS AND PROTOCOLS FOR ARABIDOPSIS LIPID ANALYSES

3.1. Lipid Extraction Methods and Separation

(Katherine M. Schmid¹⁸)

The following sections summarize methods that have been applied specifically to analysis of lipids from Arabidopsis and plant systems with similar challenges. Many other protocols are available, and readers may be especially interested in *The Lipid Library*, available online at <http://lipidlibrary.aocs.org>.

Although recent advances in nuclear magnetic resonance (NMR)-based techniques have made quantitation of oil in intact Arabidopsis seeds feasible (Jako et al., 2001; Colnago et al., 2007), most lipid analyses require extraction of the desired fractions into organic solvents. Since polarities and solubilities of lipids differ radically, methods of extraction will vary with the goals of the researcher. In all cases, oxidation of unsaturated fatty acids should be minimized by drying and storing samples under nitrogen, including antioxidants such as 25 mg L⁻¹ butylated hydroxytoluene (BHT), and avoiding diethyl ether and unstabilized chloroform. Sample containers and equipment should be chosen to prevent introduction of contaminating plasticizers and lubricants (Christie, 1993). Thus, glass or Teflon containers rinsed with high purity solvents should be used rather than plastics, Teflon tape and solvent-washed aluminum foil should replace parafilm and plastic wraps, and stopcock grease and homogenizers with exposed lubricated bearings must be avoided.

¹⁸ Department of Biological Sciences, Butler University, 4600 Sunset Avenue, Indianapolis, IN 46208. Email: kschmid@butler.edu

If native lipid species are to be characterized, it is critical to immediately denature lipases, esterases, and oxidases, which may even be stimulated by some solvents or by freezing and persist at subzero temperatures (Christie, 1993). Therefore, even quickly frozen tissues will undergo degradation when stored in the freezer. Wounding quickly and strongly activates conversion of Arabidopsis leaf fatty acids to oxophytodienoic acids (Buseman et al., 2006). Immediate brief treatment of plant tissue with boiling isopropanol to inactivate enzymes (Kates and Eberhardt, 1957) is the typical remedy and is highly recommended. To prevent transesterification artifacts, extracts should not be stored in solvents containing primary alcohols such as methanol (Christie, 1993).

Arabidopsis lipids have most often been extracted with chloroform:methanol (2:1; Folch et al., 1957) or (1:2; Bligh and Dyer, 1959) (v/v). The latter permits lower solvent-to-sample ratios, since additional methanol increases the water content at which phase separation and concomitant loss of extraction efficiency occur beyond the 6.54% (w/v) limit of chloroform:methanol (2:1; Schmid 1973). Bligh and Dyer (1959) stipulated three subsequent chloroform washes, bringing the combined extracts to chloroform:methanol (2:1). Both protocols call for induction of phase separation once extraction is complete. Use of a salt solution such as 0.88% (w/v) potassium chloride (KCl) rather than pure water to achieve optimal chloroform:methanol:water (8:4:3 v/v/v) helps keep most acidic lipids protonated, so that they partition into the lower lipid phase (chloroform:methanol:water 86:14:1) rather than being lost with polar contaminants to the upper phase (3:48:47; Folch et al., 1957). Additional washes of the lower phase with salt solution reduce lipid yield compared to washes with salt solution:methanol (1:1 v/v; Christie, 1993). For a variant of the chloroform:methanol method suggested by the Kansas City Lipidomics Research Center (<http://www.k-state.edu/lipid/lipidomics/leaf-extraction.html>), see the protocol below.

Given the toxicity of chloroform and the advantages of boiling isopropanol pretreatment, some Arabidopsis researchers have adopted extraction with hexane:isopropanol (3:2) as proposed by Hara and Radin (1978). The initial hexane:isopropanol solution yields a relatively uncontaminated extract that can be used for gas chromatography (GC) or thin-layer chromatography (TLC) analysis without partitioning or washing. However, to remove non-lipids, the extract may be partitioned into an upper hexane phase by addition of aqueous sodium sulfate (e.g., 1/2 volume 6.5% [w/v] Na₂SO₄; (Y.H. Li et al., 2006). Back extraction of the lower phase with hexane:isopropanol 7:2 is necessary to avoid loss of polar lipids. For a sample protocol, see below.

Unfortunately, few direct comparisons of laboratory scale extractions of plant material are available. Fishwick and Wright (1977) found that the procedure of Bligh and Dyer (1959) gave better lipid yields than that of Folch et al. (1957) for spinach leaf, tomato fruit, and potato tuber. A small-scale study by Khor and Chan (1985) suggested that the hexane:isopropanol procedure of Hara and Radin (1978), including a 6.5% Na₂SO₄ wash, extracted neutral lipids from soybean seeds but left behind about 4/5 of phospholipid extractable with chloroform/methanol (2:1). Schäfer (1998), however, obtained better extraction from a mixture of wheat, soybean meal, and barley with hexane:isopropanol (3:2) than with chloroform:methanol (2:1).

In addition to the general techniques above, many specialized applications are available. High-throughput techniques such as screening of total fatty acid profiles by simultaneous extraction and transmethylation of tissue samples in hot acidic methanol (Browse et al., 1986a) have been popular in the Arabidopsis community. For complete transesterification of Arabidopsis seeds or other tissues high in triacylglycerols, a cosolvent such as toluene should be included (Y.H. Li et al., 2006).

Finally, some lipids are poorly represented in extracts prepared by standard methods. Table 1 provides references to approaches for lipid classes requiring special attention.

Techniques for fractionating lipid extracts include TLC, high-performance liquid chromatography (HPLC), and column chromatography (Christie, 2003). Often a gross separation into non-polar lipids, glycolipids, and phospholipids by silicic acid column chromatography (Rouser et al., 1967) precedes further analysis.

Protocols for general extraction of Arabidopsis lipids.

- For minimum oxidation, all solvents should contain 0.01% BHT.
- Samples should be placed in glass tubes with Teflon-lined screw caps and extracted immediately after harvesting.
- Isopropanol should be preheated prior to step 1 for effective killing of phospholipase D.
- Appropriate internal standard(s) may be added in step 1.
- After extraction is complete, lipid extracts may be concentrated under a stream of nitrogen for TLC and preparation of derivatives.

Chloroform/Methanol method

For soft tissue samples up to 0.5 g fresh weight (approx. 30 mg dry weight)

1. Cover sample with 3 mL preheated isopropanol. Cap and heat at 75°C for 15 min. Cool to room temperature.
2. Add 1.5 mL chloroform and 0.6 mL water.
3. Incubate with shaking for 1 hr.
4. After transferring lipid extract to a fresh tube, reextract tissue with 4 mL chloroform:methanol (2:1 v/v).
5. Repeat step 4 until tissue is white.
6. To combined lipid extracts from steps 4 and 5, add 1 mL 1M KCl. Vortex, centrifuge, and discard upper phase.
7. To lower phase from step 6, add 2 mL water. Vortex, centrifuge, and discard upper phase.

Hexane/Isopropanol method

For up to 1 g fresh weight

1. Add 8 volumes isopropanol (v/w) to sample. Cap and heat at 80°C for 5 min. Cool to room temperature.
2. Add 12 v/w of hexane.
3. Homogenize (mortar and pestle, polytron, or other suitable equipment).
4. Briefly centrifuge to facilitate separation of lipid extract from tissue.
5. Transfer the upper phase (hexane:isopropanol-containing lipids) to another tube.
6. For complete recovery, re-extract the pellet with hexane:isopropanol (7:2) and combine extracts with upper phase from step 5.
7. If less contamination of the extract is required, partition the hexane:isopropanol with Na₂SO₄ as described by Hara and Radin (1978) or Y.H. Li et al. (2006).

Modified Bligh and Dyer (1959) protocol for lipid extraction from Arabidopsis leaves.

1. Put frozen plant material (snap-frozen in liquid nitrogen and stored in -80°C, put back in liquid nitrogen prior to extraction) in a glass homogenizer
2. Add 3.75 mL MeOH:CHCl₃ (2:1, v/v).
3. Add 1mL 1mM EDTA in 0.15M HAc (acetic acid).
4. Homogenize carefully.
5. Transfer to a fresh glass tube with screw cap (cap with teflon rubber inside).
6. Rinse homogenizer with 1.25 mL CHCl₃; transfer to the glass tube.
7. To the glass tube, add 1.25 mL 0.88% (w/v) KCl.
8. Vortex carefully.
9. Centrifuge appr. 3000 rpm for 2 min.
10. Transfer lipid (CHCl₃-) phase (lower phase) with a Pasteur pipette to a fresh glass tube, store in freezer -20°C.

Table 1. Extraction Methods for Acyl Lipids Not Amenable to Standard Chloroform/Methanol Extraction Techniques

Lipid Class	Extraction Solvent or Approach	Reference
Acyl ACP	2.5% trichloroacetic acid; resuspend in buffer and analyze by immunoblotting	Post-Beittenmiller et al., 1991
Acyl coenzyme A	isopropanol:50 mM KH ₂ PO ₄ 7.2:glacial acetic acid:50 mg mL ⁻¹ BSA (2:2:0.05:0.08 v/v/v/v)	Larson and Graham, 2001 ^a
Acylcarnitine	acetonitrile:MeOH (4:1 v/v)	Bourdin et al., 2007 ^a
Cutin/suberin	hydrogenolysis or transmethylation of solvent-insoluble epidermal residue	Bonaventure et al., 2004b ^a
Lysophospholipids	n-butanol chloroform:methanol (2:1 v/v) minus partitioning	Bjerve et al., 1974; Seo et al., 2008 ^{a*} Bjerve et al., 1974; W. Li et al., 2008 ^a
Phosphatidylinositol phosphates	Chloroform:methanol:2.4M HCl:0.4M EDTA 36:36:18:9 (v/v/v/v)	König et al., 2008 ^a
Complex sphingolipids	direct hydrolysis in dioxane:10% aqueous Ba(OH) ₂ (1:1 v/v) isopropanol:hexane:water (50:20:25 v/v/v)	Sperling et al., 1998 ^a , 2005 ^a Markham and Jaworski, 2007 ^a

^aCitation includes application to Arabidopsis.

3.2. Determination of Total Fatty Acid Profiles

(Martine Miquel¹⁹)

In plants, fatty acids are mainly present as esters linked to glycerol, sterols, or waxes (long-chain alcohols) or as amides to sphingolipids, while free (unesterified) fatty acids are minor constituents. The total fatty acid profile of plant tissues other than seeds (see Section 3.4) or from lipid extracts can be determined by direct transesterification followed by analysis by GC or GC-MS. This process applies to the most commonly found fatty acids ranging from 14 to 24 carbon straight chains with zero to three double bonds. Fatty acids are identified by comparison of retention times (and also split patterns) to standards. With addition of an internal standard such as heptadecanoic acid (C17:0), which is normally not present in the lipid extracts, the quantity of each fatty acid in the sample analyzed can be determined. A typical GC chromatogram of Arabidopsis leaf is provided in Figure 13.

For fresh tissue, for example, from leaf or root, the following acid-based procedure (Browse et al., 1986a) is widely used. This procedure allows methylation of both free fatty acids and

transmethylation of *O*-acyl lipids. *O*-acyl lipids and free fatty acids in lipid extracts can be transesterified/methylated using the same protocol. For particular cases (short-chain and unusual fatty acids, free fatty acids, sphingolipids and *N*-acyl lipids, derivatization for GC-MS), protocols are available (Christie, 1993, 2003), as well as beginner's guides on methylation of fatty acids (<http://www.lipidlibrary.co.uk/topics/methests/index.htm>) and mass spectrometry of fatty acids (http://www.lipidlibrary.co.uk/topics/ms_fa_1/index.htm)

Notes:

1. This method works well for Arabidopsis leaves and also roots, although duration of the transmethylation step for the latter should be increased to 1.5 h.
2. Hexane and heptane have been used traditionally for extraction of FAMES. However, due to known long-term toxicity of hexane, one may consider using pentane, which is less toxic. Should hexane or heptane be used, care should be taken.
3. Care should be taken when applying nitrogen stream to evaporate the solvent, as a considerable amount of C14 (even C16) FAMES can be lost if the sample is heated or the nitrogen flow too vigorous.

¹⁹ Institut Jean-Pierre Bourgin, INRA-AgroParisTech, 78026 Versailles Cedex, France. Email: Martine.Miquel@versailles.inra.fr

A direct acid-catalyzed transmethylation protocol.

1. Place up to 50 mg tissue in a Teflon-lined screw capped glass tube.
2. Add 1 mL of 2.5 % H₂SO₄ (v/v) in methanol (freshly prepared).
3. Heat at 80°C for 1 h.
4. Cool to room temperature.
5. Add 500 µL of pentane followed by 1.5 mL 0.9% NaCl (w/v) to extract fatty acid methyl esters (FAME).
6. Shake vigorously and then briefly centrifuge to facilitate phase separation.
7. Transfer some of the upper phase (pentane-containing FAME) to an injection vial. Concentrate with stream of nitrogen if necessary for GC sensitivity.
8. Run GC with a flame ionization detector (FID) on a polar column such as Econo-Cap™ EC™-WAX capillary column (15 m long, 0.53 mm i. d., 1.20 µm film, Alltech Associates, Deerfield, Ill.).
9. Typical GC conditions—split or splitless mode injection, injector, and flame ionization detector temperature, 250°C; oven temperature program—160°C for 1 min, 40°C min⁻¹ to 190°C, 4°C min⁻¹ to 230°C, holding this temperature for 4 min.

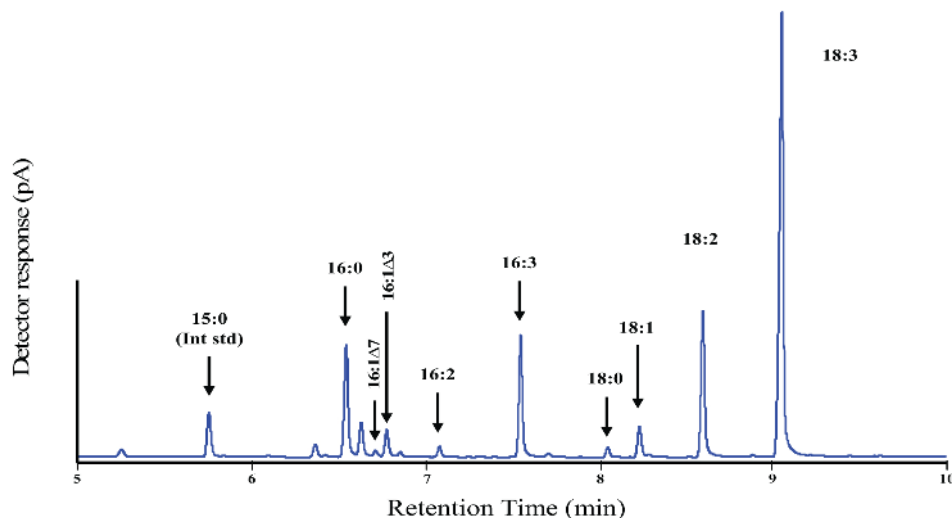

Figure 13. Separation of the Methyl Ester Derivatives of Fatty Acids From Arabidopsis Leaf.

A capillary fused silica column coated with (50% Cyanopropyl)-methylpolysiloxane (DB-23; J&W Scientific) was temperature-programmed from 140°C to 260°C at 10°C min⁻¹ with helium as carrier gas. One μ L of sample was injected in a 270°C inlet with a 30:1 split ratio. Methyl ester derivatives were detected using a FID at 270°C. (Courtesy of Dr. Imad Ajjawi, Michigan State University, Michigan)

3.3. Glycerolipid Analysis Methods

(Philip D. Bates²⁰)

Glycerolipid analysis involves separation of individual polar and neutral glycerolipid classes. Separation may be followed by quantitation of acyl groups within the class, stereospecific analysis to determine composition of acyl groups at each position of the glycerol backbone, or characterization of molecular species with specific combinations of acyl groups esterified to a single glycerol backbone.

Accurate analysis of glycerolipids requires care in lipid extraction to minimize oxidation, lipolysis, or transesterification [see Section 3.1]. Although initial separation of the extract may be performed by HPLC (Beermann et al., 2003), the ease of use and low cost of TLC have made it a dominant technique for more than 60 years. Once separated, individual lipid classes can be quantified and fatty acid composition determined by direct conversion to fatty acid methyl esters and GC (Wu et al., 1994), or the glycerolipids may be collected for other analytical methods. Many different TLC separation and analysis methods are available for lipids and have been reviewed in depth (Christie, 2003, <http://www.lipidlibrary.co.uk/>).

3.3.1. Separation of glycerolipid classes by TLC

TLC plates are typically made of glass and coated with silica gel. Differences in gel composition and binders may affect lipid migration and downstream analysis (Sowa and Subbaiah, 2004). Comigration of lipid class standards should be used for identification of unknown compounds. Commercial TLC plates can be used directly; however, sometimes it is beneficial to heat TLC plates to ~110°C to drive off any moisture, especially in areas of high humidity. The ability of TLC

plates to separate plant lipids can be enhanced by impregnating the plates with salts or compounds that will interact with the lipids. For instance, the silver ions of AgNO₃ will slow the migration of double bond-containing lipids, allowing separation of molecular species (Christie, 2003; Bates et al., 2009). To prevent oxidation of fatty acids, both spotting of samples on plates and drying of samples eluted from plates are performed under nitrogen, and 0.01% BHT may be added to samples, TLC solvents, and detection sprays.

Several reagents are available for detection of lipids on TLC plates. Lipids containing double bonds can be stained with iodine vapor by placing a TLC plate for 15 to 60 min together with iodine crystals in a TLC tank. The iodine staining is mostly reversible, but because iodine can destroy double bonds, very light staining is advised if further analysis is required. Alternatively, general lipids can be sprayed lightly with 0.005% primulin in 80% acetone and lipids visualized under UV light. This sensitive, nondestructive stain will not interfere with most downstream analyses. Other nondestructive sprays for lipid detection under UV include 0.01% Rhodamine 6G (w/v) in water and 0.1% (w/v) 2',7'-dichlorofluorescein in 95% methanol. Both solvents and sprays should be handled in a fume hood.

Figure 14 illustrates separation of the major lipid classes found in Arabidopsis and other plants on Partisil K6 silica gel 60 Å TLC plates (Whatman, Maidstone, U.K.). Neutral lipids are separated on TLC plates developed once in hexane/diethyl ether/acetic acid (70/30/1, v/v/v) (Figure 14A). Waxes and sterol esters migrate the most quickly, followed by triacylglycerols, free fatty acids, diacylglycerols, and monoacylglycerols, while polar lipids remain at the origin. For polar lipid separation, TLC plates are dipped in a solution of 0.15 M (NH₄)₂SO₄ and allowed to air dry. Just before use, the plates are heated to 110°C for at least 3 h. After lipid application, the plates are developed once or twice in acetone:toluene:H₂O (91/30/8, v/v/v) (Khan and Williams, 1977). Typical migration order of the major plant membrane lipids is as follows: total neutral lipids, monogalactosyldiacylglycerol, phosphatidylglycerol, sul-

²⁰ Institute of Biological Chemistry, Washington State University, Pullman, WA 99164. Email: phil_bates@wsu.edu

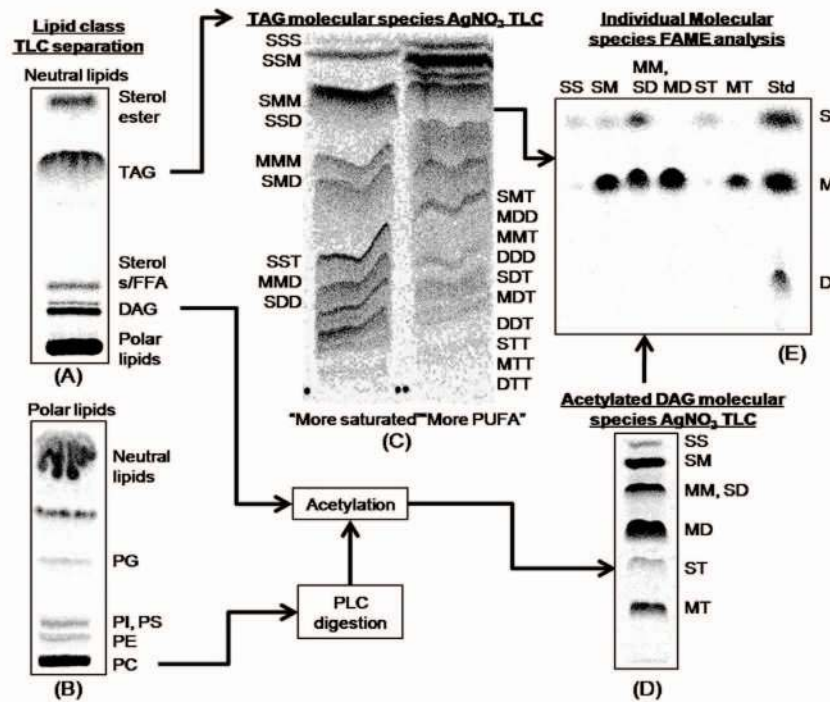

Figure 14. TLC Image Examples and Flow Chart for Analysis of Radiolabeled Glycerolipids From [^{14}C]acetate and [^{14}C]glycerol Labeled Soybean Embryos.

Examples of the major TLC systems used during analysis of radiolabeled glycerolipid classes, molecular species, and FA composition. Molecular species (e.g. SSS, SM, etc.) are represented as a combination of two or three FA, total saturates, S; monoenes (18:1), M; dienes (18:2), D; trienes (18:3), T.

(A) Neutral lipid class TLC, pictured 6 min [^{14}C]acetate labeling.

(B) Polar lipid class TLC, pictured 6 min [^{14}C]acetate labeling.

(C) TAG molecular species AgNO_3 -TLC, pictured 30 min [^{14}C]glycerol labeling.

(D) Molecular species separation of PC (after phospholipase C digestion) and DAG as 3-acetyl-1,2-diacyl-glycerols, pictured 6 min [^{14}C]acetate labeled PC.

(E) FAME AgNO_3 -TLC, pictured FAMES from different 6 min [^{14}C]acetate labeled PC molecular species separated in D. See (Bates et al., 2009) for labeling experiment details and TLC protocols.

Abbreviations: DAG, diacylglycerol; FFA, free fatty acid; PG, phosphatidylglycerol; PI, phosphatidylinositol; PE, phosphatidylethanolamine; PC, phosphatidylcholine; PLC, phospholipase C; PS, phosphatidylserine; PUFA, polyunsaturated fatty acid; TAG, triacylglycerol;

foquinovosyldiacylglycerol, digalactosyldiacylglycerol, phosphatidylinositol and phosphatidylserine, phosphatidylethanolamine, and phosphatidylcholine. See Figure 14B for separation of polar lipids after metabolic radiolabeling of soybean embryos or Härtel et al. (2000) for separation of Arabidopsis leaf lipids.

3.3.2. Stereochemical analysis of glycerolipids

The acyltransferases of glycerolipid synthesis have different specificities for acyl groups and thus produce lipids with different acyl compositions at each position of the glycerol backbone. Stereospecific phospholipase A_2 will cleave acyl groups from the *sn*-2 position of phospholipids. The free fatty acid and lyso-lipid products can be separated for analysis by TLC. Stereospecific analysis of glycolipids can be done with the TAG lipase from *Rhizopus arrhizus* that will cleave at the *sn*-1 position. There is no enzyme that differentiates the *sn*-1 and *sn*-3 positions of TAG, and thus a regiochemical analysis of *sn*-2 versus *sn*-1/3 is commonly employed with TAG lipase. Complete stereochemical analyses of TAG can be done through multistep procedures that involve partial degradation of TAG, generating a mixture of 1,2-DAG and

2,3-DAG. The mixed DAGs are either separated by chiral chromatography or are chemically converted to phospholipids for stereospecific PLA_2 digestion of *sn*-1,2 species as for natural phospholipids above. Protocols can be found in Christie (2003).

3.3.3. FAME and molecular species separations

GC and mass spectrometry are the preferred methods of measurement for lipid-derived FAME and individual lipid molecular species, respectively. For detailed coverage of molecular species analysis by mass spectrometry, see Section 3.10. However, TLC separations can be very useful in circumstances such as analysis of radiolabeled lipids from metabolic labeling experiments. For example, molecular species of triacylglycerols and acetylated diacylglycerols may be separated based on their number of double bonds by TLC on AgNO_3 -impregnated TLC plates developed with a series of chloroform/methanol mixtures (Bates et al., 2009; Figure 14C and Figure 14D). FAME may be separated based on the number of double bonds with AgNO_3 -TLC (Figure 14E) or based on both number of double bonds and fatty acid chain length with reverse phase TLC plates (Christie, 2003; Marquardt and Wilson, 1998).

3.4. Seed Oil Quantification

(Yonghua Li-Beisson²¹)

Arabidopsis stores over 35% oil in its seeds as energy and carbon reserves. A range of methods has been applied to quantify oil amount in Arabidopsis seeds (Table 2). These methods differ in sample size, sensitivity, instrument required, and information provided. Functional genetic screens have increasingly been used as a way to identify genes/proteins involved in storage oil metabolism. To facilitate mutant identification, a reliable and medium- to high-throughput oil quantification method is desirable.

²¹ Department of Plant Biology and Environmental Microbiology, CEA/CNRS/Aix-Marseille University, Cadarache, France. Email: yonghua.li@cea.fr

Arabidopsis seeds have a thin seed coat and are tiny (~20 µg per seeds). Each seed has 5 to 8 µg of fatty acids, and over 90% of these fatty acids are stored as triacylglycerols. It has been shown that total TAGs can be quantified based on fatty acid composition compared to internal standard (Y.H. Li et al., 2006). A direct whole seed transmethylation protocol is described below. It has several advantages: (1) It bypasses oil extraction; (2) it requires a GC-FID, which is found in most lipid labs, and GC-FID-based methods offer very high sensitivity for quantifying acyl chains; (3) it provides not only total TAG content but also fatty acid composition; and (4) it is suitable for medium- to high-throughput screening and can be used in functional genetic screens. A typical GC chromatogram of the FAME profile for seeds is shown in Figure 15.

Table 2. Comparison of Methods Reported for Quantifying Oil Content of Arabidopsis Seed

Method	Sample Size	Analytic Procedure	Precision	Equipment (Core)	Information Provided
Gravimetric analysis ^a	>100 mg	Destructive Time consuming	Moderate	Analytical balance	Total lipid content (TAGs, phospholipids, etc.)
NMR ^a	>50 mg	Nondestructive Short scans (<1 min)	Moderate	NMR analyzer	Total lipid content
Lipid extraction transmethylation ^a	>100 mg	Destructive Time consuming	High	GC-FID	TAG content Fatty acid composition
Whole seed transmethylation ^a	20 seeds ^b	Destructive Suitable for high-throughput screening	High	GC-FID	TAG content Fatty acid composition
Carbon/Nitrogen ratio ^a	2–4 mg seeds	Destructive Suitable for high-throughput screening	High	Element analyzer	Relative value
TLC ^b	10 mg	Destructive	Low	TLC	TAG content
High temperature GC ^b		Destructive	High	GC-FID	TAG content TAG molecular species
LC-MS/MS (Burgal et al., 2008)	50 seeds	Destructive	High	LC-MS/MS	TAG content TAG molecular species

TAG = triacylglycerol; NMR = nuclear magnetic resonance; GC-FID = gas chromatography flame ionization detector; TLC = thin-layer chromatography; GC = gas chromatography; LC-MS/MS = liquid chromatography tandem mass spectrometry.

^aFor references, please refer to Y.H. Li et al., 2006; new methods available after this publication will be added here.

^bPlease refer to Christie's website <http://www.lipidlibrary.co.uk/> for more details.

A whole seed acid-catalyzed transmethylation protocol.

- Count 20 seeds and add them to a Teflon-lined screw-capped glass tube.
- Add 1 mL 5% H₂SO₄ (v/v) in methanol (freshly prepared), 50 µg BHT, 20 µg C17:0 TAG (triheptadecanoin) as internal standard, and 300 µL of toluene as cosolvent.
- Vortex vigorously for 30 s.
- Heat at 85° to 90°C for 1.5 h.
- Cool to room temperature.
- Add 1.5 mL 0.9% NaCl (w/v) and add 1 mL of hexane to extract FAME.
- Mix well (vortex) and then centrifuge briefly to facilitate phase separation.
- Transfer the upper organic phase (hexane-containing FAME) to a new tube.
- Evaporate the extracts under a stream of nitrogen.
- Redissolve in 50 µL of hexane (vortex well).
- Run GC with a flame ionization detector on a polar column—like DB23 (30 m by 0.25 mm i.d., 0.25 µm film; J&W Scientific, Folsom, CA).
- The GC conditions were as follows: split mode injection (1:40); injector and flame ionization detector temperature, 260°C; oven temperature program 150°C for 3 min, then increasing at 10°C min⁻¹ to 240°C and holding this temperature for 5 min.

Notes:

1. This method works well for Arabidopsis seeds because almost all of the fatty acids are esterified to form TAGs, and the tiny seeds can be extracted without first grinding. For larger seeds (such as seeds of *Brassica napus*) or in cases where significant amounts of fatty acids are stored in other forms, TAGs might need to be isolated.
2. Before applying this method to other systems, total oil content and fatty acid distribution need to be verified by other methods.
3. Often researchers use as little as 1 or 2 seeds for the analysis. From our experience, this is sufficient to screen a large number of lines aiming to find changes in fatty acid profile or production of an unusual fatty acid. For quantification purpose, this usually gives very low value. Variations are likely due to seed-to-seed variation and inaccuracy in seed weight determinations.
4. Toluene is added as a cosolvent since neutral lipids such as TAGs and wax esters do not dissolve well in methanol alone.
5. Care should be taken when applying nitrogen stream to evaporate the solvent as a considerable amount of C14 (even C16) FAME can be lost if the nitrogen flow is too vigorous.
6. This method gives information on FAME content and composition; therefore, when reporting oil content, calculation is required: percent oil by weight = $100 \times (4 \text{ total mol FAME}/3) + \text{total g FAME}/\text{g tissue}$, where 4 is the Mr. difference between TAG and three moles of FAME.

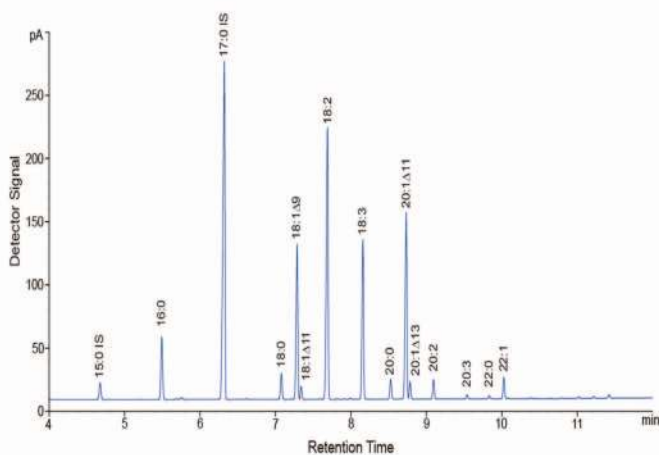

Figure 15. GC-FID Analysis of Fatty Acid Methyl Esters Derived From Neutral Lipids Isolated From Arabidopsis Col-0 Seed.

Neutral lipids were isolated from wild type Col-0 seed and transmethylated and the subsequent fatty acid methyl esters separated on a J+W DB-23 (50% cyanopropyl) methylpolysiloxane 30 m column and detected using a flame ionization detector. The column temperature was initially held at 150 °C for 3 min, then increased to 240 °C at rate of 10 °C min⁻¹, and then held at 240 °C for 10 min. Tripentadecanoin (15:0) and triheptadecanoin (C17:0) were used as seed lipid extraction and transmethylation internal standards, respectively. IS = internal standard (Courtesy of Dr. Timothy Durrett, Michigan State University)

3.5. TAG Analysis by Liquid Chromatography Mass Spectrometry

(Tony Larson²²)

The yield and fatty acid composition of seed triacylglycerols reflects the combined activities of fatty acid synthesis, desaturation, elongation, and transferase reactions, the latter of which are reversible. TAG analysis is therefore an important tool in evaluating how the process of acyl chain assembly into storage lipids is controlled, which may be especially important in metabolically engineered oil synthesis (Burgal et al., 2008). Three components of TAG analysis are potentially useful measures: (1) absolute quantity (i.e., yield), (2) relative TAG molecular species distribution, and (3) acyl position-specific information for a given TAG species. In the outlined method, absolute quantification is difficult as MS-based methods return biased responses depending on acyl chain length and degree of unsaturation (X.W. Li and Evans, 2005); instead, GC-FID-based FAME analyses of TAG derivatives is recommended. However, seed oil TAGs from Arabidopsis, comprising mixed acyl chains in the narrow 18–20 carbon number and 1–3 double bond range, generally provide a proxy of FAME-calculated yield within an error of ±10%. Less than half of the 80 to 120 resolvable *Arabidopsis* TAG molecular species are chromatographically separated; the remainder is resolved in the MS dimension by nominal mass. Constituent acyl species are then empirically assigned by reconciling the MS2 neutral-loss DAG fragments with the parent ammoniated molecular ion. In some cases, *sn*-2 position can be assigned due to the theoretically favorable loss of acyl chains from *sn*-1,3 positions (represented as more intense *sn*-1,2 and *sn*-2,3 DAG fragments in MS2 spectra). However, full positional assignments are not possible with MS techniques alone; prior stereospecific digestion techniques are required and are not covered here.

TAGs are extracted by grinding 20 to 200 Arabidopsis seeds in a 1.5 mL microfuge tube with 10 µL 1,1,1¹³C-triolein (0.5–5 mg mL⁻¹ in chloroform; internal standard) + 400 µL hexane/isopropanol (3:2, v/v), snap-freezing in liquid nitrogen, incubating at 4 °C for 60 min, and centrifuging at 14,000 RPM for 5 min, and the supernatant is transferred to a fresh tube. The pellet is washed 3 times with 100 µL hexane:isopropanol and the supernatants pooled, combined with 350 µL 6.7% sodium sulphate (w/v), vortexed and centrifuged for 30 s at 14,000 RPM, and the supernatant dried *in vacuo* in an HPLC vial. The lipid residue is reconstituted in 100 µL chloroform and 10 µL injected on an LCQ-MS (Thermo Finnigan) equipped with a C30 HPLC column (YMC, 250 x 4.6 mm, 5 µm particle size) held at 30 °C. A ternary separation gradient is used at 1 mL min⁻¹ with solvents containing 0.2% formic acid (v/v): Solvent A is 20 mM ammonium formate in 80% (v/v) methanol, B is methanol, and C is tetrahydrofuran. Gradient is 0 to 5 min isocratic 5% A, 95% B; 5 to 45 min to 5% A, 35% B, 60% C, then isocratic 45–50 min; 10 min re-equilibration time between injections. The column eluent fed unsplit into an atmospheric pressure chemical ionization (APCI) source: vaporizer temperature 350 °C; sheath gas (N₂) flow 60 units, aux gas flow 60 units; source current 5

²² Centre for Novel Agricultural Products, Department of Biology, University of York, Heslington, York, YO10 5YW, UK. Email: tr11@york.ac.uk

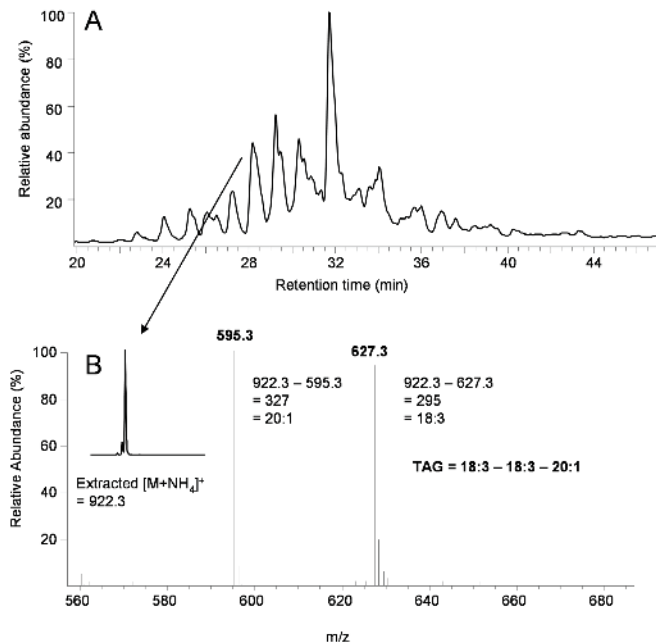

Figure 16. TAG Profile of Col-0 Dry Seed.

The total ion current (A) is used for the data-dependent selection of parent ions (inset in (B)), which are subjected to MS² fragmentation analysis. Up to three daughter diacylglycerol (DAG) fragments are generated per triacylglycerol (TAG); in this example, two are generated because there are only two unique constituent fatty acids. The neutral losses for the observed DAG fragments (after correction for adducts) can be used for a constrained calculation of fatty acid identity (B). The correct stoichiometric combination of these fatty acids to give the parent ion is used to calculate the TAG molecular formula.

μA; capillary voltage 32 V; capillary temperature 150°C. Full-scan MS data are collected over the range 450 to 1500 m/z, and MS² fragmentation data are collected in data-dependent mode at 60% normalized collision energy and an isolation width of 4 m/z.

A representative total ion current trace for Col-0 seed extract is shown in Figure 16A, with the identification process shown for a dominant TAG species outlined in Figure 16B.

3.6. Acyl-CoA Analysis by High-Performance Liquid Chromatography (Tony Larson²³)

Long-chain (C16–18) and very long chain acyl-CoAs (C20–C24) are cytosolic intermediates for glycerolipid synthesis, and their accumulation would suggest a bottleneck or limiting step. Additionally, these acyl-CoAs (and also short-, medium-, and branched-chain variants) are measurable intermediates dur-

ing peroxisomal β-oxidation in all tissues, especially those tissues undergoing rapid catabolism (e.g., seedlings, senescing leaves). CoA species also include the rapidly turned-over ubiquitous intermediates, acetyl and malonyl CoAs, which, although occasionally seen, are troublesome to recover quantitatively from extracts using the method described below.

The method given is an HPLC-reversed-phase-based separation with an integral washing step to remove interfering components. It is based on established techniques for acyl-CoA extraction from biological samples (Mancha et al., 1975), with extraction optimized to maximize recovery from plant tissues and detection specificity and sensitivity increased to cope with the low inherent concentration of acyl-CoAs in complex plant tissue matrices (Larson and Graham, 2001). Sample extraction combines prepurification with conversion to stable *etheno* fluorescent derivatives that can be readily separated by HPLC and sensitively and quantitatively detected. The acyl chain moiety of novel acyl-CoAs can be structurally determined in pre-concentrated extracts using liquid chromatography tandem mass spectrometry (LC-MS/MS) techniques (Ishizaki et al., 2005). Acyl-CoA standards for verification of unknowns can be purchased or synthesized using enzymatic techniques for long or very long chains (Taylor et al., 1990) or chemical synthesis (Kawaguchi et al., 1981) for short or medium chains.

Fresh or frozen tissue samples (2–20 mg) are transferred to a microfuge tube and internal standards (10 μL each of 0.2 μM isovaleroyl and heptadecanoyl CoAs) added, followed by 200 μL freshly made ice-cold extraction buffer (200:200:5:8 [v/v] isopropanol:50mM phosphate buffer pH 7.2: acetic acid: 50 mg mL⁻¹ BSA). It is important not to exceed 20 mg plant material, or recoveries will be greatly compromised. The samples are ground and lipids removed by 3 x 200 μL washes with water-saturated petroleum ether. Saturated ammonium sulphate (5 μL) is added to each sample, followed by 600 μL 2:1 [v/v] methanol:chloroform. Samples are vortexed and left at room temperature (RT) to precipitate for 20 min before centrifuging at 14,000 RPM for 2 min. The supernatant is transferred to HPLC vials and dried *in vacuo*. Derivatizing reagent (0.5 M chloroacetaldehyde, 0.5% [v/v] SDS, 150 mM citrate buffer pH 4.0; stored at RT for up to 3 months) is added to each vial (40 μL), and the sealed vials are heated at 85°C for 20 min. The derivatized samples (stable for at least a week at RT) are injected (20 μL) for HPLC analysis. The HPLC is equipped with a Luna C18(2) column (Phenomenex, 150 x 2.0 mm, 5 μm particle size) held at 40°C. A quaternary separation gradient is used with solvents: A, 1% acetic acid; B, 90% acetonitrile 1% acetic acid; C, 0.25% triethylamine; D, 90% acetonitrile. The run gradient is as follows: 0–5 min, 0.75 mL min⁻¹ A:B (90:10) – A:B (20:80); 5–5.1 min, A:B (20:80) – A:C(20:80); 5.1–7 min, A:C (20:80) – C:D(97:3); 7–10 min, C:D(97:3) – C:D(95:5); 10–10.1 min, flow rate reduced to 0.2 mL min⁻¹; 10.1–50 min, C:D (95:5) – C:D (55:45); 50–50.1 min, C:D(55:45) – D; 50.1–52 min, D; 52–52.1 min, flow rate increased to 0.2 mL min⁻¹; 52.1–57 min D; 57–57.1 min, D – A:B (90:10); 57.1–60 min, A:B (10:90). The eluent is sent to a fluorescent detector with excitation set to 230 nm and emission to 420 nm. Peak area is directly proportional to molar quantities, and concentrations can be determined by reference to the internal standards. An example trace for Col-0 seedling extracts is shown in Figure 17.

²³ Centre for Novel Agricultural Products, Department of Biology, University of York, Heslington, York, YO10 5YW, UK. Email: trl1@york.ac.uk

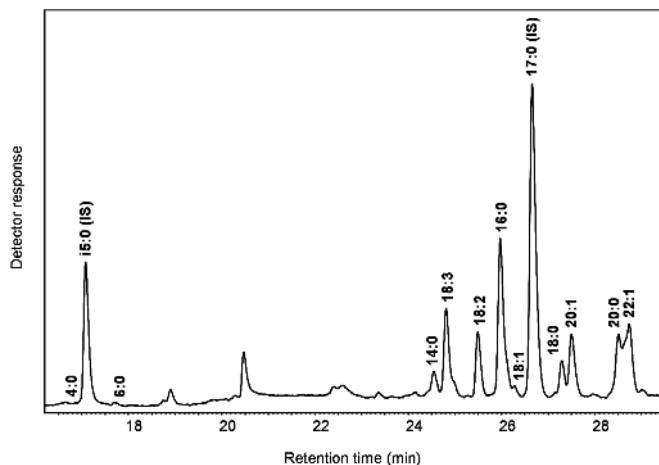

Figure 17. High-Performance Liquid Chromatography Trace of Acyl-CoA From a Col-0 Seedling Extract.

The extract was made as described from 30 seedlings (grown on media plates) harvested at 5 days after imbibition. This developmental stage encompasses both rapid storage lipid breakdown and de novo lipid biosynthesis associated with seedling establishment. Peak areas and heights are directly proportional to the absolute amounts of the indicated acyl-CoAs. IS = internal standard.

3.7. Sphingolipid Analyses

(Jonathan E. Markham²⁴)

Sphingolipids have unique chemistry that has both advantages and drawbacks for the lipid biochemist. Due to their unique long-chain base component, total sphingolipid content can be quantified from intact, dry tissue by hydrolysis, derivitization, HPLC separation, and fluorescence detection (Markham et al., 2006). A similar technique can be used to release the 2-hydroxy fatty acids (which are almost exclusively found in sphingolipids) to obtain information about the sphingolipid LCB and fatty acid content, although information about which LCBs are found in different classes of sphingolipid and with what fatty acids is not obtained.

Analysis of intact lipids is more challenging due to the highly glycosylated nature of the complex sphingolipids, which means they are largely insoluble in pure solvent and hence not easily extracted by the usual methods to extract lipids (Markham et al., 2006). For this reason, many analyses of sphingolipids from plants have focused on simpler sphingolipids such as ceramide or glucosylceramide (Ohnishi and Fujino, 1981; Imai et al., 1995, 2000). Analysis of complex glycosphingolipids requires more extensive purification and techniques of carbohydrate analysis to uncover the absolute structure of the complex headgroup (Kaul and Lester, 1975; Markham et al., 2006). Intact sphingolipids from Arabidopsis can be extracted and quantified by LC-MS/MS, albeit with some limitations (Markham and Jaworski, 2007),

²⁴ Donald Danforth Plant Science Center, St. Louis, MO 63132. Email: jmarkham@danforthcenter.org

but nonetheless this remains the only viable option for extensive analysis of intact sphingolipids from Arabidopsis.

This protocol is very simple and a quick way to check for changes in sphingolipid metabolism in Arabidopsis due to genetic mutation or environmental challenge. It is robust, very sensitive, quantitative, and free from most artifacts generated by other hydrolysis conditions. In the absence of a HPLC fitted with a fluorimeter, LCBs can be analyzed by making dinitrophenyl derivatives of the LCBs and analyzing by HPLC with a UV detector (Sperling et al., 1998), converting the LCBs to aldehydes and analysis by GC-FID/GC-MS (Bonaventure et al., 2003), or making N-acetyl, *O*-trimethylsilane-derivatives and also detecting by GC-FID/GC-MS.

Protocol: Hydrolysis and quantification of LCBs from sphingolipids of Arabidopsis.

Materials: Internal standard D-erythro-C20-sphingosine (d20:1, Matreya) dissolved in methanol at 0.1 nmol μL^{-1} ; 10% Ba(OH)₂ (dissolve 10 g of Ba(OH)₂·8H₂O [Sigma] in 96 mL of water with heating and stirring, warm before use); dioxane (HPLC grade), 2% Ammonium sulphate, OPA reagent (dissolve 5mg of O-phthalaldehyde in 100 μL of methanol, add 5 μL of mercaptoethanol, 6.6 mL of water and 3.3 mL of 3% Boric acid pH 10.5); OPA diluent (combine 10 mL of water, 50 μL of 1M KHPO₄ pH7 and 60 mL of methanol).

1. Freeze dry sample. Grind tissue to powder.
 - a. Alternatively, dry a lipid extract under nitrogen and proceed to step 3.
2. Weigh approximately 10 mg of tissue into a screw-cap glass tube and record weight.
3. Add 10 μL of d20:1 standard, 1 mL of dioxane, and 1 mL of 10% Ba(OH)₂.
4. Screw cap onto tube as tightly as possible.
5. Place tube in 110°C heat block. Hydrolysis reaction is essentially complete after 8 h.
6. Add 2 mL 2% ammonium sulfate and 2 mL diethylether. Vortex.
7. Spin at 500 g for 10 min. Remove upper phase to a new tube and dry under nitrogen.
8. Add 100 μL of methanol and 50 μL of OPA reagent. Allow to derivatize at room temperature for 20 min.
9. Add 350 μL of OPA diluent.
10. Spin at 500 g for 10 min. Transfer sample to labeled autosampler vial and seal.
11. Run on HPLC as soon as possible. Store samples in dark at 4°C if there is any delay.
12. Quantify the resulting peaks by comparison to the internal standard.

Note: HPLC conditions: Column—Agilent XDB-C18 4.6 x 250mm with guard column; Buffer A 5 mM K₂HPO₄ pH 7; Buffer B Methanol Flow Rate 1.5 mL min⁻¹

HPLC gradient:

Time	Percent B	Duration
0 min	80%	7 min
7 min	90%	8 min
15 min	90%	10 min
25 min	100%	5 min
30 min	100%	3 min
33 min	80%	1 min
34 min	80%	2 min

Fluorescence detector: Excitation 340 nm Detection 455 nm

Notes:

The major peak in Arabidopsis is t18:1^{ABE} that elutes around 17–18 min. Artifacts generated by the hydrolysis include the partial hydrolysis of the glycosidic bond resulting in Glc-t18:1 peaks and the formation of 1,4-*anhydro* derivatives from the phosphorylated sphingolipids.

3.8. Lipid Polyester Analysis

(Fred Beisson²⁵)

A protocol for the routine quantitative analysis of ester-linked monomers of Arabidopsis cutin and suberin is described below. Major steps are delipidation of tissues, chemical depolymerization of the residue, and extraction of released monomers in an organic phase and analysis of monomers by gas chromatography after derivatization of their hydroxyl groups. Various protocols using different delipidation, depolymerization, monomer extraction, and derivatization methods have been described (Bonaventure et al., 2004b; Franke et al., 2005; Molina et al., 2006). The protocol reported here is mostly adapted from the Bonaventure and Molina references. It can be performed on all Arabidopsis organs and uses minimal amounts of biological material and solvent.

²⁵ Department of Plant Biology and Environmental Microbiology, CEA/CNRS/Aix-Marseille University, Cadarache, France. Email: frederic.beisson@cea.fr

I. Delipidation of tissues.

All solvent extraction steps include 0.01% (w/v) butylated hydroxytoluene (BHT) added from a 5% (w/v) stock solution in methanol. Unless indicated otherwise, each extraction is performed at room temperature by vortexing for 1 h (use a multitube vortexer, glass tubes with Teflon-lined screw caps, and 4 to 10 mL of solvent).

1. Fill preweighed tubes with isopropanol and heat up (85°C). Immerse Arabidopsis tissues in boiling isopropanol (10 min at 85°C). Leaves need to be cut in small pieces, and stems need to be cut in 1–2 cm bits and

(Continued)

I. Delipidation of tissues. (continued)

longitudinally in two halves. Examples of amounts of starting material per tube: 20–100 mg mature seeds, 100–300 mg fresh weight (fw) leaves or stems, 10–20 flowers, 50–200 mg fw secondary roots.

2. Cool down and extract by vortexing for 1 h. Alternatively, shake on a rocking agitator or a rotating wheel for at least 2 h and up to overnight.
3. Discard solvent. Most chlorophyll should have been extracted at this step. Extract again with isopropanol.
4. Discard solvent and extract with chloroform/methanol (2:1, v/v).
5. Discard solvent and extract with chloroform/methanol (1:2, v/v).
6. Discard solvent and extract with methanol.
7. Discard solvent and dry under a gentle stream of nitrogen gas. Dry in vacuum desiccator under reduced pressure until constant weight is achieved (at least 24 h). It is very important to remove as much water as possible.

II. Depolymerization of residue: Base- or acid-catalyzed transmethylation.

Weigh tubes to determine amount of dry residue after delipidation (there should be 10–50 mg depending on tissue). Transmethylation can be done by either acid or base catalysis.

Base catalysis

1. In each tube, add 2 ml of freshly made reaction medium and 5–10 µg of methyl heptadecanoate and ω-pentadecalactone as internal standards. To make 20 mL of reaction medium: In 12 mL methanol, add 3 mL methyl acetate and 5 ml 25% sodium methoxide in methanol (Sigma).
2. Heat the mixture at 60°C for 2 h.
3. Cool, add 4 ml dichloromethane, 0.5 mL glacial acetic acid to neutralize to pH 4–5, and 1 mL 0.9% NaCl (w/v) Tris 100 mM pH 8.0. Shake well and phase separate by centrifugation for 2 min at 1500 g. Check pH of upper phase with pH indicator paper.
4. Collect the lower organic phase, wash it with 2 mL 0.9% NaCl (w/v), and dry over anhydrous sodium sulfate. Evaporate to dryness under a gentle stream of nitrogen gas (heat up tubes at 35°C max).

Acid catalysis

1. In each tube, add 2 mL freshly made reaction medium, 0.2 mL toluene as a cosolvent, and 5–10 µg of methyl heptadecanoate and ω-pentadecalactone as internal standards. To make 20 mL of reaction medium: In 19 mL methanol, add 1 mL concentrated sulfuric acid. Alternatively, 3N methanolic hydrochloride can be used.

(Continued)

II. Depolymerization of residue. (continued)

- Heat the mixture at 80°C for 2 h.
- Cool. Add 4 mL dichloromethane and 1 mL of buffer 0.9% NaCl (w/v) Tris 100 mM pH 8.0. Shake well and phase separate by centrifugation for 2 min at 1500 g.
- Collect the lower organic phase, wash it with 2 mL of buffer, and dry it over anhydrous sodium sulphate. Evaporate to dryness under a gentle stream of nitrogen gas (heat up tubes at 35°C max).

III. Derivatization of monomers and GC-(MS) analysis.

- Hydroxyl residues can be acetylated or silylated.
Acetylation: Add 100 μL of anhydrous pyridine and 100 μL of acetic anhydride. Heat up at 60°C for 2 h. Evaporate solvent under nitrogen stream.
Silylation: Add 100 μL of anhydrous pyridine and 100 μL of BSTFA [N,O-bis(trimethylsilyl)-trifluoroacetamide]. Heat up at 110°C for 10 min.
- Redissolve monomers in 30–200 μL of heptane:toluene (1:1, v/v) and run samples on GC-(MS). GC-FID conditions: HP-5 capillary column (30 m, 0.32 mm ID, 0.25 μm film thickness) with helium carrier gas at 2 ml min^{-1} and oven temperature programmed from 140°C to 310°C at 3°C min^{-1} and then held for 10 min at 310°C. Samples are injected in split mode (30:1 ratio, 310°C injector temperature) and peaks quantified on the basis of their FID ion current. For GC-MS, the same column is used with He carrier gas at 2 mL min^{-1} and oven temperature programmed from 110°C to 300°C at 10°C min^{-1} . Splitless injection is used and the mass spectrometer run in scan mode over 40–500 amu (electron impact ionization) with peaks quantified on the basis of their total ion current.

Additional tips and cautionary notes

- Grinding tissues.** For seeds, it is necessary to grind material in liquid nitrogen with mortar and pestle before solvent extractions (Molina et al., 2006). To ensure optimal delipidation of seeds, additional extraction/centrifugation steps should be performed after the final methanol step: methanol (30 min), water (30 min), 2 M NaCl (1 h), water (30 min), methanol (30 min), chloroform/methanol 1:2 (v/v) (1h to overnight), chloroform/methanol 2:1 (v/v) (1h to overnight), and methanol (1h). To improve delipidation steps, tissues such as stems and leaves can also be ground using a Polytron (following immersion in hot isopropanol and cooling down). Recovery of ground material after each extraction can be performed using centrifugation or filtration through several layers of filter paper. One will have to be careful to minimize loss of material at each extraction step, however. Grinding and centrifugation or filtration is thus easier for experiments aiming at quantifying polyester monomer on a dry residue weight basis than those requiring quantification on a leaf/stem surface area basis.

- Quantification.** To express polyester loads as micrograms per unit surface area, scan stems and leaves after harvest. To express polyester loads in ng per seed, weigh 200 seeds.
- Depolymerization.** The acid-catalyzed depolymerization procedure is a bit faster because it does not require acidification prior to monomer extraction. One has to be aware that acid catalysis will release substantial amounts of 2-OH fatty acids that are not O-acylated to polyesters and might come from residual sphingolipids (Molina et al., 2006).
- Monomer extraction.** To extract fatty acid methyl esters, it is important to use dichloromethane (and not hexane) because polyhydroxy fatty acids are very poorly extracted in hexane.
- Derivatization.** Acetylation is less sensitive to water than silylation. However, it is recommended to perform both methods because a few monomers that do not separate well with one derivatization will separate better with the other one. Ideally, this should be done on two samples of the same monomer extract. Alternatively, the acetyl or trimethylsilyl group from an already derivatized sample can be derivatized again with the other agent by doing a short acid-catalyzed transmethylation (5 min), re-extracting, drying, and derivatizing.
- Drying organic phase.** The drying organic phase can also be achieved by using 2,2-dimethoxypropane (2,2 DMP). This is done by reducing the volume of the organic phase to ~1 mL by evaporating with N_2 , adding 1.5–2 volumes of 2,2 Dimethoxypropane (DMP), incubating at 50–60°C for ~5–15 min, and evaporating under nitrogen gas to complete dryness (Kosma et al., 2009).

3.9. Analysis of Cuticular Waxes(Owen Rowland²⁶)

Cuticular wax is the mixture of compounds removed from plant surfaces by brief immersion in an organic solvent of low polarity. The resulting extract (wax) is typically a mixture of saturated hydrocarbon backbones that may carry an oxygen-containing functional group (e.g., mixture of alkanes, aldehydes, primary and secondary alcohols, ketones, and alkyl esters). Each lipid class is present as a homologous series (e.g., C24:0, C26:0, C28:0, and C30:0 primary alcohols), or one chain length may predominate. In addition to straight-chain aliphatics, cuticular wax may also contain secondary metabolites such as triterpenoids and phenylpropanoids. A detailed discussion of the composition of plant cuticular waxes and methods used for chemical analysis can be found in Jetter et al. (2006).

3.9.1. Wax extraction

After 4 to 7 weeks of plant growth, aerial organs (e.g., 5 cm length of stem or 3–4 rosette leaves) are submerged twice for 30 s each in chloroform at room temperature. Fresh, healthy tissue samples should be used that are free of surface lesions to prevent contamination with internal lipids. A volume required to cover the tissues completely is sufficient. A 13 x 100 mm glass tube holding 10 mL

²⁶ Department of Biology and Institute of Biochemistry, Carleton University, Ottawa, ON K1S 5B6, Canada. Email: owen_rowland@carleton.ca

of chloroform is convenient for dipping stems. *n*-Hexane can also be used as the solvent for extraction, but it has a very low polarity, and larger volumes may be required to exhaustively extract the more polar wax constituents. It is important that all vessels are prerinsed thoroughly with solvent to prevent contamination of samples. An internal standard to determine wax quantities is added immediately before or after dipping of organs in solvent. In each tube, 1 μg of *n*-Tetracosane (C₂₄ alkane) is typically added as the internal standard because it is chemically similar to the common wax constituents but runs at a distinct retention time. The samples are then completely evaporated under a gentle stream of nitrogen and derivatized with bis-*N,O*-(trimethylsilyl)trifluoroacetamide (BSTFA) to transform all hydroxyl- and carboxyl-containing compounds into the corresponding trimethylsilyl derivatives. Derivatization conditions vary, but heating samples resuspended in 50 μL of BSTFA with 1% trimethylchlorosilane (available in 1 mL ampules from Pierce or Sigma-Aldrich) at 80°C for 60 min or 10 μL of BSTFA mixed with 10 μL of pyridine at 70°C for 60 min are typical (Rowland et al., 2006; Greer et al., 2007).

3.9.2. Gas chromatography

Derivatized samples are injected onto a capillary GC column with helium or hydrogen as carrier gas. A typical column for wax analysis: 15-30 meter, 0.32 mm i.d., $df = 1 \mu\text{m}$ HP-1 column (Agilent, or equivalent column from another supplier). A typical GC method: oven temperature set at 50°C for 2 min, raised by 40°C min^{-1} to 200°C, held for 2 min at 200°C, raised by 3°C min^{-1} to 320°C, and held for 30 min at 320°C (Wen and Jetter, 2009). After separation by GC, quantitative analysis of individual wax components is usually done with a FID, as it is highly sensitive and has a broad range of proportionality. Absolute values in units of wax mass per surface area are determined by comparison with the known internal standard and measured surface areas. The surface areas of leaves can be conveniently measured using microscope imaging software (e.g., Zeiss Axiovision) and stem surface areas either by microscope imaging or by using a caliper. Values are sometimes reported as units of wax mass per dry or fresh tissue weight, but surface area is more typical and generally preferred. Identification of individual wax components is done by GC-MS in comparison with published MS libraries or authentic standards (many wax constituents are represented in MS libraries).

3.9.3. Thin layer chromatography

TLC is a convenient and rapid way to analyze general alterations of wax compound classes between WT, mutant, and transgenic plants (Greer et al., 2007). Total wax mixtures, extracted as above, of approximately 2 mg are readily separated on silica gel with a mobile phase of CHCl_3 :ethanol 99:1. The separated fractions are sprayed with 0.01% primuline in acetone:H₂O (4:1) and then visualized under UV light. Individual compound classes can then be scraped from the TLC plate, eluted with CHCl_3 , filtered, concentrated in a stream of N₂, and then analyzed by GC-MS to identify all homologues and/or isomers of, for example, alkyl esters, secondary alcohols, and ketones (Rowland et al., 2006; Wen and Jetter, 2009).

3.10. Lipidomics

(Ruth Welti²⁷)

Lipidomics typically describes the use of electrospray ionization (ESI) triple quadrupole mass spectrometry (MS/MS) to profile lipid molecular species. Quantitative information on numerous individual lipid species is acquired directly from organic extracts [see Section 3.1] of plant material, typically without chemical modification. Lipidomics is rapid in comparison to “traditional” lipid analysis and requires relatively small amounts of material (i.e., 0.1 mg of leaf dry weight). Comparison of the lipid profiles of WT plants with those of plants that have been subjected to forward- or reverse-genetic manipulation, in parallel with developmental and physiological phenotyping, can aid in characterization of the roles of the manipulated genes and enzymes (e.g., Welti et al., 2002; Nandi et al., 2003; Cruz-Ramírez, 2006; Devaiah et al., 2006; M.Y. Li et al., 2006b; Welti et al., 2007; Chen et al., 2008; W. Li et al., 2008; Maeda et al., 2008). Association of lipid and genetic alterations can provide clues as to the physiological substrates and products of the altered gene products (enzymes; e.g., Welti et al., 2002).

Lipid extracts can be introduced directly to a mass spectrometer (direct-infusion ESI-MS/MS) or through a liquid chromatography column (LC-MS/MS). Thus far, phospholipids and galactolipids in *Arabidopsis* have been analyzed primarily by direct-infusion ESI-MS/MS, sphingolipids [see Section 3.7] and acyl-CoAs [see Section 3.6] have been analyzed primarily by LC ESI-MS/MS (Larson and Graham, 2001; Markham and Jaworski, 2007), and triacylglycerols [see Section 3.5] have been analyzed by several mass-spectrometry based approaches. Direct-infusion ESI-MS/MS for analysis of complex lipids is described in this section.

The direct-infusion ESI-MS/MS approach most applied to plant polar lipids (Welti and Wang, 2004) utilizes a series of “precursor” and “neutral loss” scans (based on Brügger et al., 1997). This method takes advantage of the formation of common fragments from related complex lipids upon collision-induced dissociation (CID) in a triple quadrupole mass spectrometer. Among polar lipids, the CID fragment is typically a head group fragment common to all members of a lipid class. For example, phosphatidylcholine molecular species, which vary in fatty acid composition, produce a common phosphocholine fragment. If the common fragment is charged, a scan for the precursors of the fragment (a precursor scan) yields a spectrum (plot of signal vs. m/z or mass/charge ratio, where z is typically = 1) in which there are signals at m/z corresponding to the masses of intact lipid molecular species ions containing the fragment (Welti and Wang, 2004). If the common fragment is uncharged, then a neutral loss scan provides the spectrum of the molecular species that contain the fragment. A complete lipid profile is obtained by sequentially carrying out characteristic precursor and neutral loss scans for each lipid group or class. Essentially, these scans allow one to look at the molecular species within one class or group of lipids at a time, while the extract is continuously infused into the mass spectrometer. Scans for analysis of many complex plant lipid classes are shown in Table 3.

²⁷ Kansas Lipidomics Research Center, Division of Biology, Kansas State University, Manhattan, KS 66506. Email: welti@ksu.edu

Table 3. Precursor and neutral loss scans utilizing characteristic fragments generated by electrospray ionization for analysis of polar complex lipids from Arabidopsis

Lipids Analyzed	Polarity	Ion Analyzed	Scan Mode	References
Phospholipids				
phosphatidylcholines	+	[M + H] ⁺	Precursors of <i>m/z</i> 184	Brügger et al., 1997
phosphatidylethanolamines	+	[M + H] ⁺	Neutral loss of 141	Brügger et al., 1997
phosphatidylserines	+	[M + H] ⁺	Neutral loss of 185	Brügger et al., 1997
phosphatidylglycerols	+	[M + NH ₄] ⁺	Neutral loss of 189	Taguchi et al., 2005
phosphatidylinositols	+	[M + NH ₄] ⁺	Neutral loss of 277	Taguchi et al., 2005
phosphatidic acids	+	[M + NH ₄] ⁺	Neutral loss of 115	
Sphingolipids				
glycosylinositolphosphoceramides	+	[M + NH] ⁺	Neutral loss of 615 or 179	
hexosylceramides	+	[M + H] ⁺	Neutral loss of 162	
Galactolipids				
sulfoquinovosyldiacylglycerols	-	[M - H] ⁻	Precursors of <i>m/z</i> 225	Gage et al., 1992; Welti et al., 2003
monogalactosyldiacylglycerols	+	[M + NH ₄] ⁺	Neutral loss of 179	Moreau et al., 2008
digalactosyldiacylglycerols	+	[M + NH ₄] ⁺	Neutral loss of 341	Moreau et al., 2008
trigalactosyldiacylglycerols	+	[M + NH ₄] ⁺	Neutral loss of 503	Moreau et al., 2008
tetragalactosyldiacylglycerols	+	[M + NH ₄] ⁺	Neutral loss of 665	

These scans are recommended for analysis of lipids in chloroform:methanol:300 mM ammonium acetate in water (300:665:35, v/v/v).

The precursor and neutral loss scans thus provide, for each lipid molecular species, the mass and signal of the intact ion, along with the mass of one molecular fragment that allows the lipid to be classified into a class or group. Given the classification, the mass can be interpreted as the total number of carbons and double bonds in the component acyl (or sphingosine/fatty amide) chains. To obtain more complete characterization of the complex lipid molecule, further analysis, such as mass spectral product ion analysis to identify individual fatty acyl components, can be performed. Devaiah et al. (2006) utilized product ion analysis to characterize many Arabidopsis glycerolipid molecular species in terms of fatty acyl composition.

For each detected lipid molecular species, the signal size allows quantification. To achieve accurate quantification by the direct-infusion ESI-MS/MS approach, a large number of internal standard compounds, optimally at least two non-naturally-occurring compounds for each class or group, are required (e.g., Welti et al., 2002; Devaiah et al., 2006). Alternatively, relative quantification among samples can be achieved by comparing mass spectral responses to an arbitrary standard compound detected with the same polarity (i.e., positive or negative mode) and scanning mode (i.e., precursor or neutral loss scanning) as the lipids of interest (e.g., detection of oxylipin-containing complex lipids in Maeda et al., 2008).

Challenges remaining in lipidomics include:

1. Standardizing lipidomics methodology and making the technology widely accessible.
2. Establishment of analyses for additional groups of lipids.

3. Development of a standardized and available data processing system for interpreting mass spectral data to produce lipid profiles.
4. Development of a web-accessible lipid profile database that facilitates integration with genomic, gene expression, proteomic, and other metabolomic data.

3.11. Strategies for Imaging in Plant Lipid Biology (Allan DeBono and Lacey Samuels^{*28})

3.11.1. Background

The goal of the microscopy of lipids is to visualize these hydrophobic compounds in their cellular context, with minimal rearrangements. When planning a microscopy approach, it is useful to think about what level of detailed cell structure is required. For high-resolution information on cellular organelles, transmission electron microscopy must be used, but TEM requires that cells be fixed and cut into thin sections, presenting a static view. Scanning electron microscopy (SEM) is useful for directly visualizing detailed surface structures such as the cuticle. For dynamic processes in live cells, light microscopy is the only choice as live cells fare poorly in the high-vacuum conditions of conventional electron microscopes. However, the resolution of the light microscope is limiting, so organelle identification is often done by correlating "puncta" with markers of known subcellular compartments.

In fluorescence microscopy, a sample containing fluorescent molecules, such as a dye or a fluorescent protein, is excited with

²⁸ Department of Botany, University of British Columbia, Vancouver, BC, Canada V6T 1Z4. *Email: lsamuels@interchange.ubc.ca

energy of a given wavelength from a light source (e.g., a mercury lamp). Lower energy, longer wavelength light is emitted, collected through specific filters, and detected by eye or with a camera. Confocal laser scanning microscopy (CLSM) follows the same excitation and emission principles of fluorescence microscopy but provides improved imaging due to removal of out-of-focus fluorescence. The source of excitation is a laser that scans across the sample. The emission is collected through a pinhole of adjustable size that filters out-of-focus light. This allows for shallow depth of focus, which is exploited to generate a series of optical sections in the z-axis, which can be reassembled into a three-dimensional data set (Nikon Microscopy U website.)

In the study of plant lipids, CLSM is used both to detect fluorochrome dyes and to localize enzymes and other gene products related to lipid metabolism in the cell using fluorescent protein fusions. Storage lipids, such as triacylglycerols in oil bodies, can be imaged in live cells using Nile Red staining and fluorescence microscopy (e.g., Schmidt and Herman, 2008; Quettier and Eastmond, 2009). The plasma membrane can be stained using the amphipathic fluorescent styryl dye, FM4-64, as it partitions into the plasma membrane of live cells (Bolte et al., 2004). Endocytosis of the plasma membrane then can be followed over time as the bilayer is internalized and recycled (Zheng et al., 2005; Dettmer et al., 2006; DeBono et al., 2009). FM1-43, a closely related styryl dye, has also been used to label the plasma membrane, endocytic pathway, and even secretory vesicles (Okamoto et al., 2008; Bove et al., 2008).

The following list of protocols is not comprehensive; rather, it represents the experimental approaches that we have found most robust and reliable. For specialized applications, classical histochemistry stains or other fluorescent probes may be more appropriate, and a search of the literature to find how others have approached imaging lipids in the same system is always the best preliminary step.

3.11.2. Protocols

3.11.2.1. Nile red, a general lipophilic stain. Nile Red is a polycyclic lipid stain that fluoresces intensely in a hydrophobic environment but not in aqueous media (Fowler and Greenspan, 1985). Nile Red has sensitivity to the hydrophobic environment, exhibiting red emission in the presence of polar lipids to more yellow emission in the presence of esterified cholesterol and triacylglycerols (Diaz et al., 2008). Nile Red has been used to stain sites of lipid accumulation in plants (Pighin et al., 2004; Schmidt and Herman, 2008; Dietrich et al., 2009) and alterations of surface lipids (Y.H. Li et al., 2007a; Figure 18).

Protocol:

1. A stock solution of Nile Red, also called Nile Blue A Oxazone (Sigma #72485), is dissolved in 100% DMSO to 1 mg/mL and should be stored protected from light at -20°C .
2. Working solutions range from $1\text{--}5\ \mu\text{g mL}^{-1}$, diluted with water or buffer.
3. For tissues with cuticle, cut small segments to allow the stain to penetrate. A leaf disc or 5 mm longitudinal segment from a stem or seedling root will provide abundant imaging material. For elongated cell types, avoid transverse sections to prevent

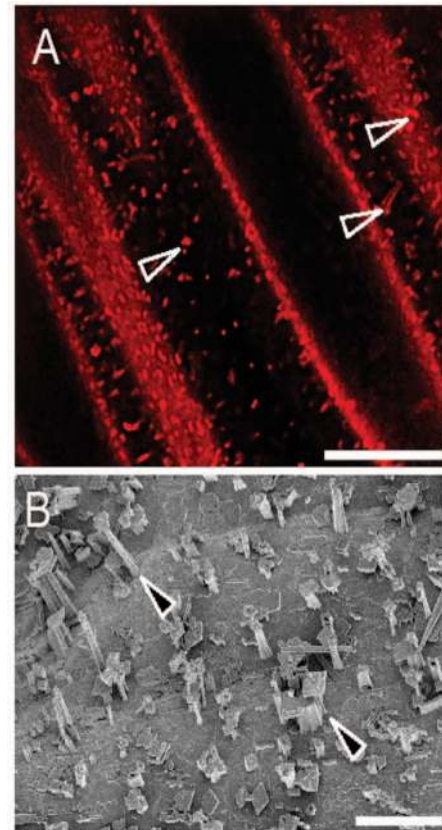

Figure 18. Wax Crystals of Arabidopsis Stems Viewed by Confocal Microscopy and Cryo-Scanning Electron Microscopy.

- (A) Nile Red and confocal microscopy of the Arabidopsis stem epidermis surface with wax crystal structures.
 (B) CryoSEM of Arabidopsis stem epidermis surface with wax crystal structures (closed arrowhead).

Bars = $8\ \mu\text{m}$ (A) and $5\ \mu\text{m}$ (B).

- cell rupture and think about the cell geometry if the tissue is dissected. The tissue can be rinsed to remove excess dye.
4. Generally, Nile Red is excited with 488 nm or 543 nm laser lines and collected with a 560–615 nm filter. For special applications, Nile Red yellow emission, for nonpolar lipids, can be observed with 460 nm excitation and 535 nm emission; the red emission of Nile Red, for polar lipids, can be observed with 540 nm excitation and a 590 nm long pass emission filter (Diaz et al., 2008).

3.11.2.2. FM4-64 staining of the plasma membrane and the endocytic pathway. FM4-64, which fluoresces in the red range, is a useful counterstain to demonstrate plasma membrane localization in plants expressing green or yellow fluorescent proteins (GFP, YFP). FM4-64 has several properties that have contributed to its widespread use: It is not toxic to cells at the working concentrations; it fluoresces intensely only in a lipidic environment or when bound in membranes, reduc-

ing background; and it is soluble in water (<http://www.invitrogen.com>; Bolte et al., 2004). FM1-43 is the green fluorescent equivalent of the red FM4-64 (both spectra can be viewed at the Invitrogen Spectral Viewer).

Protocol:

1. Stock solutions of FM4-64 and FM1-43 (Invitrogen #T-3166 and #T-3163) are prepared at 10 mM in 100% DMSO and stored in aliquots, protected from light, at -20°C .
2. Typical applications of FM4-64 use a working concentration of 4–10 μM for roots (Dettmer et al., 2006), leaves (Zheng et al., 2005), and stems (DeBono et al., 2009). Typical working concentrations of FM1-43 are 160 nM to 2 μM for pollen (Bove et al., 2008; Sousa et al., 2008) and roots (Okamoto et al., 2008).
3. Dissect tissue to allow dye penetration but minimize cell damage (Figure 19) and immerse in dye at room temperature.
4. The plasma membranes of cells from Arabidopsis stems can be observed after 10 min, while roots require shorter incubation times (less than 60 sec). Endocytosis of FM4-64 typically occurs in 20–30 minutes (Figure 20). Timing must be determined empirically for each tissue.
5. FM4-64 can be excited with the 488 nm laser lines and detected with a 560 nm long pass filter. Alternatively, the 543 or 561 nm laser lines can be used for excitation and emission detected with a 584–664 nm band pass filter. Although this means collecting on the shoulder of the FM4-64 emission peak, with the intensity of FM4-64 label, it is often adequate and can be used to limit chloroplast autofluorescence. FM1-43 can also be excited with the 488 nm laser line and detected with a 500–600 nm filter.

3.11.2.3. Scanning electron microscopy. Since the surface structures of the cuticle are sensitive to fixatives and dehydrating agents (Reed, 1982), the undisturbed cuticle is best viewed without conventional SEM preparation (Neinhuis and Barthlott, 1997). Samples can be air dried directly on the SEM stub (Jackson, 2002) or frozen and viewed with cryo-SEM (Pighin et al., 2004; Radboud University Nijmegen).

3.11.2.4. Transmission electron microscopy. TEM allows high-resolution imaging of lipidic cell structure, including membranes and oil bodies. However, lipids are poorly cross-linked by the first aldehyde fixation step in conventional chemical electron microscopy sample preparation (Hopwood, 1972). This can cause membrane and organelle rearrangements, so cryofixation, such as high-pressure freezing and freeze substitution, is recommended for all lipid-rich systems (Bird et al., 2007; Schmidt and Herman, 2008). However, even in cryofixed cells, lipids are probably extracted during room temperature embedding. For example, we have observed that the ultrastructure of the cuticle of Arabidopsis stems was identical in samples that had been dipped in hexane to remove soluble waxes compared to controls without dipping (Samuels lab, unpublished data). This suggests that the cuticle viewed in the TEM is primarily cutin and cutan components. With these caveats in mind, TEM can still provide useful information about membrane structure, oil body size and distribution, and cutin organization.

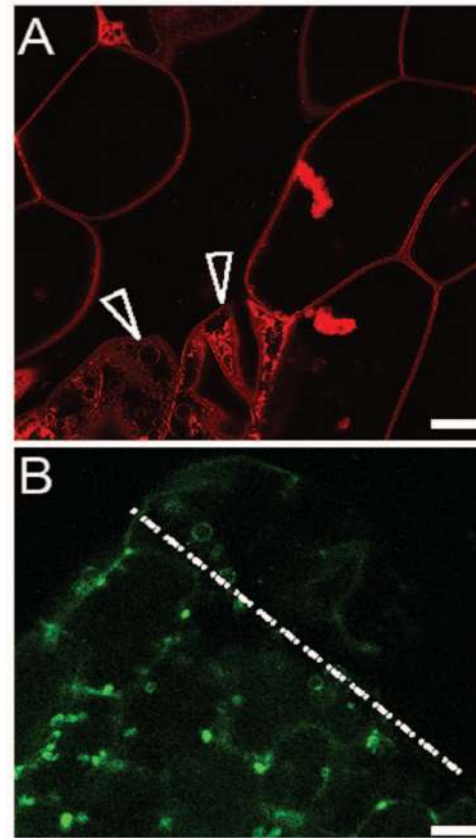

Figure 19. Arabidopsis Hypocotyl Cells Damaged During Handling Prior to Live Imaging.

(A) Hypocotyl cells stained with FM4-64 are vesiculated after crushing (arrowheads).

(B) Yellow fluorescent protein tagged glycosylphosphatidylinositol (GPI)-anchored lipid transfer protein (YFP-LTPG) is plasma membrane localized in undamaged cells. In contrast, due to damage during sample dissection, cells along the incision (dotted line) contain numerous large vesicles. Bars = 14 μm .

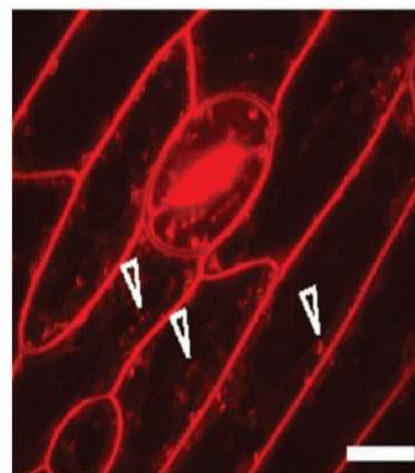

Figure 20. Arabidopsis Stem Epidermal Cells Stained With FM4-64.

Prolonged exposure to FM4-64 stains endocytic compartments (arrowheads) in addition to the plasma membrane. Bar = 9 μm .

Chemical Fixation Protocol:

1. Dissect plant part of interest into pieces no bigger than 2–3 mm. Immersion of the sample in fixative (2% glutaraldehyde in 50 mM PIPES buffer, pH 7.0) at room temperature for 2 h is usually adequate.
2. Wash 3 x in 50 mM PIPES buffer.
3. Postfix in 2% OsO₄ in 50 mM PIPES buffer for 1 h. Samples will turn black.
4. Dehydrate in an ethanol series, 20 min for each step (30% ethanol, 50% ethanol, 70% ethanol, 95% ethanol, 100% ethanol twice).
5. Mix the liquid plastic resin (Spurr's epoxy resin) with the ethanol to gradually infiltrate the resin into the cells. Infiltrate using resin mixed with solvent of increasing concentration series (10% resin, 25% resin, 50% resin, 75% resin, 100% resin). For each mix, let cells incubate for 2 h minimum, overnight maximum.
6. Put samples into BEEM® polyethylene embedding capsules with fresh resin and bake overnight at 60°C.
7. Cut into 0.5 µm sections and stain with 1% toluidine blue in 1% sodium borate to check the morphology of fixed cells with light microscopy. Choose the best blocks and cut 70 nm sections, stain with 2% aqueous uranyl acetate 15 min and Reynold's lead citrate for 5 min, then view with a transmission electron microscope.

Cryofixation Protocol: For detailed information on sample preparation, download the Practical Methods Manual to High-Pressure Freezing (HPF) by Mary Mophew from the Boulder Lab for 3-D Electron Microscopy of Cells.

1. Prepare HPF according to manufacturer's directions and do test runs.
2. With extra fine razor blades, cut small blocks of tissue under a pool of extracellular cryoprotectant, such as sucrose at a nonplasmolyzing concentration. Transfer cells to sample carriers and freeze without delay. The sample preparation and handling is critical; if samples are anoxic, crushed, or air-dried (mild drying leads to plasmolysis), then the best freezing will be for naught.
3. Following freezing, transfer samples to cryovials with freeze substitution medium (2% OsO₄ in anhydrous acetone with 8% dimethoxypropane).
4. Substitute at –80°C for 3 to 5 days using an automated freeze substitution system or an acetone/dry ice slush in a styrofoam chest, which equilibrates at –80°C.
5. Gradually warm samples to room temperature, ramping the temperature up over an 8-hour period, allowing the OsO₄ to react with the stabilized cell structures.
6. Rinse in clean acetone several times and remove the HPF carriers.
7. Slowly infiltrate with Spurr's resin. Add 1 drop of resin to 1 mL of acetone and mix well, then incubate the samples with the resin and acetone mixture for 5–10 min. Continue to increase the amount of resin by 1 drop/mL until you have added up to 10%–25% resin, then leave overnight.
8. Incubate in fresh 25% resin, 2–3 h; 50% resin, 2–3 h; 75% resin, 2–3 h, 100% resin 2–3 h twice or overnight with an extra 1 h change in the morning.
9. Incubate at 60°C to polymerize the resin.

10. Sectioning, staining, and TEM then follow the conventional protocol above.

3.11.3. Comments

The light and electron microscopy techniques above remain popular approaches, but often simple, classical lipid stains, which are used with bright field microscopy, are the most appropriate technique to identify lipid-rich structures such as the cuticle, suberized endodermis, or periderm (Brundrett et al., 1991; Shen et al., 2003; Y.H. Li et al., 2007b). For practical methods in classical histochemical techniques, see Harris et al. (1994).

Despite the problem that structures in the submicrometer range are difficult to resolve, light microscopy continues to be an important tool for studying plant lipids, especially in conjunction with molecular biology and mutant analyses. The localization of proteins of interest using fluorescent protein fusions provides useful information but requires careful experimental design.

Before beginning a molecular biology protocol to fuse a gene of interest to GFP, the following considerations can make the difference between success and disaster. First, consider predicted targeting sites and topology for the protein, and plan the site of fusion to minimize the probability that the fluorescent protein tag will be cleaved off the mature protein during targeting. Check the autofluorescence of the tissue where the protein will be expressed, and choose a protein that does not fluoresce in that range. Finally, your work will have greater credibility if you can demonstrate that the GFP-fusion protein is functional *in vivo* by complementing a mutant phenotype. GFP research has evolved from the older and now obsolete variants of green fluorescent protein to fluorescent proteins with increased brightness, pH stability, and monomerization (e.g., eYFP to CitrineYFP and mRFP to mCherry; Shaner et al., 2007). If your protein of interest is secreted to the acidic cell wall or vacuole, then older GFP variants will be quenched by the low pH. New variants of YFP, Venus, and Citrine have improved pH and chloride sensitivity (Griesbeck et al., 2001; Nagai et al., 2002). After selection of transgenic lines, it is important to screen 10 to 12 lines and select those with appropriate fluorescence levels.

Although live plant cell imaging preparation is relatively straightforward, there are simple provisions that can be made to improve image quality. In addition to differences in anatomical structure, airspaces contribute to the differences in uptake of dyes between leaves and stems versus roots. To overcome the air spaces and the cuticle in such tissues, we have found that a brief centrifugation (30 s) at 500g after incubation in a given dye will improve staining, reduce the time required before imaging, and most importantly permit the tissue to be excited using lower, less damaging laser intensity.

The appropriate amount of laser power is the absolute minimum that can excite the fluor without generating autofluorescence in an untreated, nonfluorescent protein control. Too much laser intensity is toxic and will alter membrane morphology and/or cause vesiculation.

4. SUMMARY OF ARABIDOPSIS LIPID COMPOSITION

This section summarizes the acyl lipid composition for various tissues and organs of wild type Arabidopsis. Data presented in this chapter were collected from Col-0 ecotype unless otherwise noted. The goal of this section is to provide a quick and easy access to summary on acyl lipid content and composition, which sometimes can be difficult to find. It is composed of 15 tables and 3 figures as outlined below:

Tables included:

- Table 4. Fatty Acid Composition of Arabidopsis Tissues
 Table 5. Molecular Species Composition for 52 TAGs From Dry Seeds
 Table 6. Glycerolipid Composition of Arabidopsis Tissues
 Table 7. Fatty Acid Composition of Individual Leaf Glycerolipids From Arabidopsis
 Table 8. Load of Cuticular Wax Compound Classes in Stems and Rosette Leaves of Arabidopsis
 Table 9. Total Load of Suberin and Suberin-Associated Waxes in Arabidopsis Seeds and Roots

- Table 10. Suberin Monomer Composition in Seed Coats and Roots
 Table 11. Composition of Arabidopsis Root Waxes
 Table 12. Composition of Arabidopsis Seed Waxes
 Table 13. Cutin Monomer Composition in Arabidopsis Tissues
 Table 14. Fatty Acid Composition of Glycerophospholipids in Mitochondrial Membranes of Arabidopsis
 Table 15. Lipid Composition of Mitochondria Isolated From Arabidopsis
 Table 16. Acyl-CoA Composition of Arabidopsis Leaf Tissues
 Table 17. Sphingolipid Composition of Arabidopsis Tissues
 Table 18. Stereospecific Analysis of Arabidopsis Seed Triacylglycerols

Figures included:

- Figure 21. Relative Distribution of Lipids and Other Components of Arabidopsis Leaf.
 Figure 22. Relative Distribution of Lipids and Other Components of Arabidopsis Seeds.
 Figure 23. Distribution of Extracellular Lipids in Mature Seeds

Table 4. Fatty Acid Composition of Arabidopsis Tissues

Fatty Acids	Tissue Types				
	Seed	Leaf	Stem	Flower	Root
	Mature	5-Week-Old		Open Flower	15-Day-Old
16:0	8.7±0.1	15.0±0.13	26.3±0.6	28.0±0.1	20.7±0.8
16:1(d3 + d9)	—	3.8±0.04	2.3±0.02	—	1.2±0.6
16:2	—	1.1±0.03	—	—	0.4±0.1
16:3	—	13.8±0.19	11.7±1.6	3.3±0.4	1.5±0.1
18:0	3.6± 0.1	1.0±0.04	2.3±0.01	1.9±0.03	1.9±0.1
18:1 (d9 + d11)	15.0±0.2	3.5±0.14	1.0±0.01	—	7.5±0.01
18:2	29.0±0.3	15.7±0.17	19.9±2.4	36.9±0.4	36.5±1.8
18:3	19.2±0.1	46.0±0.2	36.4±3.3	28.3±0.1	24.6±2.3
20:0	2.2±0.1	—	—	0.6±0.1	1.4±0.02
20:1	20.2±0.1	—	—	—	—
20:2	2.0±0.1	—	—	—	—
22:0	—	—	—	0.5±0.02	2.5±0.1
22:1	1.7±0.1	—	—	—	—
24:0	—	—	—	0.4±0.03	1.7±0.1
Reference	Y.H. Li et al., 2006	Miquel and Browse, 1992	Y.H. Li et al., 2007a	Li-Beisson et al., 2009	Beaudoin et al., 2009

Data are mean expressed as mol% ± SD (SE for leaves). Seeds n = 6, leaves n = 24, stems n = 4, flowers n = 3, roots n = 4). — = not detected. (Prepared by Yonghua Li-Beisson)

Table 5. Molecular Species Composition for 52 TAGs From Dry Seeds

TAG Molecular Species	Weight %	TAG Molecular Species	Weight %
20:1-18:2-18:3	11.5 ± 0.9	18:0-18:2-20:1	1.3 ± 0.1
18:2-20:1-18:2	7.7 ± 0.4	16:0-18:2-16:0	1.3 ± 0.1
18:3-20:1-18:3	6.9 ± 0.5	18:2-20:0-18:2	1.3 ± 0.1
16:0-18:2-20:1	5.1 ± 0.3	16:0-18:1-20:1	1.2 ± 0.1
18:1-18:2-18:3	4.4 ± 0.2	18:0-18:3-20:1	1.0 ± 0.1
20:1-18:3-18:1	4.2 ± 0.3	16:0-18:2-18:0	1.0 ± 0.0
16:0-18:2-18:3	3.6 ± 0.2	18:0-18:2-18:1	0.9 ± 0.1
18:2-16:0-18:2	3.4 ± 0.2	18:3-20:0-18:3	0.9 ± 0.1
16:0-18:3-20:1	3.4 ± 0.1	16:0-20:0-18:2	0.8 ± 0.0
20:1-20:1-18:2	2.8 ± 0.7	16:0-16:0-18:3	0.6 ± 0.1
20:1-20:1-18:3	2.8 ± 0.3	20:0-18:2-18:1	0.6 ± 0.0
16:0-18:2-18:1	2.8 ± 0.1	18:3-18:3-18:3	0.6 ± 0.1
18:2-18:2-18:1	2.6 ± 0.1	20:0-18:2-20:1	0.6 ± 0.1
18:1-20:1-18:1	2.5 ± 0.1	16:0-20:0-18:3	0.5 ± 0.0
18:2-18:3-18:2	2.3 ± 0.2	20:0-18:3-18:1	0.5 ± 0.0
18:3-18:1-18:3	2.2 ± 0.1	16:0-18:3-18:0	0.5 ± 0.0
18:3-18:2-18:3	1.8 ± 0.1	20:0-18:3-20:1	0.4 ± 0.0
18:1-18:2-18:1	1.7 ± 0.3	18:0-18:1-20:1	0.4 ± 0.1
20:0-18:2-18:3	1.7 ± 0.1	18:1-20:0-18:1	0.3 ± 0.0
16:0-18:3-18:1	1.6 ± 0.1	16:0-16:0-18:1	0.3 ± 0.1
18:0-18:2-18:3	1.6 ± 0.1	22:0-18:2-18:3	0.2 ± 0.0
18:2-18:2-18:0	1.5 ± 0.2	16:0-18:1-18:0	0.2 ± 0.0
18:3-18:2-22:1	1.4 ± 0.2	18:2-20:0-18:0	0.2 ± 0.0
20:1-18:1-20:1	1.4 ± 0.1	18:2-22:0-18:2	0.2 ± 0.0
18:2-18:2-18:2	1.3 ± 0.1	18:3-18:3-20:3	0.2 ± 0.0
18:1-18:3-18:1	1.3 ± 0.1	16:0-18:1-20:0	0.2 ± 0.1

TAGs were extracted from 50 seeds/plant and subjected to LC-MS/MS analysis. Amounts were calculated as weight % of total TAGs detected. Only TAGs with an abundance >0.2% are shown. The putative *sn*-2 assignment of the fatty acid for each TAG annotation (*sn*-(1,3) – *sn*-2 – *sn*-(1,3)) was deduced from the intensity of the MS2 daughter ions; *sn*-(1,3) positions are interchangeable. However, *sn*-2 assignments are not guaranteed without further analysis. Values are mean ± SD (n = 5). (Prepared by Tony Larson)

Table 6. Glycerolipid Composition of Arabidopsis Tissues

Glycerolipid Classes	Tissue Types				
	Seed	Root	Chloroplasts	Extrachloroplasts	Leaf (7-Week-Old)
PC	48.1	45.4	12.0	47.8	13.8
PE	22.1	27.5	—	36.5	7.1
PI + PS	18.9	12.9	—	10.9	3.1
PA	—	—	—	—	0.7
SQDG	—	—	3.9	—	—
DGDG	3.3	2.0	20.9	—	18.6
PG	4.6	3.8	9.5	4.4	13.5
MGDG	3.0	3.4	53.7	—	43.2
References	Browse and Somerville, 1994			Welti et al., 2002	

Data are mean and expressed as mol%. — = not detected. (Prepared by Mats Andersson)

Table 7. Fatty Acid Composition of Individual Leaf Glycerolipids From Arabidopsis

Fatty Acids	Leaf Glycerolipid Classes						
	PC	PE	PI	PG	MGDG	DGDG	SQDG
16:0	20.6	31.2	43.5	20.7	1.5	13.6	43.2
16:1	0.6	—	—	33.5	1.5	0.3	—
16:2	—	—	—	—	1.3	0.6	—
16:3	—	—	—	—	30.6	2.1	—
18:0	2.7	3.4	5.2	1.8	0.2	1.1	3.7
18:1	4.4	3.3	4.3	6	1.5	1.3	5.3
18:2	38.8	43	27	12.5	3.4	5.0	10.4
18:3	32.1	18.7	20	25.6	60.0	75.9	37.4
% of total polar lipids	17.2	10.3	3.5	10.1	42.3	14.2	2.5
Reference	Miquel and Browse, 1992						

Data are mean and expressed as mol%. 15-day-old rosette leaves were analyzed. — = not detected. (Prepared by Mats Andersson)

Table 8. Load of Cuticular Wax Compound Classes in Stems and Rosette Leaves of Arabidopsis

Compound Classes	Acyl Chain Length	Tissue Type	
		Stem	Leaf
Free fatty acids	C22	1.5 ± 0.3	—
	C24	2.7 ± 0.4	0.3 ± 0.2
	C26	5.7 ± 1.0	2.7 ± 0.5
	C28	23.5 ± 4.0	3.9 ± 0.5
	C30	15.5 ± 6.5	5.6 ± 1.0
Aldehydes	C26	8.4 ± 1.1	—
	C28	36.2 ± 4.5	2.5 ± 0.6
	C30	57.1 ± 6.9	2.7 ± 0.6
Primary alcohols	C24	3.5 ± 0.6	—
	C26	32.7 ± 4.6	3.6 ± 0.6
	C28	63.0 ± 8.8	6.3 ± 1.2
	C30	21.3 ± 1.9	1.5 ± 1.1
Alkanes	C25	4.5 ± 0.4	0.8 ± 0.6
	C26	0.6 ± 0.4	0.2 ± 0.3
	C27	27.3 ± 2.6	2.7 ± 0.5
	C28	8.0 ± 0.9	0.3 ± 0.2
	C29	1318.1 ± 57.6	30.3 ± 1.6
	C30	9.1 ± 0.6	1.1 ± 0.2
	C31	30.5 ± 6.0	60.5 ± 4.4
	C32	3.3 ± 0.4	1.2 ± 0.1
	C33	4.4 ± 0.4	16.7 ± 1.3
Secondary alcohols	C29	55.5 ± 8.5	—
	C31	8.1 ± 0.7	—
Ketone	C29	534.7 ± 12.4	0.9 ± 0.6
Wax esters	C38	3.8 ± 0.4	—
	C40	8.6 ± 0.3	—
	C42	28.5 ± 2.6	—
	C44	22.0 ± 1.9	—
	C46	9.8 ± 0.9	—
	C48	3.9 ± 0.6	—
Unidentified		43.0 ± 14.7	3.1 ± 2.1
Total		2399.1 ± 71.5	150.1 ± 8.2
Reference	Lü et al., 2009		

Total wax loads and coverage of individual compound classes ($\mu\text{g}/\text{dm}^2$) are given as mean values \pm SD ($n = 3$). Stem and leaf tissue were taken from 6-week-old Arabidopsis plants. — = not detected. (Prepared by Owen Rowland)

Table 9. Total Load of Suberin and Suberin-Associated Waxes in Arabidopsis Seeds and Roots

Tissue Type	Suberin Polyester Monomers		Chloroform-Extracted Waxes	
	Monomer Load	References	Wax Load	References
Seed	^a 2.56 µg/g seeds 46 ng/seed 12 µg/cm ²	Molina et al., 2006	170 µg/g seeds 1.3 ng/seed	Y.H. Li et al., 2007b Beisson et al., 2007
Root	^b 62.7 mg/g residue ^b 50.5 µg/cm ² ^c 7.2 mg/g cell wall ^d 17 mg/g cell wall	Franke et al., 2005 Franke et al., 2005 Beisson et al., 2007 Y.H. Li et al., 2007b	360 µg/gfw	Y.H. Li et al., 2007b

(Prepared by Isabel Molina)

^aSuberin monomers are mostly deposited on the seed coat, but determinations were performed on solvent-extracted residues of whole mature seed samples. Thus, the reported total lipid polyester monomer load includes a contribution of cutin-like monomers from the embryo (about 11% in *B. napus seeds*).

^bLipid polyester monomers determined on solvent-extracted and enzyme-digested (cellulases + pectinases) roots of 5-week-old plants grown on soil.

^cLipid polyester monomers determined on solvent-extracted primary roots of 1-week-old seedlings grown on plates.

^dLipid polyester monomers determined on solvent-extracted secondary roots of 7-week-old plants grown on soil.

Table 10. Suberin Monomer Composition in Seed Coats and Roots

Polyester Monomers	Tissue Type	
	Seed ^a (mol %)	Root ^b (Weight %)
Octadecan-1-ol (C18)	1.50 ± 0.10	2.11 ± 1.46
Eicosan-1-ol (C20)	1.50 ± 0.10	2.49 ± 0.13
Docosan-1-ol (C22)	2.80 ± 0.25	1.83 ± 0.53
Nonadecan-1-ol, branched (C19)	0.30 ± 0.05	—
Tricosan-1-ol, branched (C23)	0.35 ± 0.05	—
Total alkan-1-ols	6.50 ± 0.45	6.43 ± 1.06
16-Hydroxyhexadecanoic acid (C16)	1.75 ± 0.10	5.77 ± 1.2
18-Hydroxyoctadecadienoic acid (C18:2)	4.55 ± 0.60	—
18-Hydroxyoctadecenoic acid (C18:1)	3.45 ± 0.25	23.11 ± 2.26
18-Hydroxyoctadecanoic acid (C18)	0.25 ± 0.05	2.73 ± 0.88
20-Hydroxyeicosanoic acid (C20)	0.65 ± 0.10	3.07 ± 0.44
22-Hydroxydocosanoic acid (C22)	4.20 ± 0.25	7.79 ± 0.76
22-Hydroxydocosanoic acid, branched (C22)	0.70 ± 0.05	—
23-Hydroxytricosanoic acid (C23)	0.55 ± 0.05	—
24-Hydroxytetracosanoic acid (C24)	12.60 ± 0.45	0.71 ± 0.24
24-Hydroxytetracosanoic acid, branched (C24)	0.40 ± 0.05	—
25-Hydroxypentacosanoic acid (C25)	0.30 ± 0.05	—
26-Hydroxyhexacosanoic acid (C26)	0.20 ± 0.05	—
Total ω-hydroxy fatty acids	29.6 ± 1.95	43.19 ± 4.14
1,16-Hexadecane dioic acid (C16)	1.80 ± 0.10	4.91 ± 1.3
1,18-Octadecadiene dioic acid (C18:2)	8.90 ± 0.75	—
1,18-Octadecene dioic acid (C18:1)	3.40 ± 0.20	10.68 ± 0.76
1,18-Octadecane dioic acid (C18)	0.50 ± 0.05	5.87 ± 4.79

(Continued)

Table 10. (continued)

Polyester Monomers	Tissue Type	
	Seed ^a (mol %)	Root ^b (Weight %)
1,20-Eicosane dioic acid (C20)	—	1.01 ± 0.2
1,22-Docosane dioic acid (C22)	1.65 ± 0.10	1.39 ± 0.15
1,24-Tetracosane dioic acid (C24)	8.50 ± 0.40	0.35 ± 0.26
Total 1, ω-dicarboxylic acids	24.75 ± 1.60	24.21 ± 4.69
1,20-Eicosane diol (C20)	0.30 ± 0.05	—
1,22-Docosane diol (C22)	2.40 ± 0.02	—
Total 1, ω-alkane diols	2.70 ± 0.25	—
Hexadecanoic acid (C16)	2.00 ± 0.25	—
Octadecanoic acid (C18)	0.35 ± 0.10	0.12 ± 0.03
C18:1, C18:2, C18:3 acids	5.50 ± 1.50	—
Eicosanoic acid (C20)	0.50 ± 0.05	2.23 ± 0.82
Eicosenoic acid (C20:1)	1.40 ± 0.40	—
Docosanoic acid (C22)	0.50 ± 0.05	6.18 ± 0.7
Tetracosanoic acid (C24)	1.50 ± 0.10	1.11 ± 0.52
Hexacosanoic acid (C26)	0.55 ± 0.05	—
Hexacosenoic acid (C26:1)	0.45 ± 0.10	—
Octacosenoic acid (C28)	0.15	—
Octacosenoic acid (C28:1)	0.30 ± 0.05	—
Dotriacontanoic acid (C32)	0.10	—
Dotriacontenoic acid (C32:1)	0.15	—
Tetracontanoic acid (C34)	0.15	—
Total fatty acids	13.6 ± 2.9	9.64 ± 0.77
2-Hydroxytetracosanoic acid (C24)	0.4 ± 0.15	0.12 ± 0.1
10,16-Dihydroxyhexadecanoic acid (C16)	0.55 ± 0.25	—
9,10,18-Trihydroxyoctadecenoic acid (C18:1)	4.8 ± 0.85	—
Secondary hydroxy-containing species	5.75 ± 1.25	0.12 ± 0.1
Ferulate	15.2 ± 1.3	3.65 ± 3.15
Coumarate	—	1.51 ± 0.69
Sinapate	1.4 ± 0.5	—
β-sitosterol (C29:1)	0.5 ± 0.05	—
Other	17.1 ± 1.9	11.26 ± 3.89
References	Molina et al., 2006	Franke et al., 2005

Composition and relative amounts of monomers released from solvent-extracted seed residues by NaOMe-catalyzed transesterification and from root cell walls by BF₃/MeOH transesterification. — = not detected. (Prepared by Isabel Molina)

^aFor seed analysis, three extractions of bulked mature *Arabidopsis thaliana* seed batches were performed and each seed residue was analyzed in triplicate to give 9 determinations, reported as the average ±SD. GC analyses were undertaken on acetyl derivatives. Peaks that were identified and that are at least 1% of the peak area of the greatest peak, 24-hydroxytetracosanoate, were summed to give 100 mole %. Unidentified peaks represented 18% of the identified peak by peak area.

^bFor root analysis, root cell walls were prepared from 5-week-old *Arabidopsis thaliana* plants. Mean and SD were determined from 10 replicates each representing the roots of 5 to 7 plants. Acids were analyzed as methyl esters, hydroxyl groups as trimethylsilyl ethers.

Table 11. Composition of Arabidopsis Root Waxes

Compound classes	Acyl chain length	Waxes (weight %)
Primary alcohols	18:0	0.97
	20:0	2.18
	22:0	6.13
Free fatty acids	16:0	3.75
	18:0	4.93
	20:0	0.89
	22:0	3.06
	24:0	2.38
	26:0	0.43
	28:0	0.23
Stem-type waxes	30:0	0.09
	29 Alkane	2.93
	29 15-OH	2.02
Monoacylglycerols	29 ketone	0.57
	β -22:0	2.29
	α -22:0	0.99
	β -24:0	1.26
	α -24:0	0.72
	β -26:0	0.30
	α -26:0	0.17
	β -28:0	—
	α -28:0	0.16
	β -30:0	—
α -30:0	0.23	
Sterols	28:1	3.67
	29:1	12.16
Coumarates	18:0	6.90
	20:0	7.72
	22:0	9.86
Ferulates	18:0	1.23
	20:0	2.28
	22:0	4.31
Caffeates	18:0	2.67
	20:0	3.45
	22:0	9.06
Reference	Y.H. Li et al., 2007b	

Data are average of 3 replicates. — = not detected. (Prepared by Isabel Molina)

Table 12. Composition of Arabidopsis Seed Waxes

Compound Classes	Acyl Chain Length	Mass%
Fatty acids	26:0	3.09 ± 0.42
Primary alcohols	26:0	4.33 ± 0.03
	28:0	4.91 ± 0.03
	30:0	0.95 ± 0.22
Alkanes	27:0	1.46 ± 0.05
	29:0	54.41 ± 0.42
	31:0	2.80 ± 0.06
Secondary alcohols	29 15-OH	9.34 ± 0.05
Ketones	29	18.70 ± 0.28
References	Molina et al., 2008	

Values are average ±SE (n = 3). (Prepared by Isabel Molina)

Table 13. Cutin Monomer Composition in Arabidopsis Tissues

Compound Classes	Acyl Chain Length	Tissue Type		
		Stem	Leaf	Flower
		(μg/dm ²)		(μg/g FW)
Fatty acids	16:0	4.5 ± 0.2	2.8 ± 0.2	10 ± 1
	18:0	1.2 ± 0.1	1.4 ± 0.1	2.9 ± 0.3
	18:1, 18:2	2.5 ± 0.6	1.5 ± 0.2	3.6 ± 0.9
	20:0	2.8 ± 1.1	1.4 ± 0.1	10 ± 1
	22:0	3.4 ± 0.3	2.2 ± 0.2	24 ± 1
ω-hydroxy fatty acids	24:0	7.1 ± 1.4	4.4 ± 0.3	6 ± 1
	16:0	12.3 ± 1.1	1.3 ± 0.1	44 ± 6
	18:2	7 ± 0.3	6.4 ± 0.5	45 ± 2
α,ω-Dicarboxylic acids	18:1	7.9 ± 0.8	4.7 ± 0.1	23 ± 9
	16:0	15.8 ± 1.8	9.9 ± 0.4	102 ± 14
	18:2	127.2 ± 26.6	57.7 ± 2.2	126 ± 22
10(9),16-dihydroxy 16:0	18:1	10.4 ± 1.6	9.7 ± 0.3	74 ± 14
	18:0	4.3 ± 0.7	5 ± 0.2	14 ± 8
	10(9),16-dihydroxy 16:0	3.6 ± 0.2	4 ± 0.1	620 ± 120
Total		210 ± 18.2	110.7 ± 9.8	1104 ± 81
References		Y.H. Li et al., 2007a; Li-Beisson et al., 2009		

Data are mean with SD (n = 4). For leaf and cutin analysis, samples were prepared from 5-week-old plants; for flowers, open flower (stage 15) were used. — = not detected. (Prepared by Fred Beisson)

Table 14. Fatty Acid Composition of Glycerophospholipids in Mitochondrial Membranes of Arabidopsis

Fatty Acids	Lipid Species				
	PC	PE	CL	PI	PG
16:0	20.3	19.9	7.0	58.8	64.3
18:0	12.0	5.5	2.7	16.0	16.6
18:1	12.4	9.4	5.8	4.2	6.0
18:2	28.9	39.9	36.8	11.9	7.8
18:3	26.4	25.3	47.7	9.1	5.3
Reference	Caiveau et al., 2001				

Data are expressed on a mol% basis. Cell suspension culture of *A. thaliana* L. (Heynh) was used. (Prepared by Hajime Wada and Kenta Katayama)

Table 15. Lipid Composition of Mitochondria Isolated from Arabidopsis

Cell Suspension Culture	Lipid Species								Reference
	PC	PE	PG	PI	CL	DGDG	MGDG	SQDG	
Cultured with 1 mM Pi	39.4	41.2	3	3.3	10.2	1.5	1.4	0	Jouhet et al., 2004
Cultured without Pi for 3 d	32.6	29	0.3	2.3	14.7	18.2	2.3	0.6	
Cultured with 1 mM Pi	49	33	2	5	11	—	—	—	Caiveau et al., 2001

— = not detected. (Prepared by Hajime Wada and Kenta Katayama)

Table 16. Acyl-CoA Composition of Arabidopsis Leaf Tissues

Acyl-CoAs	Content (fmol/mgFW)
2:0	488.31 ± 30.10
14:0	34.66 ± 1.94
16:0	292.72 ± 9.18
16:1	14.48 ± 1.08
18:0	45.79 ± 2.15
18:1	10.99 ± 3.17
18:2	119.97 ± 7.72
18:3	85.06 ± 3.71
20:0	54.15 ± 1.97
Reference	Kannangara et al., 2007

Data are represented as mean ± SE (n = 3). (Prepared by Yonghua Li-Beisson)

Table 17. Sphingolipid Composition of Arabidopsis Tissues

The sphingolipid content of Arabidopsis varies based on the method used to determine composition and the tissue from which the sphingolipids are extracted. Data are provided for the two main methods of analysis, hydrolysis and measurement of the long-chain base (LCB) component and liquid chromatography tandem mass spectrometry (LC-MS/MS) of the intact sphingolipids. All data are from Arabidopsis leaf tissue at 5–6 weeks of age. (Prepared by Jonathan E. Markham)

Table 17.1. Sphingolipid Composition Determined by LCB Analysis

	t18:1(8Z)	t18:1(8E)	t18:0	d18:1(8Z)	d18:1(8E)	d18:0	TOTAL
Total tissue	59.8 ± 2.9 22.8%	170.5 ± 9.0 65.1%	13.5 ± 0.9 5.2%	2.1 ± 0.3 0.8%	14.7 ± 1.9 5.6%	1.4 ± 0.2 0.5%	262.0 ± 14.3 100%
Neutral sphingolipids	13.0 ± 2.2 39.9%	8.2 ± 1.3 25%	0.8 ± 0.2 0.1%	1.5 ± 0.2 4.5%	8.6 ± 1.2 26.6%	0.3 ± 0.0 0.9%	32.6 ± 4.5 12.4%
Anionic sphingolipids	7.3 ± 2.1 8.7%	67.0 ± 19.3 80.4%	4.8 ± 0.9 5.9%	0.1 ± 0.0 0.1%	2.9 ± 0.4 3.6%	1.1 ± 0.4 1.3%	83.2 ± 23.0 31.8%
Ceramide	0.04 2.9%	0.68 49.3%	0.66 47.7%	0 0%	0 0%	0 0%	1.37 0.5%
Glucosylceramide	10.9 40.9%	8.8 32.9%	0.3 1.1%	0.5 2.0%	6.1 22.7%	0.1 0.4%	26.7 10.2%
GIPC	3.6 7.3%	36.5 72.8%	7.4 14.7%	0 0%	1.3 2.5%	1.3 2.7%	50.1 19.1%
Reference	Markham et al., 2006						

Sphingolipid composition of Arabidopsis determined by hydrolysis and analysis of LCBs as o-phthalaldehyde derivatives as described in Section I (Markham et al., 2006). Table is given for Total tissue, the relative proportion of neutral and anionic sphingolipid, and individually purified compounds. Quantities are in nmol g fw⁻¹ (n = 5; ±SD). GIPC = glycosylinositolphosphoryl-ceramide.

Table 17.2. Sphingolipid Composition Determined by LC-MS/MS

Cer	c16:0	c18:0	c20:0	c20:1	c22:0	c22:1	c24:0	c24:1	c26:0	c26:1	Total
d18:0	0.0	0.0	0.0	0.0	0.0	0.0	0.0	0.0	0.0	0.0	0.1
d18:1	0.1	0.1	0.0	0.0	0.0	0.0	0.1	0.0	0.0	0.0	0.4
t18:0	0.4	0.0	0.0	0.0	0.1	0.0	0.8	0.5	0.4	0.1	2.2
t18:1	0.6	0.0	0.1	0.0	0.5	0.1	2.6	1.1	1.8	0.4	7.3
Total	1.1	0.1	0.2	0.0	0.7	0.1	3.5	1.6	2.2	0.5	13.6
hCer	h16:0	h18:0	h20:0	h20:1	h22:0	h22:1	h24:0	h24:1	h26:0	h26:1	Total
d18:0	0.4	0.0	0.0	0.0	0.0	0.0	0.0	0.0	0.0	0.0	0.4
d18:1	0.2	0.0	0.0	0.0	0.0	0.0	0.0	0.0	0.0	0.0	0.3
t18:0	0.0	0.0	0.0	0.0	0.1	0.0	0.3	0.2	0.0	0.0	0.6
t18:1	0.7	0.1	0.1	0.0	0.9	0.0	2.3	3.5	0.7	0.3	8.6
Total	1.3	0.1	0.1	0.0	1.0	0.0	2.6	3.8	0.8	0.3	9.9

(Continued)

Table 17.2 (continued)

GlcCer	h16:0	h18:0	h20:0	h20:1	h22:0	h22:1	h24:0	h24:1	h26:0	h26:1	Total
d18:0	1.2	0.0	0.1	0.0	0.0	0.0	0.0	0.0	0.0	0.0	1.3
d18:1	52.0	0.2	0.2	0.0	1.1	0.1	2.1	5.8	0.2	0.6	62.2
t18:0	0.1	0.0	0.0	0.0	0.2	0.0	0.6	0.8	0.2	0.0	1.9
t18:1	28.0	0.0	1.8	0.0	13.0	0.5	32.6	58.1	10.3	5.3	149.6
Total	81.2	0.2	2.1	0.1	14.3	0.6	35.3	64.7	10.6	5.9	214.9

GIPC	h16:0	h18:0	h20:0	h20:1	h22:0	h22:1	h24:0	h24:1	h26:0	h26:1	Total
d18:0	2.3	0.0	0.0	0.0	1.5	0.1	0.5	0.8	0.1	1.7	7.1
d18:1	9.6	0.1	1.6	0.0	1.1	0.0	3.3	1.9	0.6	0.7	19.0
t18:0	1.1	0.1	0.4	0.0	2.4	0.2	8.9	13.4	1.3	0.3	28.1
t18:1	16.6	0.6	2.6	0.0	38.7	0.8	85.2	99.9	24.5	8.9	277.7
Total	29.6	0.8	4.6	0.1	43.8	1.1	97.9	116.0	26.4	11.6	331.9

Total	16:0	18:0	20:0	20:1	22:0	22:1	24:0	24:1	26:0	26:1	Total
d18:0	3.9	0.0	0.1	0.0	1.5	0.1	0.6	0.8	0.1	1.7	8.8
d18:1	61.9	0.4	1.9	0.0	2.3	0.1	5.5	7.8	0.8	1.3	81.9
t18:0	1.6	0.1	0.4	0.0	2.8	0.2	10.5	14.9	1.8	0.4	32.8
t18:1	45.8	0.7	4.5	0.1	53.2	1.4	122.7	162.6	37.2	15.0	443.1
Total	113.1	1.1	6.9	0.1	59.8	1.8	139.3	186.1	40.0	18.4	570.4

Free LCBs and LCB-Ps

d18:0	d18:1	d18:2	t18:0	t18:1	3-KS	d18:0-P	d18:1-P	d18:2-P	t18:0-P	t18:1-P
0.63	0.06	0.02	1.57	0.62	0.00	0.00	0.02	0.01	0.07	0.14

LC-MS/MS provides much more data about the sphingolipid LCB–fatty acid pairings, but it provides a lower value for the total sphingolipid composition. The reasons for this are discussed in Markham & Jaworski, 2007. Figures are in nmol g dw⁻¹ (Dry weight is about 1/10th of fresh weight). Data are arranged by sphingolipid; Cer = Ceramide, hCer = 2-hydroxyceramide, GlcCer = Glucosylceramide, GIPC = glycosylinositolphosphoyleceramide. The Total table is a sum of all the classes of sphingolipids and represents the total composition. Numbers for the amount of free LCBs and long-chain base-1-phosphates (LCB-Ps) are also provided.

Table 18. Stereospecific Analysis of Arabidopsis Seed Triacylglycerols**Table 18.1.** Occurrence of Fatty Acids at Each *sn*-Position

	16:0	18:0	18:1Δ9	18:1Δ11	18:2	18:3	20:0	20:1	20:2	22:0	22:1
TAG	8.3	3.4	15	1.2	28.6	18.5	2.1	19.8	1.2	0.3	1.6
<i>sn</i> -1	11.2	3.6	12.8	1.7	23.3	16.4	2.4	21.7	3.5	0.4	2.7
<i>sn</i> -2	6.4	3.6	17.4	0.9	44.3	22	0.9	3.3	0.5	0.4	0.4
<i>sn</i> -3	18.2	9.8	13.9	1	6	4.8	6.3	34.3	1.5	1.3	2.8

Table 18.2. Occurrence of Each Fatty Acid Across All Three *sn*-Positions

	16:0	18:0	18:1Δ9	18:1Δ11	18:2	18:3	20:0	20:1	20:2	22:0	22:1
<i>sn</i> -1	31.4	21.4	29.1	47.3	31.7	38.0	25.1	36.6	64.3	19.9	46.2
<i>sn</i> -2	17.8	20.9	39.4	24.4	60.1	50.8	9.4	5.6	8.3	19.4	7.0
<i>sn</i> -3	50.9	57.8	31.6	28.2	8.2	11.1	65.5	57.8	27.4	60.6	46.8

TAGs were isolated from mature *A. thaliana* (L.) Heynh. Columbia wild type seed and subjected to a Grignard-based stereospecific analysis. Table 18.1 shows the occurrence of all fatty acids at each *sn*-position. Table 18.2 shows the occurrence of each fatty acid across all three *sn*-positions. Values represent mol% of the total. (Prepared by Timothy P. Durette; data from Taylor et al., 1995).

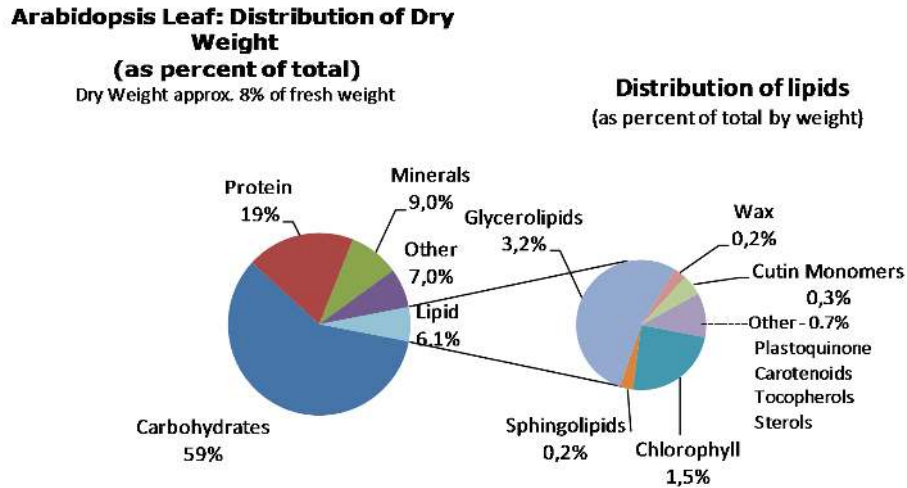

Figure 21. Relative Distribution of Lipids and Other Components of Arabidopsis Leaf.

Data adapted from Browse and Somerville (1994). (Prepared by John Ohlrogge)

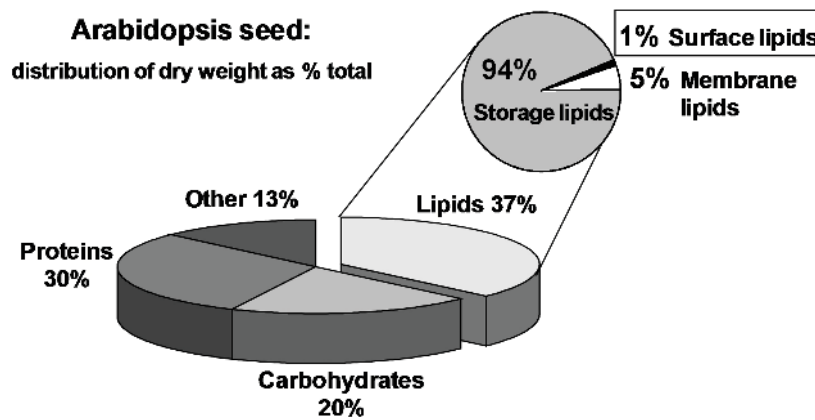

Figure 22. Relative Distribution of Lipids and Other Components of Arabidopsis Seeds.

Relative contribution of storage lipids and proteins were obtained from Y.H. Li et al., 2006. Percentage of membrane glycerolipids relative to total lipids is from Ohlrogge and Browse, 1995. Content of surface lipids is from Molina et al. (2006) and Beisson et al. (2007). (Prepared by Isabel Molina)

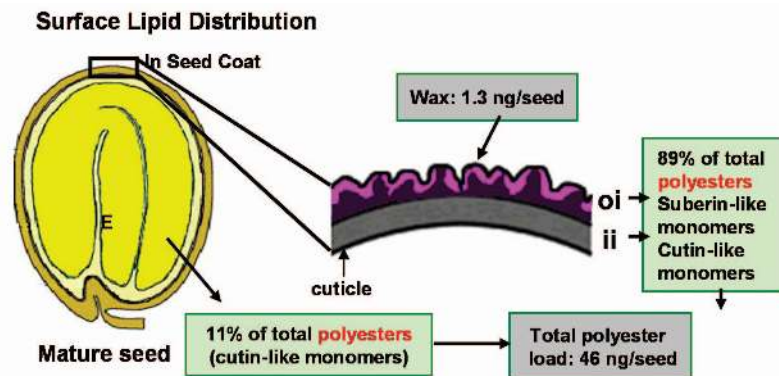

Figure 23. Distribution of Extracellular Lipids in Mature Seeds.

Values of total polyester monomers and distribution between seed coat and embryo (inferred from *B. napus* data) are from Molina et al. (2006). Distribution of polyester monomers in inner integument (ii) and outer integument (oi) summarize results from Molina et al. (2008). Surface wax load was reported by Beisson et al. (2007). (Prepared by Isabel Molina)

REFERENCES

- Aarts, M.G.M., Keijzer, C.J., Stiekema, W.J., and Pereira, A.** (1995). Molecular characterization of the *CER1* gene of Arabidopsis involved in epicuticular wax biosynthesis and pollen fertility. *Plant Cell* **7**, 2115–2127.
- Acosta, I.F., and Farmer, E.E.** (2010). Jasmonates. In *The Arabidopsis Book* (Rockville, MD: American Society of Plant Biologists).
- Adham, A.R., Zolman, B.K., Millius, A., and Bartel, B.** (2005). Mutations in Arabidopsis acyl-CoA oxidase genes reveal distinct and overlapping roles in β -oxidation. *Plant J.* **41**, 859–874.
- Agrawal, V.P., and Kolattukudy, P.E.** (1977). Biochemistry of suberization: ω -hydroxyacid oxidation in enzyme preparations from suberizing potato tuber disks. *Plant Physiol.* **59**, 667–672.
- Agrawal, V.P., and Kolattukudy, P.E.** (1978). Purification and characterization of a wound-induced omega-hydroxyfatty acid:NADP oxidoreductase from potato tuber disks (*Solanum tuberosum* L.). *Arch. Biochem. Biophys.* **191**, 452–465.
- Aharoni, A., Dixit, S., Jetter, R., Thoenes, E., van Arkel, G., and Pereira, A.** (2004). The SHINE clade of AP2 domain transcription factors activates wax biosynthesis, alters cuticle properties, and confers drought tolerance when overexpressed in Arabidopsis. *Plant Cell* **16**, 2463–2480.
- Akoh, C.C., Lee, G.C., Liaw, Y.C., Huang, T.H., and Shaw, J.F.** (2004). GDSL family of serine esterases/lipases. *Prog. Lipid Res.* **43**, 534–552. **Review**
- Andersson, M.X., and Dörmann, P.** (2008). Chloroplast membrane lipid biosynthesis and transport. In *The Chloroplast: Interactions With the Environment*, A. Sandelius and H. Aronsson, eds (Berlin: Springer), pp. 125–159. **Review**
- Andersson, M.X., Goksor, M., and Sandelius, A.S.** (2007). Optical manipulation reveals strong attracting forces at membrane contact sites between endoplasmic reticulum and chloroplasts. *J. Biol. Chem.* **282**, 1170–1174.
- Andersson, M.X., Larsson, K.E., Tjellström, H., Liljenberg, C., and Sandelius, A.S.** (2005). Phosphate-limited oat. The plasma membrane and the tonoplast as major targets for phospholipid-to-glycolipid replacement and stimulation of phospholipases in the plasma membrane. *J. Biol. Chem.* **280**, 27578–27586.
- Andersson, M.X., Stridh, M.H., Larsson, K.E., Liljenberg, C., and Sandelius, A.S.** (2003). Phosphate-deficient oat replaces a major portion of the plasma membrane phospholipids with the galactolipid digalactosyl-diacylglycerol. *FEBS Lett.* **537**, 128–132.
- Andrews, J., and Mudd, J.B.** (1985). Phosphatidylglycerol synthesis in pea chloroplasts: Pathway and localization. *Plant Physiol.* **79**, 259–265.
- Awai, K., Maréchal, E., Block, M.A., Brun, D., Masuda, T., Shimada, H., Takamiya, K., Ohta, H., and Joyard, J.** (2001). Two types of MGDG synthase genes, found widely in both 16:3 and 18:3 plants, differentially mediate galactolipid syntheses in photosynthetic and nonphotosynthetic tissues in *Arabidopsis thaliana*. *Proc. Natl. Acad. Sci. USA* **98**, 10960–10965.
- Awai, K., Xu, C.C., Tamot, B., and Benning, C.** (2006). A phosphatidic acid-binding protein of the chloroplast inner envelope membrane involved in lipid trafficking. *Proc. Natl. Acad. Sci. USA* **103**, 10817–10822.
- Babiychuk, E., Müller, F., Eubel, H., Braun, H.P., Frentzen, M., and Kushnir, S.** (2003). Arabidopsis phosphatidylglycerophosphate synthase 1 is essential for chloroplast differentiation, but is dispensable for mitochondrial function. *Plant J.* **33**, 899–909.
- Bach, L., Michaelson, L.V., Haslam, R., Bellec, Y., Gissot, L., Marion, J., Da Costa, M., Boutin, J.P., Miquel, M., Tellier, F., Domergue, F., Markham, J.E., Beaudoin, F., Napier, J.A., and Faure, J.D.** (2008). The very-long-chain hydroxy fatty acyl-CoA dehydratase PASTICCINO2 is essential and limiting for plant development. *Proc. Natl. Acad. Sci. USA* **105**, 14727–14731.
- Baker, A., Graham, I.A., Holdsworth, M., Smith, S.M., and Theodoulou, F.L.** (2006). Chewing the fat: Beta-oxidation in signalling and development. *Trends Plant Sci.* **11**, 124–132. **Review**
- Bao, X., Focke, M., Pollard, M., and Ohlrogge, J.** (2000). Understanding *in vivo* carbon precursor supply for fatty acid synthesis in leaf tissue. *Plant J.* **22**, 39–50.
- Bates, P.D., Durrett, T.P., Ohlrogge, J.B., and Pollard, M.** (2009). Analysis of acyl fluxes through multiple pathways of triacylglycerol synthesis in developing soybean embryos. *Plant Physiol.* **150**, 55–72.
- Bates, P.D., Ohlrogge, J.B., and Pollard, M.** (2007). Incorporation of newly synthesized fatty acids into cytosolic glycerolipids in pea leaves occurs via acyl editing. *J. Biol. Chem.* **282**, 31206–31216.
- Baud, S., Guyon, V., Kronenberger, J., Wuillème, S., Miquel, M., Caboche, M., Lepiniec, L., and Rochat, C.** (2003). Multifunctional acetyl-CoA carboxylase 1 is essential for very long chain fatty acid elongation and embryo development in Arabidopsis. *Plant J.* **33**, 75–86.
- Baud, S., and Lepiniec, L.** (2009). Regulation of *de novo* fatty acid synthesis in maturing oilseeds of Arabidopsis. *Plant Physiol. and Biochem.* **47**, 448–455. **Review**
- Baud, S., Santos-Mendoza, M., To, A., Harscoët, E., Lepiniec, L., and Dubreucq, B.** (2007). WRINKLED1 specifies the regulatory action of LEAFY COTYLEDON2 towards fatty acid metabolism during seed maturation in Arabidopsis. *Plant J.* **50**, 825–838.
- Baxter, I., Hosmani, P.S., Rus, A., Lahner, B., Borevitz, J.O., Muthukumar, B., Mickelbart, M.V., Schreiber, L., Franke, R.B., and Salt, D.E.** (2009). Root suberin forms an extracellular barrier that affects water relations and mineral nutrition in Arabidopsis. *PLoS Genet.* **5**, e1000492
- Beaudoin, F., Wu, X., Li, F., Haslam, R.P., Markham, J.E., Zheng, H., Napier, J.A., and Kunst, L.** (2009). Functional characterization of the Arabidopsis β -ketoacyl-coenzyme A reductase candidates of the fatty acid elongase. *Plant Physiol.* **150**, 1174–1191.
- Beermann, C., Green, A., Möbius, M., Schmitt, J.J., and Boehm, G.** (2003). Lipid class separation by HPLC combined with GC FA analysis: Comparison of seed lipid compositions from different *Brassica napus* L. varieties. *J. Am. Oil Chem. Soc.* **80**, 747–753.
- Beisson, F., Koo, A.J., Ruuska, S., Schwender, J., Pollard, M., Thelen, J.J., Paddock, T., Salas, J.J., Savage, L., Milcamps, A., Mhaske, V.B., Cho, Y., and Ohlrogge, J.B.** (2003). Arabidopsis genes involved in acyl lipid metabolism: A 2003 census of the candidates, a study of the distribution of expressed sequence tags in organs, and a web-based database. *Plant Physiol.* **132**, 681–697.
- Beisson, F., Li, Y., Bonaventure, G., Pollard, M., and Ohlrogge, J.B.** (2007). The acyltransferase GPAT5 is required for the synthesis of suberin in seed coat and root of Arabidopsis. *Plant Cell* **19**, 351–368.
- Beisson, F., Tiss, A., Rivière, C., and Verger, R.** (2000). Methods for lipase detection and assay: A critical review. *Eur. J. Lipid Sci. Technol.* **102**, 133–153. **Review**
- Bell, R.M., Ballas, L.M., and Coleman, R.A.** (1981). Lipid topogenesis. *J. Lipid Res.* **22**, 391–403.
- Benning, C.** (2008). A role for lipid trafficking in chloroplast biogenesis. *Prog. Lipid Res.* **47**, 381–389. **Review**
- Benning, C.** (2009). Mechanisms of lipid transport involved in organelle biogenesis in plant cells. *Annu. Rev. Cell Dev. Biol.* **25**, 71–91. **Review**
- Benning, C., Xu, C., and Awai, K.** (2006). Non-vesicular and vesicular lipid trafficking involving plastids. *Curr. Opin. Plant Biol.* **9**, 241–247. **Review**
- Benveniste, I., Tijet, N., Adas, F., Philipps, G., Salaün, J.P., and Durst, F.** (1998). CYP86A1 from *Arabidopsis thaliana* encodes a cytochrome P450-dependent fatty acid omega-hydroxylase. *Biochem. Biophys. Res. Commun.* **243**, 688–693.

- Bernards, M.A.** (2002). Demystifying suberin. *Can. J. Bot.* **80**, 227–240. **Review**
- Bessire, M., Chassot, C., Jacquat, A.-C., Humphry, M., Borel, S., Petétot, J.M.C., Metraux, J.P., and Nawrath, C.** (2007). A permeable cuticle in *Arabidopsis* leads to a strong resistance to *Botrytis cinerea*. *EMBO J.* **26**, 2158–2168.
- Bird, D.A.** (2008). The role of ABC transporters in cuticular lipid secretion. *Plant Sci.* **174**, 563–569. **Review**
- Bird, D., Beisson, F., Brigham, A., Shin, J., Greer, S., Jetter, R., Kunst, L., Wu, X., Yephremov, A., and Samuels, L.** (2007). Characterization of *Arabidopsis* ABCG11/WBC11, an ATP binding cassette (ABC) transporter that is required for cuticular lipid secretion. *Plant J.* **52**, 485–498.
- Bishop, W.R., and Bell, R.M.** (1988). Assembly of phospholipids into cellular membranes: Biosynthesis, transmembrane movement and intracellular translocation. *Annu. Rev. Cell Biol.* **4**, 579–610. **Review**
- Bjerve, K.S., Daae, L.N., and Bremer, J.** (1974). The selective loss of lysophospholipids in some commonly used lipid-extraction procedures. *Anal. Biochem.* **58**, 238–245.
- Bligh, E.G., and Dyer, W.J.** (1959). A rapid method of total lipid extraction and purification. *Can. J. Biochem. Physiol.* **37**, 911–917.
- Boerjan, W., Ralph, J., and Baucher, M.** (2003). Lignin biosynthesis. Annual Review of Plant Biology **54**, 519–546. **Review**
- Bolte, S., Talbot, C., Boutte, Y., Catrice, O., Read, N.D., and Satiat-Jeunemaitre, B.** (2004). FM-dyes as experimental probes for dissecting vesicle trafficking in living plant cells. *J. Microsc. (Oxford, U.K.)* **214**, 159–173.
- Bonaventure, G., Salas, J.J., Pollard, M.R., and Ohlrogge, J.B.** (2003). Disruption of the *FATB* gene in *Arabidopsis* demonstrates an essential role of saturated fatty acids in plant growth. *Plant Cell* **15**, 1020–1033.
- Bonaventure, G., Bao, X., Ohlrogge, J., and Pollard, M.** (2004a). Metabolic responses to the reduction in palmitate caused by disruption of the *FATB* gene in *Arabidopsis*. *Plant Physiol.* **135**, 1269–1279.
- Bonaventure, G., Beisson, F., Ohlrogge, J., and Pollard, M.** (2004b). Analysis of the aliphatic monomer composition of polyesters associated with *Arabidopsis* epidermis: Occurrence of octadeca-*cis*-6, *cis*-9-diene-1,18-dioate as the major component. *Plant J.* **40**, 920–930.
- Bourdin, B., Adenier, H., and Perrin, Y.** (2007). Camitine is associated with fatty acid metabolism in plants. *Plant Physiol. Biochem.* **45**, 926–931.
- Bove, J., Vaillancourt, B., Kroeger, J., Hepler, P.K., Wiseman, P.W., and Geitmann, A.** (2008). Magnitude and direction of vesicle dynamics in growing pollen tubes using spatiotemporal image correlation spectroscopy and fluorescence recovery after photobleaching. *Plant Physiol.* **147**, 1646–1658.
- Brodersen, P., Petersen, M., Pike, H.M., Olszak, B., Skov, S., Ødum, N., Jørgensen, L.B., Brown, R.E., and Mundy, J.** (2002). Knockout of *Arabidopsis* *ACCELERATED-CELL-DEATH11* encoding a sphingosine transfer protein causes activation of programmed cell death and defense. *Genes Dev.* **16**, 490–502.
- Broun, P., Poindexter, P., Osborne, E., Jiang, C.Z., and Riechmann, J.L.** (2004). WIN1, a transcriptional activator of epidermal wax accumulation in *Arabidopsis*. *Proc. Natl. Acad. Sci. USA* **101**, 4706–4711.
- Brown, A.P., Affleck, V., Fawcett, T., and Slabas, A.R.** (2006). Tandem affinity purification tagging of fatty acid biosynthetic enzymes in *Synechocystis* sp PCC6803 and *Arabidopsis thaliana*. *J. Exp. Bot.* **57**, 1563–1571.
- Browse, J., McConn, M., James, D., Jr., and Miquel, M.** (1993). Mutants of *Arabidopsis* deficient in the synthesis of α -linolenate: Biochemical and genetic characterization of the endoplasmic reticulum linoleoyl desaturase. *J. Biol. Chem.* **268**, 16345–16351.
- Browse, J., McCourt, P.J., and Somerville, C.R.** (1986a). Fatty acid composition of leaf lipids determined after combined digestion and fatty acid methyl ester formation from fresh tissue. *Anal. Biochem.* **152**, 141–145.
- Browse, J., and Somerville, C.** (1991). Glycerolipid synthesis: Biochemistry and regulation. *Annu. Rev. Plant Physiol. Plant Mol. Biol.* **42**, 467–506. **Review**
- Browse, J., and Somerville, C.R.** (1994). Glycerolipids. In *Arabidopsis*, E.M. Meyerowitz and C.R. Somerville, eds (Plainview, NY: Cold Spring Harbor Laboratory Press), pp. 881–936. **Review**
- Browse, J., Warwick, N., Somerville, C.R., and Slack, C.R.** (1986b). Fluxes through the prokaryotic and eukaryotic pathways of lipid synthesis in the '16:3' plant *Arabidopsis thaliana*. *Biochem. J.* **235**, 25–31.
- Brügger, B., Erben, G., Sandhoff, R., Wieland, F.T., and Lehmann, W.D.** (1997). Quantitative analysis of biological membrane lipids at the low picomole level by nano-electrospray ionization tandem mass spectrometry. *Proc. Natl. Acad. Sci. USA* **94**, 2339–2344.
- Brundrett, M.C., Kendrick, B., and Peterson, C.A.** (1991). Efficient lipid staining in plant material with Sudan red 7B or fluoral [correction of fluoral] yellow 088 in polyethylene glycol-glycerol. *Biotech. Histochem.* **66**, 111–116.
- Buckhout, T.J., and Thimm, O.** (2003). Insights into metabolism obtained from microarray analysis. *Curr. Opin. Plant Biol.* **6**, 288–296. **Review**
- Burgal, J., Shockey, J., Lu, C., Dyer, J., Larson, T., Graham, I., and Browse, J.** (2008). Metabolic engineering of hydroxy fatty acid production in plants: RcDGAT2 drives dramatic increases in ricinoleate levels in seed oil. *Plant Biotechnol. J.* **6**, 819–831.
- Buseman, C.M., Tamura, P., Sparks, A.A., Baughman, E.J., Maatta, S., Zhao, J., Roth, M.R., Esch, S.W., Shah, J., Williams, T.D., and Welti, R.** (2006). Wounding stimulates the accumulation of glycerolipids containing oxophytodienoic acid and dinor-oxophytodienoic acid in *Arabidopsis* leaves. *Plant Physiology* **142**, 28–39.
- Caiveau, O., Fortune, D., Cantrel, C., Zachowski, A., and Moreau, F.** (2001). Consequences of ω -6-oleate desaturase deficiency on lipid dynamics and functional properties of mitochondrial membranes of *Arabidopsis thaliana*. *J. Biol. Chem.* **276**, 5788–5794.
- Cao, J., Li, J.L., Li, D., Tobin, J.F., and Gimeno, R.E.** (2006). Molecular identification of microsomal acyl-CoA:glycerol-3-phosphate acyltransferase, a key enzyme in *de novo* triacylglycerol synthesis. *Proc. Natl. Acad. Sci. USA* **103**, 19695–19700.
- Carde, J.P., Joyard, J., and Douce, R.** (1982). Electron-microscopic studies of envelope membranes from spinach plastids. *Biol. Cell* **44**, 315–324.
- Carman, G.M.** (1997). Phosphatidate phosphatases and diacylglycerol pyrophosphate phosphatases in *Saccharomyces cerevisiae* and *Escherichia coli*. *Biochim. Biophys. Acta* **1348**, 45–55.
- Carman, G.M., and Han, G.S.** (2006). Roles of phosphatidate phosphatase enzymes in lipid metabolism. *Trends Biochem. Sci.* **31**, 694–699. **Review**
- Carrie, C., Murcha, M.W., Millar, A.H., Smith, S.M., and Whelan, J.** (2007). Nine 3-ketoacyl-CoA thiolases (KATs) and acetoacetyl-CoA thiolases (ACATs) encoded by five genes in *Arabidopsis thaliana* are targeted either to peroxisomes or cytosol but not to mitochondria. *Plant Mol. Biol.* **63**, 97–108.
- Cases, S., Smith, S.J., Zheng, Y.W., Myers, H.M., Lear, S.R., Sande, E., Novak, S., Collins, C., Welch, C.B., Lusic, A.J., Erickson, S.K., and Farese, R.V., Jr.** (1998). Identification of a gene encoding an acyl CoA:diacylglycerol acyltransferase, a key enzyme in triacylglycerol synthesis. *Proc. Natl. Acad. Sci. USA* **95**, 13018–13023.
- Cases, S., Stone, S.J., Zhou, P., Yen, E., Tow, B., Lardizabal, K.D., Voelker, T., and Farese, R.V., Jr.** (2001). Cloning of DGAT2, a second mammalian diacylglycerol acyltransferase, and related family members. *J. Biol. Chem.* **276**, 38870–38876.
- Cernac, A., and Benning, C.** (2004). *WRINKLED1* encodes an AP2/EREB domain protein involved in the control of storage compound bio-

- synthesis in Arabidopsis. *Plant J.* **40**, 575–585.
- Cheesbrough, T.M., and Kolattukudy, P.E.** (1984). Alkane biosynthesis by decarbonylation of aldehydes catalyzed by a particulate preparation from *Pisum sativum*. *Proc. Natl. Acad. Sci. USA* **81**, 6613–6617.
- Chen, M., Han, G., Dietrich, C.R., Dunn, T.M., and Cahoon, E.B.** (2006). The essential nature of sphingolipids in plants as revealed by the functional identification and characterization of the Arabidopsis LCB1 subunit of serine palmitoyltransferase. *Plant Cell* **18**, 3576–3593.
- Chen, M., Markham, J.E., Dietrich, C.R., Jaworski, J.G., and Cahoon, E.B.** (2008). Sphingolipid long-chain base hydroxylation is important for growth and regulation of sphingolipid content and composition in Arabidopsis. *Plant Cell* **20**, 1862–1878.
- Chen, X., Goodwin, S.M., Boroff, V.L., Liu, X.L., and Jenks, M.A.** (2003). Cloning and characterization of the *WAX2* gene of Arabidopsis involved in cuticle membrane and wax production. *Plant Cell* **15**, 1170–1185.
- Choi, Y.H., Lee, J.K., Lee, C.-H., and Cho, S.H.** (2000). cDNA cloning and expression of an aminoalcoholphosphotransferase isoform in Chinese cabbage. *Plant Cell Physiol.* **41**, 1080–1084.
- Christie, W.W.** (1993). Preparation of lipid extracts from tissues. In *Advances in Lipid Methodology*, Vol. 2, W.W. Christie, ed (Dundee, Scotland: Oily Press), pp. 195–213, reprinted <http://lipidlibrary.aocs.org/topics/extract2/index.htm>.
- Christie, W.W.** (2003). *Lipid Analysis: Isolation, Separation, Identification and Structural Analysis of Lipids*, 3rd ed. (Bridgwater, England: Oily Press). **Review**
- Clauss, K., Baumert, A., Nitz, M., Milkowski, C., and Strack, D.** (2008). Role of a GDSL lipase-like protein as sinapine esterase in Brassicaceae. *Plant J.* **53**, 802–813.
- Colnago, L.A., Engelsberg, M., Souza, A.A., and Barbosa, L.L.** (2007). High-throughput, non-destructive determination of oil content in intact seeds by continuous wave-free precession NMR. *Anal. Chem.* **79**, 1271–1274.
- Cominelli, E., Sala, T., Calvi, D., Gusmaroli, G., and Tonelli, C.** (2008). Over-expression of the Arabidopsis *AtMYB41* gene alters cell expansion and leaf surface permeability. *Plant J.* **53**, 53–64.
- Compagnon, V., Diehl, P., Benveniste, I., Meyer, D., Schaller, H., Schreiber, L., Franke, R., and Pinot, F.** (2009). CYP86B1 is required for very long chain ω -hydroxyacid and α,ω -dicarboxylic acid synthesis in root and seed suberin polyester. *Plant Physiol.* **150**, 1831–1843.
- Cruz-Ramírez, A., López-Bucio, J., Ramírez-Pimentel, G., Zurita-Silva, A., Sánchez-Calderon, L., Ramirez-Chávez, E., González-Ortega, E., and Herrera-Estrella, L.** (2004). The *xip1* mutant of Arabidopsis reveals a critical role for phospholipid metabolism in root system development and epidermal cell integrity. *Plant Cell* **16**, 2020–2034.
- Cruz-Ramírez, A., Oropeza-Aburto, A., Razo-Hernández, F., Ramirez-Chávez, E., and Herrera-Estrella, L.** (2006). Phospholipase DZ2 plays an important role in extraplastidic galactolipid biosynthesis and phosphate recycling in Arabidopsis roots. *Proc. Natl. Acad. Sci. USA* **103**, 6765–6770.
- Dahlqvist, A., Ståhl, U., Lenman, M., Banas, A., Lee, M., Sandager, L., Ronne, H., and Stymne, H.** (2000). Phospholipid:diacylglycerol acyltransferase: An enzyme that catalyzes the acyl-CoA-independent formation of triacylglycerol in yeast and plants. *Proc. Natl. Acad. Sci. USA* **97**, 6487–6492.
- Davin, L.B., and Lewis, N.G.** (2005). Dirigent phenoxyl radical coupling: Advances and challenges. *Curr. Opin. Biotechnol.* **16**, 398–406. **Review**
- DeBono, A., Yeats, T.H., Rose, J.K.C., Bird, D., Jetter, R., Kunst, L., and Samuels, L.** (2009). Arabidopsis LTPG is a glycosylphosphatidylinositol-anchored lipid transfer protein required for export of lipids to the plant surface. *Plant Cell* **21**, 1230–1238.
- Dettmer, J., Hong-Hermesdorf, A., Stierhof, Y.D., and Schumacher, K.** (2006). Vacuolar H⁺-ATPase activity is required for endocytic and secretory trafficking in Arabidopsis. *Plant Cell* **18**, 715–730.
- Devaiah, S.P., Roth, M.R., Baughman, E., Li, M., Tamura, P., Jeannotte, R., Welti, R., and Wang, X.** (2006). Quantitative profiling of polar glycerolipid species from organs of wild-type Arabidopsis and a *PHOSPHOLIPASE D α 1* knockout mutant. *Phytochemistry* **67**, 1907–1924.
- Dewey, R.E., Wilson, R.F., Novitzky, W.P., and Goode, J.H.** (1994). The *AAPT1* gene of soybean complements a cholinephosphotransferase-deficient mutant of yeast. *Plant Cell* **6**, 1495–1507.
- Diaz, G., Melis, M., Batetta, B., Angius, F., and Falchi, A.M.** (2008). Hydrophobic characterization of intracellular lipids in situ by Nile Red red/yellow emission ratio. *Micron* **39**, 819–824.
- Dietrich, C.R., Han, G., Chen, M., Berg, R.H., Dunn, T.M., and Cahoon, E.B.** (2008). Loss-of-function mutations and inducible RNAi suppression of Arabidopsis *LCB2* genes reveal the critical role of sphingolipids in gametophytic and sporophytic cell viability. *Plant J.* **54**, 284–298.
- Dietrich, D., Schmuths, H., Lousa, C.D., Baldwin, J.M., Baldwin, S.A., Baker, A., Theodoulou, F.L., and Holdsworth, M.J.** (2009). Mutations in the Arabidopsis peroxisomal ABC transporter COMATOSE allow differentiation between multiple functions in planta: Insights from an allelic series. *Mol. Biol. Cell* **20**, 530–543.
- Dörmann, P., and Benning, C.** (2002). Galactolipids rule in seed plants. *Trends Plant Sci.* **7**, 112–118. **Review**
- Dorne, A.J., Joyard, J., Block, M.A., and Douce, R.** (1985). Localization of phosphatidylcholine in outer envelope membrane of spinach chloroplasts. *J. Cell Biol.* **100**, 1690–1697.
- Drea, S.C., Mould, R.M., Hibberd, J.M., Gray, J.C., and Kavanagh, T.A.** (2001). Tissue-specific and developmental-specific expression of an *Arabidopsis thaliana* gene encoding the lipoamide dehydrogenase component of the plastid pyruvate dehydrogenase complex. *Plant Mol. Biol.* **46**, 705–715.
- Dunn, T.M., Lynch, D.V., Michaelson, L.V., and Napier, J.A.** (2004). A post-genomic approach to understanding sphingolipid metabolism in *Arabidopsis thaliana*. *Ann. Bot.* **93**, 483–497. **Review**
- Eastmond, P.J.** (2004). Cloning and characterization of the acid lipase from castor beans. *J. Biol. Chem.* **279**, 45540–45545.
- Eastmond, P.J.** (2006). *SUGAR-DEPENDENT1* encodes a patatin domain triacylglycerol lipase that initiates storage oil breakdown in germinating Arabidopsis seeds. *Plant Cell* **18**, 665–675.
- Eastmond, P.J., and Graham, I.A.** (2000a). The multifunctional protein AtMFP2 is co-ordinately expressed with other genes of fatty acid β -oxidation during seed germination in *Arabidopsis thaliana* (L.) Heynh. *Biochem. Soc. Trans.* **28**, 95–99.
- Eastmond, P.J., Hooks, M.A., Williams, D., Lange, P., Bechtold, N., Sarrobert, C., Nussaume, L., and Graham, I.A.** (2000b). Promoter trapping of a novel medium-chain acyl-CoA oxidase, which is induced transcriptionally during Arabidopsis seed germination. *J. Biol. Chem.* **275**, 34375–34381.
- El-Kouhen, K., Blangy, S., Ortiz, E., Gardies, A.-M., Ferte, N., and Aron-del, V.** (2005). Identification and characterization of a triacylglycerol lipase in Arabidopsis homologous to mammalian acid lipases. *FEBS Lett.* **579**, 6067–6073.
- Espelie, K.E., Davis, R.W., and Kolattukudy, P.E.** (1980). Composition, ultrastructure and function of the cutin-containing and suberin-containing layers in the leaf, fruit peel, juice-sac and inner seed coat of grapefruit (*Citrus-paradisi* macfied). *Planta* **149**, 498–511.
- Faussner, I., and Wasternack, C.** (2002). The lipoxygenase pathway. *Annu. Rev. Plant Biol.* **53**, 275–297. **Review**
- Fiebig, A., Mayfield, J.A., Miley, N.L., Chau, S., Fischer, R.L., and Preuss, D.** (2000). Alterations in *CER6*, a gene identical to *CUT1*, differentially affect long-chain lipid content on the surface of pollen and stems. *Plant Cell* **12**, 2001–2008.
- Fishwick, M.J., and Wright, A.J.** (1977). Comparison of methods for ex-

- traction of plant lipids. *Phytochemistry* **16**, 1507–1510.
- Focke, M., Gieringer, E., Schwan, S., Jansch, L., Binder, S., and Braun, H.P.** (2003). Fatty acid biosynthesis in mitochondria of grasses: Malonyl-coenzyme A is generated by a mitochondrial-localized acetyl-coenzyme A carboxylase. *Plant Physiol.* **133**, 875–884.
- Folch, J., Lees, M., and Sloane Stanley, G.H.** (1957). A simple method for the isolation and purification of total lipides from animal tissues. *J. Biol. Chem.* **226**, 497–509.
- Footitt, S., Slocombe, S.P., Lerner, V., Kurup, S., Wu, Y., Larson, T., Graham, I., Baker, A., and Holdsworth, M.** (2002). Control of germination and lipid mobilization by *COMATOSE*, the Arabidopsis homologue of human ALDP. *EMBO J.* **21**, 2912–2922.
- Fowler, S.D., and Greenspan, P.** (1985). Application of Nile red, a fluorescent hydrophobic probe, for the detection of neutral lipid deposits in tissue sections: Comparison with oil red O. *J. Histochem. Cytochem.* **33**, 833–836.
- Franke, R., Briesen, I., Wojciechowski, T., Faust, A., Yephremov, A., Nawrath, C., and Schreiber, L.** (2005). Apoplastic polyesters in Arabidopsis surface tissues—A typical suberin and a particular cutin. *Phytochemistry* **66**, 2643–2658.
- Franke, R., Höfer, R., Briesen, I., Emsermann, M., Efremova, N., Yephremov, A., and Schreiber, L.** (2009). The *DAISY* gene from Arabidopsis encodes a fatty acid elongase condensing enzyme involved in the biosynthesis of aliphatic suberin in roots and the chalaza-micropyle region of seeds. *Plant J.* **57**, 80–95.
- Franke, R., and Schreiber, L.** (2007). Suberin—A biopolyester forming apoplastic plant interfaces. *Curr. Opin. Plant Biol.* **10**, 252–259. **Review**
- Frentzen, M., and Griebau, R.** (1994). Biosynthesis of cardiolipin in plant mitochondria. *Plant Physiol.* **106**, 1527–1532.
- Froman, B.E., Edwards, P.C., Bursch, A.G., and Dehesh, K.** (2000). ACX3, a novel medium-chain acyl-coenzyme A oxidase from Arabidopsis. *Plant Physiol.* **123**, 733–741.
- Fulda, M., Schnurr, J., Abbad, A., Heinz, E., and Browse, J.** (2004). Peroxisomal acyl-CoA synthetase activity is essential for seedling development in *Arabidopsis thaliana*. *Plant Cell* **16**, 394–405.
- Gable, K., Slife, H., Bacikova, D., Monaghan, E., and Dunn, T.M.** (2000). Tsc3p is an 80-amino acid protein associated with serine palmitoyltransferase and required for optimal enzyme activity. *J. Biol. Chem.* **275**, 7597–7603.
- Gage, D.A., Huang, Z.H., and Benning, C.** (1992). Comparison of sulfoquinovosyl diacylglycerol from spinach and the purple bacterium *Rhodobacter sphaeroides* by fast atom bombardment tandem mass spectrometry. *Lipids* **27**, 632–636.
- Gao, J., Ajjawi, I., Manoli, A., Sawin, A., Xu, C., Froehlich, J.E., Last, R.L., and Benning, C.** (2009). FATTY ACID DESATURASE4 of Arabidopsis encodes a protein distinct from characterized fatty acid desaturases. *Plant J.* **60**, 832–839.
- Germain, V., Rylott, E.L., Larson, T.R., Sherson, S.M., Bechtold, N., Carde, J.P., Bryce, J.H., Graham, I.A., and Smith, S.M.** (2001). Requirement for 3-ketoacyl-CoA thiolase-2 in peroxisome development, fatty acid beta-oxidation and breakdown of triacylglycerol in lipid bodies of Arabidopsis seedlings. *Plant J.* **28**, 1–12.
- Ghosh, A.K., Chauhan, N., Rajakumari, S., Daum, G., and Rajasekharan, R.** (2009). At4g24160, a Soluble Acyl-Coenzyme A-Dependent Lysophosphatidic Acid Acyltransferase. *Plant Physiology* **151**, 869–881.
- Gidda, S.K., Shockey, J.M., Rothstein, S.J., Dyer, J.M., and Mullen, R.T.** (2009). *Arabidopsis thaliana* GPAT8 and GPAT9 are localized to the ER and possess distinct ER retrieval signals: Functional divergence of the dilysine ER retrieval motif in plant cells. *Plant Physiol. Biochem.* **47**, 867–879.
- Girke, T., Todd, J., Ruuska, S., White, J., Benning, C., and Ohlrogge, J.** (2000). Microarray analysis of developing Arabidopsis seeds. *Plant Physiol.* **124**, 1570–1581.
- Goepfert, S., Hiltunen, J.K., and Poirier, Y.** (2006). Identification and functional characterization of a monofunctional peroxisomal enoyl-CoA hydratase 2 that participates in the degradation of even cis-unsaturated fatty acids in *Arabidopsis thaliana*. *J. Biol. Chem.* **281**, 35894–35903.
- Goepfert, S., and Poirier, Y.** (2007). Beta-oxidation in fatty acid degradation and beyond. *Curr. Opin. Plant Biol.* **10**, 245–251. **Review**
- Goepfert, S., Vidoudez, C., Rezzonico, E., Hiltunen, J.K., and Poirier, Y.** (2005). Molecular identification and characterization of the Arabidopsis Delta(3,5),Delta(2,4)-dienoyl-coenzyme A isomerase, a peroxisomal enzyme participating in the beta-oxidation cycle of unsaturated fatty acids. *Plant Physiol.* **138**, 1947–1956.
- Goepfert, S., Vidoudez, C., Tellgren-Roth, C., Delessert, S., Hiltunen, J.K., and Poirier, Y.** (2008). Peroxisomal Delta(3),Delta(2)-enoyl CoA isomerases and evolution of cytosolic paralogues in embryophytes. *Plant J.* **56**, 728–742.
- Gomes, E., Jakobsen, M.K., Axelsen, K.B., Geisler, M., and Palmgren, M.G.** (2000). Chilling tolerance in Arabidopsis involves ALA1, a member of a new family of putative aminophospholipid translocases. *Plant Cell* **12**, 2441–2453.
- Goode, J.H., and Dewey, R.E.** (1999). Characterization of aminoalcoholphosphotransferases from *Arabidopsis thaliana* and soybean. *Plant Physiol. Biochem.* **37**, 445–457.
- Graça, J., and Pereira, H.** (2000). Suberin structure in potato periderm: Glycerol, long-chain monomers, and glyceryl and feruloyl dimers. *J. Agric. Food Chem.* **48**, 5476–5483.
- Graça, J., and Santos, S.** (2006a). Glycerol-derived ester oligomers from cork suberin. *Chem. Phys. Lipids* **144**, 96–107.
- Graça, J., and Santos, S.** (2006b). Linear aliphatic dimeric esters from cork suberin. *Biomacromolecules* **7**, 2003–2010.
- Graça, J., and Santos, S.** (2007). Suberin: A biopolyester of plants' skin. *Macromol. Biosci.* **7**, 128–135. **Review**
- Graham, I.A.** (2008). Seed storage oil mobilization. *Ann. Rev. Plant Biol.* **59**, 115–142. **Review**
- Graham, I.A., and Eastmond, P.J.** (2002). Pathways of straight and branched chain fatty acid catabolism in higher plants. *Prog. Lipid Res.* **41**, 156–181. **Review**
- Greer, S., Wen, M., Bird, D., Wu, X.M., Samuels, L., Kunst, L., and Jetter, R.** (2007). The cytochrome p450 enzyme CYP96A15 is the mid-chain alkane hydroxylase responsible for formation of secondary alcohols and ketones in stem cuticular wax of Arabidopsis. *Plant Physiol.* **145**, 653–667.
- Griebau, R., and Frentzen, M.** (1994). Biosynthesis of phosphatidylglycerol in isolated mitochondria of etiolated mung bean (*Vigna radiata* L.) seedlings. *Plant Physiol.* **105**, 1269–1274.
- Griesbeck, O., Baird, G.S., Campbell, R.E., Zacharias, D.A., and Tsien, R.Y.** (2001). Reducing the environmental sensitivity of yellow fluorescent protein Mechanism and applications. *J. Biol. Chem.* **276**, 29188–29194.
- Gueguen, V., Macherel, D., Jaquinod, M., Douce, R., and Bourguignon, J.** (2000). Fatty acid and lipoic acid biosynthesis in higher plant mitochondria. *J. Biol. Chem.* **275**, 5016–5025.
- Hagio, M., Sakurai, I., Sato, S., Kato, T., Tabata, S., and Wada, H.** (2002). Phosphatidylglycerol is essential for the development of thylakoid membranes in *Arabidopsis thaliana*. *Plant Cell Physiol.* **43**, 1456–1464.
- Hammond, L.E., Gallagher, P.A., Wang, S., Hiller, S., Kluckman, K.D., Posey-Marcos, E.L., Maeda, N., and Coleman, R.A.** (2002). Mitochondrial glycerol-3-phosphate acyltransferase-deficient mice have reduced weight and liver triacylglycerol content and altered glycerolipid fatty acid composition. *Mol. Cell Biol.* **22**, 8204–8214.
- Han, G., Gupta, S.D., Gable, K., Niranjanakumari, S., Moitra, P.,**

- Eichler, F., Brown, R.H., Harmon, J.M., and Dunn, T.M.** (2009). Identification of small subunits of mammalian serine palmitoyltransferase that confer distinct acyl-CoA substrate specificities. *Proc. Natl. Acad. Sci. USA* **106**, 8186–8191.
- Han, G.S., Wu, W.L., and Carman, G.M.** (2006). The *Saccharomyces cerevisiae* lipin homolog is a Mg²⁺-dependent phosphatidate phosphatase enzyme. *J. Biol. Chem.* **281**, 9210–9218.
- Hara, A., and Radin, N.S.** (1978). Lipid extraction of tissues with a lowtoxicity solvent. *Anal. Biochem.* **90**, 420–426.
- Harris, N., Spence, J., and Oparka, K.J.** (1994). General and enzyme histochemistry. In *Plant Cell Biology: A Practical Approach*, N. Harris and K. J. Oparka, eds (Oxford University Press), pp. 51–68.
- Härtel, H., Dormann, P., and Benning, C.** (2000). DGD1-independent biosynthesis of extraplasmidic galactolipids after phosphate deprivation in *Arabidopsis*. *Proc. Natl. Acad. Sci. USA* **97**, 10649–10654.
- Harwood, J.L.** (1996). Recent advances in the biosynthesis of plant fatty acids. *Biochim. Biophys. Acta, Lipids Lipid Metab.* **1301**, 7–56. **Review**
- Hayashi, H., De Bellis, L., Ciurli, A., Kondo, M., Hayashi, M., and Nishimura, R.** (1999). A novel acyl-CoA oxidase that can oxidize short-chain acyl-CoA in plant peroxisomes. *J. Biol. Chem.* **274**, 12715–12721.
- Hayashi, M., Nito, K., Takei-Hoshi, R., Yagi, M., Kondo, M., Suenaga, A., Yamaya, T., and Nishimura, M.** (2002). Ped3p is a peroxisomal ATP-binding cassette transporter that might supply substrates for fatty acid beta-oxidation. *Plant Cell Physiol.* **43**, 1–11.
- He, Y.H., and Gan, S.S.** (2002). A gene encoding an acyl hydrolase is involved in leaf senescence in *Arabidopsis*. *Plant Cell* **14**, 805–815.
- Heazlewood, J.L., Howell, K.A., Whelan, J., and Millar, A.H.** (2003). Towards an analysis of the rice mitochondrial proteome. *Plant Physiol.* **132**, 230–242.
- Heemskerk, J.W., Bogemann, G., Helsper, J.P., and Wintermans, J.F.** (1988). Synthesis of mono- and digalactosyldiacylglycerol in isolated spinach chloroplasts. *Plant Physiol.* **86**, 971–977.
- Heilmann, I., Pidkowich, M.S., Girke, T., and Shanklin, J.** (2004). Switching desaturase enzyme specificity by alternate subcellular targeting. *Proc. Natl. Acad. Sci. USA* **101**, 10266–10271.
- Höfer, R., Briesen, I., Beck, M., Pinot, F., Schreiber, L., and Franke, R.** (2008). The *Arabidopsis* cytochrome P450 CYP86A1 encodes a fatty acid omega-hydroxylase involved in suberin monomer biosynthesis. *J. Exp. Bot.* **59**, 2347–2360.
- Hooker, T.S., Lam, P., Zheng, H.Q., and Kunst, L.** (2007). A core subunit of the RNA-processing/degrading exosome specifically influences cuticular wax biosynthesis in *Arabidopsis*. *Plant Cell* **19**, 904–913.
- Hooks, M.A., Kellas, F., and Graham, I.A.** (1999). Long-chain acyl-CoA oxidases of *Arabidopsis*. *Plant J.* **20**, 1–13.
- Hopwood, D.** (1972). Theoretical and practical aspects of glutaraldehyde fixation. *Histochem. J.* **4**, 267–303.
- Hsieh, K., and Huang, A.H.C.** (2004). Endoplasmic reticulum, oleosins, and oils in seeds and tapetum cells. *Plant Physiol.* **136**, 3427–3434. **Review**
- Hsieh, T.C., Kaul, K., Laine, R.A., and Lester, R.L.** (1978). Structure of a major glycoposphoceramide from tobacco leaves, PSL-I: 2-deoxy-2-acetamido-D-glucopyranosyl(alpha1 leads to 4)-D-glucuronopyranosyl(alpha1 leads to 2)myoinositol-1-O-phosphoceramide. *Biochemistry* **17**, 3575–3581.
- Huang, A.** (1993). Lipases. In *Lipid Metabolism in Plants* (Boca Raton, FL: CRC Press), pp. 473–503. **Review**
- Huang, A.H.C.** (1992). Oil bodies and oleosins in seeds. *Annu. Rev. Plant Phys.* **43**, 177–200.
- Imai, H., Morimoto, Y., and Tamura, K.** (2000). Sphingoid base composition of monoglucosylceramide in Brassicaceae. *J. Plant Physiol.* **157**, 453–456.
- Imai, H., Ohnishi, M., Kinoshita, M., Kojima, M., and Ito, S.** (1995). Structure and distribution of cerebroside containing unsaturated hydroxy fatty-acids in plant-leaves. *Biosci. Biotechnol. Biochem.* **59**, 1309–1313.
- Inatsugi, R., Nakamura, M., and Nishida, I.** (2002). Phosphatidylcholine biosynthesis at low temperature: Differential expression of CTP:phosphorylcholine cytidyltransferase isogenes in *Arabidopsis thaliana*. *Plant Cell Physiol.* **43**, 1342–1350.
- Ishiguro, S., Kawai-Oda, A., Ueda, J., Nishida, I., and Okada, K.** (2001). The DEFECTIVE IN ANther DEHISCENCE1 gene encodes a novel phospholipase A1 catalyzing the initial step of jasmonic acid biosynthesis, which synchronizes pollen maturation, anther dehiscence, and flower opening in *Arabidopsis*. *Plant Cell* **13**, 2191–2209.
- Ishizaki, K., Larson, T.R., Schauer, N., Fernie, A.R., Graham, I.A., and Leaver, C.J.** (2005). The critical role of *Arabidopsis* electron-transfer flavoprotein: Ubiquinone oxidoreductase during dark-induced starvation. *Plant Cell* **17**, 2587–2600.
- Jackson, D.** (2002). Imaging of fresh *Arabidopsis* tissue in the SEM. In *Arabidopsis: A Laboratory Manual*, D. Weigel and J. Glazebrook, eds (Cold Spring Harbor, NY: Cold Spring Harbor Laboratory Press), pp. xii, 354 pp 195–203.
- Jako, P., Kumar, A., Wei, Y., Zou, J., Barton, D.L., Giblin, E.M., Covello, P.S., and Taylor, D.C.** (2001). Seed-specific over-expression of an *Arabidopsis* cDNA encoding a diacylglycerol acyltransferase enhances seed oil content and seed weight. *Plant Physiol.* **126**, 861–874.
- Jenks, M.A., Tuttle, H.A., Eigenbrode, S.D., and Feldmann, K.A.** (1995). Leaf epicuticular waxes of the eceriferum mutants in *Arabidopsis*. *Plant Physiol.* **108**, 369–377.
- Jetter, R., Kunst, L., and Samuels, A.L.** (2006). Composition of plant cuticular waxes. In *Biology of the Plant Cuticle*, M. Riederer and C. Müller, eds (Oxford, England; and Ames, IA: Blackwell), pp. 145–175. **Review**
- Johnston, M.L., Luethy, M.H., Miernyk, J.A., and Randall, D.D.** (1997). Cloning and molecular analyses of the *Arabidopsis thaliana* plastid pyruvate dehydrogenase subunits. *Biochim. Biophys. Acta, Bioenerg.* **1321**, 200–206.
- Jolivet, P., Roux, E., d'Andrea, S., Davanture, M., Negroni, L., Zivy, M., and Chardot, T.** (2004). Protein composition of oil bodies in *Arabidopsis thaliana* ecotype WS. *Plant Physiol. Biochem.* **42**, 501–509.
- Jordan, P., Fromme, P., Witt, H.T., Klukas, O., Saenger, W., and Krauss, N.** (2001). Three-dimensional structure of cyanobacterial photosystem I at 2.5 angstrom resolution. *Nature* **411**, 909–917.
- Joubes, J., Raffaele, S., Bourdenx, B., Garcia, C., Laroche-Traineau, J., Moreau, P., Domergue, F., and Lessire, R.** (2008). The VLCFA elongase gene family in *Arabidopsis thaliana*: Phylogenetic analysis, 3D modelling and expression profiling. *Plant Mol. Biol.* **67**, 547–566.
- Jouhet, J., Marechal, E., Baldan, B., Bligny, R., Joyard, J., and Block, M.A.** (2004). Phosphate deprivation induces transfer of DGDG galactolipid from chloroplast to mitochondria. *J. Cell Biol.* **167**, 863–874.
- Jouhet, J., Marechal, E., and Block, M.A.** (2007). Glycerolipid transfer for the building of membranes in plant cells. *Prog. Lipid Res.* **46**, 37–55. **Review**
- Justin, A.M., Kader, J.C., and Collin, S.** (2002). Phosphatidylinositol synthesis and exchange of the inositol head are catalysed by the single phosphatidylinositol synthase 1 from *Arabidopsis*. *Eur. J. Biochem.* **269**, 2347–2352.
- Kandel, S., Sauveplane, V., Compagnon, V., Franke, R., Millet, Y., Schreiber, L., Werck-Reichhart, D., and Pinot, F.** (2007). Characterization of a methyl jasmonate and wounding-responsive cytochrome P450 of *Arabidopsis thaliana* catalyzing dicarboxylic fatty acid formation in vitro. *FEBS J.* **274**, 5116–5127.
- Kandel, S., Sauveplane, V., Olry, A., Diss, L., Benveniste, I., and Pinot, F.** (2006). Cytochrome P450-dependent fatty acids hydroxylases in plants. *Phytochem. Rev.* **5**, 359–372.
- Kannangara, R., Branigan, C., Liu, Y., Penfield, T., Rao, V., Mouille, G.,**

- Hofte, H., Pauly, M., Riechmann, J.L., and Broun, P.** (2007). The transcription factor WIN1/SHN1 regulates cutin biosynthesis in *Arabidopsis thaliana*. *Plant Cell* **19**, 1278–1294.
- Karlsson, M., Contreras, J.A., Hellman, U., Tornqvist, H., and Holm, C.** (1997). cDNA cloning, tissue distribution, and identification of the catalytic triad of monoglyceride lipase Evolutionary relationship to esterases, lysophospholipases, and haloperoxidases. *J. Biol. Chem.* **272**, 27218–27223.
- Katagiri, T., Ishiyama, K., Kato, T., Tabata, S., Kobayashi, M., and Shinozaki, K.** (2005). An important role of phosphatidic acid in ABA signaling during germination in *Arabidopsis thaliana*. *Plant J.* **43**, 107–117.
- Katavic, V., Reed, D.W., Taylor, D.C., Giblin, E.M., Barton, D.L., Zou, J., Mackenzie, S.L., Covello, P.S., and Kunst, L.** (1995). Alteration of seed fatty acid composition by an ethyl methanesulfonate-induced mutation in *Arabidopsis thaliana* affecting diacylglycerol acyltransferase activity. *Plant Physiol.* **108**, 399–409.
- Katayama, K., Sakurai, I., and Wada, H.** (2004). Identification of an *Arabidopsis thaliana* gene for cardiolipin synthase located in mitochondria. *FEBS Lett.* **577**, 193–198.
- Kates, M., and Eberhardt, F.M.** (1957). Isolation and fractionation of leaf phosphatides. *Can. J. Bot.* **35**, 895–905.
- Kaul, K., and Lester, R.L.** (1975). Characterization of inositol-containing phosphosphingolipids from tobacco leaves: Isolation and identification of two novel, major lipids: N-acetylglucosamidoglucuronidoinositol phosphorylceramide and glucosamidoglucuronidoinositol phosphorylceramide. *Plant Physiol.* **55**, 120–129.
- Kaul, K., and Lester, R.L.** (1978). Isolation of 6 novel phosphoinositol-containing sphingolipids from tobacco-leaves. *Biochemistry* **17**, 3569–3575.
- Kaup, M.T., Froese, C.D., and Thompson, J.E.** (2002). A role for diacylglycerol acyltransferase during leaf senescence. *Plant Physiol.* **129**, 1616–1626.
- Kawaguchi, A., Yoshimura, T., and Okuda, S.** (1981). A new method for the preparation of acyl-CoA thioesters. *J. Biochem.* **89**, 337–339.
- Kelly, A.A., and Dörmann, P.** (2002). DGD2, an *Arabidopsis* gene encoding a UDP-galactose-dependent digalactosyldiacylglycerol synthase is expressed during growth under phosphate-limiting conditions. *J. Biol. Chem.* **277**, 1166–1173.
- Kelly, A.A., and Dörmann, P.** (2004). Green light for galactolipid trafficking. *Curr. Opin. Plant Biol.* **7**, 262–269. **Review**
- Kelly, A.A., Froehlich, J.E., and Dörmann, P.** (2003). Disruption of the two digalactosyldiacylglycerol synthase genes DGD1 and DGD2 in *Arabidopsis* reveals the existence of an additional enzyme of galactolipid synthesis. *Plant Cell* **15**, 2694–2706.
- Keogh, M.R., Courtney, P.D., Kinney, A.J., and Dewey, R.E.** (2009). Functional characterization of phospholipid N-methyltransferases from *Arabidopsis* and soybean. *J. Biol. Chem.* **284**, 15439–15447.
- Khan, M.U., and Williams, J.P.** (1977). Improved thin-layer chromatographic method for the separation of major phospholipids and glycolipids from plant lipid extracts and phosphatidyl glycerol and bis(monoacylglyceryl) phosphate from animal lipid extracts. *J. Chromatogr.* **140**, 178–185.
- Khor, H.T., and Chan, S.L.** (1985). Comparative studies of three solvent mixtures for the extraction of soybean lipids. *J. Am. Oil Chem. Soc.* **62**, 98–99.
- Kim, H.U., Hsieh, K., Ratnayake, C., and Huang, A.H.C.** (2002). A novel group of oleosins is present inside the pollen of *Arabidopsis*. *J. Biol. Chem.* **277**, 22677–22684.
- Kim, H.U., and Huang, A.H.C.** (2004). Plastid lysophosphatidyl acyltransferase is essential for embryo development in *Arabidopsis*. *Plant Physiol.* **134**, 1206–1216.
- Kim, H.U., Li, Y.B., and Huang, A.H.C.** (2005). Ubiquitous and endoplasmic reticulum-located lysophosphatidyl acyltransferase, LPAT2, is essential for female but not male gametophyte development in *Arabidopsis*. *Plant Cell* **17**, 1073–1089.
- Kim, Y., and Oliver, D.J.** (1990). Molecular cloning, transcriptional characterization, and sequencing of cDNA encoding the H-protein of the mitochondrial glycine decarboxylase complex in peas. *J. Biol. Chem.* **265**, 848–853.
- Kjellberg, J.M., Trimborn, M., Andersson, M., and Sandelius, A.S.** (2000). Acyl-CoA dependent acylation of phospholipids in the chloroplast envelope. *Biochim. Biophys. Acta* **1485**, 100–110.
- Klaus, D., Hartel, H., Fitzpatrick, L.M., Froehlich, J.E., Hubert, J., Benning, C., and Dormann, P.** (2002). Digalactosyldiacylglycerol synthesis in chloroplasts of the *Arabidopsis* *dgd1* mutant. *Plant Physiol.* **128**, 885–895.
- Kobayashi, K., Awai, K., Nakamura, M., Nagatani, A., Masuda, T., and Ohta, H.** (2009). Type-B monogalactosyldiacylglycerol synthases are involved in phosphate starvation-induced lipid remodeling, and are crucial for low-phosphate adaptation. *Plant J.* **57**, 322–331.
- Kobayashi, K., Awai, K., Takamiya, K., and Ohta, H.** (2004). *Arabidopsis* type B monogalactosyldiacylglycerol synthase genes are expressed during pollen tube growth and induced by phosphate starvation. *Plant Physiol.* **134**, 640–648.
- Kolattukudy, P.E.** (2001a). Polyesters in higher plants. In *Advances in Biochemical Engineering/Biotechnology*, Vol. 71, Biopolyesters, W. Babel and A. Steinbuschel, eds (Berlin: Springer), pp. 1–49. **Review**
- Kolattukudy, P.E.** (2001b). Suberin from plants. In *Biopolymers*, Vol. 3A, Polyesters I Biological Systems and Biotechnological Production, Y. Doi and A. Steinbüchel, eds (Weinheim, Germany; Chichester, England: Wiley-VCH), pp. 41–68. **Review**
- König, S., Hoffmann, M., Mosblech, A., and Heilmann, I.** (2008). Determination of content and fatty acid composition of unlabeled phosphoinositide species by thin-layer chromatography and gas chromatography. *Anal. Biochem.* **378**, 197–201.
- Konishi, T., Shinohara, K., Yamada, K., and Sasaki, Y.** (1996). Acetyl-CoA carboxylase in higher plants: Most plants other than gramineae have both the prokaryotic and the eukaryotic forms of this enzyme. *Plant Cell Physiol.* **37**, 117–122.
- Koo, A.J.K., Ohlrogge, J.B., and Pollard, M.** (2004). On the export of fatty acids from the chloroplast. *J. Biol. Chem.* **279**, 16101–16110.
- Kopka, J., Ludewig, M., and MullerRober, B.** (1997). Complementary DNAs encoding eukaryotic-type cytidine-5'-diphosphate-diacylglycerol synthases of two plant species. *Plant Physiol.* **113**, 997–1002.
- Kormann, B., Currie, E., Collins, S.R., Schuldiner, M., Nunnari, J., Weissman, J.S., and Walter, P.** (2009). An ER-mitochondria tethering complex revealed by a synthetic biology screen. *Science* **325**, 477–481.
- Kosma, D.K., Bourdenx, B., Bernard, A., Parsons, E.P., Lu, S., Joubes, J., and Jenks, M.A.** (2009). The impact of water deficiency on leaf cuticle lipids of *Arabidopsis*. *Plant Physiol.* **151**, 1918–1929.
- Kroll, D., Meierhoff, K., Bechtold, N., Kinoshita, M., Westphal, S., Vothknecht, U.C., Soll, J., and Westhoff, P.** (2001). VIPP1, a nuclear gene of *Arabidopsis thaliana* essential for thylakoid membrane formation. *Proc. Natl. Acad. Sci. USA* **98**, 4238–4242.
- Kuge, O., and Nishijima, M.** (2003). Biosynthetic regulation and intracellular transport of phosphatidylserine in mammalian cells. *J. Biochem.* **133**, 397–403.
- Kunst, L., Browse, J., and Somerville, C.** (1988). Altered regulation of lipid biosynthesis in a mutant of *Arabidopsis* deficient in chloroplast glycerol-3-phosphate acyltransferase activity. *Proc. Natl. Acad. Sci. USA* **85**, 4143–4147.
- Kunst, L., and Samuels, A.L.** (2003). Biosynthesis and secretion of plant cuticular wax. *Prog. Lipid Res.* **42**, 51–80. **Review**
- Kurdyukov, S., Faust, A., Nawrath, C., Bar, S., Voisin, D., Efremova, N., Franke, R., Schreiber, L., Saedler, H., Metraux, J.P., and Yephremov, A.**

- (2006a). The epidermis-specific extracellular BODYGUARD controls cuticle development and morphogenesis in Arabidopsis. *Plant Cell* **18**, 321–339.
- Kurdyukov, S., Faust, A., Trenkamp, S., Bar, S., Franke, R., Efremova, N., Tietjen, K., Schreiber, L., Saedler, H., and Yephremov, A.** (2006b). Genetic and biochemical evidence for involvement of HOTHEAD in the biosynthesis of long-chain alpha-,omega-dicarboxylic fatty acids and formation of extracellular matrix. *Planta* **224**, 315–329.
- Lai, C., Kunst, L., and Jetter, R.** (2007). Composition of alkyl esters in the cuticular wax on inflorescence stems of *Arabidopsis thaliana* cer mutants. *Plant J.* **50**, 189–196.
- Lardizabal, K.D., Mai, J.T., Wagner, N.W., Wyrick, A., Voelker, T., and Hawkins, D.J.** (2001). DGAT2 is a new diacylglycerol acyltransferase gene family Purification, cloning, and expression in insect cells of two polypeptides from *Mortierella ramanniana* with diacylglycerol acyltransferase activity. *J. Biol. Chem.* **276**, 38862–38869.
- Larson, T.R., and Graham, I.A.** (2001). A novel technique for the sensitive quantification of acyl CoA esters from plant tissues. *Plant J.* **25**, 115–125.
- Lee, S.B., Go, Y.S., Bae, H.J., Park, J.H., Cho, S.H., Cho, H.J., Lee, D.S., Park, O.K., Hwang, I., and Suh, M.C.** (2009). Disruption of glycosylphosphatidylinositol-anchored lipid transfer protein gene altered cuticular lipid composition, increased plastoglobules, and enhanced susceptibility to infection by the fungal pathogen *Alternaria brassicicola*. *Plant Physiol.* **150**, 42–54.
- Leung, K.C., Li, H.Y., Xiao, S., Tse, M.H., and Chye, M.L.** (2006). Arabidopsis ACBP3 is an extracellularly targeted acyl-CoA-binding protein. *Planta* **223**, 871–881.
- Levine, T.** (2004). Short-range intracellular trafficking of small molecules across endoplasmic reticulum junctions. *Trends Cell Biol.* **14**, 483–490. **Review**
- Levine, T., and Loewen, C.** (2006). Inter-organelle membrane contact sites: Through a glass, darkly. *Curr. Opin. Cell Biol.* **18**, 371–378. **Review**
- Li, F., Wu, X., Lam, P., Bird, D., Zheng, H., Samuels, L., Jetter, R., and Kunst, L.** (2008). Identification of the wax ester synthase/acyl-coenzyme A:diacylglycerol acyltransferase WSD1 required for stem wax ester biosynthesis in Arabidopsis. *Plant Physiol.* **148**, 97–107.
- Li, M.Y., Welti, R., and Wang, X.M.** (2006). Quantitative profiling of Arabidopsis polar glycerolipids in response to phosphorus starvation: Roles of phospholipases D zeta 1 and D zeta 2 in phosphatidylcholine hydrolysis and digalactosyldiacylglycerol accumulation in phosphorus-starved plants. *Plant Physiol.* **142**, 750–761.
- Li, W., Wang, R., Li, M., Li, L., Wang, C., Welti, R., and Wang, X.** (2008). Differential degradation of extraplastidic and plastidic lipids during freezing and post-freezing recovery in *Arabidopsis thaliana*. *J. Biol. Chem.* **283**, 461–468.
- Li, X.W., and Evans, J.J.** (2005). Examining the collision-induced decomposition spectra of ammoniated triglycerides as a function of fatty acid chain length and degree of unsaturation: I. The OXO/YOY series. *Rapid Commun. Mass Spectrom.* **19**, 2528–2538.
- Li, Y.H., Beisson, F., Koo, A.J.K., Molina, I., Pollard, M., and Ohlrogge, J.** (2007a). Identification of acyltransferases required for cutin biosynthesis and production of cutin with suberin-like monomers. *Proc. Natl. Acad. Sci. USA* **104**, 18339–18344.
- Li, Y.H., Beisson, F., Ohlrogge, J., and Pollard, M.** (2007b). Monoacylglycerols are components of root waxes and can be produced in the aerial cuticle by ectopic expression of a suberin-associated acyltransferase. *Plant Physiol.* **144**, 1267–1277.
- Li, Y., Beisson, F., Pollard, M., and Ohlrogge, J.** (2006). Oil content of Arabidopsis seeds: The influence of seed anatomy, light and plant-to-plant variation. *Phytochemistry* **67**, 904–915.
- Li-Beisson, Y., Pollard, M., Sauveplane, V., Pinot, F., Ohlrogge, J., and Beisson, F.** (2009). Nanoridges that characterize the surface morphology of flowers require the synthesis of cutin polyester. *Proc. Natl. Acad. Sci. USA* **106**, 22008–22013.
- Liang, H., Yao, N., Song, L.T., Luo, S., Lu, H., and Greenberg, L.T.** (2003). Ceramides modulate programmed cell death in plants. *Genes Dev.* **17**, 2636–2641.
- Lin, L.J., Tai, S.S.K., Peng, C.C., and Tzen, J.T.C.** (2002). Steroleosin, a sterol-binding dehydrogenase in seed oil bodies. *Plant Physiol.* **128**, 1200–1211.
- Lin, M., Behal, R., and Oliver, D.J.** (2003). Disruption of pLE2, the gene for the E2 subunit of the plastid pyruvate dehydrogenase complex, in Arabidopsis causes an early embryo lethal phenotype. *Plant Mol. Biol.* **52**, 865–872.
- Lin, M., and Oliver, D.J.** (2008). The role of acetyl-coenzyme a synthetase in Arabidopsis. *Plant Physiol.* **147**, 1822–1829.
- Lin, W.L., and Oliver, D.J.** (2008). Role of triacylglycerols in leaves. *Plant Sci.* **175**, 233–237.
- Lindén, D., William-Olsson, L., Ahnmark, A., Ekroos, K., Hallberg, C., Sjögren, H.P., Becker, B., Svensson, L., Clapham, J.C., Oscarsson, J., and Schreyer, S.** (2006). Liver-directed overexpression of mitochondrial glycerol-3-phosphate acyltransferase results in hepatic steatosis, increased triacylglycerol secretion and reduced fatty acid oxidation. *FASEB J.* **20**, 434–443.
- Löffke, C., Ischebeck, T., Konig, S., Freitag, S., and Heilviann, I.** (2008). Alternative metabolic fates of phosphatidylinositol produced by phosphatidylinositol synthase isoforms in *Arabidopsis thaliana*. *Biochem. J.* **413**, 115–124.
- Logan, D.C.** (2006). The mitochondrial compartment. *J. Exp. Bot.* **57**, 1225–1243. **Review**
- Loll, B., Kern, J., Saenger, W., Zouni, A., and Biesiadka, J.** (2005). Towards complete cofactor arrangement in the 3.0 angstrom resolution structure of photosystem II. *Nature* **438**, 1040–1044.
- Loll, B., Kern, J., Saenger, W., Zouni, A., and Biesiadka, J.** (2007). Lipids in photosystem II: Interactions with protein and cofactors. *Biochim. Biophys. Acta, Bioenerg.* **1767**, 509–519.
- López-Lara, I.M., and Geiger, O.** (2001). Novel pathway for phosphatidylcholine biosynthesis in bacteria associated with eukaryotes. *J. Biotechnol.* **91**, 211–221.
- Lu, B.B., Xu, C.C., Awai, K., Jones, A.D., and Benning, C.** (2007). A small ATPase protein of Arabidopsis, TGD3, involved in chloroplast lipid import. *J. Biol. Chem.* **282**, 35945–35953.
- Lu, C., Xin, Z., Ren, Z., Miquel, M., and Browse, J.** (2009). An enzyme regulating triacylglycerol composition is encoded by the ROD1 gene of Arabidopsis. *Proc. Natl. Acad. Sci. USA* **106**, 18837–18842.
- Lu, S.Y., Song, T., Kosma, D.K., Parsons, E.P., Rowland, O., and Jenks, M.A.** (2009). Arabidopsis CER8 encodes LONG-CHAIN ACYL-COA SYNTHETASE 1 (LACS1) that has overlapping functions with LACS2 in plant wax and cutin synthesis. *Plant J.* **59**, 553–564.
- Luo, B., Xue, X.Y., Hu, W.L., Wang, L.J., and Chen, X.Y.** (2007). An ABC transporter gene of *Arabidopsis thaliana*, AtWBC11, is involved in cuticle development and prevention of organ fusion. *Plant Cell Physiol.* **48**, 1790–1802.
- Lynch, D.V.** (2000). Enzymes of sphingolipid metabolism in plants. *Methods Enzymol.* **311**, 130–149.
- Macher, B.A., and Mudd, J.B.** (1976). Partial purification and properties of ethanolamine kinase from spinach leaf. *Arch. Biochem. Biophys.* **177**, 24–30.
- Macherel, D., Lebrun, M., Gagnon, J., Neuburger, M., and Douce, R.** (1990). cDNA cloning, primary structure and gene expression for H-protein, a component of the glycine-cleavage system (glycine decarboxylase) of pea (*Pisum sativum*) leaf mitochondria. *Biochem. J.* **268**, 783–789.

- Maeda, H., Sage, T.L., Isaac, G., Welti, R., and DellaPenna, D.** (2008). Tocopherols modulate extraplastidic polyunsaturated fatty acid metabolism in *Arabidopsis* at low temperature. *Plant Cell* **20**, 452–470.
- Mancha, M., Stokes, G.B., and Stumpf, P.K.** (1975). Fat metabolism in higher plants: The determination of acyl-acyl carrier protein and acyl coenzyme A in a complex lipid mixture 1,2. *Anal. Biochem.* **68**, 600–608.
- Markham, J.E., and Jaworski, J.G.** (2007). Rapid measurement of sphingolipids from *Arabidopsis thaliana* by reversed-phase high-performance liquid chromatography coupled to electrospray ionization tandem mass spectrometry. *Rapid Commun. Mass Spectrom.* **21**, 1304–1314.
- Markham, J.E., Li, J., Cahoon, E.B., and Jaworski, J.G.** (2006). Separation and identification of major plant sphingolipid classes from leaves. *J. Biol. Chem.* **281**, 22684–22694.
- Marquardt, T.C., and Wilson, R.F.** (1998). An improved reversed-phase thin-layer chromatography method for separation of fatty acid methyl esters. *J. Am. Oil Chem. Soc.* **75**, 1889–1892.
- Mekhedov, S., de Ilarduya, O.M., and Ohlrogge, J.** (2000). Toward a functional catalog of the plant genome: A survey of genes for lipid biosynthesis. *Plant Physiol.* **122**, 389–402.
- Mentzen, W.I., Peng, J.L., Ransom, N., Nikolau, B.J., and Wurtele, E.S.** (2008). Articulation of three core metabolic processes in *Arabidopsis*: Fatty acid biosynthesis, leucine catabolism and starch metabolism. *BMC Plant Biol.* **8**.
- Meyer, E.H., Heazlewood, J.L., and Millar, A.H.** (2007). Mitochondrial acyl carrier proteins in *Arabidopsis thaliana* are predominantly soluble matrix proteins and none can be confirmed as subunits of respiratory Complex I. *Plant Mol. Biol.* **64**, 319–327.
- Mhaske, V., Beldjilali, K., Ohlrogge, J., and Pollard, M.** (2005). Isolation and characterization of an *Arabidopsis thaliana* knockout line for phospholipid:diacylglycerol transacylase gene (At5g13640). *Plant Physiol. Biochem.* **43**, 413–417.
- Michaelson, L.V., Zauner, S., Markham, J.E., Haslam, R.P., Desikan, R., Mugford, S., Albrecht, S., Warnecke, D., Sperling, P., Heinz, E., and Napier, J.A.** (2009). Functional characterization of a higher plant sphingolipid Delta4-desaturase: Defining the role of sphingosine and sphingosine-1-phosphate in *Arabidopsis*. *Plant Physiol.* **149**, 487–498.
- Millar, A.A., Clemens, S., Zachgo, S., Giblin, E.M., Taylor, D.C., and Kunst, L.** (1999). CUT1, an *Arabidopsis* gene required for cuticular wax biosynthesis and pollen fertility, encodes a very-long-chain fatty acid condensing enzyme. *Plant Cell* **11**, 825–838.
- Millar, A.A., and Kunst, L.** (1997). Very-long-chain fatty acid biosynthesis is controlled through the expression and specificity of the condensing enzyme. *Plant J.* **12**, 121–131.
- Min, K.M., Bae, Y.G., Lee, J.S., Choi, Y.H., Cha, Y.R., and Cho, S.H.** (1997). Cloning of an aminoalcoholphosphotransferase cDNA from Chinese cabbage roots. *J. Plant Biol.* **40**, 234–239.
- Miquel, M., and Browse, J.** (1992). *Arabidopsis* mutants deficient in polyunsaturated fatty acid synthesis: Biochemical and genetic characterization of a plant oleoyl-phosphatidylcholine desaturase. *J. Biol. Chem.* **267**, 1502–1509.
- Mizoi, J., Nakamura, M., and Nishida, I.** (2006). Defects in CTP:PHOSPHORYLETHANOLAMINE CYTIDYLTRANSFERASE affect embryonic and postembryonic development in *Arabidopsis*. *Plant Cell* **18**, 3370–3385.
- Molina, I., Bonaventure, G., Ohlrogge, J., and Pollard, M.** (2006). The lipid polyester composition of *Arabidopsis thaliana* and *Brassica napus* seeds. *Phytochemistry* **67**, 2597–2610.
- Molina, I., Li-Beisson, Y., Beisson, F., Ohlrogge, J.B., and Pollard, M.** (2009). Identification of an *Arabidopsis* feruloyl-coenzyme a transferase required for suberin synthesis. *Plant Physiol.* **151**, 1317–1328.
- Molina, I., Ohlrogge, J.B., and Pollard, M.** (2008). Deposition and localization of lipid polyester in developing seeds of *Brassica napus* and *Arabidopsis thaliana*. *Plant J.* **55**, 437–449.
- Monks, D.E., Goode, J.H., and Dewey, R.E.** (1996). Characterization of soybean choline kinase cDNAs and their expression in yeast and *Escherichia coli*. *Plant Physiol.* **110**, 1197–1205.
- Moreau, P., Bessoule, J.J., Mongrand, S., Testet, E., Vincent, P., and Cassagne, C.** (1998). Lipid trafficking in plant cells. *Prog. Lipid Res.* **37**, 371–391. **Review**
- Moreau, R.A., Doehlert, D.C., Welti, R., Isaac, G., Roth, M., Tamura, P., and Nunez, A.** (2008). The identification of mono-, di-, tri-, and tetragalactosyl-diacylglycerols and their natural estolides in oat kernels. *Lipids* **43**, 533–548.
- Mou, Z.L., He, Y.K., Dai, Y., Liu, X.F., and Li, J.Y.** (2000). Deficiency in fatty acid synthase leads to premature cell death and dramatic alterations in plant morphology. *Plant Cell* **12**, 405–417.
- Mou, Z.L., Wang, X.Q., Fu, Z.M., Dai, Y., Han, C., Ouyang, J., Bao, F., Hu, Y.X., and Li, J.Y.** (2002). Silencing of phosphoethanolamine N-methyltransferase results in temperature-sensitive male sterility and salt hypersensitivity in *Arabidopsis*. *Plant Cell* **14**, 2031–2043.
- Mu, J., Tan, H., Zheng, Q., Fu, F., Liang, Y., Zhang, J., Yang, X., Wang, T., Chong, K., Wang, X., and Zuo, J.** (2008). LEAFY COTYLEDON1 is a key regulator of fatty acid biosynthesis in *Arabidopsis*. *Plant Physiol.* **148**, 1042–1054.
- Mukherjee, K.D.** (1994). Plant lipases and their application in lipid biotransformations. *Prog. Lipid Res.* **33**, 165–174. **Review**
- Müller, F., and Frentzen, M.** (2001). Phosphatidylglycerophosphate synthases from *Arabidopsis thaliana*. *FEBS Lett.* **509**, 298–302.
- Nagai, T., Iбата, K., Park, E.S., Kubota, M., Mikoshiba, K., and Miyawaki, A.** (2002). A variant of yellow fluorescent protein with fast and efficient maturation for cell-biological applications. *Nature Biotechnol.* **20**, 87–90.
- Nagiec, M.M., Wells, G.B., Lester, R.L., and Dickson, R.C.** (1993). A suppressor gene that enables *Saccharomyces cerevisiae* to grow without making sphingolipids encodes a protein that resembles an *Escherichia coli* fatty acyltransferase. *J. Biol. Chem.* **268**, 22156–22163.
- Nakamura, Y., Koizumi, R., Shui, G., Shimojima, M., Wenk, M.R., Ito, T., and Ohta, H.** (2009). *Arabidopsis* lipins mediate eukaryotic pathway of lipid metabolism and cope critically with phosphate starvation. *Proc. Natl. Acad. Sci. USA* **106**, 20978–20983.
- Nakamura, Y., Tsuchiya, M., and Ohta, H.** (2007). Plastidic phosphatidic acid phosphatases identified in a distinct subfamily of lipid phosphate phosphatases with prokaryotic origin. *J. Biol. Chem.* **282**, 29013–29021.
- Nandi, A., Krothapalli, K., Buseman, C.M., Li, M.Y., Welti, R., Enyedi, A., and Shah, J.** (2003). *Arabidopsis* *sfd* mutants affect plastidic lipid composition and suppress dwarfing, cell death, and the enhanced disease resistance phenotypes resulting from the deficiency of a fatty acid desaturase. *Plant Cell* **15**, 2383–2398.
- Nawrath, C.** (2006). Unraveling the complex network of cuticular structure and function. *Curr. Opin. Plant Biol.* **9**, 281–287. **Review**
- Neinhuis, C., and Barthlott, W.** (1997). Characterization and distribution of water-repellent, self-cleaning plant surfaces. *Ann. Bot.* **79**, 667–677. **Review**
- Nerlich, A., von Orlow, M., Rontein, D., Hanson, A.D., and Dormann, P.** (2007). Deficiency in phosphatidylserine decarboxylase activity in the *psd1 psd2 psd3* triple mutant of *Arabidopsis* affects phosphatidylethanolamine accumulation in mitochondria. *Plant Physiol.* **144**, 904–914.
- Nowicki, M., Muller, F., and Frentzen, M.** (2005). Cardiolipin synthase of *Arabidopsis thaliana*. *FEBS Lett.* **579**, 2161–2165.
- Ohlrogge, J., and Browse, J.** (1995). Lipid biosynthesis. *Plant Cell* **7**, 957–970. **Review**
- Ohlrogge, J.B., and Jaworski, J.G.** (1997). Regulation of fatty acid synthesis. *Annu. Rev. Plant Phys.* **48**, 109–136. **Review**
- Ohnishi, M., and Fujino, Y.** (1981). Chemical-composition of ceramide and cerebroside in azuki bean-seeds. *Agric. Biol. Chem.* **45**, 1283–1284.

- Okamoto, T., Tsurumi, S., Shibasaki, K., Obana, Y., Takaji, H., Oono, Y., and Rahman, A.** (2008). Genetic dissection of hormonal responses in the roots of Arabidopsis grown under continuous mechanical impedance. *Plant Physiol.* **146**, 1651–1662.
- Okazaki, Y., Shimojima, M., Sawada, Y., Toyooka, K., Narisawa, T., Mochida, K., Tanaka, H., Matsuda, F., Hirai, A., Hirai, M.Y., Ohta, H., and Saito, K.** (2009). A chloroplastic UDP-Glucose pyrophosphorylase from Arabidopsis is the committed enzyme for the first step of sulfolipid biosynthesis. *Plant Cell* **21**, 892–909.
- Okuley, J., Lightner, J., Feldmann, K., Yadav, N., Lark, E., and Browse, J.** (1994). Arabidopsis FAD2 gene encodes the enzyme that is essential for polyunsaturated lipid synthesis. *Plant Cell* **6**, 147–158.
- Oliver, D.J., Nikolau, B.J., and Wurtele, E.S.** (2009). Acetyl-CoA-life at the metabolic nexus. *Plant Sci.* **176**, 597–601.
- Ollis, D.L., Cheah, E., Cygler, M., Dijkstra, B., Frolow, F., Franken, S.M., Harel, M., Remington, S.J., Silman, I., Schrag, J., Sussman J.L., Verschuere K.H., Goldman A** (1992). The alpha/beta hydrolase fold. *Protein Eng.* **5**, 197–211. **Review**
- Olsson, A., Lindstrom, M., and Iversen, T.** (2007). Lipase-catalyzed synthesis of an epoxy-functionalized polyester from the suberin monomer cis-9,10-epoxy-18-hydroxyoctadecanoic acid. *Biomacromolecules* **8**, 757–760.
- Padham, A.K., Hopkins, M.T., Wang, T.W., McNamara, L.M., Lo, M., Richardson, L.G.L., Smith, M.D., Taylor, C.A., and Thompson, J.E.** (2007). Characterization of a plastid triacylglycerol lipase from Arabidopsis. *Plant Physiol.* **143**, 1372–1384.
- Panikashvili, D., Savaldi-Goldstein, S., Mandel, T., Yifhar, T., Franke, R.B., Hofer, R., Schreiber, L., Chory, J., and Aharoni, A.** (2007). The Arabidopsis DESPERADO/AtWBC11 transporter is required for cutin and wax secretion. *Plant Physiol.* **145**, 1345–1360.
- Panikashvili, D., Shi, J.X., Schreiber, L., and Aharoni, A.** (2009). The Arabidopsis DCR encoding a soluble BAHD acyltransferase is required for cutin polyester formation and seed hydration properties. *Plant Physiol.* **151**, 1773–1789.
- Penfield, S., Pinfield-Wells, H.M., and Graham, I.A.** (2006). Storage reserve mobilization and seedling establishment in Arabidopsis. In *The Arabidopsis Book* (Rockville, MD: American Society of Plant Biologists). **Review**
- Perham, R.N.** (1991). Domains, motifs, and linkers in 2-oxo acid dehydrogenase multienzyme complexes: A paradigm in the design of a multifunctional protein. *Biochemistry* **30**, 8501–8512.
- Pidkowich, M.S., Nguyen, H.T., Heilmann, I., Ischebeck, T., and Shanklin, J.** (2007). Modulating seed beta-ketoacyl-acyl carrier protein synthase II level converts the composition of a temperate seed oil to that of a palm-like tropical oil. *Proc. Natl. Acad. Sci. USA* **104**, 4742–4747.
- Pierrugues, O., Brutesco, C., Oshiro, J., Gouy, M., Deveaux, Y., Carman, G.M., Thuriaux, P., and Kazmaier, M.** (2001). Lipid phosphate phosphatases in Arabidopsis Regulation of the AtLPP1 gene in response to stress. *J. Biol. Chem.* **276**, 20300–20308.
- Pighin, J.A., Zheng, H.Q., Balakshin, L.J., Goodman, I.P., Western, T.L., Jetter, R., Kunst, L., and Samuels, A.L.** (2004). Plant cuticular lipid export requires an ABC transporter. *Science* **306**, 702–704.
- Pinfield-Wells, H., Rylott, E.L., Gilday, A.D., Graham, S., Job, K., Larson, T.R., and Graham, I.A.** (2005). Sucrose rescues seedling establishment but not germination of Arabidopsis mutants disrupted in peroxisomal fatty acid catabolism. *Plant J.* **43**, 861–872.
- Poirier, Y., Antonenkov, V.D., Glumoff, T., and Hiltunen, J.K.** (2006). Peroxisomal beta-oxidation A metabolic pathway with multiple functions. *Biochim. Biophys. Acta, Mol. Cell Res.* **1763**, 1413–1426.
- Pollard, M., Beisson, F., Li, Y.H., and Ohlrogge, J.B.** (2008). Building lipid barriers: Biosynthesis of cutin and suberin. *Trends Plant Sci.* **13**, 236–246. **Review**
- Post-Beittenmiller, D., Jaworski, J.G., and Ohlrogge, J.B.** (1991). In vivo pools of free and acylated acyl carrier proteins in spinach: Evidence for sites of regulation of fatty acid biosynthesis. *J. Biol. Chem.* **266**, 1858–1865.
- Post-Beittenmiller, D., Roughan, G., and Ohlrogge, J.B.** (1992). Regulation of plant fatty acid biosynthesis: Analysis of acyl-coenzyme A and acyl-acyl carrier protein substrate pools in spinach and pea chloroplasts. *Plant Physiol.* **100**, 923–930.
- Poxleitner, M., Rogers, S.W., Samuels, A.L., Browse, J., and Rogers, J.C.** (2006). A role for caleosin in degradation of oil-body storage lipid during seed germination. *Plant J.* **47**, 917–933.
- Pruitt, R.E., Vielle-Calzada, J.P., Ploense, S.E., Grossniklaus, U., and Lolte, S.J.** (2000). FIDDLEHEAD, a gene required to suppress epidermal cell interactions in Arabidopsis, encodes a putative lipid biosynthetic enzyme. *Proc. Natl. Acad. Sci. USA* **97**, 1311–1316.
- Qi, Q.G., Huang, Y.F., Cutler, A.J., Abrams, S.R., and Taylor, D.C.** (2003). Molecular and biochemical characterization of an aminoalcoholphosphotransferase (AAPT1) from Brassica napus: Effects of low temperature and abscisic acid treatments on AAPT expression in Arabidopsis plants and effects of over-expression of BnAAPT1 in transgenic Arabidopsis. *Planta* **217**, 547–558.
- Quettier, A.L., and Eastmond, P.J.** (2009). Storage oil hydrolysis during early seedling growth. *Plant Physiol. Biochem.* **47**, 485–490. **Review**
- Raffaele, S., Vaillieu, F., Leger, A., Joubes, J., Blee, E., Domergue, F., Mongrand, S., and Roby, D.** (2008). A MYB transcription factor regulates fatty acid biosynthesis for the activation of the hypersensitive cell death in Arabidopsis. *Biology of Plant-Microbe Interactions*, Vol. 6. Proceedings of the 13th International Congress on Molecular Plant-Microbe Interactions. Sorrento, Italy, 21–27 July 2007, article 80.
- Reed, D.W.** (1982). Wax alteration and extraction during electron microscopy preparation of leaf cuticles. In *The Plant Cuticle*, D.F. Cutler, K.L. Alvin, and C.E. Price, eds (London; New York: Academic Press), pp. 181–195.
- Richmond, T.A., and Bleecker, A.B.** (1999). A defect in beta-oxidation causes abnormal inflorescence development in Arabidopsis. *Plant Cell* **11**, 1911–1923.
- Riekhof, W.R., Wu, J., Jones, J.L., and Voelker, D.R.** (2007). Identification and characterization of the major lysophosphatidylethanolamine acyltransferase in *Saccharomyces cerevisiae*. *J. Biol. Chem.* **282**, 28344–28352.
- Rontein, D., Nishida, I., Tashiro, G., Yoshioka, K., Wu, W.I., Voelker, D.R., Basset, G., and Hanson, A.D.** (2001). Plants synthesize ethanolamine by direct decarboxylation of serine using a pyridoxal phosphate enzyme. *J. Biol. Chem.* **276**, 35523–35529.
- Rontein, D., Wu, W.I., Voelker, D.R., and Hanson, A.D.** (2003). Mitochondrial phosphatidylserine decarboxylase from higher plants: Functional complementation in yeast, localization in plants, and overexpression in Arabidopsis. *Plant Physiol.* **132**, 1678–1687.
- Rouser, G., Kritchevsky, G., Simon, G., and Nelson, G.J.** (1967). Quantitative analysis of brain and spinach leaf lipids employing silicic acid column chromatography and acetone for elution of glycolipids. *Lipids* **2**, 37–40.
- Roughan, P.G., and Slack, C.R.** (1982). Cellular Organization of Glycerolipid Metabolism. *Annu Rev Plant Phys* **33**, 97–132. **Review**
- Routaboul, J.M., Benning, C., Bechtold, N., Caboche, M., and Lepiniec, L.** (1999). The TAG1 locus of Arabidopsis encodes for a diacylglycerol acyltransferase. *Plant Physiol. Biochem.* **37**, 831–840.
- Rowland, O., Lee, R., Franke, R., Schreiber, L., and Kunst, L.** (2007). The CER3 wax biosynthetic gene from *Arabidopsis thaliana* is allelic to WAX2/YRE/FLP1. *FEBS Lett.* **581**, 3538–3544.
- Rowland, O., Zheng, H.Q., Hepworth, S.R., Lam, P., Jetter, R., and Kunst, L.** (2006). CER4 encodes an alcohol-forming fatty acyl-coen-

- zyme A reductase involved in cuticular wax production in *Arabidopsis*. *Plant Physiol.* **142**, 866–877.
- Rupasinghe, S.G., Duan, H., and Schuler, M.A.** (2007). Molecular definitions of fatty acid hydroxylases in *Arabidopsis thaliana*. *Proteins: Struct., Funct., Bioinf.* **68**, 279–293.
- Ruuska, S.A., Girke, T., Benning, C., and Ohlrogge, J.B.** (2002). Contrapuntal networks of gene expression during *Arabidopsis* seed filling. *Plant Cell* **14**, 1191–1206.
- Rylott, E.L., Eastmond, P.J., Gilday, A.D., Slocombe, S.P., Larson, T.R., Baker, A., and Graham, I.A.** (2006). The *Arabidopsis thaliana* multifunctional protein gene (MFP2) of peroxisomal beta-oxidation is essential for seedling establishment. *Plant J.* **45**, 930–941.
- Rylott, E.L., Hooks, M.A., and Graham, I.A.** (2001). Co-ordinate regulation of genes involved in storage lipid mobilization in *Arabidopsis thaliana*. *Biochem. Soc. Trans.* **29**, 283–287.
- Saha, S., Enugutti, B., Rajakumari, S., and Rajasekharan, R.** (2006). Cytosolic triacylglycerol biosynthetic pathway in oilseeds: Molecular cloning and expression of peanut cytosolic diacylglycerol acyltransferase. *Plant Physiol.* **141**, 1533–1543.
- Samuels, L., Kunst, L., and Jetter, R.** (2008). Sealing plant surfaces: Cuticular wax formation by epidermal cells. *Annu. Rev. Plant Biol.* **59**, 683–707. **Review**
- Santos-Mendoza, M., Dubreucq, B., Baud, S., Parcy, F., Caboche, M., and Lepiniec, L.** (2008). Deciphering gene regulatory networks that control seed development and maturation in *Arabidopsis*. *Plant J.* **54**, 608–620.
- Schäfer, K.** (1998). Accelerated solvent extraction of lipids for determining the fatty acid composition of biological material. *Anal. Chim. Acta* **358**, 69–77.
- Schlame, M.** (2008). Thematic review series: Glycerolipids Cardiolipin synthesis for the assembly of bacterial and mitochondrial membranes. *J. Lipid Res.* **49**, 1607–1620. **Review**
- Schmid, M., Davison, T.S., Henz, S.R., Pape, U.J., Demar, M., Vingron, M., Scholkopf, B., Weigel, D., and Lohmann, J.U.** (2005). A gene expression map of *Arabidopsis thaliana* development. *Nat. Genet.* **37**, 501–506.
- Schmid, P.** (1973). Extraction and purification of lipids: II. Why is chloroform-methanol such a good lipid solvent? *Physiol. Chem. Phys.* **5**, 141–150.
- Schmid, R.D., and Verger, R.** (1998). Lipases: Interfacial enzymes with attractive applications. *Angew. Chem., Int. Ed.* **37**, 1609–1633. **Review**
- Schmidt, M.A., and Herman, E.M.** (2008). Suppression of soybean oleosin produces micro-oil bodies that aggregate into oil body/ER complexes. *Mol. Plant* **1**, 910–924.
- Schnurr, J., Shockey, J., and Browse, J.** (2004). The acyl-CoA synthetase encoded by LACS2 is essential for normal cuticle development in *Arabidopsis*. *Plant Cell* **16**, 629–642.
- Schulz, H., and Kunau, W.H.** (1987). Beta-oxidation of unsaturated fatty acids: A revised pathway. *Trends Biochem. Sci.* **12**, 403–406. **Review**
- Schwacke, R., Schneider, A., van der Graaff, E., Fischer, K., Catoni, E., Desimone, M., Frommer, W.B., Flugge, U.I., and Kunze, R.** (2003). ARAMEMNON, a novel database for *Arabidopsis* integral membrane proteins. *Plant Physiol.* **131**, 16–26.
- Seo, Y., Kim, E., Kim, J., and Kim, W.** (2009). Enzymatic characterization of class I DAD1-like acylhydrolase members targeted to chloroplast in *Arabidopsis*. *FEBS Lett.* **583**, 2301–2307.
- Seo, Y.S., Kim, E.Y., Mang, H.G., and Kim, W.T.** (2008). Heterologous expression, and biochemical and cellular characterization of *CaPLA1* encoding a hot pepper phospholipase A1 homolog. *Plant J.* **53**, 895–908.
- Shaner, N.C., Patterson, G.H., and Davidson, M.W.** (2007). Advances in fluorescent protein technology. *J. Cell Sci.* **120**, 4247–4260. **Review**
- Shanklin, J., and Cahoon, E.B.** (1998). Desaturation and related modifications of fatty acids 1. *Annu. Rev. Plant Physiol. Plant Mol. Biol.* **49**, 611–641. **Review**
- Shanklin, J., Whittle, E., and Fox, B.G.** (1994). Eight histidine residues are catalytically essential in a membrane-associated iron enzyme, stearyl-CoA desaturase, and are conserved in alkane hydroxylase and xylylene monooxygenase. *Biochemistry* **33**, 12787–12794.
- Shen, B., Li, C.J., Min, Z., Meeley, R.B., Tarczynski, M.C., and Olsen, O.A.** (2003). *sal1* determines the number of aleurone cell layers in maize endosperm and encodes a class E vacuolar sorting protein. *Proc. Natl. Acad. Sci. USA* **100**, 6552–6557.
- Shimada, T.L., Shimada, T., Takahashi, H., Fukao, Y., and Hara-Nishimura, I.** (2008). A novel role for oleosins in freezing tolerance of oilseeds in *Arabidopsis thaliana*. *Plant J.* **55**, 798–809.
- Shintani, D.K., and Ohlrogge, J.B.** (1994). The characterization of a mitochondrial acyl carrier protein isoform isolated from *Arabidopsis thaliana*. *Plant Physiol.* **104**, 1221–1229.
- Shintani, D.K., and Ohlrogge, J.B.** (1995). Feedback inhibition of fatty acid synthesis in tobacco suspension cells. *Plant J.* **7**, 577–587.
- Shockey, J.M., Gidda, S.K., Chapital, D.C., Kuan, J.C., Dhanoa, P.K., Bland, J.M., Rothstein, S.J., Mullen, R.T., and Dyer, J.M.** (2006). Tung tree DGAT1 and DGAT2 have nonredundant functions in triacylglycerol biosynthesis and are localized to different subdomains of the endoplasmic reticulum. *Plant Cell* **18**, 2294–2313.
- Siloto, R.M.P., Findlay, K., Lopez-Villalobos, A., Yeung, E.C., Nykiforuk, C.L., and Moloney, M.M.** (2006). The accumulation of oleosins determines the size of seed oilbodies in *Arabidopsis*. *Plant Cell* **18**, 1961–1974.
- Slocombe, S.P., Cornah, J., Pinfield-Wells, H., Soady, K., Zhang, Q., Gilday, A., Dyer, J.M., and Graham, I.A.** (2009). Oil accumulation in leaves directed by modification of fatty acid breakdown and lipid synthesis pathways. *Plant Biotechnol. J.* **7**, 694–703.
- Sohlenkamp, C., de Rudder, K.E.E., Rohrs, V., Lopez-Lara, I.M., and Geiger, O.** (2000). Cloning and characterization of the gene for phosphatidylcholine synthase. *J. Biol. Chem.* **275**, 18919–18925.
- Soler, M., Serra, O., Molinas, M., Huguet, G., Fluch, S., and Figueras, M.** (2007). A genomic approach to suberin biosynthesis and cork differentiation. *Plant Physiol.* **144**, 419–431.
- Soliday, C.L., and Kolattukudy, P.E.** (1977). Biosynthesis of cutin omega-hydroxylation of fatty acids by a microsomal preparation from germinating *Vicia faba*. *Plant Physiol.* **59**, 1116–1121.
- Somerville, C., and Browse, J.** (1996). Dissecting desaturation: Plants prove advantageous. *Trends Cell Biol.* **6**, 148–153. **Review**
- Somerville, C.R., Browse, J., Jaworski, J., and Ohlrogge, J.** (2000). Lipids. In *Biochemistry and Molecular Biology of Plants*, B.B. Buchanan, W. Gruissem, and R.L. Jones, eds (Rockville, MD: American Society of Plant Physiologists), Chap 10, pp. 456–526. **Review**
- Sousa, E., Kost, B., and Malho, R.** (2008). *Arabidopsis* phosphatidylinositol-4-monophosphate 5-kinase 4 regulates pollen tube growth and polarity by modulating membrane recycling. *Plant Cell* **20**, 3050–3064.
- Sowa, J.M., and Subbaiah, P.V.** (2004). Variable recoveries of fatty acids following the separation of lipids on commercial silica gel TLC plates: Selective loss of unsaturated fatty acids on certain brands of plates. *J. Chromatogr., B: Anal. Technol. Biomed. Life Sci.* **813**, 159–166.
- Sperling, P., Franke, S., Luthje, S., and Heinz, E.** (2005). Are glucocerebrosides the predominant sphingolipids in plant plasma membranes? *Plant Physiol. Biochem.* **43**, 1031–1038.
- Sperling, P., and Heinz, E.** (1993). Isomeric sn-1-octadecenyl and sn-2-octadecenyl analogs of lysophosphatidylcholine as substrates for acylation and desaturation by plant microsomal-membranes. *European Journal of Biochemistry* **213**, 965–971.
- Sperling, P., Linscheid, M., Stocker, S., Muhlbach, H.P., and Heinz, E.** (1993). In vivo desaturation of cis-delta 9-monounsaturated to cis-delta 9,12-diunsaturated alkenylether glycerolipids. *J. Biol. Chem.* **268**,

- 26935–26940.
- Sperling, P., Zähringer, U., and Heinz, E.** (1998). A sphingolipid desaturase from higher plants Identification of a new cytochrome b_5 fusion protein. *J. Biol. Chem.* **273**, 28590–28596.
- Staelin, L.A.** (1997). The plant ER: A dynamic organelle composed of a large number of discrete functional domains. *Plant J.* **11**, 1151–1165. **Review**
- Stahl, U., Carlsson, A.S., Lenman, M., Dahlqvist, A., Huang, B.Q., Banas, W., Banas, A., and Stymne, S.** (2004). Cloning and functional characterization of a Phospholipid:Diacylglycerol acyltransferase from Arabidopsis. *Plant Physiol.* **135**, 1324–1335.
- Stahl, U., Stalberg, K., Stymne, S., and Ronne, H.** (2008). A family of eukaryotic lysophospholipid acyltransferases with broad specificity. *FEBS Lett.* **582**, 305–309.
- Stalberg, K., Stahl, U., Stymne, S., and Ohlrogge, J.** (2009). Characterization of two *Arabidopsis thaliana* acyltransferases with preference for lysophosphatidylethanolamine. *BMC Plant Biol.* **9**, 60.
- Stobart, K., Mancha, M., Lenman, M., Dahlqvist, A., and Stymne, S.** (1997). Triacylglycerols are synthesized and utilized by transacylation reactions in microsomal preparations of developing safflower (*Carthamus tinctorius* L) seeds. *Planta* **203**, 58–66.
- Stymne, S., and Stobart, A.K.** (1984). Evidence for the reversibility of the acyl-CoA:lysophosphatidylcholine acyltransferase in microsomal preparations from developing safflower (*Carthamus tinctorius* L.) cotyledons and rat liver. *Biochem. J.* **223**, 305–314.
- Suh, M.C., Samuels, A.L., Jetter, R., Kunst, L., Pollard, M., Ohlrogge, J., and Beisson, F.** (2005). Cuticular lipid composition, surface structure, and gene expression in Arabidopsis stem epidermis. *Plant Physiol.* **139**, 1649–1665.
- Sullards, M.C., Lynch, D.V., Merrill, A.H., and Adams, J.** (2000). Structure determination of soybean and wheat glucosylceramides by tandem mass spectrometry. *J. Mass Spectrom.* **35**, 347–353.
- Suzuki, M., and McCarty, D.R.** (2008). Functional symmetry of the B3 network controlling seed development. *Curr. Opin. Plant Biol.* **11**, 548–553.
- Taguchi, R., Houjou, T., Nakanishi, H., Yamazaki, T., Ishida, M., Imagawa, M., and Shimizu, T.** (2005). Focused lipidomics by tandem mass spectrometry. *J. Chromatogr., B: Anal. Technol. Biomed. Life Sci.* **823**, 26–36.
- Tasseva, G., Richard, L., and Zachowski, A.** (2004). Regulation of phosphatidylcholine biosynthesis under salt stress involves choline kinases in *Arabidopsis thaliana*. *FEBS Lett.* **566**, 115–120.
- Taylor, D.C., Giblin, E.M., Reed, D.W., Hogge, L.R., Olson, D.J., and Mackenzie, S.L.** (1995). Stereospecific analysis and mass-spectrometry of triacylglycerol from Arabidopsis seeds. *J. Am. Oil Chem. Soc.* **72**, 305–308.
- Taylor, D.C., Weber, N., Hogge, L.R., and Underhill, E.W.** (1990). A simple enzymatic method for the preparation of radiolabeled erucoyl-CoA and other long-chain fatty acyl-CoAs and their characterization by mass spectrometry. *Anal. Biochem.* **184**, 311–316.
- Teissere, M., Borel, M., Cailloil, B., Nari, J., Gardies, A.M., and Noat, G.** (1995). Purification and characterization of a fatty acyl-ester hydrolase from post-germinated sunflower seeds. *Biochim. Biophys. Acta* **1255**, 105–112.
- Theodoulou, F.L., Job, K., Slocombe, S.P., Footitt, S., Holdsworth, M., Baker, A., Larson, T.R., and Graham, I.A.** (2005). Jasmonoic acid levels are reduced in COMATOSE ATP-binding cassette transporter mutants: Implications for transport of jasmonate precursors into peroxisomes. *Plant Physiol.* **137**, 835–840.
- Todd, J., Post-Beittenmiller, D., and Jaworski, J.G.** (1999). KCS1 encodes a fatty acid elongase 3-keetoacyl-CoA synthase affecting wax biosynthesis in *Arabidopsis thaliana*. *Plant J.* **17**, 119–130.
- Townley, H.E., McDonald, K., Jenkins, G.I., Knight, M.R., and Leaver, C.J.** (2005). Ceramides induce programmed cell death in Arabidopsis cells in a calcium-dependent manner. *Biol. Chem.* **386**, 161–166.
- Tsegaye, Y., Richardson, C.G., Bravo, J.E., Mulcahy, B.J., Lynch, D.V., Markham, J.E., Jaworski, J.G., Chen, M., Cahoon, E.B., and Dunn, T.M.** (2007). Arabidopsis mutants lacking long chain base phosphate lyase are fumonisin-sensitive and accumulate trihydroxy-18:1 long chain base phosphate. *J. Biol. Chem.* **282**, 28195–28206.
- Ukitsu, H., Kuromori, T., Toyooka, K., Goto, Y., Matsuoka, K., Sakuradani, E., Shimizu, S., Kamiya, A., Imura, Y., Yuguchi, M., Wada, T., Hirayama, T., and Shinozaki, K.** (2007). Cytological and biochemical analysis of COF1, an Arabidopsis mutant of an ABC transporter gene. *Plant Cell Physiol.* **48**, 1524–1533.
- van Meer, G., Voelker, D.R., and Feigenson, G.W.** (2008). Membrane lipids: Where they are and how they behave. *Nat. Rev. Mol. Cell Biol.* **9**, 112–124. **Review**
- Villena, J.F., Dominguez, E., Stewart, D., and Heredia, A.** (1999). Characterization and biosynthesis of non-degradable polymers in plant cuticles. *Planta* **208**, 181–187.
- Vioque, J., and Kolattukudy, P.E.** (1997). Resolution and purification of an aldehyde-generating and an alcohol-generating fatty acyl-CoA reductase from pea leaves (*Pisum sativum* L). *Arch. Biochem. and Biophys.* **340**, 64–72.
- Voisin, D., Nawrath, C., Kurdyukov, S., Franke, R.B., Reina-Pinto, J.J., Efremova, N., Will, I., Schreiber, L., and Yephremov, A.** (2009). Dissection of the complex phenotype in cuticular mutants of Arabidopsis reveals a role of SERRATE as a mediator. *PLoS Genet.* **5**, e1000703
- Wada, H., Shintani, D., and Ohlrogge, J.** (1997). Why do mitochondria synthesize fatty acids? Evidence for involvement in lipoic acid production. *Proc. Natl. Acad. Sci. USA* **94**, 1591–1596.
- Wada, M., Yasuno, R., Jordan, S.W., Cronan, J.E., and Wada, H.** (2001a). Lipoic acid metabolism in *Arabidopsis thaliana*: Cloning and characterization of a cDNA encoding lipoyltransferase. *Plant Cell Physiol.* **42**, 650–656.
- Wada, M., Yasuno, R., and Wada, H.** (2001b). Identification of an Arabidopsis cDNA encoding a lipoyltransferase located in plastids. *FEBS Lett.* **506**, 286–290.
- Wang, W.M., Yang, X.H., Tangchaiburana, S., Ndeh, R., Markham, J.E., Tsegaye, Y., Dunn, T.M., Wang, G.L., Bellizzi, M., Parsons, J.F., Morrissey, D., Bravo, J.E., et al.** (2008). An inositolphosphorylceramide synthase is involved in regulation of plant programmed cell death associated with defense in Arabidopsis. *Plant Cell* **20**, 3163–3179.
- Wellesen, K., Durst, F., Pinot, F., Benveniste, I., Nettekheim, K., Wisman, E., Steiner-Lange, S., Saedler, H., and Yephremov, A.** (2001). Functional analysis of the LACERATA gene of Arabidopsis provides evidence for different roles of fatty acid omega-hydroxylation in development. *Proc. Natl. Acad. Sci. USA* **98**, 9694–9699.
- Welti, R., Li, W.Q., Li, M.Y., Sang, Y.M., Biesiada, H., Zhou, H.E., Rajashekar, C.B., Williams, T.D., and Wang, X.M.** (2002). Profiling membrane lipids in plant stress responses—Role of phospholipase D alpha in freezing-induced lipid changes in Arabidopsis. *J. Biol. Chem.* **277**, 31994–32002.
- Welti, R., Shah, J., Li, W.Q., Li, M.Y., Chen, J.P., Burke, J.J., Fauconnier, M.L., Chapman, K., Chye, M.L., and Wang, X.M.** (2007). Plant lipidomics: Discerning biological function by profiling plant complex lipids using mass spectrometry. *Front. Biosci.* **12**, 2494–2506. **Review**
- Welti, R., and Wang, X.M.** (2004). Lipid species profiling: A high-throughput approach to identify lipid compositional changes and determine the function of genes involved in lipid metabolism and signaling. *Curr. Opin. Plant Biol.* **7**, 337–344. **Review**
- Welti, R., Wang, X.M., and Williams, T.D.** (2003). Electrospray ionization tandem mass spectrometry scan modes for plant chloroplast lipids. *Anal. Biochem.* **314**, 149–152.

- Wen, M., and Jetter, R.** (2009). Composition of secondary alcohols, ketones, alkanediols, and ketols in *Arabidopsis thaliana* cuticular waxes. *J. Exp. Bot.* **60**, 1811–1821.
- Weng, H., Molina, I., Shockey, J., and Browse, J.** (2010). Organ fusion and defective cuticle function in a *lacs1 lacs2* double mutant of *Arabidopsis*. *Planta* **231**, 1089–1100.
- Westphal, S., Heins, L., Soll, J., and Vothknecht, U.C.** (2001a). *Vipp1* deletion mutant of *Synechocystis*: A connection between bacterial phage shock and thylakoid biogenesis? *Proc. Natl. Acad. Sci. USA* **98**, 4243–4248.
- Westphal, S., Soll, J., and Vothknecht, U.C.** (2001b). A vesicle transport system inside chloroplasts. *FEBS Lett.* **506**, 257–261.
- Wharfe, J., and Harwood, J.L.** (1979). Lipid metabolism in germinating seeds: Purification of ethanolamine kinase from soya bean. *Biochim. Biophys. Acta* **575**, 102–111.
- Williams, J.P., Imperial, V., Khan, M.U., and Hodson, J.N.** (2000). The role of phosphatidylcholine in fatty acid exchange and desaturation in *Brassica napus* L. leaves. *Biochem. J.* **349**, 127–133.
- Wintermans, J.F., Van Besouw, A., and Bogemann, G.** (1981). Galactolipid formation in chloroplast envelopes: II. Isolation-induced changes in galactolipid composition. *Biochim. Biophys. Acta* **663**, 99–107.
- Woolley, P., Petersen, S.B., and Nordisk Industrifond.** (1994). *Lipases: Their Structure, Biochemistry, and Application* (Cambridge, England; New York: Cambridge University Press). **Review**
- Wu, J.R., James, D.W., Dooner, H.K., and Browse, J.** (1994). A mutant of *Arabidopsis* deficient in the elongation of palmitic acid. *Plant Physiol.* **106**, 143–150.
- Xiao, F.M., Goodwin, S.M., Xiao, Y.M., Sun, Z.Y., Baker, D., Tang, X.Y., Jenks, M.A., and Zhou, J.M.** (2004). *Arabidopsis* CYP86A2 represses *Pseudomonas syringae* type III genes and is required for cuticle development. *EMBO J.* **23**, 2903–2913.
- Xiao, S., and Chye, M.L.** (2009). An *Arabidopsis* family of six acyl-CoA-binding proteins has three cytosolic members. *Plant Physiol. Biochem.* **47**, 479–484.
- Xu, C., Fan, J.L., Cornish, A.J., and Benning, C.** (2008). Lipid trafficking between the endoplasmic reticulum and the plastid in *Arabidopsis* requires the extraplastidic TGD4 protein. *Plant Cell* **20**, 2190–2204.
- Xu, C.C., Fan, J.L., Riekhof, W., Froehlich, J.E., and Benning, C.** (2003). A permease-like protein involved in ER to thylakoid lipid transfer in *Arabidopsis*. *EMBO J.* **22**, 2370–2379.
- Xu, C.C., Hartel, H., Wada, H., Hagio, M., Yu, B., Eakin, C., and Benning, C.** (2002). The *pgp1* mutant locus of *Arabidopsis* encodes a phosphatidylglycerolphosphate synthase with impaired activity. *Plant Physiol.* **129**, 594–604.
- Xu, C.C., Yu, B., Cornish, A.J., Froehlich, J.E., and Benning, C.** (2006). Phosphatidylglycerol biosynthesis in chloroplasts of *Arabidopsis* mutants deficient in acyl-ACP glycerol-3-phosphate acyltransferase. *Plant J.* **47**, 296–309.
- Xu, J., Francis, T., Mietkiewska, E., Giblin, E.M., Barton, D.L., Zhang, Y., Zhang, M., and Taylor, D.C.** (2008). Cloning and characterization of an acyl-CoA-dependent diacylglycerol acyltransferase 1 (DGAT1) gene from *Tropaeolum majus*, and a study of the functional motifs of the DGAT protein using site-directed mutagenesis to modify enzyme activity and oil content. *Plant Biotechnol. J.* **6**, 799–818.
- Xue, H.W., Hosaka, K., Plesch, G., and Mueller-Roeber, B.** (2000). Cloning of *Arabidopsis thaliana* phosphatidylinositol synthase and functional expression in the yeast *pis* mutant. *Plant Mol. Biol.* **42**, 757–764.
- Yang, W., Pollard, M., Li-Beisson, Y., Beisson, F., Feig, M., and Ohlrogge, J.** (2010). A distinct type of glycerol-3-phosphate acyltransferase with sn-2 preference and phosphatase activity producing 2-monoacylglycerol. *Proc. Natl. Acad. Sci. USA* **107**, 12040–12045.
- Yang, Z.L., and Ohlrogge, J.B.** (2009). Turnover of fatty acids during natural senescence of *Arabidopsis*, *Brachypodium*, and *Switchgrass* and in *Arabidopsis* beta-oxidation mutants. *Plant Physiol.* **150**, 1981–1989.
- Yasuno, R., von Wettstein-Knowles, P., and Wada, H.** (2004). Identification and molecular characterization of the beta-ketoacyl-acyl carrier protein synthase component of the *Arabidopsis* mitochondrial fatty acid synthase. *J. Biol. Chem.* **279**, 8242–8251.
- Yasuno, R., and Wada, H.** (1998). Biosynthesis of lipoic acid in *Arabidopsis*: Cloning and characterization of the cDNA for lipoic acid synthase. *Plant Physiol.* **118**, 935–943.
- Yasuno, R., and Wada, H.** (2002). The biosynthetic pathway for lipoic acid is present in plastids and mitochondria in *Arabidopsis thaliana*. *FEBS Lett.* **517**, 110–114.
- Yen, C.L.E., Stone, S.J., Koliwad, S., Harris, C., and Farese, R.V.** (2008). DGAT enzymes and triacylglycerol biosynthesis. *J. Lipid Res.* **49**, 2283–2301.
- Yephremov, A., Wisman, E., Huijser, P., Huijser, C., Wellesen, K., and Saedler, H.** (1999). Characterization of the FIDDLEHEAD gene of *Arabidopsis* reveals a link between adhesion response and cell differentiation in the epidermis. *Plant Cell* **11**, 2187–2201.
- Yu, B., and Benning, C.** (2003). Anionic lipids are required for chloroplast structure and function in *Arabidopsis*. *Plant J.* **36**, 762–770.
- Yu, B., Wakao, S., Fan, J., and Benning, C.** (2004). Loss of plastidic lysophosphatidic acid acyltransferase causes embryo-lethality in *Arabidopsis*. *Plant Cell Physiol.* **45**, 503–510.
- Zechner, R., Kienesberger, P.C., Haemmerle, G., Zimmermann, R., and Lass, A.** (2009). Adipose triglyceride lipase and the lipolytic catabolism of cellular fat stores. *J. Lipid Res.* **50**, 3–21. **Review**
- Zhang, M., Fan, J., Taylor, D.C., and Ohlrogge, J.B.** (2009). DGAT1 and PDAT1 acyltransferases have overlapping functions in *Arabidopsis* triacylglycerol biosynthesis and are essential for normal pollen and seed development. *Plant Cell* **21**, 3885–3901
- Zheng, H.Q., Rowland, O., and Kunst, L.** (2005). Disruptions of the *Arabidopsis* enoyl-CoA reductase gene reveal an essential role for very-long-chain fatty acid synthesis in cell expansion during plant morphogenesis. *Plant Cell* **17**, 1467–1481.
- Zheng, Z.F., Xia, Q., Dauk, M., Shen, W.Y., Selvaraj, G., and Zou, J.T.** (2003). *Arabidopsis* AtGPAT1, a member of the membrane-bound glycerol-3-phosphate acyltransferase gene family, is essential for tapetum differentiation and male fertility. *Plant Cell* **15**, 1872–1887.
- Zheng, Z.F., and Zou, J.T.** (2001). The initial step of the glycerolipid pathway Identification of glycerol 3-phosphate/dihydroxyacetone phosphate dual substrate acyltransferases in *Saccharomyces cerevisiae*. *J. Biol. Chem.* **276**, 41710–41716.
- Zolman, B.K., Silva, I.D., and Bartel, B.** (2001). The *Arabidopsis* *pxa1* mutant is defective in an ATP-binding cassette transporter-like protein required for peroxisomal fatty acid beta-oxidation. *Plant Physiol.* **127**, 1266–1278.
- Zolman, B.K., Yoder, A., and Bartel, B.** (2000). Genetic analysis of indole-3-butyric acid responses in *Arabidopsis thaliana* reveals four mutant classes. *Genetics* **156**, 1323–1337.
- Zou, J.T., Wei, Y.D., Jako, C., Kumar, A., Selvaraj, G., and Taylor, D.C.** (1999). The *Arabidopsis thaliana* TAG1 mutant has a mutation in a diacylglycerol acyltransferase gene. *Plant J.* **19**, 645–653.