

Research Article

Adaptive Fuzzy Super-Twisting Sliding Mode Control for Microgyroscope

Juntao Fei ^{1,2} and Zhilin Feng^{1,2}

¹College of IoT Engineering, Hohai University, Changzhou 213022, China

²Jiangsu Key Lab. of Power Transmission and Distribution Equipment Technology, China

Correspondence should be addressed to Juntao Fei; jtfei@yahoo.com

Received 14 September 2018; Accepted 29 January 2019; Published 21 February 2019

Academic Editor: Michele Scarpiniti

Copyright © 2019 Juntao Fei and Zhilin Feng. This is an open access article distributed under the Creative Commons Attribution License, which permits unrestricted use, distribution, and reproduction in any medium, provided the original work is properly cited.

This paper proposes a novel adaptive fuzzy super-twisting sliding mode control scheme for microgyroscopes with unknown model uncertainties and external disturbances. Firstly, an adaptive algorithm is used to estimate the unknown parameters and angular velocity of microgyroscopes. Secondly, in order to improve the performance of the system and the superiority of the super-twisting algorithm, this paper utilizes the universal approximation characteristic of the fuzzy system to approach the gain of the super-twisting sliding mode controller and identify the gain of the controller online, realizing the adaptive adjustment of the controller parameters. Simulation results verify the superiority and the effectiveness of the proposed approach, compared with adaptive super-twisting sliding mode control without fuzzy approximation; the proposed method is more effective.

1. Introduction

Microgyroscope is the basic measuring element of inertial navigation and inertial guidance system. Microgyroscope has been widely used in civil and military fields due to its advantages in cost, volume, and structure, such as oilfield survey and development, vehicle navigation and positioning systems, navigation, aerospace, and aviation. The sensitivity and accuracy of the microgyroscope will be reduced due to the errors and temperature effects during the design and manufacturing process. The main control objectives of the microgyroscope system are to compensate for manufacturing errors and to measure angular velocity. After years of research and development, the microgyroscope has made remarkable progress in precision and structural design. However, due to the limitations of precision and design principle, the development of microgyroscopes difficultly achieves a qualitative leap.

In order to improve the performance of microgyroscope and its robustness, many researchers have endeavored to study advanced technologies [1–8] applied to microgyroscopes like adaptive control, backstepping control, sliding mode control, and fuzzy control. An adaptive force-balancing

control for a micro-electro-mechanical-system z-axis gyroscope using a trajectory-switching algorithm was proposed in [1]. A novel robust adaptive control strategy for MEMS gyroscope, based on the coupling of the fuzzy control with sliding mode control (SMC) approach, was proposed in [2]. An adaptive nonsingular terminal sliding mode (NTSM) tracking control method based on backstepping design was presented for MEMS vibratory gyroscopes in [3]. In [5], an adaptive fuzzy sliding mode control problem for a microgyroscope system based on global fast terminal sliding mode approach was discussed. An adaptive sliding mode control system using a double loop recurrent neural network control method was proposed for a class of nonlinear dynamic systems in [6]. A novel adaptive super-twisting sliding mode control for a microgyroscope was discussed in [7]. The experimental evaluation and development of an optimized double closed-loop of microgyroscope were described in [8].

As an effective control method for studying uncertain objects and unpredictable systems, adaptive control is widely used in various control systems. A novel adaptive control architecture for addressing security and safety in cyberphysical systems was proposed in [9]. An adaptive tracking control for a class of stochastic uncertain nonlinear systems with

input saturation was developed in [10]. The adaptive control problem for robot manipulators with both the uncertain kinematics and dynamics was investigated in [11]. A robust adaptive control for a class of MIMO nonlinear systems was studied in [12].

Because the universal approximation theory of fuzzy system can approximate any nonlinear model and realize arbitrary nonlinear control law, it is widely used in the control systems. In [14], an adaptive fuzzy output feedback controller is constructed for the systems under consideration by utilizing an appropriate observer and the approximation ability of fuzzy systems. In [15], an adaptive backstepping controller is developed where a fuzzy system is used to approximate unknown dynamics in flexible structure. In [16], a nonsingular terminal sliding mode controller is proposed by combining adaptive fuzzy neural control approach. A new adaptive fuzzy neural control scheme is proposed for active power filters in [17]. A problem of universal fuzzy model and universal fuzzy controller for discrete-time nonaffine nonlinear systems was investigated in [18].

As a kind of second-order continuous sliding mode control algorithm, super-twisting sliding mode control algorithm has superior control performance. It is widely used in various control systems. The biggest advantage of super-twisting sliding mode control is that it can effectively solve the chattering problem of the control system and enable the system to converge in a limited time. The reason why the super-twisting algorithm can effectively suppress chattering is that it can hide the high-frequency switching part in the high-order derivative of the sliding mode variable; that is, it can transfer the discrete control law to the high-order sliding mode surface. The detailed analysis of high-order sliding mode control was discussed in [19, 20]. The strict Lyapunov functions were proposed in [21] for super-twisting sliding mode control; the proposed Lyapunov functions ascertain finite time convergence, provide an estimate of the convergence time, and ensure the robustness of the finite time or ultimate boundedness for a class of perturbations. An adaptive second-order sliding mode control strategy was proposed in [22] to maximize the energy production of a wind energy conversion system simultaneously reducing the mechanical stress on the shaft. A super-twisting sliding mode direct power control strategy for a brushless doubly fed induction generator was proposed and implemented in [23]. An improved nonsingular terminal sliding mode control based on the super-twisting algorithm is proposed for a class of second-order uncertain nonlinear systems in [24]. An output feedback stabilization of perturbed double-integrator systems using super-twisting control is studied in [25]. An adaptive super-twisting algorithm based sliding mode observer was proposed in [26] for surface-mounted permanent magnet synchronous machine (PMSM) sensorless control. A generalization of the super-twisting algorithm for perturbed chains of integrators of arbitrary order was proposed in [27]. A novel control scheme combined a continuous differentiator with an adaptive super-twisting controller for the regulation and trajectory tracking in spite of external perturbations of the three-degrees-of-freedom helicopter was presented in [28]. A hybrid control method

based on RBF neural network and super-twisting sliding mode control was proposed for the microgyroscope with unknown model in [13], the RBF neural network was used to estimate the unknown dynamic model, which provides an effective method to solve the uncertainty problem.

In [7], adaptive super-twisting controller was investigated to estimate the unknown parameters and angular velocity of microgyroscope. Because the selection of the gain value of the super-twisting sliding mode controller is very complicated, the optimal control parameters of super-twisting sliding mode controller are obtained by experience or experiment in the existing research and we need to constantly adjust it to achieve the best, which not only increases the difficulty of the numerical simulation, but also reduces the efficiency of the simulation. Therefore, the ability of super-twisting algorithm to weaken the chattering will be reduced, and the superiority of the algorithm cannot be effectively realized. Two different methods were studied to estimate the unknown dynamic model of the microgyroscope in [7, 13], but the parameters of the super-twisting sliding mode control algorithm were selected according to simulation test and experience, which reduces the superiority of the super-twisting algorithm and the efficiency of the simulation to some extent. Motivated by [7, 13] and other literatures, a novel super-twisting sliding mode control scheme based on adaptive fuzzy control for a microgyroscope is proposed by combining the advantages of the above methods in this paper, which not only solves the problem of unknown model of microgyroscope, but also enables the parameters of super-twisting algorithm to adjust online adaptively according to the fuzzy system, improving the effectiveness of the control algorithm and making the approximation of model parameters more accurate. The main features and contributions of the proposed methods compared with existing methods can be summarized as follows:

(1) An adaptive control method is adopted to identify the unknown parameters of the microgyroscope online, so that the control system does not depend on the actual mathematical model, and the design of the controller is simplified and the control performance of the system is improved.

(2) The proposed super-twisting sliding mode control algorithm can suppress the chattering of the system effectively; it can make the control system stable in limited time and, as a high-order sliding mode controller, requires less information and simplifies the complexity of the algorithm. In addition, this algorithm takes the influence of disturbance into account, which ensures that the trajectory of the control system can track its reference trajectory accurately and effectively.

(3) Compared with the existing work, the advantage of the method proposed in this paper is that it uses the universal approximation characteristic of the fuzzy system to approach the gain of the super-twisting sliding mode controller and identify the gain of the controller online, realizing the adaptive adjustment of the controller parameters and weakening the chattering.

The rest of this paper is organized as follows. The dynamics of microgyroscope is proposed in Section 2. A

description of the problem of the control system is presented in Section 3. Adaptive fuzzy super-twisting sliding mode control for microgyroscope is studied in Section 4. In order to show the superiority and effectiveness of the proposed method, the simulation analysis and comparison between the adaptive super-twisting sliding mode control based on proposed fuzzy approximation and adaptive super-twisting sliding mode control without fuzzy approximation are carried out in Section 5. Finally, the paper ends with the conclusion in Section 6.

2. Dynamics of Microgyroscope

In this section, the mathematical model of microgyroscope is presented. The main structure of microvibration gyroscope includes base mass block, cantilever beam, driving electrode, induction device, and basement. The dynamics model of the microgyroscope system can be simplified to a damping-spring-mass system, as shown in Figure 1.

Considering the influence of various manufacturing errors on the microgyroscope, the dynamic equation of the microgyroscope is established as follows:

$$\begin{aligned} m\ddot{x} + d_{xx}\dot{x} + d_{xy}\dot{y} + k_{xx}x + k_{xy}y &= u_x + 2m\Omega_z\dot{y} \\ m\ddot{y} + d_{xy}\dot{x} + d_{yy}\dot{y} + k_{xy}x + k_{yy}y &= u_y - 2m\Omega_z\dot{x} \end{aligned} \quad (1)$$

where m is the mass of mass block. x , y represent the coordinates of x-axis and y-axis system. d_{xy} is the damping coefficient. k_{xy} is the coupling coefficient. d_{xx} and d_{yy} are the damping coefficients of two axes. k_{xx} , k_{yy} are the spring coefficients of two axes. u_x , u_y represent the control inputs of two axes. Ω_z is the angular speed along the z direction.

The dynamic model of the system described by (1) is a dimensional form, which not only increases the difficulty of numerical simulation, but also increases the complexity of controller design. Dimensionless method is very valuable in numerical simulation. It can make numerical simulation easy to realize. At the same time, it can provide a unified mathematical formula for the design of various microgyroscope control systems. Therefore, it is very essential to perform dimensionless processing on the system model for simplifying the design of the controller.

The nondimensional form of microgyroscope will be given by dividing both sides of (1) with m, q_0, ω_0^2 , where m represents the mass of mass block, the reference length is q_0 , and ω_0^2 expresses the square of the resonance frequency of the two axes. Finally the dimensionless model of the dynamics is obtained as follows:

$$\begin{aligned} \ddot{x} + d_{xx}\dot{x} + d_{xy}\dot{y} + \omega_x^2x + \omega_{xy}y &= u_x + 2\Omega_z\dot{y} \\ \ddot{y} + d_{xy}\dot{x} + d_{yy}\dot{y} + \omega_{xy}x + \omega_y^2y &= u_y - 2\Omega_z\dot{x} \end{aligned} \quad (2)$$

where

$$\begin{aligned} \frac{d_{xx}}{m\omega_0} &\longrightarrow d_{xx}, \\ \frac{d_{xy}}{m\omega_0} &\longrightarrow d_{xy}, \end{aligned}$$

$$\begin{aligned} \frac{d_{yy}}{m\omega_0} &\longrightarrow d_{yy}, \\ \frac{k_{xx}}{m\omega_0^2} &\longrightarrow \omega_x^2, \\ \frac{k_{xy}}{m\omega_0^2} &\longrightarrow \omega_{xy}, \\ \frac{k_{yy}}{m\omega_0^2} &\longrightarrow \omega_y^2, \\ \frac{\Omega_z}{m\omega_0} &\longrightarrow \Omega_z \end{aligned} \quad (3)$$

Dimensionless model (2) contains two equations; the difficulty and complexity of the controller design will be improved. Therefore, it is necessary to perform an equivalent transformation on the model. The equivalent model is beneficial to the stability analysis and the application of various advanced control methods. Then formula (2) is transformed into the following vector form:

$$\ddot{q} + D\dot{q} + Kq = u - 2\Omega\dot{q} \quad (4)$$

where

$$\begin{aligned} q &= \begin{bmatrix} x \\ y \end{bmatrix}, \\ D &= \begin{bmatrix} d_{xx} & d_{xy} \\ d_{xy} & d_{yy} \end{bmatrix}, \\ K &= \begin{bmatrix} \omega_x^2 & \omega_{xy} \\ \omega_{xy} & \omega_y^2 \end{bmatrix}, \\ u &= \begin{bmatrix} u_x \\ u_y \end{bmatrix}, \\ \Omega &= \begin{bmatrix} 0 & -\Omega_z \\ \Omega_z & 0 \end{bmatrix} \end{aligned} \quad (5)$$

Considering the parameter uncertainties and external disturbances, the model of the microgyroscope system described in (4) can be modified as

$$\ddot{q} + (D + 2\Omega + \Delta D)\dot{q} + (K + \Delta K)q = u + d \quad (6)$$

where ΔD is the uncertainty of the unknown parameters of the inertia matrix $D + 2\Omega$. ΔK is the uncertainty of the unknown parameters of matrix K . d is an external disturbance.

Then, (6) can be written as

$$\ddot{q} + (D + 2\Omega)\dot{q} + Kq = u + \varphi(t) \quad (7)$$

where $\varphi(t) = d - \Delta D\dot{q} - \Delta Kq = [\varphi_1(t), \varphi_2(t)]^T$ shows the lumped model uncertainties and external disturbances.

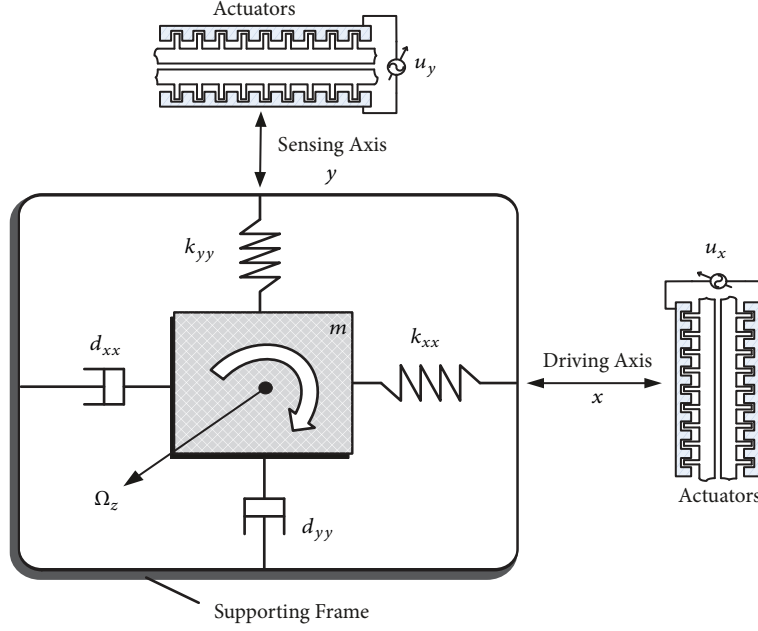

FIGURE 1: Mass-spring-damper structure of microgyroscopes [5, 7].

3. Problem Description

The control objective is to design a suitable control law that allows the system's control output to track the reference trajectory quickly and efficiently and estimate system parameters online. The designed control law consists of two parts: the equivalent control and the super-twisting sliding mode control; the super-twisting sliding mode control is used as a switching control to overcome external disturbances and uncertainties and improve the robustness of the system.

Design the controller of the microgyroscope system according to the model of the microgyroscope expressed in (7) and define the sliding mode surface as

$$s = ce + \dot{e} \quad (8)$$

where c is the coefficient of the sliding mode surface; e and \dot{e} are tracking error and the derivative of the tracking error, respectively. The expression of e and \dot{e} is as follows.

$$e = q - q_r = [q_1 - q_{r1}, q_2 - q_{r2}]^T \quad (9)$$

$$\dot{e} = \dot{q} - \dot{q}_r = [\dot{q}_1 - \dot{q}_{r1}, \dot{q}_2 - \dot{q}_{r2}]^T \quad (10)$$

where q , q_r are the output trajectory and the reference trajectory of the microgyroscope respectively.

Solving the first derivative of the sliding surface yields

$$\dot{s} = c\dot{e} + \ddot{e} = c\dot{e} + \ddot{q} - \ddot{q}_r \quad (11)$$

Substituting (7) into (11) generates

$$\dot{s} = c\dot{e} - (D + 2\Omega)\dot{q} - Kq + u + \varphi(t) - \ddot{q}_r \quad (12)$$

Without considering external disturbances, the equivalent control law can be obtained by setting $\dot{s} = 0$:

$$u_{eq} = -c\dot{e} + (D + 2\Omega)\dot{q} + Kq + \ddot{q}_r \quad (13)$$

According to the super-twisting control algorithm, the switching control law is designed as follows:

$$u_{sw} = - \begin{bmatrix} k_{11} \sqrt{|s_1|} \operatorname{sgn}(s_1) \\ k_{12} \sqrt{|s_2|} \operatorname{sgn}(s_2) \end{bmatrix} - \begin{bmatrix} k_{21} \int \operatorname{sgn}(s_1) d\tau \\ k_{22} \int \operatorname{sgn}(s_2) d\tau \end{bmatrix} \quad (14)$$

$$\text{Set } k_1, k_2 \text{ as } k_1 = \begin{bmatrix} k_{11} & 0 \\ 0 & k_{12} \end{bmatrix}, k_2 = \begin{bmatrix} k_{21} & 0 \\ 0 & k_{22} \end{bmatrix}.$$

Remark 1. k_1, k_2 as the gain of the super-twisting sliding mode controller satisfy $k_{1i} > 0, k_{2i} > 0$ and $k_{2i} > |\dot{\varphi}_i(t)|$, where $i = 1, 2$.

$\operatorname{Sgn}(s)$ is symbolic function, which is defined as

$$\operatorname{sgn}(s) = \begin{cases} -1 & \text{if } s < 0 \\ 0 & \text{if } s = 0 \\ +1 & \text{if } s > 0 \end{cases} \quad (15)$$

Then the final control law can be obtained as follows:

$$\begin{aligned} u &= u_{eq} + u_{sw} \\ &= -c\dot{e} + (D + 2\Omega)\dot{q} + Kq + \ddot{q}_r - k_1 \sqrt{|s|} \operatorname{sgn}(s) \\ &\quad - k_2 \int \operatorname{sgn}(s) d\tau \end{aligned} \quad (16)$$

However, because the parameters of the actual microgyroscope system are unknown, the control algorithm described in (16) cannot be implemented. It is necessary to design appropriate control algorithm to identify the unknown model. Moreover the selection of the parameters k_1, k_2 in the super-twisting sliding mode control is very

complicated. It needs to be selected based on experience and adjusted manually in the simulation; there is a serious uncertainty problem. Therefore, an adaptive fuzzy super-twisting sliding mode control scheme for microgyroscope system is proposed in this paper in order to solve the two problems mentioned above. Firstly, an adaptive algorithm of unknown parameters of microgyroscope system is designed to identify unknown parameters online according to the general idea of adaptive control. Secondly, the fuzzy system is used to approximate the unknown parameters of the super-twisting controller. The parameters of the controller are identified online to find the reasonable parameters, realizing the optimal control of the system.

4. Adaptive Fuzzy Super-Twisting Sliding Mode Control

4.1. Approximation Algorithm of Fuzzy Control. A brief introduction for the approximation principle of fuzzy systems is given in this part, assuming that the unknown part of the system model is $f(x) = f(x_1, x_2)$. $\hat{f}(x | \theta)$ is used to approximate $f(x)$ according to the universal approximation property of fuzzy system. Designing 5 fuzzy sets for the input x_1, x_2 of the fuzzy system respectively and setting $n = 2$, $i = 1, 2, p_1 = p_2 = 5$, there will be 25 ($p_1 \times p_2 = 25$) fuzzy rules.

The following two steps are used to construct a fuzzy system $\hat{f}(x | \theta)$.

Step 1. Defining fuzzy sets for the variable x_i ($i = 1, 2$) as $A_i^{l_i}$ ($l_i = 1, 2, 3, 4, 5$), the number of fuzzy sets is p_i .

Step 2. Constructing fuzzy systems $\hat{f}(x | \theta)$ with 25 ($\prod_{i=1}^n p_i = p_1 \times p_2 = 25$) fuzzy rules, then the j th fuzzy rule is

$$R^{(j)} : \text{IF } x_1 \text{ is } A_1^{l_1} \text{ and } x_2 \text{ is } A_1^{l_2} \text{ THEN } \hat{f} \text{ is } B^{l_1 l_2} \quad (17)$$

where $l_i = 1, 2, 3, 4, 5$, $i = 1, 2$, $j = 1, 2, \dots, 25$, and $B^{l_1 l_2}$ is the fuzzy set of conclusions.

The first and twenty-fifth fuzzy rules are expressed as

$$\begin{aligned} R^{(1)} : \text{IF } x_1 \text{ is } A_1^1 \text{ and } x_2 \text{ is } A_2^1 \text{ THEN } \hat{f} \text{ is } B^1 \\ \vdots \end{aligned} \quad (18)$$

$$R^{(25)} : \text{IF } x_1 \text{ is } A_1^5 \text{ and } x_2 \text{ is } A_1^5 \text{ THEN } \hat{f} \text{ is } B^{25}$$

The following four steps are adopted in the process of fuzzy inference.

Step 1. Using product inference engine to realize the prerequisite inference of rules, the result of inference is $\prod_{i=1}^2 \mu_{A_i}^{l_i}(x_i)$.

Step 2. Adopt singleton fuzzifier to solve $\bar{y}_f^{l_1 l_2}$.

Step 3. Using product inference engine to realize the inference of the precondition and the conclusion of the rule, the result of the inference is $\bar{y}_f^{l_1 l_2} (\prod_{i=1}^2 \mu_{A_i}^{l_i}(x_i))$. Performing the

union operations on all fuzzy rules, then the output of the fuzzy system is $\sum_{l_1=1}^5 \sum_{l_2=1}^5 \bar{y}_f^{l_1 l_2} (\prod_{i=1}^2 \mu_{A_i}^{l_i}(x_i))$.

Step 4. The output of the fuzzy system is obtained by using the average defuzzer:

$$\hat{f}(x | \theta) = \frac{\sum_{l_1=1}^5 \sum_{l_2=1}^5 \bar{y}_f^{l_1 l_2} (\prod_{i=1}^2 \mu_{A_i}^{l_i}(x_i))}{\sum_{l_1=1}^5 \sum_{l_2=1}^5 (\prod_{i=1}^2 \mu_{A_i}^{l_i}(x_i))} \quad (19)$$

where $\mu_{A_i}^{l_i}(x_i)$ is the membership function of x_i .

Let $\bar{y}_f^{l_1 l_2}$ be a free parameter and put it in the set of $\theta \in R^{(25)}$. Introducing the fuzzy basis vector $\xi(x)$, then (19) can be modified as

$$\hat{f}(x | \theta) = \tilde{\theta}^T \xi(x) \quad (20)$$

where $\tilde{\theta}^T$ is the adaptive law based on Lyapunov stability theory. $\xi(x)$ is a 25-dimensional ($\prod_{i=1}^n p_i = p_1 \times p_2 = 25$) fuzzy basis vector and the $l_1 l_2$ -th element is

$$\xi_{l_1 l_2}(x) = \frac{\prod_{i=1}^2 \mu_{A_i}^{l_i}(x_i)}{\sum_{l_1=1}^5 \sum_{l_2=1}^5 (\prod_{i=1}^2 \mu_{A_i}^{l_i}(x_i))} \quad (21)$$

4.2. Design of Adaptive Fuzzy Super-Twisting Sliding Mode Controller. In this part, we will give the design of controller based on adaptive control, fuzzy approximation and super-twisting sliding mode control. The block diagram of the adaptive fuzzy super-twisting sliding mode control is given as in Figure 2.

The parameters D, K, Ω of the actual microgyroscope are unknown; therefore, the estimated values $\widehat{D}, \widehat{K}, \widehat{\Omega}$ are used to replace the unknown true values D, K, Ω according to the general idea of adaptive control. Then (13) can be rewritten as

$$u_{eq'} = -c\dot{e} + (\widehat{D} + 2\widehat{\Omega})\dot{q} + \widehat{K}q + \dot{q}_r \quad (22)$$

According to Lyapunov stability theory to design the adaptive algorithms of the three parameters $\widehat{D}, \widehat{K}, \widehat{\Omega}$, the estimation errors of D, K, Ω are defined as

$$\begin{aligned} \widetilde{D} &= \widehat{D} - D \\ \widetilde{K} &= \widehat{K} - K \\ \widetilde{\Omega} &= \widehat{\Omega} - \Omega \end{aligned} \quad (23)$$

Then the fuzzy system is used to approximate the parameters k_1, k_2 of the super-twisting sliding mode controller, in which \widehat{h} is used to approximate the controller parameter k_1 , and \widehat{f} is used to approximate the controller parameter k_2 , and the definitions of \widehat{h} and \widehat{f} are given as follows:

$$\begin{aligned} \widehat{h}(s | \widehat{\theta}_h) &= \widehat{\theta}_h^T \phi(s) = \begin{bmatrix} \widehat{h}_1 & 0 \\ 0 & \widehat{h}_2 \end{bmatrix} \\ &= \begin{bmatrix} \widehat{\theta}_{h_1}^T \phi(s_1) & 0 \\ 0 & \widehat{\theta}_{h_2}^T \phi(s_2) \end{bmatrix} \end{aligned} \quad (24)$$

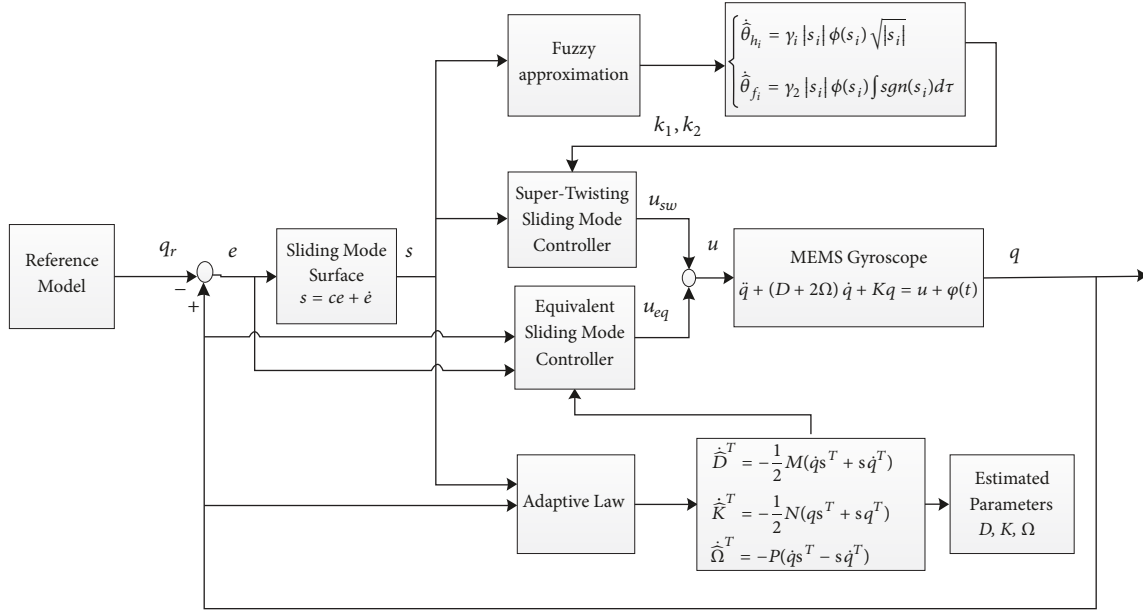

FIGURE 2: Block diagram of the adaptive fuzzy super-twisting sliding mode control.

$$\begin{aligned} \hat{f}(s | \hat{\theta}_f) &= \hat{\theta}_f^T \phi(s) = \begin{bmatrix} \hat{f}_1 & 0 \\ 0 & \hat{f}_2 \end{bmatrix} \\ &= \begin{bmatrix} \hat{\theta}_{f_1}^T \phi(s_1) & 0 \\ 0 & \hat{\theta}_{f_2}^T \phi(s_2) \end{bmatrix} \end{aligned} \quad (25)$$

Here $\hat{h}(s | \hat{\theta}_h)$ and $\hat{f}(s | \hat{\theta}_f)$ are the outputs of the fuzzy system, $\phi(s)$ is a matrix composed of fuzzy basis vectors and $\phi(s) = \begin{bmatrix} \phi(s_1) & 0 \\ 0 & \phi(s_2) \end{bmatrix}$, and $\hat{\theta}_h^T$ and $\hat{\theta}_f^T$ will change according to the adaptive laws, where $\hat{\theta}_h^T = \begin{bmatrix} \hat{\theta}_{h_1}^T & 0 \\ 0 & \hat{\theta}_{h_2}^T \end{bmatrix}$, $\hat{\theta}_f^T = \begin{bmatrix} \hat{\theta}_{f_1}^T & 0 \\ 0 & \hat{\theta}_{f_2}^T \end{bmatrix}$

Then (16) can be rewritten as

$$\begin{aligned} u &= u_{eq} + u_{sw} \\ &= -c\dot{e} + (\hat{D} + 2\hat{\Omega})\dot{q} + \hat{K}q + \ddot{q}_r - \hat{h}\sqrt{|s|} \operatorname{sgn}(s) \\ &\quad - \hat{f} \int \operatorname{sgn}(s) d\tau \end{aligned} \quad (26)$$

The ideal value of $\hat{h}(s | \hat{\theta}_h)$ is $\hat{h}(s | \theta_h^*) = k_1$ and the ideal value of $\hat{f}(s | \hat{\theta}_f)$ is $\hat{f}(s | \theta_f^*) = k_2$.

The optimal parameters are defined as

$$\begin{aligned} \theta_h^* &= \arg \min_{\theta_h \in \Omega_h} [\sup |\hat{h}(s | \hat{\theta}_h) - k_1|] \\ \theta_f^* &= \arg \min_{\theta_f \in \Omega_f} [\sup |\hat{f}(s | \hat{\theta}_f) - k_2|] \end{aligned} \quad (27)$$

where Ω_h and Ω_f are the sets of θ_h and θ_f , respectively.

Substituting (26) into (12) generates

$$\begin{aligned} \dot{s} &= -(D + 2\Omega)\dot{q} + (\hat{D} + 2\hat{\Omega})\dot{q} - Kq + \hat{K}q \\ &\quad - \hat{h}\sqrt{|s|} \operatorname{sgn}(s) - \hat{f} \int \operatorname{sgn}(s) d\tau + \varphi(t) \\ &= (\hat{D} + 2\hat{\Omega})\dot{q} + \hat{K}q - \hat{h}\sqrt{|s|} \operatorname{sgn}(s) - \hat{f} \int \operatorname{sgn}(s) d\tau \\ &\quad + \varphi(t) \\ &= (\hat{D} + 2\hat{\Omega})\dot{q} + \hat{K}q - \hat{h}(s | \hat{\theta}_h) \sqrt{|s|} \operatorname{sgn}(s) \\ &\quad + \hat{h}(s | \theta_h^*) \sqrt{|s|} \operatorname{sgn}(s) - \hat{h}(s | \theta_h^*) \sqrt{|s|} \operatorname{sgn}(s) \\ &\quad - \hat{f}(s | \hat{\theta}_f) \int \operatorname{sgn}(s) d\tau \\ &\quad + \hat{f}(s | \theta_f^*) \int \operatorname{sgn}(s) d\tau \\ &\quad - \hat{f}(s | \theta_f^*) \int \operatorname{sgn}(s) d\tau + \varphi(t) \\ &= (\hat{D} + 2\hat{\Omega})\dot{q} + \hat{K}q + \hat{\theta}_h^T \phi(s) \sqrt{|s|} \operatorname{sgn}(s) \\ &\quad - \hat{h}(s | \theta_h^*) \sqrt{|s|} \operatorname{sgn}(s) + \hat{\theta}_f^T \phi(s) \int \operatorname{sgn}(s) d\tau \\ &\quad - \hat{f}(s | \theta_f^*) \int \operatorname{sgn}(s) d\tau + \varphi(t) \end{aligned} \quad (28)$$

$$\text{where } \tilde{\theta}_h = \theta_h^* - \hat{\theta}_h, \tilde{\theta}_f = \theta_f^* - \hat{\theta}_f.$$

Theorem 2. If the adaptive laws of the unknown parameters of the microgyroscope model and the parameters of the super-twisting sliding mode controller are designed as (29) and (30),

the system will be able to reach the stable state in a finite time, and all unknown parameters of the microgyroscope including the angular rate can be accurately estimated:

$$\begin{aligned}\dot{\bar{D}}^T &= -\frac{1}{2}M(\dot{q}s^T + s\dot{q}^T) \\ \dot{\bar{K}}^T &= -\frac{1}{2}N(qs^T + sq^T)\end{aligned}\quad (29)$$

$$\begin{aligned}\dot{\bar{\Omega}}^T &= -P(\dot{q}s^T - s\dot{q}^T) \\ \dot{\hat{\theta}}_{h_1} &= \gamma_1 |s_1| \phi(s_1) \sqrt{|s_1|} \\ \dot{\hat{\theta}}_{h_2} &= \gamma_1 |s_2| \phi(s_2) \sqrt{|s_2|} \\ \dot{\hat{\theta}}_{f_1} &= \gamma_2 |s_1| \phi(s_1) \int \text{sgn}(s_1) d\tau \\ \dot{\hat{\theta}}_{f_2} &= \gamma_2 |s_2| \phi(s_2) \int \text{sgn}(s_2) d\tau\end{aligned}\quad (30)$$

Here M, N , and P are positive definite symmetric matrices and satisfy $M = M^T > 0, N = N^T > 0, P = P^T > 0$.

4.3. Stability Analysis. Stability analysis and proof will be given in this part. First, the Lyapunov function is defined as

$$\begin{aligned}V &= \frac{1}{2}s^T s + \frac{1}{2} \text{tr} \{ \bar{D}M^{-1}\bar{D}^T \} + \frac{1}{2} \text{tr} \{ \bar{K}N^{-1}\bar{K}^T \} \\ &+ \frac{1}{2} \text{tr} \{ \bar{\Omega}P^{-1}\bar{\Omega}^T \} + \frac{1}{2} \frac{1}{\gamma_1} \sum_{i=1}^2 \bar{\theta}_{h_i}^T \dot{\hat{\theta}}_{h_i} + \frac{1}{2} \frac{1}{\gamma_2} \sum_{i=1}^2 \bar{\theta}_{f_i}^T \dot{\hat{\theta}}_{f_i}\end{aligned}\quad (31)$$

where $\text{tr}\{\cdot\}$ represents the inverse operation of the matrix, M, N , and P satisfy $M = M^T > 0, N = N^T > 0, P = P^T > 0$. Then the derivative of V can be obtained as

$$\begin{aligned}\dot{V} &= s^T \dot{s} + \text{tr} \{ \bar{D}M^{-1}\dot{\bar{D}}^T \} + \text{tr} \{ \bar{K}N^{-1}\dot{\bar{K}}^T \} \\ &+ \text{tr} \{ \bar{\Omega}M^{-1}\dot{\bar{\Omega}}^T \} + \frac{1}{\gamma_1} \sum_{i=1}^2 \bar{\theta}_{h_i}^T \dot{\hat{\theta}}_{h_i} + \frac{1}{\gamma_2} \sum_{i=1}^2 \bar{\theta}_{f_i}^T \dot{\hat{\theta}}_{f_i}\end{aligned}\quad (32)$$

Substituting (28) into (32) generates

$$\begin{aligned}\dot{V} &= s^T \left((\bar{D} + 2\bar{\Omega}) \dot{q} + \bar{K}q + \bar{\theta}_h^T \phi(s) \sqrt{|s|} \text{sgn}(s) \right. \\ &- \hat{h}(s | \theta_h^*) \sqrt{|s|} \text{sgn}(s) + \bar{\theta}_f^T \phi(s) \int \text{sgn}(s) d\tau \\ &- \hat{f}(s | \theta_f^*) \int \text{sgn}(s) d\tau + \varphi(t) \left. \right) + \text{tr} \{ \bar{D}M^{-1}\dot{\bar{D}}^T \} \\ &+ \text{tr} \{ \bar{K}N^{-1}\dot{\bar{K}}^T \} + \text{tr} \{ \bar{\Omega}M^{-1}\dot{\bar{\Omega}}^T \} + \frac{1}{\gamma_1} \sum_{i=1}^2 \bar{\theta}_{h_i}^T \dot{\hat{\theta}}_{h_i} \\ &+ \frac{1}{\gamma_2} \sum_{i=1}^2 \bar{\theta}_{f_i}^T \dot{\hat{\theta}}_{f_i} = s^T \left(\bar{\theta}_h^T \phi(s) \sqrt{|s|} \text{sgn}(s) \right. \\ &- \hat{h}(s | \theta_h^*) \sqrt{|s|} \text{sgn}(s) + \bar{\theta}_f^T \phi(s) \int \text{sgn}(s) d\tau\end{aligned}$$

$$\begin{aligned}&- \hat{f}(s | \theta_f^*) \int \text{sgn}(s) d\tau + \varphi(t) \left. \right) + s^T \bar{D} \dot{q} \\ &+ \text{tr} \{ \bar{D}M^{-1}\dot{\bar{D}}^T \} + s^T \bar{K}q + \text{tr} \{ \bar{K}N^{-1}\dot{\bar{K}}^T \} \\ &+ 2s^T \bar{\Omega} \dot{q} + \text{tr} \{ \bar{\Omega}M^{-1}\dot{\bar{\Omega}}^T \} + \frac{1}{\gamma_1} \sum_{i=1}^2 \bar{\theta}_{h_i}^T \dot{\hat{\theta}}_{h_i} + \frac{1}{\gamma_2} \\ &\cdot \sum_{i=1}^2 \bar{\theta}_{f_i}^T \dot{\hat{\theta}}_{f_i}\end{aligned}\quad (33)$$

Because $D = D^T, K = K^T, \Omega = -\Omega^T$, and $s^T \bar{D} \dot{q} = \dot{q}^T \bar{D} s$ (it is scalar), then (34) can be obtained.

$$s^T \bar{D} \dot{q} = \frac{1}{2} (s^T \bar{D} \dot{q} + \dot{q}^T \bar{D} s) \quad (34)$$

Meanwhile, the following equation also can be obtained.

$$s^T \bar{K}q = \frac{1}{2} (s^T \bar{K}q + q^T \bar{K}s) \quad (35)$$

$$2s^T \bar{\Omega} \dot{q} = \frac{1}{2} (2s^T \bar{\Omega} \dot{q} - 2\dot{q}^T \bar{\Omega} s)$$

Therefore, (33) can be modified as follows:

$$\begin{aligned}\dot{V} &= s^T \left(\bar{\theta}_h^T \phi(s) \sqrt{|s|} \text{sgn}(s) - \hat{h}(s | \theta_h^*) \sqrt{|s|} \text{sgn}(s) \right. \\ &+ \bar{\theta}_f^T \phi(s) \int \text{sgn}(s) d\tau - \hat{f}(s | \theta_f^*) \int \text{sgn}(s) d\tau \\ &+ \varphi(t) \left. \right) + \text{tr} \left\{ \bar{D} \left[M^{-1}\dot{\bar{D}}^T + \frac{1}{2} (\dot{q}s^T + s\dot{q}^T) \right] \right\} \\ &+ \text{tr} \left\{ \bar{K} \left[N^{-1}\dot{\bar{K}}^T + \frac{1}{2} (qs^T + sq^T) \right] \right\} \\ &+ \text{tr} \left\{ \bar{\Omega} \left[P^{-1}\dot{\bar{\Omega}}^T + \frac{1}{2} (2\dot{q}s^T - 2s\dot{q}^T) \right] \right\} + \frac{1}{\gamma_1} \\ &\cdot \sum_{i=1}^2 \bar{\theta}_{h_i}^T \dot{\hat{\theta}}_{h_i} + \frac{1}{\gamma_2} \sum_{i=1}^2 \bar{\theta}_{f_i}^T \dot{\hat{\theta}}_{f_i}\end{aligned}\quad (36)$$

The adaptive laws of the unknown parameters $\bar{D}, \bar{K}, \bar{\Omega}$ are designed as (29) according to the Lyapunov stability theory. Therefore, substituting (29) into (36) yields

$$\begin{aligned}\dot{V} &= s^T \left(\bar{\theta}_h^T \phi(s) \sqrt{|s|} \text{sgn}(s) - \hat{h}(s | \theta_h^*) \sqrt{|s|} \text{sgn}(s) \right. \\ &+ \bar{\theta}_f^T \phi(s) \int \text{sgn}(s) d\tau - \hat{f}(s | \theta_f^*) \int \text{sgn}(s) d\tau \\ &+ \varphi(t) \left. \right) + \frac{1}{\gamma_1} \sum_{i=1}^2 \bar{\theta}_{h_i}^T \dot{\hat{\theta}}_{h_i} + \frac{1}{\gamma_2} \sum_{i=1}^2 \bar{\theta}_{f_i}^T \dot{\hat{\theta}}_{f_i} = |s^T| \bar{\theta}_h^T \phi(s) \\ &\cdot \sqrt{|s|} + s^T \bar{\theta}_f^T \phi(s) \int \text{sgn}(s) d\tau + \frac{1}{\gamma_1} \sum_{i=1}^2 \bar{\theta}_{h_i}^T \dot{\hat{\theta}}_{h_i} + \frac{1}{\gamma_2} \\ &\cdot \sum_{i=1}^2 \bar{\theta}_{f_i}^T \dot{\hat{\theta}}_{f_i} + s^T \left(-\hat{h}(s | \theta_h^*) \sqrt{|s|} \text{sgn}(s) \right.\end{aligned}$$

$$\begin{aligned}
& -\hat{f}(s | \theta_f^*) \int \operatorname{sgn}(s) d\tau + \varphi(t) \\
& = \sum_{i=1}^2 |s_i| \tilde{\theta}_{h_i}^T \phi(s_i) \sqrt{|s_i|} + \sum_{i=1}^2 s_i \tilde{\theta}_{f_i}^T \phi(s_i) \int \operatorname{sgn}(s_i) d\tau \\
& + \frac{1}{\gamma_1} \sum_{i=1}^2 \tilde{\theta}_{h_i}^T \dot{\theta}_{h_i} + \frac{1}{\gamma_2} \sum_{i=1}^2 \tilde{\theta}_{f_i}^T \dot{\theta}_{f_i} \\
& + s^T \left(-\hat{h}(s | \theta_h^*) \sqrt{|s|} \operatorname{sgn}(s) \right. \\
& \left. - \hat{f}(s | \theta_f^*) \int \operatorname{sgn}(s) d\tau + \varphi(t) \right) = \frac{1}{\gamma_1} \\
& \cdot \sum_{i=1}^2 \tilde{\theta}_{h_i}^T \left(\gamma_1 |s_i| \phi(s_i) \sqrt{|s_i|} + \dot{\theta}_{h_i} \right) + \frac{1}{\gamma_2} \\
& \cdot \sum_{i=1}^2 \tilde{\theta}_{f_i}^T \left(s_i \phi(s_i) \int \operatorname{sgn}(s_i) d\tau + \dot{\theta}_{f_i} \right) \\
& + s^T \left(-\hat{h}(s | \theta_h^*) \sqrt{|s|} \operatorname{sgn}(s) \right. \\
& \left. - \hat{f}(s | \theta_f^*) \int \operatorname{sgn}(s) d\tau + \varphi(t) \right)
\end{aligned} \tag{37}$$

Because $\dot{\theta}_{h_i} = -\dot{\tilde{\theta}}_{h_i}$, $\dot{\theta}_{f_i} = -\dot{\tilde{\theta}}_{f_i}$, and $\hat{h}(s | \theta_h^*) = k_1$, $\hat{f}(s | \theta_f^*) = k_2$, in order to ensure $\dot{V} \leq 0$, the adaptive laws of the super-twisting sliding mode controller parameters are designed as (30).

Simplify (30) as

$$\begin{aligned}
\dot{\theta}_{h_i} &= \gamma_1 |s_i| \phi(s_i) \sqrt{|s_i|} \\
\dot{\theta}_{f_i} &= \gamma_2 |s_i| \phi(s_i) \int \operatorname{sgn}(s_i) d\tau
\end{aligned} \tag{38}$$

Substituting (38) into (37) generates

$$\begin{aligned}
\dot{V} &= s^T \left(-k_1 \sqrt{|s|} \operatorname{sgn}(s) - k_2 \int \operatorname{sgn}(s) d\tau + \varphi(t) \right) \\
&= -\sum_{i=1}^2 |s_i| k_{1i} \sqrt{|s_i|} - \sum_{i=1}^2 s_i k_{2i} \int \operatorname{sgn}(s_i) d\tau \\
&+ \sum_{i=1}^2 s_i \varphi_i(t) \\
&\leq -\sum_{i=1}^2 |s_i| k_{1i} \sqrt{|s_i|} - \sum_{i=1}^2 |s_i| \int k_{2i} d\tau \\
&+ \sum_{i=1}^2 |s_i| \int |\dot{\varphi}_i(t)| d\tau
\end{aligned}$$

TABLE I: Parameters of microgyroscope.

Parameters	Values
m	$1.8 \times 10^{-7} kg$
k_{xx}	$63.955 N/m$
k_{yy}	$95.92 N/m$
k_{xy}	$12.779 N/m$
d_{xx}	$1.8 \times 10^{-6} Ns/m$
d_{yy}	$1.8 \times 10^{-6} Ns/m$
d_{xy}	$3.6 \times 10^{-7} Ns/m$

$$\begin{aligned}
&\leq -\sum_{i=1}^2 |s_i| k_{1i} \sqrt{|s_i|} \\
&- \sum_{i=1}^2 |s_i| \left(\int k_{2i} d\tau - \int |\dot{\varphi}_i(t)| d\tau \right)
\end{aligned} \tag{39}$$

Since $k_{1i} > 0$, $k_{2i} > 0$ and $k_{2i} > |\dot{\varphi}_i(t)|$, then (39) can be simplified as

$$\dot{V} \leq -\sum_{i=1}^2 |s_i| k_{1i} \sqrt{|s_i|} \leq 0 \tag{40}$$

According to the Lyapunov stability criterion, \dot{V} is seminegative definite, which guarantees the global asymptotic stability of the system and ensures that the controlled system can reach stable state in limited time. The seminegative definite matrices of \dot{V} guarantee that V and s are bounded. According to Barbalat theorem and its corollaries, $s(t)$ will tend to zero, and then e and \dot{e} will also tend to zero in limited time, which guarantees the robustness and stability of the system.

5. Simulation Study

In this section, the Matlab simulation software is used to verify the proposed adaptive fuzzy super-twisting sliding mode control method. The unknown parameters D, K, Ω of the microgyroscope system are estimated online, and the fuzzy approximation theory is used to identify the parameters of the super-twisting sliding mode controller. In order to clarify the effectiveness and superiority of the adaptive fuzzy super-twisting sliding mode control method studied in this paper, the simulations were implemented in Matlab/Simulink environment for both adaptive fuzzy super-twisting sliding mode control and adaptive super-twisting sliding mode control without fuzzy approximation. Parameters of the microgyroscope are chosen as Table 1.

The angular velocity of the input of the microgyroscope is assumed to be $\Omega_z = 100$ rad/s. Then the dimensionless processing to the microgyroscope is carried out, in order to make the numerical simulation easier to realize and simplify the design of the controller. The reference length q_0 and the reference frequency ω_0 are selected as $1 \mu m$ and $1000 Hz$, respectively. Therefore, the dimensionless parameters of the microgyroscope system are obtained as Table 2.

TABLE 2: Dimensionless parameters of microgyroscope [13].

Parameters	Values
ω_x^2	355.3
ω_y^2	532.9
ω_{xy}	70.99
d_{xx}	0.01
d_{yy}	0.01
d_{xy}	0.002
Ω_z	0.1

TABLE 3: Parameters of system and controller.

Parameters	Values
$q_1(0)$	1
$\dot{q}_1(0)$	0
$q_2(0)$	0.5
$\dot{q}_2(0)$	0
q_{r1}	$\sin(\pi t)$
q_{r2}	$\cos(0.5\pi t)$
$\widehat{D}(0)$	$0.95 * D$
$\widehat{K}(0)$	$0.95 * K$
$\widehat{\Omega}(0)$	0
$M = N = P$	$diag(150, 150)$
γ_1	6
γ_2	6
d	$[0.5 * randn(1, 1); 0.5 * randn(1, 1)]$
c	10

The matrices of the dimensionless parameter of the microgyroscope system are expressed as follows:

$$\begin{aligned}
 D &= \begin{bmatrix} 0.01 & 0.002 \\ 0.002 & 0.01 \end{bmatrix}, \\
 K &= \begin{bmatrix} 355.3 & 70.99 \\ 70.99 & 532.9 \end{bmatrix}, \\
 \Omega &= \begin{bmatrix} 0 & -0.1 \\ 0.1 & 0 \end{bmatrix}
 \end{aligned} \quad (41)$$

The other parameters of the microgyroscope and controller are selected as Table 3.

Here $q_1(0), \dot{q}_1(0), q_2(0), \dot{q}_2(0)$ represent the initial states of the system. The reference trajectories of the x - and y -axis are set as q_{r1}, q_{r2} , respectively. The estimated values of the three parameter matrices are $\widehat{D}(0), \widehat{K}(0), \widehat{\Omega}(0)$. The sliding coefficient is c . M, N, P represent adaptive gains. Define the membership functions of the sliding surface s_i as $\mu_{NM}(s_i) = 1/(1 + \exp(5(s_i + 3)))$, $\mu_{ZO}(s_i) = \exp(-s_i^2)$, $\mu_{PM}(s_i) = 1/(1 + \exp(5(s_i - 3)))$. γ_1 and γ_2 are adaptive parameters. The controller parameters k_1, k_2 of the adaptive super-twisting sliding mode control without fuzzy approximation are selected as 10, 20, respectively. Random signal d is considered as external

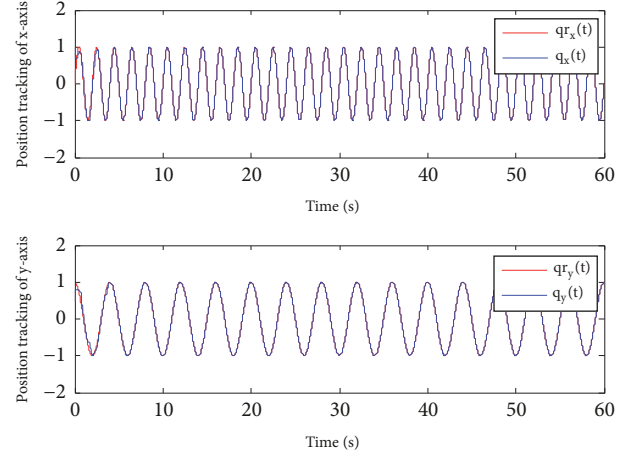

FIGURE 3: Position tracking of microgyroscope system under adaptive fuzzy super-twisting sliding mode control.

disturbance. The simulation time is set as 60s, and the simulation results are shown in Figures 3–14.

Figure 3 shows the position tracking of the x - and y -axis under the adaptive fuzzy super-twisting sliding mode control. Figures 4 and 5 show the position tracking error under the adaptive fuzzy super-twisting sliding mode control and adaptive super-twisting sliding mode control without fuzzy approximation, respectively. Figures 4 and 5 show that both two controllers can make the tracking errors decrease and converge to zero quickly. However, the adaptive fuzzy super-twisting sliding mode control method proposed in this paper can achieve more effective and accurate tracking and reach the reference trajectory in a shorter finite time than the method in Figure 5.

Figure 6 indicates the control input of the x - and y -axis of the microgyroscope under the adaptive fuzzy super-twisting sliding mode control. It can be seen from the diagram that the chattering of the control input can be avoided effectively under the adaptive fuzzy super-twisting sliding mode control.

The estimated values of d_{xx}, d_{xy}, d_{yy} and w_x^2, w_{xy}, w_y^2 under two methods are described in Figures 7–10. It is observed that the estimated values of d_{xx}, d_{xy}, d_{yy} and w_x^2, w_{xy}, w_y^2 under the adaptive fuzzy super-twisting sliding mode control can converge to their true values in shorter time and are closer to the true values than that under the adaptive super-twisting sliding mode control without fuzzy approximation.

Figures 11 and 12 indicate the estimated value of Ω_z under two schemes. It is obvious that the adaptive fuzzy super-twisting sliding mode control has a better estimation effect. Simulation results also verify that the estimated value of Ω_z under the adaptive fuzzy super-twisting sliding mode control can converge to its true value in shorter time and overshoot is smaller than that under the adaptive super-twisting sliding mode control without fuzzy approximation.

Figures 13 and 14 are the fuzzy approximation curves of the parameters k_1 and k_2 of the super-twisting sliding mode controller under the adaptive fuzzy super-twisting sliding

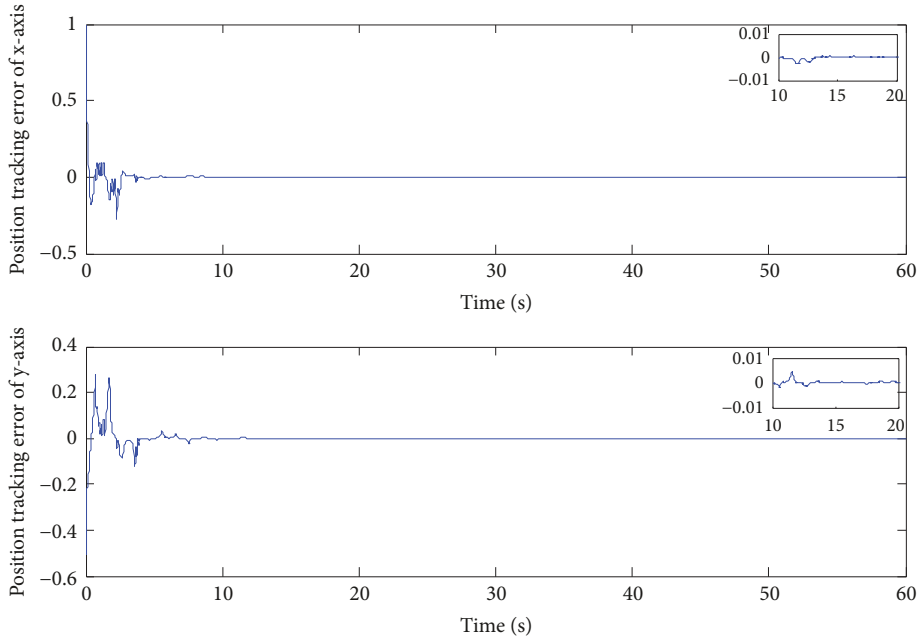

FIGURE 4: Position tracking error of microgroscope system under adaptive fuzzy super-twisting sliding mode control.

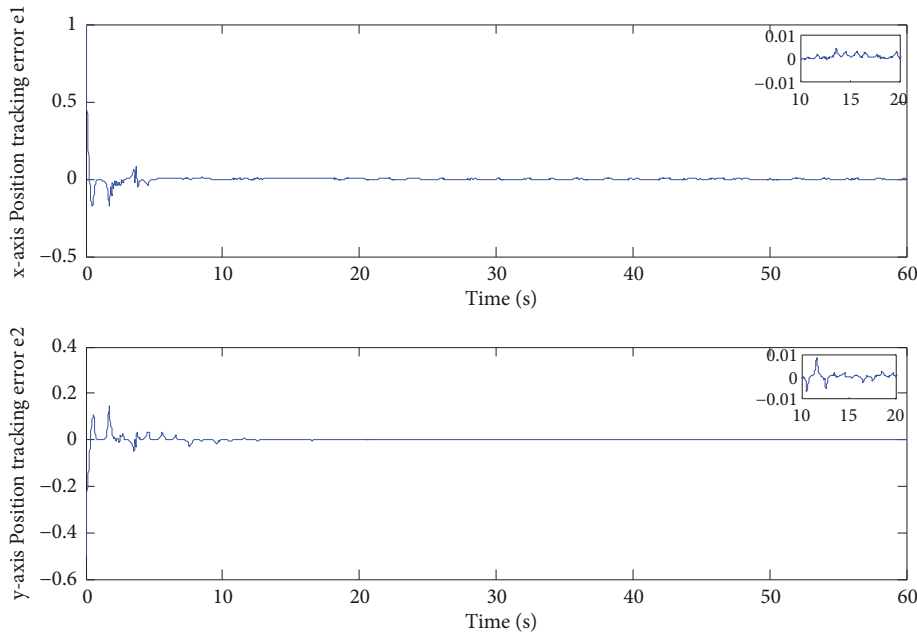

FIGURE 5: Position tracking error of microgroscope system under adaptive super-twisting sliding mode control without fuzzy approximation.

mode control method. It can be seen from Figures 13 and 14 that fuzzy system can effectively approximate the unknown parameters of the controller, improving the performance of the control system.

In order to illustrate the superiority of the proposed scheme clearly, the root mean square error (RMSE) of x - and y -axis between adaptive fuzzy super-twisting sliding mode control and adaptive super-twisting sliding mode control without fuzzy approximation is analyzed. The validity and accuracy of the proposed method can be well proved by using RMSE. The comparison of the RMSE is shown in Table 4.

Table 4 indicates that the RMSE under adaptive fuzzy super-twisting sliding mode control is smaller than that under the adaptive super-twisting sliding mode control without fuzzy approximation. All these simulation results and analyses prove the advantage and validity of the proposed method.

6. Conclusion

Through the comparison and analysis of the simulation results above, it can be seen that the proposed method

TABLE 4: RMSE of x -axis and y -axis under two methods.

Control method	RMSE	
	X	Y
Adaptive fuzzy ST-SMC	0.1105	0.0601
Adaptive ST-SMC without fuzzy approximation	0.1370	0.0703

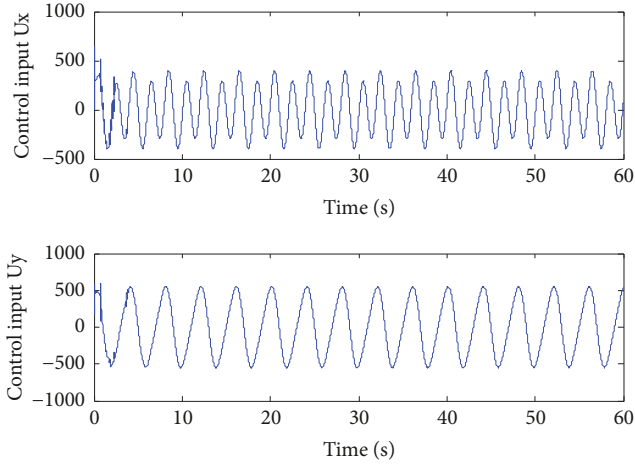
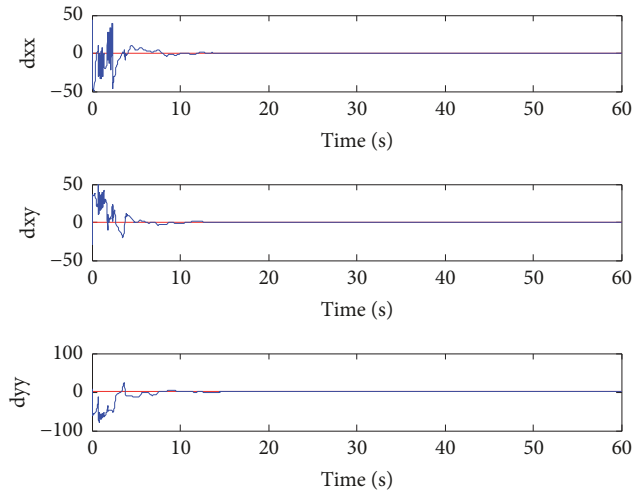
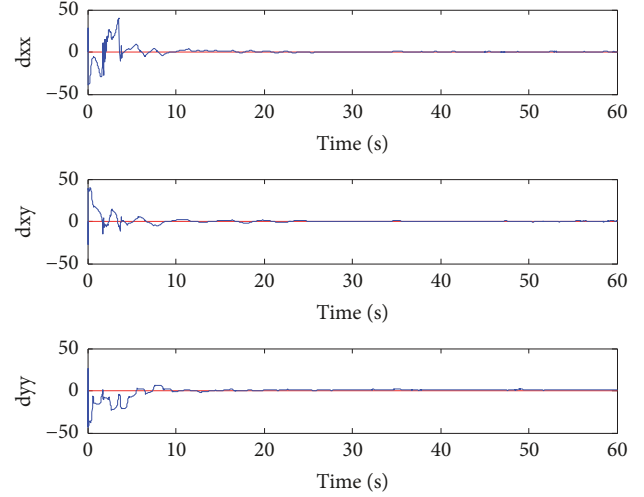
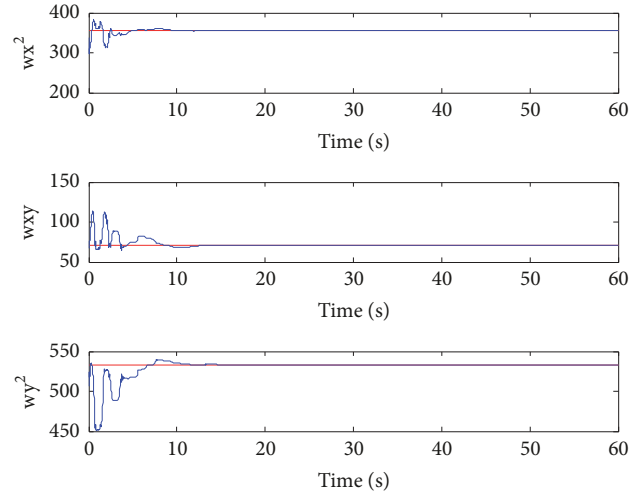

FIGURE 6: Control input of microgyroscope system under adaptive fuzzy super-twisting sliding mode control.

FIGURE 7: Estimated values of d_{xx} , d_{xy} , d_{yy} under adaptive fuzzy super-twisting sliding mode control.

is superior to the adaptive super-twisting sliding mode control without fuzzy approximation in all aspects. The proposed method in this paper can not only identify the unknown parameters of the microgyroscope system more effectively, but also adjust the parameters of the super-twisting controller adaptively. It is more effective in ensuring the stability, robustness, and accuracy of the system. The simulation results demonstrate the superiority of the proposed method. In the current step, we implemented simulation study to verify the effectiveness of the proposed methods.

FIGURE 8: Estimated values of d_{xx} , d_{xy} , d_{yy} under adaptive super-twisting sliding mode control without fuzzy approximation.FIGURE 9: Estimated values of w_x^2 , w_{xy} , w_y^2 under adaptive fuzzy super-twisting sliding mode control.

Experimental verification is needed to verify the validity in the practical application, which will be the next research steps.

Data Availability

The data used to support the findings of this study are available from the corresponding author upon request.

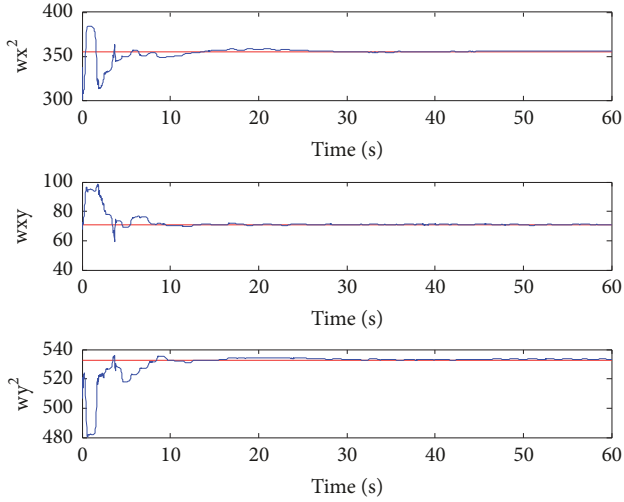

FIGURE 10: Estimated values of w_x^2, w_{xy}, w_y^2 under adaptive super-twisting sliding mode control without fuzzy approximation.

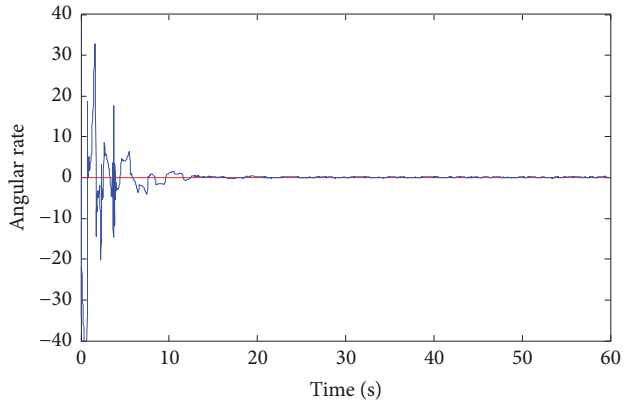

FIGURE 11: Estimated value of Ω_z under adaptive fuzzy super-twisting sliding mode control.

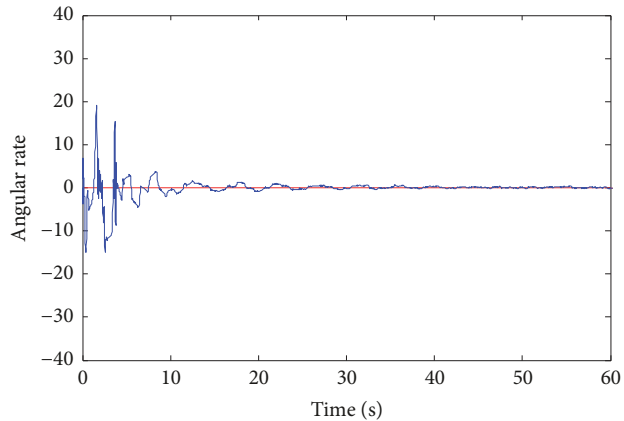

FIGURE 12: Estimated value of Ω_z under adaptive super-twisting sliding mode control without fuzzy approximation.

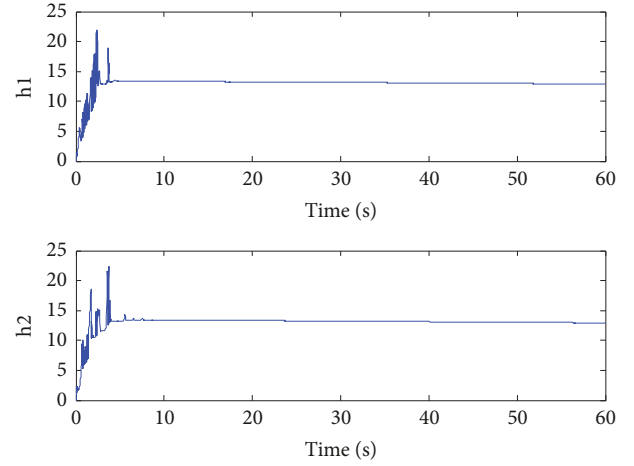

FIGURE 13: Fuzzy approximation curve of parameter k_1 under adaptive fuzzy super-twisting sliding mode control.

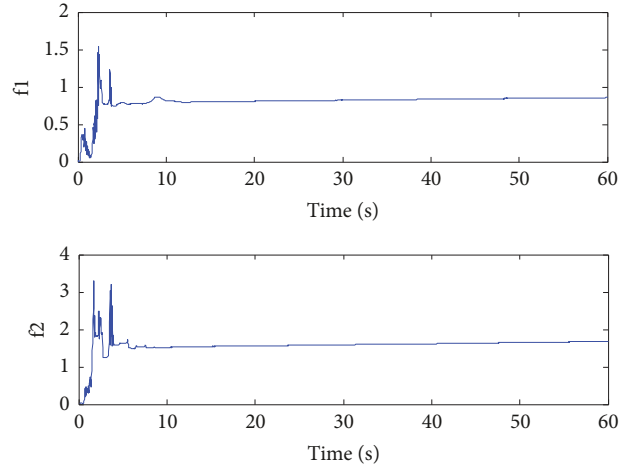

FIGURE 14: Fuzzy approximation curve of parameter k_2 under adaptive fuzzy super-twisting sliding mode control.

Conflicts of Interest

The authors declare that there are no conflicts of interest regarding the publication of this paper.

Acknowledgments

This work is supported by the National Natural Science Foundation of China under Grant No. 61873085, Natural Science Foundation of Jiangsu Province under Grant No. BK20171198, the University Graduate Research and Innovation Projects of Jiangsu Province under Grant No. KYCX19_0540, and the Fundamental Research Funds for the Central Universities under Grant No. 2017B 20014.

References

- [1] S. Park, R. Horowitz, S. K. Hong, and Y. Nam, "Trajectory-switching algorithm for a MEMS gyroscope," *IEEE Transactions*

- on *Instrumentation and Measurement*, vol. 56, no. 6, pp. 2561–2569, 2007.
- [2] J. Fei and J. Zhou, “Robust adaptive control of MEMS triaxial gyroscope using fuzzy compensator,” *IEEE Transactions on Systems, Man, and Cybernetics, Part B: Cybernetics*, vol. 42, no. 6, pp. 1599–1607, 2012.
 - [3] Y. Fang, J. Fei, and Y. Yang, “Adaptive backstepping design of a microgyroscope,” *Micromachines*, vol. 9, no. 7, p. 338, 2018.
 - [4] J. Fei and C. Lu, “Adaptive fractional order sliding mode controller with neural estimator,” *Journal of The Franklin Institute*, vol. 355, no. 5, pp. 2369–2391, 2018.
 - [5] J. Fei and X. Liang, “Adaptive backstepping fuzzy-neural-network fractional order control of microgyroscope using nonsingular terminal sliding mode controller,” *Complexity*, vol. 2018, Article ID 5246074, 12 pages, 2018.
 - [6] J. Fei and C. Lu, “Adaptive sliding mode control of dynamic systems using double loop recurrent neural network structure,” *IEEE Transactions on Neural Networks and Learning Systems*, vol. 29, no. 4, pp. 1275–1286, 2017.
 - [7] Z. Feng and J. Fei, “Design and analysis of adaptive Super-Twisting sliding mode control for a microgyroscope,” *PLoS ONE*, vol. 13, no. 1, Article ID e0189457, 2018.
 - [8] F. Chen, W. Yuan, H. Chang, G. Yuan, J. Xie, and M. Kraft, “Design and implementation of an optimized double closed-loop control system for MEMS vibratory gyroscope,” *IEEE Sensors Journal*, vol. 14, no. 1, pp. 184–196, 2014.
 - [9] X. Jin, W. M. Haddad, and T. Yucelen, “An adaptive control architecture for mitigating sensor and actuator attacks in cyber-physical systems,” *IEEE Transactions on Automatic Control*, vol. 62, no. 11, pp. 6058–6064, 2017.
 - [10] Y.-F. Gao, X.-M. Sun, C. Wen, and W. Wang, “Adaptive tracking control for a class of stochastic uncertain nonlinear systems with input saturation,” *Institute of Electrical and Electronics Engineers Transactions on Automatic Control*, vol. 62, no. 5, pp. 2498–2504, 2017.
 - [11] F. Jaramillo-Lopez, G. Kenne, and F. Lamnabhi-Lagarrigue, “Adaptive control for a class of uncertain nonlinear systems: application to photovoltaic control systems,” *Institute of Electrical and Electronics Engineers Transactions on Automatic Control*, vol. 62, no. 1, pp. 393–398, 2017.
 - [12] S. S. Ge and Z. Li, “Robust adaptive control for a class of MIMO nonlinear systems by state and output feedback,” *IEEE Transactions on Automatic Control*, vol. 59, no. 6, pp. 1624–1629, 2014.
 - [13] Z. Feng and J. Fei, “Super-twisting sliding mode control for micro gyroscope based on rbf neural network,” *IEEE Access*, 2018.
 - [14] X. Zhao, X. Wang, G. Zong, and H. Li, “Fuzzy-approximation-based adaptive output-feedback control for uncertain non-smooth nonlinear systems,” *IEEE Transactions on Fuzzy Systems*, vol. 26, no. 6, pp. 3847–3859, 2018.
 - [15] Y. Fang, J. Fei, and T. Hu, “Adaptive backstepping fuzzy sliding mode vibration control of flexible structure,” *Journal of Low Frequency Noise, Vibration and Active Control*, vol. 37, no. 4, pp. 1079–1096, 2018.
 - [16] S. Hou and J. Fei, “Finite-time adaptive fuzzy-neural-network control of active power filter,” *IEEE Transactions on Power Electronics*, pp. 1-1, 2019.
 - [17] J. Fei and T. Wang, “Adaptive fuzzy-neural-network based on RBFNN control for active power filter,” *International Journal of Machine Learning and Cybernetics*, vol. 6, pp. 1–12, 2018.
 - [18] Q. Gao, G. Feng, D. Dong, and L. Liu, “Universal fuzzy models and universal fuzzy controllers for discrete-time nonlinear systems,” *IEEE Transactions on Cybernetics*, vol. 45, no. 5, pp. 880–887, 2015.
 - [19] V. Utkin, “Discussion aspects of high-order sliding mode control,” *Institute of Electrical and Electronics Engineers Transactions on Automatic Control*, vol. 61, no. 3, pp. 829–833, 2016.
 - [20] V. Utkin, “On convergence time and disturbance rejection of super-twisting control,” *Institute of Electrical and Electronics Engineers Transactions on Automatic Control*, vol. 58, no. 8, pp. 2013–2017, 2013.
 - [21] J. A. Moreno and M. Osorio, “Strict Lyapunov functions for the super-twisting algorithm,” *IEEE Transactions on Automatic Control*, vol. 57, no. 4, pp. 1035–1040, 2012.
 - [22] C. Evangelista, P. Puleston, F. Valenciaga, and L. M. Fridman, “Lyapunov-designed super-twisting sliding mode control for wind energy conversion optimization,” *IEEE Transactions on Industrial Electronics*, vol. 60, no. 2, pp. 538–545, 2013.
 - [23] R. Sadeghi, S. M. Madani, M. Ataei, M. R. Agha Kashkooli, and S. Ademi, “Super-twisting sliding mode direct power control of brushless doubly fed induction generator,” *IEEE Transactions on Industrial Electronics*, vol. 65, no. 11, pp. 9147–9156, 2018.
 - [24] Z. Zhao, H. Gu, J. Zhang, and G. Ding, “Terminal sliding mode control based on super-twisting algorithm,” *Journal of Systems Engineering and Electronics*, vol. 28, no. 1, pp. 145–150, 2017.
 - [25] A. Chalanga, S. Kamal, L. M. Fridman, B. Bandyopadhyay, and J. A. Moreno, “Implementation of super-twisting control: Super-twisting and higher order sliding-mode observer-based approaches,” *IEEE Transactions on Industrial Electronics*, vol. 63, no. 6, pp. 3677–3685, 2016.
 - [26] D. Liang, J. Li, R. Qu, and W. Kong, “Adaptive second-order sliding-mode observer for pmsm sensorless control considering VSI nonlinearity,” *IEEE Transactions on Power Electronics*, vol. 33, no. 10, pp. 8994–9004, 2017.
 - [27] S. Laghrouche, M. Harmouche, and Y. Chitour, “Higher order super-twisting for perturbed chains of integrators,” *Institute of Electrical and Electronics Engineers Transactions on Automatic Control*, vol. 62, no. 7, pp. 3588–3593, 2017.
 - [28] H. Castaneda, F. Plestan, A. Chriette, and J. De Leon-Morales, “Continuous differentiator based on adaptive second-order sliding-mode control for a 3-DOF helicopter,” *IEEE Transactions on Industrial Electronics*, vol. 63, no. 9, pp. 5786–5793, 2016.



Hindawi

Submit your manuscripts at
www.hindawi.com

