

# Adaptive Integral Backstepping Motion Control for Inverted Pendulum

Ö. Tolga Altınöz

**Abstract**—The adaptive backstepping controller for inverted pendulum is designed by using the general motion control model. Backstepping is a novel nonlinear control technique based on the Lyapunov design approach, used when higher derivatives of parameter estimation appear. For easy parameter adaptation, the mathematical model of the inverted pendulum converted into the motion control model. This conversion is performed by taking functions of unknown parameters and dynamics of the system. By using motion control model equations, inverted pendulum is simulated without any information about not only parameters but also measurable dynamics. Also these results are compare with the adaptive backstepping controller which extended with integral action that given from [1].

**Keywords**—Adaptive Backstepping, Inverted Pendulum, Nonlinear Adaptive Control.

## I. INTRODUCTION

ADAPTIVE nonlinear control scheme was proposed to stabilize inverted pendulum. A novel control design technique called backstepping control was used to make inverted pendulum rod upwards. The key idea of backstepping design is to drive the error equation to zero by designing unique control and parameter adjustment laws. This design technique is applicable to both linear and nonlinear systems.

For the inverted pendulum system some of the unknown parameters can be measurable. With these known parameters, the numbers of unknown parameters are reduced and with this advantage, design and implementation of control law will be easier. That type of adaptive backstepping controller was designed in [1]. In that study, measuring the cart and pole weights, and trying to estimate the rod length are necessary. Comparing to measure rod length to weight is an easier task to perform. And also estimation of easy measure parameters is unnecessary. In some cases all parameters must be estimated. In [2] the same adaptive technique was used to estimate all parameters to stabilize inverted pendulum. For simplicity all unknown parameters are taken as three functions and adaptation is performed by estimating unknown parameter functions. With only estimation of three parameters, rather than five, stabilization becomes an easier task to perform. But this advantage is not enough to make the control law and adaptation mechanism easy.

Adaptive backstepping control is also used in industrial motion control systems. In [3-5] integral adaptive backstepping control was proposed for industrial motion control systems.

Experimental and simulation results show that when disturbance appears in the motor drives integral action in backstepping controller can increase system robustness with respect to the external disturbance and modeling error [4].

In this study we focus on the error. The modeling error and disturbance can occur in a function that has both unknown parameters and dynamics of the system.

The adaptive integral backstepping motion controller [3-5] was used to control inverted pendulum.

In second chapter, we proposed the problem, and related mathematical supplementary. Chapters 3 is the controller design procedure for adaptive backstepping controller and also in this chapter we introduce a new integral action control structure which is extended from [1]. In chapter 4 simulation and simulation results are proposed.

## II. PROBLEM STATEMENT

### A. Motion of Equation

The objective of this study is to convert inverted pendulum with movable cart mathematical equation to simplified second order model of the motion control equation. With this conversion, we can apply integral adaptive backstepping motion controller and adaptation mechanism to inverted pendulum which with the conversion looks like second order motion equation.

The motion equation of the inverted pendulum which derives from the Lagrange equation is used to derive motion equations of n-degree-of-freedom mechanic system. The Lagrange equation uses energy equation that does not need to use Newton's Law. Lagrange used to compute mathematical equations of mechanic systems that have joint forces. (Because of computational difficulty we use the Lagrange equation).

The Lagrange Equation

$$\frac{d}{dt} \left( \frac{\partial L}{\partial \dot{q}}(q, \dot{q}) \right) - \frac{\partial L}{\partial q}(q, \dot{q}) = \tau \quad (1)$$

where  $q$  is generalized coordinate,  $\tau$  is control forces and  $L(q, \dot{q})$  is the Lagrangian function by using (1) we have inverted pendulum motion equation

$$u = (Mc + Mp)\ddot{x} + Mpl\ddot{\theta} \cos\theta - Mpl\dot{\theta}^2 \quad (2)$$

$$(-I + Mpl^2)\ddot{\theta} + Mpgl \sin\theta = Mpl\ddot{x} \cos\theta \quad (3)$$

where  $u$  is the force applied to the cart,  $M_c$  and  $M_p$  are mass of the cart and pendulum rod respectively,  $l$  is the length of the rod,  $g$  is the graviton constant,  $\theta$  is the rod angle and  $x$  is the position of the cart.

By solving  $\ddot{x}$  and used in (2) we have

$$u = \phi_1 \ddot{\theta} \sec \theta + \phi_2 \tan \theta + \phi_3 (\ddot{\theta} \cos \theta - \dot{\theta}^2 \sin \theta) \quad (4)$$

where

$$\phi_1 = (M_c + M_p) \left[ \frac{(I + M_p l^2)}{M_p l} \right] \quad (5)$$

$$\phi_2 = (M_c + M_p) g \quad (6)$$

$$\phi_3 = M_p l \quad (7)$$

are functions that have unknown parameters of the system. Rewriting (4) in state space form is achieved by  $x_1 = \theta$  and  $x_2 = \dot{\theta}$  (or  $x_2 = w$ , where  $w$  is angular velocity). As a result

$$\dot{x}_1 = x_2 \quad (8)$$

$$g(x_1) \dot{x}_2 = u - \phi_2 \tan x_1 + \phi_3 x_2^2 \sin x_1 \quad (9)$$

$$g(x_1) = \phi_1 \sec x_1 + \phi_3 \cos x_1 \quad (10)$$

Now if we rewrite equation (8), (9) and (10) in the motion control form, then we have

$$\dot{x}_1 = x_2 \quad (11)$$

$$g(x_1) \dot{x}_2 = u - h(x_1) \quad (12)$$

where

$$h(x_1) = \phi_2 \tan x_1 - \phi_3 x_2^2 \sin x_1 \quad (13)$$

### B. Motion Control Equation

Simplified second order differential equation for motion control is given

$$\dot{\theta} = w \quad (14)$$

$$J \dot{w} = Tq - T_L \quad (15)$$

where  $\theta$  is angular position,  $w$  is angular velocity  $J$  is total effective inertia,  $Tq$  is the acting torque (used as input) and  $T_L$  is the load torque. The variables  $J$  and  $T_L$  are unknown parameters of the system. The purpose of the motion control with integral adaptive backstepping controller is to estimate these unknown motion parameters.

We rewrite equation (11), (12) in the form of

$$\dot{\theta} = w \quad (16)$$

$$g \dot{w} = u - h \quad (17)$$

Equations (14), (15) and (16), (17) are similar to  $g$  and  $h$  functions which also contain unknown parameters. This study aims to estimate these  $g$  and  $h$  functions by using integral adaptive backstepping motion controller.

The only difference is that  $h$  and  $g$  functions also contain dynamics of the system which is rod angle  $\theta$ . The rod angle  $\theta$  varies  $\pm \pi/2$ . Then we have  $g(x_1)$  converged to zero where  $\theta$  goes to zero.

But we consider dynamic value in these functions as disturbance and also we will estimate these unknown values.

Introduce normalize unknown function as

$$\Gamma = \frac{h(x_1)}{g(x_1)} \quad (18)$$

### III. ADAPTIVE BACKSTEPPING CONTROLLER DESIGN

The error equation is defined as

$$e_1 = \theta_{ref} - \theta \quad (19)$$

where  $\theta_{ref}$  is the reference  $\theta$  signal which assumes that continuous and differential piecewise signal, for inverted pendulum is zero.

Virtual control equation is defined as

$$w_{ref} = c_1 e_1 + \dot{\theta}_{ref} + \lambda_1 x_1 \quad (20)$$

where  $x_1 = \int e_1(\tau) d\tau$  is the integral action and by using this equation we can ensure that tracking error converge to zero.

Second error equation defined as

$$e_2 = w_{ref} - w \quad (21)$$

By using derivative of  $e_2$  to make desired dynamic for the velocity tracking error

$$\frac{de_2}{dt} = -c_2 e_2 - e_1 \quad (22)$$

We have control command input function as

$$u = \hat{g} \left\{ (1 - c_1^2 + \lambda_1) e_1 + (c_1 + c_2) e_2 - c_1 \lambda_1 x_1 + \ddot{\theta}_{ref} + \hat{\Gamma} \right\}$$

where  $\hat{g}$  and  $\hat{\Gamma}$  are estimated values of  $g$  and  $\Gamma$ . Now we can construct adaptation rules by using Lyapunov energy function.

$$V = \frac{\lambda_1}{2} x_1^2 + \frac{1}{2} e_1^2 + \frac{1}{2} e_2^2 + \frac{1}{2\gamma_1} (g - \hat{g})^2 + \frac{1}{2\gamma_2} (\Gamma - \hat{\Gamma})^2$$

where  $\gamma_1, \gamma_2, c_1, \lambda_1$  are positive constants at the disposal of the designer where they determine the convergence speed of the estimation.

The adaptation laws are

$$\frac{d\hat{g}}{dt} = \gamma_1 e_2 \left\{ (1 - c_1^2 + \lambda_1) e_1 + (c_1 + c_2) e_2 - c_1 \lambda_1 x_1 + \ddot{\theta}_{ref} + \hat{\Gamma} \right\}$$

$$\frac{d\hat{\Gamma}}{dt} = \gamma_2 e_2$$

The adaptation laws cancel undesired dynamics in the Lyapunov derivation.

For compare the all results we extend the adaptive backstepping controller which is given in [1] with integral action. New virtual control, control law and adaptation equation given equations (23), (24) and (25) respectively;

$$x_{4d} = -k_3 \xi_3 + \dot{\theta}_{sp} + x_1 \lambda_1 \quad (23)$$

$$u = -\hat{l} \left[ (k_3 + k_4) \xi_4 + (1 - k_3^2 - \lambda_1) \xi_3 - \ddot{\theta}_{sp} - k_3 \lambda_1 x_1 + \varphi_4 \right] \quad (24)$$

$$\dot{\hat{l}} = \gamma_5 \xi_4 \left[ (k_3 + k_4) \xi_4 + (1 - k_3^2 - \lambda_1) \xi_3 - \ddot{\theta}_{sp} - k_3 \lambda_1 x_1 + \varphi_4 \right] \quad (25)$$

where  $x_3 = \theta, x_4 = \dot{\theta}$

$$\varepsilon_3 = x_3 - \theta_{sp}$$

$$\varepsilon_4 = x_4 - x_{4d}$$

The new adaptive backstepping controller and adaptation mechanism simulation as introduced in Fig. 7.

#### IV. SIMULATION AND SIMULATION RESULTS

Simulation executed by using  $Mc=1, Mp=0.1, l=0.1, g=9.8$  model parameters and controller parameters selected as  $c_1=6, c_2=6, \gamma_1=6, \gamma_2=6$  and  $\lambda_1=0.0001$ .

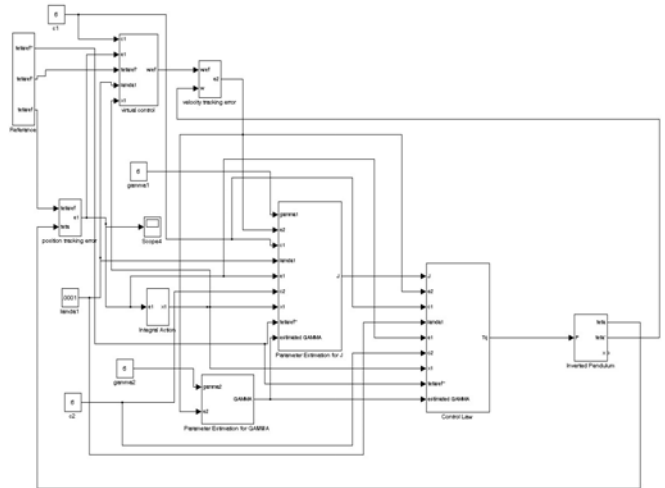

Fig. 1 Adaptive Integral Backstepping Control Block Diagram

Fig. 1 is the block diagram of the controller. This diagram is executed using the SIMULINK computer program. Initial conditions of inverted pendulum rod angle selected as 0.5 radian. This value is important as a higher degree or linearization. The inverted pendulum equation is converted to linear form by assuming rod angle in small values. By this assumption linear adaptive or non-adaptive control schemes can be applied. But in this study our purpose is to create a nonlinear adaptive controller for the nonlinear inverted pendulum. Higher changes in angle will not affect the control law.

Figs. 2 and 6 are the experimental result of the inverted pendulum rod angle. The angle converges to zero from 0.5 and 0.3 radians respectively.

Figs. 3 and 4 are the convergence of unknown parameters which converge into their true values.

Fig. 5 is the error function diagram that shows the error between the actual rod angle and the reference value which is zero. The error goes to zero which is the expected value.

Fig. 7 is the rod angle resulted from experiment in [1] which is extended with integral action.

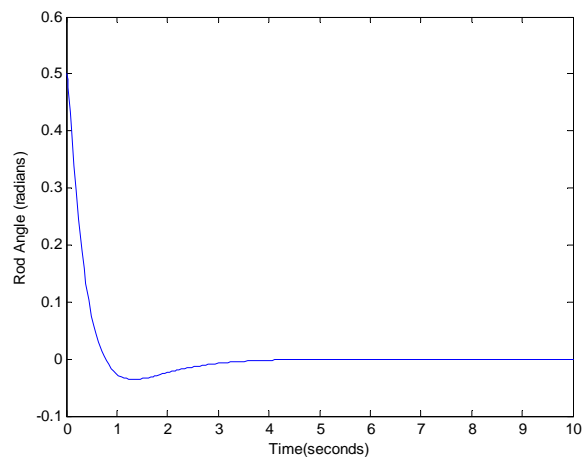

Fig. 2 Inverted pendulum rod angle for initial 0.5 radians

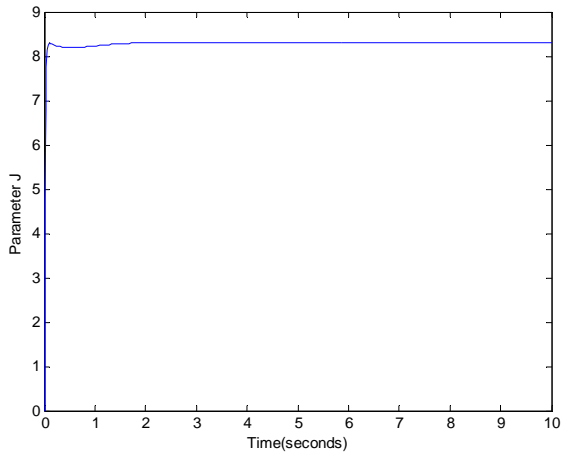

Fig. 3 Unknown J parameter convergence

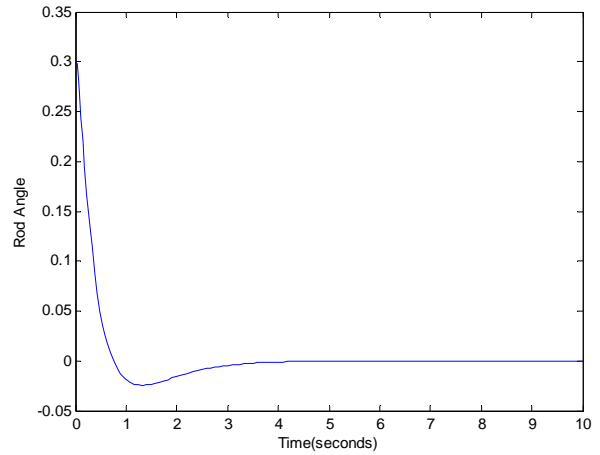

Fig. 6 Inverted pendulum rod angle for initial 0.3 radians

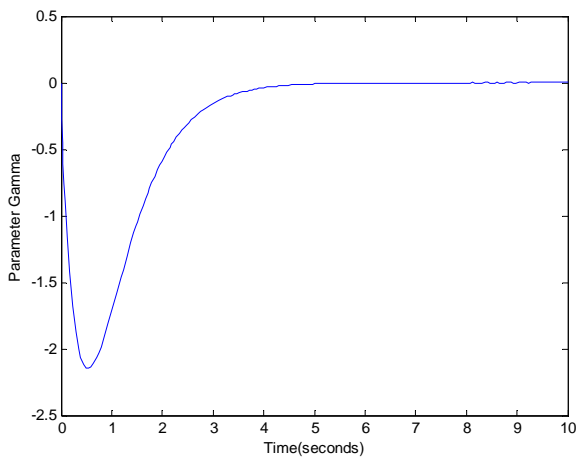

Fig. 4 Unknown  $\Gamma$  parameter convergence

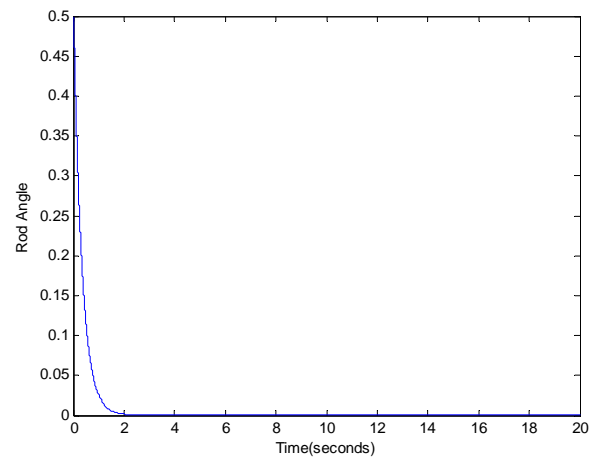

Fig. 7 Inverted pendulum rod angle for initial 0.5 radians by using estimation of l parameter with integral action

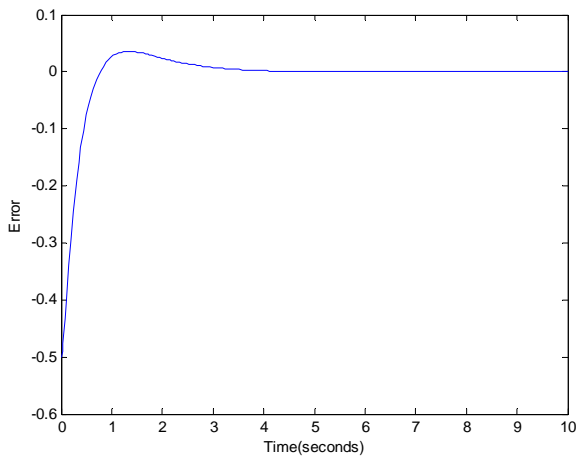

Fig. 5 Error function

#### REFERENCES

- [1] A. Bnaskeur and A.Desbiens, "Application of Adaptive Backstepping to the Stabilization of the Inverted Pendulum", IEEE, 1998, pp. 113-116.
- [2] A. Ebrahim and G.V. Murphy, "Adaptive Backstepping Controller Design of an Inverted Pendulum", IEEE, 2005, pp. 172-174.
- [3] Y. Tan, J.Chang, H.Tan and J.Hu, "Integral Backstepping Control and Experimental Implementation for Motion System", IEEE Int. Conf. Control Applications, September 2000, pp. 367-372.
- [4] Y. Tan, J.Hu J.Chang and H.Tan, "Adaptive Integral Backstepping Motion Control and Experimental Implmentation", 2000 , pp. 1081-1088
- [5] Y. Tan, J.Chang, J.Hu, H.Tan, "Advanced Nonlinear Control Strategy for Motion Control Systems", IEEE, 2000, pp. 116-121.