

# Adaptive PID Speed Control Design for Permanent Magnet Synchronous Motor Drives

Jin-Woo Jung, *Member, IEEE*, Viet Quoc Leu, Ton Duc Do, *Student Member, IEEE*, Eun-Kyung Kim, and Han Ho Choi, *Member, IEEE*

**Abstract**—This paper proposes an adaptive proportional–integral–derivative (PID) speed control scheme for permanent magnet synchronous motor (PMSM) drives. The proposed controller consists of three control terms: a decoupling term, a PID term, and a supervisory term. The first control term is employed to compensate for the nonlinear factors, the second term is made to automatically adjust the control gains, and the third one is designed to guarantee the system stability. Different from the offline-tuning PID controllers, the proposed adaptive controller includes adaptive tuning laws to online adjust the control gains based on the gradient descent method. Thus, it can adaptively deal with any system parameter uncertainties in reality. The proposed scheme is not only simple and easy to implement, but also it guarantees an accurate and fast speed tracking. It is proven that the control system is asymptotically stable. To confirm the effectiveness of the proposed algorithm, the comparative experiments between the proposed adaptive PID controller and the conventional PID controller are performed on the PMSM drive. Finally, it is validated that the proposed design scheme accomplishes the superior control performance (faster transient response and smaller steady-state error) compared to the conventional PID method in the presence of parameter uncertainties.

**Index Terms**—Adaptive control, parameter uncertainties, PID control, surface-mounted permanent magnet synchronous motor (SPMSM).

## I. INTRODUCTION

IN recent years, the ac motors are extensively applied in home appliances as well as industrial applications such as electric vehicles, wind generation systems, industrial robots, air conditioners, washing machines, etc. There are two main categories of the ac motors: induction motors (IMs) and permanent magnet synchronous motors (PMSMs). Nowadays, the IMs are used in about 70% of industrial electric motors due

to their simplicity, ruggedness, and low production costs [1]–[5]. Despite that, the PMSMs are gradually taking over the IMs owing to their high efficiency, low maintenance cost, and high power density. However, the PMSM system is not easy to control because it is a nonlinear multivariable system and its performance can be highly affected by parameters variations in the run time [6]–[9]. Therefore, researchers always desire to design a high-performance controller which has a simple algorithm, fast response, high accuracy, and robustness against the motor parameter and load torque variations.

Traditionally, the proportional–integral–derivative (PID) controller is widely adopted to control the PMSM systems in industrial applications owing to its simplicity, clear functionality, and effectiveness [10]. However, a big problem of the traditional PID controller is its sensitivity to the system uncertainties. Thus, the control performance of the conventional PID method can be seriously degraded under parameter variations. Some groups of researchers try to overcome this disadvantage by proposing the hybrid PID controllers or new tuning rules [11]–[13]. In [11], a hybrid control system, which contains a fuzzy controller in the transient and a PI controller in the steady-state, is proposed. In [12], the fuzzy rules are employed for tuning the PI gains. Unfortunately, both these methods use offline-tuning rules, which lack the adaptability to deal with the time-varying system uncertainties. An adaptive PI controller with an online-tuning rule is presented in [13]. Although this controller does not require the exact knowledge of any motor parameter, the authors do not show the results under parameter uncertainties.

Recently, many researchers have presented various advanced control strategies to efficiently control the PMSM systems, such as fuzzy logic control (FLC), nonlinear optimal control (NOC), sliding mode control (SMC), neural network control (NNC), adaptive control, etc. The FLC [14], [15] is a preferred research topic due to its fuzzy reasoning capacity. However, as the number of the fuzzy rules increases, the control accuracy can get better but the control algorithm can be complex. The NOC is successfully applied on the PMSM drives [16], [17]. Unfortunately, this control method requires full knowledge of the motor parameters with a sufficient accuracy and the results under serious variations of the mechanical parameters are not shown. The SMC has achieved much popularity in the speed control of the PMSM drives because of its great properties such as robustness to external load disturbances and fast dynamic

---

Manuscript received January 06, 2014; revised March 05, 2014; accepted for publication March 06, 2014. This work was supported by the National Research Foundation of Korea (NRF) Grant (2012R1A2A2A01045312) funded by the Korea government (MSIP, Ministry of Science, ICT & Future Planning). This research was supported by Basic Science Research Program through the National Research Foundation of Korea (NRF) funded by the Ministry of Education (2012R1A1A2001439).

The authors are with the Division of Electronics and Electrical Engineering, Dongguk University, Seoul 100-715, Korea (E-mail: [tonducd0@dongguk.edu](mailto:tonducd0@dongguk.edu)).

response [6], [18]-[21]. However, its system dynamics are still subject to the parameter variations and chattering problem. Meanwhile, the NNC technique has been presented as a substitutive design method to control the speed of the PMSM system [22]-[24]. The most valuable property of this technique is its ability to approximate the linear or nonlinear mapping through learning. However, the high computational burden increases the complexity in the control algorithm, which limits the implementation of this strategy in the practical applications. Next, the adaptive control is also an interesting method for the PMSM drives because it can deal with the motor parameter and load torque variations [25], [26]. Nevertheless, in these two papers, only the stator inductances and load torque variations are considered. The authors neglect the uncertainties of other motor parameters such as stator resistance, moment of inertia and viscous friction coefficient, etc. Moreover, the adaptive control algorithm [26] does not guarantee the convergence condition of the system dynamic error.

By combining the simplicity and effectiveness of the traditional PID control and the automatic adjustment capability of the adaptive control, this paper proposes a simple adaptive PID control algorithm for the PMSM drives. The adaptive PID controller encompasses the adaptive tuning laws which are designed to online adjust the control gains by using the supervisory gradient descent method. Therefore, when the motor parameters vary, the PID gains are automatically tuned to attain their optimal values. Consequently, the proposed control system achieves a good regulation performance such as fast dynamic response and small steady-state error even under system parameter uncertainties. The stability analysis of the proposed control strategy is described in details through the Lyapunov stability theories. The experimental results demonstrate the validity and feasibility of the proposed adaptive PID control method in comparison with the conventional PID control scheme under parameter uncertainties.

## II. SYSTEM MODEL DESCRIPTION AND DYNAMIC ERROR SYSTEM

### A. System Model Description

The mathematical model of a surface-mounted permanent magnet synchronous motor (SPMSM) drives can be described by the following equations in a  $d$ - $q$  synchronously rotating reference frame:

$$\begin{aligned}\dot{\omega} &= \frac{3}{2J} \frac{p^2}{4} \psi_m i_{qs} - \frac{B}{J} \omega - \frac{p}{2J} T_L \\ \dot{i}_{qs} &= -\frac{R_s}{L_s} i_{qs} - \frac{\psi_m}{L_s} \omega + \frac{1}{L_s} V_{qs} - \omega i_{ds} \\ \dot{i}_{ds} &= -\frac{R_s}{L_s} i_{ds} + \frac{1}{L_s} V_{ds} + \omega i_{qs}\end{aligned}\quad (1)$$

where  $\omega$  is the electrical rotor speed,  $i_{ds}$  and  $i_{qs}$  are the  $d$ -axis and  $q$ -axis stator currents,  $V_{ds}$  and  $V_{qs}$  are the  $d$ -axis and  $q$ -axis voltage inputs,  $L_s$  is the stator inductance,  $R_s$  is the stator resistance,  $\psi_m$  is the magnetic flux linkage,  $J$  is the moment of

inertia,  $B$  is the viscous friction coefficient,  $p$  is the number of poles, and  $T_L$  is the load torque.

Depending on  $R_s$ ,  $L_s$ ,  $J$ ,  $B$ , and  $\psi_m$ , the system parameters  $k_1 \sim k_6$  can be denoted as

$$\begin{aligned}k_1 &= \frac{3}{2J} \frac{p^2}{4} \psi_m, k_2 = \frac{B}{J}, k_3 = \frac{p}{2J} \\ k_4 &= \frac{R_s}{L_s}, k_5 = \frac{\psi_m}{L_s}, k_6 = \frac{1}{L_s}\end{aligned}\quad (2)$$

Then the SPMSM drive system model is rewritten as the following equations:

$$\begin{aligned}\dot{\omega} &= k_1 i_{qs} - k_2 \omega - k_3 T_L \\ \dot{i}_{qs} &= -k_4 i_{qs} - k_5 \omega + k_6 V_{qs} - \omega i_{ds} \\ \dot{i}_{ds} &= -k_4 i_{ds} + k_6 V_{ds} + \omega i_{qs}\end{aligned}\quad (3)$$

### B. Conventional PID Controller with Decoupling Term

First, the speed error ( $\omega_e$ ) and rotor acceleration ( $\beta$ ) are defined as

$$\begin{aligned}\omega_e &= \omega - \omega_d \\ \beta &= \dot{\omega} = k_1 i_{qs} - k_2 \omega - k_3 T_L\end{aligned}\quad (4)$$

where  $\omega_d$  is the desired speed.

From (3) and (4), the following dynamic equations can be derived

$$\begin{aligned}\dot{\omega}_e &= \dot{\omega} - \dot{\omega}_d \\ \dot{\beta} &= k_1 (-k_4 i_{qs} - k_5 \omega + k_6 V_{qs} - \omega i_{ds}) - k_2 \dot{\omega} - k_3 \dot{T}_L \\ \dot{i}_{ds} &= -k_4 i_{ds} + k_6 V_{ds} + \omega i_{qs}\end{aligned}\quad (5)$$

In practical applications, the desired speed and the load torque vary slowly in the sampling period. Thus, it can be reasonably supposed that the derivatives of  $\omega_d$  and  $T_L$  can be neglected. Then the system model (1) can be rewritten as

$$\begin{aligned}\dot{\omega}_e &= \beta \\ \dot{\beta} &= -k_2 \beta - k_1 k_4 i_{qs} - k_1 k_5 \omega - k_1 \omega i_{ds} + k_1 k_6 V_{qs} \\ \dot{i}_{ds} &= -k_4 i_{ds} + \omega i_{qs} + k_6 V_{ds}\end{aligned}\quad (6)$$

Then, the second-order system can be achieved in the following:

$$\begin{aligned}\ddot{\omega}_e + \lambda \dot{\omega}_e &= -k_2 \beta - k_1 k_4 i_{qs} - k_1 k_5 \omega - k_1 \omega i_{ds} + \lambda \beta \\ \dot{i}_{ds} &= -k_4 i_{ds} + \omega i_{qs} + k_6 V_{ds}\end{aligned}\quad (7)$$

where  $\lambda$  is the positive control parameter.

Based on the basic theory of the feedback linearization control, the decoupling control term  $u_f = [u_{1f} \ u_{2f}]^T$  is chosen as

$$\begin{aligned}u_{1f} &= (k_1 k_4 i_{qs} + k_1 k_5 \omega + k_1 \omega i_{ds} + (k_2 - \lambda) \beta) / (k_1 k_6), \\ u_{2f} &= (k_4 i_{ds} - \omega i_{qs}) / k_6\end{aligned}\quad (8)$$

From (7) and (8), the dynamic error system can be formulated as follows:

$$\begin{aligned}\ddot{\omega}_e &= -\lambda \dot{\omega}_e + k_1 k_6 (V_{qs} - u_{1f}) \\ \dot{i}_{ds} &= k_6 (V_{ds} - u_{2f})\end{aligned}\quad (9)$$

Then the conventional PID controller is given by

$$V_{dq_s} = \begin{bmatrix} k_1 k_6 V_{qs} \\ k_6 V_{ds} \end{bmatrix} = B \begin{bmatrix} V_{qs} \\ V_{ds} \end{bmatrix} = u_f + u_{PID}\quad (10)$$

where  $B = \text{diag}[k_1 k_6, k_6]$ ,  $u_f$  is the decoupling control term to compensate for the nonlinear factors, and  $u_{PID}$  is the PID control term below.

$$u_{PID} = \begin{bmatrix} u_{1PID} \\ u_{2PID} \end{bmatrix} = \begin{bmatrix} -K_{1P} \omega_e - K_{1I} \int_0^t \omega_e dt - K_{1D} \frac{d\omega_e}{dt} \\ -K_{2P} i_{dse} - K_{2I} \int_0^t i_{dse} dt \end{bmatrix} = EK \quad (11)$$

where  $(K_{1P}, K_{2P})$ ,  $(K_{1I}, K_{2I})$ , and  $(K_{1D})$  are the proportional gains, integral gains, and derivative gain of the PID control term, respectively. The state and gain matrices are given as

$$E = \begin{bmatrix} \int_0^t \omega_e dt & \omega_e & \beta & 0 & 0 \\ 0 & 0 & 0 & \int_0^t i_{ds} dt & i_{ds} \end{bmatrix},$$

$$K = [-K_{1I} \quad -K_{1P} \quad -K_{1D} \quad -K_{2I} \quad -K_{2P}]^T$$

It should be noted that the derivative of the stator current is normally very noisy, thus, it is not included in (11).

### III. PROPOSED ADAPTIVE PID CONTROLLER DESIGN

The conventional PID controller (10) with the offline-tuned control gains can give a good control performance if the motor parameters ( $k_1$  to  $k_6$ ) are accurately known. However, the system parameters gradually change during operating time; therefore, after a long running time, the control performance can be seriously degraded if changed system parameters are not updated. To overcome this challenge, this section presents the adaptive tuning laws for auto adjustment of the control gains. On that note, the control gains, denoted as  $K_{1I}$ ,  $K_{1P}$ ,  $K_{1D}$ ,  $K_{2I}$ , and  $K_{2P}$  in (11), are adjusted to the proper values based on the supervisory gradient descent method. The proposed adaptive PID controller is assumed to have the following form:

$$V_{dqs} = u_f + u_{PID} - u_{PID0} + u_S \quad (12)$$

where  $u_f$  is the decoupling control term which compensates for the nonlinear factors as shown in (6),  $u_{PID}$  is the PID control term which includes the adaptive tuning laws,  $u_S$  is the supervisory control term which guarantees the system stability, and  $u_{PID0} = EK_0$  (with  $K_0 = [-K_{1I0} \quad -K_{1P0} \quad -K_{1D0} \quad -K_{2I0} \quad -K_{2P0}]^T$  is a constant coefficient matrix).

#### A. Proposed Adaptive PID Controller

In order to derive the proper adaptation laws, a new tracking error vector based on the reduced-order sliding mode dynamics is defined as

$$s(t) = \begin{bmatrix} s_1(t) \\ s_2(t) \end{bmatrix} = \begin{bmatrix} \lambda \omega_e + \beta \\ i_{ds} \end{bmatrix} \quad (13)$$

Then, the transfer function  $G(p)$  from  $s_1$  to  $\omega_e$  is given by the following strictly positive real function:

$$G(p) = \frac{\omega_e}{s_1} = \frac{1}{(\lambda + p)} \quad (14)$$

where  $p$  is the Laplace variable. Hence, it can be concluded that  $\omega_e$  converges to zero as  $s \rightarrow 0$ .

From the viewpoints of the SMC method, the sliding condition that ensures the hitting and existence of a sliding

mode is deduced according to the Lyapunov stability theory. Commonly, the Lyapunov function candidate for the sliding mode control is given by  $V_1 = s^T s / 2$ . Then, the sliding condition can be obtained from the Lyapunov stability theory as

$$\dot{V}_1(t) = s^T \dot{s} < 0 \quad (15)$$

The sliding condition (15) guarantees that  $s \rightarrow 0$  as  $t \rightarrow \infty$ . In order to derive the adaptive tuning laws for the PID gains, the supervisory gradient descent method is used to minimize the sliding condition  $s^T \dot{s}$  in (15). The gradient descent search algorithm is calculated in the direction opposite to the energy flow, and the convergence properties of the PID gains can also be obtained. Therefore, the adaptation laws for the five control gains  $K_{1P}$ ,  $K_{1I}$ ,  $K_{1D}$ ,  $K_{2P}$ , and  $K_{2I}$  can be easily obtained based on the supervisory gradient method as follows:

$$\begin{aligned} \dot{K}_{1P} &= -\gamma_{1P} \frac{\partial V_1}{\partial K_{1P}} = -\gamma_{1P} \frac{\partial V_1}{\partial u_{1PID}} \frac{\partial u_{1PID}}{\partial K_{1P}} = -\gamma_{1P} s_1 \omega_e \\ \dot{K}_{1I} &= -\gamma_{1I} \frac{\partial V_1}{\partial K_{1I}} = -\gamma_{1I} \frac{\partial V_1}{\partial u_{1PID}} \frac{\partial u_{1PID}}{\partial K_{1I}} = -\gamma_{1I} s_1 \int_0^t \omega_e dt \\ \dot{K}_{1D} &= -\gamma_{1D} \frac{\partial V_1}{\partial K_{1D}} = -\gamma_{1D} \frac{\partial V_1}{\partial u_{1PID}} \frac{\partial u_{1PID}}{\partial K_{1D}} = -\gamma_{1D} s_1 \beta \\ \dot{K}_{2P} &= -\gamma_{2P} \frac{\partial V_1}{\partial K_{2P}} = -\gamma_{2P} \frac{\partial V_1}{\partial u_{2PID}} \frac{\partial u_{2PID}}{\partial K_{2P}} = -\gamma_{2P} s_2 i_{ds} \\ \dot{K}_{2I} &= -\gamma_{2I} \frac{\partial V_1}{\partial K_{2I}} = -\gamma_{2I} \frac{\partial V_1}{\partial u_{2PID}} \frac{\partial u_{2PID}}{\partial K_{2I}} = -\gamma_{2I} s_2 \int_0^t i_{ds} dt \end{aligned} \quad (16)$$

where  $\gamma_{1P}$ ,  $\gamma_{1I}$ ,  $\gamma_{1D}$ ,  $\gamma_{2P}$ , and  $\gamma_{2I}$  are the positive learning-rates.

The adaptive tuning laws (16) can be expressed in the following vector form:

$$\dot{K} = \Phi E^T s \quad (17)$$

where  $\Phi = \text{diag}(\gamma_{1I}, \gamma_{1P}, \gamma_{1D}, \gamma_{2I}, \gamma_{2P})$ .

**Remark 1:** By utilizing the online-tuning rules (16), the control gains are automatically adjusted as the system parameters vary. Therefore, the proposed adaptive PID controller can overcome the disadvantage of all offline-tuning methods [11], [12] and can exhibit the good performance regardless of the system parameter uncertainties.

Next, the supervisory control term in (12) is necessary for pulling back the dynamic errors to the predetermined bounded region and guaranteeing the system stability. Assume that there exists an optimal PID control term ( $u_{PID}^*$ ) such that

$$u_{PID}^* = u_{PID0} + \varepsilon \quad (18)$$

where  $K^* = [-K_{1I}^* \quad -K_{1P}^* \quad -K_{1D}^* \quad -K_{2I}^* \quad -K_{2P}^*]^T$  is the optimal gain matrix,  $\varepsilon = [\varepsilon_1 \quad \varepsilon_2]^T$ ;  $\varepsilon_1$  and  $\varepsilon_2$  denote the approximation errors and they are assumed to be bounded by  $0 \leq |\varepsilon_1| \leq \delta_1$  and  $0 \leq |\varepsilon_2| \leq \delta_2$  in which  $\delta_1$  and  $\delta_2$  are the positive constants.

Then the supervisory control term is designed as

$$u_S = \begin{bmatrix} -\delta_1 \cdot \text{sgn}(s_1) \\ -\delta_2 \cdot \text{sgn}(s_2) \end{bmatrix} \quad (19)$$

To this end, the desired controller is obtained by combining the decoupling control term (8), PID control term (11) with the adaptation laws (16), and supervisory control term (19), as  $V_{dqs} = u_f + u_{PID} + u_S$ .

### B. Stability Analysis

To analyze the stability of the dynamic error system, the following theorem is established.

**Theorem:** Consider the dynamic error system represented by (9). If the adaptive PID speed controller (12) with the adaptive tuning laws (16) is applied to (9), then, the dynamic error system is asymptotically stable.

**Proof:** The following equation can be derived from (9), (12), and (18) as

$$\dot{s} = B(u_{PID} + u_S - u_{PID}^* + u_{PID}^* - u_{PID0}) = B(E\tilde{K} + u_S - \varepsilon) \quad (20)$$

where  $\tilde{K} = K - K^*$ .

Let us define the errors of the control gains as follows:

$$\begin{aligned} \tilde{K}_{1P} &= K_{1P} - K_{1P}^*, \tilde{K}_{1I} = K_{1I} - K_{1I}^*, \tilde{K}_{1D} = K_{1D} - K_{1D}^*, \\ \tilde{K}_{2P} &= K_{2P} - K_{2P}^*, \tilde{K}_{2I} = K_{2I} - K_{2I}^* \end{aligned} \quad (21)$$

Based on (20) and (21), the following Lyapunov function candidate is chosen:

$$\begin{aligned} V_2(t) &= \frac{1}{2} s^T B^{-1} s + \frac{1}{\gamma_{1P}} \tilde{K}_{1P}^2 + \frac{1}{\gamma_{1I}} \tilde{K}_{1I}^2 + \frac{1}{\gamma_{1D}} \tilde{K}_{1D}^2 \\ &+ \frac{1}{\gamma_{2P}} \tilde{K}_{2P}^2 + \frac{1}{\gamma_{2I}} \tilde{K}_{2I}^2 \end{aligned} \quad (22)$$

The time derivative of the Lyapunov function  $V_2(t)$  is given by

$$\begin{aligned} \dot{V}_2(t) &= s^T B^{-1} \dot{s} + \frac{1}{\gamma_{1I}} \tilde{K}_{1I} \dot{K}_{1I} + \frac{1}{\gamma_{1P}} \tilde{K}_{1P} \dot{K}_{1P} \\ &+ \frac{1}{\gamma_{1D}} \tilde{K}_{1D} \dot{K}_{1D} + \frac{1}{\gamma_{2I}} \tilde{K}_{2I} \dot{K}_{2I} + \frac{1}{\gamma_{2P}} \tilde{K}_{2P} \dot{K}_{2P} \\ &= s^T B^{-1} B(E\tilde{K} + u_S - \varepsilon) + \tilde{K}^T \Phi^{-1} \dot{\tilde{K}} \\ &= s^T (E\tilde{K} - \begin{bmatrix} \delta_1 \operatorname{sgn}(s_1) \\ \delta_2 \operatorname{sgn}(s_2) \end{bmatrix} - \varepsilon) - \tilde{K}^T \Phi^{-1} \Phi E^T s \\ &= -\delta_1 |s_1| - \delta_2 |s_2| - \varepsilon_1 s_1 - \varepsilon_2 s_2 \\ &\leq -(\delta_1 - |\varepsilon_1|) |s_1| - (\delta_2 - |\varepsilon_2|) |s_2| \\ &\leq 0 \end{aligned} \quad (23)$$

Using the adaptive PID controller (12) with the adaptive tuning laws (16), the inequality  $\dot{V}_2(t) \leq 0$  can be obtained for non-zero value of the tracking error vector  $s$ . Since  $\dot{V}_2(t)$  is a negative semi-definite function (i.e.,  $V_2(t) \leq V_2(0)$ ), which implies that  $s$  and  $\tilde{K}$  are bounded. Let the function  $\Omega(t) \equiv [(\delta_1 - |\varepsilon_1|) |s_1| + (\delta_2 - |\varepsilon_2|) |s_2|]$ , and the following inequality is obtained from (23)

$$\int_0^t \Omega(\tau) d\tau \leq V_2(0) - V_2(t) \quad (24)$$

Because  $V_2(0)$  is bounded and  $V_2(t)$  is bounded and non-increasing, thus the following inequality can be deduced

$$\lim_{t \rightarrow \infty} \int_0^t \Omega(\tau) d\tau < \infty \quad (25)$$

Meanwhile, as far as  $s$  is bounded, by using (13), it is obvious to realize that  $\dot{s}$  is also bounded. Then  $\Omega(t)$  is uniformly continuous. By using Barbalat's lemma [27], it can be shown

that  $\lim_{t \rightarrow \infty} \Omega(t) = 0$ . Therefore,  $s \rightarrow 0$  as  $t \rightarrow \infty$ . Consequently, the

adaptive PID control system is asymptotically stable even if there exist the motor parameter variations and external load torque disturbances. ■

**Remark 2:** The angular acceleration ( $\beta$ ) is normally not available. This angular acceleration can be estimated by the extended state observer [19], [28]. However, these estimations require accurate knowledge about some system parameters, so the algorithm seems to be complex and the accuracy of estimated values is highly sensitive to parameters variations. In this paper,  $\beta$  is simply computed by using the relation  $\beta = \dot{\omega}$  as [29]. Moreover, this computation is independent of the system parameters.

$$\hat{\beta}(k) = \frac{\varphi}{T + \varphi} \hat{\beta}(k-1) + \frac{1}{T + \varphi} [\omega(k) - \omega(k-1)] \quad (26)$$

where  $\varphi$  is a sufficiently small filter time constant to limit the vulnerability of this computation to noise.

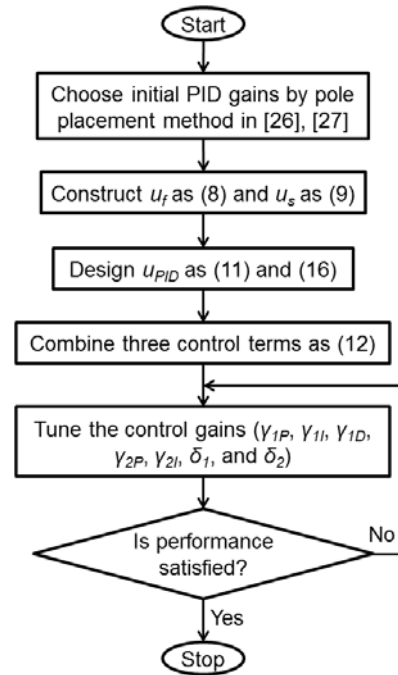

Fig. 1. Flow chart of the proposed adaptive PID control algorithm.

**Remark 3:** It should be noted that the proposed adaptive PID control strategy can be applicable to various electrical systems which have the mathematical form as (9). The overall design procedure of the proposed control scheme can be summarized as follows:

- Step 1:** Choosing the initial values of the PID gains by using the pole placement method [30] and [31].
- Step 2:** Constructing the decoupling control term  $u_f$  as (8) and the supervisory control term  $u_s$  as (19).
- Step 3:** Making the PID control term  $u_{PID}$  as (11) with the adaptation laws as (16).
- Step 4:** Giving the desired controller (12) by combining the three control terms in (8), (11), and (19).

Then, Fig. 1 shows the flow chart of the proposed adaptive PID control algorithm that represents the design procedure described in Remark 3.

#### IV. EXPERIMENTAL EVALUATION

##### A. Drive System Setup

In this section, the effectiveness of the proposed adaptive PID control scheme is evaluated through conducting a series of experiments on a prototype 1HP SPMSM drive using TMS320F28335 digital signal processor (DSP), which is extensively used at ac motor drives. Note that with the advanced development of the DSP today, the proposed scheme with the simple adaptive tuning laws does not affect much the processing time and CPU utilization to execute the algorithm compared to the traditional PID method. Fig. 2 illustrates the overall block diagram of the SPMSM drive system with the proposed adaptive PID controller which consists of three control terms. As shown in Fig. 2, the driving system includes the following hardware components: a three-phase inverter and its driving circuits, a SPMSM, a brake, an incremental encoder, Hall-effect current sensors, and a DSP-board. First, the rotor position ( $\theta$ ) is measured via the encoder RIA-40-2500ZO and then it is used to calculate the motor speed. Also, the transformations such as Clarke, Park, and inverse Park are utilized to transform a stationary three-phase system into the stationary two-phase system ( $abc$ -frame to  $\alpha\beta$ -frame), the stationary system to the synchronously rotating system ( $\alpha\beta$ -frame to  $dq$ -frame), and the synchronously rotating system to the stationary system ( $dq$ -frame to  $\alpha\beta$ -frame), respectively. Next, only two phase currents ( $i_a, i_b$ ) are measured through the Hall sensors, and converted from analog values to digital values via 12-bit A/D converters. Note that since the stator windings are connected in star configuration, the phase- $C$  current can be easily calculated from the phase- $A$  and - $B$  currents ( $i_a, i_b$ ). In this paper, the space vector pulse width modulation (SVPWM) technique is used to efficiently regulate the rotor speed. Taking into account the system efficiency and control performance, the switching (or sampling) frequency and dead time are selected as 5 kHz and 2  $\mu$ s, respectively. The nominal parameters of the SPMSM drive are illustrated in Table I.

TABLE I  
NOMINAL SPMSM PARAMETERS

Parameters	Symbols	Values
Rated power	$P_{rated}$	750 W
Rated phase-to-phase voltage	$V_{rated}$	220 V
Rated phase current	$I_{rated}$	4.3 A
Rated torque	$T_{rated}$	2.4 N·m
Number of poles	$p$	8
Stator resistance	$R_s$	0.43 $\Omega$
Stator inductance	$L_s$	3.2 mH
Magnet flux	$\psi_m$	0.085 V·s/rad
Equivalent inertia	$J$	0.0018 kg·m <sup>2</sup>
Viscous friction coefficient	$B$	0.0002 N·m·s/rad

##### B. Study Scenarios

To evaluate the effectiveness of the proposed control strategy, there are various study scenarios such as variable load

torque, variable speed, parameter variations, etc. In this paper, the regulation performance of the proposed control method is evaluated by the two scenarios that include the step changes of both the load torque and desired rotor speed. Moreover, the motor parameter variations are implemented in the experiments to verify the robustness of the control system. Actually, the electrical parameters are changed according to the temperature and stator currents during the system operation. Based on [32] and [33], it is assumed that the stator resistance ( $R_s$ ) and stator inductance ( $L_s$ ) are changed as +70% and -30%, respectively, i.e.,  $R_s' = (100\% + 70\%) \times 0.43 = 0.731 \Omega$  and  $L_s' = (100\% - 30\%) \times 3.2 = 2.24$  mH. Also, the mechanical parameters are normally increased when the motor shaft is connected to the external mechanical load. Therefore, it is assumed that the moment of inertia and viscous friction coefficient are varied to be +120% and +50%, respectively, i.e.,  $J' = (120\% + 100\%) \times 18 \times 10^{-4} = 39.6 \times 10^{-4}$  kg·m<sup>2</sup>,  $B' = (100\% + 50\%) \times 2 \times 10^{-4} = 3 \times 10^{-4}$  N·m·s/rad. It should be noted that some parameters such as  $J$  and  $B$  may be more heavily changed according to the operating conditions and applications. However, the proposed control system can effectively overcome these problems by using an online tuning rule which can be adapted to the variations of any system parameters. Table II summarizes the two different scenarios described above to assess the proposed algorithm.

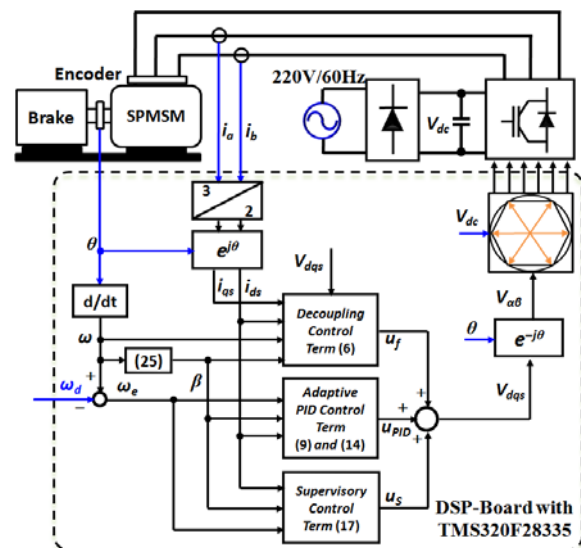

Fig. 2. Overall block diagram of the SPMSM drive system using the proposed adaptive PID controller.

TABLE II  
TWO STUDY SCENARIOS FOR EXPERIMENT

Scenarios	Conditions	Details	Parameter Variations
1	Step change of the load torque	$\omega_d = 251.3$ rad/s; $T_L: 2.4$ N·m $\rightarrow$ 0 N·m	$R_s, L_s, J,$ and $B$ are changed as +100, -30%, +120%, and +50%, respectively
2	Step change of the desired speed	$\omega_d: 251.3$ rad/s $\rightarrow$ 125.7 rad/s; $T_L = 1$ N·m	

Notice that it is not easy to directly change the motor parameters in experiments even if these values in simulations can be easily changed. As an alternative to implement the motor parameter changes in a real SPMSM drive, it can be done simply by changing the parameters in the control scheme. Therefore, in this paper, the changes of the system parameters in the controller have been made instead of changing the real system parameters in the SPMSM in order to experimentally verify the control performance of the proposed method and conventional PID method under the variations of some motor parameters ( $R_s$ ,  $L_s$ ,  $J$ , and  $B$ ).

Since the conventional PID controller (10) possesses the control structure similar to the proposed adaptive PID controller (12), therefore, it is also implemented for the competitive comparison. Notice that the gains of the conventional PID controller are determined by the tuning rules of [30] and [31] based on the pole placement technique. In this paper, the conventional PID control gains are chosen as  $K_{1P} = 30000$ ,  $K_{1I} = 3000$ ,  $K_{1D} = 100$ ,  $K_{2P} = 200$ , and  $K_{2I} = 50$ . Note that, these values are also used as the initial values to online tune the control gains of the proposed adaptive PID controller. In (16), the positive learning-rates ( $\gamma_{1P}$ ,  $\gamma_{1I}$ ,  $\gamma_{1D}$ ,  $\gamma_{2P}$ , and  $\gamma_{2I}$ ) should be sufficiently large to guarantee a fast learning process and small time to converge. However, if they are selected to be too large, the proposed adaptive PID algorithm may become unstable. Therefore, these values are chosen as  $\gamma_{1P} = \gamma_{1I} = \gamma_{1D} = \gamma_{2P} = \gamma_{2I} = 0.1$  based on the fast learning process and system stability. Besides, the positive constants in the supervisory control term are chosen via extensive simulation studies as  $\delta_1 = 5$  and  $\delta_2 = 1$ . Note that the angular acceleration ( $\beta$ ) obtained from (26) is utilized in the conventional PID control scheme.

### C. Experimental Results

**Scenario 1:** Under this scenario, the desired speed ( $\omega_d$ ) is set to 251.3 rad/s and the load torque ( $T_L$ ) suddenly changes from 2.4 N·m to 0 N·m under system parameter variations given in Table II. Figs. 3 and 4 present the comparative experimental waveforms of the proposed adaptive PID controller and the conventional PID controller, respectively. In detail, Figs. 3(a) and 4(a) show the desired speed ( $\omega_d$ ), rotor speed ( $\omega$ ), and speed error ( $\omega_e$ ), whereas Figs. 3(b) and 4(b) show the  $d$ -axis stator current ( $i_{ds}$ ) and  $q$ -axis stator current ( $i_{qs}$ ), respectively. It can be inferred from Figs. 3 and 4 that the regulation performance of the conventional PID control system is significantly improved after applying the adaptive tuning laws. That is, the proposed control scheme precisely tracks the desired speed with fast dynamic response (settling time: 196 ms) and small steady-state error (2.0%), under a sudden change in load torque. On the contrary, it is obvious from Fig. 4 that the conventional PID controller still shows its poor capacity when the load torque changes with a step, i.e., the settling time and steady-state error are 240 ms and 6%, respectively. It should be noted that the gains of the conventional PID controller are tuned under nominal parameters via extensive simulation studies. As shown in Fig. 4, its steady-state error is quite high because it lacks an adaptive capacity under parameter uncertainties.

**Scenario 2:** In this experimental scenario, the desired speed ( $\omega_d$ ) is suddenly changed from 125.7 rad/s to 251.3 rad/s and the load torque ( $T_L$ ) is set at 1 N·m under system parameter variations. Figs. 5 and 6 show the experimental results of the proposed PID control method and the conventional PID control method. In Fig. 5, the rotor speed can be tracked to accurately follow the desired value (steady-state error: 1.6%). On the other hand, it can be seen in Fig. 6 that the conventional controller tracks the rotor speed with a considerable steady-state error (9.1%). In these figures, the proposed adaptive PID control scheme (settling time: 90 ms) exhibits the faster dynamic behavior than the conventional control method (settling time: 216 ms) under the parameter uncertainties.

The detailed comparative performance of the two control methods is summarized in Table III. From Figs. 3–6 and Table III, it is apparent that the proposed adaptive PID controller can more effectively improve the control performance (i.e., faster dynamic response and smaller steady-state error) than the conventional PID controller when there exist the motor parameter variations and external load disturbances.

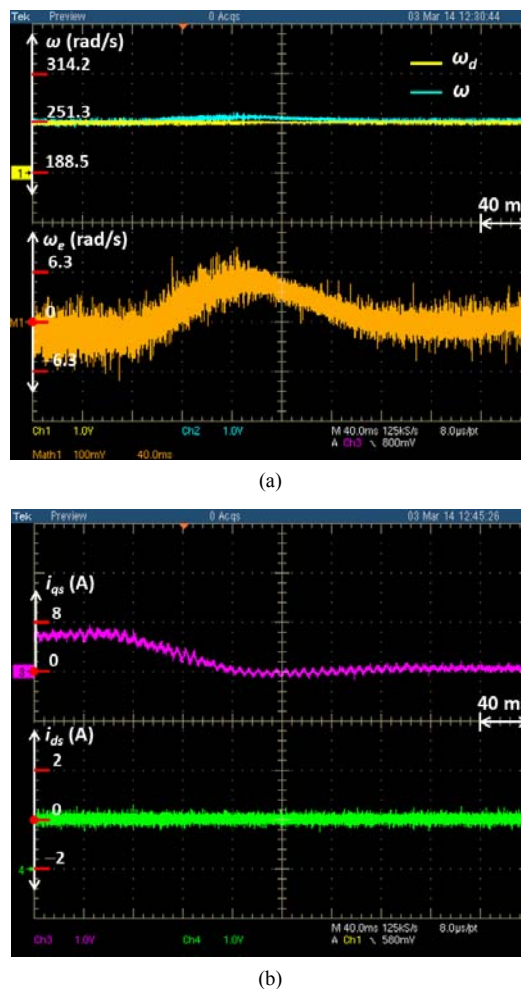
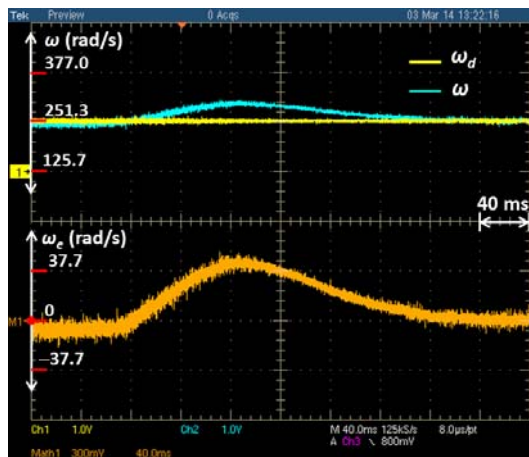
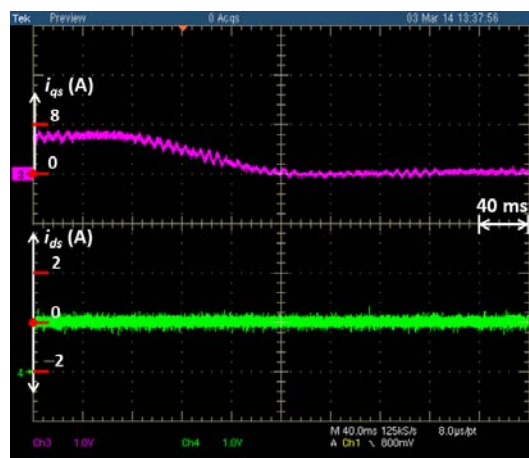

Fig. 3. Experimental results of the proposed adaptive PID control method when the load torque suddenly changes under system parameter variations. (a) Desired speed ( $\omega_d$ ), rotor speed ( $\omega$ ), and speed error ( $\omega_e$ ); (b)  $d$ -axis stator current ( $i_{ds}$ ) and  $q$ -axis stator current ( $i_{qs}$ ).



(a)



(b)

Fig. 4. Experimental results of the conventional PID control method when the load torque suddenly changes under system parameter variations. (a) Desired speed ( $\omega_d$ ), rotor speed ( $\omega$ ), and speed error ( $\omega_e$ ); (b)  $d$ -axis stator current ( $i_{ds}$ ) and  $q$ -axis stator current ( $i_{qs}$ ).

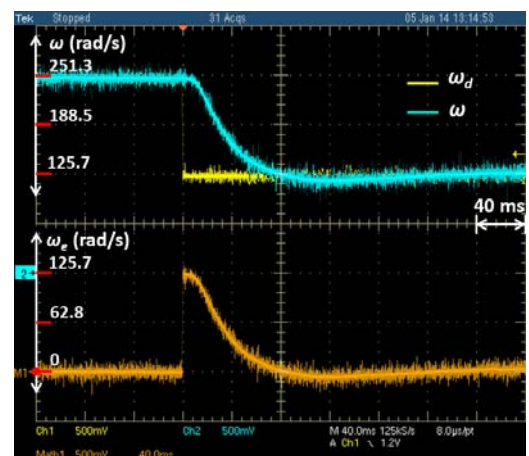

(a)

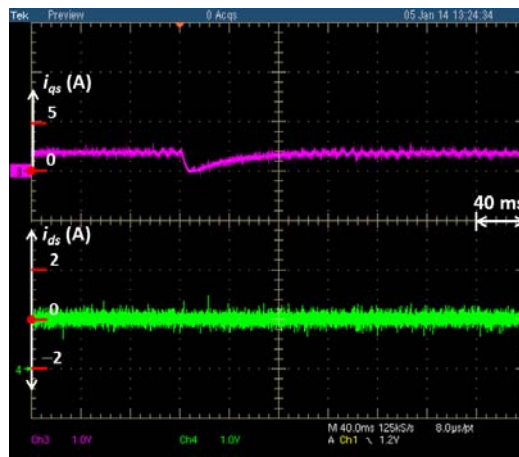

(b)

Fig. 5. Experimental results of the proposed adaptive PID control method when the desired speed suddenly changes under system parameter variations. (a) Desired speed ( $\omega_d$ ), rotor speed ( $\omega$ ), and speed error ( $\omega_e$ ); (b)  $d$ -axis stator current ( $i_{ds}$ ) and  $q$ -axis stator current ( $i_{qs}$ ).

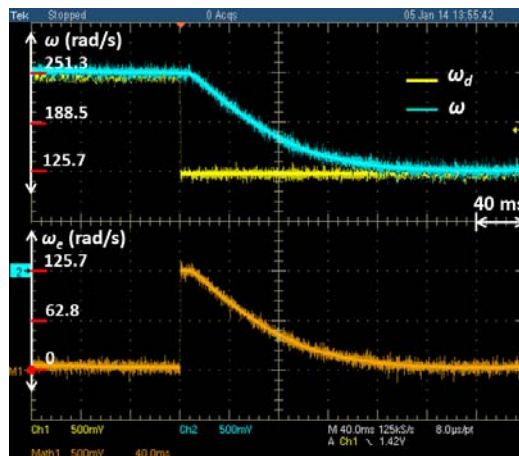

(a)

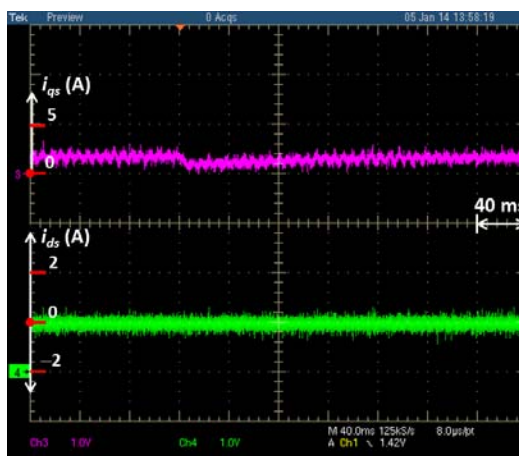

(b)

Fig. 6. Experimental results of the conventional PID control method when the desired speed suddenly changes under system parameter variations. (a) Desired speed ( $\omega_d$ ), rotor speed ( $\omega$ ), and speed error ( $\omega_e$ ); (b)  $d$ -axis stator current ( $i_{ds}$ ) and  $q$ -axis stator current ( $i_{qs}$ ).

TABLE III  
COMPARISON PERFORMANCES OF TWO CONTROL METHODS IN EXPERIMENT

Control methods Scenarios	Proposed adaptive PID controller		Conventional PID controller	
	Settling time (ms)	Steady-state error (%)	Settling time (ms)	Steady-state error (%)
1	196	2.0	240	6.0
2	90	1.6	216	9.1

## V. CONCLUSION

In this paper, an adaptive PID control method for speed control of the PMSM drives was proposed. The proposed control algorithm was simple and easy to implement in the practical applications. By using the gradient descent method, the adaptive tuning laws were proposed to auto adjust the PID gains that can achieve favorable tracking performance. Therefore, the proposed control scheme could guarantee the accurate and fast speed tracking in spite of the system parameter variations and external load disturbances. Moreover, the stability analysis of the proposed control system was described in detail. To verify the effectiveness of the proposed control strategy, the experiments were conducted. For comparison purpose, the conventional PID controller was also tested at the same conditions as the proposed controller. It was evidenced through the experimental results that the proposed adaptive PID control algorithm could considerably enhance the control performance compared to the conventional PID control method. As a result, the main accomplishments of this paper are summarized as follows:

- 1) It provided a novel adaptive PID control strategy with a detailed design procedure.
- 2) It offered the mathematical proof about the stability and zero convergence of the control system with Lyapunov's direct method and related lemmas.
- 3) It tested the adaptive PID control scheme that can precisely track the speed of the SPMSM drive under motor parameter variations and external load disturbances.
- 4) It presented the experimental results of the conventional PID controller for comparative studies.

Nowadays, the research activities are going on to develop the new analysis and tuning methods for the PID gains, so the proposed adaptive PID control scheme can help reduce the difficulties in these issues.

## REFERENCES

- [1] G. Wang, H. Zhan, G. Zhang, X. Gui, and D. Xu, "Adaptive compensation method of position estimation harmonic error for EMF-based observer in sensorless IPMSM drives," *IEEE Trans. Power Electron.*, vol. 29, no. 6, pp. 3055–3064, Jun. 2014.
- [2] P. K. Kovacs, *Transient Phenomena in Electrical Machines*, New York, Elsevier, 1984.
- [3] H. W. Sim, J. S. Lee, and K. B. Lee, "On-line parameter estimation of interior permanent magnet synchronous motor using an extended Kalman filter," *J. Elect. Eng. Technol.*, vol. 9, no. 2, pp. 600–608, Mar. 2014.
- [4] S. Bolognani, S. Calligaro, and R. Petrella, "Adaptive flux-weakening controller for IPMSM drives," *IEEE Journal of Emerging and Selected Topic in Power Electronics*, Early access.
- [5] J. Kim, I. Jeong, K. Lee, and K. Nam, "Fluctuating current control method for a PMSM along constant torque contours," *IEEE Trans. Power Electron.*, Early access.
- [6] M. Sekour, K. Hartani, A. Draou, and A. Allali, "Sensorless fuzzy direct torque control for high performance electric vehicle with four in-wheel motors," *J. Elect. Eng. Technol.*, vol. 8, no. 3, pp. 530–543, May 2013.
- [7] X. Zhang, L. Sun, K. Zhao, and L. Sun, "Nonlinear speed control for PMSM system using sliding-mode control and disturbance compensation techniques," *IEEE Trans. Power Electron.*, vol. 28, no. 3, pp. 1358–1365, Mar. 2013.
- [8] H. Lin, K. Y. Hwang, and B. I. Kwon, "An improved flux observer for sensorless permanent magnet synchronous motor drives with parameter identification," *J. Elect. Eng. Technol.*, vol. 8, no. 3, pp. 516–523, May 2013.
- [9] D. Q. Dang, N. T. T. Vu, H. H. Choi, and J. W. Jung, "Neural-fuzzy control of interior permanent magnet synchronous motor: stability analysis and implementation," *J. Elect. Eng. Technol.*, vol. 8, no. 6, pp. 1439–1450, Nov. 2013.
- [10] K. H. Ang, G. Chong, and Y. Li, "PID control system analysis, design, and technology," *IEEE Trans. Control Syst. Technol.*, vol. 13, no. 4, pp. 559–576, Jul. 2005.
- [11] A. V. Sant and K. R. Rajagopal, "PM synchronous motor speed control using hybrid fuzzy-PI with novel switching functions," *IEEE Trans. Magn.*, vol. 45, no. 10, pp. 4672–4675, Oct. 2009.
- [12] J. W. Jung, Y. S. Choi, V. Q. Leu, and H. H. Choi, "Fuzzy PI-type current controllers for permanent magnet synchronous motors," *IET Elect. Power Appl.*, vol. 5, no. 1, pp. 143–152, Jan. 2011.
- [13] V. M. Hernandez-Guzman and R. Silva-Ortigoza, "PI control plus electric current loops for PM synchronous motors," *IEEE Trans. Control Syst. Technol.*, vol. 19, no. 4, pp. 868–873, Jul. 2011.
- [14] K. Y. Lian, C. H. Chiang, and H. W. Tu, "LMI-based sensorless control of permanent-magnet synchronous motors," *IEEE Trans. Ind. Electron.*, vol. 54, no. 5, pp. 2769–2778, Oct. 2007.
- [15] K. Y. Cheng and Y. Y. Tzou, "Fuzzy optimization techniques applied to the design of a digital PMSM servo drive," *IEEE Trans. Power Electron.*, vol. 19, no. 4, pp. 1085–1099, Jul. 2004.
- [16] T. D. Do, S. Kwak, H. H. Choi, and J. W. Jung, "Suboptimal control scheme design for interior permanent magnet synchronous motors: An SDRE-based approach," *IEEE Trans. Power Electron.*, vol. 29, no. 6, pp. 3020–3031, Jun. 2014.
- [17] T. D. Do, H. H. Choi, and J. W. Jung, "SDRE-based near optimal control system design for PM synchronous motor," *IEEE Trans. Ind. Electron.*, vol. 59, no. 11, pp. 4063–4074, Nov. 2012.
- [18] V. Q. Leu, H. H. Choi, and J. W. Jung, "Fuzzy sliding mode speed controller for PM synchronous motors with a load torque observer," *IEEE Trans. Power Electron.*, vol. 27, no. 3, pp. 1530–1539, Mar. 2012.
- [19] I. C. Baik, K. H. Kim, and M. J. Youn, "Robust nonlinear speed control of PM synchronous motor using boundary layer integral sliding mode control technique," *IEEE Trans. Control Syst. Technol.*, vol. 8, no. 1, pp. 47–54, Jan. 2000.
- [20] Z. Xu and M. F. Rahman, "Direct torque and flux regulation of an IPM synchronous motor drive using variable structure control approach," *IEEE Trans. Power Electron.*, vol. 22, no. 6, pp. 2487–2498, Nov. 2007.
- [21] K. Jezernik, J. Korelic, and R. Horvat, "PMSM sliding mode FPGA-based control for torque ripple reduction," *IEEE Trans. Power Electron.*, vol. 28, no. 7, pp. 3549–3556, Jul. 2013.
- [22] D. F. Chen and T. H. Liu, "Optimal controller design for a matrix converter based surface mounted PMSM drive system," *IEEE Trans. Power Electron.*, vol. 18, no. 4, pp. 1034–1046, Jul. 2003.
- [23] F. J. Lin, P. H. Chou, C. S. Chen, and Y. S. Lin, "DSP-based cross-coupled synchronous control for dual linear motors via intelligent complementary sliding mode control," *IEEE Trans. Ind. Electron.*, vol. 59, no. 2, pp. 1061–1073, Feb. 2012.
- [24] F. J. Lin, Y. C. Hung, J. C. Hwang, and M. T. Tsai, "Fault-tolerant control of a six-phase motor drive system using a Takagi-Sugeno-Kang type fuzzy neural network with asymmetric membership function," *IEEE Trans. Power Electron.*, vol. 28, no. 7, pp. 3557–3572, Jul. 2013.
- [25] M. A. Rahman, D. M. Vilathgamuwa, M. N. Uddin, and K. J. Tseng, "Nonlinear control of interior permanent-magnet synchronous motor," *IEEE Trans. Ind. Appl.*, vol. 39, no. 2, pp. 408–416, Mar./Apr. 2003.
- [26] M. N. Uddin and M. M. I. Chy, "Online parameter-estimation-based speed control of PM AC motor drive in flux-weakening region," *IEEE Trans. Ind. Appl.*, vol. 44, no. 5, pp. 1486–1494, Sep./Oct. 2008.



- [27] J. J. E. Slotine and W. Li, *Applied Nonlinear Control*, Prentice Hall, Englewood Cliffs, New Jersey, 1991.
- [28] G. Zhu, L. A. Dessaint, O. Akhrif, and A. Kaddouri, "Speed tracking control of a permanent-magnet synchronous motor with state and load torque observer," *IEEE Trans. Ind. Electron.*, vol. 47, no. 2, pp. 346–355, Apr. 2000.
- [29] H. H. Choi, N. T. T. Vu, and J. W. Jung, "Digital implementation of an adaptive speed regulator for a PMSM," *IEEE Trans. Power Electron.*, vol. 26, no. 1, pp. 3–8, Jan. 2011.
- [30] M. B. Argoun, "On the stability of low-order perturbed polynomials," *IEEE Trans. Autom. Contr.*, vol. 35, no. 2, pp. 180–182, Feb. 1990.
- [31] J. W. Jung, H. H. Choi, and T. H. Kim, "Fuzzy PD speed controller for permanent magnet synchronous motor," *J. Power Electron.*, vol. 11, no. 6, pp. 819–823, Nov. 2011.
- [32] F. Fernandez-Bernal, A. Garcia-Cerrada, and R. Faure, "Determination of parameters in interior permanent-magnet synchronous motors with iron losses without torque measurement," *IEEE Trans. Ind. Appl.*, vol. 37, no. 5, pp. 1265–1272, Sep./Oct. 2001.
- [33] P. H. Mellor, F. B. Chaaban, and K. J. Binns, "Estimation of parameters and performance of rare-earth permanent-magnet motors avoiding measurement of load angle," *IEE Proc. B*, vol. 138, no. 6, pp. 322–330, Nov. 1991.



**Jin-Woo Jung** (S'97–M'06) received the B.S. and M.S. degrees in electrical engineering from Hanyang University, Seoul, Korea in 1991 and 1997, respectively, and the Ph.D. degree in electrical and computer engineering from The Ohio State University, Columbus, Ohio, USA, in 2005. From 1997 to 2000, he was with the Digital Appliance Research Laboratory, LG Electronics Company, Ltd., Seoul, Korea. From 2005 to 2008, he worked at the R&D Center and PDP Development Team, Samsung SDI Company, Ltd., Seoul, Korea, as a senior engineer. Since 2008, he has been an Associate Professor with the Division of Electronics and Electrical Engineering, Dongguk University, Seoul, Korea. His current research interests are in the area of electric machine drives, control of distributed generation systems using renewable energy sources (wind turbines/fuel cells, solar cells), design and control of power converters, and driving circuits and driving methods of ac plasma display panels (PDP).



**Viet Quoc Leu** received the B.S. and M.S. degrees in electrical engineering from Hanoi University of Science and Technology (HUST), Hanoi, Vietnam in 2006 and 2008, respectively, and the Ph.D. degree in the Division of Electronics and Electrical Engineering, Dongguk University, Seoul, Korea, in 2013. His research interests are in the field of DSP-based electric machine drives and control of distributed generation systems using renewable energy sources.



**Ton Duc Do** (S'12) received the B.S. and M.S. degrees in electrical engineering from Hanoi University of Science and Technology (HUST) in 2007 and 2009, respectively, and the Ph.D. degree in the Division of Electronics and Electrical Engineering, Dongguk University, Seoul, Korea, in 2014. From 2008 to 2009, he worked at Water Resources University, Hanoi, Vietnam, as a lecturer. Currently, he is a postdoctoral researcher at the Division of Electronics and Electrical Engineering, Dongguk University, Seoul, Korea. His research interests are in the field of electric machine drives and control of distributed generation systems using renewable energy sources.



**Eun-Kyung Kim** received the B.S. degree in electrical engineering from Dongguk University, Seoul, Korea in 2009. From 2009 to 2012, she was with the Electrical Vehicle Research Laboratory, VCTech Company, Ltd., Gyeonggi, Korea. She is currently working toward the Ph.D. degree in the Division of Electronics and Electrical Engineering, Dongguk University, Seoul, Korea. Her research interests are in the field of DSP-based electric machine drives and control of distributed generation systems using renewable energy sources.



**Han Ho Choi** (M'03) received the B.S. degree in control and instrumentation engineering from Seoul National University, Seoul, Korea, in 1988, and the M.S. and Ph.D. degrees in electrical engineering from Korea Advanced Institute of Science and Technology, Daejeon, Korea, in 1990 and 1994, respectively. From 1994 to 1998, he was a Team Leader with the Advanced Technology Laboratory, DaeWoo Electrical Company. He is currently with the Division of Electronics and Electrical Engineering, Dongguk University, Seoul, Korea. He spent his sabbatical with the Department of Electrical and Computer Engineering, California State Polytechnic University, Pomona. He teaches introductory electrical engineering courses on microprocessors, robotics, sensors, and instrumentation engineering. His research interests include linear-matrix-inequality-based control system design, microprocessor-based control systems, and variable structure systems.