

ADEPT Sounding Rocket One Flight Test Overview

Alan M. Cassell,¹ Paul F. Wercinski,² Brandon P. Smith,³ Bryan C. Yount,⁴ Shakib M. Ghassemieh,⁵ Owen S. Nishioka,⁷ Carl E. Kruger,⁷ Chad A. Brivkalns,⁷ Alberto Makino,⁷ Shang C. Wu,⁸ Nghia N. Mai⁸, Ryan D. McDaniel,⁹ and Ali Guarneros-Luna¹⁰
NASA Ames Research Center, Moffett Field, CA, 94035, USA

Joseph D. Williams¹¹
Analytical Mechanics Associates Inc. at NASA ARC, Moffett Field, CA, 94035, USAj

Dzung T. Hoang¹² and Richard L. Rowan¹³
Millennium Engineering & Integration Co. at NASA ARC, Moffett Field, CA, 94035, USA

Soumyo Dutta,⁶ Ashley M. Korzun,¹⁴ and Justin S. Green¹⁴
NASA Langley Research Center (LaRC), Hampton, VA, 23681, USA

and
Jake A. Tynis¹⁴ and Chris Karlgaard¹⁴
Analytical Mechanics Associates Inc. at NASA LaRC, Hampton, VA, 23681, USA

On September 12th 2018, a sounding rocket flight test was conducted on a mechanically-deployed atmospheric entry system known as the Adaptable Deployable Entry and Placement Technology (ADEPT). The purpose of the Sounding Rocket One (SR-1) test was to gather critical flight data for evaluating the vehicle's in-space deployment performance and supersonic stability. This flight test was a major milestone in a technology development campaign for Nano-ADEPT: the application of ADEPT for small secondary payloads. The test was conducted above White Sands Missile Range, New Mexico on a SpaceLoft XL rocket manufactured by UP Aerospace. This paper describes the system components, hardware development campaign, test execution, and test conclusions.

¹ ADEPT SR-1 Lead Systems Engineer, Entry Systems and Vehicle Development Branch.

² ADEPT SR-1 Project Manager, Entry Systems and Vehicle Development Branch, AIAA Member.

³ ADEPT SR-1 Principal Investigator, Entry Systems and Vehicle Development Branch, AIAA Member.

⁴ ADEPT SR-1 Structures and Mechanisms Lead, Engineering Systems Division.

⁵ ADEPT SR-1 Systems Engineering & Avionics Lead, Chief Engineer's Office.

⁶ ADEPT SR-1 Flight Mechanics Lead, Atmospheric Flight and Entry Systems Branch, AIAA Member.

⁷ Mechanical Engineer, Engineering Systems Division.

⁸ Electrical Engineer, Engineering Systems Division.

⁹ Aerospace Engineer, Aerothermodynamics Branch.

¹⁰ Aerospace and Systems Engineer, System Safety and Mission Assurance Division.

¹¹ Aerospace Engineer, Entry Systems and Vehicle Development Branch.

¹² Electrical Engineer, Engineering Systems Division.

¹³ Engineering Evaluation Laboratory Engineer, Applied Manufacturing Division.

¹⁴ Aerospace Engineer, Atmospheric Flight and Entry Systems Branch, AIAA Member.

I. Introduction

NASA's 2015 technology roadmap identifies mechanically deployed entry systems as a technology candidate with mission enabling benefits. Adaptable Deployable Entry and Placement Technology (ADEPT) is a mechanically deployable decelerator employing a 3D woven carbon fabric that serves both as thermal protection and primary structure. Specific missions identified by the roadmap that ADEPT could enable are large payload delivery to Mars surface [1], ISS down-mass, and Earth return beyond low Earth orbit. Recent work has shown that ADEPT could also have enabling science benefits for small spacecraft missions that are riding along as secondary payloads and in need of a low-volume, deployable entry system that can withstand high temperatures. These "Nano-ADEPT" entry vehicles (< 1 m diameter) are targeted for systems with an entry mass of less than 25 kg and a payload mass on the order of 15 kg. For mission considerations, Nano-ADEPT is intended where volume is a constraint that would limit or prohibit the use of a rigid aeroshell for the mission application. [2]

The ADEPT development strategy, and Nano-ADEPT in particular, represents a design approach that utilizes simple mechanical and electrical interfaces with the payload and launch vehicle (LV). Nano-ADEPT uses a reliable and robust deployment mechanism, as well as commercial-off-the-shelf (COTS) parts where possible. The ADEPT Sounding Rocket-One (SR-1) flight experiment is a component of the broader 1 m-class development strategy to reach technology maturation for mission infusion, described in more detail in Smith, et al [3].

The ADEPT SR-1 flight test was the first sub-orbital flight of Nano-ADEPT. Details of the SR-1 test objectives and concept of operations are described in earlier publications [4] and will be briefly included here for the sake of completeness. SR-1 will mature ADEPT in the areas of deployment and structural integrity (for Nano-ADEPT missions), and improve aerodynamic knowledge of the ADEPT open-back configuration. In addition, SR-1 is an integrated system demonstration in a partially relevant environment (SR-1 did not experience significant heating but reached supersonic speeds). When considered with all the previous ground test and analysis products for the ADEPT project, successful demonstration of the SR-1 flight test Key Performance Parameters (KPPs) will support a technology readiness level (TRL) claim of 5 for Nano-ADEPT at the system-level. The KPPs for the ADEPT SR-1 flight experiment are:

- 1) Exo-atmospheric deployment to the desired entry configuration.
- 2) Aerodynamic stability without active control of the 1m-class ADEPT deployed flight configuration.

As with any new technology requiring in-space deployment, demonstrating deployment in relevant environments significantly increases the reliability for the design. While ADEPT was only exposed to exo-atmospheric conditions for ~ 40 seconds prior to deployment, the test demonstrated design robustness to the launch environments and verified the deployment initiator timer circuit and rib-tip release functionality. Furthermore, achieving and maintaining the desired deployed shape was critical to the aerodynamic performance. On-board full deployment indicator switch and a video camera were used to confirm KPP-1.

The altitude of apogee determines the total potential energy of the entry vehicle and is correlated to a maximum Mach number experienced during descent. A higher apogee means higher entry velocity and thus higher maximum Mach number. It was a goal to observe the entry vehicle flight dynamics during deceleration from at least Mach 2.8 through Mach 0.8. Mach 2.8 was chosen because flight data from Mars Pathfinder, a 70° sphere-cone with a conical aft body, showed unbounded angle of attack amplitude growth at Mach 2.5 prior to supersonic parachute deployment. The 70° cone angle helps achieve a low ballistic coefficient but has less stability margin than lower cone angle entry configurations. We sought to confirm that ADEPT SR-1 angle of attack oscillations should remain neutrally stable or damped by virtue of its open-back shape and center of gravity location. The open-back configuration was expected to provide some stability benefit over a closed-back design. Figure 1 shows the stability definition SR-1 KPP-2.

A summary of the SR-1 Flight Experiment Success Criteria is listed below:

- A. ADEPT separates from the sounding rocket prior to apogee
- B. ADEPT does not re-contact any part of the launch vehicle after separation
- C. ADEPT reaches an apogee greater than 100 km.
- D. ADEPT achieves fully deployed and locked configuration prior to reaching 80 km altitude on descent.
- E. Obtain video (on-board data recovery after ground impact) of deployed ADEPT to observe fabric response during entry
- F. Obtain data necessary to reconstruct ADEPT 6-DOF descent trajectory between 90 km and 30 km.

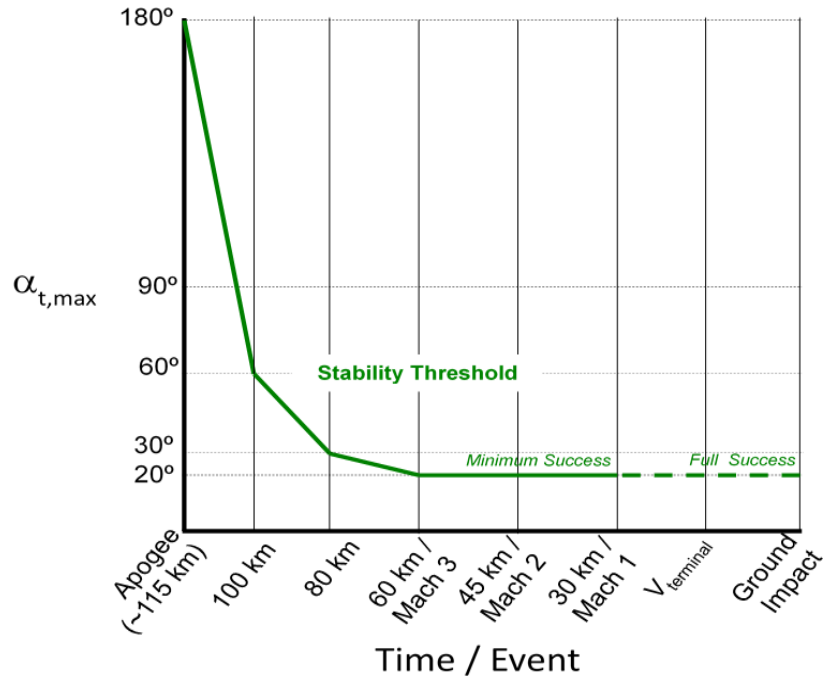

Figure 1- Total angle of attack oscillation amplitude ($\alpha_{t,max}$) stability threshold for ADEPT SR-1. Any angle of attack excursions above the stability threshold must damp within 2 cycles back into the stable region to be considered dynamically stable.

Achieving the KPPs placed key performance requirements on the launch vehicle that carried the SR-1 payload. Separation from the LV is an important step in the ADEPT flight test operations timeline. Without successful separation, none of the remaining success criteria can be met. Possible re-contact would likely result in the inability of SR-1 to deploy as designed or result in an unacceptable flight attitude at atmospheric interface. The LV was also responsible for imparting a spin rate to gyroscopically stabilize SR-1 after deployment so that the nose down attitude would be maintained until atmospheric interface.

The SR-1 configuration forms an octagonal pyramid with a spherical nose cap aeroshell when deployed. Figure 2 shows the launch (stowed) and entry (deployed) configuration. The projected area increases nearly a factor of eight from the stowed to deployed shape. For this mission, the rectangular prism-shaped payload volume (~3U CubeSat form factor) is mostly filled with instrumentation, and the “payload” volume is integrated to the aft side of the aeroshell. The nominal dimensions of the stowed configuration are 0.24 m diameter, while the deployed configuration is 0.7 m diameter (rib-tip to rib-tip) with a 70° “half-cone” angle at the ribs. Figure 3 shows a line drawing of the ADEPT SR-1 entry configuration. The total mass was 11.0 kg (24.2 lb).

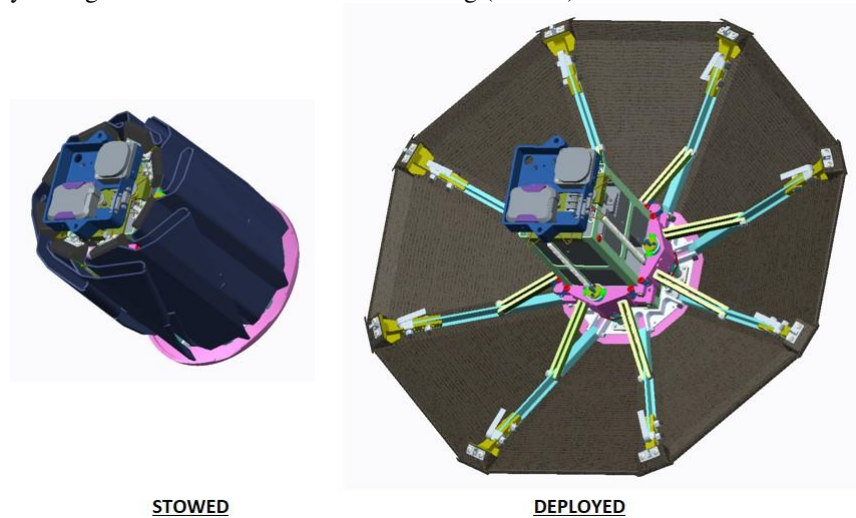

Figure 2- CAD models of the stowed and deployed configurations viewed from the aft side.

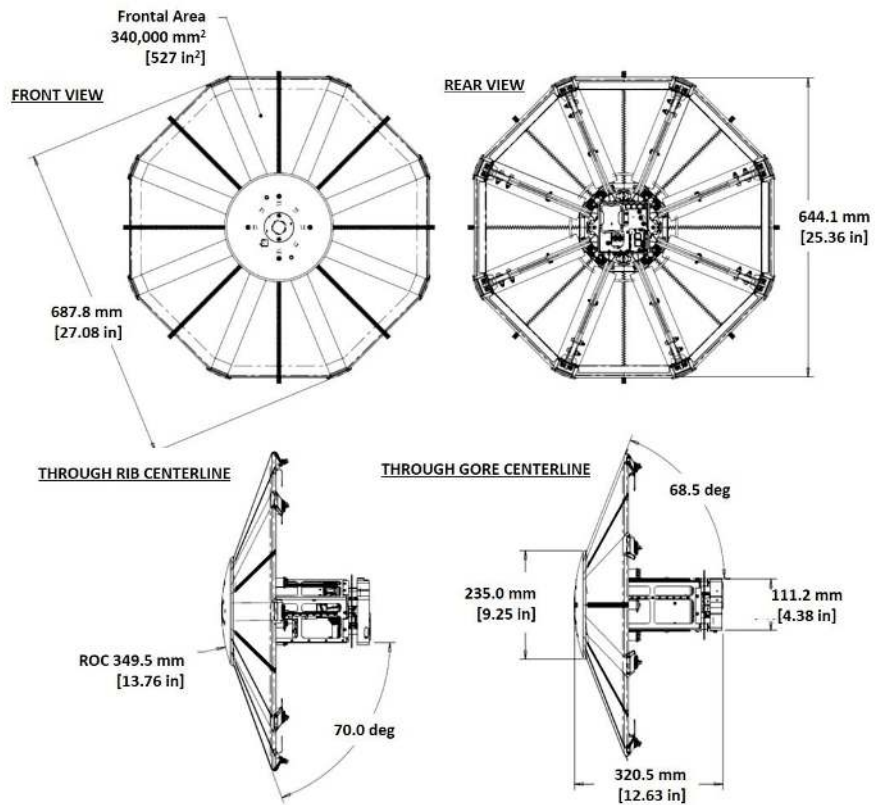

Figure 3- Line drawing of the deployed configuration.

II. Hardware Overview

The ADEPT entry vehicle is comprised of a mechanical (shown in Figure 4) and electrical subsystems (shown in Figure 5). The primary functional requirements of the mechanical system are to deploy and tension the 3D woven carbon fabric aeroshell, lock the structure in a fully-deployed and tensioned configuration, and maintain the required aerodynamic shape. A 4-layer carbon fabric [5] was baselined after conducting folding tests on 4, 6, and 8-layer weaves while also considering the deployment mechanism design and its ability to achieve the required fabric pre-tension. The 6 and 8-layer weaves were quite stiff and difficult to fold into the compact size required for the launch vehicle payload volume. The 4-layer weave had the most desirable stowage characteristics. The carbon fabric was comprised of 16 ends per inch (epi) of 6k IM7 carbon tows in the warp direction, while there are 14.5 epi of 6k IM-7 carbon tows in the weft (fill) direction. The bottom two layers are composed of orthogonal weave, which provides the primary structural function for the fabric skirt, while the top two layers are composed of layer to layer plain weave, which serve as the sacrificial thermal protection layers. The carbon fabric is then stitched together with carbon thread to make structural joints between the gore panels. Additionally, a trailing edge tension cord pocket and rib-end attachment features are incorporated to complete final carbon fabric skirt assembly.[6] A three-phase spring system was developed to deploy and tension the fabric skirt and lock the structure into place. In the launch configuration, the moving ring is located near the aft-end of ADEPT and the ribs, struts and fabric are folded up like an umbrella. In this configuration, a retention cord is routed through the eight retention cord loops and tied tightly such that the eight push-off springs are in compression. Deployment is initiated when the retention cord is severed by one of the two burn-wires (see Figure 5). This causes a chain reaction of several mechanical events. First, the push-off springs cause the ribs to move a small distance from the centerbody at which point the first-stage springs can pull the moving ring toward the nose along the rails (without the push-off springs, the first-stage springs may not have enough leverage to pull the moving ring forward). Once the moving ring has translated most of the way to the nose, the four second-stage springs are released by four pins mounted to the nose cap. These second-stage springs are responsible for adding tension into the fabric by translating the moving ring the remaining small distance on the rails. Once the structure is fully deployed, eight latches engage to lock the structure at its final position and the full-deployment indicator switch (see Figure 5) is triggered. The ADEPT structure is now fully deployed. The time between retention cord severing and fully-locked deployment is less than one second.

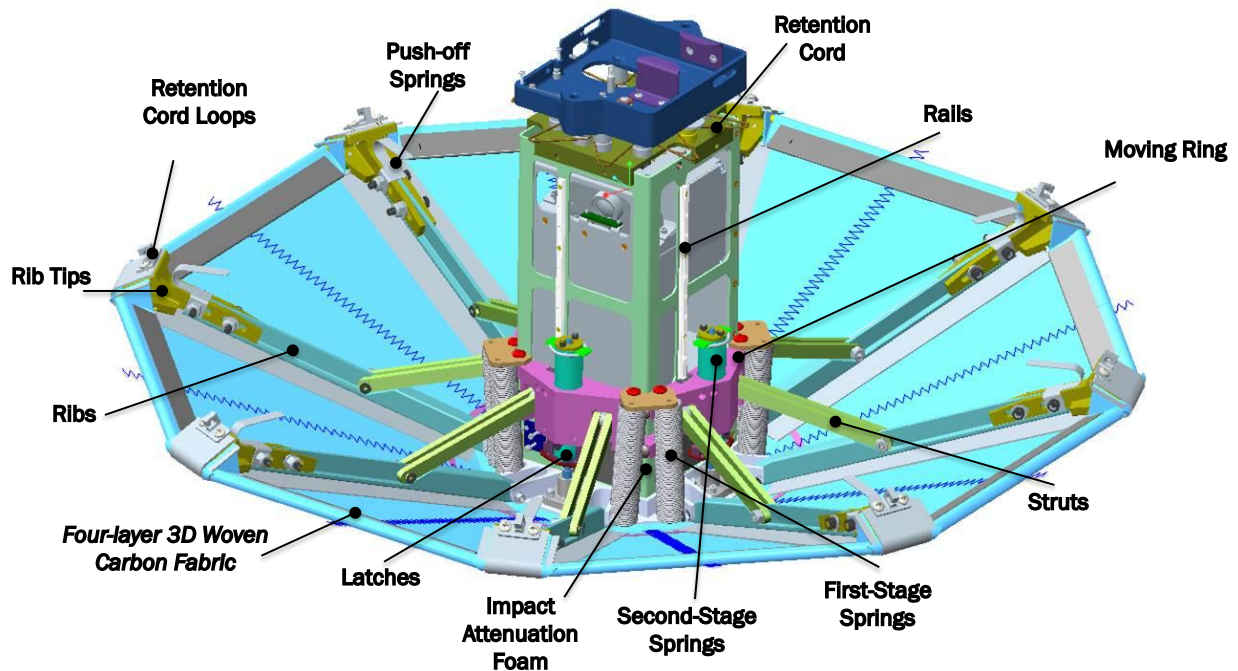

Figure 4- Mechanical subsystem overview.

The electrical subsystem, shown in Figure 5, is controlled by the Electrical Power System Board and electrical ground support equipment (EGSE) that attaches to ADEPT through the Late Access Connectors / GSE Interface. Items identified in Figure 5 with blue text are powered on during pre-launch procedures, and items identified in green text are powered on once separation from the launch vehicle is sensed. Since SR-1 does not use telemetry, the instrumentation housed within the payload volume is selected and designed to survive impact with the ground. The Affordable Avionics Unit (AVA) and the backup inertial measurement unit (IMU) are powered on manually prior to launch using the EGSE equipment. The AVA unit [7] is a government off-the-shelf (GOTS) low cost avionics package designed to provide Guidance, Navigation, and Control (GNC) functionality in a small package (approximately 4 in x 4 in x 2 in). The AVA unit takes advantage of commercially available, low-cost, mass-produced, miniaturized sensors and provides real-time Extended Kalman Filtering. AVA was designed with the goal of producing and flight-verifying a common suite of avionics and software that deliver affordable, capable GNC functionality. The AVA module includes three primary subsystems: an inertial measurement unit (IMU) consisting of three-axis rate gyros and accelerometers, a magnetometer that can sense ADEPT's orientation relative to Earth's magnetic field, and a GPS receiver. The GPS antenna identified in Figure 4 is connected to the AVA GPS antenna port. ADEPT uses AVA's on-board data logging of accelerometer, gyro, magnetometer and Global Positioning System (GPS) data for post-flight trajectory reconstruction (each channel recorded at 100 Hz). The backup IMU is a Next Generation IMU (NGIMU), made by X-IO Technologies. The NGIMU provides a redundant set of AVA sensors (except for GPS), and also includes a barometric sensor and temperature measurements of IMU components (each channel recorded at 400 Hz). The C-band transponder enhances radar tracking and provided a back-up means to obtain position data during descent. A ruggedized, custom battery pack (~72 W-hr capacity) provides power for all of the electrical hardware, except for the GoPro® camera and SPOT Trace®, which use internal batteries. The Electrical Power System (EPS) board manages power distribution and event timing for the various subsystems. The GoPro video camera (1080 p, 60 frames per second) provides imaging of the deployment event, an on-board view of the deployed SR-1 carbon fabric skirt and horizon during entry/descent through the atmosphere, and a recording of SR-1's LED system status indicators (which show power system health, event timing, and deployment status). As another means to aid recovery location determination, a SPOT Trace unit was included on the aft end of the SR-1 vehicle to transmit GPS location that could be downloaded through mobile cellular devices. The electrical subsystem is built primarily as a carriage that is fastened to the mechanical subsystem with shear pins. Upon impact with the ground, these fasteners are designed to break so that the electronics carriage will push into the impact attenuation foam shown in Figure 4. The foam attenuates the impact load felt by the on-board instrumentation, power and electrical components.

ADEPT was ejected from the launch vehicle 95 seconds after launch, at which point the separation sensors triggered the start of a timer circuit (the LV's pusher plate includes two magnets that are sensed by two magnetic switches on ADEPT). The separation sensor circuit causes electrical power to be immediately supplied to the C-band transponder, while simultaneously activating the burn wire timer circuit (designed for 40 second delay). This delay was programmed to ensure that even if ADEPT became unseated from the separation magnets due to nose cone separation, ADEPT would not deploy prior to ejection. At the same time separation is sensed, the GoPro camera powers on. Radar tracking stations at White Sands Missile Range (WSMR) can then detect ADEPT using its unique C-Band frequency and code spacing. Within seconds after the burn wires are supplied power, they heat up and sever the Vectran® retention cord that keeps ADEPT in a stowed configuration. Burn-wire activation is confirmed through two LEDs that illuminate when power is applied to the burn wire circuits. Once ADEPT deploys past a critical angle (~69°), the full-deployment indicator switch causes the respective LED to illuminate. This LED provides confirmation of full-deployment and deploy circuit timing as recorded by the GoPro camera.

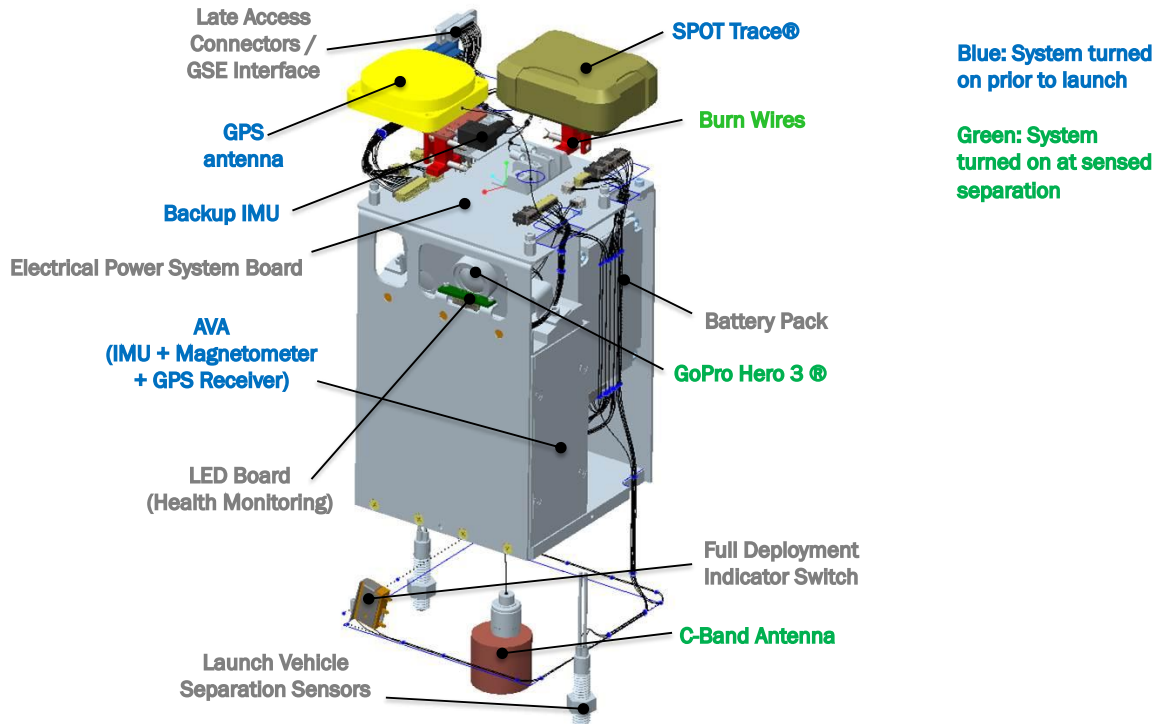

Figure 5- Electrical subsystem overview.

III. Development Campaign

Early in the development phase, a Deployment Demonstrator was designed and tested to demonstrate a deployment mechanism that met the design requirements and was compatible with the launch environments. The testing also served to demonstrate that a spring-based deployment system could be used to adequately pre-tension the 4-layer carbon fabric aeroshell skirt. Another component of the Deployment Demonstrator was the rib retention and release mechanism. This system utilizes a Vectran™ cord looped through the rib ends and two spring loaded nichrome burn wires.[8] When activated the nichrome heats up and cuts through a Vectran™ retention cord, initiating deployment. Once the carbon fabric skirt was successfully installed and adjusted for a tension level required for flight, extensive testing was performed to refine the deployment system design.

Since there is no parachute utilized to slow the descent of the SR-1 entry vehicle, a critical risk reduction activity was to ensure that the on-board data sources would survive a hard impact. Estimated terminal velocities of 25-30 m/s and impact with the relatively hard desert floor could cause excessive g-loading (>1000 g) and damage to the on-board data storage devices. In addition, the SR-1 electronics carriage contains rechargeable lithium-ion batteries. Damage to the batteries upon impact could lead to fire and destruction of the memory cards and failure to meet key mission objectives. To mitigate these risks, a robust battery package design incorporating fusible links was employed along with high shock rated micro-SD memory cards and an impact attenuation system.

A series of drop tests were executed to characterize the impact load, evaluate various impact attenuators, and increase the reliability, robustness and safety of the design. Drop tests from heights of 80-110 feet replicated the range of terminal velocities expected. The external scaffolding of the National Full-Scale Aerodynamics Complex 80 ft x 120 ft wind tunnel served as the drop test platform (Figure 6). Test instrumentation included a high-speed video camera to measure terminal velocity at impact and an on-board accelerometer with high data rate to characterize the impact event. Post impact screening tests demonstrated that the micro-SD cards survived with data intact, and that the secondary lithium-ion battery cells remained healthy and did not appear to suffer any damage.



Figure 6- Impact test location and test set-up description.

Other development activities conducted included sub-sonic wind tunnel testing to understand pre-tension levels required to minimize fabric deflection under aerodynamic loading [9], subsonic free-flight testing used to inform a center of mass location requirement [10], and aerodynamic database development [11].

Prior to integrating the electrical subsystem components together inside the electronics chassis, environmental stress screening (ESS) was performed to screen for defective parts and improper workmanship during manufacture. ESS is a cost-effective means of improving reliability, and allows for relatively straightforward replacement of defective parts and/or components prior to higher level integration. ESS was comprised of thermal vacuum and random vibration tests on the electrical power system board, AVA unit, back-up IMU, modified GoPro, SPOT Trace, LED indicator board, separation sensors, deployment switch, and the main battery (with protection circuit module). After ESS, all of the electrical components (except SPOT Trace unit) were 'laid out into a Flat Sat configuration (Figure 7) to allow for electrical system functional testing prior to integration. This procedure enabled the electrical subsystem requirements and EGSE performance specifications to be verified. This was also the first chance to test inhibit circuits within the EGSE that allowed for independently powering certain components in preparation for downstream testing at the integrated system level. After Flat Sat testing was completed, the electrical components were integrated into the electronics chassis in preparation for assembly with the mechanical subsystem.

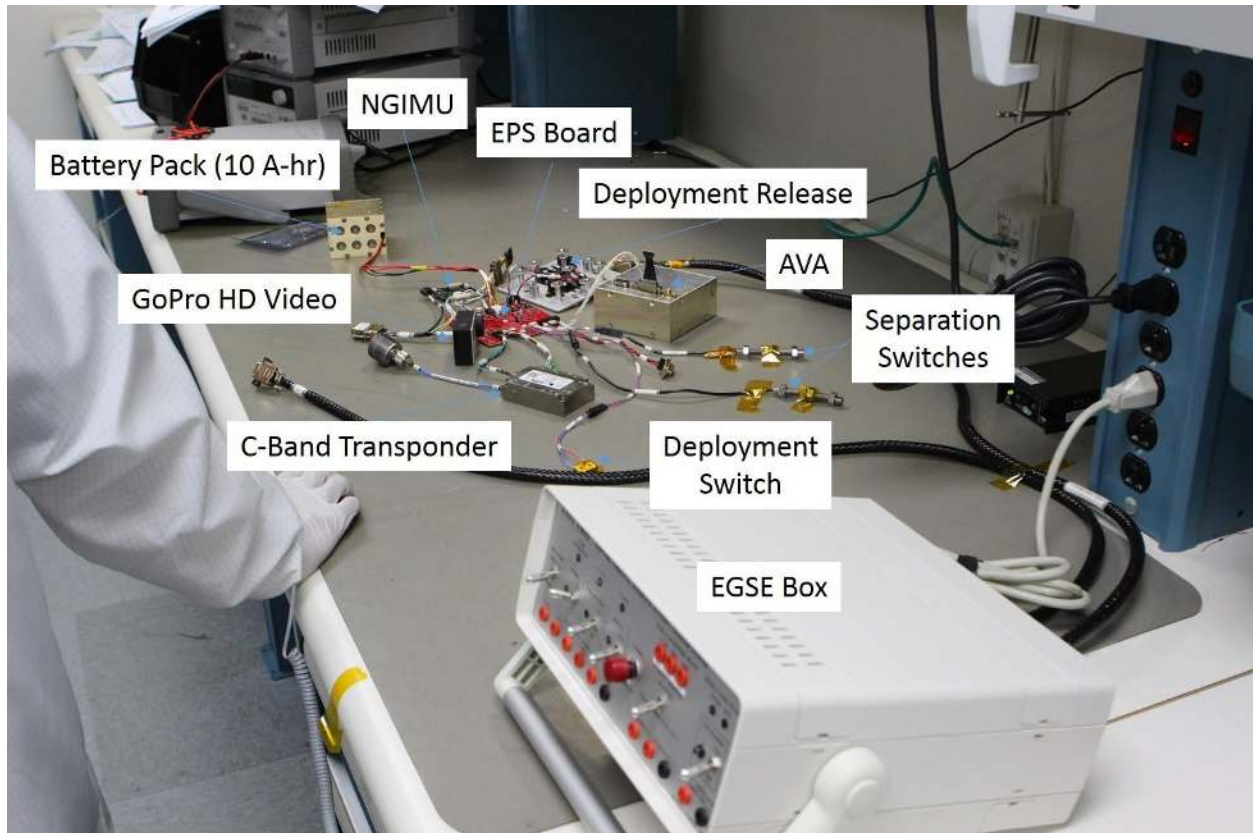

Figure 7- Flat Sat testing prior to electrical subsystem integration.

Two flight units were built and tested in preparation for launch: one designated the Spare unit and one the Flight unit. Final assembly was completed by integrating the mechanical subsystem (including impact attenuator, rib-release deck and aft deck) with the electrical sub-system as shown in Figure 8. After fine adjustments to the rib length and fabric tension levels were performed, the deployment design was verified through repeated deployment tests. Required carbon fabric pre-tension to maintain desired aerodynamic shape was verified through a deflection test wherein the maximum expected flight dynamic pressure (~900 Pa) was applied over the ADEPT surface with a vacuum bag.

The general development approach has been to perform all procedures on the Spare unit prior to performing them on the Flight unit. The Spare unit was also utilized for other risk reduction activities including long duration stowage and deploy tests, and repeated mission simulation testing rehearsals. This approach was taken to refine and rehearse mission simulation procedures and minimize stowage/deploy cycles in the Flight unit fabric skirt. Once the units were assembled, a System Integration test procedure was performed to verify system level functionality, which was followed by system level vibration testing and mission simulation testing. The LV provider was responsible for verifying the de-spin and separation system designs using a test demonstration unit that replicated the SR-1 Flight unit mass properties and mechanical interfaces to the Payload module. Mission simulation testing replicated the planned pre-launch preparations, launch window and expected flight timelines and also incorporated deployment and flight simulation tests. Once these tests were complete, the Flight unit was prepped for shipment to the LV provider for Combined Systems testing. The purpose of the Combined Systems Test (CST) was to verify the ADEPT mechanical interface and electromagnetic interference compatibility with the SpaceLoft XL rocket and other co-manifested payloads. ADEPT was physically installed in the payload module and then other systems (payloads and LV Avionics) were powered in the same sequence expected during preparation for launch. The test was to ensure that all the systems functioned together, and served as a gate for proceeding with launch preparations at the launch site. The CST ends after ADEPT has simulated separation (no deployment or recovery procedures are simulated).

Electrical Subsystem



Mechanical Subsystem

- + Rib Release Deck
- + Aft Deck
- + Impact Attenuator

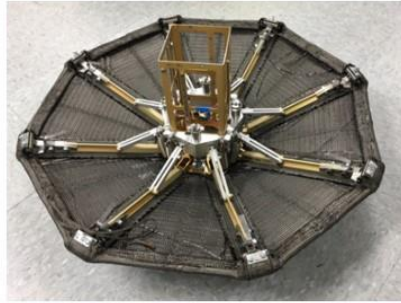

Top Level Assembly

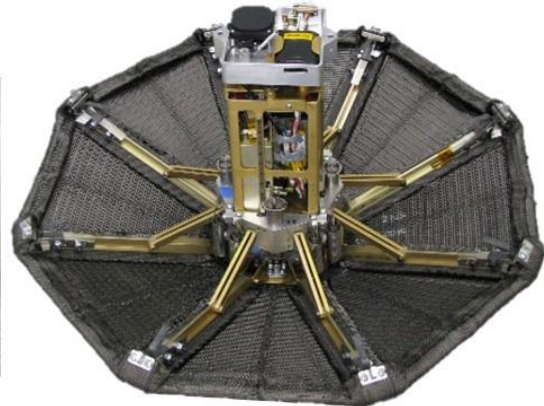

Figure 8- Final assembly description.

IV. Flight Test Execution and Operations

During pre-launch activities, SR-1 was prepared and integrated into the LV payload module and final system checks were performed. The payload module was then integrated with the entire LV to prepare for launch operations. The day prior to launch, a mission dress rehearsal was performed after which the main battery within ADEPT was charged to full capacity. Figure 9 shows the LV layout on the morning of launch. There are three primary components of the LV, the booster, payload module (includes LV avionics, recovery system and payloads), and nose section. The LV is also equipped with 3 GoPro cameras to capture various views during flight. A prismatic mirror mounted in the payload module section outer skin allows for a view looking down toward the booster. The second camera is mounted in the nose section looking towards the payload module (to capture the nose separation event), and the final camera is mounted on the separation section push plate that looks up towards the nose (which records ADEPT separating from the payload module).



Figure 9- LV moving to launch position. ADEPT SR-1 is housed just behind the nose in the separation section.

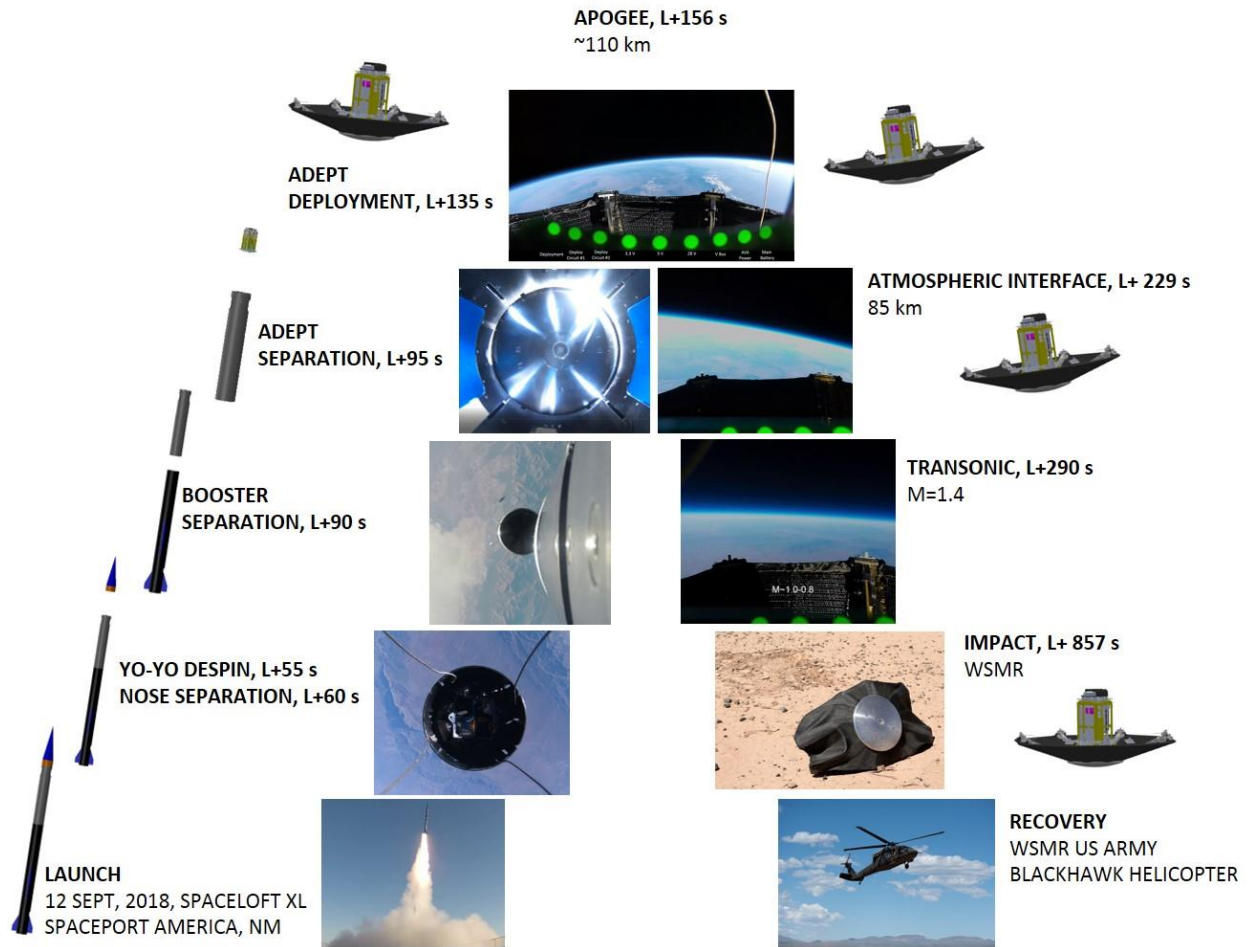

Figure 10- Concept of Operations and key event timing with actual still frames included.

ADEPT SR-1 was launched as part of the UP Aerospace SL-12 mission sponsored by the NASA Flight Opportunities program. The launch occurred from the vertical launch area at Spaceport America in New Mexico into the White Sands Missile Range (WSMR) on September 12, 2018 at 13:33 UTC (7:33 AM local). The ADEPT SR-1 Flight unit was powered-on at approximately 5:30 AM local time, 2 hours prior to the launch window opening. Terminal countdown operations commenced after high altitude wind data was obtained from a previously released balloonsonde, which allowed for final launch rail elevation and azimuth adjustments.

The operations timeline is shown in Figure 10. After launch, booster burn-out occurred ~12 s into flight followed by high spin (>7 Hz) coast to the de-spin mechanism deploy point (launch + 55 s). Next, the nose was separated (launch + 60 s), followed by booster separation (launch + 90 s) and ADEPT separation (launch + 95 s). Sensing separation from the LV at + 95 s, ADEPT deployed 40 seconds later at + 135 s. Figure 11 shows a still image extracted from the onboard GoPro video camera just after deployment with the LED status indicator board in view displaying that all systems were functioning as expected. The fully locked deployment indicator status LED is lit (leftmost LED), indicating the project goal for fully locked deployment into the desired aerodynamic shape prior to entry was met. Apogee (~110 km) was reached at +156 s. As ADEPT descended it encountered atmospheric interface (defined as 85 km), which occurred at +229 s. ADEPT decelerated through the transonic flight regime at +290 s. Impact occurred at +857 s within WSMR. The ADEPT test article was radar tracked by WSMR as it returned to Earth. A Sikorsky UH-60 Black Hawk helicopter was dispatched around 1:30 PM in the afternoon of September 12 approximately 6 hours after SR-1 impacted the ground. The final radar location latitude and longitude were provided to the recovery team which quickly located the test article once the helicopter arrived at the impact site approximately 30 miles E-NE from the launch site. Figure 12 shows the final resting condition of the test article, along with the suspected initial impact point, approximately 3 feet away. The article appeared to have impacted on the rib ends as there was no noticeable damage to the stainless steel nose, and some of the ribs were bent towards the centerbody. Initial examination also

showed that none of the LEDs were illuminated, which indicated there was no power to the instrumentation and electronics.

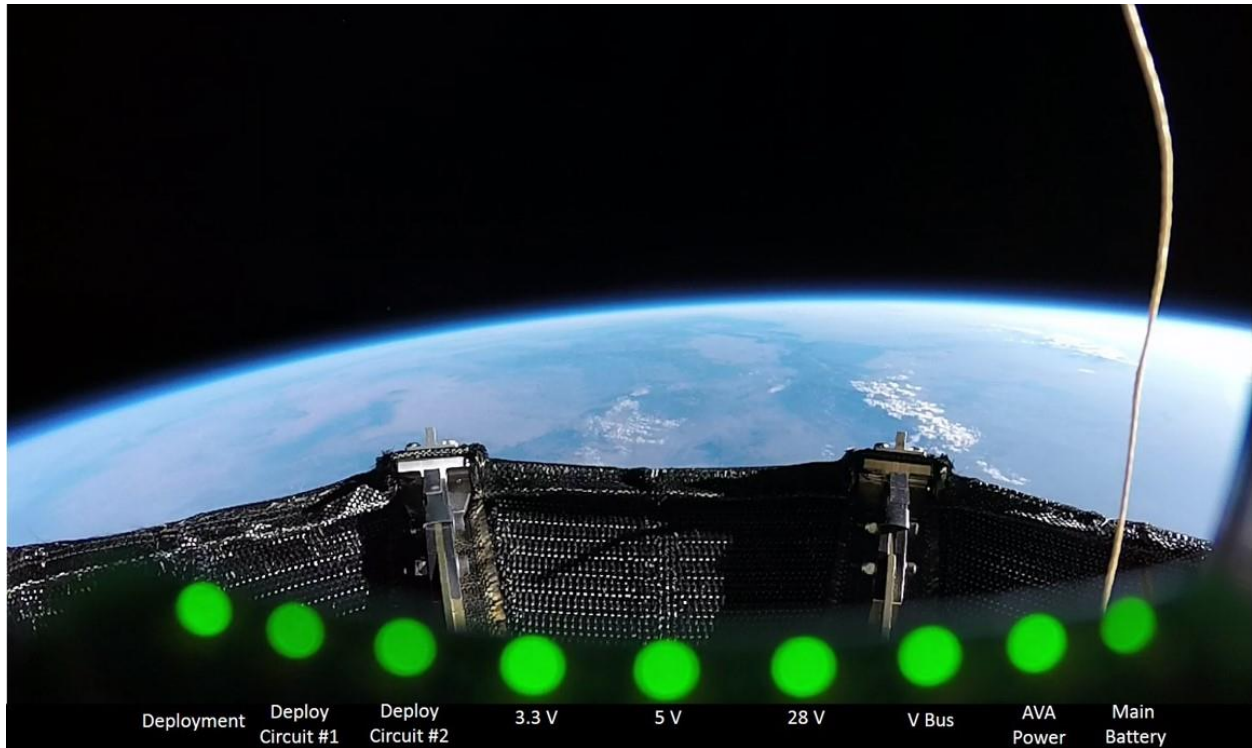

Figure 11- still frame taken from onboard GoPro video just after exoatmospheric deployment showing all 9 health status LEDs illuminated.

A brief examination of the vehicle disclosed no evidence of battery rupture, and there was no evidence of power being supplied to any system. The ADEPT SR-1 vehicle was prepared for helicopter transport by severing and isolating the battery cables and placing the Flight unit in a transport case. Immediately upon return to the launch site payload processing facility, the GoPro SD card was removed and handed over to WSMR for content review. The NGIMU SD card was also removed. Removal of AVA required disassembly of the main chassis and electronics carriage, and was performed later in the day. There was no damage to the AVA chassis and removal of the AVA SD card was straightforward. Data products from AVA and NGIMU were downloaded in accordance with post-flight data recovery and back-up procedures. The main battery was also examined and found to be in perfect working condition. To prepare for transport back to the laboratory at NASA Ames, the battery was discharged to less than 30% capacity.



Figure 12- Impact site and recovery operations.

V. Flight Test Conclusions

ADEPT SR-1 had several sensors on-board the vehicle and also leveraged several third-party data sources for initial flight analysis and trajectory reconstruction. Table 1 shows the status of the on-board and third-party data sources. All on-board instruments have been processed and incorporated into the initial trajectory reconstruction. Unfortunately, one source of the on-board data – GPS – was not usable because the minimum number of satellites for a valid measurement were not met during flight (3 satellites were obtained, minimum required is 4). Much of the essential third-party data products, such as the launch vehicle IMU and partial radar tracking information has also been collected. Based upon data review, the LV has met exo-atmospheric delivery performance requirements of spin rate, no re-contact, separation velocity, and delivery altitude. WSMR provided ground-based radar tracking data for the mission. Ground tracking of SR-1 was expected to occur shortly after separation (prior to reaching apogee) but was delayed due to a ground operations communication error between UP Aerospace Launch Control and the WSMR tracking stations just moments prior to SL-12 launch. Radar tracking of SR-1 was achieved after apogee but before SR-1 re-entered the atmosphere. The three SR-1 on-board data sources: 1) GoPro video, 2) AVA, and 3) NGIMU, were all operational and successfully stored in-flight data, which were recovered post flight.

GoPro video: Video recording started at SR-1 separation (launch + 95 s) from the LV payload module prior to reaching apogee. Video recorded un-interrupted for 501 seconds capturing the exo-atmospheric deployment event, peak Mach number, and deceleration through sub-sonic terminal descent. Recording unexpectedly stopped at an approximate altitude of 8 km (t=596 seconds) during low sub-sonic descent and tumble. This recording stoppage did not affect trajectory reconstruction or success criteria. The project suspects that the GoPro shut down occurred due to a low-temperature battery condition.

AVA: AVA provided gyro (attitude rate) measurements, IMU, magnetometer, and GPS data. AVA was turned on prior to launch and full-functionality was confirmed on morning of launch prior to final closeout. The gyro and IMU data were recorded and found to be of good quality although the gyro data was saturated during lower portions of subsonic descent due to SR-1 experiencing subsonic ($M < 0.3$) tumbling (which was acceptable) and did not impact success criteria. Unfortunately, a GPS signal was only obtained from 3 satellites whereas 4 satellites are the minimum needed to resolve quality positional and velocity measurements. This lack of GPS data will affect the project's ability to meet trajectory reconstruction accuracy targets but not the evaluation of the overall vehicle flight performance (e.g. stability).

NGIMU: Provided backup gyro and IMU measurements. Data from NGIMU serves as another data source for reconstructing attitude, position and velocity of SR-1 throughout the flight.

A summary of ADEPT SR-1 performance against the Flight Test Success Criteria is offered below. The primary data products used to inform these conclusions will be described in post-flight trajectory reconstruction [12] and flight mechanics analysis [13].

ADEPT SR-1 Success Criteria (A-F) Assessment

- A. ADEPT separates from the sounding rocket prior to apogee
- Pass, confirmed by three independent data sources- AVA IMU, NGIMU, GoPro
- B. ADEPT does not re-contact any part of the launch vehicle after separation
- Pass, no evidence of re-contact based upon on-board IMUs and video data provided by LV provider
- C. ADEPT reaches an apogee greater than 100 km
- Pass, confirmed by radar tracking and post flight reconstruction
- D. ADEPT achieves fully deployed and locked configuration prior to reaching 80 km altitude on descent
- Pass, evidence from GoPro video and LED deployment indicator
- E. Obtain video (on-board data recovery after ground impact) of deployed ADEPT to observe fabric response during entry
- Pass, GoPro video was obtained from approximately t=130 to t=501 seconds
- F. Obtain data necessary to reconstruct ADEPT 6-DOF descent trajectory between 90 km and 30 km to required accuracy below with 95% confidence from Mach 3.0 while decelerating to ground impact.
 - a. Mach number: 0.1
 - b. Total angle of attack: 2 deg (if not tumbling)
 - c. Axial force coefficient: larger of 5% or 0.005 (if not tumbling)**- Incomplete, ADEPT will be able to reconstruct the descent trajectory, but indications are that the desired level of accuracy will not be met due to the lack of GPS data.**

ADEPT SR-1 had two major Key Performance Parameters:

1. Exo-atmospheric deployment to an entry configuration of the 1m-class ADEPT.
Assessment: Goal value of KPP met with confirmed fully locked deployment to 70 deg rib cone angle prior to entry achieving ~ 8x increase in drag area over stowed configuration
2. Aerodynamic stability without active control of the 1m-class ADEPT deployed flight configuration.
Assessment: Threshold value of KPP met with GoPro video (and on-board gyros) indicating stable flight from supersonic conditions through Mach 0.6.

Data Sources	Status/Notes	Comment
AVA IMU	Utilized in initial trajectory reconstruction	
AVA GPS	Not utilized in trajectory reconstruction	Minimum number of satellites not met
AVA Magnetometer	Utilized in initial trajectory reconstruction	
NGIMU	Utilized in initial trajectory reconstruction	
GoPro Video	Video recorded through launch +595 seconds	GoPro stopped recording below M=0.2, Qualitatively confirmed key data observations.
LV IMU	Utilized in initial trajectory reconstruction	
AFTU GPS	Utilized in initial trajectory reconstruction	
Radar Tracking	Utilized in initial trajectory reconstruction	Data obtained on descent from 99 km altitude

Table 1- Data sources summary and utility for trajectory reconstruction.

The ADEPT SR-1 flight experiment met 5 out of 6 mission success criteria and satisfied both KPPs, so thus has demonstrated the advancement of the Nano-ADEPT system to a TRL of 5. Several noteworthy observations from the flight however, indicate that further study is needed:

- An increase in roll rate (from 44 deg/s to 370 deg/s) was observed during supersonic to transonic deceleration. The cause of this is not known at this time, but the faceted forebody geometry is being looked at more closely in post flight analysis.
- SR-1 started tumbling at t=407 sec which corresponds with approximately Mach=0.25. This was a known possibility and can be mitigated with a parachute or drogue.

The ADEPT SR-1 flight test provided a low-cost means of achieving significant system level maturity for the 1 m class Nano-ADEPT design. Continued improvements in thermostructural design and predictive modeling tools are anticipated to prepare for a low earth orbit re-entry demonstration test that will achieve mission readiness for secondary payloads such as CubeSat and Small Satellite class missions.

VI. Future Work

Preliminary reconstruction has been completed using on-board IMU data coupled with external radar observations and atmospheric profile information [12]. Future work will be focused on incorporation of additional data sources and observations. The preliminary estimates of the reconstructed trajectory are not expected to deviate dramatically in future revisions, but the uncertainty in the estimated trajectory can decrease as more data types are incorporated.

Flight dynamics models used to inform stakeholders of system performance and risk prior to the flight test are also being evaluated against the reconstructed trajectory. Pre-flight modeling assumptions will be reconciled with the reconstructed conditions to see if models, such as the aerodynamic database (ADB), need to be adjusted. The goal of this aspect of post-flight analysis is to understand how the ADEPT SR-1 flight can inform models and design choices for future missions that use the ADEPT shape. For example, based on the unexpected roll rate increase observed during supersonic and subsonic phase of flight, it is expected that the rolling moments in future ADBs for faceted ADEPT-like forebodies could have large uncertainties and a non-zero mean.

The pre-flight ADB assumed the vehicle to behave as if SR-1 were fully axisymmetric, without consideration of how the faceted shape behaves at non-zero sideslip angles. The pre-flight ADB applied zero roll moment coefficients, with a small, non-zero uncertainty. Post-flight analysis has focused on completion of additional CFD solutions on the original, smooth geometry at non-zero sideslip angles, up to 20 deg. Initial solutions at Mach 2 for non-zero sideslip are yielding non-zero roll moment coefficients with magnitudes that are much greater than the pre-flight uncertainty. CFD solutions on the original, smooth, faceted geometry will be completed for the remaining Mach numbers. A subset of solutions will then be computed on a less ideal geometry to quantify differences when additional details in forebody geometry are included.

The ADEPT project has focused on ballistic, axisymmetric shapes as the logical ‘first step’ in mission infusion applications. With the current maturation and development of the ballistic (non-lifting) 1-m class Nano-ADEPT, the next step in ADEPT maturation is the focus on configurations that are capable of generating lift in order to accomplish aerocapture and precision landing mission capabilities. ADEPT is particularly attractive for evaluating various guidance and control approaches as the deployable structure enables attachment points for various actuation methods such as control surfaces, moving mass elements, or RCS thrusters. The Pterodactyl Project is utilizing a lifting Nano-ADEPT configuration to study the efficiency of guidance and control architectures for deployable entry vehicles [14].

References

- [1] Cassell, A. M., et al “Human Mars Mission Design Study Utilizing the Adaptive Deployable Entry and Placement Technology” *IEEE Aerospace Conference*, Big Sky, MT, March 2016.
- [2] Cassell, A. M., et al “ADEPT, a Mechanically Deployable Re-Entry Vehicle System, Enabling Interplanetary CubeSat and Small Satellite Missions” *SmallSat 2018*, Logan, UT, August 2018.
- [3] Smith, B. P., Cassell, A. M., Kruger, C. E., Venkatapathy, E., Kazemba, C. D., Simonis, K. R., “Nano-ADEPT: An Entry System for Secondary Payloads,” *IEEE Aerospace Conference*, Big Sky, MT, March 2015.
- [4] Wercinski, P. F. et al., “ADEPT Sounding Rocket One (SR-1) Flight Experiment Overview,” *IEEE Aerospace Conference*, Big Sky, MT, March 2016.
- [5] Bally Ribbon Mills, Inc <http://www.ballyribbon.com>
- [6] Thin Red Line Aerospace, Inc. <http://www.thin-red-line.com>
- [7] Affordable Vehicle Avionics (AVA) fact sheet: http://www.nasa.gov/sites/default/files/atoms/files/fs_ava_150604.pdf
- [8] Thurn, A., Huynh, S., Koss, S., Oppenheimer, P., Butcher, S., Schlater, J., Hagan, P. “A Nichrome Burn Wire Release Mechanism for CubeSats” Proceedings of the 41st Aerospace Mechanisms Symposium, Jet Propulsion Laboratory, May 16-18, 2012.
- [9] Smith, B.; et al “Nano-ADEPT Aeroloads Wind Tunnel Test” *IEEE Aerospace Conference*, 2016.
- [10] Cruz, J. R., Green, J. S., “Subsonic Dynamic Testing of a Subscale ADEPT Entry Vehicle,” *AIAA Aviation Conference*, Dallas, TX, 17-21 June 2019.
- [11] Korzun, A. M., Dutta, S., McDaniel, R. D., Karlgaard, C., Tynis, J. A., “Aerodynamics for the ADEPT SR-1 Flight Experiment,” *AIAA Aviation Conference*, Dallas, TX, 17-21 June 2019.
- [12] Tynis, J. A., Karlgaard, C., “Reconstruction of the Adaptable Deployable Entry and Placement Technology Sounding Rocket One Flight Test,” *AIAA Aviation Conference*, Dallas, TX, 17-21 June 2019.
- [13] Dutta, S., Green, J. S., “Flight Mechanics Modeling and Post Flight Analysis of ADEPT SR-1,” *AIAA Aviation Conference*, Dallas, TX, 17-21 June 2019.
- [14] D’Souza, S. D., Johnson, B. J., Okolo, W. A., Nikaido, B. E., Smith, B. P., “Pterodactyl: Developing a Design, Build and Test Capability for Non-propulsive Control Systems for Lifting Nano-ADEPT,” *AIAA Aviation Conference*, Dallas, TX, 17-21 June 2019.