

NASA TM-86867

DOE/NASA/20320-60  
NASA TM-86867

NASA-TM-86867

19850003150

# Aileron Controls for Wind Turbine Applications

Dean R. Miller and Richard L. Putoff  
National Aeronautics and Space Administration  
Lewis Research Center

**LIBRARY COPY**

1985 0003150

LANGLEY RESEARCH CENTER  
LIBRARY, NASA  
HAMPTON, VIRGINIA

Work performed for  
**U.S. DEPARTMENT OF ENERGY**  
**Conservation and Renewable Energy**  
**Wind Energy Technology Division**

Prepared for  
Intersociety Energy Conversion Engineering Conference  
San Francisco, California, August 19-24, 1984



NF00801

## DISCLAIMER

This report was prepared as an account of work sponsored by an agency of the United States Government. Neither the United States Government nor any agency thereof, nor any of their employees, makes any warranty, express or implied, or assumes any legal liability or responsibility for the accuracy, completeness, or usefulness of any information, apparatus, product, or process disclosed, or represents that its use would not infringe privately owned rights. Reference herein to any specific commercial product, process, or service by trade name, trademark, manufacturer, or otherwise, does not necessarily constitute or imply its endorsement, recommendation, or favoring by the United States Government or any agency thereof. The views and opinions of authors expressed herein do not necessarily state or reflect those of the United States Government or any agency thereof.

Printed in the United States of America

Available from

National Technical Information Service  
U S Department of Commerce  
5285 Port Royal Road  
Springfield, VA 22161

NTIS price codes<sup>1</sup>

Printed copy A02  
Microfiche copy A01

<sup>1</sup>Codes are used for pricing all publications. The code is determined by the number of pages in the publication. Information pertaining to the pricing codes can be found in the current issues of the following publications, which are generally available in most libraries: *Energy Research Abstracts (ERA)*, *Government Reports Announcements and Index (GRA and I)*, *Scientific and Technical Abstract Reports (STAR)*, and publication, NTIS-PR-360 available from NTIS at the above address.

DOE/NASA/20320-60  
NASA TM-86867

## **Aileron Controls for Wind Turbine Applications**

Dean R. Miller and Richard L. Putoff  
National Aeronautics and Space Administration  
Lewis Research Center  
Cleveland, Ohio 44135

Work performed for  
U.S. DEPARTMENT OF ENERGY  
Conservation and Renewable Energy  
Wind Energy Technology Division  
Washington, D.C 20545  
Under Interagency Agreement DE-AIO1-76ET20320

Prepared for  
Intersociety Energy Conversion Engineering Conference  
San Francisco, California, August 19-24, 1984

*N83-11458#*

## AILERON CONTROLS FOR WIND TURBINE APPLICATIONS

Dean R. Miller and Richard L. Puthoff  
National Aeronautics and Space Administration  
Lewis Research Center  
Cleveland, Ohio 44135

### SUMMARY

Horizontal-axis wind turbines utilize partial or full variable blade pitch to regulate rotor speed. The weight and costs of these systems indicated a need for alternate methods of rotor control. Aileron-control is an alternative which has potential to meet this need. The NASA Lewis Research Center has been experimentally testing aileron-control rotors on the Mod-0 wind turbine to determine their power regulation and shutdown characteristics. This paper presents experimental test results for a 20 and 38 percent chord aileron-control rotor. The test results to date show that aileron-control is a viable method for safely controlling rotor speed, following a loss of generator load.

### INTRODUCTION

As part of the DOE Wind Energy Program, the NASA Lewis Research Center (LeRC) has been involved in the research of large horizontal-axis wind turbines since 1975. The overall goal of the effort has been to develop the technology to build reliable, yet cost-effective large HAWTS. Since the rotor constitutes a large portion of the overall wind turbine cost, various methods of rotor control were investigated based on their potential to reduce rotor weight and cost.

Aileron-control was a method of rotor control which appeared to have potential for reducing rotor costs. This method of rotor control involved placing a control surface on the trailing-edge of the rotor blade (in the same way control surfaces are placed on the trailing-edges of aircraft wings). As with the airplane wing, the ailerons change the lift and drag characteristics of the basic airfoil as a function of their deflection angle, producing corresponding changes in rotor torque. It is these changes in rotor torque which enable the ailerons to regulate rotor speed or rotor power output.

The primary advantages of aileron-control over partial-span control are that a smaller pitch actuator system is required and the actuator system can be located so as not to interrupt the structure of the blade spar. The net result is a lighter weight, less complicated actuator system than that used for partial-span control.

To investigate the applicability of aileron-control to large horizontal-axis wind turbines a feasibility study was performed by Wichita State University (ref. 1). Based on this study, two outboard blade tip sections with 20 percent chord ailerons were designed and fabricated for testing on the Mod-0 100 kW wind turbine. These tips were installed on existing inboard blades to form an aileron-control rotor. Loss of load shutdown tests and no-load equilibrium rpm tests were conducted and the results indicated that the 20 percent chord ailerons did not provide enough aerodynamic braking capability.

Therefore, two blade tip sections were designed with 38 percent chord ailerons and fabricated for testing on the Mod-0. These 38 percent chord aileron-control tips were also installed and tested on the Mod-0. Test results with this rotor showed much improved aerodynamic braking characteristics, when compared to the 20 percent chord aileron-control rotor.

This paper will briefly explain the theoretical basis for using aileron-control to provide aerodynamic braking. Then the loss of load shutdown tests conducted on the Mod-0 100 kW wind turbine will be described for the 20 and 38 percent aileron-control rotors. A typical rotor speed time history will be shown for a loss of load shutdown with the 38 percent chord aileron-control rotor. Finally, results of no-load equilibrium rpm tests conducted on the Mod-0 will be compared for the 20 and 38 percent chord aileron-control rotors.

### AILERON-CONTROL THEORY

The ability of an aileron to change the lift and drag characteristics of a basic airfoil section is the key to the use of aileron-control for aerodynamic braking on wind turbine rotors. As the aileron deflection is varied, the lift and drag forces acting on the rotor are correspondingly changed.

Figure 1 shows the relationship between the lift and drag forces and the relative wind vector ( $V_r$ ). The relative wind vector is the resultant of the rotational vector ( $\omega R$ ) and the wind vector ( $V$ ). The angle between the resultant wind ( $V_r$ ) and the section chord line is the angle of attack ( $\alpha$ ). Traditionally, the lift and drag forces ( $L$  and  $D$ ), acting on an airfoil have been nondimensionalized and expressed as lift and drag coefficients ( $C_L$  and  $C_D$ ). These coefficients provide a more generalized way of expressing the lift and drag variations as a function of angle of attack. The equations used to derive  $C_L$  and  $C_D$  from the lift and drag forces are also presented.

A second set of coefficients can be defined to describe the forces acting on the basic section. These are the flapwise force coefficient ( $C_N$ ) and the chordwise force coefficient ( $C_C$ ). For a wind turbine blade section with zero twist and zero pitch, only the chordwise force ( $C$ ) produces torque. Therefore, the chordwise force coefficient is a measure of the aerodynamic braking ability of an aileron-control system. These coefficients are shown in figure 1.

The airfoil cross-section shown in figure 1 is a 64-series airfoil with a 38 percent chord aileron deflected at the maximum braking angle of  $-90^\circ$ . For this aileron deflection,  $C_L$  and  $C_D$  were determined as a function of angle of attack from wind tunnel tests. These values were then converted to a chordwise force coefficient ( $C_C$ ), which is shown plotted versus angle of attack in figure 2.

The portion of figure 2 where  $C_C$  is negative indicates an angle of attack range for which a negative (decelerating) torque will be produced by this aileron-control section. Conversely, where  $C_C$  is positive, there will be a positive torque produced. It is desirable to have a negative value of  $C_C$  from  $0^\circ$  to  $90^\circ$  angle of attack.

As shown in figure 2,  $C_C$  does become positive from  $\alpha = 33^\circ$  to  $\alpha = 48^\circ$ . The point at which the  $C_C$  curve crosses zero can be used to estimate the no load equilibrium tip speed ratio for a wind turbine with this aileron-control

section over its entire span. The no-load tip speed ratio is useful in determining the rpm such a rotor would "freewheel" at, for a given windspeed, should there be a loss of generator load.

The tip speed ratio is defined as the speed of the blade tip ( $\omega R$ ) divided by the windspeed ( $V$ ). For a fixed windspeed, it follows that lowering the value of the no-load equilibrium tip speed ( $\omega R$ ) will in turn reduce the equilibrium tip speed ratio. Thus, the more effective an aileron-control system is, the lower will be its no-load equilibrium tip speed ratio.

Point A of figure 2 is of particular interest because it represents a stable equilibrium condition and can be used to estimate a no-load equilibrium tip speed ratio for a rotor with a 38 percent chord aileron deflected at  $-90^\circ$ . If the rotor were "freewheeling" at a condition represented by point B on the  $C_c$  curve, the negative value of  $C_c$  suggests the rotor would decelerate, thus increasing the angle of attack. This, in turn, would move the value of  $C_c$  toward point A. Alternately, if the rotor were "freewheeling" at a condition indicated by point C, the positive value of  $C_c$  suggests the rotor would tend to accelerate. This would effectively decrease the angle of attack and again move the value of  $C_c$  toward point A. Therefore, point A represents an equilibrium condition.

For a rotor with a 38 percent chord aileron over its entire span deflected to  $-90^\circ$ , the no-load equilibrium tip speed ratio can be estimated from the angle of attack value corresponding to point A. The cotangent of this angle will yield an approximate no-load equilibrium tip speed ratio, as shown below:

$$\lambda = \text{blade tip speed/windspeed} = \omega R/V$$

but

$$\text{TAN}(\alpha) = V/\omega R$$

thus

$$\lambda = 1/\text{TAN}(\alpha) = \text{COT}(\alpha)$$

For the conditions corresponding to point A in figure 2 the estimated equilibrium tip speed ratio would be expressed by:  $\lambda = \text{COT}(33^\circ) = 1.53$ . Actual experimental results obtained on the Mod-0 wind turbine with a 38 percent chord aileron over the outer third of the blade span and a  $-90^\circ$  deflection angle showed an equilibrium tip speed ratio of 1.95.

The apparent discrepancy emphasizes that the above analytical procedure for estimating no-load equilibrium tip speed ratios is approximate. This is because the actual equilibrium tip speed ratio for an aileron-control rotor will depend on the integrated effect of not only the aileron-control sections, but the other blade sections without ailerons as well. Still, the above method is useful as a first approximation.

#### DESCRIPTION OF LOSS OF LOAD SHUTDOWN TESTS

Shutdown tests were conducted on the Mod-0 100 kW wind turbine located at Plum Brook Station, Sandusky, Ohio. Figure 3 shows the Mod-0 which operated downwind of the tower with a teetered hub.

The nacelle was located atop a tubular tower with the rotor axis 38 m above the ground.

Shutdown characteristics of a 20 percent chord aileron-control rotor and a 38 percent chord aileron-control rotor were investigated. Both rotors had the same inboard section, but differed in the aileron-control tip section. A plan-form view, typical of both rotors, is shown in figure 4. The inboard part of the rotor was an untwisted blade fixed in pitch at 0°. It had a NACA 23024 airfoil over its entire length. The aileron-control tip sections were assembled to the inboard blades. The 20 and 38 percent chord aileron-control tips are shown in figure 5. Their differences are summarized as follows:

1. Aileron chord length is 20 percent of blade chord versus 38 percent of blade chord,
2. Maximum aileron deflection angle is -60° for the 20 percent chord aileron versus -90° for the 38 percent chord aileron,
3. Aileron airfoil section is NACA 23024 for the 20 percent chord aileron versus NACA 64 series for the 38 percent chord aileron.

The aerodynamic braking tests conducted on the 20 and 38 percent chord aileron control rotors were (1) rotor overspeed following loss of load, and (2) no-load equilibrium rotor speed. The relationship between these two tests is illustrated in figure 6, which is a rotor speed time history for a hypothetical loss of load shutdown. The shutdown has been divided into a rotor overspeed test and a no-load equilibrium rpm test.

The rotor overspeed test defines the time period immediately following a loss of generator load. It is during this time period after the load is removed and before the ailerons are completely deflected that the rotor may experience large accelerations, thus producing an overspeed and possible damage to the drive train and rotor. Therefore, it is important for the aileron-control system to either prevent an overspeed or limit the peak rpm to a safe value.

The no-load equilibrium test is characterized by the rotor reaching a stable or equilibrium rpm. This can be seen in figure 6 as the portion of the rotor speed time history where the curve parallels the abscissa. Since figure 6 assumes a constant windspeed, the rotor speed would remain constant. However, should the windspeed change to another fixed value, the rotor speed would reach a new equilibrium rotor speed.

#### SHUTDOWN TEST RESULTS

Overspeed test results showed that both the 20 and 38 percent chord aileron-control tips did provide overspeed protection. However, the 20 percent chord aileron-control tips only did so over a small portion of the Mod-0's operational windspeed range of 4 to 18 mps. The 38 percent chord aileron-control tips appeared to provide overspeed protection over the entire operational windspeed range.

The 38 percent chord aileron-control tips limited the peak overspeed to less than 20 percent of the nominal operating rotor speed during the 31 overspeed tests. These tests were run in windspeeds from 4 to 12 mps and in all

cases the peak overspeed was less than 24 rpm (where 20 rpm = nominal rotor speed). Many of the overspeed tests were conducted near the Mod-0's rated power output of 100 kW, which is the most severe loss of load test.

For the windspeed range of 13 to 18 mps, no experimental overspeed test results were available, therefore the Mod-0 Emergency Shutdown Model (ref. 2) was used to predict the peak overspeed in this windspeed regime. These predictions indicated that for a windspeed of 18 mps the 38 percent chord aileron-control tips should limit the peak overspeed to less than 26 rpm (30 percent overspeed).

Figure 7 is a typical rotor speed time history obtained from an overspeed test of the 38 percent chord aileron-control rotor. The average windspeed was 10 mps and the generator power was 100 kW. The peak overspeed rpm was about 22.5 rpm, representing an increase of only 1.8 rpm above the initial rotor speed of 20.7 rpm. Also, within 10 sec the rotor speed had been reduced to about 12 rpm. These two trends (small overspeed and rapid reduction in rotor speed) were typical of the 38 percent chord aileron-control overspeed tests. They were attributable to the high aileron deflection rates of 20°/sec which are attainable with an aileron-control system. This allowed the ailerons to reach their maximum deflection (hence their maximum braking capability) quickly.

No-load equilibrium test results for the 38 percent chord aileron-control rotor indicated marked improvement, when compared with the 20 percent chord aileron-control test results. Figure 8 is a plot of no-load equilibrium rpm versus windspeed, for the 20 and 38 percent chord aileron-control rotors. Both curves B and C for the 38 percent chord aileron have lower equilibrium rotor speeds, than curve A for the 20 percent chord aileron. Curve A corresponds to an equilibrium tip speed ratio of about 5.5, while curves B and C represent equilibrium tip speed ratios of 2.5 and 1.9, respectively. Thus, the 38 percent chord ailerons were much better aerodynamic brakes than the 20 percent chord ailerons.

## CONCLUSIONS

The test results to date show that aileron-control is a viable method for safely controlling rotor speed following a loss of generator load. Other conclusions are:

1. The analytical procedure for estimating no-load equilibrium tip speed rotors is useful as a first approximation.
2. The 20 percent chord aileron-control tips provided adequate rotor overspeed protection only for a small portion of the Mod-0's operational windspeed range.
3. The 38 percent chord aileron-control tips should provide rotor overspeed protection over the entire Mod-0 operational windspeed range (4 to 18 mps).
4. An equilibrium tip speed ratio of 1.9 is achievable with a 38 percent chord aileron.



## REFERENCES

1. Wentz, William H. Jr.; Snyder, Melvin H.; and Calhoun, John T.: Feasibility Study of Aileron and Spoiler Control Systems for Large Horizontal Axis Wind Turbines. NASA CR-159856, 1980.
2. Miller, D. R.; and Ensworth, C. B.: Analytical Model for Predicting Emergency Shutdown of a Two-Bladed Horizontal-Axis Wind Turbine. NASA TM-83472, 1983.
3. Snyder, Melvin H.; and Staples, David L.: Wind-II Users Manual. WER-15, Wichita State University, July 1982.
4. Viterna, L. A.; and Janetzke, D. C.: Theoretical and Experimental Power from Large Horizontal-Axis Wind Turbines, NASA TM 82944, 1982.

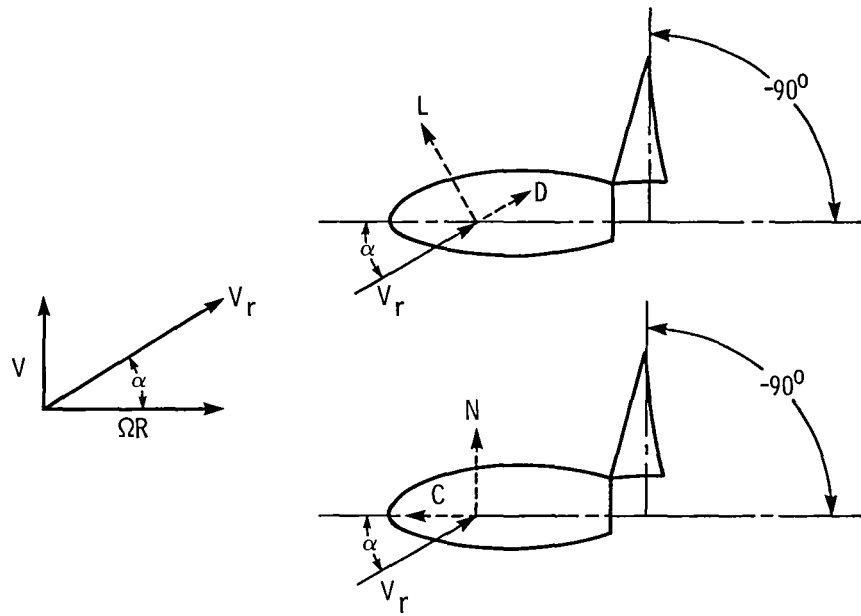

LIFT FORCE COEFFICIENT :  $C_l = L / (\rho v^2 s / 2)$   
 DRAG FORCE COEFFICIENT :  $C_d = D / (\rho v^2 s / 2)$   
 CHORDWISE FORCE COEFFICIENT :  $C_c = C_l \sin (\alpha) - C_d \cos (\alpha)$   
 FLAPWISE FORCE COEFFICIENT :  $C_n = C_l \cos (\alpha) + C_d \sin (\alpha)$

Figure 1. - Aerodynamic force coefficients.

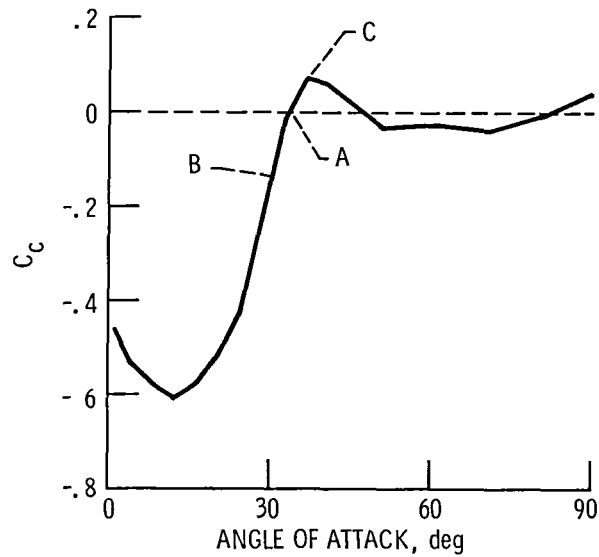

Figure 2. - Chordwise force coefficient,  $C_c$ .

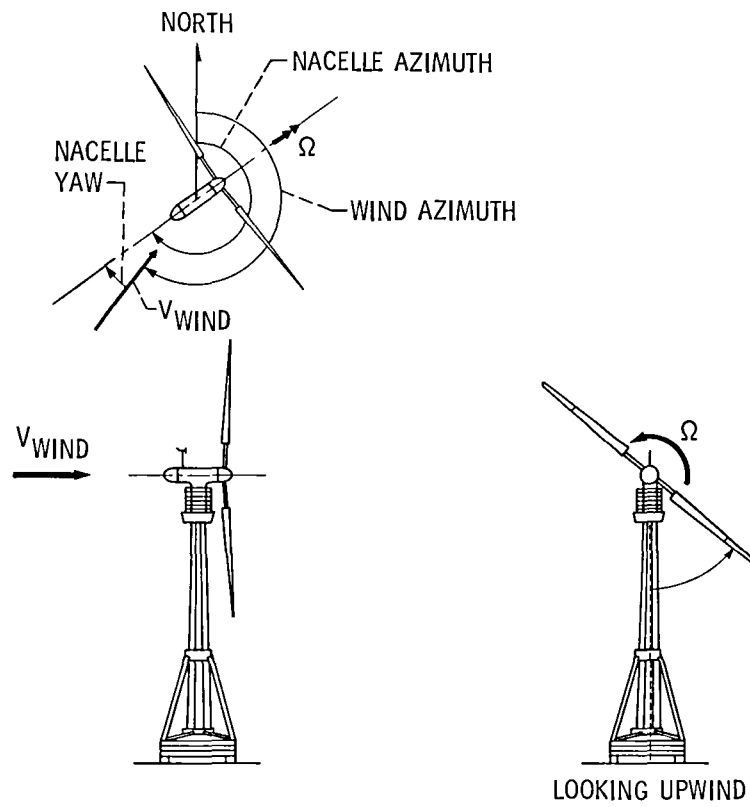

Figure 3. - Mod-0 wind turbine.

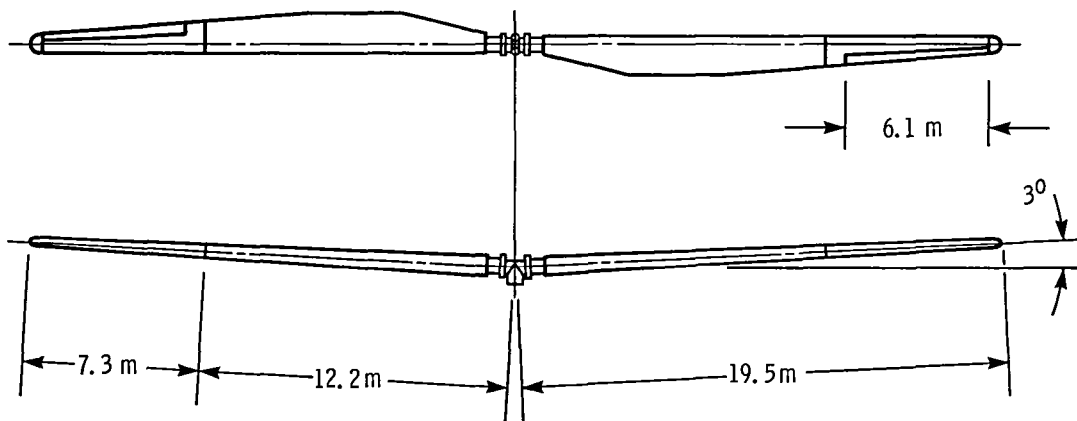

Figure 4. - Aileron-control rotor planform.

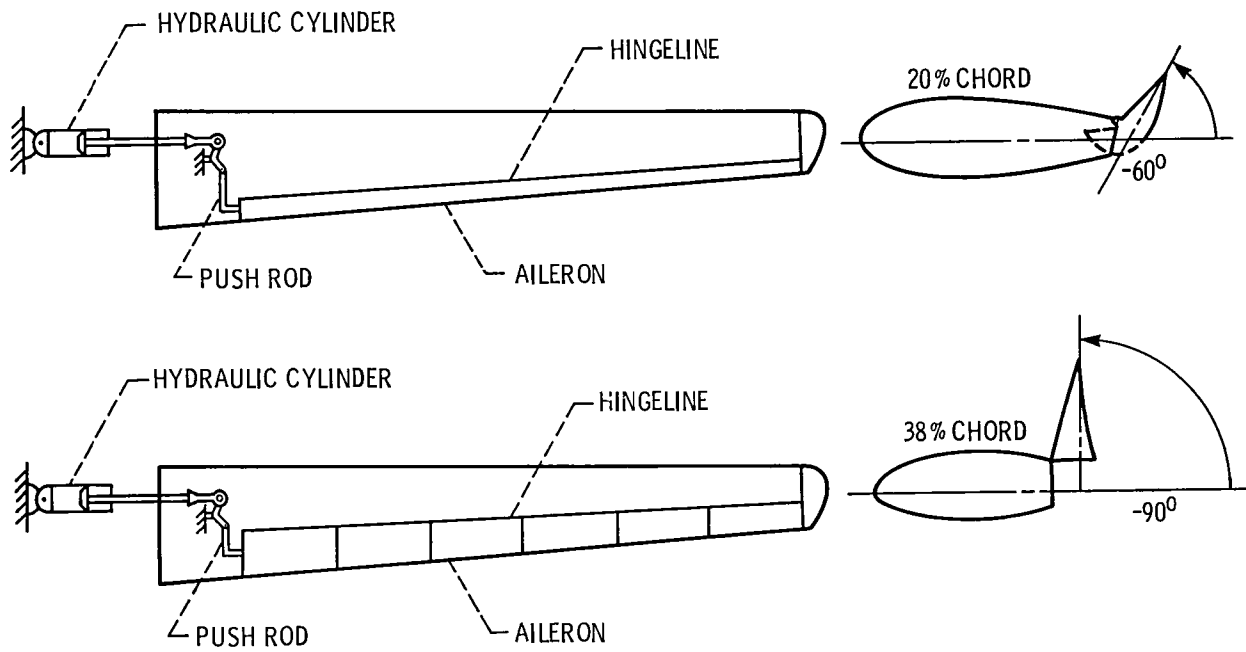

Figure 5. - 20% and 38% chord aileron-control blade tips.

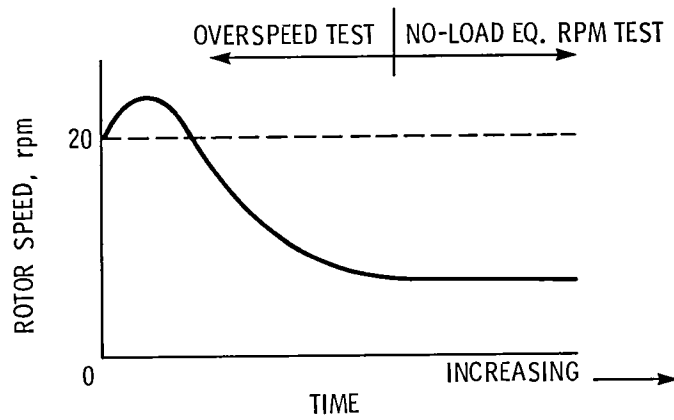

Figure 6. - Aileron-control shutdown tests.

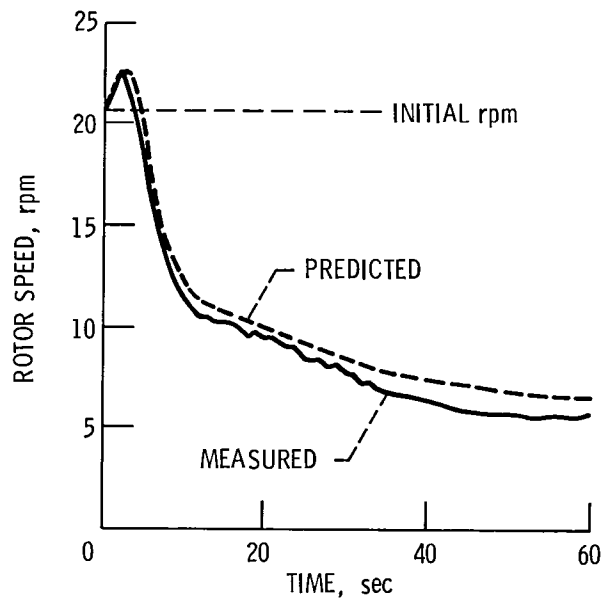

Figure 7. - Loss of load overspeed for 38% chord aileron-control rotor.

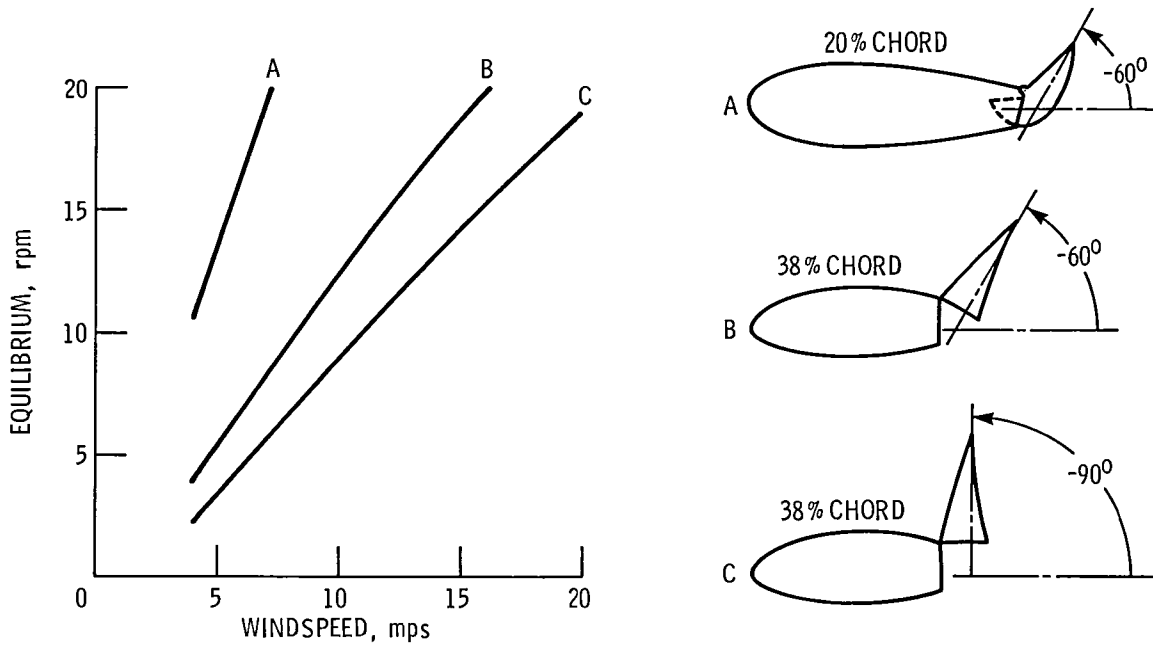

Figure 8. - No load equilibrium rotor speed for the 20% and 38% chord aileron control rotors.

1. Report No NASA TM-86867		2. Government Accession No		3. Recipient's Catalog No	
4. Title and Subtitle  Aileron Controls for Wind Turbine Applications				5. Report Date November 1984	
				6. Performing Organization Code 776-33-41	
7. Author(s)  Dean R. Miller and Richard L. Puthoff				8. Performing Organization Report No E-2330	
				10. Work Unit No	
9. Performing Organization Name and Address National Aeronautics and Space Administration Lewis Research Center Cleveland, Ohio 44135				11. Contract or Grant No	
				13. Type of Report and Period Covered Technical Memorandum	
12. Sponsoring Agency Name and Address U.S. Department of Energy Wind Energy Technology Division Washington, D.C. 20545				14. Sponsoring Agency <del>Code</del> Report No. DOE/NASA/20320-60	
15. Supplementary Notes Prepared under Interagency Agreement DE-AI01-76ET20320. Prepared for Intersociety Energy Conversion Engineering Conference, San Francisco, California, August 19-24, 1984.					
16. Abstract Horizontal-axis wind turbines utilize partial or full variable blade pitch to regulate rotor speed. The weight and costs of these systems indicated a need for alternate methods of rotor control. Aileron-control is an alternative which has potential to meet this need. The NASA Lewis Research Center has been experimentally testing aileron-control rotors on the Mod-0 wind turbine to determine their power regulation and shutdown characteristics. This paper presents experimental test results for a 20 and 38 percent chord aileron-control rotor. The test results to date show that aileron-control is a viable method for safely controlling rotor speed, following a loss of generator load.					
17. Key Words (Suggested by Author(s)) Wind turbine Wind turbine rotor control Wind turbine with aileron-control rotor			18. Distribution Statement Unclassified - unlimited STAR Category 44 DOE Category UC-60		
19. Security Classif (of this report) Unclassified		20. Security Classif (of this page) Unclassified		21. No of pages	22. Price* A02

**End of Document**