



# An Analytical Survey of the Islanding Detection Techniques of Distributed Generation Systems

Suman Khichar<sup>1</sup> · Mahendra Lalwani<sup>1</sup>

Received: 4 February 2017 / Accepted: 18 March 2018 / Published online: 23 July 2018  
© Springer Nature Singapore Pte Ltd. 2018

## Abstract

This paper provides an analytical survey of the islanding detection techniques for the distributed generation systems. Islanding phenomena on takes place when the power supply from the main utility is intermittent due to numerous reasons, but the distributed generation keeps supplying power into the distribution networks. Islanding can be dangerous to workers and electrical equipment, even the power grid. Therefore, islanding detection is the priority among priorities. Islanding detection is a precondition of two working modes switching for distributed generation. In this paper, a detailed description followed by the classification of the islanding detection techniques has been made based on features, such as detection time, size of non-detection zone, power quality disturbances, system cost and operation under multiple distributed generation units. The merits and demerits of islanding detection methods are analyzed and summarized in this paper. In this manner, the greatest detection outcome can be achieved by exploiting the merits of each method. This paper is aimed to serve as a convenient reference and guidance value for deciding the islanding detection method for future islanding users in distributed generation system.

**Keywords** Distributed generation · Point of common coupling · Islanding detection

## Nomenclature

DG	Distributed generation	$V_{NS}$	Negative sequence voltage of the DG terminal voltage
UI	Unintentional islanding	$Cf$	Chopping fraction
EPS	Electric power system	$t_z$	Dead time
PCC	Point of common coupling	$T_{Vutil}$	Time period for one cycle in the utility voltage
NDZ	Non-detection zone	$K$	Accelerating gain
PLL	Phase lock loop	$f_{PCC}$	Measured frequency of PCC
IDMs	Islanding detection methods	$f_{grid}$	Line frequency
VU	Voltage unbalance	$cf_0$	Chopping fraction where there is no frequency error
$P_{inv}$	Inverter active power	$cf_k$	Chopping fraction of the previous cycle
$Q_{inv}$	Inverter reactive power	$f_m$	Maximum frequency
$\Delta P$	PCC active power	$\theta_m$	Maximum phase shift occurring at frequency $f_m$
$\Delta Q$	PCC reactive power	$f_n$	Rated frequency
$V_{PS}$	Positive sequence voltage of the DG terminal voltage	$f^{k-1}$	Frequency at the previous cycle
		SCADA	Supervisory control and data acquisition

✉ Mahendra Lalwani  
mlalwani.ee@gmail.com

Suman Khichar  
sumankhichar0@gmail.com

<sup>1</sup> Department of Electrical Engineering, Rajasthan Technical University, Kota, Rajasthan, India

## Introduction

Distributed generation (DG) technology is increasing day by day because of the rapid development in the world and as scientific, technological progress and economic development, people on the environment demand. The development and utilization of new energy has been continuously developing [1–3].

Distributed generation technology is not only clean, environmental protective, economic and efficient, but also can look up the stability and flexibility of the whole power system. In recent years, distributed generation technologies have developed rapidly, and that implement the parallel operation. Distributed generation technology in power system not only improves the reliability and flexibility of the power, but also brings some new challenges at the same time, an islanding effect is one of them [4–7].

Islanding refers to when the power company or power supply enterprises cannot control range, due to power failure of grid-connected power generation system and the load to form a self-contained power that supply electric power company. The self-sufficiency of islanding phenomenon can make severe effects to repair personnel and electrical apparatus even the power grid. So the distributed generation system needs to be able to suitably detect the occurrence of islanding [7, 26]. At present, the islanding detection methods include local detection and remote detection technology. Local detection technologies include active technology and passive technology. Figure 1 broadly classifies anti-islanding techniques. The local techniques are based on the measurement of parameters at the local DG terminal and are generally preferred. These techniques are further classified into the passive, active and hybrid techniques. The remote techniques are based on communication between the grid and the DG, and are very expensive. Utility-interactive PV inverter islanding might occur as an outcome of the follow circumstances [7, 8, 12, 28]:

- Power grid terminates in repair and leads in the direction of the power engrave of the entire power grid, but throw put on the brake switch is at a standstill associated to power network, subsequently, PV organism has the prospect to carry on to work for a numeral of times.
- Power distribution scheme breaks, after that toward a situation or switch trips, which resolves beginning PV organism and its load toward structure an incorporated system supplying power through it.

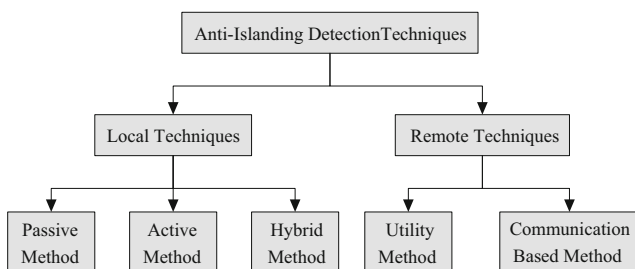

Fig. 1 The categorization of anti-islanding techniques

- Switch outing of the PV scheme breaks alone or inside accident, but grid-coupled coordination and its load activate in island appearance.

Primary flow chart for islanding process is exposed in Fig. 2. The flow chart for islanding detection principle describes process and each step for islanding detection technology. Although, there are several rewards of during service structure within island approach, further, there are many drawbacks of it. Several of them are the same as follows [9, 10]:

- *Safety awareness:* Safety is the major awareness, at the identical time as the grid may at a standstill be powered, in the end result of a power outage suitable to electricity entire by distributing generators. This may confuse the utility employees and describe them to hazards such seeing that shocks.
- *Customer’s appliances harm:* Suitable for islanding and distributed production there may a bi-directional flow of electricity. This may become a basis to severe harm to electrical apparatus, appliances and devices. Some devices are additionally responsive to voltage variance than others and should for all time be prepared with surge protections.
- *Harm to inverter:* In the case of bulky solar systems, several inverters are installed throughout the distributed generators. Islanding may possibly cause tribulations within proper carrying out of the inverters.

Two key features are to be defined for better understanding of islanding phenomena namely non-detection zone (NDZ) and quality factor (Q) [10, 11]. These two are extensively used as the criteria to evaluate the islanding detection methods.

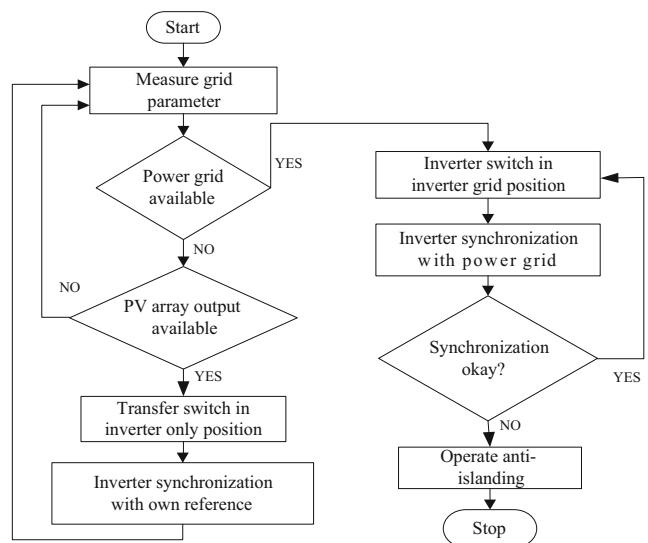

Fig. 2 Flow chart describing the process of basic islanding operation

Non-detection zone (NDZ) is the interval of failure in detecting the island by DG once islanding has occurred. This region relates the power mismatched between the DG and local load. There NDZ is considered as an evaluation index for islanding detection methods. Quality factor is defined as  $2\pi$  times the ratio of maximum storage energy to energy dissipated per cycle at a given frequency. Q factor is proportional to NDZ and therefore NDZ should be as small as possible. The description of this paper classified in following section: “[Islanding Detection Techniques](#)” provides classification of the islanding detection techniques. Section “[Merits and Demerits of Islanding Detection Techniques](#)” describes merits and demerits of passive, active and remote islanding detection techniques. Comparison of various islanding detection methods based on detection time, size of non-detection zone, power quality disturbances, system cost and operation under multiple distributed generation units are described in “[Comparison of Various Islanding Detection Methods](#)”. Overall conclusion of this work is presented in “[Conclusion](#)”.

## Islanding Detection Techniques

### Local Techniques

#### Passive Islanding Detection Techniques

Passive methods observe parameters such as variations in the voltage, frequency, harmonic distortion, power, phase angle *etc.* used to identify the islanding condition. When island occurs, enormous variation in these parameters can be observed [13, 31]. To discriminate islanding condition from the other disturbances, unique care must be taken while setting threshold values. Figure 3 shows the basic process of passive islanding detection procedure. Excessive care should be taken while setting the value of threshold in order to discriminate islanding operation from other disturbances in the controlled system. In general, passive detection techniques are fast and create no disturbance in the system; however it has a large NDZ which could fail the islanding detection [14, 49].

**Under/Over Voltage Protection (UVP/OVP) and Under/Over Frequency Protection (UFP/OFP)** In this technique, when islanding occurs, the DG stops supplying power to the utility grid if the frequency or amplitude of the voltage at the point of common coupling (PCC) crosses their threshold confines and that deviation in the parameters is used to identify islanding condition. Just the once islanding location has been detected; the DG must cease its operation [15]. The power flow in a PV grid connected system is accessible in Fig. 4, which the node PCC is the point of common coupling between the utility grid and power conditioning unit.

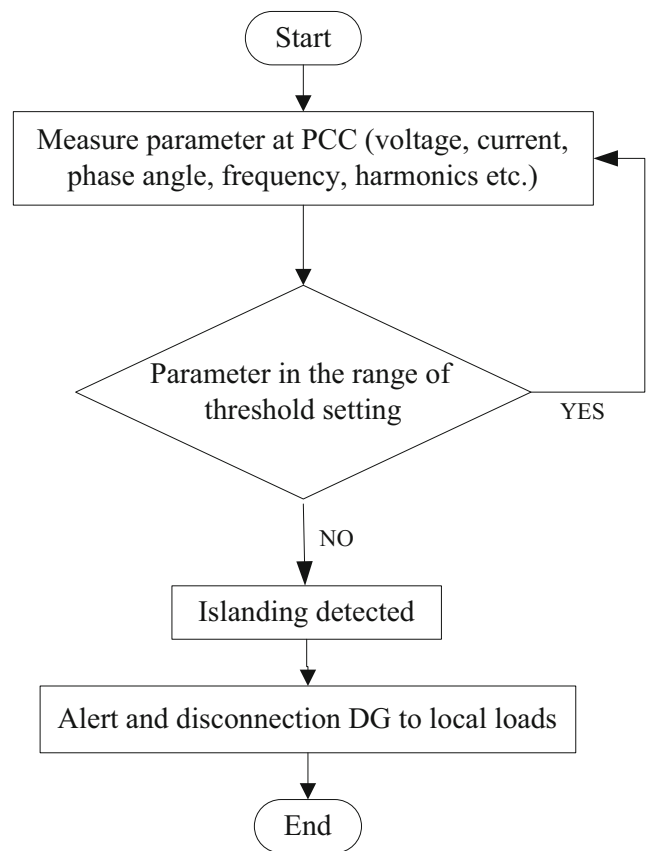

Fig. 3 Flow chart describing the process of passive islanding detection procedure

During islanding mode of operation, the control system should be able to maintain the active power demand for the local load equivalent to the power generated by PV at the moment when the utility circuit breaker is opened. In case the power generated by PV,  $P_{PV}$  is less than the load power,  $P_{Load}$  the voltage at PCC has to be increased to achieve equivalent input and output power and vice-versa. Similarly, if the reactive power of local load does not match the reactive power generated from PV, the frequency at

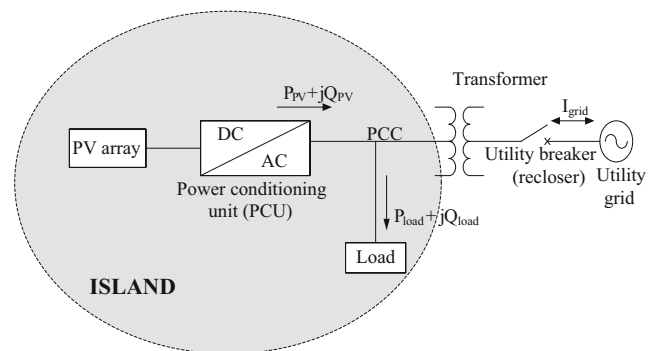

Fig. 4 Operation of power flow in Grid connected photovoltaic system-Islanded operating mode

the PCC has to be controlled to make both reactive power equivalents.

At the PCC,

$$\Delta P = P_{Load} - P_{inv} \ \& \ \Delta Q = Q_{Load} - Q_{inv}$$

The value of  $\Delta P$  and  $\Delta Q$  resolve of the presentation of the system when DG is detached from the utility grid. However, this method has, particularly in the case when  $\Delta P$  and  $\Delta Q$  are near to zero [15, 16].

**Phase Jump Detection (PJD)** The island is detected if the phase angle deviation exceeds a predefined threshold. The PJD technique searches for a swift revolutionize in phase angle to detect islanding as shown in Fig. 5. This method has a straight forward implementation because only modify the phase locked loop (PLL) obligatory by the inverters for utility synchronization is needed [42]. The swift alteration in the phase angle is the key to identify islanding in PJD. The PLL is used to synchronize the inverter output current and the grid voltage during ordinary operation. When the phase errors go beyond a preset value, the inverter is discontinued from its process.

**Detection of Voltage Unbalance (VU) and Total Harmonics Distortion (THD)** A normal grid has the characteristic of low impedance which enables it to acquire and supply power to additional devices connected to it. Even though compensation and control algorithms are embedded into the power system, the voltage harmonics will be present in low magnitude rewarding the standards of harmonic distortion ( $THD < 5\%$ ). When islanding occurs the grid is disconnected from the inverter module and the local load is immediately connected with the inverter. Since the local load has superior impedance compared with the grid, harmonic levels are also high which can be made as indicated for the islanding detection. This method suffers from a misinterpretation of an islanding event due to changes in the harmonic conditions triggered by sudden removal or addition of non-linear loads to the systems. This constraint of THD based

detection technique leads to use voltage unbalance as an islanding detection parameter in combination with THD [18].

$$VU \text{ (Voltage Unbalance)} = \frac{V_{NS}}{V_{PS}} \tag{1}$$

$V_{PS}$  and  $V_{NS}$  are the positive and negative sequence voltages of the DG terminal voltage. When island occurs, adjust in the topology of the power system results in changes in VU, even for the petite amount of power mismatch. Therefore, the VU parameter along with the THD parameter is used to detect islanding condition.

**Rate of Change of Frequency  $df/dt$**  This method calculates  $df/dt$  and monitors the voltage waveform at PCC. Huge value of  $df/dt$  can be experienced during islanding. The threshold limits must be elected such that the scheme can distinguish between the island and the ordinary load modify the condition. The threshold setting for this method is 0.1-1.2 Hz/s. This method may bring to a standstill working to detect islanding condition when there is small, power variance between DG's ability and local load [19].

**Rate of Change of Power  $dp/dt$**  During islanding,  $dp/dt$  during normal grid connected condition is much smaller than the  $dp/dt$  for the same rate of load change. This method is much effective for unbalance load  $dp/dt$  during normal grid connected condition to a certain extent than balanced load [20].

**Rate of Change of Frequency over Power  $df/dp$**  In this method  $df/dp$  is measure parameter to identify islanding. For petite power generation capacity system  $df/dp$  is bigger than that of system with superior power generation capability. For small power variance between DG's capacity and local load  $df/dp$  is much more perceptive than  $df/dt$  to detect island [21].

**Active Islanding Detection Techniques**

The active islanding detection method is based on the insertion of a small interruption signal to define parameters at the PCC [30]. Figure 6 describes the basic operation of power flow in active islanding detection procedure. The concept of this method is that small interruption signal will become considerable upon entering the islanding mode of operation in order to help the inverter to swing the power change. Hence, the values of system parameter will be unreliable during the cessation of power conversion, and by measuring the consequent system parameters, islanding condition can detect [22]. However, this method requires additional control circuits to create adequate disturbances, which increase the complexity for

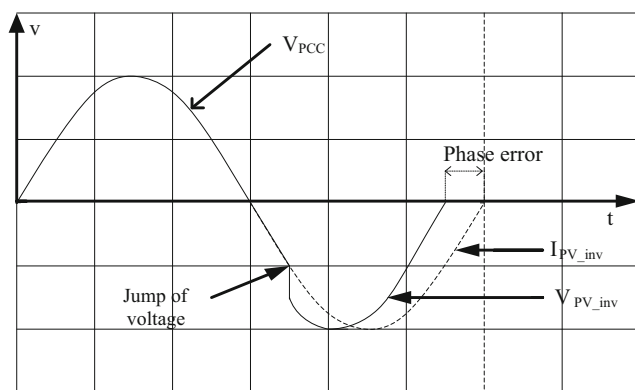
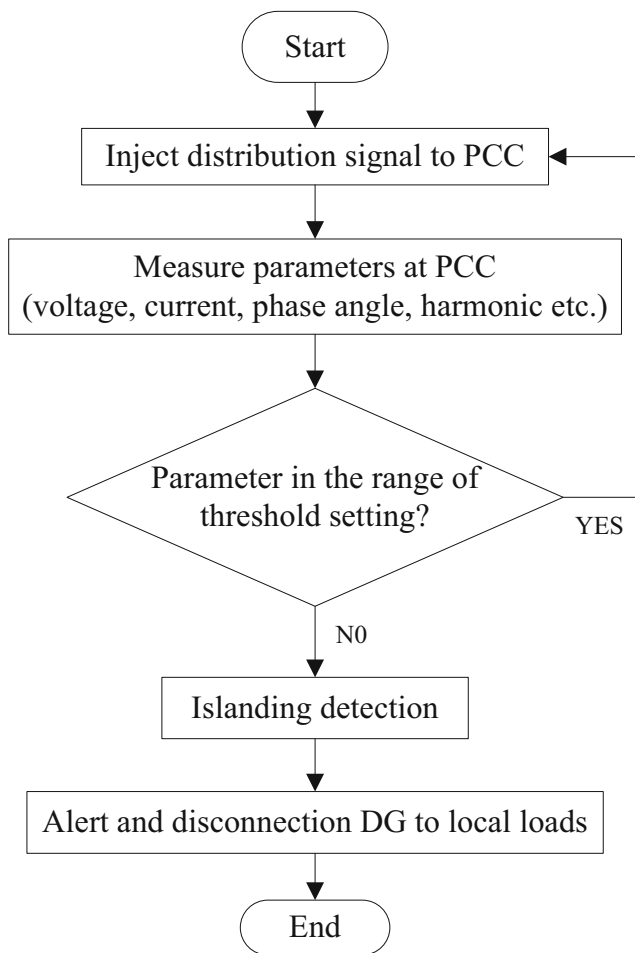

Fig. 5 The operation of phase-jump detection



**Fig. 6** Flow chart describing the process of active islanding detection procedure

implementation. Nevertheless, an additional circuit may cause unpredicted effects to the electric power quality, such as the deterioration of the grid voltage quality and system instability [30].

**Frequency Bias or Active Frequency Drift (AFD) Method** In this method, when islanding occurs, the frequency at the PCC will drift positive or negative. Due to the constancy of the grid, the voltage and frequency at the PCC will not modify [27, 28, 41]. In the occurrence of an islanding taking place, the utility grid is detached and the local load is associated to the inverter output. If the associated load is purely resistive in nature, then the voltage reaction of this load is same as that of the current waveform, which is unclear. The inverter, on the other hand, detects this phase lag and indulges in a drift in frequency in its current reaction to create the phase lag to zero. DG operated grid associated inverters are designed to operate at unity power factor and hence the drift occurs. If the drift in frequency exceeds the threshold value set by the Under/Over frequency relays, islanding is detected. The major parameter relating the

distortion of the inverter injected current is the chopping fraction ( $cf$ ), given by the following equation.

$$cf = \frac{2t_z}{T_{V_{util}}} \tag{2}$$

where  $t_z$  is the dead time and  $T_{V_{util}}$  is the time period for one cycle in the utility voltage.

**Sandia Frequency Shift (SFS)** SFS method is an innovative method enhanced from Active Frequency Drift (AFD) [29]. SFS using positive feedback by creating to some extent uneven phase angle at inverter output current through adding up truncations or dead times to the current waveform [23, 25]. The chopping fraction ( $cf$ ) expressed in Eq. (3) is resolute to be a function of error in the grid frequency.

$$cf = cf_0 + K (f_{PCC} + f_{grid}) \tag{3}$$

where  $cf_0$  is the chopping portion when there is no frequency error,  $K$  is accelerating gain,  $f_{PCC}$  is the measured frequency of PCC, and  $f_{grid}$  is the line frequency. When the utility grid is associated, a slight change in frequency due to load variation does not influence the strong grid. But when the utility is detached, frequency at PCC increases the frequency error. The  $cf$  increases, which results in modifying in frequency of the inverter. This  $cf$  increases due to positive feedback till it reaches a threshold situation for OFP and islanding is detected [25].

**Sandia Voltage Shift (SVS)** In this technique, when the utility grid is coupled, there will be very small or no cause of the power of the system. But once the utility is detached, there is turn down in  $V_{PCC}$ . According to the load impedance's correlation, thus lessening will continue and as a result, current and power output reduces. Therefore, this drop in amplitude of  $V_{PCC}$  can be detected by UVP. It is possible, moreover to raise or condense the power output of the inverter, most important, to corresponding OVP/UVP to trip and discontinue inverter operation [24].

**Active frequency drift with positive feedback (AFDPF)** The AFDPF is a calibration method of the AFD (Zhang Xiaoli-et-al:2012) to prevail over the drawbacks suffered by it in suitcases of multi inverter utility and loads with a large significance of L and C. The AFDPF uses a positive gain feedback which is the underlying of this method. This positive feedback increases the chopping fraction which leads to recognition of frequency deviations of the utility load and the output current of the inverter with an elevated rate with respect to time. At these elevated rates of detection, islanding can be detected further quickly.

$$cf_k = cf_{k-1} + K(\Delta\omega_k) \tag{4}$$

where  $cf_k$  = chopping fraction of the previous cycle,  $k$  = frequency difference between the previous cycle and present

one,  $K =$  positive gain constant. The value of  $cf$  in AFDPF can be up or down. No matter if frequency drift is upward or downward, this method can add force to the frequency drift as an alternative of counteracting it, overcoming the impact of the load parameters [32–34]. The power quality is to some extent exaggerated due the distortions injected into the grid. The utility voltages NDZ for high-quality factor loads are at a standstill large in this technique [35, 42].

**Impedance Measurement (IM)** This method detects the changes in impedance during grid disconnection in the output of the inverter. The change in impedance is calculated by the rate of change of voltage to the current of the inverter. During islanding operation, the voltage varies with respect to the current and it is monitored from the inverter side [40]. This equivalent impedance seen from the inverter can be used to detect islanding. In case of multiple inverters unless and until all the inverters operate synchronously the detection will not be effective. Also, it is very tedious to obtain the exact value of grid impedance to be set for the threshold value since it is highly intermittent [36].

**Slip Mode Frequency Shift (SMS)** In this method, a positive feedback is applied to the phase of the PCC voltage to destabilize the inverter during islanding. Shifting the phase of the voltage, results in change in frequency. Figure 7 shows the utility frequency, the phase of inverter curve increases rapidly than the phase of the load [37]. An SMS curve is given by the following equation:

$$\theta = \theta_m \sin \left[ \frac{\pi}{2} \frac{f^{k-1} - f_n}{f_m - f_n} \right] \tag{5}$$

In Eq. 5,  $\theta_m$  is referred as maximum phase shift occurring at frequency  $f_m$ .  $f_n$  is the rated frequency and  $f^{k-1}$  is the frequency of the previous cycle.

During normal grid connected condition, the inverter operates at a frequency  $w_0$  with zero phase angles. When

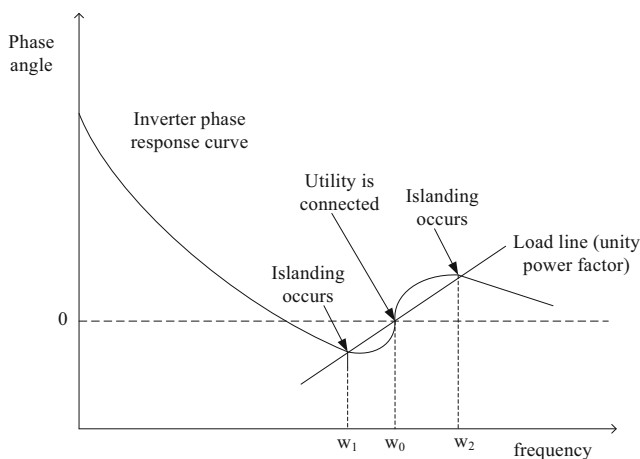

Fig. 7 Operation of slip-mode frequency shift method

the utility is disconnected, the frequency of the PCC voltage will change and accordingly phase response curve increases the phase angle error and hence inverter becomes instable to operate at utility frequency  $w_0$ . This instability further amplifies the perturbation in the frequency and thus the system will move to another operating point either  $w_1$  or  $w_2$  which is the frequency outside the range of OFP/UFP [44]. Implementation in this method is easy and has comparatively smaller NDZ than passive methods. But for some RLC load, which has a phase of load increased at a faster rate, than the phase of inverter like the load which has high Q factor, this method fails to detect an islanding condition [11, 38].

**Hybrid Islanding Detection Techniques**

Hybrid method is evolved from the recipe of both active and passive detection methods [13, 22]. The hybrid methods involve two stages of detecting actions to overcome the problems of passive method and active method, in order to attain higher efficiency [39]. Throughout the detecting course of action, passive detection method is used as prime protection, and then the active detection method is implemented when the islanding is assumed through the passive method [13]. Figure 8 shows the operation of power flow for hybrid islanding detection procedure.

Hybrid islanding detection methods work in the system of detection voltage at PCC to realize the islanding detection. Hybrid methods provide better effectiveness for detecting islanding. Most of the proposed methods are still

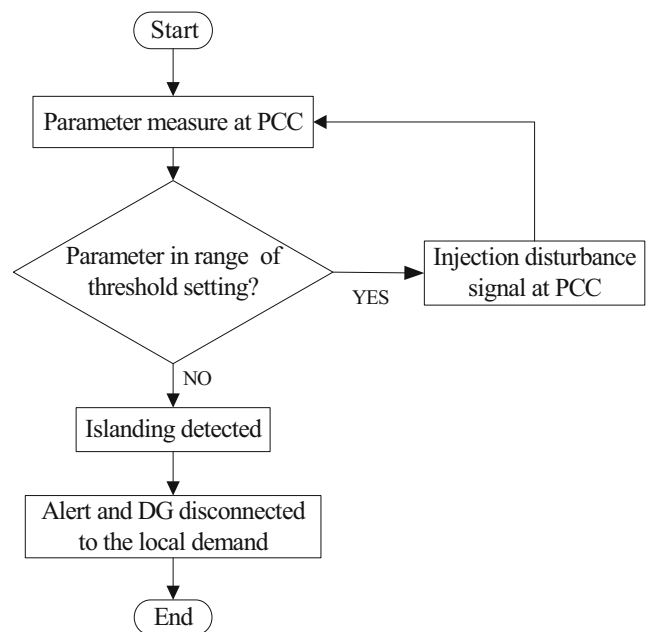

Fig. 8 Flow chart describing the process of a hybrid islanding detection procedure

in the research and development stage, yet to reach practical implementation in real systems [39].

## Remote Techniques

### Methods at the Utility Level

The utility also has a variety of methods available to it to force systems offline in the event of a failure.

**Impedance Insertion** In the impedance insertion method, the small significance impedance, generally a capacitor bank is installed on the utility system [40]. If the local load be of the kind that causes complexity in islanding detection, the adding together of the bulky capacitor would disappoint the balance between the generation and load. However, the present is several remunerations toward using a capacitor for the reason that such capacitor banks are the similar be going to as those that serve awake as a reactive power sustain purpose for the utility. But adding up a capacitor bank in grid side will increase procedure complexity and cost and it will have some delay as soon as adding up the capacity bank in this method, so responding speed will be low.

### Communication Based Methods

Communication based methods have the best performance, compared to the passive and active methods; because of these methods, all circuit breakers are monitored by the control system [42].

**Trip Transfer Schemes** This scheme incorporates SCADA (supervisory control and data acquisition) to observe the position of circuit breakers and reclosers. By means of monitoring the position of the utility circuit breaker secure

to PCC islanding is detected. At this point, voltage sensing strategies are used in the confined parts of the utility system. Alarms associated in series resolve conscious the DG in case of any voltage there when the utility arrangement is detached and curative act resolve is taken [34, 42].

**Power Line Carrier Communication (PLCC)** PLCC method uses the communication channel during the utility power line on behalf of islanding detection [43]. During this method, a miniature energy signal is propelled between the transmitter (T) installed by the side of the utility and the receiver (R) inserted at the DG side. This communication, determination is disturbed at what time islanding occurs and a stopping signal is sent toward PCU or a switch through the receiver in the direction of segregating the load [44].

**Signal Produced by Disconnect (SPD)** The SPD method just about has no NDZ, and has a further feature which allows control of DG as a result of the main grid, which would survive precious [45]. This bringing together helps during civilizing the early characteristics of the system. Huge capital speculation is desired to be used for installation of transmitters, receivers, cabling repeaters (for microwave transmission) and setting awake of communication set of a rule which makes this method unsuitable for low power density DG units [46, 47].

## Merits and Demerits of Islanding Detection Techniques

Table 1 shows the ordinary merits and demerits of passive, active and remote methods. Passive method is the important constraint of grid associated DG, because this method is proficient and practical. Active methods are developed in

**Table 1** Merits and demerits of islanding detection techniques

Islanding detection techniques	Advantages	Disadvantages
Passive techniques	<ul style="list-style-type: none"> <li>• Smaller detection time</li> <li>• Do not introduce any perturbation in the system</li> <li>• Do not humiliate output power quality of the DG</li> <li>• Accurately detect islanding condition where there is large variance between DG capacity and local demand</li> </ul>	<ul style="list-style-type: none"> <li>• Threshold setting is difficult</li> <li>• If the setting is too destructive than it could result in nuisance tripping</li> <li>• Difficult to detect islanding when DG capacity and local demand are directly matched</li> <li>• Large NDZ</li> </ul>
Active techniques	<ul style="list-style-type: none"> <li>• Small NDZ</li> <li>• Still, for perfect match between DG capacity and local load demand, it can detect islanding</li> </ul>	<ul style="list-style-type: none"> <li>• Introduce perturbation in the system</li> <li>• Output power quality of the system degrades and if considerable enough, it will degrade the stability of the system</li> <li>• Detection time is slow</li> </ul>
Remote methods	<ul style="list-style-type: none"> <li>• Further, consistent</li> </ul>	<ul style="list-style-type: none"> <li>• Expensive toward implementing</li> </ul>

**Table 2** Comparison of various islanding detection techniques

Type of IDM	Methodology	Detection time	NDZ	Power quality	System cost	Operation under Multi DG units
OUV/OUF	P	#	VL	NI	L	●
PJD	P	○	#	NI	L	●
VH	P	○	○	NI	L	●
ROCOP	P	○	M	NI	L	●
ROCOF	P	○	S	NI	L	●
AFD	A	S	S	SD	H	△
AFDPF	A	S	○	SD	H	△
SFS	A	S	S	SD	M	△
SVS	A	S	S	SD	M	△
IM	A	S	S	SD	H	△
SMS	A	S	*	SD	H	△
PLCC	C	*	*	NI	VH	●
SPD	C	*	N	NI	VH	●
SCADA	C	*	N	NI	VH	●

**Note:** P = passive method, A = active method, C = communication method, # = large, ○ = average, S = small, VL = very large, N = none, NI = no impact, \* = very small, M = medium, SD = slight degrade, L = low, H = high, VH = very high, ● = possible, △ = complex

the direction of the condense NDZ of passive methods, as a consequence, most of the active methods have very small NDZ compared toward passive methods, apart from in cases of high Q factor loads. As a result, active methods are capable to corrupt the system stabilization and power quality [1, 17, 48]. This concern will develop further significance when more inverters are associated with same DG. Communication support detection has just right concert, although the system and process cost is extremely elevated, proper toward the supplementary telecommunication strategy and sensors installed by the side of utility. Hence, these methods are frequently applied to large size systems with perceptual load, wherever power quality and system stabilization are tinted instead of system cost. Therefore, by means of the principle to solve problems of individuals three common methods, hybrid detection methods have been proposed towards reducing NDZ, make available better power quality and cheaper system cost.

## Comparison of Various Islanding Detection Methods

It is necessary to know the restrictions on anti-islanding methods obtained before the comparison. All methods discussed over can have subsequent limitations [48, 49].

- Elevated achievement costs
- Inclination toward counterfeit procedure into multiple DG case
- Happening of NDZ's
- Decline in power quality, and scheme constancy

Cost has all the time been a dominant factor in determining realistic and reliable method designed for islanding detection. Owing to these reasons, active methods are generally intended for islanding detection [42, 49]. The appraisal of the range of IDMs and their performances through detection time, size of NDZ, power quality disturbances, system cost and operation under multiple DG units is given in Table 2.

In this paper, it can survive there that active methods are profoundly emphasized during the majority of investigating and enlargement resting on uncovering method. Current PV grid associated systems are generally functional in small range basis to provide the failing effects by means of active detection methods fewer considerable. Presently among all active methods, SVS and SFS methods are well thought-out the mainstream, effectual methods intended for PV based DG [50].

## Conclusion

This survey provides a classification of islanding detection techniques based on detection time, size of non-detection zone, power quality disturbances, system cost and operation under multiple distributed generation units, which is possibly useful for selecting islanding detection technique for a particular application. The survey has discussed the merits and demerits of islanding detection methods. Review of several passive and active islanding detection methods through the purpose of relying upon taking place measurement of local parameters. Active methods are



advanced to the passive detection methods, even while there is no variance between power generated and demanded during the local island. Remote methods for islanding detection are advanced to local islanding detection methods, however, to the increased cost and stage of advantage. It is observed that active methods are more accurate but passive methods are faster. Hybrid detection methods are robust, and suitable for individual problems for reduced NDZ, better power quality with cost effectiveness. This paper is intended to serve as a convenient reference for future islanding users in distributed generation system.

## References

- Chowdhary SP, Chowdhary S, Ten CF, Crossley PA (2009) Operation and control of DG based power island in smart grid environment. In: International conference and exhibition on electricity distribution part 1, Boston, pp 1–5. <https://doi.org/10.1049/ic:20080490>
- Makhlouf M, Messai F, Nabti K, Benalla H (2012) Modelling and simulation of grid-connected photovoltaic distribution generation system. In: IEEE International conference on renewable energies and vehicular technology, Hammamet, pp 187–193. <https://doi.org/10.1109/REVET.2012.6195269>
- Soumya R, Moahnty SR, Roy PK (2015) Comparative study of advanced signal processing techniques for islanding detection in a hybrid distributed generation system. *IEEE Transaction on Sustainable Energy* 171–178. <https://doi.org/10.1109/TSTE.2014.2362797>
- Hu X, SM J, Nikolce M, Egardt B, Cao D (2016) Integrated optimization of battery sizing, charging, and power management in plug-in hybrid electric vehicles. *IEEE Trans Control Syst Technol* 24:1036–1043. <https://doi.org/10.1109/TCST.2015.2476799>
- Hu X, Zou Y, Yang Y (2016) Greener plug-in hybrid electric vehicles incorporating renewable energy and rapid system optimization. *Energy*. 111:971–980. <https://doi.org/10.1016/j.energy.2016.06.037>
- Wu X, Hu X, Moura S, Yin X, Pickert V (2016) Stochastic control of smart home energy management with plug-in electric vehicle battery energy storage and photovoltaic array. *J Power Sources* 333:203–212. <https://doi.org/10.1016/j.jpowsour.2016.09.157>
- Gupta P, Bhatia RS, Jain DK (2015) Average absolute frequency deviation value base active islanding detection technique. *IEEE Trans Smart Grid* 6:26–35. <https://doi.org/10.1109/TSG.2014.2337751>
- Brown RE (1996) Reliability assessment and design optimization in electric power distribution systems. Ph.D Dissertation University, Washington. <https://doi.org/10.1109/TDC.2001.971382>
- Mahat P, Chen Z, Bak-Jensen B (2008) Review of islanding detection methods for distribution generation. In: International conference on electric utility deregulation and restructuring and power technologies (DRPT), China, pp 2743–2748. <https://doi.org/10.1109/DRDT.2008.4523877>
- Chandrakar CS, Dewani B, Chandrakar D (2012) An assessment of distribution generation islanding detection methods. *Int J Adv Eng Technol* 5:218–226. <https://doi.org/10.7323/ijaet/v5.iss1>
- Lidula NWA, Perera N, Rajapakse AD (2009) Investigation of a fast islanding detection methodology using transient signals. In: IEEE Power engineering society general meeting, Calgary, pp 1–6. <https://doi.org/10.1109/ICINF.2009.5429812>
- Nikkhajoie H, Lasseter RH (2007) Micro grid protection. In: IEEE power engineering society general meeting, Tampa. <https://doi.org/10.1109/PES.2007.385805>
- Narayanan K, Siddiqui SA, Manoj F (2017) Hybrid islanding detection method and priority-based load shedding for distribution networks in the presence of DG units. *IET Gener Transm Distrib* 11:586–595. <https://doi.org/10.1049/iet-gtd.2016.0437>
- Trujillo CL, Velasco D, Figueres E, Garcera G (2010) Analysis of active islanding detection methods for grid connected micro inverters for renewable energy processing. *Appl Energy* 87:3591–3605. <https://doi.org/10.1016/j.apenergy.2010.05.014>
- Kunte RS, Gao W (2008) Comparison and review of islanding detection techniques for distributed energy resources. In: IEEE power symposium conference, Canada, pp 1–8. <https://doi.org/10.1109/NAPS.2008.5307381>
- Guha B, Haddad RJ, Kalaani Y (2015) Anti-islanding techniques for inverter-based distributed generation system-a survey. In: IEEE Southeast conference, Southeast, pp 1–9. <https://doi.org/10.15680/IJRSET.2016.0504084>
- Ropp ME, Begovic M, Rohatgi A, Kern GA, Bonn RH, Gonzalez S (2000) Determining the relative effectiveness of islanding prevention techniques using phase criteria and non-detection zones. *IEEE Trans Energy Convers* 15:290–296. <https://doi.org/10.1109/60.875495>
- Balaguer-Alvarez I, Ortiz-Rivera E (2010) Survey of distributed generation islanding detection methods. *IEEE Latin Amer Trans* 8:565–570. <https://doi.org/10.1109/TLA.2010.5623510>
- Bright CG (2001) COROCOF: comparison of rate of change of frequency protection- A solution of the detection of loss of mains. In: International development power system protection conference, Glasgow, pp 70–73. <https://doi.org/10.1109/cp:20010102>
- Salman SK, King DJ, Weller G (2000) Detection of loss of mains based on using rate of change of voltage and changes in power factor. In: Universities power engineering conference, Belfast, pp 1–8. <https://doi.org/10.1049/cp:2001015>
- Katiraei F, Foss A, Abbey C, Strehler B (2007) Dynamic analysis and field verification of an innovative anti-islanding protection scheme based on direction reactive power detection. In: IEEE electrical power conference, Canada, pp 183–188. <https://doi.org/10.1109/EPC.2007.4520327>
- Vatani M, Amraee T, Ranjbar AM, Mozafari B (2015) Relay logic for islanding detection in active distribution systems 9:1254–1263. <https://doi.org/10.1049/iet-gtd.2014.0373>
- Bollen M, Zhong J, Samuelsson O, Bjornstedt J (2009) Performance indicators for micro grids during grid-connected and island operation. <https://doi.org/10.1109/PTC.2009.5282118>
- Roop ME (1998) Design issues for grid-connected photovoltaic systems. Ph.D. Dissertation, Department of Electrical Engineering, Georgia Tech Univ, Atlanta. <https://doi.org/10.1109/TIA.2012.2209190>
- Zeineldin H, Marei MI, Saadany EF, Salama MA (2004) Safe controlled islanding of inverter based distributed generation. In: IEEE power electronics specialists conference, Germany, vol 4, pp 2515–2520. <https://doi.org/10.1109/PESC.2004.1355224>
- Lee SH, Park JW (2010) New islanding detection method for inverter-based distributed generation considering its switching frequency. *IEEE Trans Ind Appl* 46:2089–2098. <https://doi.org/10.1109/IAS.2009.5324872>
- Tofis Y, Hadjidemetriou L, Kyriakides E (2013) An intelligent load shedding mechanism for maintaining frequency stability. In: PowerTech IEEE grenoble, France. <https://doi.org/10.1109/PTC.2013.6652296>
- Liu F, Kang Y, Duan S (2007) Analysis and optimization of active frequency drift islanding detection method. In: Applied power electronics conference, Blacksburg, pp 1379–1384. <https://doi.org/10.1109/APEX.2007.357696>

29. Jung Y, Choi J, Yu B, So J, Yu G, Choi J (2005) A novel active frequency drift method of islanding prevention for the grid-connected photovoltaic inverter. In: 2005 IEEE 36th power electronics specialists conference, Recife, pp 1915–1921. <https://doi.org/10.1109/PESC.2005.1581893>
30. Reigosa D, Briz F, Charro CB, Garcia P, Guerrero JM (2012) Active islanding detection using high-frequency signal injection. *IEEE Trans Ind Appl* 48:1588–1597. <https://doi.org/10.1109/TIA.2012.2209190>
31. Noor F, Arumugam R, Vaziri MY (2005) Unintentional islanding and comparison of prevention techniques. In: Proceedings of the 37th annual North American power symposium, USA, pp 90–96. <https://doi.org/10.1109/NAPS.2005.1560507>
32. Li C, Cao C, Cao Y, Kuang Y, Zeng L, Fang B (2014) A review of islanding detection methods for microgrid. *Renew Sustainable Energy Rev* 35:211–220. <https://doi.org/10.1016/j.rser.2014.04.026>
33. Ye Z, Kolwalkar A, Zhang Y, Du P, Walling R (2004) Evolution of anti-islanding schemes based on non-detection zone concept. *IEEE Trans Power Electron* 19:1171–1176. <https://doi.org/10.1109/TPEL.2004.833436>
34. Yafaoui A, Wu B, Kouro S (2012) Improved active frequency drift anti-islanding detection method for grid connected photovoltaic systems. *IEEE Trans Power Electron* 27:2367–2375. <https://doi.org/10.1109/TPEL.2011.2171997>
35. Wrinch M, Marti J, Nagpal M (2008) Negative sequence impedance based islanding detection for distributed generation (NSIID). In: IEEE electric power conference, Canada, vol 1, pp 6–7. <https://doi.org/10.1049/iet-gtd.2015.1229>
36. Yin J, Diduch CP, Chang L (2008) Islanding detection using proportional power spectral density. *IEEE Trans Power Deliv* 23:776–784. <https://doi.org/10.1109/TPWRD.2007.915907>
37. Jang S-II, Kim K-H (2004) An islanding detection method for distributed generations using voltage unbalance and total harmonic distortion of current. *IEEE Trans Power Deliv* 19:745–752. <https://doi.org/10.1109/TPWRD.2003.822964>
38. Singam B, Hui LY (2006) Assessing SMS and PJD schemes of anti-islanding with varying quality factor. In: IEEE International power and energy conference. Belmont, USA, vol 28, pp 196–201. <https://doi.org/10.1109/PECON.2006.346645>
39. Chang WY (2010) A hybrid islanding detection method for distributed synchronous generators. In: International power electronics conference (IPEC), Asia, pp 948–953. <https://doi.org/10.1109/IPEC.2010.5544559>
40. Funabashi T, Koyanagi K, Yokoyama R (2003) A review of islanding detection methods for distributed resources. In: IEEE (2003) Bologna power tech conference proceedings, vol 2, pp 608–613. <https://doi.org/10.1109/PTC.2003.1304617>
41. Lopes LAC, Sun H (2006) Performance assessment of active frequency drifting islanding detection methods. *IEEE Trans Energy Conversion* 21:171–180. <https://doi.org/10.1109/TEC.2005.859981>
42. Ropp ME, Aaker K, Haigh J, Sabbah N (2000) Using power line carrier communications to prevent islanding of PV power systems. In: 28th IEEE photovoltaic specialists conference, Anchorage, pp 1675–1678. <https://doi.org/10.1109/PVSC.2000.916224>
43. Ropp M, Larson D, Meandering S, McMahon D, Ginn J, Stevens J, Bower W, Gonzalez S, Fen-nell K, Brusseau L (2006) Discussion of a power line carrier communications-based anti-islanding scheme using a commercial automatic meter reading system. In: 4th IEEE world conference on photovoltaic energy conversion, Waikoloa, vol 2, pp 2351–2354. <https://doi.org/10.1109/WCPEC.2006.279663>
44. Xu W, Zhang G, Li C, Wang W, Wang G, Klüber J (2007) A power line signaling based technique for anti-islanding protection of distributed generators Part 1: scheme and analysis. *IEEE Trans Power Deliv* 22:1767–1772. <https://doi.org/10.1109/TPWRD.2007.899618>
45. Balaguer IJ, Kim HG, Peng FZ, Ortiz EI (2008) Survey of photovoltaic power systems islanding detection methods. In: 34th annual conference of IEEE industrial electronics, Florida, vol 10, pp 2247–2252. <https://doi.org/10.1109/IECON.2008.4758306>
46. Sun J (2011) Impedance-based stability criterion for grid-connected inverters. *IEEE Trans Power Electron* 26:3075–3078. <https://doi.org/10.1109/TPEL.2011.2136439>
47. Javadian SAM, Tamizkar R, Haghifam MR (2009) A protection and reconfiguration scheme for distribution network with DG. In: IEEE Power technology conference, Bucharest, pp 1–8. <https://doi.org/10.1109/PTC.2009.5282063>
48. Yu BG, Matsui M, Yu GJ (2011) A correlation-based islanding-detection method using current-magnitude disturbance for PV system. *IEEE Trans Ind Electron* 58:2935–2943. <https://doi.org/10.1109/TIE.2010.2080651>
49. IEEE (2003) Standard for interconnecting distributed resources with electric power systems, vol 1547. IEEE Standard. <https://doi.org/10.1109/IEEESTD.2003.94285>
50. Assis TML, Taranto GN (2012) Automatic reconnection from intentional islanding based on remote sensing of voltage and frequency signals. *IEEE Trans Smart Grid* 3:1877–1884. <https://doi.org/10.1109/TSG.2012.2191579>