

AN EQUILIBRIUM MODEL OF THE INTERNATIONAL PRICE SYSTEM*

Dmitry Mukhin

d.mukhin@lse.ac.uk

September 10, 2021

Abstract

What explains the central role of the dollar in world trade? Will the U.S. currency retain its dominant status in the future? This paper develops a *quantitative general equilibrium* framework with *endogenous* currency choice that can address these questions. Complementarities in price setting and input-output linkages across firms generate complementarities in currency choice making exporters coordinate on the same currency of invoicing. The dollar is more likely to play this role because of the large size of the U.S. economy, a widespread peg to the dollar, and the history dependence in currency choice. Calibrated using the world input-output tables and exchange rate moments, the model can successfully replicate the key empirical facts about the use of currencies at the global level, across countries, and over time. According to the counterfactual analysis, the peg to the dollar in other economies ensures that the U.S. currency is unlikely to lose its global status because of the falling U.S. share in the world economy, but can be replaced by the renminbi in case of a negative shock in the U.S. economy. If the peg is abandoned, the world is likely to move to a new equilibrium with multiple regional currencies.

*This paper is based on my PhD dissertation at Princeton. I am extremely grateful to my advisor Oleg Itskhoki, as well as to Mark Aguiar, Nobu Kiyotaki, and Esteban Rossi-Hansberg for continual guidance and support. I am also indebted to Michael Devereux, Povilas Lastauskas, Luca Dedola, and Fernando Leibovici for insightful discussions, Costas Arkolakis, Ariel Burstein, Giancarlo Corsetti, Javier Cravino, Eduardo Dávila, Konstantin Egorov, Charles Engel, Linda Goldberg, Gita Gopinath, Pierre-Olivier Gourinchas, Matteo Maggiori, David Nagy, Diego Perez, Mikkel Plagborg-Møller, Richard Rogerson, Sanjay Singh, and Aleh Tsyvinski as well as numerous seminar/conference participants for helpful comments and suggestions, David Baqaee and Philip Saure for generously sharing their data, Viktoriia Berestova, Anna Lukianova, Julia Soloveva, Vitalii Tubdenov, Aiaz Valetdinov, and Nan Xiang for the outstanding research assistance, and the International Economics Section at Princeton University and the Cowles Foundation at Yale University for financial support.

1 Introduction

One of the most intriguing facts in international economics is the asymmetric use of currencies in world trade and the dominance of the dollar in the international price system (Gopinath 2016). Indeed, the share of dollar currency pricing (DCP) in imports and exports is disproportionately high in both emerging economies – where it often reaches one – and many developed countries including Japan, South Korea, and several European economies (see Figures A3). In contrast, the euro (ECP) plays the role of a regional currency accounting for most of the trade within Eurozone, but almost zero share in trade between third countries. The use of other currencies is marginal and is usually lower than the trade shares of the corresponding economies. Although these invoicing patterns are highly persistent and with few exceptions do not change much at the horizon of a few decades, the history of the twentieth century shows that they are not immanent and that the international price system can undergo major transformations with one dominant currency (dollar) replacing the other (pound sterling). These facts raise several policy-relevant questions: Why do firms coordinate on one vehicle currency instead of using producer currencies (PCP) and/or local currencies (LCP)? What explains the central role of the dollar? Will the U.S. currency retain its dominant status in the future? Is it more likely to be replaced by the euro, by the renminbi or are we heading to a world with multiple regional currencies?

This paper studies these questions both *theoretically* and *quantitatively* by developing a tractable general equilibrium framework with endogenous currency choice. I build on the conventional sticky-price open-economy model by Gali and Monacelli (2005) and augment it with three additional ingredients. First, rather than taken as exogenous, the currency of invoicing is optimally chosen by individual exporters to bring their prices – which are sticky and cannot adjust in response to shocks – closer to the optimal level (Engel 2006). Second, I allow for price linkages across firms that arise from the use of intermediates in production and complementarities in price setting. These linkages are strongly supported by the data, especially for large firms that account for most of international trade, and are important to explain several other puzzles in international economics (see e.g. Amiti, Itskhoki, and Konings 2014, Burstein and Gopinath 2012). Finally, the countries are heterogeneous in terms of size, inflation, and exchange rate regime.

Solving analytically for the equilibrium currency choice, I show that the model can explain key stylized facts about the international price system. Because of price linkages, each firm wants to synchronize its price with the prices of suppliers and competitors, which generates strategic complementarities in currency choice and gives rise to an equilibrium with exporters coordinating on one dominant currency. Two fundamental factors – the large size of the U.S. economy and the use of the dollar as an anchor currency by other countries – make the dollar the most likely candidate for a vehicle currency. Intuitively, the size advantage implies that foreign firms use more U.S. intermediates and compete with a larger number of U.S. firms, which makes their prices more sensitive to the dollar exchange rate and increases the odds that they choose DCP when selling goods both in the U.S. and in other markets. The

anchor-currency advantage, on the other hand, means that many countries stabilize their exchange rates against the dollar (see [Ilzetzi, Reinhart, and Rogoff 2019](#)) making it the best substitute for a large number of currencies and increasing its chances to become a vehicle currency. This mechanism is further amplified by the fact that many developing countries have high inflation, which makes their currencies hardly suitable for invoicing.

The international price system is shaped, however, not only by fundamental factors, but also by its history: because of strategic complementarities, no exporter wants to change the currency of invoicing before other firms do, giving rise to path dependence. The hysteresis is even stronger if firms have to pay fixed costs when switching to a new currency. This result can account for the delayed transition from the pound to the dollar during the twentieth century and the wide use of the dollar in the modern economy, despite increasing competition from the euro and the renminbi.

I then show that a straightforward extension of the baseline model can be easily taken to the data and used for a rich quantitative analysis. Complementing the analytical results that capture the first-order facts about the international price system, the quantitative extension of the model allows for a more nuanced view with the coexistence of the dominant, regional and local currencies in world trade. I calibrate price stickiness and complementarities in price setting using the values from [Nakamura and Steinsson \(2008\)](#) and [Amiti, Itskhoki, and Konings \(2019\)](#) and estimate the two main inputs of the quantitative model – the country-sector trade flows and the exchange rates moments – directly from the data using the OECD world input-output (ICIO) tables with 63 countries and 32 sectors and the exchange rate series from the IFM IFS database. To capture history-dependence, the model is estimated and simulated sequentially for years 1995, 2005 and 2015 using as an initial guess the equilibrium invoicing from the previous period. Importantly, the only invoicing moment used in the calibration is the aggregate share of DCP for a subsample of countries in 1995 to choose the value of the fixed costs of currency adjustment.

Confronted with the invoicing data from [Georgiadis, Le Mezo, Mehl, Casas, Boz, Nguyen, and Gopinath \(2020\)](#), the calibrated model shows a surprisingly good fit replicating the key empirical facts about global use of currencies, the cross-sectional variation, and the evolution of invoicing in time. The share of DCP in total exports of 53 economies with available invoicing data is 52% in the model against 53% in the data. Moreover, the model explains 80% of the cross-country variation in DCP, including relatively low shares in the Eurozone countries, high shares in the U.S. and most emerging economies, and the intermediate values in the U.K. and Japan. The cross-sectional fit for the euro and home currencies is even better, exceeding 90%. This success of the structural model with endogenous currency choice contrasts with the naïve predictions based on trade shares and the role of commodities, which can explain neither the global dominance of the dollar, nor its cross-country variation. Using the granular invoicing data for Switzerland, I also show that the model captures the differences in currency shares across sectors. In addition, the model closely reproduces the evolution of the price system in 1995–2015, generating stable currency shares for most countries and a negative trend in DCP for

selected European economies that switched to the euro.

Lastly, I take advantage of the quantitative general equilibrium framework to do counterfactuals about the future of the international price system under alternative scenarios. Interestingly, the model predicts that the rise of China and other emerging economies does not imperil, and can even strengthen, the dominance of the dollar if these countries maintain their current peg to the U.S. currency. Given the complementarities and the adjustment costs, firms are unlikely to abandon the dollar as long as it remains a close substitute to other currencies. On the flip side, the status of the anchor currency bears its own risks, making the DCP equilibrium more sensitive to negative shocks in the U.S. economy: an increase in the U.S. inflation rate – e.g. due to rising government debt or the loss of the safe-asset status of treasuries – makes exporters look for an alternative unit of account and switch to the renminbi as the dollar’s closest substitute. Finally, I consider a case where China abandons its peg to the dollar and several emerging economies follow suit, adopting the renminbi as a new anchor currency. This counterfactual mirrors the history of the twentieth century, when many countries joined the Bretton Woods system with a peg to the pound or gold, but left it with a peg to the dollar (see [Gourinchas 2021](#)). Under this scenario, history dependence is strong enough to prevent the renminbi from becoming the new dominant currency, but it is not sufficient for the dollar to retain its global status, and therefore, the world moves to a new equilibrium with multiple regional currencies in line with the predictions of [Eichengreen \(2011\)](#).

Related literature There are three main strands in the literature that use different frictions to explain the dominant status of the dollar in international trade. First, there is a long tradition in economics, going back to [Krugman \(1980\)](#), that emphasizes the *transaction costs* in exchange markets: coordination on a single currency raises the chances of a “double coincidence of wants” ([Matsuyama, Kiyotaki, and Matsui 1993](#)) and increases the “thickness” of markets ([Rey 2001](#), [Devereux and Shi 2013](#), [Chahrour and Valchev 2021](#)). These theories explain the widespread use of the dollar as a medium of exchange but have little to say about its role as an invoicing currency. Second, the use of the dollar as a unit of account can be due to *financial frictions*: firms try to synchronize the risks on their contracts ([Drenik, Kirpalani, and Perez 2018](#)) and borrow in a cheaper currency ([Gopinath and Stein 2021](#)).

This paper belongs to the third strand in the literature, one that emphasizes *nominal frictions* and has two important advantages. First, [Gopinath, Itskhoki, and Rigobon \(2010\)](#) provide direct empirical evidence in favor of this mechanism, which allows them to discriminate against alternative theories. Second, it is price stickiness that makes currency choice relevant for monetary policy in most existing open-economy models ([Gopinath, Boz, Casas, Díez, Gourinchas, and Plagborg-Møller 2020](#)) and so it is natural to use the same friction as a starting point to think about firms’ invoicing decisions.

The contribution of this paper is twofold. On the theory side, several ingredients of the model come from the previous literature, including firm’s currency choice under sticky prices ([Friberg 1998](#), [Engel 2006](#)), complementarities in currency choice arising from input-output linkages ([Novy 2006](#), [Devereux,](#)

Shi, and Xu 2010) and price linkages (Bacchetta and van Wincoop 2005, Goldberg and Tille 2008), the effect of monetary policy on invoicing (Corsetti and Pesenti 2002, Devereux, Engel, and Storgaard 2004), and the use of a vehicle currency in international trade (Bhattarai 2009, Cravino 2014). None of these papers, however, are readily available to analyze the global dominance of the dollar or the future of the international price system. Three features of my model distinguish it from the previous literature and make it particularly suitable to address these issues. First, I consider a world with multiple countries, which allows me to distinguish vehicle currencies from PCP and LCP. Second, the model is consistent with the exchange rate disconnect in the data and does not produce a counterfactually high correlation between exchange rates and nominal wages – the moment that plays the central role in firms’ currency choice. Finally and most importantly, I solve for the *equilibrium* invoicing taking into account the effects of exporters’ decisions on each other via input-output linkages and complementarities in price setting.

On the empirical side, the paper complements the reduced-form evidence (see Goldberg and Tille 2008, Drenik and Perez 2021, Georgiadis, Le Mezo, Mehld, and Tille 2020) with the structural analysis of the determinants of the currency choice using a calibrated general equilibrium model to explain the global invoicing as well as its variation across countries, sectors, and periods. The important advantage of this approach is that it takes into account the interactions between exogenous factors in their effect on equilibrium invoicing, as well as the complementarities in currency choice across firms that are hard to capture in reduced-form regressions, especially given the limited coverage of the invoicing data.

2 Baseline Model

This section describes the model of currency choice that is based on conventional ingredients and attains a closed-form characterization, yet is rich enough to allow for alternative invoicing regimes depending on parameter values. I keep the environment as simple as possible for tractability reasons and relegate the discussion of extensions to Section 4.

2.1 Environment

Following Gali and Monacelli (2005), consider a world consisting of a continuum of symmetric regions $i \in [0, 1]$. Each region $i \in (n, 1]$ is a small open economy with its own nominal unit of account, in which local wages and prices are expressed. All countries are symmetric except for the U.S., which is allowed to be different in two dimensions. First, it is a large economy that includes regions $i \in [0, n]$ and can also be interpreted as a currency union or a set of dollarized countries. Second, as explained in detail below, the second moments of exogenous shocks are such that the volatility of the exchange rates against the dollar are lower than the volatility of other bilateral exchange rates capturing the fact that many countries peg their exchange rates to the dollar (see Ilzetzi, Reinhart, and Rogoff 2019).

In each country, there is a representative household, a local government and a continuum of firms

with intermediate goods in production, strategic complementarities in price setting and the home bias towards domestically produced goods. For simplicity, there is only one period, risk-sharing and price-setting decisions are made before the realization of shocks and firms adjust prices afterwards with a given probability. I focus on financial shocks as the key driver of exchange rates, which is consistent with empirical evidence (see [Jiang, Krishnamurthy, and Lustig 2018](#), [Engel and Wu 2018](#)) and allows the model to reproduce the exchange rate disconnect from the data (see [Itskhoki and Mukhin 2021](#)).

Households in region i have log-linear preferences over consumption and labor

$$\mathbb{E}[\log C_i - L_i]. \quad (1)$$

Before the realization of shocks, agents can trade internationally a full set of Arrow securities subject to the ex-ante budget constraint

$$\sum_h Q^h B_i^h = 0, \quad (2)$$

where Q^h is the price of Arrow security that pays one dollar in a given state of the world indexed by h . To simplify the notation, I suppress index h below with the understanding that all variables are state-contingent if not noted otherwise. After the shocks are realized, households collect labor income $W_i L_i$, dividends from local firms Π_i and returns on their assets, and spend the proceeds $P_i C_i$ on consumption:

$$P_i C_i = W_i L_i + \Pi_i + e^{-\psi_i} \mathcal{E}_{i0} B_i + \Omega_i, \quad (3)$$

where \mathcal{E}_{ij} is the bilateral nominal exchange rate between regions i and j , which goes up when currency i devalues relative to currency j . Because markets are complete, the assumption that returns on the Arrow securities are in dollars is without loss of generality. I allow for stochastic country-specific wedges in asset returns ψ_i , which can be interpreted as a shock in the local financial markets with the resulting profits (or losses) of the financial sector Ω_i reimbursed lump-sum to local households.

Firms in region i produce a continuum of unique tradable products indexed by $\omega \in [0, 1]$ using technology that combines labor L_i and intermediate goods X_i :

$$Y_i(\omega) = A_i \left(\frac{L_i(\omega)}{1 - \phi} \right)^{1-\phi} \left(\frac{X_i(\omega)}{\phi} \right)^\phi, \quad \phi < 1. \quad (4)$$

The bundle of intermediates X_i used in production is the same as that consumed by households and includes both local and foreign varieties, which are combined via a homothetic aggregator:

$$\Phi \left(\left\{ \frac{Y_{ji}(\omega)}{X_i} \right\}_{j,\omega}, \gamma \right) = 1, \quad (5)$$

where $Y_{ji}(\omega)$ denotes exports of product ω from country j to country i and the home bias $1 - \gamma$ reflects either trade costs or preferences for domestic goods, $\gamma \in (0, 1)$. Note that when $n > 0$, a positive fraction of global trade happens between regions within the U.S. As a result, the home bias is higher in the U.S. than in small economies. I assume $\Phi(\cdot)$ is the [Kimball \(1995\)](#) aggregator (see equation (A1) in the appendix) to allow for complementarities in price setting, which as explained below, are important for firms' currency choice.

For each country of destination, exporters choose the currency of invoicing, which they use to set the price before the realization of shocks. I use a one-period version of [Calvo \(1983\)](#) pricing, assuming that the price can be updated ex post with probability $1 - \lambda$.¹ While any currency can be used for invoicing in international trade, it is assumed that local firms set prices exclusively in domestic currency – perhaps due to legal reasons. Appendix A.3.2 relaxes this assumption and derives additional results when domestic firms optimally choose the currency of invoicing.

Government in each country is responsible for setting monetary policy. Following the primal approach, I formulate the monetary policy in terms of the target, namely, the process for the aggregate demand $M_i \equiv C_i P_i$ as in [Carvalho and Nechio \(2011\)](#), and abstract from the particular implementation of this policy, which can be done either with an interest-rate rule or a money-supply rule.

Equilibrium conditions require that labor supply equals total demand of all firms:

$$L_i = \int_0^1 L_i(\omega) d\omega. \quad (6)$$

Produced goods are sold locally and exported abroad to be used in production and consumption:

$$Y_i = (1 - \gamma)Y_{ii} + \gamma \int_0^1 Y_{ij} dj. \quad (7)$$

Finally, the market clearing in the international asset markets implies

$$\int_0^1 B_i di = 0. \quad (8)$$

Shocks that have no effect on nominal exchange rates in this setting – including shocks to productivity, government spending, and terms-of-trade – do not change the trade-off between setting prices in different currencies, and therefore are suppressed for brevity. Furthermore, I assume that monetary policy fully stabilizes nominal demand and revisit the case of positive inflation in Section 4.1. This

¹The currency choice is robust to the nature of nominal rigidities – including staggered price setting (Section 4), [Rotemberg \(1982\)](#) friction, and menu costs (see [Gopinath, Itskhoki, and Rigobon 2010](#)) – and to replacing the assumption that currency choice is made unilaterally by suppliers with Nash bargaining between buyers and sellers.

leaves financial shocks ψ_i as the only source of volatility in exchange rates. Assume that these shocks can be decomposed into a common global component $\bar{\psi}$ and an idiosyncratic currency-specific component $\psi_i - \bar{\psi}$ that is uncorrelated across countries (but not regions). The volatility of the latter is assumed to be lower for the U.S. than for other economies, i.e. $\rho \equiv \frac{\text{var}(\psi_0 - \bar{\psi})}{\text{var}(\psi_i - \bar{\psi})} \leq 1$ for $\forall i > n$, which can be rationalized in three ways. First, a better diversification of the U.S. economy implies that it is subject to granular shocks less than countries that specialize in production and exports of a few commodities and manufacturing goods (Gabaix 2011, Gaubert and Itskhoki 2021). Second, the large size of the U.S. economy can result in stronger spillovers and comovement with other economies (Hassan 2013). My preferred interpretation of the condition, however, is that non-U.S. economies use FX interventions and capital controls to stabilize their exchange rates against the dollar, giving rise to a global component $\bar{\psi}$ that is negatively correlated with ψ_0 (Ilzetzki, Reinhart, and Rogoff 2019).²

Definition 1 *Given exogenous shocks $\{\psi_i\}$, an equilibrium is defined as follows: a) households maximize utility over consumption, labor supply and asset holdings, b) each firm maximizes expected profits over labor, intermediate inputs, currency of invoicing and prices in each market, taking the decisions of all other firms as given and setting domestic prices in local currency, c) all markets clear.*

2.2 Firm's currency choice

This section describes the invoicing problem of an individual exporter following closely the insights of Engel (2006), Gopinath, Itskhoki, and Rigobon (2010) and Cravino (2014). In contrast to the previous literature, which focuses mostly on a binary currency choice (e.g. between PCP and LCP), firms are allowed to set prices in any currency $k \in [0, 1]$ in the model. I approximate equilibrium conditions around the symmetric steady state and denote the log-deviations of variables from the steady-state values with small letters (see Appendix A.1 for details).

Let $\Pi_{ji}(p)$ denote the profit of the exporter from country j to country i as a function of price p expressed in the currency of destination.³ Define the optimal price \tilde{p}_{ji} that maximizes profits for a given realization of shocks:

$$\tilde{p}_{ji} = \underset{p}{\operatorname{argmax}} \Pi_{ji}(p).$$

Ideally, firms would like to implement \tilde{p}_{ji} in every state of the world. This is, however, not feasible because of price stickiness, and firms preset prices in currency k to maximize their expected profits:⁴

$$\bar{p}_{ji}^k = \underset{p}{\operatorname{argmax}} \mathbb{E} \Pi_{ji}(p + e_{ik}).$$

²While the exchange rate regime is taken as exogenous in the model, Egorov and Mukhin (2021) show that there is a feedback with the optimal tightness of the peg to the dollar increasing in the share of DCP in country's imports.

³Because of constant returns to scale technology, marginal costs are independent of the quantity produced. Therefore, the profit function is separable across markets, and firms choose prices and currencies independently for each destination.

⁴I assume that profits are expressed in real discounted units, i.e. $\Pi_{ji}(\cdot)$ includes the stochastic discount factor (SDF). The variation in SDF does not affect the results under the approximation used below.

The optimal preset price equals the *expected* value of \tilde{p}_{ji} expressed in currency of invoicing k

$$\bar{p}_{ji}^k = \mathbb{E}[\tilde{p}_{ji} + e_{ki}]. \quad (9)$$

and allows firms to replicate the mean value of the optimal price. With the endogenous currency choice, firms can go one step further and target the second moment of \tilde{p}_{ji} :

Lemma 1 (Currency choice) *To the second-order approximation, the currency choice problem of the exporter is equivalent to choosing currency k , in which the optimal price $\tilde{p}_{ji} + e_{ki}$ is most stable:*

$$\max_{k \in [0,1]} \mathbb{E} \Pi_{ji}(\bar{p}_{ji}^k + e_{ik}) \quad \Leftrightarrow \quad \min_{k \in [0,1]} \mathbb{E} \left[\bar{p}_{ji}^k + e_{ik} - \tilde{p}_{ji} \right]^2 \quad \Leftrightarrow \quad \min_{k \in [0,1]} \text{var} [\tilde{p}_{ji} + e_{ki}]. \quad (10)$$

As the second expression makes clear, exporters choose currency k to mitigate the effect of sticky prices and to bring ex post price $\bar{p}_{ji}^k + e_{ik}$ closer to the optimal state-dependent value \tilde{p}_{ji} . Equivalently, it is optimal to use currency k , in which the optimal price $\tilde{p}_{ji} + e_{ki}$ is most stable.⁵

To give an example, if the optimal price is always \$100, then setting the price in dollars allows the firm to replicate \tilde{p}_{ji} in every state of the world. The choice is more nuanced when the optimal price is not fully stable in one currency, e.g. when \tilde{p}_{ji} can be expressed as \$50 + £50. As argued by [Corsetti and Pesenti \(2002\)](#), in this case, the firm would ideally like to set the price in terms of a basket of currencies.⁶ However, not only is there little empirical evidence for such pricing, but it also generates counterfactual predications at the aggregate level and makes the model inconsistent with the key stylized fact about the international price system:

Lemma 2 (Basket of currencies) *If firms could set prices in terms of baskets of currencies, then the share of DCP would not exceed the share of the U.S. in global trade.*

Intuitively, invoicing in baskets of currencies allows firms to reproduce their desired prices \tilde{p}_{ji} and the equilibrium is the same as under flexible prices. As discussed below, the currency shares in the optimal basket are then determined by the amount of intermediates and competing products produced in each country and the share of the dollar is bounded by the size of the U.S. economy. Therefore, I introduce the second key friction to the model on top of sticky prices, so that individual firms find it suboptimal to use baskets of currencies for invoicing and make discrete currency choices. In the spirit of [Mankiw \(1985\)](#), Lemma 1 ensures that small (second-order) fixed costs of adding currencies are sufficient to rationalize this assumption.

⁵Although Lemma 1 summarizes optimal currency choice in a compact form, solving minimization problem (10) is equivalent to a pairwise comparison of all currencies: currency k is preferred to currency h if the pass-through of bilateral exchange rate shocks e_{kh} into the desired price $\tilde{p}_{ji} + e_{ki}$ is low (see Proposition 2 in [Gopinath, Itskhoki, and Rigobon 2010](#)).

⁶Notice this is not the same as using mixed strategies (lotteries) across currencies. Moreover, the optimal currency basket is firm-specific and there is no one-size-fits-all solution like the Special Drawing Rights (SDR).

2.3 Equilibrium prices

Lemma 1 shows that firms' currency choice is determined by the properties of the desired price \tilde{p}_{ji} . A constant returns to scale technology and a homothetic demand ensure that equilibrium prices depend only on the supply side of the economy and can be analyzed separately from the quantities, which greatly simplifies the analysis. In contrast to the CES case, the Kimball demand generates strategic complementarities in price setting across firms, so that the optimal price of an exporter from j to i depends not only on its marginal costs but also on the prices of competitors in the destination market:

$$\tilde{p}_{ji} = (1 - \alpha)(mc_j + e_{ij}) + \alpha p_i, \quad (11)$$

where parameter α reflects the curvature of $\Phi(\cdot)$ and is different from demand elasticity.⁷ In the limit $\alpha \rightarrow 0$, the Kimball aggregator converges to the CES function and firms charge a constant markup, so that cost shocks are the only source of variation in the optimal price. The marginal costs of production in country i are a weighted sum of local wages w_i and prices of intermediates p_i :

$$mc_i = (1 - \phi)w_i + \phi p_i. \quad (12)$$

To the first-order approximation, the aggregate price index is the sum of the prices of locally produced goods p_{ii} and imported goods p_i^I with the weight of the former determined by the home bias $1 - \gamma$

$$p_i = (1 - \gamma)p_{ii} + \gamma p_i^I, \quad \text{where} \quad p_i^I = \int_0^1 p_{ji}^I dj, \quad (13)$$

while the bilateral price index combines the prices of adjusting and non-adjusting firms:⁸

$$p_{ji} = (1 - \lambda)\tilde{p}_{ji} + \lambda(\bar{p}_{ji}^k + e_{ik}). \quad (14)$$

A fraction $1 - \lambda$ of firms update prices after the realization of shocks and set them at the optimal level \tilde{p}_{ji} . The prices of other firms stay constant in the currency of invoicing k_{ji} , which means they move one-to-one with the exchange rate $e_{ik_{ji}}$ in the currency of the customers. It follows that the equilibrium price system is a fixed point with prices determined by firms' invoicing decisions and individual currency choices shaped by aggregate prices:

Definition 2 *Given $\{w_i, e_{ij}\}$, the equilibrium international price system consists of price indices $\{p_{ji}\}$ and firms' currency choices $\{k_{ji}\}$ such that: (a) given invoicing regime, $\{p_{ji}\}$ solve the system (11)-(14), (b) given prices, $\{k_{ji}\}$ solve problem (10).*

⁷An alternative way of generating complementarities in price setting is to assume decreasing returns to scale in production (see Goldberg and Tille 2008, Bacchetta and van Wincoop 2005). In this case, the optimal price depends on shifts in demand and hence, on prices of competing firms. Despite this isomorphism, the important advantage of the Kimball demand is that it allows to solve for prices and invoicing independently from quantities keeping the analysis more tractable.

⁸To simplify the notation, I assume that all exporters from j to i use the same currency of invoicing k . The results in Section 3, however, apply even under mixed strategies if not noted otherwise.

2.4 General equilibrium

Definition 2 implies that the only general equilibrium objects that matter for exporters' currency choices are the second moments of exchange rates and nominal wages. In the general case, there is also a feedback effect: the dynamics of w_i and e_{ij} depend on international prices, which in turn are shaped by the invoicing decisions of firms. This section shows, however, that under the assumptions made in the baseline model, exchange rates and nominal wages do not depend on the currency of invoicing, and therefore, the model attains a convenient block-recursive structure: one can solve for equilibrium currency choice taking the *relevant* general equilibrium moments as given.⁹

Lemma 3 (Exchange rates) *The second moments of equilibrium nominal wages and exchange rates are independent of the invoicing decisions of firms.*

The result follows from the combination of log-linear utility, complete asset markets and the monetary rule that targets nominal spending. Indeed, the labor supply condition implies that wages are equal to nominal spending $w_i = p_i + c_i$ and hence, are stabilized by the monetary policy, while international risk-sharing ensures that exchange rates depend only on financial shocks $e_{ij} = \psi_i - \psi_j$. The result from Lemma 3 holds more broadly and can be derived under the alternative set of assumptions. In particular, one can replace monetary policy that stabilizes nominal wages with the assumption that wages are sticky in domestic currency, while the assumption of complete asset markets can be relaxed to one internationally traded bond.

For future use, it is convenient to define a trade-weighted exchange rate of country i , which under symmetric trade flows is equal $e_i \equiv \frac{1}{1-n} \int_n^1 e_{ik} dk$. Any bilateral exchange rate can then be decomposed into country-specific components $e_{ij} = \frac{1}{1-n} \int_n^1 e_{ij} dk = \frac{1}{1-n} \int_n^1 e_{ik} dk - \frac{1}{1-n} \int_n^1 e_{jk} dk = e_i - e_j$. It follows from the structure of financial shocks that $e_i = \psi_i - \bar{\psi}$ and hence, the trade-weighted exchange rates are uncorrelated across economies.

3 Equilibrium Currency Choice

This section solves for the equilibrium currency choice and shows that the model is consistent with the key stylized facts about the international price system. In particular, I argue that exporters find it optimal to coordinate on a single vehicle currency, the dollar is a preferred candidate for the role of the dominant currency, and there is a path-dependence in currency choice explaining a delayed transition from the pound to the dollar.

⁹Notice this result does *not* mean that invoicing decisions of firms have no general equilibrium effects at all: consumption, output, exports and imports do change with the currency of invoicing even though wages and exchange rates do not.

Figure 1: Optimal price and the currency choice of an individual firm

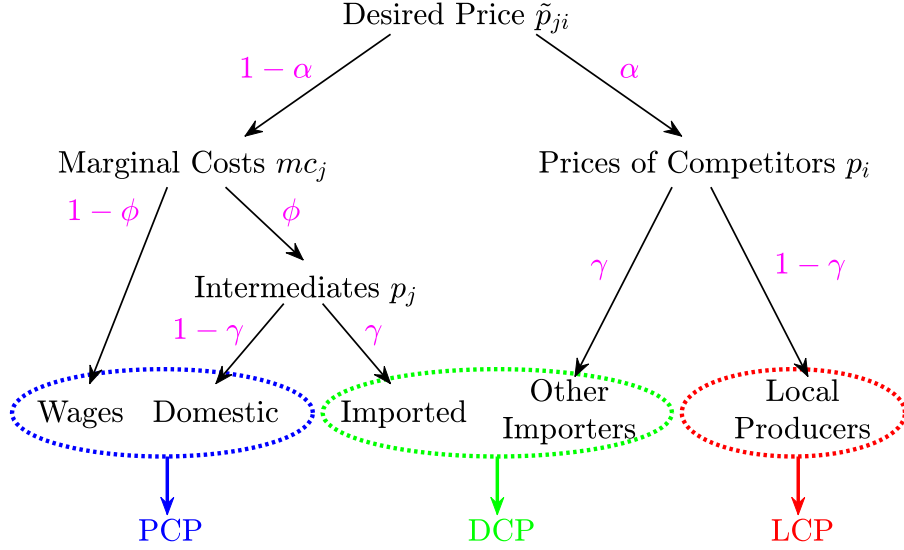

3.1 Why vehicle currency?

While it is intuitive that firms might set prices in producer or customer currency, it is not immediately clear why they would ever use a third currency for invoicing. In this section, I show that a vehicle currency equilibrium (VCP) can arise naturally when price linkages across exporters are strong enough. The question of *which* currency is used as a vehicle currency is discussed in the next section.

According to Lemma 1, the currency choice of an individual exporter from j to i depends on the properties of its desirable price \tilde{p}_{ji} , which in turn, is determined by the system of equilibrium conditions (11)-(14) summarized in Figure 1. Firms choose currency k , in which their optimal price is most stable:

$$\tilde{p}_{ji} + e_{ki} = e_k - (1 - \alpha)(e_j - \phi p_j) - \alpha(e_i - p_i). \quad (15)$$

To see the importance of price linkages between exporters for the VCP equilibrium, consider the currency choice in two limiting cases with no interactions between firms from different economies. First, assume the CES aggregator $\alpha = 0$ and no intermediates in production $\phi = 0$. With no price linkages across firms, the desired price $\tilde{p}_{ji} + e_{ki} = e_k - e_j$ is independent of prices and invoicing decisions of other exporters and is proportional to the nominal wage, which by assumption is stable in the domestic currency. It follows that the optimal price of the exporter is constant in the producer currency and PCP is always optimal, i.e. $k = j$. Second, consider the autarky limit $\gamma \rightarrow 0$, so that there are price linkages only between local firms. The aggregate prices in each country are then independent of exchange rate movements and are constant in local currency $p_i = 0$. With marginal costs stable in producer currency and the prices of competitors stable in local currency, the desired price is equal $\tilde{p}_{ji} + e_{ki} = e_k - (1 - \alpha)e_j - \alpha e_i$ and exporters choose PCP if $\alpha < 1/2$ and LCP if $\alpha > 1/2$, but never set prices in a vehicle currency.

These two special cases show that the price linkages between exporters from different countries are a *necessary* condition to sustain the vehicle currency pricing. The next proposition shows that the reverse is also true: the VCP equilibrium always exists as long as the share of foreign intermediates in production and/or the price complementarities across foreign firms are strong enough.¹⁰

Proposition 1 (Price linkages) *The region of the VCP equilibrium in parameter space is non-empty and is increasing in the openness of economies γ and the share of intermediates in production ϕ , and can be non-monotonic in price-setting complementarities α .*

Intuitively, when openness γ is high, so that a significant fraction of suppliers and competitors are coming from third countries, the optimal price \tilde{p}_{ji} of an exporter is no longer stable in either producer or local currency, and using a vehicle currency might be optimal. The prices of inputs and competing products that a given exporter faces in this case depend on the invoicing decisions of suppliers and competitors: in particular, if other firms set their prices in dollars, the optimal price of the exporter becomes more stable in dollars as well, making DCP more attractive. An important implication of this result, which will be further discussed in Section 4.3, is that the globalization of the last few decades – including the rising participation of Asian countries in global value chains and the integration of post-Soviet states in the global economy – might have strengthened the incentives of exporters to coordinate on a common currency to avoid undesirable movements in relative prices.

Proposition 1 also shows an important difference between parameters α and ϕ : even though both strengthen complementarities in currency choice, the price-setting complementarities tie the invoicing decisions of firms *within* a given market, while the input-output linkages generate complementarities *between* markets. As a result, a higher share of intermediates in production ϕ always makes VCP more attractive, while stronger price complementarities α can potentially benefit LCP rather than VCP. In general, the effect of price complementarities is non-monotonic: low α increases the share of producer currency in the optimal price, while high α increases the share of the local currency (see Figure 1). The chances of a vehicle currency are therefore, higher for intermediate values of α when neither producer nor local currency dominates in the desired price.

It is worth emphasizing that although Proposition 1 provides sufficient conditions for the existence of the VCP equilibrium, the uniqueness of an equilibrium is not guaranteed. Instead, the strong complementarities in currency choice that help to support VCP can also generate multiple equilibria despite unique optimal choice at the firm level. The next section shows, however, that DCP is not necessarily a sunspot equilibrium and there are *fundamental* factors that make firms choose dollar pricing.¹¹

¹⁰I use the following definition throughout the paper: the region of equilibrium Z in parameter space is said to be increasing in parameter x if for any $x_2 > x_1$ the set of (other) parameters for which Z exists under $x = x_2$ includes the set for which Z exists under $x = x_1$.

¹¹Section A.3.1 in the appendix provides additional results about the co-existence of the PCP, LCP, and DCP equilibria.

3.2 Why the dollar?

In order to disentangle the fundamental factors behind equilibrium invoicing from the complementarities in currency choice described above, I focus on the flexible-price limit $\lambda \rightarrow 0$, where all firms adjust prices ex-post, and therefore the invoicing decision of a given exporter does not depend on the currency choice of other firms and the equilibrium is always unique (see Lemma A1). Indeed, given no nominal frictions, the aggregate prices are independent of the currency of invoicing and can be found directly from equations (11)-(14):

$$p_i = \frac{\gamma}{1 - (1 - \gamma)\phi} (e_i - ne_0). \quad (16)$$

Consistent with Proposition 1, the pass-through of exchange rate shocks into aggregate prices is increasing in the economy's openness and in the intensity of the input-output linkages. At the same time, the currency choice is still well-defined given an arbitrarily small price stickiness: the invoicing decision of an exporter depends only on the states of the world in which prices remain unadjusted and is determined even when the probability of these states converges to zero. Substituting price indices (16) into the optimal currency choice (15), we get the necessary condition for dollar invoicing:

Lemma 4 (No-DCP benchmark) *Assume $\lambda \rightarrow 0$. If countries are symmetric, $n = 0$, $\rho = 1$, exporters choose PCP when $\alpha \leq \frac{1}{2-\gamma}$, LCP when $\alpha \geq \frac{1}{2-\gamma}$, and no DCP equilibrium exists.*

Intuitively, when prices are (almost) flexible, the weights of different exchange rates in the optimal price \tilde{p}_{ji} are determined solely by trade linkages. If countries are symmetric, $n = 0$, the market share of U.S. products is infinitely small and therefore, the weight of the dollar in the optimal price of exporters from other countries is trivial. The same applies to all other currencies except for producer and destination ones, which have a positive weight due to home bias. Given that all exchange rates have the same volatility, $\rho = 1$, firms unambiguously choose either PCP or LCP.

Consider next the case when the volatility of exchange rates is the same for all countries, $\rho = 1$, but the U.S. accounts for a non-trivial share of global trade, $n > 0$.¹² This implies that a positive fraction of inputs and competing products in small economies are coming from the U.S., and that the dollar has a positive weight in price index (16) and the optimal price \tilde{p}_{ji} of foreign exporters. As a result, the dollar is preferable to any other vehicle currency and depending on parameter values, firms choose PCP, LCP, or DCP in equilibrium. Figure 2a illustrates this result in the coordinates α and γ . Consistent with Proposition 1, exporters are more likely to set prices in producer (local) currency when complementarities in price setting are weak (strong), while a higher openness of the economies and a larger share of the U.S. in world trade increase the chances of the DCP equilibrium.

¹²Note that PCP, LCP and DCP coincide for trade flows between regions within the U.S.

Figure 2: Currency choice: flexible price limit

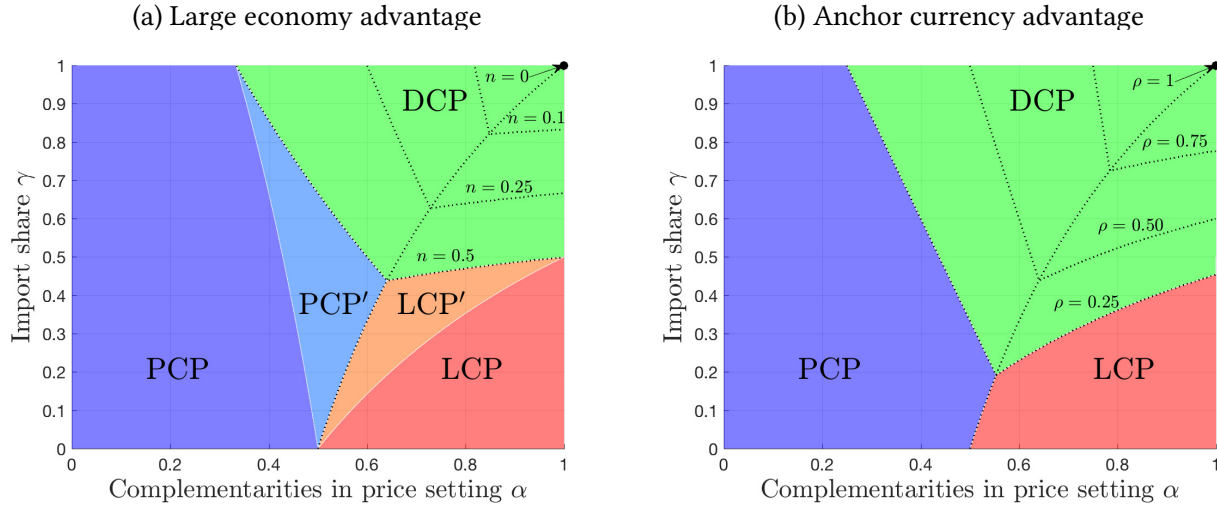

Note: the figure shows equilibria for $\lambda \rightarrow 0$, $\phi = 0.5$ and (a) $\rho = 1$, different values of n , (b) $n = 0$, different values of ρ . PCP' (LCP') denotes the region where small countries set prices in producer (local) currency when trading with each other and use dollars when trading with the U.S.

Proposition 2 (Large economy advantage) Assume $\lambda \rightarrow 0$. Then as long as the share of the U.S. economy in international trade is positive, $n > 0$, the region in the parameter space with DCP as a unique equilibrium is non-empty and increases as n goes up.

Figure 2a also shows that equilibria with asymmetric invoicing can arise when $n > 0$. In particular, firms might choose PCP when trading between small economies, but set prices in dollars when exporting to the U.S. This is because the home bias is larger in the U.S. than in other countries when $n > 0$, and more competitors in the U.S. market have prices stable in local currency. Similarly, exporters from the U.S. have a higher share of their marginal costs that are stable in their own currency and can choose DCP even when exporters from other economies prefer LCP.

Interestingly, the size of the U.S. economy is not the only fundamental advantage of the dollar. Even if countries are symmetric in terms of their size, $n = 0$, and the dollar exchange rate does not appear in foreign price indices (16), the DCP equilibrium may still emerge because of the lower volatility of the U.S. exchange rate, i.e. $\rho < 1$ (see Figure 2b). To see the benefits of DCP in this case, consider a limiting case with no home bias $\gamma \approx 1$ and strong complementarities in price setting $\alpha \approx 1$, so that the optimal price of a given firm depends only on prices of foreign competitors (see Figure 1). It follows that all exchange rates enter symmetrically into the optimal price \tilde{p}_{ji} and the firm would ideally like to set prices in terms of a fully diversified basket of currencies. This is, however, not feasible because of the discrete nature of the invoicing problem, and firms look for a currency that can most closely replicate this diversified portfolio. Since the dollar has the lowest idiosyncratic volatility, $\rho < 1$, it strictly dominates other alternatives. Away from this limit, there is a trade-off between producer/local currency and the dollar, but the DCP region still increases as ρ goes down.

Proposition 3 (Anchor currency advantage) *Assume $\lambda \rightarrow 0$. Then as long as the dollar has lower volatility than other currencies, $\rho < 1$, the region in the parameter space with DCP as a unique equilibrium is non-empty and, if $n \leq 1/2$, increases as ρ goes down.*

This result has several noteworthy implications. First, it shows that the relative volatilities of exchange rates are important even when they are not driven by nominal shocks (*cf.* Devereux, Engel, and Storgaard 2004), and that volatile currencies are unlikely to be widely used in international trade. Second, the result establishes an important linkage between, on the one hand the wide use of the dollar as an anchor currency in the exchange rate policies of emerging economies and, on the other hand the dominance of the dollar in international trade: a tighter peg of exchange rates to the dollar makes it a better substitute for other currencies and raises its odds of becoming the vehicle currency. Finally, notice the connection between Propositions 2 and 3: while parameter n reflects the total size of economies with a *hard peg* to the dollar, parameter ρ captures the tightness of *crawling pegs* to the dollar.

3.3 Transition

The previous sections show that both the fundamentals and the complementarities in currency choice contribute to the dominant status of the dollar in today's world. But what happens when the two factors work in the opposite directions and firms coordinate on a currency that is losing its fundamental advantages? This section discusses the transition from the pound sterling to the dollar during the twentieth century, while Section 4.6 below discusses the future of the dollar in the twenty first century.

To this end, I extend the model to have two large countries, the U.K. and the U.S., and a continuum of small economies (the RoW) (see Figure 3 and Appendix A.2 for details). The global economy starts from the point where the U.K. has a fundamental advantage in terms of economy size and/or the anchor status of its currency, which it loses during the transition path as the U.S. economy becomes larger and more countries switch to pegging their exchange rates to the dollar. I focus on the choice between the two potential dominant currencies and ignore the PCP and LCP alternatives. Importantly, I follow the previous literature (see e.g. Matsuyama, Kiyotaki, and Matsui 1993, Rey 2001) and make the assumption in the spirit of evolutionary game theory that as long as the old equilibrium exists, firms do not coordinate to jump into a new one.¹³

Corollary 1 (Transition) *Consider an increase in the relative size of the U.S. economy or a decrease in the relative volatility of its exchange rate. The share of the pound remains above one half even when the U.S. fundamentals become the same as in the U.K. The trade flows switch to the dollar in the following order: (1) between the U.S. and the RoW, (2) between the RoW countries and between the U.S. and the U.K., and (3) between the U.K. and the RoW.*

¹³Although a dynamic model with staggered pricing can be applied to select between "history" vs. "expectations", this the equilibrium remains non-unique (see e.g. Matsuyama 1991, Krugman 1991). Alternatively, one can use a global game approach (Morris and Shin 2001), but its application in dynamic settings is complex and goes beyond the scope of this paper.

Figure 3: Transition from one vehicle currency to another

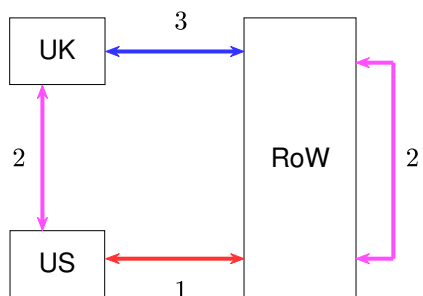

Note: the figure shows the order in which trade flows between countries switch from the pound to the dollar.

This result follows from Propositions 1-3 and illustrates the interplay between the fundamental determinants of currency choice and the strategic complementarities across firms. The latter implies that no firm wants to be the first to adopt the dollar. As a result, the pound remains the dominant currency even when the U.S. economy overtakes the U.K. economy in terms of size, and regarding the anchoring of exchange rates, which gives rise to path-dependence in equilibrium invoicing. Although the fixed costs of changing the currency would further strengthen the hysteresis, they are not necessary given the complementarities in invoicing. The flip side of this result is that the U.S. can potentially speed up the transition by forcing its own firms adopt the dollar, which due to price linkages, would make exporters from other countries more willing to abandon the pound.

The model also has clear predictions about the order in which trade flows switch from one currency to another. As can be seen from Figure 3, trade between the U.S. and small economies is the first to switch from the pound because of the prevalence of U.S. firms with costs stable in dollars. At the second stage, small economies start using the dollar as a vehicle currency when trading with one another, and trade flows between the two large economies also change the currency of invoicing. Finally, trade between the U.K. and small economies switches to the dollar as well. Interestingly, depending on the strength of complementarities in currency choice, there can be a full transition from the pound to the dollar or alternatively, the economy can end up in an equilibrium with multiple regional currencies: e.g. the dollar dominates in trade between the U.S. and small economies as well as across small economies, but the imports and exports of the U.K. remain invoiced in pounds.

These predictions are broadly consistent with historical evidence – the transition from the pound to the dollar was sluggish, followed with a lag after the U.S. overtook the U.K. as the largest economy, and was accelerated by the high volatility of the U.K. exchange rate after World War I (see Eichengreen 2011). While the invoicing data is scarce for most of the twentieth century, the recent experience of the Eurozone also fits the predictions of the model. In particular, the euro is more commonly used in trade between the Eurozone and developing countries, but much less so in trade with the U.S., and almost never as a vehicle currency (Kamps 2006).

4 Quantitative Analysis

This section shows that a straightforward extension of the analytical model described above can be taken to the data and be used for a rich quantitative analysis. To this end, I augment the baseline setup with staggered Calvo pricing, heterogeneous countries and sectors, calibrate the model using the global input-output table and exchange rate series, demonstrate a good fit of the model, and finally, do the counterfactual exercises about the future of the international price system.

4.1 Full Model

Although useful to build intuition, the baseline model is clearly too simplistic to be taken directly to the data. This section extends the setup in two directions — a general input-output matrix between countries and sectors, and richer dynamics of prices and exchange rates — briefly outlining the key new ingredients and relegating the details to Appendix B.1. Consider an infinite horizon model with N economies, S sectors (industries), and K currencies. For convenience, in most of the analysis below, I use subscripts j and i to denote respectively the countries of origin and destination, and superscripts r and s for the sectors of origin and destination. Index k is reserved for currency of invoicing. Firms are free to set different prices across markets with the latter defined by the type of good r (industry of production) and country of destination i .

Heterogeneity of trade flows between countries and sectors is important in two ways. On the one hand, it allows analysis of the cross-sectional variation in currency choice. On the other hand, it incorporates the granularity of international trade with the resulting values of γ in trade-intensive sectors much higher than the aggregate import-to-GDP ratio.

To allow for heterogeneous trade flows between countries and sectors, assume that the individual varieties are aggregated via a generalized Kimball aggregator:

$$\sum_{j=1}^N \gamma_{ji}^r \Upsilon \left(\frac{X_{jit}^r}{\gamma_{ji}^r X_{it}^r} \right) = 1,$$

where X_{jit}^r are the quantities sold by firms from country j and sector r in country i , and γ_{ji}^r are demand shifters that determine the steady-state trade shares and sum up to one, $\sum_{j=1}^N \gamma_{ji}^r = 1$. Similarly, the heterogeneity across sectors arises due to different input shares for labor ϕ_i^{Ls} and intermediate goods ϕ_i^{rs} in the Cobb-Douglas production function. The marginal costs in sector s of country i are equal

$$MC_{it}^s = \frac{1}{A_{it}^s} \left(W_{it} \right)^{\phi_i^{Ls}} \prod_{r=1}^S \left(P_{it}^r \right)^{\phi_i^{rs}},$$

where P_{it}^r is the aggregate price index in the market of good r in country i , and the sum of input shares is equal to one to ensure a constant returns to scale, $\phi_i^{Ls} + \sum_{r=1}^S \phi_i^{rs} = 1$.

Dynamics of the model feature a random-walk process for exchange rates, the Calvo price adjustment, and fixed costs of changing invoicing currency. On the household side, the optimal risk sharing under complete markets remains unchanged, hence the properties of exchange rates from Lemma 3 still apply. I assume that financial shocks ψ_{it} are martingales potentially correlated across countries and that a deterministic wage inflation chosen by the monetary policy is $\Delta m_{it} = \mu_i$. Consistent with the empirical evidence from Meese and Rogoff (1983), it follows that the vector of equilibrium exchange rates e_t follows a random walk process with drift μ and contemporaneous covariance matrix Σ across economies, $\Delta e_t \sim \text{i.i.d.}(\mu, \Sigma)$.

On the firm side, prices are assumed to adjust in a staggered way subject to the Calvo friction. This assumption allows me to calibrate the price stickiness in a conventional way and contrasts with the static setup, in which the value of λ depends on the period length and is not determinate. Leveraging the insights of Gopinath, Itskhoki, and Rigobon (2010), Cravino (2014) and Drenik and Perez (2021), Appendix B.1 solves for the optimal currency choice in dynamic setting with non-zero inflation.¹⁴

Proposition 4 (Calvo pricing) *The optimal currency choice k maximizes the following statistic:*

$$2(1 - \beta\lambda^r) \sum_{t=0}^{\infty} (\beta\lambda^r)^t \text{cov}(e_{it} - \tilde{p}_{jit}^r, \Delta e_{k0}) - \sigma_k^2 - \frac{1}{1 - \beta\lambda^r} \mu_k^2. \quad (17)$$

The formula generalizes the currency choice from Section 2.2, which can be nested as a special case when firms act myopically $\beta \rightarrow 0$ and inflation rates are zero $\mu_k = 0$. In contrast, as emphasized in the previous literature, what matters for invoicing in the dynamic setting is the medium-run pass-through, i.e. a discounted sum of intertemporal covariances between exchange rates and desired prices. The latter has complicated dynamics due to staggered price adjustment and can only be solved numerically. Consistent with the predictions of the one-period model, the second term of equation (17) indicates that firms are unlikely to use volatile currencies as a unit of account. Finally, the proposition adds inflation as a separate determinant of the currency choice that is only relevant in a dynamic model. Other things equal, a positive inflation in country i implies that the desired prices are growing in currency i and hence, it is optimal to set prices in other currencies in which the optimal price is more stable.

Finally, I allow for fixed costs τ of changing the currency of invoicing, i.e. an individual firm switches from one currency to another only if that increases statistic (17) by more than τ .¹⁵ Although similar to the menu costs, the motivation for this additional ingredient is quite different. As the analysis above shows, there are strategic complementarities and path-dependence in currency choice, even in the absence of any fixed costs. Instead, the main challenge is that invoicing decisions of firms are indeterminate in the limit of fixed exchange rates and are unstable in its neighbourhood. As a result, equilibrium currency choice can change abruptly in response to minor shocks when the volatility of

¹⁴The expression is isomorphic to the formula in Drenik and Perez (2021), but is derived for an arbitrary process \tilde{p}_{jit} rather than the one with a constant growth rate, which is important given the endogenous nature of \tilde{p}_{jit} in this setting.

¹⁵For simplicity, I assume that the fixed costs are paid in local currency and are a pure transfer to households.

exchange rates is low, e.g. under a “crawling peg”. The fixed costs ensure that firms change invoicing only in response to sufficiently large shifts in exchange rate regimes and can be interpreted as both costs of renegotiating contracts and rational inattention (Sims 2003, Mankiw and Reis 2002).

Simulation of the model is done in three steps. Although my main focus is on the current structure of the international price system, I capture the history-dependence of the currency choice by estimating the model sequentially for years 1995, 2005 and 2015 using equilibrium invoicing from the previous period as a starting point when solving for the new equilibrium. The choice of dates is constrained by the availability of the global input-output tables. Moreover, in the absence of historical data on currency choice, I have to make a crude assumption that all international prices are set in dollars before 1995. The aim is that it provides a reasonable approximation to the late Bretton-Woods period and plays a diminishing role for later periods. To simplify the analysis, it is assumed that domestic firms set prices in local currency, while exporters are allowed to choose between PCP, LCP and five potential vehicle currencies – the dollar, euro, pound, yen, and renminbi. Section 4.4 below relaxes all these restrictions and shows the robustness of the main results.

4.2 Data and calibration

This section briefly summarizes the main sources of data and the calibration strategy, while further details can be found in Appendix B.2. The parameters of the model are calibrated in three different ways. The values of the standard parameters are borrowed from the previous literature. The two main inputs of the quantitative model – the country-sector trade flows (γ, ϕ) and the exchange rate moments (μ, Σ) – are estimated directly from the data. Finally, the only targeted invoicing moment is the aggregate share of DCP in 1995 that is used to calibrate the fixed costs of currency adjustment.

Following most of the literature, the monthly discount factor is equal $\beta = 0.96^{\frac{1}{12}}$. I use the estimates of price adjustment frequencies from Nakamura and Steinsson (2008) to calibrate λ^r at the sectoral level (see Table A1). The elasticity of strategic complementarities in price setting α^r is calibrated following the estimates for large firms that account for most of international trade from Amiti, Itskhoki, and Konings (2019). Given scarce evidence on the cross-industry variation in α^r , I use the same value of 0.5 for all sectors in manufacturing and services, but a much higher value of 0.99 for commodities in order to capture the price-taking behavior of firms in these sectors.

The main source of trade shares is the OECD inter-country input-output (ICIO) table widely used in international trade literature. After making the tables consistent across years, the sample includes $N = 63$ countries (including all OECD economies, the European Union, most East Asian countries plus the RoW) and $S = 32$ two-digit ISIC industries (including 2 commodity sectors, 16 manufacturing industries, and 14 sectors in services). The database has a good coverage with only 2% of international trade accounted for by the within RoW flows that are not observed separately from the domestic flows

of these economies.

The ISIC table is adjusted in several ways to bridge the gap between the model and the data. Following the model that defines markets at the country-good level, I eliminate the variation in γ_{ji}^{rs} across importing sectors s . The adjusted input-output matrix matches the original cross-country trade flows and sectoral input shares, but is different in terms of sector-to-sector flows. To capture the fact that prices of most commodities are determined at a global level with relatively little variation across countries, I assume one international market for each commodity, in which the worldwide price of the corresponding good is determined. Finally, because ICIO tables do not report labor costs, one needs to adjust total value added by firms' profits. To this end, I use the estimates of markups for Compustat firms from [Baqae and Farhi \(2020\)](#), which I aggregate to the sectoral level, average across years, and extrapolate to all economies and periods.

The covariance matrix of exchange rates is computed using monthly series of bilateral exchange rates from the IMF IFS database. Given almost no variation in their exchange rates, Saudi Arabia and Hong Kong are assumed to have a hard peg to the dollar and all members of the Eurozone have a hard peg to the euro. Motivated by the fact that out of 124 countries not included in ICIO tables, less than 1% have a free floating exchange rate ([Ilzetzi, Reinhart, and Rogoff 2019](#)), I construct the exchange rate for the RoW as a weighted-average of dollar and euro exchange rates. Finally, given the limited availability of wage-based inflation rates, parameter μ_i is estimated as an average of the CPI inflation and exchange rate depreciation in each economy (see Table A2). I use a fifteen-year window before 1995, 2005 and 2015 to estimating the corresponding exchange rate and inflation moments assuming they provide an accurate approximation to agents' expectations about the near future.

As mentioned above, the fixed costs of currency adjustment are introduced to avoid large swings in invoicing when countries switch between floating and pegged exchange rates. As a result, the switching between currencies — both in sample and in the counterfactual analysis — depends crucially on the value of this parameter. Given little empirical guidance on the size of these adjustment costs, I adopt two calibration strategies. First, starting with micro evidence, I assume that the fixed costs of changing the currency are equal to the standard menu costs of price adjustment. Using the estimates from [Nakamura and Steinsson \(2010\)](#), [Goloso and Lucas \(2007\)](#), [Levy, Bergen, Dutta, and Venable \(1997\)](#) that firms spend about 0.5% of their revenues on menu costs, I get $\tau = 0.5 - 1 \cdot 10^{-4}$. Second, I directly target invoicing moments and calibrate fixed costs to match the share of DCP in 1995 for a subsample of countries with available data. Given the initial guess that all international trade is invoiced in dollars, the share of DCP is monotonically decreasing in τ and provides a good identification. This approach leads to a similar estimate and I adopt $\tau = 0.8 \cdot 10^{-4}$ as the baseline value of fixed costs.¹⁶

I use the IMF dataset compiled by [Georgiadis, Le Mezo, Mehl, Casas, Boz, Nguyen, and Gopinath \(2020\)](#), which provides annual shares of exports and imports invoiced in dollars, euros, and home currencies for more than 100 economies over the period from 1990–2020. I focus on three-year averages

¹⁶The main results do not change much as long as τ stays within the range $0.5 - 1.2 \cdot 10^{-4}$.

as a benchmark, but given the large number of missing values, I increase the window to five years for some economies. This allows me to get invoicing shares for about 63% of global trade in 2015 with the main limitation being the absence of data for China. Because most numbers come from customs authorities and cover only merchandise trade, I compare empirical values with model-implied invoicing for manufacturing and commodities, excluding service sectors.¹⁷ I complement this country-level data with the bilateral and sectoral invoicing for Switzerland in 2015 (Bonadio, Fischer, and Sauré 2020).

4.3 Descriptive evidence

Before proceeding to the structural results, I present a first look at the raw data and summarize the main empirical facts about trade flows (γ, ϕ) and exchange rates (μ, Σ) . The objective is to visualize the main inputs of the quantitative model and to evaluate the role of four determinants of the DCP equilibrium from Propositions 1-4: high inflation and tight trade linkages in shaping demand for a vehicle currency, and the large-economy and the anchor-currency advantages of the U.S. in making the dollar the top candidate for this role. A reader more interested in the predictions of the structural model can proceed directly to Section 4.4.

Starting with the implications of Proposition 4, the much-studied hyperinflation in Latin American countries in the 1980s and in Eastern Europe in the 1990s, as well as a relatively high inflation in most East Asian economies in the same time period, imply that the currencies of the vast majority of economies in 1995 were hardly suitable for invoicing and that exporters from these countries were looking for a vehicle currency to be used in international trade (see Figure A4 and Table A2). Comparing these patterns with the later period, one can see that despite a substantial decrease in inflation rates across-the-board in the 2000s, most emerging economies — with the notable exception of China — still exhibit significantly higher inflation rates than developed countries. This presumably lowered the global demand for a vehicle currency and increased the number of potential candidates for this role relative to earlier decades, even though for many economies, inflation still generates strong incentives to use foreign currency in international trade.

Fact 1 (Inflation) *The median inflation rate across emerging economies was 16.8% in the 1980-90s and went down to 2.7% in the 2000s against 0.7% in developed economies.*

This negative trend in inflation was, however, largely offset by the rising openness of economies that, according to Proposition 1, helped to sustain the dominant currency equilibrium. To show this, I use the flexible-price version of the model to compute the pass-through of exchange rates into aggregate prices.¹⁸ The only input in this exercise is the global input-output table, which allows to estimate

¹⁷That said, the currency shares for some countries are inferred from settlement data collected by central banks, which includes trade in services and can potentially be one source of discrepancy between the model and the data.

¹⁸Relative to this flexible-price benchmark, the equilibrium pass-through in a full structural model can be either higher due to import prices being sticky in foreign currency or lower due to local and import prices being sticky in home currency.

the shares of labor from different countries in the aggregate basket of good r sold in country i . These estimates allow to express prices in terms of labor costs across countries and are equivalent to the pass-through of country-specific exchange rates e_{it} . In particular, the pass-through of a home currency shows how much domestic prices change in terms of foreign units when the local exchange rate depreciates against all other currencies and is a convenient way to measure the openness of the economy: it is equal one for closed economies and zero in the limit with no home bias. I focus on manufacturing goods and use imports as weights to aggregate the pass-through coefficients across markets.¹⁹

Figure 4 shows the results. As can be seen from the first panel, there is a large heterogeneity in openness across countries with the average content of home currency ranging in 2015 from less than 20% for small East Asian and East European economies, to more than 50% for large economies of the U.S., Japan, China and the Eurozone (see also Table A3). On average, the share of local currency among non-large economies is about 30% leaving enough room for a foreign dominant currency. Moreover, the openness of the economies has substantially increased over the last decades. The left panel of Figure 5 shows that while expected, the average share of domestic currency went up between 1995-2015 for countries that joined the Eurozone, it went down for almost all other economies. The differences are quantitatively large, including the change from 78% to 56% in Japan. Thus, the increase in the openness of economies has largely counteracted the fall in inflation in emerging economies discussed above, and has helped to sustain demand for a vehicle currency in international trade.

Fact 2 (Price linkages) *The average pass-through of home currency in prices is about 30% for small economies and 55% for the U.S., the Eurozone, Japan, and China.*

Turing next to the two fundamental advantages of the U.S., Figures 4b and 4c show the import-weighted pass-through of the euro and the dollar exchange rates into the prices of manufacturing goods across economies. While the euro share is above 30% for European countries trading actively with the Eurozone, the numbers are close to zero for other economies, suggesting that the euro is more likely to be a regional currency rather than a global one. In contrast, the dollar share is high not only for Canada and Mexico – the two countries with the most intense trade linkages with the U.S. – but also for Latin American and Asian countries. Aggregating across all economies other than the issuer of the respective currency, the import-weighted average pass-through is 11% for the euro and 21% for the dollar. Given a tight peg of the renminbi to the dollar over most of the period, a more relevant statistic for currency choice might be a combined pass-through of the two currencies, which reaches 33% at the global level (see Figure 4d). This ensures that in most markets, the dollar ranks as the top foreign currency and often surpasses the home currency. The second panel of Figure 5 shows that this dominance has only strengthened over the last decades as the combined share of the dollar and the renminbi went up for every singly country in the sample, including the Eurozone economies. The total share has almost doubled with the renminbi contributing two thirds of this growth. At the same time,

¹⁹The results are similar for the currency content of exports as shown in Table A4, Figures A5 and A6 in the appendix.

Figure 4: Pass-through into domestic prices

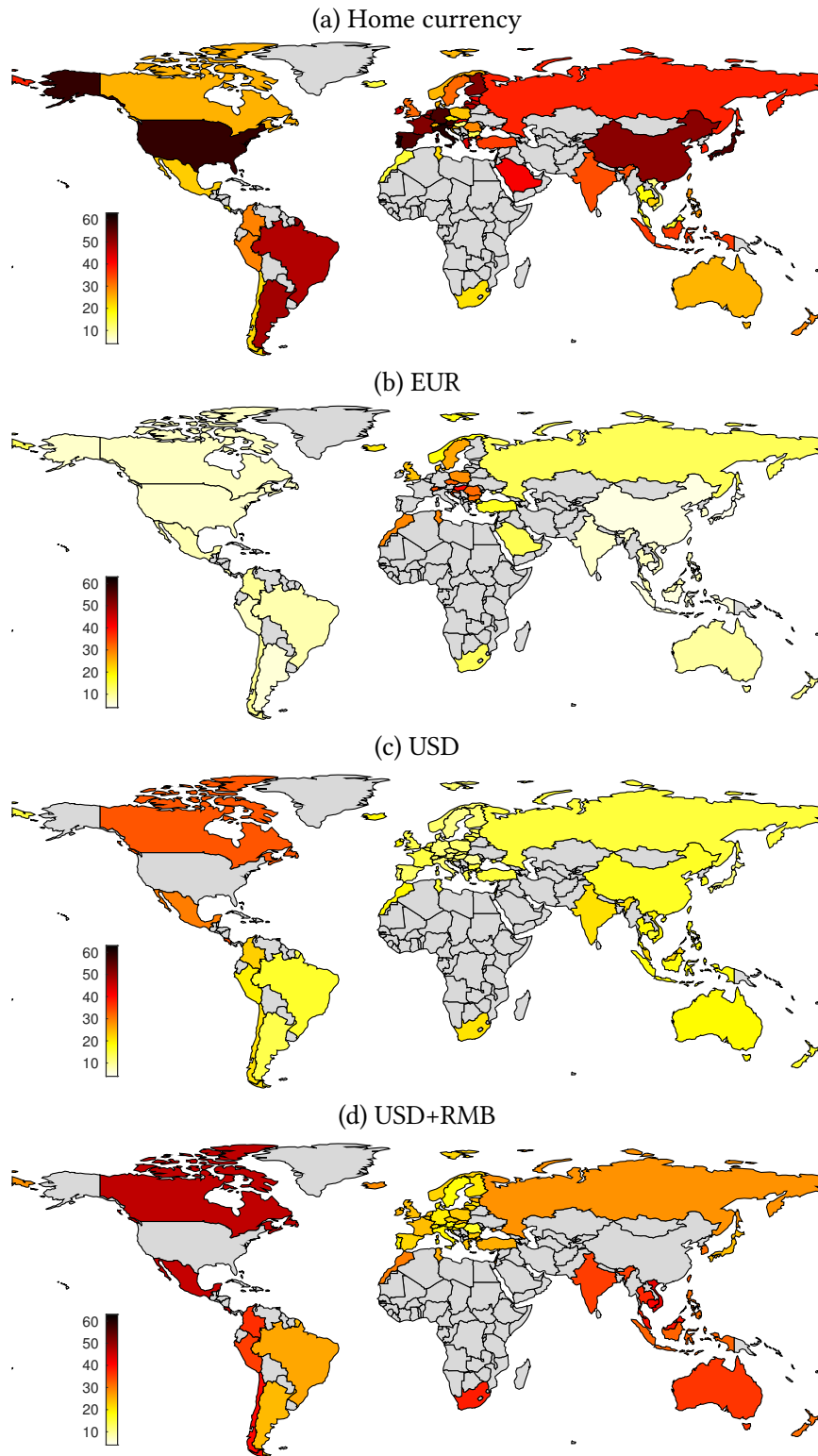

Note: the figure shows the pass-through (%) of home currency, euro, dollar and a combination of dollar and renminbi exchange rates into domestic prices in 2015. All values are computed taking into account the global input-output linkages, are aggregated across markets using imports as weights, and include only markets of manufacturing goods.

Figure 5: Pass-through into domestic prices: 1995 vs. 2015

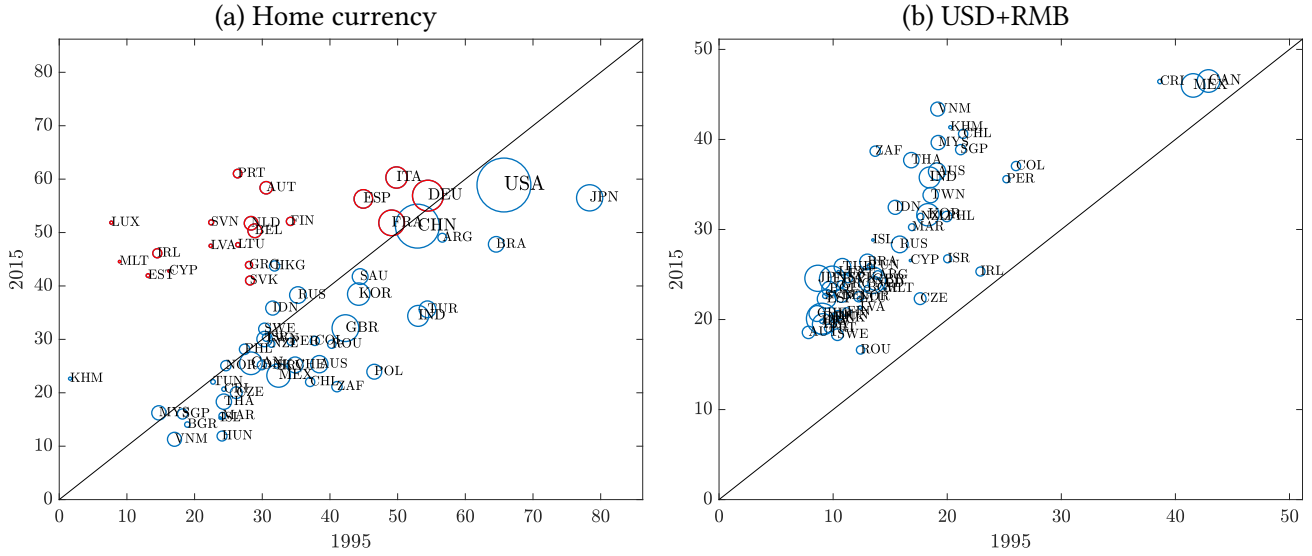

Note: the figure compares the pass-through of exchange rates from Figure 4 with counterparts estimated for 1995. The size of each circle represents a country's share in world imports. The members of the Eurozone are shown in red in panel (a).

the share of the dollar remains twice as large as the share of the renminbi because of the contribution of the RoW, which is mostly pegged to the dollar.

Fact 3 (Large economy advantage) *Between 1995 and 2015, the average pass-through of the dollar in prices went up from 16% to 21% and the pass-through of the renminbi increased from 2% to 12%.*

Finally, to evaluate the role of the anchor currency advantage, I turn to the sufficient statistic from Proposition 4 and focus on the limit of static economy $\beta \rightarrow 0$ with no inflation $\mu_i = 0$. I define the pass-through coefficients into desired prices of exporters, such that $\tilde{p}_{ji}^r - e_i = -\sum_m \chi_{ji}^r(m) e_m$ and note that $\sum_m \chi_{ji}^r(m) = 1$. It follows that the currency choice statistic (17) can be rewritten as

$$2\text{cov}(e_i - \tilde{p}_{ji}^r, e_k) - \sigma_k^2 = 2 \sum_m \chi_{ji}^r(m) \text{cov}(e_m, e_k) - \sigma_k^2 = \sum_m \chi_{ji}^r(m) \left(2\text{cov}(e_m, e_k) - \sigma_k^2 \right).$$

Without taking a stand on the values of $\chi_{ji}^r(m)$, which depend on the trade flows and currency choices of other firms, one can ask the following hypothetical question: What vehicle currency will a firm choose if it does not want to use currency m for invoicing – because of either high inflation μ_m or a low share of currency m in desired price $\chi_{ji}^r(m)$ – and is looking for the closest substitute k that maximizes $2\text{cov}(e_m, e_k) - \sigma_k^2$? Clearly, if a single currency k turns out to be a good substitute for a large number of currencies, it has a better chance of becoming the dominant currency in international trade. For simplicity, I do this exercise allowing firms to choose only among five potential vehicle currencies and show the results in Figure 6, where each country on a map corresponds to currency m and the colours show the best choice k .

Figure 6: Best substitution currency

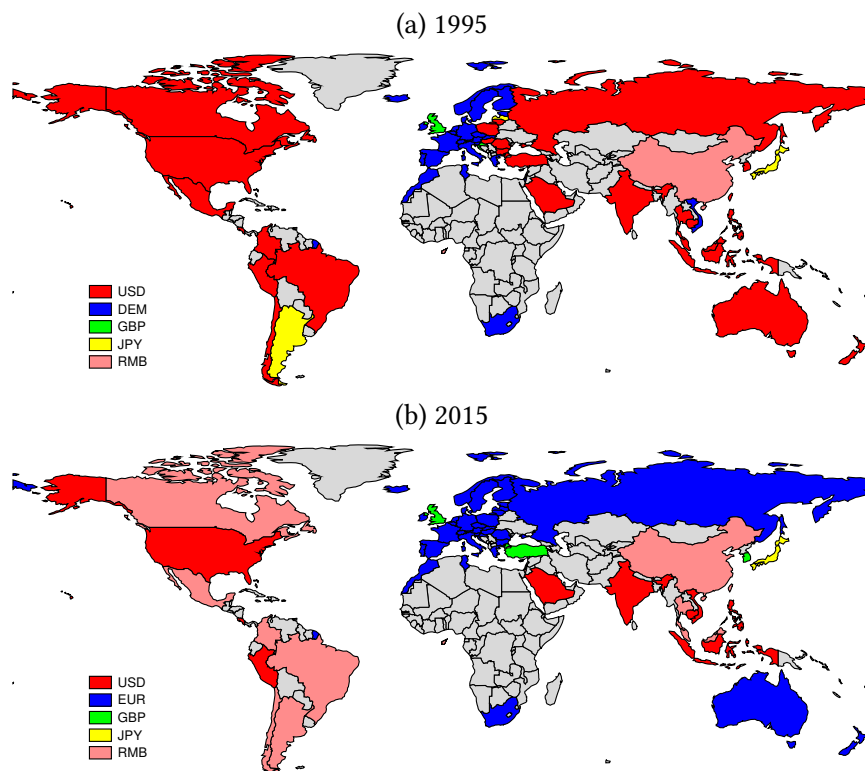

Note: for currency m of each country, the figure shows the best substitute k among five potential vehicle currencies with the highest value of $2\text{cov}(e_m, e_k) - \sigma_k^2$. The panels report results for two periods from 1981–1995 and from 2001–2015.

The first thing to notice from this picture, is that the dollar is the best substitute for the vast majority of currencies in 1995, with the only exception being Western European currencies that have the German mark as the closest substitute.²⁰ Almost no currency is paired with the pound, yen or the renminbi in this period.²¹ The position of the dollar is more ambiguous in 2015 as can be seen from the second panel of Figure 6. On the one hand, it loses its dominance among Eastern European currencies to the euro and its position among several Latin American and East Asian currencies to renminbi. On the other hand, if one excludes the renminbi from the set of potential vehicle currencies, given its tight peg to the dollar over this period, the position of the dollar is even stronger in 2015 than in 1995. The expansion of China also explains a falling trade-weighted share of the euro despite an increase in the number of countries pegging to the currency.

Fact 4 (Anchor currency advantage) *Between 1995 and 2015, the trade-weighted share of countries with the corresponding currency as a best substitute went down from 44% to 26% for the dollar, up from 2% to 29% for the renminbi, and down from 41% to 32% for the euro.*

²⁰This result echoes the findings of Ilzetzi, Reinhart, and Rogoff (2019) that most countries peg their exchange rates to the dollar, although the sufficient statistic for currency choice is different from the one used in their classification and does not depend on whether the comovement of the exchange rates is driven by a monetary policy or non-monetary shocks.

²¹The fact that the Argentinian peso is substituted for yen is driven by a few large depreciations of the former and is not robust to the exclusion of these outliers.

Table 1: Currencies in world trade

	Trade share	Baseline model	Robustness					
			include services	any VCP	domestic invoicing	zero inflation	initial invoicing	flexible prices
	(1)	(2)	(3)	(4)	(5)	(6)	(7)	(8)
USD	22.6	64.7	60.3	63.6	64.7	61.1	58.8	65.2
EUR	20.9	21.7	24.9	21.2	21.7	18.2	26.0	23.8
RMB	14.2	0.7	0.6	0.8	0.7	1.6	0.9	1.1
GBP	3.1	1.3	1.7	1.2	1.3	1.8	1.3	1.1
JPY	4.3	2.4	2.4	2.4	2.4	4.1	5.0	4.1
Other AE	14.0	5.2	6.5	7.0	5.2	6.1	4.3	2.9
Other EM	20.9	4.0	3.5	3.8	4.0	7.1	3.7	1.7

Note: column 1 shows the percent of world trade accounted for by countries with the corresponding currency, column 2 shows the fraction of world trade invoiced in a given currency, column 3 reports invoicing shares for all sectors including services, in column 4 exporters choose between 13 vehicle currencies, in column 5 domestic firms optimally choose the currency, column 6 assumes $\mu_k = 0$ in all countries, column 7 uses initial invoicing based on [Ilzetzi, Reinhart, and Rogoff \(2019\)](#) classification, column 8 assumes $\lambda^r \rightarrow 0$ for all sectors. In each case, the model is reestimated for all periods. Advanced economies (AE) are defined according to the IMF classification and emerging economies (EM) include the RoW.

4.4 Model's fit

While the previous section provides suggestive evidence about fundamentals that can support the DCP equilibrium, the strategic interactions between firms imply that it is not possible to accurately predict currency choice without a full structural model. Next, I combine together all ingredients in a calibrated version of the model and show that it can quantitatively replicate the key empirical facts about global use of currencies, the cross-sectional variation, and the evolution of invoicing in time.

Starting with the aggregate predictions of the model, column 2 of Table 1 reports the share of international trade invoiced in the dollar, euro, renminbi, British pound, yen, and in the remaining currencies of advanced and emerging economies. The dollar clearly emerges as the dominant currency with almost two thirds of global trade invoiced in the U.S. currency. It is followed by the euro, which accounts for another 22% of international flows, while the share of any other currency in world trade does not exceed 2.5%. To dissect the *optimal* currency choice from purely mechanical effects, it is worth comparing these numbers with the shares of the corresponding countries in world trade reported in column 1 of the table: the share of DCP is three times larger than the total trade share of countries with a hard peg to the dollar (including most of the RoW). In this sense, the relative size of economies can only explain about one third of DCP in world trade with the remaining use of the dollar arising endogenously. In contrast, the percentage of international prices set in euros is very close to the contribution of the Eurozone to global trade and the use of other currencies is disproportionately smaller than the trade share of their issuers. Note that although the difference is especially large for emerging economies, it is also significant for all advanced economies, including the pound, which served as the main vehicle

Figure 7: Global exports and invoicing

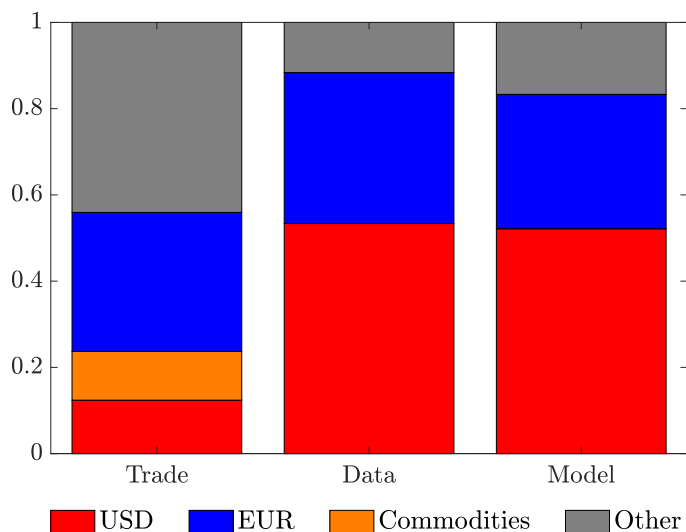

Note: ‘Trade’ bars show the share of commodity trade and the share of non-commodity trade with dollarized and euroized economies in world exports. ‘Data’ and ‘Model’ bars show respectively the empirical and model-implied fraction of exports invoiced in dollars and euros. All numbers are computed for a subsample of countries with available invoicing data.

currency before the dollar.

To confront the model predictions with the data, I next look at a subsample of countries, for which invoicing data is available. Figure 7 replicates the plot from [Georgiadis, Le Mezo, Mehl, Casas, Boz, Nguyen, and Gopinath \(2020\)](#) showing in the first two bars the share of dollarized and euroized economies and their currencies in total exports of countries in the subsample.²² As emphasized by [Gopinath \(2016\)](#), the invoicing share of the dollar (53%) is disproportionately large relative to its trade share (12%). Importantly, this pattern cannot be attributed solely to the dollar invoicing of commodities: the share of the dollar is about 2.3 times larger than the combined share of dollarized economies and commodity trade between other countries. The third bar of the plot shows that the model replicates closely these empirical facts with the global share of DCP equal to 52% against 53% in the data and the share of ECP equal to 31% against 35% in the data.

Given a good fit at the global level, one can go one step further and ask whether the model is also consistent with the cross-country variation in invoicing. Focusing again on economies with available data, Figure 8a presents a scatter plot of empirical and simulated shares of DCP in imports across countries (see also Figure A8 and Table A5 in the appendix). The figure shows that there is substantial variation in the use of the dollar across economies in the data: e.g. the dollar share is around 20% in Germany, 40% in the U.K., 70% in Japan, 90% in India, and 100% in the U.S. This heterogeneity is well captured by the model as indicated by the fact that most observations lie close to the 45-degree line. In particular, the model reproduces a low share of DCP in the Eurozone countries and a high share in the

²²The results for imports are similar and are shown in Figure A7 in the appendix.

Figure 8: Cross-country import currency shares: model vs. data

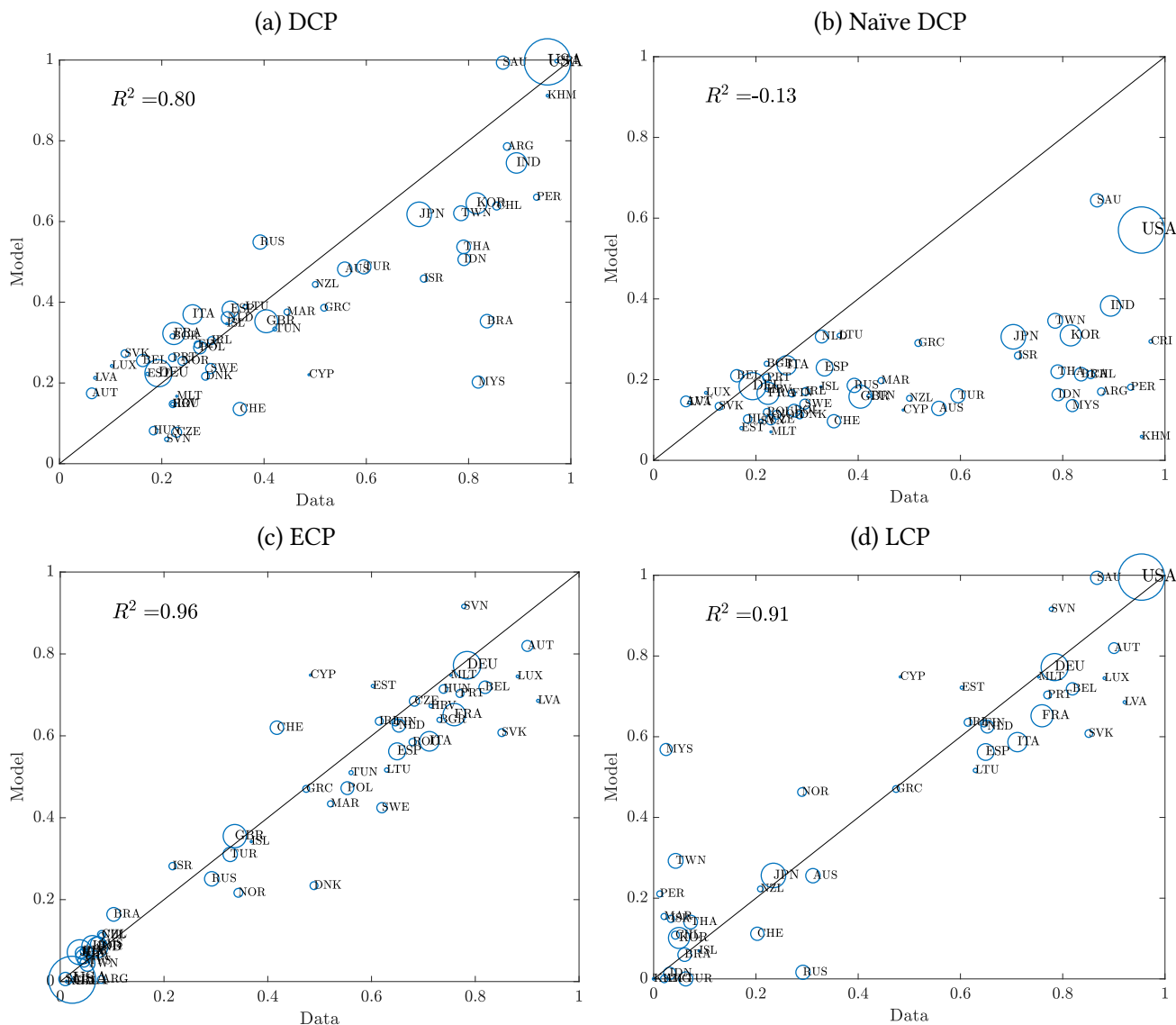

Note: panels (a), (c) and (d) show empirical and model-implied shares of DCP, ECP and LCP in imports. Panel (b) shows a counterfactual share of DCP in imports if commodities were invoiced in dollars and invoicing of other goods were split equally between currencies of the buyer and the seller. The size of circles is proportional to country's share in world imports.

U.S. and most developing economies. Perhaps most surprisingly, it also rationalizes the widespread use of the dollar in such advanced economies as Japan, Korea, New Zealand, and the U.K. A good cross-country fit of the model is not limited to DCP and, as can be seen from Figures 8c and 8d, also extends to the use of the euro and local currencies in international trade.

To measure the goodness of fit more formally, I use the fraction of (trade-weighted) cross-country dispersion explained by the model, i.e. $R^2 \equiv 1 - \frac{\sum_i \omega_i (\pi_i - \hat{\pi}_i)^2}{\sum_i \omega_i (\pi_i - \bar{\pi})^2}$, where ω_i is the share of country i in world imports, π_i and $\hat{\pi}_i$ are respectively empirical and simulated shares of a given currency in imports of country i , and $\bar{\pi}$ is a weighted-average share in the data. Note that the statistic is equal to one when

Figure 9: Currency shares in Switzerland by sector: model vs. data

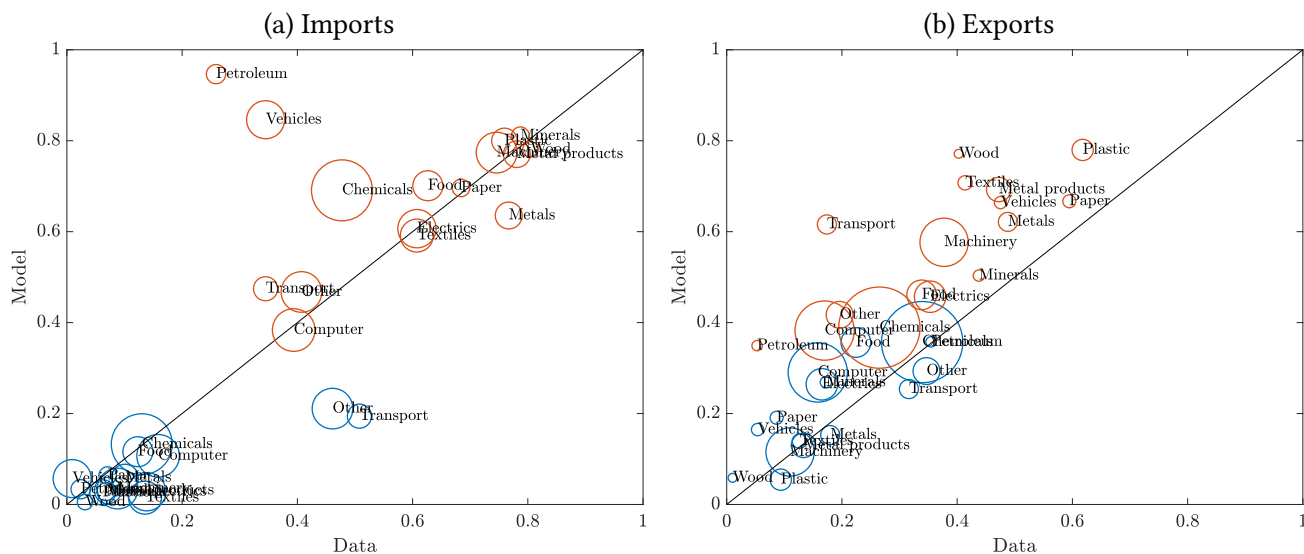

Note: the figure shows the share of DCP (blue) and ECP (red) in imports and exports of Switzerland by sector. The size of circles is proportional to sector's share in country's trade.

the model perfectly matches the data $\hat{\pi}_i = \pi_i$ and converges to zero when the model can only explain the global use of currencies, but not the cross-country variation $\hat{\pi}_i = \bar{\pi}$. As can be seen in Figure 8, the statistic is equal $R^2 = 0.80$ for the dollar, $R^2 = 0.96$ for the euro, and $R^2 = 0.91$ for local currencies – a surprisingly good fit, especially given the amount of noise in the data. To put these numbers in perspective, consider a “naïve invoicing” when all commodity prices are set in dollars and the prices in non-commodity sectors are split in half between the currency of the seller and the currency of the buyer.²³ Figure 8b shows that in contrast to the structural model, the naïve invoicing substantially underestimates both the global use of the dollar and its variation across countries with the DCP share staying between 10 – 40% for all non-dollarized economies and the resulting R^2 being negative.

Going a step further, I complement these cross-country results with the invoicing patterns between different sectors. Since such data is not available at the global level, I focus instead on one individual economy – Switzerland – with a substantial use of home currency, DCP, and ECP and a large variation in invoicing across sectors. Figure 9 compares the empirical and model-implied shares of DCP and ECP in imports and exports across manufacturing sectors with the remaining trade in each industry mostly invoiced in Swiss francs. Even at this granular level when one controls for the country of origin or destination, the fit of the model is quite good. Although overestimating the average share of the euro in exports, the model reproduces well the ranking of sectors in their use of dollars and euros, including a higher share of DCP in exports of food, chemicals, and petroleum and a higher share of ECP in exports of vehicles, paper, and plastics. Of course, the model's performance deteriorates as

²³Notice this is a conservative benchmark as it takes for granted the dollar invoicing of commodities. Instead, this is an endogenous outcome in the model.

Figure 10: Evolution of DCP in exports of selected economies

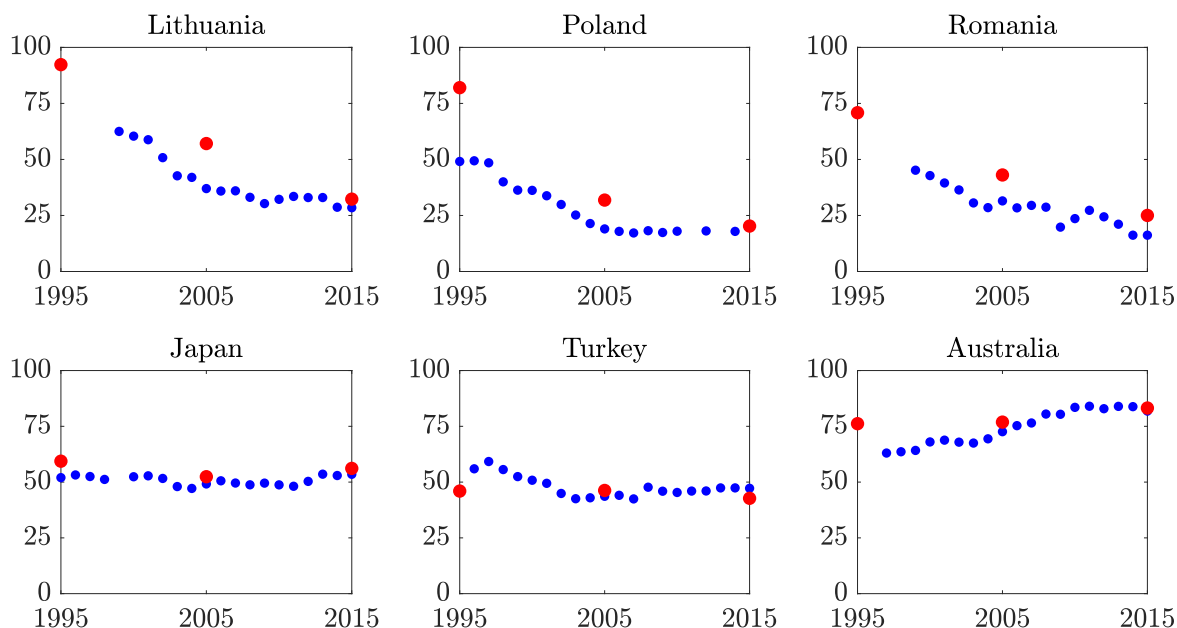

Note: the figure shows the evolution of empirical (blue) and simulated (red) DCP shares (in %) in countries' exports.

one looks at a more granular level, since by construction, the currency choice is the same for all firms within a sector-exporter-importer triplet.²⁴ More disaggregated data on trade flows is required to make progress in this direction.

Finally, moving to the time dimension, one of the key properties of the international prices system is the stability of invoicing patterns (Gopinath 2016). The fixed costs of changing a currency and the complementarities in currency choice allow the model to reproduce this fact. The simulated share of DCP is stable not only at the global level (see Figure A10 in the appendix), but also at the country level. Focusing on the evolution of export invoicing between 2005 and 2015, the cross-country median absolute change in the DCP (ECP) share is 3.6% (3.2%) in the model against 3.5% (2.9%) in the data.²⁵ The model also matches well the fraction of countries with a rising share of ECP in exports (47% against 50% in the data), but underpredicts the number of countries with a growing share of DCP (36% against 52% in the data). At the same time, as emphasized by Georgiadis, Le Mezo, Mehl, Casas, Boz, Nguyen, and Gopinath (2020), there are a few countries with substantial changes in invoicing between 1995 and 2015. The upper panel of Figure 10 illustrates this point by showing the evolution of the dollar share in exports of selected economies with a good data coverage. Both in the data and in the model, there is a negative trend among European countries that either joined the euro area or had strong trade linkages

²⁴Decomposing the variance of simulated invoicing in international trade, one gets that the countries of origin and destination account each for about 47% of the total variation, while sectors explain the remaining 5%. Figure A9 in the appendix illustrates this result by showing the use of currencies across countries in their trade with Switzerland.

²⁵I focus on the period from 2005–2015 because of a better data coverage and a lower sensitivity to the pre-1995 invoicing. The trade-weighted means are close to the medians. See Figure A11 in the appendix for the cross-country evidence.

with euro economies.²⁶ On the other hand, the figure shows the model also matches a stable DCP share in Japan and Turkey, and a moderate positive trend in Australia driven by country's trade with China.

4.5 Discussion

Having established a good empirical fit of the model, it is worth discussing in greater detail the mechanisms that sustain the DCP equilibrium. This section studies the currency choice under alternative values of parameters and shows the robustness of the main findings.

Addressing the fact that empirical invoicing shares of some countries include not only merchandise trade, but also the trade in services, column 3 of Table 1 reports the global use of currencies across all sectors. Because of a larger share of the Eurozone and the U.K. in services, the use of their currencies is slightly higher in this case. The share of the dollar, on the other hand, goes down. This is expected given the larger role of PCP and LCP in service sectors: according to the model, a stronger home bias and a lower share of foreign intermediates in these sectors implies that the third currencies account for about 76% of world trade in commodities, 32% in manufacturing, and only 20% in services (see Table A6 for details). Yet, the dollar remains the dominant currency with a global share above 60%.

The next column of the table relaxes the assumption that exporters can choose from five vehicle currencies and in addition, allows them to set prices in the currencies of Switzerland, South Korea, Norway, Sweden, New Zealand, Australia, Canada, and South Africa.²⁷ Although, expectedly, this increases the share of currencies of advanced economies, the changes are quantitatively small. In particular, the DCP share falls from 64.7% to 63.7% indicating that given the starting conditions and the fundamentals, there is little scope for other vehicle currencies in international trade.²⁸

I then consider the case when both exporters and domestic firms can optimally choose the currency of invoicing. Consistent with a dramatic fall in inflation rates documented in Section 4.3, the model implies that the share of domestic manufacturing goods in emerging economies invoiced in local currency went up from 38% in 1995 to 94% in 2015. These changes, however, had only minor effects on exporters' decisions given the low share of currencies of emerging economies in international trade and the dominance of local currencies in the domestic flows of developed economies. Thus, the baseline assumption of exogenous PCP in local sales provides a good approximation to the equilibrium invoicing in 2015 and, as can be seen from column 5 of Table 1, is almost inconsequential for the currency shares in international trade.

²⁶The results are similar for Bulgaria, Estonia, Hungary, and Latvia. Although the model somewhat overestimates the share of DCP in the first period due to a crude guess for the pre-1995 invoicing, it reproduces well the negative trend from the data. A counterfactual with infinite adjustment costs shows that the results from the baseline model are driven not only by a mechanical effect of changing export shares, but is also due to the endogenous change in the currency of invoicing.

²⁷I focus on these currencies because of their floating regime and a high liquidity — together they account for more than 90% of FX turnover. At the same time, the results remain almost unchanged when exporters are allowed to use arbitrary currencies for invoicing.

²⁸Here and below, I solve for the whole new path of currency choice starting from 1995.

Similarly, column 6 shows that the currency shares remain largely unchanged if one assumes zero inflation across economies. This result should be interpreted with caution as it only holds because of the initial guess that all exporters set their prices in dollars and there are both fixed costs and complementarities that make switching to currencies of emerging economies suboptimal even in a low-inflation case. In other words, the high inflation of the 1990s confirms the status quo. If instead one assumes PCP or LCP in the pre-1995 period, the inflation substantially changes the currency choice of exporters and makes them switch to vehicle currencies. To further evaluate the role of the initial currency choice, I consider the case when exporters set prices in anchor currencies of their economies as defined by [Ilzetki, Reinhart, and Rogoff \(2019\)](#) for year 1995. Expectedly, this increases the share of currencies of developed economies and lowers the share of the dollar (see column 7). Yet, even in this case, the dominance of the U.S. currency remains undisputed. Interestingly, if one assumes instead that all export prices except for commodities are set in euros (German mark) before 1995, then in 2015 the share of DCP is 53.2% and the share of the ECP is 28.5%. This shows that although the history-dependence enhances the role of the dollar and especially so in the commodity sectors, it is the fundamental anchor-currency advantage of the U.S. that ensures that its currency dominates the euro in world trade, even if the initial conditions work against the dollar.

Finally, to disentangle the role of fundamental factors and the complementarities in currency choice, I consider the flexible-price limit $\lambda^r \rightarrow 0$. Perhaps surprisingly, column 8 shows that the dollar and the euro further crowd out other currencies relative to the baseline case. Intuitively, there are two effects of greater price flexibility: on the one hand, it lowers the invoicing complementarities across exporters, which dampens the role of vehicle currencies. On the other hand, it also lowers the complementarities between domestic firms and exporters, which helps to support the DCP equilibrium. The latter effect dominates in the calibrated model, although quantitatively the net effect is close to zero meaning that equilibrium invoicing is robust to a wide range of price stickiness.²⁹

4.6 Future of the dollar

After making sure that the equilibrium invoicing matches closely the current use of currencies in world trade, I next take full advantage of the general equilibrium structure of the model to do counterfactual analysis about the future evolution of the international price system. This section evaluates the effect of economic growth, exchange rate regimes, and monetary policy on the prospects of the renminbi to replace the dollar as a global currency.

The first counterfactual focuses on the growing role of China in world economy and asks how much the use of currencies will change twenty years from now, by year 2035, if countries continue to grow at their current rates. To answer this question, I compute future bilateral trade flows $\{\gamma_{ji}^r\}$ using a

²⁹This result is not driven by the fixed costs of currency adjustment. First, the costs are normalized by λ^r and go to zero in the limit of flexible prices (see Section B.2.3 in the appendix). Second, a simulation with zero fixed costs confirms that the DCP share is higher under flexible prices.

standard structural gravity model from the international trade literature (Eaton and Kortum 2002, see Appendix B.3 for details). The growth rates are estimated at the country level using the actual values for 2016–2019 and the IMF forecasts for 2020–2025 and are extrapolated for the whole horizon of twenty years. Importantly, this scenario assumes no changes in other parameters — including inflation rates and exchange rate covariances — keeping them at the 2001–2015 level.

The second bar in Figure 11 shows the results. Interestingly, the model predicts that if anything, the increasing role of China and other emerging economies in the world economy strengthens the dominance of the dollar, shrinking the share of the euro, and leaving the share of the renminbi and other currencies close to zero. This is because there are almost no changes in currency choice and all dynamics are driven by the composition effect — the contribution of emerging economies to world trade goes up and the share of the Eurozone in world economy falls. Thus, the fixed costs and complementarities in currency choice are strong enough to prevent exporters from switching to the renminbi even when the share of China in world manufacturing exports rises from 19% to 23% and its home bias goes up from 91% to 93%. Notice there is no contradiction between this result and Corollary 1: the peg to the dollar in several emerging economies including China implies that the effective share of the dollarized countries in world economy is increasing, promoting the status of DCP.

To better understand the role of the exchange rate policy, consider the second counterfactual, which assumes that China abandons FX interventions and switches to a floating regime. While it is hard to predict the properties of the renminbi exchange rate without government interventions, I assume that once expressed against a bundle of floating currencies it has a zero correlation with other exchange rates and the same volatility as the U.S. dollar.³⁰ The trade flows and other parameters take the same values as in 2015. The third bar in Figure 11 shows that the equilibrium share of the renminbi is significantly larger in this case: a higher volatility of the Chinese exchange rate against the dollar breaks the isomorphism between the two currencies and makes firms reconsider their currency choice. As a result, some trade flows to and from China switch to the renminbi invoicing. At the same time, the share of Chinese currency remains lower than the country’s contribution to world trade (11% against 14%) and the renminbi is almost never used as a vehicle currency between third countries.

The previous counterfactual makes a conservative assumption that keeps most currencies pegged to the dollar and to the euro after China switches to a floating regime. One can argue instead that developing countries are likely to adopt the renminbi as an anchor currency in their exchange rate policy in response to its rising role in international goods and financial markets (see e.g. Egorov and Mukhin 2021). The next counterfactual considers such possibility and switches the positions of the renminbi and the dollar in the exchange rate covariance matrix.³¹ In this case, the share of Chinese currency reaches 18% exceeding the country’s contribution to world trade, while the share of DCP

³⁰Indeed, once expressed in this way, the average correlation of each floating currency with the others is close to zero.

³¹In particular, I assume that the covariances between the renminbi and other currencies become the same as they are for the dollar in 2015, while the covariance of the dollar with other exchange rates is zero.

Figure 11: Counterfactual currency shares in world trade

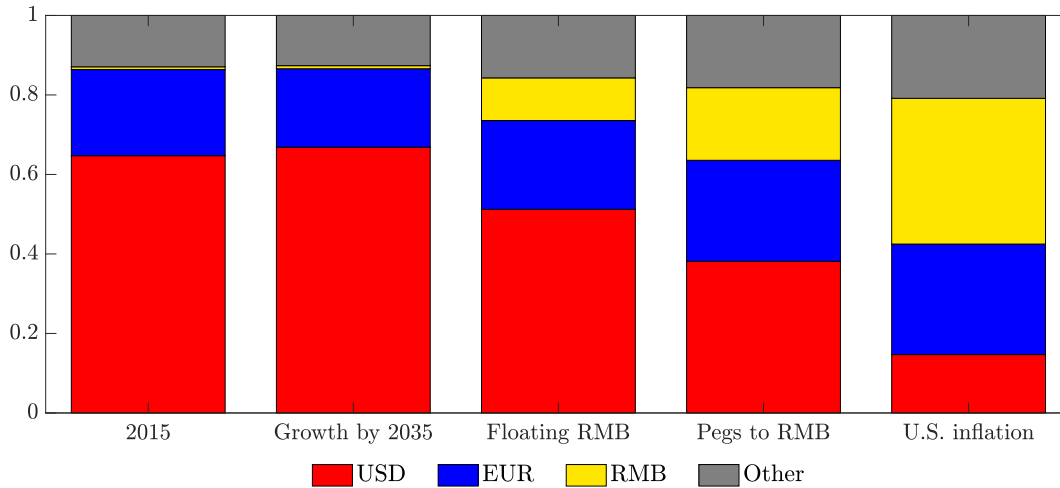

Note: the bars show the model-implied shares of the main vehicle currencies in world trade (1) in 2015, (2) under the predicted trade flows in 2035, (3) if China adopts a floating exchange rate regime, (4) if the renminbi replaces the dollar as an anchor currency for other economies, (5) if the U.S. inflation goes up to 10% per year.

falls to 38% and the share of ECP rises slightly to 25% (see the fourth bar in Figure 11). Although the renminbi also gains the status of a vehicle currency in trade between some countries, the dollar retains its status of the main vehicle currency. Thus, the history dependence is strong enough to prevent the renminbi from becoming the new dominant currency, but is not sufficient for the dollar to remain the only global currency. The world in this case features several regional currencies in line with the predictions of [Eichengreen \(2011\)](#).

Finally, I consider the case when the evolution of the international price system is driven by changes in the U.S. economy rather than in the rest of the world. In particular, assume that U.S. inflation goes up to 10% with no other changes in the world economy relative to the year 2015. Such shock can be a consequence of the rising government debt burden and the inability of the fiscal authorities to raise enough taxes to finance it. Alternatively, one can consider a shock to the safe-asset status of U.S. bonds and the resulting depreciation of the exchange rate ([Farhi and Maggiori 2018](#)), which has similar implications for the equilibrium invoicing (see Corollary 1). The last bar in Figure 11 shows that the share of DCP falls dramatically to 15%, the share of ECP goes up to 28%, and the Chinese currency emerges as the dominant currency accounting for 37% of international trade. In fact, only commodities with flexible prices remain invoiced in dollars in this case. Intuitively, an increase in U.S. inflation makes exporters look for an alternative unit of account and although the use of most currencies goes up, the gains are especially high for the renminbi, which is the closest substitute to the dollar.

To summarize, there are three main take-aways about the future of the dollar. First, the rise of China and other emerging economies does not put at risk and can even strengthen the dominance of the dollar as long as these countries stay pegged to the U.S. currency. Second, the dollar is more likely to lose its global status if U.S. inflation goes out of control, suggesting that the internal problems of the

U.S. economy are more damaging for the dominance of the dollar than external factors. Moreover, in this scenario, the anchor status works against the dollar as it simplifies the transition to the renminbi. Finally, the model suggests that the dominance of one currency in today's world is due to a particular combination of the previous history, when there were no good alternatives to the dollar, and the current fundamentals, with many emerging economies pegging their exchange rates to the dollar. If the peg is abandoned, the world is likely to move to a new equilibrium with multiple regional currencies rather than to switch to a new global currency. However, the PCP/LCP equilibrium with symmetric use of currencies in world trade is still unlikely because of the complementarities in currency choice and the high volatility of emerging economies.

5 Conclusion

This paper provides a general equilibrium framework of the international price system that can be used to analytically and quantitatively study the use of currencies in world trade. The model is broadly consistent with the key empirical facts, including the dominant status of the dollar in global trade, a large heterogeneity of invoicing across economies, and delayed transition from one dominant currency to another. A calibrated version of the model shows that high inflation and volatility in emerging economies create global demand for a vehicle currency, which is further amplified by strategic complementarities in currency choice. The large size of the U.S. economy and a widespread peg to the dollar among other countries naturally make the U.S. currency the leading candidate for the role of the global currency. While the increasing role of China in the world economy and its drift towards a floating regime can undermine the dominance of the dollar in the future, it is unlikely to fully replace it on the global stage.

The tractability of the baseline model allows for several extensions and applications, which are left for future research. First, although the use of the world input-output table and exchange rate covariance matrix allows me to match the global and cross-country invoicing patterns from the data, more granular data on inter-firm linkages can greatly improve the model's predictions at a more disaggregated level (Amiti, Itskhoki, and Konings 2020). More empirical evidence is also required regarding the size of the fixed costs of currency adjustment (Crowley, Han, and Son 2020). Second, augmenting the model with a more realistic financial sector and gross capital flows would allow analyzing the interactions between the dominant status of the dollar as a vehicle currency in international trade and as a reserve currency in global asset markets (Bahaj and Reis 2020). Third, the framework lends itself to a variety of counterfactuals and policy experiments. This paper makes the first step in this direction, leaving for future analysis many interesting experiments, such as the invoicing implications of joining the Eurozone. Finally, the counterfactual analysis shows that the future of the international price system depends heavily on the status of the dollar as the main anchor currency. More work is required to understand how countries choose the exchange rate regime, how it interacts with the other roles of the dollar, and how it is going to change in the future (Gourinchas 2021).

References

- ALLEN, T., C. ARKOLAKIS, AND Y. TAKAHASHI (2020): “Universal gravity,” *Journal of Political Economy*, 128(2), 393–433.
- ALVAREZ, F., M. BERAJA, M. GONZALEZ-ROZADA, AND P. A. NEUMEYER (2019): “From hyperinflation to stable prices: Argentina’s evidence on menu cost models,” *The Quarterly Journal of Economics*, 134(1), 451–505.
- AMITI, M., O. ITSKHOKI, AND J. KONINGS (2014): “Importers, Exporters, and Exchange Rate Disconnect,” *American Economic Review*, 7(104), 1942–1978.
- (2019): “International Shocks, Variable Markups and Domestic Prices,” *Review of Economic Studies*.
- (2020): “Dominant currencies: How firms choose currency invoicing and why it matters,” NBER Working Paper No. 27926.
- ASCARI, G., AND A. M. SBORDONE (2014): “The macroeconomics of trend inflation,” *Journal of Economic Literature*, 52(3), 679–739.
- BACCHETTA, P., AND E. VAN WINCOOP (2005): “A Theory of the Currency Denomination of International Trade,” *Journal of International Economics*, 67(2), 295–319.
- BAHAJ, S., AND R. REIS (2020): “Jumpstarting an International Currency,” CEPR Discussion Paper No. DP14793.
- BAQAEE, D. R., AND E. FARHI (2020): “Productivity and misallocation in general equilibrium,” *The Quarterly Journal of Economics*, 135(1), 105–163.
- BHATTARAI, S. (2009): “Optimal currency denomination of trade: Theory and quantitative exploration,” Discussion paper, Princeton University mimeo.
- BONADIO, B., A. M. FISCHER, AND P. SAURÉ (2020): “The speed of exchange rate pass-through,” *Journal of the European Economic Association*, 18(1), 506–538.
- BURSTEIN, A. T., AND G. GOPINATH (2012): “International Prices and Exchange Rates,” in *Handbook of International Economics*, ed. by G. Gopinath, E. Helpman, and K. Rogoff, vol. IV.
- CALIENDO, L., AND F. PARRO (2015): “Estimates of the Trade and Welfare Effects of NAFTA,” *The Review of Economic Studies*, 82(1), 1–44.
- CALVO, G. (1983): “Staggered Prices in a Utility-Maximizing Framework,” *Journal of Monetary Economics*, 12(3), 383–398.
- CARVALHO, C., AND F. NECHIO (2011): “Aggregation and the PPP Puzzle in a Sticky-Price Model,” *American Economic Review*, 101(6), 2391–2424.
- CHAHROUR, R., AND R. VALCHEV (2021): “Trade Finance and the Durability of the Dollar,” Working Paper, Boston College.

- CORSETTI, G., AND P. PESENTI (2002): “Self-Validating Optimum Currency Areas,” NBER Working Paper No. 8783.
- CRAVINO, J. (2014): “Exchange rates, aggregate productivity and the currency of invoicing of international trade,” Working paper, University of Michigan.
- CROWLEY, M. A., L. HAN, AND M. SON (2020): “Dominant currency dynamics: Evidence on dollar-invoicing from UK exporters,” CEPR Discussion Paper No. DP15493.
- DEKLE, R., J. EATON, AND S. KORTUM (2007): “Unbalanced trade,” *American Economic Review*, 97(2), 351–355.
- DEVEREUX, M., C. ENGEL, AND P. STORGAARD (2004): “Endogenous Pass-through when Nominal Prices are set in Advance,” *Journal of International Economics*, 63(2), 263–291.
- DEVEREUX, M. B., K. SHI, AND J. XU (2010): “Oil currency and the dollar standard: a simple analytical model of an international trade currency,” *Journal of Money, Credit and Banking*, 42(4), 521–550.
- DEVEREUX, M. B., AND S. SHI (2013): “Vehicle currency,” *International Economic Review*, 54(1), 97–133.
- DRENIK, A., R. KIRPALANI, AND D. PEREZ (2018): “Currency choice in contracts,” Working Paper, NYU.
- DRENIK, A., AND D. J. PEREZ (2021): “Domestic price dollarization in emerging economies,” *Journal of Monetary Economics*.
- EATON, J., AND S. KORTUM (2002): “Technology, geography, and trade,” *Econometrica*, 70(5), 1741–1779.
- EGOROV, K., AND D. MUKHIN (2021): “Optimal Policy under Dollar Pricing,” Working Paper, University of Wisconsin-Madison.
- EICHENGREEN, B. (2011): *Exorbitant Privilege: The rise and fall of the Dollar and the Future of the International Monetary System*. Oxford University Press.
- ENGEL, C. (2006): “Equivalence Results for Optimal Pass-Through, Optimal Indexing to Exchange Rates, and Optimal Choice of Currency for Export Pricing,” *Journal of European Economic Association*, 4(6), 1249–60.
- ENGEL, C. M., AND S. P. Y. WU (2018): “Liquidity and Exchange Rates: An Empirical Investigation,” NBER Working Paper w25397.
- FARHI, E., AND M. MAGGIORI (2018): “A Model of the International Monetary System,” *Quarterly Journal of Economics*.
- FRIBERG, R. (1998): “In which currency should exporters set their prices?,” *Journal of International Economics*, 45, 59–76.
- FRIBERG, R., AND F. WILANDER (2008): “The currency denomination of exports - A questionnaire study,” *Journal of international economics*, 75(1), 54–69.
- GABAIX, X. (2011): “The granular origins of aggregate fluctuations,” *Econometrica*, 79(3), 733–772.
- GALI, J., AND T. MONACELLI (2005): “Monetary policy and exchange rate volatility in a small open economy,” *The Review of Economic Studies*, 72(3), 707–734.

- GAUBERT, C., AND O. ITSKHOKI (2021): “Granular comparative advantage,” *Journal of Political Economy*, 129(3), 871–939.
- GEORGIADIS, G., H. LE MEZO, A. MEHL, C. CASAS, E. BOZ, T. NGUYEN, AND G. GOPINATH (2020): “Patterns in invoicing currency in global trade,” IMF Working Paper.
- GEORGIADIS, G., H. LE MEZO, A. MEHL, AND C. TILLE (2020): “Markets vs. policies: Can the US dollar’s dominance in global trade be dented?” ECB Working Paper.
- GOLDBERG, L. S., AND C. TILLE (2008): “Vehicle currency use in international trade,” *Journal of International Economics*, 76(2), 177–192.
- GOLOSOV, M., AND R. E. LUCAS, JR. (2007): “Menu Costs and Phillips Curves,” *Journal of Political Economy*, 115, 171–99.
- GOPINATH, G. (2016): “The International Price System,” *Jackson Hole Symposium Proceedings*.
- GOPINATH, G., E. BOZ, C. CASAS, F. J. DÍEZ, P.-O. GOURINCHAS, AND M. PLAGBORG-MØLLER (2020): “Dominant currency paradigm,” *American Economic Review*, 110(3), 677–719.
- GOPINATH, G., O. ITSKHOKI, AND R. RIGOBON (2010): “Currency Choice and Exchange Rate Pass-through,” *American Economic Review*, 100(1), 306–336.
- GOPINATH, G., AND J. C. STEIN (2021): “Banking, trade, and the making of a dominant currency,” *The Quarterly Journal of Economics*, 136(2), 783–830.
- GOURINCHAS, P.-O. (2021): “The Dollar Hegemon? Evidence and Implications for Policymakers,” in *The Asian Monetary Forum: Insights for Central Banking*, pp. 264–300.
- HASSAN, T. A. (2013): “Country size, currency unions, and international asset returns,” *The Journal of Finance*, 68(6), 2269–2308.
- ILZETZKI, E., C. M. REINHART, AND K. S. ROGOFF (2019): “Exchange arrangements entering the twenty-first century: Which anchor will hold?” *The Quarterly Journal of Economics*, 134(2), 599–646.
- ITSKHOKI, O., AND D. MUKHIN (2021): “Exchange rate disconnect in general equilibrium,” *Journal of Political Economy*, 129(8), 2183–2232.
- JIANG, Z., A. KRISHNAMURTHY, AND H. LUSTIG (2018): “Foreign safe asset demand for US treasuries and the dollar,” *AEA Papers and Proceedings*, 108, 537–41.
- KAMPS, A. (2006): “The euro as invoicing currency in international trade,” European Central Bank No. 665.
- KIMBALL, M. (1995): “The Quantitative Analytics of the Basic Neomonetarist Model,” *Journal of Money, Credit and Banking*, 27, 1241–77.
- KRUGMAN, P. (1980): “Vehicle Currencies and the Structure of International Exchange,” *Journal of Money, Credit and Banking*, 12, 513–26.
- (1991): “History versus expectations,” *The Quarterly Journal of Economics*, 106(2), 651–667.
- LEVY, D., M. BERGEN, S. DUTTA, AND R. VENABLE (1997): “The magnitude of menu costs: direct evidence

- from large US supermarket chains,” *The Quarterly Journal of Economics*, 112(3), 791–824.
- MANKIW, N. G. (1985): “Small menu costs and large business cycles: A macroeconomic model of monopoly,” *The Quarterly Journal of Economics*, 100(2), 529–537.
- MANKIW, N. G., AND R. REIS (2002): “Sticky information versus sticky prices: a proposal to replace the New Keynesian Phillips curve,” *The Quarterly Journal of Economics*, 117(4), 1295–1328.
- MATSUYAMA, K. (1991): “Increasing returns, industrialization, and indeterminacy of equilibrium,” *The Quarterly Journal of Economics*, 106(2), 617–650.
- MATSUYAMA, K., N. KIYOTAKI, AND A. MATSUI (1993): “Toward a theory of international currency,” *The Review of Economic Studies*, 60(2), 283–307.
- MEESE, R., AND K. ROGOFF (1983): “Empirical Exchange Rate Models of the Seventies: Do They Fit Out of Sample?,” *Journal of International Economics*, 14(1), 3–24.
- MORRIS, S., AND H. S. SHIN (2001): “Global Games: Theory and Applications,” *Advances in Economics and Econometrics*, p. 56.
- NAKAMURA, E., AND J. STEINSSON (2008): “Five Facts about Prices: A Reevaluation of Menu Cost Models,” *Quarterly Journal of Economics*, 123(4), 1415–1464.
- NAKAMURA, E., AND J. STEINSSON (2010): “Monetary non-neutrality in a multisector menu cost model,” *The Quarterly journal of economics*, 125(3), 961–1013.
- NOVY, D. (2006): “Hedge your costs: Exchange rate risk and endogenous currency invoicing,” Warwick Economic Research Paper No. 765.
- REY, H. (2001): “International Trade and Currency Exchange,” *Review of Economic Studies*, 68(2), 443–464.
- ROTEMBERG, J. J. (1982): “Monopolistic price adjustment and aggregate output,” *The Review of Economic Studies*, 49(4), 517–531.
- SIMS, C. A. (2003): “Implications of rational inattention,” *Journal of monetary Economics*, 50(3), 665–690.

ONLINE APPENDIX

AN EQUILIBRIUM MODEL OF THE INTERNATIONAL PRICE SYSTEM

Dmitry Mukhin
d.mukhin@lse.ac.uk

A Analytical results

A.1 Baseline model

A.1.1 Equilibrium conditions

The Kimball aggregator for consumption bundle in region i is defined as

$$(1 - \gamma) \int_0^1 \Upsilon \left(\frac{C_{ii}(\omega)}{(1 - \gamma)C_i} \right) d\omega + \gamma \int_0^1 \int_0^1 \Upsilon \left(\frac{C_{ji}(\omega)}{\gamma C_i} \right) d\omega dj = 1, \quad (\text{A1})$$

where $\Upsilon(1) = \Upsilon'(1) = 1$, $\Upsilon'(\cdot) > 0$ and $\Upsilon''(\cdot) < 0$. I define $h(\cdot) \equiv \Upsilon'^{-1}(\cdot)$ and borrow expressions for price indices and demand under the Kimball aggregator from [Itskhoki and Mukhin \(2021\)](#) and [Amiti, Itskhoki, and Konings \(2019\)](#). The equilibrium system of the model consists of the following blocks:

1. Labor supply and labor demand:

$$C_i = \frac{W_i}{P_i}, \quad (\text{A2})$$

$$L_i = (1 - \phi) \left(\frac{P_i}{W_i} \right)^\phi \frac{Y_i}{A_i}. \quad (\text{A3})$$

2. Market clearing condition:

$$Y_i(\omega) = \int_0^1 \left[(1 - \gamma) h \left(\frac{D_i P_{ii}(\omega)}{P_i} \right) (X_i + C_i) + \gamma \int_0^1 h \left(\frac{D_j P_{ij}(\omega)}{P_j} \right) (X_j + C_j) dj \right] d\omega, \quad (\text{A4})$$

where intermediate demand is given by $X_i = \phi \frac{MC_i Y_i}{P_i}$ and marginal costs of production are equal to

$$MC_i = \frac{W_i^{1-\phi} P_i^\phi}{A_i}. \quad (\text{A5})$$

3. Price setting and currency choice:

$$P_{ji}(\omega) = \begin{cases} \mathcal{E}_{ik} \bar{P}_{ji}^k, & \text{w/p } \lambda \\ \tilde{P}_{ji}, & \text{w/p } 1 - \lambda \end{cases},$$

where

$$\begin{aligned} \tilde{P}_{ji} &= \arg \max_P (P \mathcal{E}_{ji} - MC_j) h \left(\frac{D_i P}{P_i} \right) (X_i + C_i), \\ \bar{P}_{ji}^k &= \arg \max_{P,k} \mathbb{E} (P \mathcal{E}_{jk} - MC_j) h \left(\frac{D_i P \mathcal{E}_{ik}}{P_i} \right) (X_i + C_i). \end{aligned}$$

4. Definition of price indices:

$$\begin{aligned} (1 - \gamma) \int_0^1 \Upsilon \left(h \left(\frac{D_i P_{ii}(\omega)}{P_i} \right) \right) d\omega + \gamma \int_0^1 \int_0^1 \Upsilon \left(h \left(\frac{D_i P_{ji}(\omega)}{P_i} \right) \right) d\omega dj &= 1, \\ (1 - \gamma) \int_0^1 h \left(\frac{D_i P_{ii}(\omega)}{P_i} \right) \frac{P_{ii}(\omega)}{P_i} d\omega + \gamma \int_0^1 \int_0^1 h \left(\frac{D_i P_{ji}(\omega)}{P_i} \right) \frac{P_{ji}(\omega)}{P_i} d\omega dj &= 1. \end{aligned}$$

5. Risk-sharing:

$$\mathcal{E}_{i0} = \eta_i \frac{e^{\psi_i} P_i C_i}{e^{\psi_0} P_0 C_0}. \quad (\text{A6})$$

6. Country's budget constraint pins down constant η_i . The net exports expressed in dollar terms are

$$\mathbb{E} \frac{e^{\psi_i} N X_i}{e^{\psi_0} P_0 C_0} = 0, \quad \text{where} \quad (\text{A7})$$

$$N X_i = \gamma \int_0^1 \int_0^1 \left\{ \mathcal{E}_{0j} P_{ij}(\omega) h \left(\frac{D_j P_{ij}(\omega)}{P_j} \right) (X_j + C_j) - \mathcal{E}_{0i} P_{ji}(\omega) h \left(\frac{D_i P_{ji}(\omega)}{P_i} \right) (X_i + C_i) \right\} d\omega dj.$$

7. Monetary policy:

$$e^{m_i} = P_i C_i. \quad (\text{A8})$$

A.1.2 Steady state

Consider symmetric steady state with zero net foreign asset positions and $\psi_i = 0$. The symmetry implies that bilateral exchange rates between all countries are equal one, $\mathcal{E}_{ij} = 1$ and therefore, $P_{ji} = D_i$. Given the steady-state elasticity of demand θ , the optimal markup is $\frac{\theta}{\theta-1}$ and hence, from the labor supply condition (A2), the steady-state consumption is $C_i = \frac{\theta-1}{\theta}$. From market clearing conditions (A3) and (A4), the aggregate output and employment are equal $Y_i = \frac{1}{1-\phi} C_i$ and $L_i = C_i^{1-\phi}$.

A.1.3 Prices

For the applications below, it is sufficient to focus on the case when domestic firms set prices in local currency and invoicing is symmetric across countries. Let μ^P and μ^D be dummy variables that are equal one if exporters choose respectively PCP and DCP and are zero otherwise. The bilateral price index (14) can then be written as

$$p_{ji} = (1 - \lambda) \tilde{p}_{ji} + \lambda [(\mu^P + \mu^D) e_i - \mu^P e_j - \mu^D e_0],$$

where $p_{ii} = (1 - \lambda)\tilde{p}_{ii}$ for domestic prices. Substitute the bilateral prices into the aggregate price index (13) and integrate using the fact that $\int_n^1 e_i di = 0$:

$$p_i = (1 - \gamma)(1 - \lambda)\tilde{p}_{ii} + \gamma(1 - \lambda) \int_0^1 \tilde{p}_{ji} dj + \gamma\lambda[(\mu^P + \mu^D)e_i - (n\mu^P + \mu^D)e_0].$$

Given that nominal wages are constant $w_i = 0$, the desired price (11) is given by

$$\tilde{p}_{ji} = (1 - \alpha)(\phi p_j + e_{ij}) + \alpha p_i$$

and can be substituted into the previous expression to obtain

$$\begin{aligned} \left[1 - (1 - \lambda)(\alpha + (1 - \gamma)(1 - \alpha)\phi)\right] p_i &= \gamma(1 - \lambda)(1 - \alpha)\phi \int_0^1 p_j dj + \gamma \left[(1 - \lambda)(1 - \alpha) + \lambda(\mu^P + \mu^D) \right] e_i \\ &\quad - \gamma \left[\lambda(n\mu^P + \mu^D) + (1 - \lambda)(1 - \alpha)n \right] e_0. \end{aligned}$$

Integrate p_i across countries into the global price index $p \equiv \int_0^1 p_i di$:

$$\left[1 - (1 - \lambda)(\alpha + (1 - \alpha)\phi)\right] p = -\gamma\lambda(1 - n)\mu^D e_0.$$

Substitute p into the previous equation to solve for p_i :

$$p_i = \chi e_i - \chi_0 e_0, \tag{A9}$$

where

$$\begin{aligned} \chi &= \frac{\gamma[(1 - \lambda)(1 - \alpha) + \lambda(\mu^P + \mu^D)]}{1 - (1 - \lambda)(\alpha + (1 - \gamma)(1 - \alpha)\phi)}, \\ \chi_0 &= \frac{\gamma}{1 - (1 - \lambda)(\alpha + (1 - \gamma)(1 - \alpha)\phi)} \left[(1 - \lambda)(1 - \alpha)n + \lambda(n\mu^P + \mu^D) + \frac{\lambda(1 - \lambda)(1 - \alpha)\gamma\phi\mu^D(1 - n)}{1 - (1 - \lambda)(\alpha + (1 - \alpha)\phi)} \right]. \end{aligned}$$

The optimal price (15) can then be expressed as

$$\tilde{p}_{ji} + e_{ki} = e_k - (1 - \alpha)(1 - \phi\chi)e_j - \alpha(1 - \chi)e_i - (\alpha + (1 - \alpha)\phi)\chi_0 e_0. \tag{A10}$$

It is easy to verify that the aggregate pass-through coefficients (A9) are positive and no greater than one, i.e. $0 \leq \chi, \chi_0 \leq 1$. It follows that the coefficients before e_j , e_i and e_0 are between 0 and 1 as well.

A.2 Proofs

Proof of Lemma 1 Suppress country indices and take the second-order approximation of the profit function at price p around the state-dependent optimal price \tilde{p}_{ji} :

$$\Pi(p) = \Pi(\tilde{p}_{ji}) + \Pi_p(\tilde{p}_{ji})(p - \tilde{p}_{ji}) + \frac{1}{2}\Pi_{pp}(\tilde{p}_{ji})(p - \tilde{p}_{ji})^2 + \mathcal{O}(p - \tilde{p}_{ji})^3,$$

The first term on the right hand side does not depend on currency of invoicing. From the first-order condition for optimal price, $\Pi_p(\tilde{p}_{ji}) = 0$. Finally, to the zero-order approximation, $\Pi_{pp}(\tilde{p}_{ji}) = \bar{\Pi}_{pp}(\tilde{p}_{ji}) < 0$, where $\bar{\Pi}_{pp}(0)$ denotes the derivative in the deterministic steady state and \tilde{p}_{ji} is the corresponding optimal price. Therefore, to the second-order approximation, the currency choice problem is equivalent to minimizing $\mathbb{E}(p - \tilde{p}_{ji})^2$. Note that only the first-order approximation is required for p and \tilde{p}_{ji} . In particular, the optimal preset price in currency k

is $\tilde{p}_{ji}^k = \mathbb{E}(\tilde{p}_{ji} - e_{ik})$, so that ex post price is $p = \tilde{p}_{ji}^k + e_{ik}$. Substitute this expression into the objective function to write the currency problem as

$$\min_k \mathbb{V}(\tilde{p}_{ji} + e_{ki}), \quad (\text{A11})$$

which completes the proof of the lemma. ■

Proof of Lemma 2 An equal increase in all exchange rates $\{e_i\}$ leaves the bilateral exchange rates unchanged and hence, has no effect on desired prices \tilde{p}_{ji} . It follows that \tilde{p}_{ji} is homogeneous of degree zero in exchange rates and that $\tilde{p}_{ji} - e_i$ is homogeneous of degree one. Therefore, it is always possible to contract a basket of currencies with the sum of currency weights equal one that perfectly replicates the desired price. The equilibrium prices then coincide with the case of flexible prices, i.e. $\chi = \frac{\gamma}{1-(1-\gamma)\phi}$ and $\chi_0 = \frac{\gamma n}{1-(1-\gamma)\phi}$. It follows from equation (A10) that the share of dollars is $(\alpha + (1-\alpha)\phi)\chi_0$ for trade flows between non-U.S. economies, $\alpha(1-\chi) + (\alpha + (1-\alpha)\phi)\chi_0$ for U.S. imports, and $(1-\alpha)(1-\phi\chi) + (\alpha + (1-\alpha)\phi)\chi_0$ for U.S. exports. Excluding within-U.S. trade from international flows, the weights of the corresponding flows are $\frac{(1-n)^2}{1-n^2}$, $\frac{(1-n)n}{1-n^2}$ and $\frac{(1-n)n}{1-n^2}$. Integrate across all flows to get the share of DCP in international trade equal

$$(\alpha + (1-\alpha)\phi)\chi_0 + \left[\alpha(1-\chi) + (1-\alpha)(1-\phi\chi) \right] \frac{(1-n)n}{1-n^2} = \frac{n}{1+n} \left[1 + \frac{\gamma(\alpha + (1-\alpha)\phi)}{1-(1-\gamma)\phi} n \right] \leq \frac{n}{1+n}(1+n) = n.$$

Note that the dollar share in trade would be exactly n if the flows between U.S. islands $i \in [0, n]$ were included in international trade. ■

Proof of Proposition 1 Consider for example the limit $\gamma, \alpha \rightarrow 1$, so that $\chi \rightarrow \mu^P + \mu^D$, $\chi_0 \rightarrow n\mu^P + \mu^D$ and $\tilde{p}_{ji} + e_{ki} \rightarrow e_k - (1-\chi)e_i - \chi_0 e_0$. Conjecture that other firms choose DCP, so that $\mu^D = 1$ and $\tilde{p}_{ji} + e_{ki} \rightarrow e_k - e_0$. It follows that the firm finds it optimal to choose $k = 0$ and the DCP equilibrium can be sustained in the neighbourhood of $\gamma = \alpha = 1$.

Note that both χ and χ_0 are increasing in γ and ϕ . In addition, given χ and χ_0 , the coefficient before e_j in equation (A10) is decreasing in ϕ , while the coefficient before e_0 is increasing in ϕ . It follows that higher γ and ϕ decrease the weights of e_j and e_i and increase the weight of e_0 in equation (A10), which makes PCP and LCP less likely and raises the chances of DCP. Figure 2 shows that the effect of α can be not monotonic. ■

Lemma A1 *In the flexible-price limit $\lambda \rightarrow 0$, the equilibrium exists and is generically unique. The invoicing is symmetric across small countries.*

Proof In the flexible-price limit $\lambda \rightarrow 0$, the pass-through coefficients from (A9) converge to $\chi \rightarrow \frac{\gamma}{1-(1-\gamma)\phi}$ and $\chi_0 \rightarrow \frac{\gamma n}{1-(1-\gamma)\phi}$ and do not depend on invoicing decisions of firms. The currency choice problem then has a unique solution except for some borderline values of parameters. Finally, since coefficients before exchange rates are the same for exporters from all small economies and the volatility of exchange rates is also the same, the equilibrium invoicing is symmetric across them. ■

Proof of Lemma 4 When $n = 0$, the desired price of exporters is

$$\tilde{p}_{ji} + e_{ki} = e_k - \frac{1-\phi}{1-(1-\gamma)\phi} \left[(1-\alpha)e_j + \alpha(1-\gamma)e_i \right]. \quad (\text{A12})$$

Since volatility of all exchange rates is the same when $\rho = 1$, the exporter chooses between producer and local currency based on their weights in (A12): $k = j$ when $1-\alpha \geq \alpha(1-\gamma) \Leftrightarrow \alpha \leq \frac{1}{2-\gamma}$ and $k = i$ otherwise. ■

Proof of Proposition 2 The desired price in the flexible-price limit with $n > 0$ is

$$\tilde{p}_{ji} + e_{ki} = e_k - \frac{1 - \phi}{1 - (1 - \gamma)\phi} \left[(1 - \alpha)e_j + \alpha(1 - \gamma)e_i \right] - \frac{\gamma(\alpha + (1 - \alpha)\phi)}{1 - (1 - \gamma)\phi} ne_0. \quad (\text{A13})$$

As long as $n > 0$, choosing $k = 0$ is optimal for example in the limit $\phi \rightarrow 1$. Moreover, keeping the values of other parameters fixed, higher n increases the relative weight of e_0 in the optimal price, and therefore makes DCP more likely. ■

Proof of Proposition 3 Rewrite expression (A10) as $\tilde{p}_{ji} + e_{ki} = e_k - ae_j - be_i - ce_0$. From Lemma 1, exporters choose PCP, LCP or DCP depending on whether respectively a , b or $\rho(c - 0.5) + 0.5$ is greater. If $n \leq 0.5$, it follows that $c - 0.5 \geq 0$ and hence, lower values of ρ unambiguously increase the chances of DCP. Note that in the limit $\phi \rightarrow 1$, we have $a = b = 0$ and under $\rho < 1$ DCP strictly dominates both PCP and LCP. ■

Proof of Corollary 1 Adopt the following notation: two currency unions have masses n_1 and n_2 with $n \equiv n_1 + n_2$, the relative exchange rate volatility of pound is $\rho \equiv \frac{\sigma_1^2}{\sigma_1^2 + \sigma_2^2}$, μ_i^k denotes the share of country i imports invoiced in currency k ($\mu_i^1 + \mu_i^2 = 1$), and the aggregate price index in country i is $p_i = \chi_0^i e_i - \chi_1^i e_1 - \chi_2^i e_2$, where $i = 0$ for a representative country from the RoW. Vehicle currency 1 dominates vehicle currency 2 for exporter from j to i iff

$$(1 - \alpha) \frac{\text{cov}(\phi p_j + e_1 - e_j, e_1 - e_2)}{\text{var}(e_1 - e_2)} + \alpha \frac{\text{cov}(p_i + e_1 - e_i, e_1 - e_2)}{\text{var}(e_1 - e_2)} < \frac{1}{2}.$$

Applying this formula for each bilateral trade flow, we get:

- RoW exports to RoW:

$$(\alpha + (1 - \alpha)\phi)\chi_2^0 + [1 - (\chi_1^0 + \chi_2^0)(\alpha + (1 - \alpha)\phi)]\rho < \frac{1}{2},$$

- RoW exports to currency unions:

$$(1 - \alpha)\phi\chi_2^0 + \alpha\chi_2^1 + [(1 - \alpha)(1 - \phi\chi_1^0 - \phi\chi_2^0) + \alpha(\chi_0^1 - \chi_1^1 - \chi_2^1)]\rho < \frac{1}{2},$$

$$(1 - \alpha)\phi\chi_2^0 + \alpha(1 + \chi_2^2 - \chi_0^2) + [(1 - \alpha)(1 - \phi\chi_1^0 - \phi\chi_2^0) + \alpha(\chi_0^2 - \chi_1^2 - \chi_2^2)]\rho < \frac{1}{2},$$

- Currency union exporting to RoW:

$$(1 - \alpha)\phi\chi_2^1 + \alpha\chi_2^0 + [(1 - \alpha)\phi(\chi_0^1 - \chi_1^1 - \chi_2^1) + \alpha(1 - \chi_1^0 - \chi_2^0)]\rho < \frac{1}{2},$$

$$(1 - \alpha)(1 + \phi\chi_2^2 - \phi\chi_0^2) + \alpha\chi_2^0 + [(1 - \alpha)\phi(\chi_0^2 - \chi_1^2 - \chi_2^2) + \alpha(1 - \chi_1^0 - \chi_2^0)]\rho < \frac{1}{2},$$

- One currency union exporting to the other:

$$(1 - \alpha)\phi\chi_2^1 + \alpha(1 + \chi_2^2 - \chi_0^2) + [(1 - \alpha)\phi(\chi_0^1 - \chi_1^1 - \chi_2^1) + \alpha(\chi_0^2 - \chi_1^2 - \chi_2^2)]\rho < \frac{1}{2},$$

$$(1 - \alpha)(1 + \phi\chi_2^2 - \phi\chi_0^2) + \alpha\chi_2^1 + [(1 - \alpha)\phi(\chi_0^2 - \chi_1^2 - \chi_2^2) + \alpha(\chi_0^1 - \chi_1^1 - \chi_2^1)]\rho < \frac{1}{2}.$$

I next argue that the share of DCP is monotonically increasing along the transition path focusing separately on two cases when the dynamics is driven by ρ and by n_2 . Parameter ρ is present only in the currency choice

Figure A1: Transition

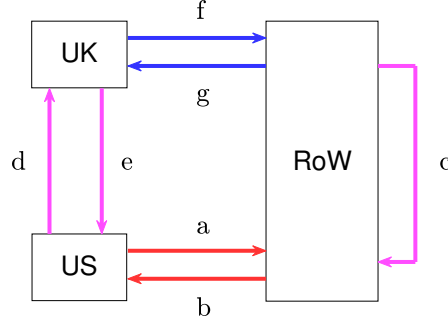

block:

$$(1 - \alpha) \left[\phi \chi_2^j + (1 - \phi \chi_1^j - \phi \chi_2^j) \rho - (1 - \phi \chi_0^j) \frac{\text{cov}(e_j, e_1 - e_2)}{\text{var}(e_1 - e_2)} \right] \\ + \alpha \left[\chi_2^i + (1 - \chi_1^i - \chi_2^i) \rho - (1 - \chi_0^i) \frac{\text{cov}(e_i, e_1 - e_2)}{\text{var}(e_1 - e_2)} \right] < \frac{1}{2}.$$

The derivative of each term with respect to ρ is clearly positive for all countries except for country 1, for which it is proportional to $\chi_0^1 - \chi_1^1 - \chi_2^1$. This term, however, is non-negative as well:

$$\gamma(1 - \lambda)(1 - \alpha)(1 - n) \left[\frac{(1 - \lambda)(1 - \alpha)(1 - \phi) + \lambda(1 - \gamma\phi)}{1 - (1 - \lambda)(\alpha + (1 - \alpha)\phi)} \right].$$

Thus, as ρ goes up, all constraints become more binding and everything else equal, can only decrease the use of the pound. Hence, μ_i^1 falls and μ_i^2 rises, which leaves χ_0^i unaffected, decreases χ_1^i and increases χ_2^i . This tightens the constraint for currency 1 even further in a monotonic way.

Consider next an increase in n_2 , assuming that n remains unchanged. Country sizes n_i are present only in price indices, but not directly in the currency choice inequalities. The second part of the proposition (proven below) implies that the share of dollar denominated imports from RoW to the first country is not smaller than the one to the second country. From the inequalities for the trade flows between the currency unions we get $\mu_1^1 - \mu_2^1 \geq n_1 - n_2 = 0$. This inequality ensures that for a given currency choice, χ_1^i is monotonic in n_1 and χ_2^i is monotonic in n_2 . This implies χ_1^i decreases and χ_2^i increases as n_2 goes up. The currency choice inequalities then tighten with n_2 . The argument from above shows that endogenous change in invoicing patterns amplifies the fall in the global share of the pound.

Consider next the order, in which the trade flows change the currency of invoicing. Suppose n_2 goes up leaving n unchanged. First, note that price index for any country consists of three terms:

$$p_i \propto (1 - \lambda)\gamma(1 - \alpha)\phi \int p_j dj + (1 - \lambda)\gamma(1 - \alpha) \int (e_i - e_j) dj + \lambda\gamma [e_i - \mu_i^1 e_1 - \mu_i^2 e_2]$$

The first term is the same for all countries, while the second one does not depend on currency of invoicing. The last term, however, implies that in the initial equilibrium with all global trade denominated in currency 1, μ_i^2 is positive only for $i = 2$. Therefore, χ_2^j is higher and χ_1^j is lower for country 2. Denote with $T(x)$ the threshold of n_2/n_1 or ρ when trade flow x switches from the pound to the dollar and denote trade flows as in Figure A1. The currency choice inequalities from above imply then $T(b) \leq T(c)$, $T(e) \leq T(f)$ and $T(a) \leq T(c)$, $T(d) \leq T(g)$. This in turn implies $\chi_2^2 \geq \chi_2^j$ for any j , which confirms that the previous inequalities hold and the ordering of switches is correct. The symmetric argument can be made for country 1 with higher χ_1^j and lower

χ_2^j implying $T(c) \leq T(f)$, $T(b) \leq T(e)$ and $T(c) \leq T(g)$, $T(a) \leq T(d)$. The comparative statics for ρ can be made in the similar way: the derivative of the LHS of currency choice inequality with respect to ρ is the same for all countries, so that only levels of χ_k^j matter. ■

A.3 Additional results

A.3.1 Multiple equilibria

Definition 3 *An equilibrium is symmetric if all exporters in the world use either PCP, LCP or the same vehicle currency. The equilibrium is unstable if exogenous perturbation of currency choice of an arbitrarily small fraction of exporters makes a positive mass of other firms change their invoicing decisions.*

Proposition A1 (Multiple equilibria) *Assume that $n = 0$ and $\rho = 1$. Then*

1. *at least one symmetric equilibrium always exists,*
2. *if symmetric equilibrium is unique, then no other equilibria exist,*
3. *all non-pure-strategy equilibria are unstable.*

The proof of Proposition A1 requires a few additional lemmas. When $n = 0$ and $\rho = 1$, the currency choice of exporters is based on the following inequalities:

$$PCP \succ LCP \Leftrightarrow (1 - \alpha) \phi \chi + \alpha (2 - \chi) < 1, \quad (\text{A14a})$$

$$PCP \succ DCP \Leftrightarrow (1 - \alpha) \phi (\chi + \chi_0) + \alpha (1 + \chi_0) < 1, \quad (\text{A14b})$$

$$DCP \succ LCP \Leftrightarrow (1 - \alpha) (1 - \phi \chi_0) + \alpha [2 - (\chi + \chi_0)] < 1. \quad (\text{A14c})$$

where \succ stays for “preferred to”. I use χ^X and χ_0^X to denote the values of the corresponding pass-through coefficients in (A9) under symmetric invoicing X.

Lemma A2 *If DCP is preferred to PCP (LCP) under PCP (LCP) price index, then this ordering holds under DCP price index as well. Symmetrically, if PCP (LCP) dominates DCP under DCP price index, then this ordering holds under PCP (LCP) price index as well.*

Proof Since condition (A14b) gets tighter with χ and χ_0 , and $\chi^P = \chi^D$, $\chi_0^P < \chi_0^D$, the relation $DCP \succ PCP$ under χ^P and χ_0^P implies the same ordering under χ^D and χ_0^D . Since condition (A14c) is relaxed by higher χ and χ_0 and $\chi^L < \chi^D$, $\chi_0^L < \chi_0^D$, the relation $DCP \succ LCP$ for χ^L and χ_0^L implies the same ordering for χ^D and χ_0^D . ■

Lemma A3 *It is impossible that for given parameter values, an exporter (i) chooses PCP when all others choose LCP, and (ii) chooses LCP when all others choose PCP.*

Proof Suppose that was the case. Then from (A14a) $\frac{1 - \phi \chi^P}{2 - \chi^P (1 + \phi)} < \alpha < \frac{1 - \phi \chi^L}{2 - \chi^L (1 + \phi)}$. But this requires $\chi^L > \chi^P$, which can not be the case. ■

Lemma A4 *Consider a pure-strategy NE with a choice only between PCP and LCP. If the symmetric LCP equilibrium does not exist, the only possible pure-strategy NE is the symmetric PCP.*

Proof Pure-strategy equilibria can be parametrized by cdf $F(\cdot)$ for $\mu_i^P \in [0, 1]$ across countries. PCP is chosen by exporter from country j to country i iff

$$(1 - \alpha)\phi\chi_j + \alpha(2 - \chi_i) < 1 \quad \Rightarrow \quad \mu_j < a + b\mu_i$$

for some positive constants a and b . Integrating across importers, we then derive the equilibrium condition: $\mu_i = \int_j \mathbb{I}\{\mu_j < a + b\mu_i\} dj$, or equivalently

$$\int_0^1 \mathbb{I}\{z < a + bx\} dF(z) = F(a + bx) = x$$

for any x with positive density. Suppose next that symmetric LCP equilibrium does not exist, i.e. $F(a) = 0$ is unattainable. This is possible only if $a > 1$. But then for any $x > 0$ with positive density we have $x = F(a + bx) \geq F(a) = 1$, i.e. symmetric PCP is the only PSE. ■

Proof of Proposition A1 (1) Suppose there are no symmetric equilibria for some combination of parameters. Note that since $\chi^P = \chi^D$, it follows from (A14a) that the preferences between PCP and LCP should be the same under PCP and DCP price indices. First, suppose that $PCP \succ LCP$ under DCP and PCP. Since there is no PCP equilibrium, we must have $DCP \succ PCP$ under PCP price index. But by Lemma A2, we have $DCP \succ PCP$ under DCP price index as well and hence, DCP equilibrium exists. Second, suppose that $LCP \succ PCP$ under DCP and PCP. Then from Lemma A3, we have $LCP \succ PCP$ under LCP price index. Non-existence of LCP equilibrium requires then $DCP \succ LCP$ under LCP price index. By Lemma A2, $DCP \succ LCP$ under DCP price index as well and hence, we obtain DCP equilibrium. In both cases we arrive to contradiction.

(2) First, suppose that DCP is a unique symmetric equilibrium. Then $DCP \succ LCP$ under LCP and $DCP \succ PCP$ under PCP price index. Since χ^i and χ_0^i can get only higher as one deviates from symmetric LCP, constraint (A14c) implies that DCP dominates LCP in any PSNE. But then χ^i stays the same and χ_0^i can only increase relative to symmetric PCP and constraint (A14b) implies that DCP dominates PCP in any PSNE as well. Second, suppose that LCP is a unique symmetric equilibrium. Since χ^i and χ_0^i can only get lower as one deviates from symmetric DCP, constraint (A14c) implies that LCP dominates DCP in any PSE as well. The existence of symmetric LCP requires according to constraint (A14a) that $\alpha > \frac{1 - \phi\chi^L}{2 - \chi^L(1 + \phi)} > \frac{1}{2}$. This implies $\alpha > (1 - \alpha)\phi$, so that constraint (A14a) relaxes as χ^i decreases. Therefore, there can be no PSNE with PCP. Finally, suppose that PCP is a unique symmetric NE. Since χ^i and χ_0^i can get only lower than under symmetric DCP, constraint (A14b) implies that DCP is dominated by PCP in PSNE. According to Lemma A4, there can be no PSE with positive measure of LCP.

(3) Suppose there is market i , in which a positive mass of importers are indifferent between PCP and DCP and play mixed strategies. Take an arbitrary small share of firms pricing in the producer currency and exogenously switch their invoicing into dollars. The coefficient χ^i does not change, while χ_0^i increases. Condition (A14b) implies that the firms that were indifferent now strictly prefer DCP, while condition (A14c) implies that the share of LCP can only fall. Since firms (endogenously) switch to dollar in response to the perturbation, the initial equilibrium is not stable. Note there are no indirect effects coming from other markets: as country i is infinitely small, the changes in invoicing of its imports or exports has no impact on other countries. A symmetric argument applies for other types of mixed equilibria. ■

A.3.2 Domestic dollarization

In contrast to the assumption of the baseline model, it is not uncommon for *local* firms in developing countries to set prices in dollars (see e.g. Drenik and Perez 2021). I therefore extend the model allowing domestic producers to choose optimally the currency of invoicing and define the global currency pricing (GCP) equilibrium, in which

Figure A2: The optimal invoicing of domestic firms

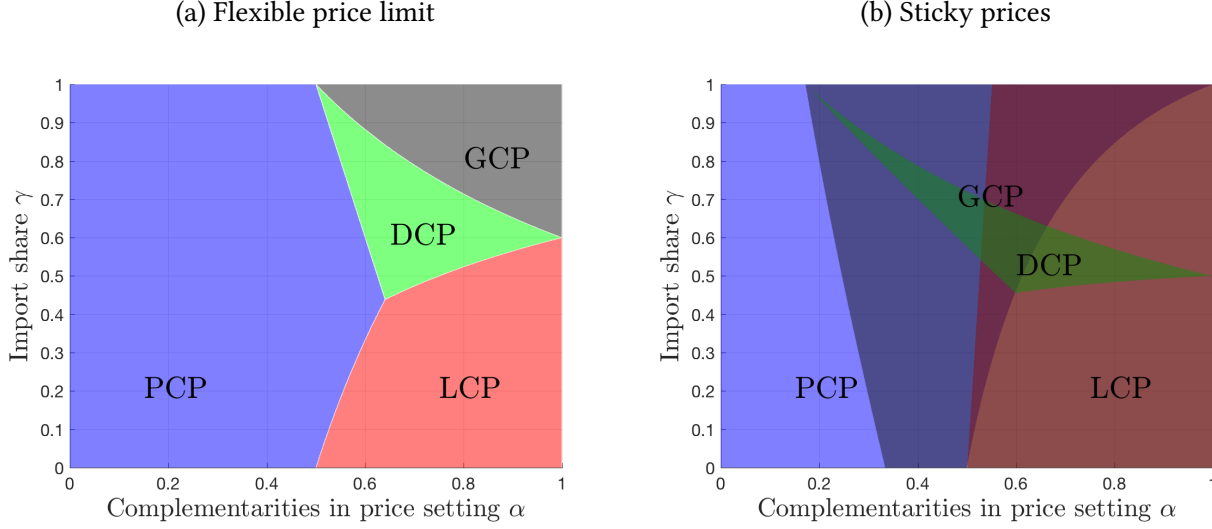

Note: figure (a) shows equilibria in the flexible price limit $\lambda \rightarrow 0$ and $\rho = 0.5$, while figure (b) shows symmetric equilibria under sticky prices $\lambda = 0.5$ and $\rho = 1$. The grey area is the region of the global currency pricing (GCP) equilibrium with all firms including domestic ones using the dollar for invoicing. Other parameters: $\phi = 0.5$, $n = 0$.

all firms in the world (including domestic ones) use dollars for invoicing. In contrast, in DCP equilibrium only exporters price in dollars, while domestic firms use local currency.

Proposition A2 *Assume that domestic firms optimally choose the currency of invoicing. Then*

1. *in the flexible price limit $\lambda \rightarrow 0$, the region of GCP is the subset of DCP and is increasing in γ , ϕ , α , n and is decreasing in ρ if $n \leq 1/2$,*
2. *in the limit of fully rigid prices $\lambda \rightarrow 1$, the region of DCP is a subset of GCP.*

Proof Note that PCP, LCP and DCP coincide for U.S. local firms. Therefore, it is sufficient to focus on the decisions of domestic firms in non-U.S. economies. In the flexible price limit, the currency of invoicing of both exporters and domestic firms has no effect on equilibrium prices and the optimal currency choice is determined by equation (A13), where $i = j$ for domestic firms. It follows immediately that if local firms choose DCP, then so do the exporters. Moreover, domestic firms prefer dollar pricing iff

$$\left[1 - \frac{2\gamma(\alpha + (1 - \alpha)\phi)}{1 - (1 - \gamma)\phi} n \right] \rho < 1 - \frac{2(1 - \phi)(1 - \gamma\alpha)}{1 - (1 - \gamma)\phi}.$$

This inequality is more likely to be satisfied when n , γ , α , and ϕ are high, and if $n \leq 0.5$, when ρ is low.

Consider next the case of fully sticky prices. Assume that all exporters set dollar prices and denote with μ_D^D a dummy that is equal one if domestic firms use DCP. It follows that $p_i = [\gamma + (1 - \gamma)\mu_D^D](e_i - e_0)$ and hence, adoption of DCP by local firms lowers the weight of PCP and LCP and raises the weight of DCP in the desired price of exporters (A10), making it easier to sustain the DCP equilibrium. ■

To see the intuition, consider first the flexible-price limit when equilibrium prices are independent from firms' invoicing decisions (Figure A2a). Because producer and local currencies coincide for domestic firms, their total weight in the optimal price is higher than the share of producer currency or local currency for exporters. As a result, domestic firms are less likely to use dollar invoicing and the GCP equilibrium is a subset of the DCP

equilibrium. On the other hand, when prices are fully sticky and strategic complementarities in currency choice are strong, it is easier to support the equilibrium where all firms invoice in dollars than the equilibrium where only exporters use dollars and domestic firms set prices in local currency (Figure A2b). Thus, the model predicts that while domestic firms might be less likely to switch to dollar invoicing than exporters, once they do so – e.g. because of the unstable monetary policy discussed above – the DCP equilibrium can be sustained more easily and can persist even after fundamental factors turn against the dollar.

B Quantitative analysis

B.1 Full model

Consider an infinite horizon model with discrete time. There are N economies, S sectors (industries), and K currencies. I use subscripts j and i to denote respectively the countries of origin and destination and superscripts r and s for the sectors of origin and destination. Index k is reserved for currency of invoicing. Firms are free to set different prices across markets with the latter defined by type of good (industry of production) r and country of destination i .

General equilibrium block in each country i is described by households maximizing expected utility

$$\mathbb{E} \sum_{t=0}^{\infty} \beta^t (\log C_{it} - L_{it})$$

subject to the budget constraint

$$P_{it}C_{it} + e^{-\psi_{it}} \mathcal{E}_{i0t} \left(\mathbb{E}_t [Q_{t+1}B_{it+1}] - B_{it} \right) = W_{it}L_{it} + \Pi_{it} - T_{it} + \Omega_{it},$$

where T_{it} includes fixed costs of currency adjustment. As before, the optimal risk sharing under complete markets and log-linear preferences implies

$$\mathcal{E}_{i0t} = \frac{e^{\psi_{it}} P_{it}C_{it}}{e^{\psi_{0t}} P_{0t}C_{0t}} = \frac{e^{\psi_{it}} W_{it}}{e^{\psi_{0t}} W_{0t}}.$$

Without loss of generality, the bilateral exchange rates can be decomposed into country-specific series given by $\mathcal{E}_{it} = e^{\psi_{it}} W_{it}$. I assume that the monetary authorities make nominal demand and nominal wages grow at a constant rate μ_i , while the financial shocks are a martingale $\Delta\psi_{it} = \varepsilon_{it}$ with innovations potentially correlated across economies $\varepsilon_t \sim \text{i.i.d.}(0, \Sigma)$. Therefore, nominal exchange rates follow a random walk process with a drift μ and covariance matrix Σ across countries: $\Delta e_t \sim \text{i.i.d.}(\mu, \Sigma)$.

Production of a representative firm in sector s of country i is described by a Cobb-Douglas technology that combines labor and intermediates from sectors $r = 1, \dots, S$:

$$Y_{it}^s = A_{it}^s \left(\frac{L_{it}^s}{\phi_i^{Ls}} \right)^{\phi_i^{Ls}} \prod_{r=1}^S \left(\frac{X_{it}^{rs}}{\phi_i^{rs}} \right)^{\phi_i^{rs}}, \quad \phi_i^{Ls} + \sum_{r=1}^S \phi_i^{rs} = 1,$$

where X_{it}^{rs} is the amount of good r used in production of sector s in country i in period t . The sum of input shares is equal to one ensuring a constant returns to scale. It follows that the marginal costs of production are

$$MC_{it}^s = \frac{1}{A_{it}^s} \left(W_{it} \right)^{\phi_i^{Ls}} \prod_{r=1}^S \left(P_{it}^r \right)^{\phi_i^{rs}}.$$

Similar to production function, the final consumption bundle is a Cobb-Douglas aggregator of different goods:

$$C_{it} = \prod_{r=1}^S \left(\frac{X_{it}^{rC}}{\phi_i^{rC}} \right)^{\phi_i^{rC}}, \quad \sum_{r=1}^S \phi_i^{rC} = 1.$$

The individual products within each market are combined via the Kimball aggregator:

$$\sum_{j=1}^N \gamma_{ji}^r \int_0^1 \Upsilon \left(\frac{Y_{jit}^r(\omega)}{\gamma_{ji}^r X_{it}^r} \right) d\omega = 1, \quad \sum_{j=1}^N \gamma_{ji}^r = 1,$$

where $Y_{jit}^r(\omega)$ are the quantities sold by firm ω from country j and sector r in country i in period t and γ_{ji}^r are demand shifters, which determine the steady-state trade flows across countries and sectors. As before, for each market, the aggregate price index P_{it}^r is implicitly defined by the system of equations:

$$\sum_{j=1}^N \gamma_{ji}^r \int_0^1 \Upsilon \left(h \left(\frac{D_{it}^r P_{jit}^r(\omega)}{P_{it}^r} \right) \right) d\omega = 1 \quad \text{and} \quad \sum_{j=1}^N \gamma_{ji}^r \int_0^1 h \left(\frac{D_{it}^r P_{jit}^r(\omega)}{P_{it}^r} \right) \frac{P_{jit}^r(\omega)}{P_{it}^r} d\omega = 1.$$

The market clearing condition can then be written as

$$Y_{jt}^r = \sum_{i=1}^N \int_0^1 Y_{jit}^r(\omega) d\omega = \sum_{i=1}^N \int_0^1 h \left(\frac{D_{it}^r P_{jit}^r(\omega)}{P_{it}^r} \right) d\omega \left(\sum_{s=1}^N X_{it}^{rs} + X_{it}^{rC} \right),$$

where the last bracket is the sum of intermediate demand and final demand for good r in country i given by

$$X_{it}^{rs} = \frac{\phi_i^{rs} M C_{it}^s Y_{it}^s}{P_{it}^r} \quad \text{and} \quad X_{it}^{rC} = \frac{\phi_i^{rC} P_{it} C_{it}}{P_{it}^r}.$$

Currency choice and proof of Proposition 4 I solve for the optimal currency choice under the Calvo friction taking the approximation around the steady-state with non-zero inflation and flexible prices.¹ Firms choose the currency of invoicing before the realization of shocks and are free to adjust the price in that currency subject to the Calvo friction. As before, to the second order of approximation, a firm chooses the currency of invoicing to minimize expected deviations of the preset price $\tilde{p}_{ji}^r(k)$ from the state-dependent desired price $\tilde{p}_{jit}^r + e_{kit}$:

$$\min_k \mathbb{E} \sum_{t=0}^{\infty} (\beta \lambda^r)^t (\tilde{p}_{jit}^r + e_{kit} - \tilde{p}_{ji}^r(k))^2,$$

where the time subscript $t = 0$ of the reset price is suppressed for brevity. Dropping the terms that are invariant to the currency k , the problem can be rewritten as

$$\max_k \mathbb{E} \sum_{t=0}^{\infty} (\beta \lambda^r)^t \left\{ -2 (\tilde{p}_{jit}^r - e_{it}) e_{kt} + 2 (\tilde{p}_{jit}^r - e_{it}) \tilde{p}_{ji}^r(k) - (\tilde{p}_{ji}^r(k) - e_{kt})^2 \right\}. \quad (\text{A15})$$

Consider separately each term of this expression and focus on expectations conditional on information in period $t = 0$. Using the stationarity properties of the model, which imply that $\mathbb{E}_0 \left(\tilde{p}_{ji\tau+t}^r - e_{i\tau+t} \right) \Delta e_{k\tau}$ is

¹While this approach is less accurate than the approximation around the steady-state with Calvo price adjustment (see e.g. [Ascari and Sbordone 2014](#)), it is much more tractable and has similar quantitative implications for low values of inflation.

independent of τ , the first term can be expressed as

$$\begin{aligned}\mathbb{E}_0 \sum_{t=0}^{\infty} (\beta\lambda^r)^t (\tilde{p}_{jit}^r - e_{it}) e_{kt} &= \mathbb{E}_0 \sum_{t=0}^{\infty} (\beta\lambda^r)^t (\tilde{p}_{jit}^r - e_{it}) \sum_{\tau=0}^t \Delta e_{k\tau} = \mathbb{E}_0 \sum_{\tau=0}^{\infty} \sum_{t=\tau}^{\infty} (\beta\lambda^r)^t (\tilde{p}_{jit}^r - e_{it}) \Delta e_{k\tau} \\ &= \sum_{\tau=0}^{\infty} (\beta\lambda^r)^\tau \sum_{t=0}^{\infty} (\beta\lambda^r)^t \mathbb{E}_0 (\tilde{p}_{ji\tau+t}^r - e_{i\tau+t}) \Delta e_{k\tau} = \frac{1}{1-\beta\lambda^r} \sum_{t=0}^{\infty} (\beta\lambda^r)^t \mathbb{E}_0 (\tilde{p}_{jit}^r - e_{it}) \Delta e_{k0}.\end{aligned}$$

For the second term of (A15), note that the optimal reset price is equal to a discounted sum of expected desired prices expressed in currency of invoicing k :

$$\bar{p}_{ji}^r(k) = (1-\beta\lambda^r) \mathbb{E}_0 \sum_{t=0}^{\infty} (\beta\lambda^r)^t (\tilde{p}_{jit}^r + e_{kit}) = (1-\beta\lambda^r) \mathbb{E}_0 \sum_{t=0}^{\infty} (\beta\lambda^r)^t (\tilde{p}_{jit}^r - e_{it}) + e_{k0} + \frac{\beta\lambda^r}{1-\beta\lambda^r} \mu_k,$$

where the second equality uses the fact that $\sum_{t=0}^{\infty} x^t t = x \left(\sum_{t=0}^{\infty} x^t \right)'_x = \frac{x}{(1-x)^2}$. It follows that

$$\begin{aligned}\bar{p}_{ji}^r(k) \mathbb{E}_0 \sum_{t=0}^{\infty} (\beta\lambda^r)^t (\tilde{p}_{jit}^r - e_{it}) &= \bar{p}_{ji}^r(k) \left[\frac{\bar{p}_{ji}^r(k)}{1-\beta\lambda^r} - \sum_{t=0}^{\infty} (\beta\lambda^r)^t (e_{k0} + t\mu_k) \right] \\ &= \frac{1}{1-\beta\lambda^r} (\bar{p}_{ji}^r(k))^2 - \frac{\beta\lambda^r}{(1-\beta\lambda^r)^2} \mu_k \bar{p}_{ji}^r(k) - \frac{1}{1-\beta\lambda^r} \bar{p}_{ji}^r(k) e_{k0}.\end{aligned}$$

Finally, the last term is equal

$$\begin{aligned}\mathbb{E}_0 \sum_{t=0}^{\infty} (\beta\lambda^r)^t (\bar{p}_{ji}^r(k) - e_{kt})^2 &= \mathbb{E}_0 \sum_{t=0}^{\infty} (\beta\lambda^r)^t \left[(\bar{p}_{ji}^r(k) - \mu_k t - e_{k0})^2 - 2(\bar{p}_{ji}^r(k) - \mu_k t - e_{k0})(e_{kt} - \mu_k t - e_{k0}) \right. \\ &\quad \left. + (e_{kt} - \mu_k t - e_{k0})^2 \right] = \frac{1}{1-\beta\lambda^r} (\bar{p}_{ji}^r(k) - e_{k0})^2 + [\sigma_k^2 + 2\mu_k e_{k0} - 2\mu_k \bar{p}_{ji}^r(k)] \frac{\beta\lambda^r}{(1-\beta\lambda^r)^2} + \frac{\beta\lambda^r (1+\beta\lambda^r)}{(1-\beta\lambda^r)^3} \mu_k^2,\end{aligned}$$

where the last equality follows from $\sum_{t=0}^{\infty} x^t t^2 = x \left[x \left(\sum_{t=0}^{\infty} x^t \right)'_x \right]'_x = x \left[\frac{x}{(1-x)^2} \right]'_x = \frac{(1+x)x}{(1-x)^3}$.

Combine all three pieces of (A15) together, use the optimal reset price and simplify to obtain

$$\begin{aligned}\mathbb{E}_0 \sum_{t=0}^{\infty} (\beta\lambda^r)^t \left\{ -2(\tilde{p}_{jit}^r - e_{it}) e_{kt} + 2(\tilde{p}_{jit}^r - e_{it}) \bar{p}_{ji}^r(k) - (\bar{p}_{ji}^r(k) - e_{kt})^2 \right\} &= (1-\beta\lambda^r) \left[\mathbb{E}_0 \sum_{t=0}^{\infty} (\beta\lambda^r)^t (\tilde{p}_{jit}^r - e_{it}) \right]^2 \\ &\quad - \frac{\beta\lambda^r}{(1-\beta\lambda^r)^2} \left[2(1-\beta\lambda^r) \sum_{t=0}^{\infty} (\beta\lambda^r)^t \mathbb{E}_0 (\tilde{p}_{jit}^r - e_{it}) (\Delta e_{k0} - \mu_k) + \sigma_k^2 \right] - \frac{\beta\lambda^r}{(1-\beta\lambda^r)^3} \mu_k^2.\end{aligned}$$

Apply the ex-ante expectation operator $\mathbb{E}(\cdot)$ and use the law of iterated expectation. The first term is invariant to currency of invoicing and can be dropped. Rescaling the remaining terms, one gets the expression from Proposition 4.

Price indices in local and foreign markets determine the pass-through of exchange rates into desired prices and hence, the currency choice of exporters. As Proposition 4 makes clear, the main difference of the Calvo model from the baseline static setup is that the currency choice is shaped not only by the contemporaneous pass-through, but also by the lagged ones, i.e. by the reaction of \tilde{p}_{jit}^r to innovations e_{k0} . I next derive the system of dynamic equations that characterizes the impulse responses of aggregate prices to exchange rate shocks. To this

end, rewrite the optimal reset price in a recursive form

$$\bar{p}_{jit}^r(k) = (1 - \beta\lambda^r) (\tilde{p}_{jit}^r + e_{kit}) + \beta\lambda^r \mathbb{E}_t \bar{p}_{jit+1}^r(k)$$

and combine it with the price index law of motion under the Calvo friction

$$p_{jit}^r(k) = (1 - \lambda^r) \bar{p}_{jit}^r(k) + \lambda^r p_{jit-1}^r(k)$$

to obtain the NKPC for bilateral trade flows:

$$[1 + \beta + \kappa^r] p_{jit}^r(k) = p_{jit-1}^r(k) + \kappa^r (\tilde{p}_{jit}^r + e_{kit}) + \beta \mathbb{E}_t p_{jit+1}^r(k), \quad \kappa^r \equiv \frac{(1 - \beta\lambda^r)(1 - \lambda^r)}{\lambda^r}.$$

Convert prices into the currency of destination and aggregate into the market-level price index:

$$[1 + \beta + \kappa^r] p_{it}^r = p_{it-1}^r + \beta \mathbb{E}_t p_{it+1}^r + \kappa^r \sum_{j=1}^N \gamma_{ji}^r \tilde{p}_{jit}^r + \sum_{j=1}^N \sum_{k=1}^K \gamma_{ji}^r \pi_{ji}^r(k) \Delta e_{ikt} - \beta \mathbb{E}_t \sum_{j=1}^N \sum_{k=1}^K \gamma_{ji}^r \pi_{ji}^r(k) \Delta e_{ikt+1},$$

where $\pi_{ji}^r(k)$ is the share of currency k in imports of country i from sector r of country j . Combine this expression with the desired price

$$\tilde{p}_{jit}^r = (1 - \alpha^r) \left(\sum_{r'=1}^S \phi_j^{r'r} p_{jt}^{r'} + (1 - \phi_j^r) w_{jt} + e_{ijt} \right) + \alpha^r p_{it}^r \quad (\text{A16})$$

to get

$$\begin{aligned} [1 + \beta + \kappa^r (1 - \alpha^r)] p_{it}^r &= p_{it-1}^r + \beta \mathbb{E}_t p_{it+1}^r - \beta \mathbb{E}_t \sum_{j=1}^N \sum_{k=1}^K \gamma_{ji}^r \pi_{ji}^r(k) \Delta e_{ikt+1} \\ &+ \sum_{j=1}^N \sum_{k=1}^K \gamma_{ji}^r \pi_{ji}^r(k) \Delta e_{ikt} + (1 - \alpha^r) \kappa^r \sum_{j=1}^N \gamma_{ji}^r \left(\sum_{r'=1}^S \phi_j^{r'r} p_{jt}^{r'} + (1 - \phi_j^r) w_{jt} + e_{ijt} \right). \end{aligned}$$

Finally, rewrite the system in terms of deviations from the trend inflation $\hat{p}_{it}^r \equiv p_{it}^r - w_{it}$ and $\hat{e}_{it} \equiv e_{it} - w_{it}$:

$$\begin{aligned} [1 + \beta + \kappa^r (1 - \alpha^r)] \hat{p}_{it}^r - \hat{p}_{it-1}^r - \beta \mathbb{E}_t \hat{p}_{it+1}^r - (1 - \alpha^r) \kappa^r \sum_{j=1}^N \gamma_{ji}^r \sum_{r'=1}^S \phi_j^{r'r} \hat{p}_{jt}^{r'} \\ = (1 - \alpha^r) \kappa^r \left[\hat{e}_{it} - \sum_{j=1}^N \gamma_{ji}^r \hat{e}_{jt} \right] + \left[\Delta \hat{e}_{it} - \sum_{j=1}^N \sum_{k=1}^K \gamma_{ji}^r \pi_{ji}^r(k) \Delta \hat{e}_{kt} \right] - (1 - \beta) \sum_{j=1}^N \sum_{k=1}^K \gamma_{ji}^r \pi_{ji}^r(k) \mu_k. \end{aligned} \quad (\text{A17})$$

Intuitively, the first three terms on left-hand side are the standard terms of the NKPC representing a sluggish price adjustment. The fourth term is due to the fact that the optimal reset price depends through input-output linkages and pricing-to-market on prices set by other firms. The levels of exchange rates on the right-hand side of the equation convert firms' marginal costs into local currency, while the first differences of exchange rates represent the automatic change in prices that remain sticky in foreign currency. Finally, the last term is a standard source of monetary non-neutrality in models with the New-Keynesian Phillips curve (see e.g. [Mankiw and Reis 2002](#)), which is, however, quantitatively small under standard calibration with $\beta \approx 1$ and therefore, can be ignored when solving for the currency choice.

The second-order system of linear dynamic equations (A17) can then be solved using the Blanchard-Kahn

method to express current prices in terms of lagged values, exchange rates and innovations to exchange rates:

$$\hat{p}_t = M_1 \hat{p}_{t-1} + M_2 \hat{e}_t + M_3 \Delta \hat{e}_t.$$

Although straightforward to implement, this step can only be done numerically. To compute the sufficient statistic for currency choice, denote with Λ a $NS \times NS$ matrix with $\beta\lambda^r$ on the main diagonal and zero off-diagonal elements. The discounted sum of the pass-through coefficients (in matrix form) can be calculated as follows:

$$\begin{aligned} (I - \Lambda) \sum_{t=0}^{\infty} \Lambda^t \mathbb{E} \hat{p}_t \Delta \hat{e}_0^T &= (I - \Lambda) \sum_{t=0}^{\infty} \Lambda^t \mathbb{E} \sum_{j=0}^t M_1^j (M_2 \hat{e}_{t-j} + M_3 \Delta \hat{e}_{t-j}) \Delta \hat{e}_0^T \\ &= (I - \Lambda) \sum_{t=0}^{\infty} \Lambda^t \left[\sum_{j=0}^t M_1^j M_2 + M_1^t M_3 \right] \Sigma = (I - \Lambda) \sum_{t=0}^{\infty} \Lambda^t \left[(I - M_1)^{-1} (I - M_1^{t+1}) M_2 + M_1^t M_3 \right] \Sigma, \\ &= (I - M_1)^{-1} M_2 \Sigma - (I - \Lambda) \left[\sum_{t=0}^{\infty} \Lambda^t (I - M_1)^{-1} M_1^t \right] M_1 M_2 \Sigma + (I - \Lambda) \left[\sum_{t=0}^{\infty} \Lambda^t M_1^t \right] M_3 \Sigma, \end{aligned} \quad (\text{A18})$$

where I is an identity matrix. Note that the infinite sums can be expressed as solutions to the Sylvester equation:

$$\begin{aligned} X &\equiv \sum_{t=0}^{\infty} \Lambda^t M_1^t = I + \Lambda X M_1 \quad \Rightarrow \quad \Lambda^{-1} X - X M_1 = \Lambda^{-1}, \\ Y &\equiv \sum_{t=0}^{\infty} \Lambda^t (I - M_1)^{-1} M_1^t = (I - M_1)^{-1} + \Lambda Y M_1 \quad \Rightarrow \quad \Lambda^{-1} Y - Y M_1 = \Lambda^{-1} (I - M_1)^{-1}. \end{aligned}$$

Numerical algorithm to solve the model includes the following steps:

1. Make initial guess about invoicing shares $\pi_{ji}^r(k)$ for each bilateral trade flow jir and currency k .
2. Solve the system of dynamic equations (A17) using the Blanchard-Kahn method:
 - (a) rewrite the equations in a matrix form as a first-order dynamic system,
 - (b) factorize the matrix on the left-hand side by finding its eigenvalues and eigenvectors,
 - (c) find the cointegration relationship and solve for M_1 , M_2 and M_3 .
3. Compute discounted sum of pass-through coefficients into aggregate prices using (A18).
4. Calculate discounted sum of pass-through into bilateral desired prices (A16) and the sufficient statistic for currency choice from Proposition 4.
5. Solve for the optimal currency choice making sure that
 - (a) domestic flows are in local currency,
 - (b) firms can only choose among selected vehicle currencies,
 - (c) firms change invoicing only if benefits are higher than fixed costs.
6. Update $\pi_{ji}^r(k)$ and iterate until convergence.

Computationally, the most costly step in this algorithm is factorizing system (A17), which involves finding $N \times S$ eigenvalues. Fortunately, there is no need to do this at every iteration of the algorithm because the left-hand side of system (A17) is independent of firms' currency choice. As a result, one can compute matrices M_1 and M_2 and most covariance terms in (A18) just one time before searching for the fixed point.

B.2 Data and calibration

B.2.1 Trade flows

There are three main sources of global input-output tables that have been extensively used in the previous literature: world input-output database (WIOD), OECD inter-country input-output (ICIO) tables, and the Eora multi-region input-output (MRIO) table. While any of these datasets can be used to calibrate the model, I adopt the trade flows from the ICIO tables in the quantitative analysis. The [database](#) covers all bilateral flows between 65 economies (including all OECD, European Union, and most East Asian countries plus the RoW) and 35 two-digit ISIC industries. According to the IMF database of bilateral trade flows in 2015, about 80% of international trade is accounted for by flows between ICIO countries (excluding the RoW), 18% are the flows between ICIO countries and the RoW, and only 2% are the flows between the RoW countries. Out of 21 datasets available from 1995–2015, I use three input-output tables for 1995, 2005 and 2015.

The raw data is adjusted in several ways. First, the tables split both China and Mexico into two economies, which roughly corresponds to services and commodities plus manufacturing. I aggregate these flows to the same sectorial level as the one used for other economies. Second, I drop Kazakhstan and Brunei from the sample and include their trade flows in the RoW. The former economy appears as a separate entity only after 2005, while Brunei is the smallest economy in the sample with no data on invoicing and a fixed exchange rate to Singapore. Third, I drop sector “private households with employed persons”, which uses no intermediates and produces goods exclusively for local final consumption. Finally, because of changes in industry classification, the sector codes for 1995 are from ISIC rev.3, while the codes for 2005 and 2015 are from ISIC rev.4. To mitigate differences in industry classifications across years, I aggregate all mining sectors into one sector in tables that use ISIC rev.4 and combine “renting of machinery and equipment” with “R&D and other business activities” in tables with ISIC rev.3. In sum, there are $N = 63$ countries and $S = 32$ industries left (see Tables [A1](#) and [A2](#) for the full list).

Additional adjustment of trade flows is required because the market is defined by exporting sector r and country of destination i , while in the data there is also variation across importing sectors s . Therefore, I aggregate all trade flows from country j and sector r to country i across sectors s and compute the corresponding trade shares of exporters from j in market ir . Similarly, I compute the country-sector is cost shares on intermediates from each sector r . Multiplying these two matrices of trade shares and input shares, I get the adjusted input-output table that is used for the rest of the analysis. Note that by construction, the new matrix perfectly matches the original cross-country trade flows and sectoral input shares, but is different in terms of sector-to-sector flows. While there are substantial differences in some individual trade shares $\gamma_{ji}^{r,s}$ relative to the original table, the aggregate statistics, such as sectoral import intensities, barely change. At the same time, the aggregation brings down the number of markets and price indices from $N \times S^2 = 64,512$ to $N \times S = 2,016$ significantly reducing the computational burden of the model.

Finally, to capture the fact that there are *global* markets for many commodities with prices highly correlated across economies, I also adjust the international trade flows of commodities in such a way that countries’ market shares are the same across all destinations. Thus, while the exports and imports of commodities remain the same as in the original input-output table, there is significant change in bilateral flows. As a result, the model has only two markets for commodities corresponding to agriculture and mining.

B.2.2 Exchange rates

The covariance matrix of exchange rates is computed using monthly series of bilateral exchange rates from the IMF IFS database. I use monthly averages, which are more robust to outliers and mistakes than the end-of-period values, and focus on log changes in exchange rates. The sample period is 1980–2015, although the series starts later for some economies (e.g. post-soviet countries). All members of the Eurozone are assumed to be on hard peg to the euro, while Saudi Arabia and Hong Kong are assumed to have a permanent peg to the dollar given almost no variation in their exchange rates against the U.S. Table [A2](#) summarizes which European countries adopted the euro in each subperiod.

Since there is no readily available exchange rate for the RoW, some extrapolations are required to compute its covariances with the exchange rates of other economies. Taking the cross-country averages does not solve the issue as it eliminates the idiosyncratic component and results in highly unrealistic moments. Using more complicated transformations, on the other hand, can result in a covariance matrix that is not positive-semidefinite. Therefore, I take a different route and assume instead that the RoW pegs its nominal exchange rate to a bundle of dollars and euros. Indeed, according to the classification of [Ilzetki, Reinhart, and Rogoff \(2019\)](#) for 124 countries not included in ICIO table from 1995–2015, about 50% of economies have a fixed exchange rate, 47% implement a “crawling peg” or a “managed float”, and only 0.3% allow for a free floating exchange rate with the remaining currencies freely falling. I use the trade-weighted share of countries with the dollar as an anchor currency equal to 95.4% to calibrate the share of the dollar in the bundle targeted by the RoW.

B.2.3 Other parameters

Markups would be irrelevant if the data included labor costs in addition to the spendings on intermediate goods. Instead, the ICIO table reports only the total value added of a sector, which is the sum of labor costs and profits. To make the necessary adjustment, I use the markup estimates based on firms’ accounting profits for U.S. publicly listed firms in Compustat from [Baqae and Farhi \(2020\)](#). Using constructed mapping between NAICS codes and ICIO classification, I aggregate firm-level estimates into sector-level markups via sales-weighted harmonic average and take a simple average across years from 1995–2015. The resulting markups are positive for all sectors and are close to the alternative measures based on user costs. Given the limitations of the data, I extrapolate these estimates to all countries and periods. The sectoral labor costs are calculated as the difference between value added and profits with the latter inferred from total revenues and average markups. Applying this procedure to the ICIO table of 2015, one gets negative labor expenses for 1.8% country-sector pairs, which account for about 0.7% of global GDP and are mostly concentrated in the petroleum industry. The labor inputs are truncated at zero in this case, which implicitly implies negative profits in these country-sector pairs. Relative to the case with no markup adjustment, the sales-weighted average labor share in world production falls from 48% to 39%, while the labor share in manufacturing falls from 29% to 20%.

Price complementarities are calibrated using the recent estimates (for manufacturing industries) from [Amiti, Itskhoki, and Konings \(2019\)](#). I focus on the estimates for large firms, which account for most of international trade, and assume the same value of $\alpha^r = 0.5$ for all manufacturing and service sectors consistent with the fact that there are no systematic differences between differentiated versus homogeneous industries in the data. At the same time, I use a much higher value of $\alpha^r = 0.99$ for commodities in order to capture the price-taking behavior of firms in these sectors.

Price stickiness is known to exhibit large variation across sectors. The Calvo parameter λ^r is calibrated based on the median frequency of price adjustment (including product substitution and sales) from [Nakamura and Steinsson \(2008\)](#). I use the subcategories of PPI from Table 6 for commodities and manufacturing and the subcategories of CPI from Table 2 for services, interpreting “farm products” as agriculture, “crude materials” as mining, “fuel and related products” as petroleum, “miscellaneous products” as other manufacturing, “transportation equipment” as motor vehicles and other transportation equipment, “furniture and household durables” as computers and electronics. The obtained values for the U.S. are then used for all economies. While this is likely to provide a poor approximation to more inflationary economies, which have a higher frequency of price adjustment ([Alvarez, Beraja, Gonzalez-Rozada, and Neumeier 2019](#)), this fact does not alter the key trade-off for currency choice: it is more costly to set prices in currencies that quickly lose their value independently whether prices are adjusted infrequently, resulting in suboptimal markups, or whether prices are adjusted frequently with firms paying higher menu costs.

Fixed costs of currency change are calibrated as follows. The second-order approximation of firm's profits is

$$\sum_{t=0}^{\infty} (\beta\lambda^r)^t \Pi_{jit}^r = \frac{\Pi}{1 - \beta\lambda^r} - \frac{\Pi_{pp}}{2} \sum_{t=0}^{\infty} (\beta\lambda^r)^t (\tilde{p}_{jit}^r + e_{kit} - \bar{p}_{ji}^r(k))^2,$$

where suppressing market indices, Π is the steady-state value of profits and Π_{pp} is its second derivative:

$$\Pi = (e^p - MC)h(p), \quad \Pi_{pp} = -(\theta - 1)e^p h(p),$$

where $h(p)$ is demand function, $R = e^p h(p)$ are total revenues of an exporter in a given market, and the last expression uses the optimal price-setting condition. Thus, to be compared to the firm's profits from Proposition 4, the menu costs f^r have to be rescaled as follows: $\tau^r = \frac{2}{\theta^r - 1} \frac{(1 - \beta\lambda^r)^2}{\beta\lambda^r} \frac{f^r}{R^r}$. Nakamura and Steinsson (2010), Golosov and Lucas (2007), Levy, Bergen, Dutta, and Venable (1997) report that the share of menu costs in revenues computed as $\frac{(1 - \lambda^r)f^r}{R^r}$ is approximately equal to 0.3–0.7% for sectors with sticky prices. Combining these estimates with λ^r and θ^r from Table A1, we get $\tau^r = 0.3 - 2 \cdot 10^{-4}$. For simplicity, I use the same value of τ^r for all sectors: although the menu costs clearly vary with the probability of price adjustment, expression (17) is scaled in such a way that it is invariant to price stickiness λ^r to the first-order.

Inflation rate matters for currency choice in the model because it generates a positive trend in both nominal wages and exchange rates. On the one hand, inferring this common trend from exchange rates is complicated: the series are highly volatile and are also too short for post-Soviet states in 1995. On the other hand, the data on wage inflation is scarce, while the measures based on CPI inflation suffer from the reverse causality as non-monetary shocks driving exchange rates pass through into import prices with no direct affect on the labor costs of local producers. At the same time, there is high correlation between these two potential measures of nominal trends in the data. Acknowledging these limitations, I calibrate μ_i using harmonic averages of CPI inflation and exchange rate depreciation in each country in a given period. This ensures that countries with hyperinflation, but noisy measures of exchange rate trends have high μ_i , and that countries with prices and exchange rates moving in opposite directions have μ_i close to zero (see Table A2). The three periods used in calibration are 1981–1995, 1991–2005, and 2001–2015. When calculating inflation for countries with a common currency (USD or EUR), I take a GDP-weighted average across economies. The value of inflation in the RoW is irrelevant because it does not have its own currency.

B.2.4 Currency of invoicing

The main source of information regarding currency use in international trade is the recent dataset compiled by the IMF, which provides annual shares of exports and imports invoiced in dollars, euros, and home currencies for more than 100 economies over the period from 1990–2020 (Georgiadis, Le Mezo, Mehl, Casas, Boz, Nguyen, and Gopinath 2020). The panel is not balanced with the coverage relatively sparse for the 1990s and more comprehensive for the 2000s and 2010s. Given these limitations, I adopt the following approach to calculate invoicing shares that maximizes the coverage of countries from the ICIO tables. For each economy in my sample, I first estimate the three-year averages for the periods of 1994–96, 2004–06, and 2014–16. For countries with no invoicing data for these years, I use a larger window of five years, i.e. the averages over 1992–98, 2002–08, and 2012–18.² I drop observations for Malaysia before the 2010s because most of invoicing is not classified. This procedure allows me to get invoicing shares for about 18% of global trade in the 1990s, 62% in the 2000s and 63% in the 2010s with the main limitation being the absence of data for China.

Aside from the aggregation issues, one important source of measurement error is the fact that while most of the numbers represent the currency of invoicing, a few countries (Cambodia, Malaysia, South Korea, Bulgaria,

²Note that the sum of invoicing shares might be greater than one in the case when the data on different currencies is available for different years, although this happens in only two cases in the sample.

Italy, Russia, Brazil) report, at least for some years, the currency of settlements instead. Although the data suggests that exporters use predominantly the same currency for pricing and payments (Friberg and Wilander 2008), the empirical evidence is scarce. More importantly, the invoicing data is usually collected by customs authorities and covers mostly merchandise trade, while the settlement data comes from central banks and includes payments for both goods and services. I compare empirical numbers to the model-implied invoicing shares for commodities and manufacturing, excluding services, which can result in discrepancies for the countries mentioned above.

To analyze the bilateral and sectoral invoicing I use data from Switzerland in 2015, which was generously shared with me by Philip Saure (Bonadio, Fischer, and Sauré 2020). The dataset includes the value of imports and exports invoiced in Swiss francs, euros, and dollars at the trade partner-product level. To match this data with the classification of the sectoral trade flows, I map HS 2-digit codes to ISIC rev.3 sector codes. For duplicates, I keep the ISIC sector code that is most frequently matched to the HS commodity. Given the coverage of the dataset, only manufacturing sectors are used. For consistency, I compute the currency shares at the trade partner-sector level and then aggregate to the country or sector level using the weights from the ISIC table. The trade shares are somewhat different in the dataset with invoicing, but the results are robust to using different weights.

B.3 Counterfactuals

B.3.1 Counterfactual trade flows

Following the previous international macro literature, the baseline model abstracts from the fundamentals that determine the size of the economies and the bilateral trade flows between them. Instead, the steady-state flows are fully determined by exogenous demand shifters γ_{ji}^r , which are calibrated to match exactly the world input-output table. However, once we are interested in the future of the international price system, these trade shares can no longer be taken as primitives and one needs to forecast future trade flows. For this counterfactual, I follow a standard approach in international trade and use a multisector gravity model, in which country-sector productivities, capital imbalances, and iceberg trade costs are the primitives that determine the equilibrium flows between economies (see Eaton and Kortum 2002, Caliendo and Parro 2015, Allen, Arkolakis, and Takahashi 2020). For consistency, the standard gravity model is extended to allow for pricing-to-market.

Consider the equilibrium system that fully characterizes the flexible-price steady state of the economy. Following the trade literature, all prices are expressed in the same currency, i.e. one can think of monetary policy normalizing nominal exchange rates to one. For simplicity, assume CES demand and strategic complementarities in price setting arising from strategic interactions between firms. The optimal price and the marginal costs of exporter from country j and sector r to country i is given by

$$P_{ji}^r = (\vartheta_j^r \tau_{ji}^r MC_j^r)^{1-\alpha^r} (P_i^r)^{\alpha^r}, \quad MC_j^r = \left(\frac{W_j}{A_j^r} \right)^{1-\phi_j^r} \prod_s (P_j^s)^{\phi_j^{sr}}$$

where ϑ_j^r is a constant component of the markup and $1 - \phi_j^r = 1 - \sum_n \phi_j^{nr}$ is the labor share in production. The bilateral trade shares in the market of destination in terms of total sales and quantities sold are respectively

$$S_{ji}^r = \left(\frac{(\tau_{ji}^r \vartheta_j^r MC_j^r)^{1-\alpha^r} (P_i^r)^{\alpha^r}}{P_i^r} \right)^{1-\theta^r} = \left(\tau_{ji}^r \vartheta_j^r \frac{MC_j^r}{P_i^r} \right)^{(1-\theta^r)(1-\alpha^r)} \quad \text{and} \quad s_{ij}^r = \frac{1}{\vartheta_i^r} (S_{ij}^r)^{\frac{1-\theta^r(1-\alpha^r)}{(1-\theta^r)(1-\alpha^r)}},$$

where the sectoral ideal price index P_i^r can be written as

$$(P_i^r)^{(1-\theta^r)(1-\alpha^r)} = \sum_n (\vartheta_n^r \tau_{ni}^r MC_n^r)^{(1-\theta^r)(1-\alpha^r)}.$$

As before the log-linear preferences guarantee that nominal spendings are equal to nominal wages:

$$C_i P_i = W_i, \quad P_i = \prod_r \left(\frac{P_i^r}{\phi_i^{rc}} \right)^{\phi_i^{rc}}.$$

The general equilibrium block of the model is then summarized by the market clearing condition that determines total costs $T_i^r \equiv \sum_j M C_i^r \tau_{ij}^r Y_{ij}^r$ of sector r in country i

$$T_i^r = \sum_j s_{ij}^r \left(\sum_s \phi_j^{rs} T_j^s + \phi_j^{rc} W_j \right)$$

and the country's budget constraint that allows for trade imbalances D_i :

$$\sum_r \sum_j S_{ji}^r \left(\sum_s \phi_i^{rs} M C_i^s Y_i^s + \phi_i^{rc} W_i \right) = \sum_r \sum_j S_{ij}^r \left(\sum_s \phi_j^{rs} M C_j^s Y_j^s + \phi_j^{rc} W_j \right) + D_i.$$

Following [Dekle, Eaton, and Kortum \(2007\)](#), rewrite the equilibrium system using the hat algebra: for arbitrary variable Z , denote the change between the counterfactual value Z' and the original value Z with $\hat{Z} \equiv \frac{Z'}{Z}$:

1. Marginal costs:

$$\hat{M}C_j^r = \left(\frac{\hat{W}_j}{\hat{A}_j^r} \right)^{\phi_j^r} \prod_n \left(\hat{P}_n^r \right)^{\phi_j^{nr}}$$

2. Prices:

$$\left(\hat{P}_i^r \right)^{(1-\theta^r)(1-\alpha^r)} = \sum_n S_{ni}^r \left(\hat{\tau}_{ni}^r \hat{M}C_n^r \right)^{(1-\theta^r)(1-\alpha^r)}$$

3. Market shares:

$$\hat{S}_{ji}^r = \left(\frac{\hat{\tau}_{ji}^r \hat{M}C_j^r}{\hat{P}_i^r} \right)^{(1-\theta^r)(1-\alpha^r)}, \quad \hat{s}_{ji}^r = \left(\frac{\hat{\tau}_{ji}^r \hat{M}C_j^r}{\hat{P}_i^r} \right)^{1-\theta^r(1-\alpha^r)}$$

4. Market clearing:

$$\hat{T}_i^r = \sum_j \hat{s}_{ij}^r \left(\sum_s \omega_{ij}^{rs} \hat{T}_j^s + \omega_{ij}^{rc} \hat{W}_j \right),$$

where $\omega_{ij}^{rs} \equiv \frac{s_{ij}^r \phi_j^{rs} T_j^s}{T_i^r}$ and $\omega_{ij}^{rc} \equiv \frac{s_{ij}^r \phi_j^{rc} W_j}{T_i^r}$ are the initial export shares.

5. Budget constraint:

$$\sum_r \sum_j \hat{S}_{ji}^r \left(\sum_s \zeta_{ji}^{rs} \hat{T}_i^s + \zeta_{ji}^{rc} \hat{W}_i \right) = \varrho_i \sum_r \sum_j \hat{S}_{ij}^r \left(\sum_s \zeta_{ij}^{rs} \hat{T}_j^s + \zeta_{ij}^{rc} \hat{W}_j \right) + (1 - \varrho_i) \hat{D}_i,$$

where $\zeta_{ji}^{rs} \equiv \frac{S_{ji}^r \phi_i^{rs} T_i^s}{\sum_r \sum_j S_{ji}^r \left(\sum_s \phi_i^{rs} T_i^s + \phi_i^{rc} W_i \right)}$ is the initial share of exports from j to i in sector r in gross purchases

of economy i , $\zeta_{ji}^{rc} \equiv \frac{S_{ji}^r \phi_i^{rc} W_i}{\sum_r \sum_j S_{ji}^r \left(\sum_s \phi_i^{rs} T_i^s + \phi_i^{rc} W_i \right)}$ is a similar share of exports from j to i for final consumption,

$\zeta_{ij}^{rs} \equiv \frac{S_{ij}^r \phi_j^{rs} T_j^s}{\sum_r \sum_j S_{ij}^r \left(\sum_s \phi_j^{rs} T_j^s + \phi_j^{rc} W_j \right)}$ and $\zeta_{ij}^{rc} \equiv \frac{S_{ij}^r \phi_j^{rc} W_j}{\sum_r \sum_j S_{ij}^r \left(\sum_s \phi_j^{rs} T_j^s + \phi_j^{rc} W_j \right)}$ are the corresponding shares of flows from i to j in gross income of country i , and $\varrho_i \equiv \frac{\sum_r \sum_j S_{ij}^r \left(\sum_s \phi_j^{rs} T_j^s + \phi_j^{rc} W_j \right)}{\sum_r \sum_j S_{ji}^r \left(\sum_s \phi_i^{rs} T_j^s + \phi_i^{rc} W_i \right)}$ is the ratio of gross income to gross spendings.

Thus, given the elasticities of substitution θ^r , complementarities in price setting α^r , input shares ϕ_i^{rs} , initial trade shares S_{ji}^r , and gross changes in productivities \hat{A}_i^r , trade costs $\hat{\tau}_{ji}^r$, and trade imbalances \hat{D}_i , this system allows to solve for new equilibrium prices and quantities $\hat{M}C_i^r, \hat{P}_i^r, \hat{S}_{ji}^r, \hat{T}_i^r, \hat{W}_i$ without calculating original trade costs or productivities.

Instead, I treat changes in productivities as endogenous and calibrate the model to the predicted changes in real GDP. Abstracting from the differences between GDP and gross national income (GNI), which are small and hardly affect the results, these changes correspond to \hat{C}_i . Given little availability of sectoral forecasts, I assume the same productivity growth rates within each country $\hat{A}_i^r = \hat{A}_i$ and compute the fixed point using the following algorithm:

- make an initial guess for changes in endogenous variables (e.g. $\hat{Z} = 1$),
- given $\left\{ \frac{\hat{W}_i}{\hat{A}_i} \right\}$, solve the first three equations for prices and trade shares,
- given $\{\hat{P}_i\}$, compute nominal wages as $\hat{W}_i = \hat{P}_i \hat{C}_i$ and update productivities $\hat{A}_i = \frac{\hat{W}_i}{\hat{W}_i / \hat{A}_i}$,
- given $\left\{ \hat{W}_i, \hat{S}_{ij}^r \right\}$, solve the market clearing conditions for $\left\{ \hat{T}_j^r \right\}$,
- given $\left\{ \hat{T}_i^r, \hat{S}_{ij}^r, \hat{A}_i \right\}$, solve the budget constraints for $\left\{ \frac{\hat{W}_i}{\hat{A}_i} \right\}$ and iterate until convergence.

Although the implied changes in productivities are highly correlated with GDP growth rates used for calibration, the two numbers do not coincide due to international spillovers, which are especially pronounced for more open economies and the countries with growth rates substantially different from the average growth of global economy.

B.3.2 Calibration

The baseline model predicts that the counterfactual currency choice depends on changes in trade flows and exchange rate behavior. Estimating the new input-output table and the covariance matrix of exchange rates requires the calibration of additional parameters. First, from the gravity model it follows that changes in trade shares depends crucially on the elasticity of substitution between products. I borrow the sectoral estimates from [Caliendo and Parro \(2015\)](#) (see Table A1). Second, one needs to calibrate exogenous shocks $\{\hat{A}_i^r, \hat{\tau}_{ji}^r, \hat{D}_i\}$ transforming the structure of global trade. For simplicity, I assume no changes in current account imbalances $\hat{D}_i = 1$ or trade costs $\hat{\tau}_{ji}^r = 1$ and focus instead on long-run economic growth \hat{A}_i^r . Because of data limitations, the growth rates are assumed to be the same across all sectors within each country. The changes in real consumption $\{\hat{C}_i\}$ are calibrated to match the growth rates of real GDP between 2015–2025 using the actual values from 2016–2019 and the forecasts from the IMF World Economic Outlook for the rest of the years. The global averages are used for the RoW. The mean annual growth rates reported in Table A2 are then applied to the whole forecast horizon of 20 years. Note that input shares ϕ_i^r , elasticities θ^r , complementarities in price-setting α^r , and price stickiness λ^r are assumed to stay the same across years.

A switch of China to a floating regime is modelled by assuming that China has the same exchange rate volatility as the dollar in 2001–2015 and a zero correlation with other exchange rates once they are expressed against an unweighted bundle of floating currencies (Australia, Canada, Germany, Japan, New Zealand, Norway, South Africa, Sweden, Switzerland, U.K., U.S.).

B.4 Additional figures and tables

Table A1: Sectors: classification and parameter values

Sector	ISIC codes		Markup	$1 - \lambda^s$	α^s	θ^s
	rev.3	rev.4				
Commodities						
Agriculture and forestry	C01T05AGR	D01T03	1.14	0.88	0.99	8.1
Mining	C10T14MIN	D05T06, D07T08, D09	1.17	0.99		15.7
Manufacturing						
Food, beverages and tobacco	C15T16FOD	D10T12	1.15	0.27	0.50	2.6
Textiles and wearing apparel	C17T19TEX	D13T15	1.07	0.04		5.6
Wood	C20WOD	D16	1.10	0.04		10.8
Paper and printing	C21T22PAP	D17T18	1.09	0.09		9.1
Coke and refined petroleum	C23PET	D19	1.12	0.49		51.1
Chemicals and pharmaceuticals	C24CHM	D20T21	1.25	0.11		4.8
Rubber and plastic	C25RBP	D22	1.12	0.04		1.7
Other non-metallic products	C26NMM	D23	1.09	0.06		2.8
Basic metals	C27MET	D24	1.10	0.05		8.0
Fabricated metal products	C28FBM	D25	1.12	0.05		8.0
Computer and electronics	C30T33XCEQ	D26	1.11	0.06		10.6
Electrical equipment	C31ELQ	D27	1.07	0.06		10.6
Machinery and equipment	C29MEQ	D28	1.12	0.05		1.5
Motor vehicles	C34MTR	D29	1.06	0.45		0.4
Other transport equipment	C35TRQ	D30	1.12	0.45		0.4
Other manufacturing	C36T37OTM	D31T33	1.13	0.17		5.0
Services						
Utilities	C40T41EGW	D35T39	1.18	0.07	0.50	5.0
Construction	C45CON	D41T43	1.08			
Wholesale and retail	C50T52WRT	D45T47	1.05			
Transportation and storage	C60T63TRN	D49T53	1.10			
Accommodation and food services	C55HTR	D55T56	1.12			
Post and telecommunications	C64PTL	D58T60, D61	1.18			
IT services	C72ITS	D62T63	1.12			
Finance and insurance	C65T67FIN	D64T66	1.50			
Real estate	C70REA	D68	2.68			
Other services	C71RMQ, C73T74OBZ	D69T82	1.13			
Public administration	C75GOV	D84	1.11			
Education	C80EDU	D85	1.15			
Health	C85HTH	D86T88	1.10			
Arts and entertainment	C90T93OTS	D90T96	1.10			

Note: the table shows the sector classification used in the analysis, the mapping into ISIC codes from ICIO tables, the sectoral values of markups, monthly probability of price adjustment $1 - \lambda^s$, degree of complementarities in price setting α^s , and the elasticity of substitution between individual products θ^s .

Table A2: Country characteristics

Country	Inflation rate			Eurozone		Growth rate
	1995	2005	2015	2005	2015	
Australia	4.0	1.0	0.7			1.9
Austria	-0.1	1.2	0.7	✓	✓	1.4
Belgium	0.9	1.2	0.7	✓	✓	1.0
Canada	2.1	0.6	0.9			1.5
Chile	16.3	4.6	2.6			1.7
Czech Republic	6.0	2.7	0.0			2.4
Denmark	1.3	0.9	0.7			1.6
Estonia	23.2	8.5	0.7		✓	2.8
Finland	2.3	1.2	0.7	✓	✓	1.4
France	2.0	1.2	0.7	✓	✓	1.1
Germany	-0.3	1.2	0.7	✓	✓	1.1
Greece	13.3	1.2	0.7	✓	✓	1.2
Hungary	12.1	11.1	2.6			2.7
Iceland	19.4	1.8	4.3			2.1
Ireland	2.9	1.2	0.7	✓	✓	4.3
Israel	59.5	5.8	1.0			3.0
Italy	5.1	1.2	0.7	✓	✓	0.4
Japan	-2.1	-0.6	0.4			0.5
Korea	3.0	3.0	1.4			2.3
Latvia	94.1	35.6	0.7		✓	2.8
Lithuania	130.2	45.4	0.7		✓	2.8
Luxembourg	1.0	1.2	0.7	✓	✓	2.1
Mexico	44.6	10.9	4.3			1.0
Netherlands	-0.4	1.2	0.7	✓	✓	1.5
New Zealand	4.5	0.0	0.0			2.0
Norway	2.9	1.1	1.2			1.5
Poland	62.5	13.5	1.3			3.2
Portugal	9.7	1.2	0.7	✓	✓	1.0
Slovak Republic	8.7	4.8	0.7	✓	✓	2.6
Slovenia	88.2	19.3	0.7	✓	✓	2.4
Spain	4.7	1.2	0.7	✓	✓	1.5
Sweden	3.9	1.8	0.5			1.6
Switzerland	-0.6	0.5	-1.2			1.2
Turkey	49.2	49.9	12.5			2.9
United Kingdom	3.5	1.2	1.3			1.0
United States	1.2	0.9	1.3			1.7
Argentina	266.6	12.2	18.2			-0.3
Brazil	377.4	180.4	5.9			0.6
Bulgaria	69.1	79.3	1.9			2.7
Cambodia	17.3	8.1	2.8			6.1
China	11.2	3.7	0.6			5.9
Colombia	21.3	11.9	3.9			2.0
Costa Rica	20.6	11.9	6.1			2.2
Croatia	239.7	83.8	1.0			2.3

Table A2: Country characteristics (continued)

Country	Inflation rate			Eurozone		Growth rate
	1995	2005	2015	2005	2015	
Cyprus	2.5	1.7	0.7		✓	2.6
India	9.0	6.3	4.9			5.3
Indonesia	8.1	11.3	5.3			4.5
Hong Kong	1.2	0.9	1.3			1.5
Malaysia	1.5	2.2	1.8			4.2
Malta	0.6	1.6	0.7		✓	3.7
Morocco	5.0	1.6	0.8			2.2
Peru	341.1	25.4	1.5			2.2
Philippines	10.2	5.3	2.0			5.0
Romania	90.7	64.5	6.3			3.4
Russia	125.7	62.5	8.9			1.1
Saudi Arabia	1.2	0.9	1.3			1.2
Singapore	-0.8	0.1	0.5			1.9
South Africa	11.4	6.4	5.1			0.5
Taiwan	-0.4	1.2	0.8			1.7
Thailand	2.3	3.1	0.9			2.7
Tunisia	5.4	3.1	3.3			1.5
Vietnam	90.0	3.6	5.5			6.4
RoW	-	-	-	-	-	2.6

Note: the table shows the estimated rates of inflation across countries and years, the members of the Eurozone in a given period, and the productivity growth rates used in the counterfactual analysis.

Table A3: Import share and exchange rate pass-through

Country	Import share (%)				Pass-through (%)			
	total	manufacturing	weighted	w/o pegs	home	EUR	USD	RMB
	(1)	(2)	(3)	(4)	(5)	(6)	(7)	(8)
Australia	10	45	57	57	25	10	19	17
Austria	23	48	55	26	58	—	11	7
Belgium	27	49	55	28	50	—	15	7
Canada	18	43	51	51	26	7	34	13
Chile	16	43	58	58	22	10	21	19
Czech Republic	28	51	55	55	20	32	12	10
Denmark	23	50	57	57	25	24	12	8
Estonia	30	62	71	42	42	—	13	12
Finland	18	36	45	26	52	—	12	8
France	16	45	58	35	52	—	15	9
Germany	17	32	38	26	57	—	12	8
Greece	18	42	60	44	44	—	14	10
Hungary	37	62	68	68	12	40	12	9
Iceland	22	55	72	72	15	21	19	10
Ireland	44	44	63	38	46	—	19	6
Israel	16	34	47	47	30	17	17	10
Italy	14	28	35	18	60	—	12	7
Japan	9	15	25	25	56	5	11	13
Korea	17	23	25	25	38	7	17	15
Latvia	21	56	68	34	48	—	14	8
Lithuania	31	52	60	32	48	—	15	7
Luxembourg	52	54	62	42	52	—	20	5
Mexico	21	43	56	56	23	8	30	16
Netherlands	22	37	44	25	52	—	16	8
New Zealand	13	38	51	51	29	10	17	15
Norway	18	45	56	56	25	18	13	10
Poland	20	41	55	55	24	29	12	11
Portugal	21	47	59	16	61	—	12	7
Slovak Republic	32	62	67	46	41	—	14	11
Slovenia	28	58	62	31	52	—	14	9
Spain	15	32	42	24	56	—	13	9
Sweden	19	42	49	49	32	26	11	7
Switzerland	22	48	58	58	25	34	13	8
Turkey	13	30	43	43	36	17	15	10
United Kingdom	15	45	52	52	32	24	14	10
United States	8	25	33	32	59	7	—	12
Argentina	7	13	28	28	49	6	14	11
Brazil	8	16	23	23	48	9	16	10
Bulgaria	27	52	62	62	14	31	15	8
Cambodia	28	46	58	58	23	5	16	25
China	7	9	15	15	51	6	17	—
Colombia	13	34	51	51	30	10	23	14
Costa Rica	18	48	67	67	21	8	34	12
Croatia	20	45	55	55	25	35	13	7
Cyprus	29	65	75	35	43	—	17	10
India	12	18	27	27	34	7	21	14
Indonesia	11	20	31	31	36	6	18	14
Hong Kong	24	35	57	48	44	7	—	18

Table A3: Import share and exchange rate pass-through (continued)

Country	Import share (%)				Pass-through (%)			
	total (1)	manufacturing (2)	weighted (3)	w/o pegs (4)	home (5)	EUR (6)	USD (7)	RMB (8)
Malaysia	24	36	45	45	16	8	22	18
Malta	46	75	81	40	45	—	16	7
Morocco	25	50	64	64	16	29	19	11
Peru	13	29	46	46	30	8	20	16
Philippines	17	28	48	48	28	8	18	14
Romania	18	37	50	50	29	32	10	7
Russia	11	23	35	35	38	14	15	13
Saudi Arabia	25	53	67	53	42	14	—	13
Singapore	32	39	54	54	16	9	27	12
South Africa	15	36	50	50	21	14	21	18
Taiwan	23	30	34	34	30	7	20	14
Thailand	25	36	55	55	18	8	19	19
Tunisia	24	45	54	54	22	29	16	10
Vietnam	26	40	54	54	11	7	19	24
RoW	14	31	38	38	—	14	46	13
Mean	15	31	39	35	44	11	21	12

Note: columns 1 and 2 show the import-to-sales ratio respectively at the aggregate level and exclusively for markets of manufacturing goods. The remaining columns focus on statistics computed at market level and then aggregated across manufacturing goods using imports as weights. Column 4 excludes imports from economies with a hard peg to the currency of the home country. The remaining columns report the pass-through of respectively home, euro, dollar and renminbi exchange rates into markets of manufacturing goods under flexible prices taking into account the whole global input-output production structure. The last row shows the import-weighted average across countries with pass-throughs averaged only across countries that are not issuers of the respective currency.

Table A4: Foreign inputs and exchange rates in exports

Country	Share of foreign inputs (%)			Pass-through (%)			
	total	manufacturing	w/o pegs	home	EUR	USD	RMB
	(1)	(2)	(3)	(4)	(5)	(6)	(7)
Australia	23	41	41	47	5	19	10
Austria	23	30	14	73	—	8	4
Belgium	28	39	23	60	—	15	6
Canada	27	39	39	48	4	25	8
Chile	21	33	33	54	5	15	10
Czech Republic	32	37	37	43	23	9	6
Denmark	27	26	26	63	11	7	4
Estonia	34	45	29	58	—	11	8
Finland	23	29	20	65	—	11	6
France	20	29	17	72	—	10	4
Germany	17	21	13	76	—	7	4
Greece	24	44	38	53	—	19	8
Hungary	41	49	49	35	29	10	6
Iceland	31	42	42	44	9	16	9
Ireland	38	30	21	67	—	14	2
Israel	16	24	24	60	9	12	5
Italy	16	21	12	74	—	9	4
Japan	8	10	10	78	2	7	5
Korea	21	23	23	53	5	14	10
Latvia	23	34	23	64	—	10	6
Lithuania	31	44	35	57	—	15	7
Luxembourg	55	40	21	57	—	15	2
Mexico	29	36	36	51	5	20	10
Netherlands	24	35	22	61	—	15	6
New Zealand	25	38	38	50	5	15	11
Norway	21	30	30	55	9	10	6
Poland	23	31	31	52	17	9	6
Portugal	26	36	16	71	—	10	5
Slovak Republic	38	45	31	56	—	11	7
Slovenia	28	35	17	71	—	9	5
Spain	19	27	17	68	—	11	6
Sweden	19	26	26	62	12	8	4
Switzerland	21	28	28	58	18	9	4
Turkey	16	22	22	64	7	11	6
United Kingdom	14	25	25	64	12	9	4
United States	11	19	15	79	3	—	5
Argentina	22	32	32	56	4	15	9
Brazil	16	24	24	59	5	14	8
Bulgaria	32	45	45	37	16	16	7
Cambodia	28	33	33	57	3	9	14
China	12	13	13	62	4	15	—
Colombia	18	29	29	57	4	17	7
Costa Rica	17	27	27	62	4	17	6
Croatia	21	31	31	55	17	10	5
Cyprus	26	38	25	61	—	12	6
India	19	28	28	48	5	19	10
Indonesia	23	30	30	53	4	15	10
Hong Kong	22	39	33	61	5	—	11

Table A4: Foreign inputs and exchange rates in exports (continued)

Country	Share of foreign inputs (%)			Pass-through (%)			
	total (1)	manufacturing (2)	w/o pegs (3)	home (4)	EUR (5)	USD (6)	RMB (7)
Malaysia	36	43	43	30	7	20	14
Malta	55	51	28	57	—	13	4
Morocco	31	41	41	48	14	14	8
Peru	24	39	39	49	4	19	10
Philippines	21	30	30	57	4	12	8
Romania	19	25	25	59	17	7	4
Russia	18	29	29	54	6	18	8
Saudi Arabia	11	35	21	72	5	—	7
Singapore	31	39	39	34	7	23	6
South Africa	29	42	42	39	7	22	11
Taiwan	21	25	25	51	4	15	9
Thailand	31	40	40	40	5	16	13
Tunisia	32	37	37	50	16	12	7
Vietnam	41	45	45	28	6	18	19
RoW	24	30	30	—	9	61	10
Mean	19	24	21	62	6	15	7

Note: columns 1 and 2 show the share of foreign inputs in country's exports computed respectively at the aggregate level and exclusively for manufacturing exports. The remaining columns focus on statistics computed at sectoral level and then aggregated across manufacturing sectors using exports as weights. Column 3 excludes imports and exports to economies with a hard peg to the currency of the home country. The remaining columns report the pass-through of respectively home, euro, dollar and renminbi exchange rates into exports of manufacturing goods under flexible prices taking into account the whole global input-output production structure. The last row shows the export-weighted average across countries with pass-throughs averaged only across countries that are not issuers of the respective currency.

Table A5: Simulated currency shares by country

Country	Imports			Exports		
	LCP	DCP	ECP	PCP	DCP	ECP
Australia	25.6	48.2	9.2	5.8	83.2	1.0
Austria	81.9	17.4	81.9	78.6	19.9	78.6
Belgium	71.9	25.6	71.9	78.9	17.9	78.9
Canada	19.6	74.8	2.8	5.6	91.7	0.9
Chile	10.8	63.8	11.5	5.5	83.4	3.0
Czech Republic	20.3	7.8	68.5	17.7	4.4	72.1
Denmark	47.0	21.6	23.4	41.3	38.7	15.4
Estonia	72.2	22.2	72.2	73.5	23.0	73.5
Finland	63.3	29.5	63.3	62.6	27.9	62.6
France	65.2	32.3	65.2	66.4	29.7	66.4
Germany	77.2	22.4	77.2	76.2	22.0	76.2
Greece	47.0	38.6	47.0	45.4	44.8	45.4
Hungary	5.3	8.2	71.4	10.3	5.7	70.1
Iceland	7.0	34.7	34.2	1.2	27.2	44.5
Ireland	63.6	30.5	63.6	47.1	43.5	47.1
Israel	14.9	45.9	28.2	16.1	56.7	15.1
Italy	58.7	37.0	58.7	60.4	33.0	60.4
Japan	25.6	61.8	7.2	30.9	56.1	5.0
Korea	10.1	64.5	8.6	18.2	64.6	3.6
Latvia	68.6	21.3	68.6	42.4	33.0	42.4
Lithuania	51.7	38.9	51.7	44.5	32.3	44.5
Luxembourg	74.5	24.2	74.5	79.9	17.9	79.9
Mexico	2.4	74.4	9.4	2.3	86.1	2.4
Netherlands	62.5	36.1	62.5	69.4	27.6	69.4
New Zealand	22.3	44.4	11.2	6.9	61.5	4.0
Norway	46.3	25.4	21.7	13.0	77.2	6.0
Poland	9.1	28.8	47.2	10.4	20.3	47.8
Portugal	70.3	26.3	70.3	63.4	29.8	63.4
Slovak Republic	60.8	27.3	60.8	76.9	15.5	76.9
Slovenia	91.6	6.0	91.6	93.6	3.7	93.6
Spain	56.2	38.2	56.2	64.1	28.2	64.1
Sweden	17.4	23.6	42.4	19.7	28.2	29.3
Switzerland	11.2	13.5	62.0	16.4	27.6	46.1
Turkey	0.0	48.8	31.0	0.0	42.7	35.3
United Kingdom	21.4	35.3	35.5	21.4	44.1	24.0
United States	99.6	99.6	0.4	99.7	99.7	0.3
Argentina	0.0	78.6	0.5	0.0	79.9	0.2
Brazil	6.0	35.3	16.4	4.4	67.3	6.9
Bulgaria	0.0	31.6	63.9	0.0	34.3	60.8
Cambodia	0.0	91.2	0.0	0.1	91.7	0.3
China	1.8	84.8	7.9	2.8	88.4	5.3
Colombia	11.8	63.1	12.9	5.1	85.8	1.9
Costa Rica	0.0	99.8	0.2	0.0	99.9	0.1
Croatia	12.6	14.8	67.3	13.4	22.9	49.4
Cyprus	74.8	22.0	74.8	53.5	43.9	53.5
India	3.1	74.5	8.3	5.9	64.8	11.7
Indonesia	1.4	50.6	7.0	1.3	65.0	5.8
Hong Kong	100.0	100.0	0.0	99.0	99.0	1.0
Malaysia	56.8	20.2	5.0	52.8	31.9	3.7

Table A5: Simulated currency shares by country (continued)

Country	Imports			Exports		
	LCP	DCP	ECP	PCP	DCP	ECP
Malta	74.8	16.7	74.8	54.1	45.2	54.1
Morocco	15.5	37.6	43.4	16.8	40.7	38.2
Peru	21.1	66.0	7.5	8.1	82.6	3.8
Philippines	9.9	55.9	6.9	7.6	70.8	6.4
Romania	3.6	14.8	58.5	2.4	25.0	51.9
Russia	1.6	54.9	25.1	0.0	75.2	14.1
Saudi Arabia	99.4	99.4	0.6	100.0	100.0	0.0
Singapore	40.1	56.6	2.2	56.6	40.5	2.9
South Africa	2.9	57.6	19.0	0.8	78.5	9.4
Taiwan	29.2	62.0	4.4	25.5	69.8	3.2
Thailand	14.1	53.7	6.1	19.2	52.2	5.2
Tunisia	11.3	33.4	51.0	2.8	33.0	61.4
Vietnam	0.0	83.2	4.6	0.0	73.8	7.9
RoW	0.0	98.4	1.5	0.0	99.3	0.6

Note: the table shows for each country the model-implied share (in %) of home currency, DCP and ECP in imports and exports. The shares do not have to sum up to one as the categories are not mutually exclusive and there are other categories of invoicing.

Table A6: Currency shares in world trade by sector

	Trade share	PCP	LCP	VCP	DCP	ECP
Agriculture and forestry	3.3	13	12	75	100	0
Mining	11.4	12	13	77	100	0
Food, beverages and tobacco	6.4	31	49	32	55	25
Textiles and wearing apparel	5.5	15	43	47	73	19
Wood	1.0	25	42	42	63	25
Paper and printing	1.6	48	43	23	52	32
Coke and refined petroleum	4.0	35	43	29	62	16
Chemicals and pharmaceuticals	10.7	46	38	27	53	30
Rubber and plastic	3.0	39	43	30	51	34
Other non-metallic products	1.5	29	39	42	63	25
Basic metals	6.1	30	42	39	59	24
Fabricated metal products	3.2	39	42	30	58	30
Computer and electronics	11.8	25	31	47	69	15
Electrical equipment	4.9	28	37	42	62	25
Machinery and equipment	8.1	41	35	33	56	31
Motor vehicles	9.7	47	52	13	49	35
Other transport equipment	4.1	59	32	19	59	23
Other manufacturing	3.7	27	52	27	56	23
Utilities		43	49	29	40	47
Construction		47	54	18	28	50
Wholesale and retail		46	41	23	52	30
Transportation and storage		39	39	29	56	24
Accommodation and food services		45	43	23	58	26
Post and telecommunications		57	35	17	61	26
IT services		48	57	12	39	44
Finance and insurance		60	46	11	46	40
Real estate		46	44	20	57	26
Other services		56	48	11	48	37
Public administration		39	57	21	38	42
Education		62	37	14	61	28
Health		48	46	19	52	31
Arts and entertainment		49	39	21	53	27

Note: the table shows for each sector the model-implied share of international trade (in %) invoiced in a given currency. The shares do not have to sum up to one as the categories are not mutually exclusive. 'Trade share' is the share of a given sector in world merchandise trade (excluding services).

Figure A3: Invoicing patterns across countries

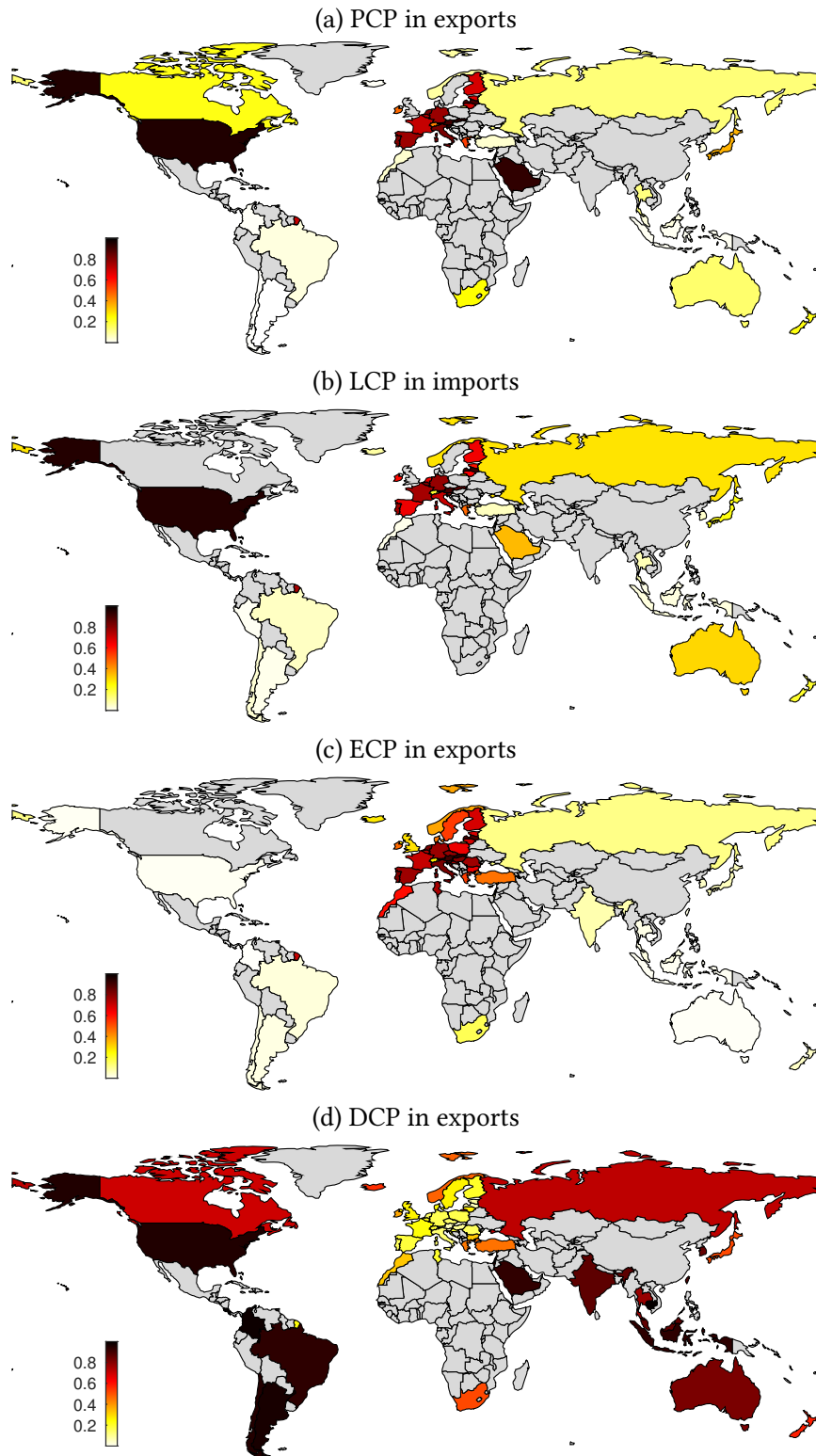

Note: the figure visualises the cross-country invoicing data from [Georgiadis, Le Mezo, Mehl, Casas, Boz, Nguyen, and Gopinath \(2020\)](#). By default, the currency shares are for 2010s, but are simple averages across all years when the data is not available for 2010s.

Figure A4: Inflation rates μ_i

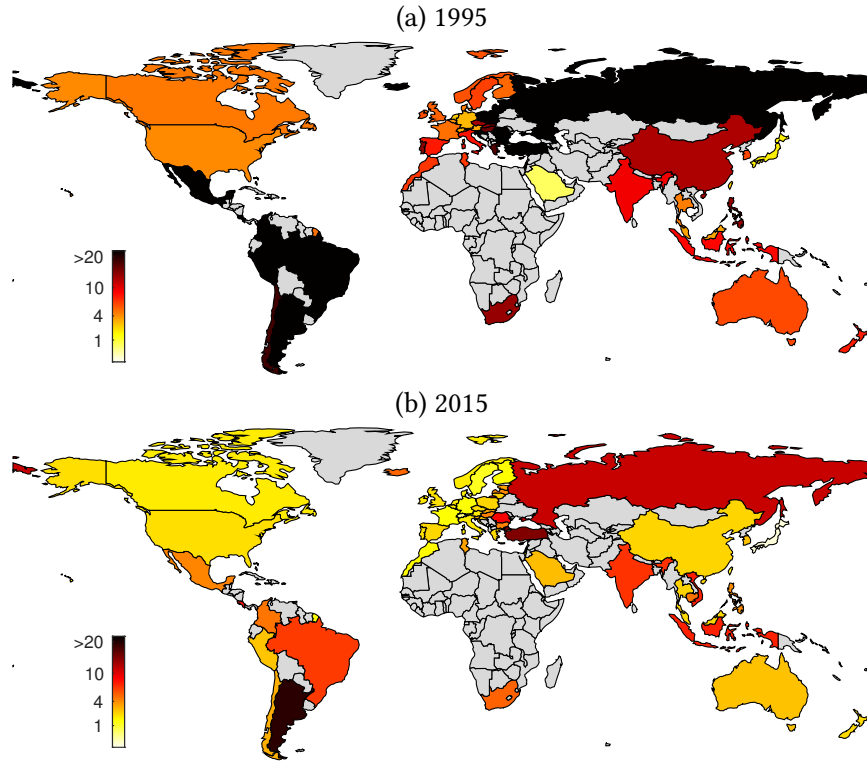

Note: the figure shows a heatmap of average annual inflation rates (%) for countries in 1981–1995 and 2001–2015. The inflation rate is defined as an average of the CPI inflation and the trend in exchange rates.

Figure A5: Pass-through into export prices

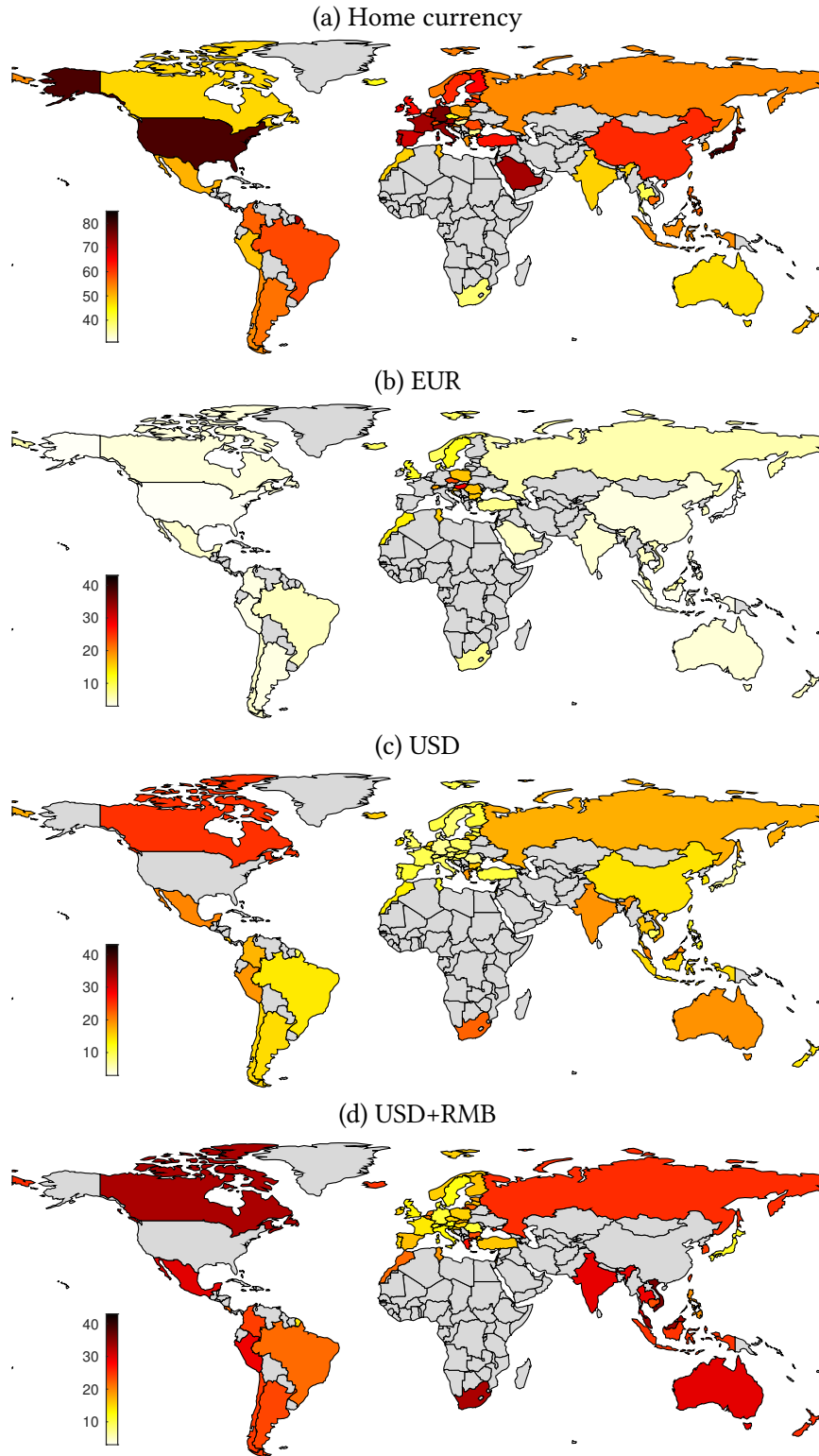

Note: the figure shows the pass-through (%) of home currency, euro, dollar and a combination of dollar and renminbi exchange rates into marginal costs of exporters. All values are computed taking into account the global input-output linkages, are aggregated across sectors using exports as weights, and include only manufacturing sectors.

Figure A6: Pass-through into export prices: 1995 vs. 2015

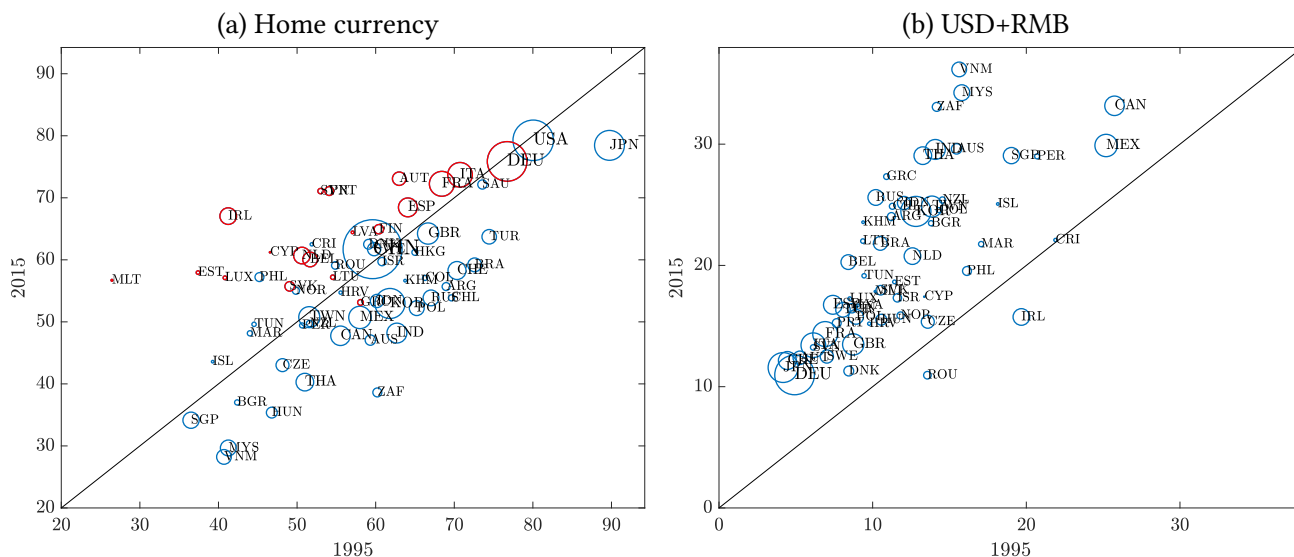

Note: the figure compares the pass-through of exchange rates from Figure A5 with the counterparts estimated for 1995. The size of each circle represents country's share in world exports. The members of the Eurozone are shown in red in panel (a).

Figure A7: Global imports and invoicing

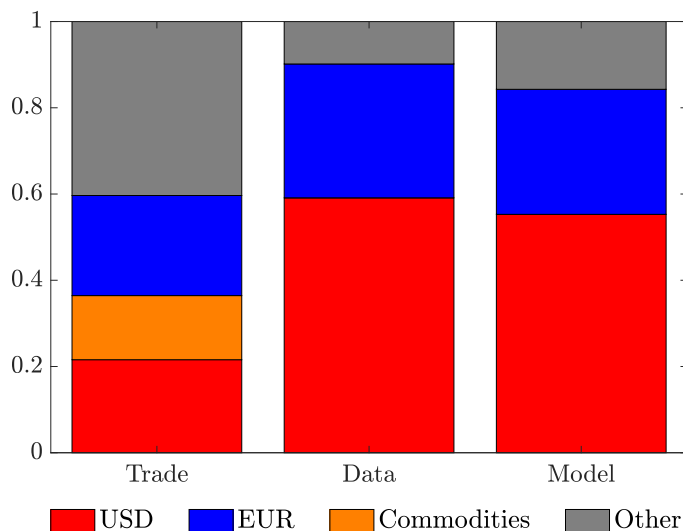

Note: 'Trade' bars show the share of commodity trade and the share non-commodity trade with the dollarized and euroized economies in world imports. 'Data' and 'Model' bars show respectively the empirical and model-implied fraction of imports invoiced in dollars and euros. All numbers are computed for a subsample of countries with available invoicing data.

Figure A8: Cross-country export currency shares: model vs. data

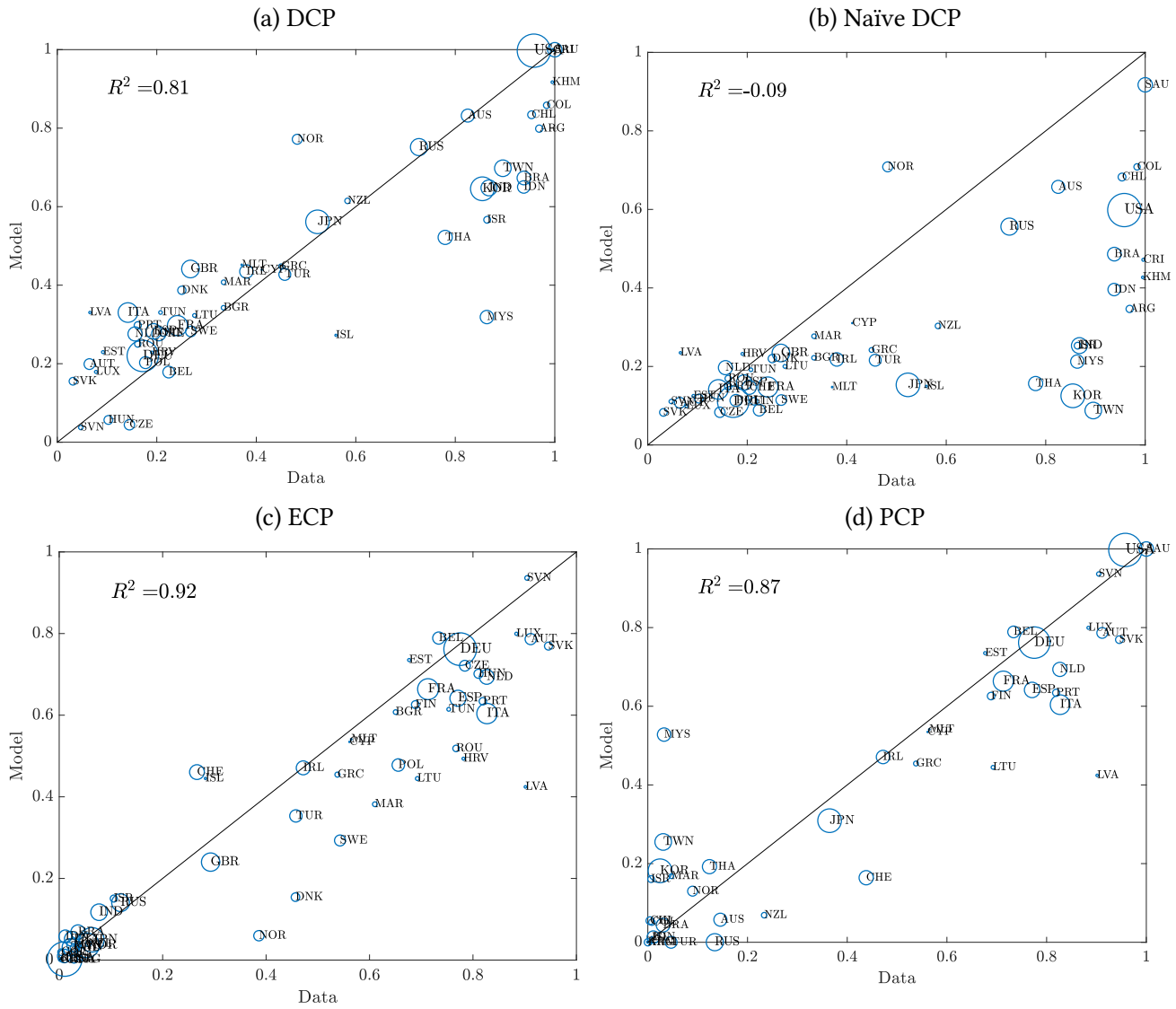

Note: panels (a), (c) and (d) show empirical and model-implied shares of DCP, ECP and PCP in exports. Panel (b) shows a counterfactual share of DCP in exports if commodities were invoiced in dollars and invoicing of other goods were split equally between currencies of the buyer and the seller. The size of circles is proportional to country's share in world exports.

Figure A9: Currency shares in Switzerland by trade partner: model vs. data

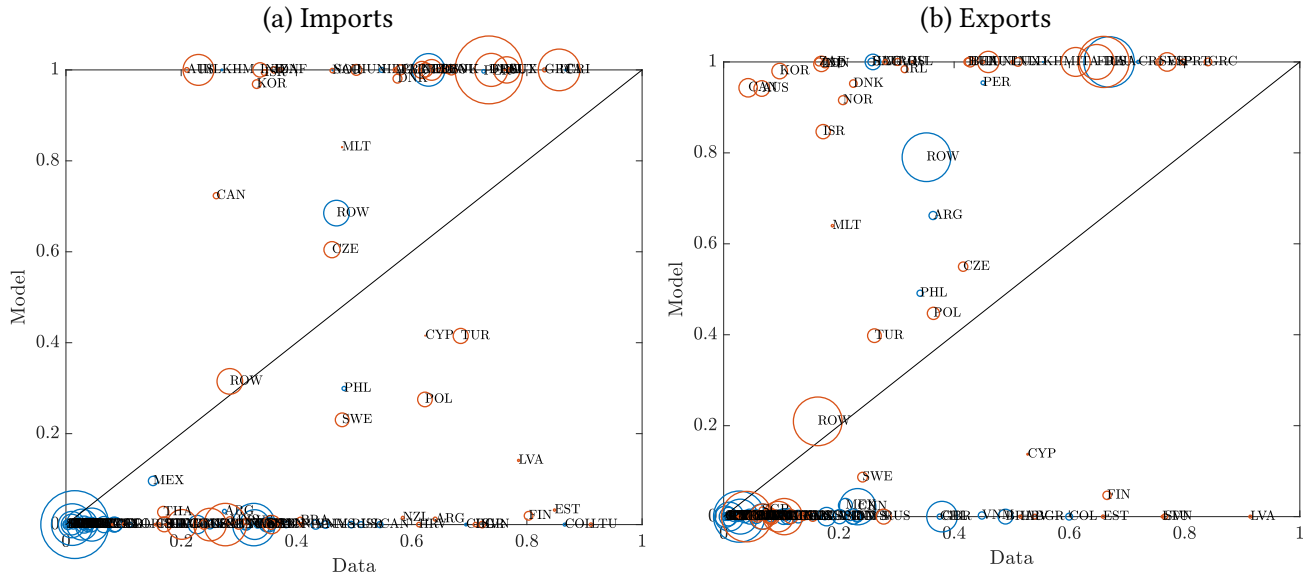

Note: the figure shows the share of DCP (blue) and ECP (red) in imports and exports of Switzerland by its trade partner. The size of circles is proportional to partner's share in Switzerland trade.

Figure A10: Simulated evolution of currency shares in world trade in 1995–2005

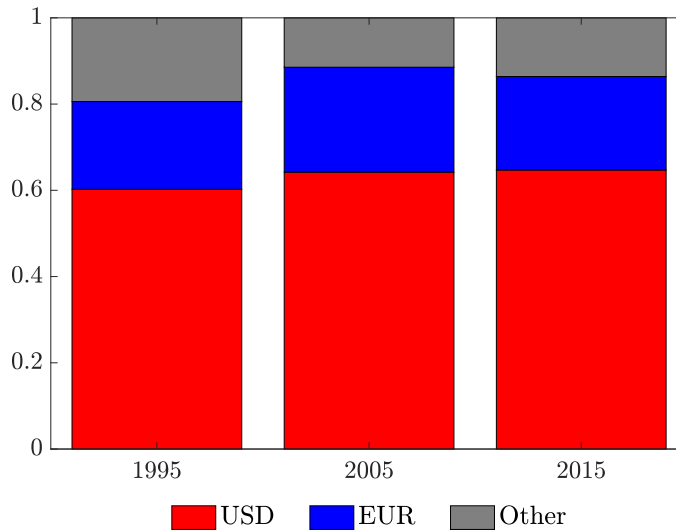

Note: the bars show the model-implied shares of the dollar, euro, and other currencies in global trade in 1995, 2005, 2015. In 1995, the euro corresponds to the German Mark.

Figure A11: Change in currency shares from 2005–2015: model vs. data

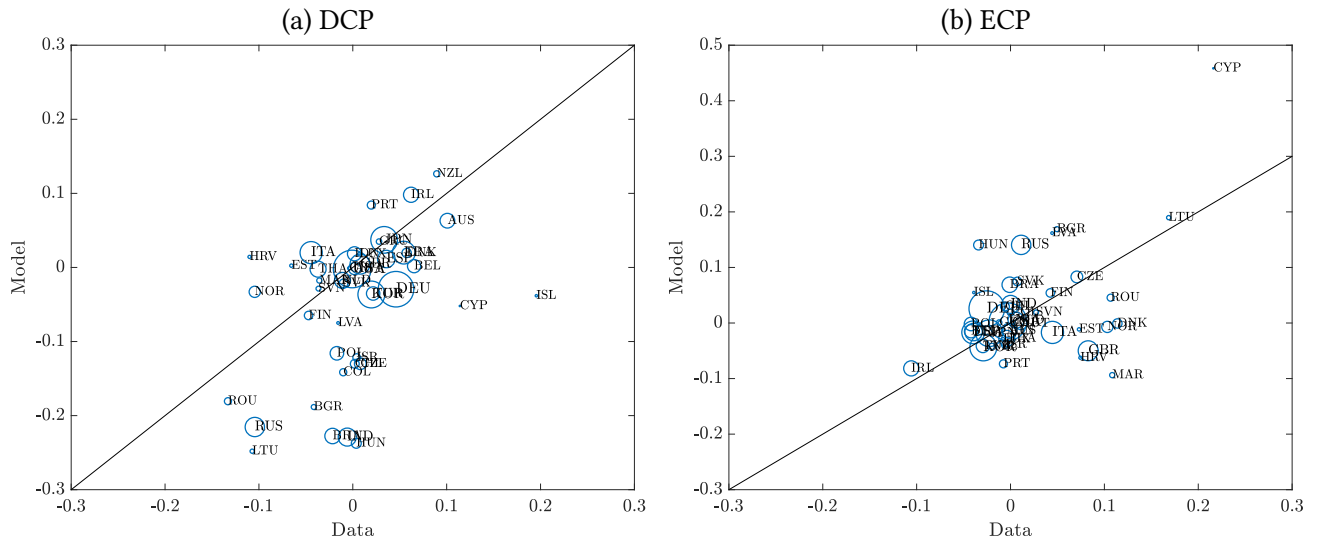

Note: the figures show the change in DCP and ECP shares in countries' exports between 2005 and 2015 comparing empirical numbers with the simulated values. The size of each circle represents country's share in world exports.