

GEORGIA INSTITUTE OF TECHNOLOGY LIBRARY

Regulations for the Use of Theses

Unpublished theses submitted for the Master's and Doctor's degrees and deposited in the Georgia Institute of Technology Library are open for inspection and consultation, but must be used with due regard for the rights of the authors. Passages may be copied only with permission of the authors, and proper credit must be given in subsequent written or published work. Extensive copying or publication of the thesis in whole or in part requires the consent of the Dean of the Graduate Division of the Georgia Institute of Technology.

This thesis by BOB LANIER MARSH
has been used by the following persons, whose signatures attest their acceptance of the above restrictions.

A library which borrows this thesis for use by its patrons is expected to secure the signature of each user.

NAME AND ADDRESS OF USER	BORROWING LIBRARY	DATE
--------------------------	-------------------	------

In presenting the dissertation as a partial fulfillment of the requirements for an advanced degree from the Georgia Institute of Technology, I agree that the Library of the Institution shall make it available for inspection and circulation in accordance with its regulations governing materials of this type. I agree that permission to copy from, or to publish from, this dissertation may be granted by the professor under whose direction it was written, or, in his absence, by the Dean of the Graduate Division when such copying or publication is solely for scholarly purposes and does not involve potential financial gain. It is understood that any copying from, or publication of, this dissertation which involves potential financial gain will not be allowed without written permission.

AN EVALUATION OF A MICROWAVE ANECHOIC CHAMBER

A THESIS

Presented to

The Faculty of the Graduate Division

by

Bob Lanier Marsh

In Partial Fulfillment

of the Requirements for the Degree

Master of Science in Electrical Engineering

Georgia Institute of Technology

August, 1964

AN EVALUATION OF A MICROWAVE ANECHOIC CHAMBER

Approved: ,

[Handwritten Signature]
Chairman

[Handwritten Signature]

[Handwritten Signature]

Date Approved by Chairman:

[Handwritten Date]

ACKNOWLEDGEMENTS

The author wishes to express his genuine appreciation to the people who have helped to make this work possible. Dr. F. Kenneth Hurd, acting as Thesis Advisor gave considerable assistance, suggestions, and advice throughout the entire work. Dr. R. C. Johnson gave many helpful suggestions in the preparation of the thesis. Dr. D. T. Paris originally suggested the problem and also gave many suggestions in the preparation of the thesis.

Sincere thanks is given to Mr. Jimmy M. Van Landingham for his encouragement and many helpful discussions.

TABLE OF CONTENTS

ACKNOWLEDGEMENTS	ii
LIST OF TABLES	iv
LIST OF ILLUSTRATIONS	v
Chapter	
I. INTRODUCTION	1
History	
Definition of the Problem and Purpose of the Research	
Review of Literature	
General Considerations	
II. EVALUATION METHODS	6
Antenna Pattern Measurements	
Radar Cross Section Measurements	
Antenna-coupling and Antenna-impedance Measurements	
III. INSTRUMENTATION AND EQUIPMENT	10
IV. PROCEDURE.	22
Measurement of Quiet Zone Reflectivity	
Measurement of Equivalent Room Radar Cross Section	
Measurement of "Termination VSWR"	
V. RESULTS	30
VI. CONCLUSIONS	31
VII. RECOMENDATIONS	34
APPENDIX	36
BIBLIOGRAPHY	51

LIST OF TABLES

Table

1. Calibration Data for Calculation of Equivalent Room Radar Cross Section	27
2. Return Signal from the Room	27
3. Quiet Zone Reflectivity Results	30

LIST OF ILLUSTRATIONS

Illustration	Page
1. Floor Diagram of the Microwave Free Space Room.	3
2. Equipment Diagram for Measurement of Quiet Zone Reflectivity.	11
3. Transmitting System for Measurement of Quiet Zone Reflectivity.	12
4. Receiving System for Measurement of Quiet Zone Reflectivity.	13
5. Photograph of Receiving Stand for Measurement of Quiet Zone Reflectivity showing Antenna Mounting Platform.	14
6. Photograph of Receiving Stand Showing Angle Indicator and Two Centimeter Increments Marked on Floor for Accomplishing the Horizontal Traverses.	15
7. Orientation of Equipment for Measurement of Quiet Zone Reflectivity.	16
8. Diagram of Equipment for Measurement of Equivalent Room Radar Cross Section	18
9. Photograph of System for Measurement of Equivalent Room Radar Cross Section	19
10. Photograph of System used to Measure "Termination VSWR"	20
11. Diagram of Equipment for Measurement of "Termination VSWR"	21
12. Antenna Pattern Perturbations Caused by Reflections	25
13. Calibration Curves for Determining the Equivalent Room Radar Cross Section	28
14. Index to Deviation Plots	37
15-26. Deviation Plots	38-49
27. 20 db Gain Horns Used in the First Test for Measuring Quiet Zone Reflectivity, in the Test for Measuring Equivalent Room Radar Cross Section, and in the Test for Measuring "Termination VSWR"	50
28. 15 db Gain Horn Used in the Second Test for Measuring Quiet Zone Reflectivity	50

SUMMARY

Much valuable work time is lost on outdoor antenna ranges because of adverse weather conditions. Consequently, many indoor ranges have been constructed. This, in turn, introduces the problem of determining just how accurate are electromagnetic measurements made in a microwave anechoic chamber.

During construction of the new Electrical Engineering Building at the Georgia Institute of Technology, it was suggested that one room be lined with microwave absorbing material in order to produce a room in which general purpose microwave measurements could be made. An explanation of how the room arrived at its final configuration is not possible, but through some oversight the resulting room contains several objectionable features. Among these objectionable features are ceiling lights with metal reflectors, exposed metal air conditioning inlet and outlet, and an exposed metal door frame. It is the purpose of the research to evaluate this "microwave anechoic chamber" in terms of its electromagnetic characteristics in order to determine the expected accuracy of measurements made in the room.

Three performance capabilities corresponding to the three general functional capabilities of 1) radar cross section measurements, 2) antenna-impedance and antenna-coupling measurements, and 3) antenna pattern measurements were investigated. The performance capabilities which correspond to the three functional capabilities listed above are 1) equivalent room radar cross section, 2) "Termination VSWR," and 3) quiet zone reflectivity

level. Cross section measurements made in an anechoic chamber will contain errors caused by reflections from the room. The performance capability of equivalent room radar cross section is thus justified. In investigating the functional capability of antenna-impedance and antenna-coupling measurements, the room may be considered as a termination of the radiating antenna. The VSWR indicated by a probe inserted in the waveguide feeding the transmitting antenna as the system is moved along a line of sight is called the "Termination VSWR". Antenna pattern measurements made in an anechoic chamber contain errors caused by the reflection and refraction of the transmitted signal. The degree of perturbation of the direct transmitted signal can be approximated by making several antenna patterns, all at an equal distance from the transmitting antenna but at slightly different locations, and comparing the variations in the patterns.

Measurements made with approximately 20 db gain horn antennas, located on the major axis of the room, at 9.4 Gc using vertical polarization indicate the following results. The measured equivalent room radar cross section was $0.162 \pm .07 \text{ m}^2$ at an equivalent distance of 3.6 meters and a "Termination VSWR" of 1.0035 ± 0.0002 . The quiet zone reflectivity level was measured to be -34 db. The equivalent room radar cross section and the "Termination VSWR" were compared using the radar equation. This comparison indicated very consistent results. The above results indicate relatively poor room performance when compared with the performance of most anechoic chambers in use today.

It is the author's opinion that the overall room performance could be improved to a small extent by removing the lights and their reflectors and covering the remaining metallic objects with absorbing material.

CHAPTER I

INTRODUCTION

History

The evolution of modern, narrow-beam antennas has created the problem of accurately determining the electrical properties of these antennas. With the imposed question of accuracy of antenna measurements, this problem has in turn produced another highly interesting and important problem, that of determining the electrical characteristics of antenna ranges. In the past, the majority of antenna measurements has been accomplished on outdoor ranges with satisfactory results. However, weather conditions have limited the actual usefulness of outdoor ranges to such an extent that many indoor ranges have been constructed in order to control the many variables which affect measurements. These variables primarily are weather conditions and reflection and refraction from objects near and on the range.

Indoor ranges are constructed by enclosing an area of sufficient size with an electromagnetic radiation absorbing material. Microwave frequencies are usually involved because of the economic limitations of constructing a large room which would be required for lower frequencies and also because many modern antennas are high frequency antennas. These indoor ranges consequently are termed microwave anechoic chambers, microwave free space rooms, or microwave dark rooms.

Microwave free space rooms eliminate weather effects but radiation absorbing materials are not perfect; thus, reflection and refraction still

exist to some degree. The problem of making accurate antenna measurements has consequently produced the new problem of evaluating a free space room in order to determine to what extent the residual reflection and refraction will affect electromagnetic radiation measurements made in the room. The research described in this thesis is in the general area of free space room evaluation.

Definition of the Problem and Purpose of the Research

During construction of the new Electrical Engineering Building at Georgia Institute of Technology it was suggested that one room be lined with absorbing material in order to produce a room in which general purpose microwave measurements could be made. The walls and ceiling of a room were lined with "Eccosorb"* type FR 330 absorbing material and the floor of the room was lined with "Eccosorb" type FR-L 330 absorbing material. An explanation of how the room arrived at its final configuration is not possible but through some oversight the resulting room contains several objectionable features. These objectionable features are listed and described below:

(1) Small Size: The room dimensions, as shown in Figure 1, are 5.0 m by 2.9 m with a ceiling height of 2.67 m. The length seriously affects the $2D^2/\lambda$ far zone requirement for most antenna measurements. The narrowness in height and width suggests that the illumination of sidewalls, ceiling, and floor may be at a high level.

(2) Ceiling Lights: There are six incandescent lights located as shown in Figure 1. The metal reflectors for these lights are 18 inches in diameter and extend below the ceiling 11 inches.

* Trademark of Emerson and Cuming, Inc.

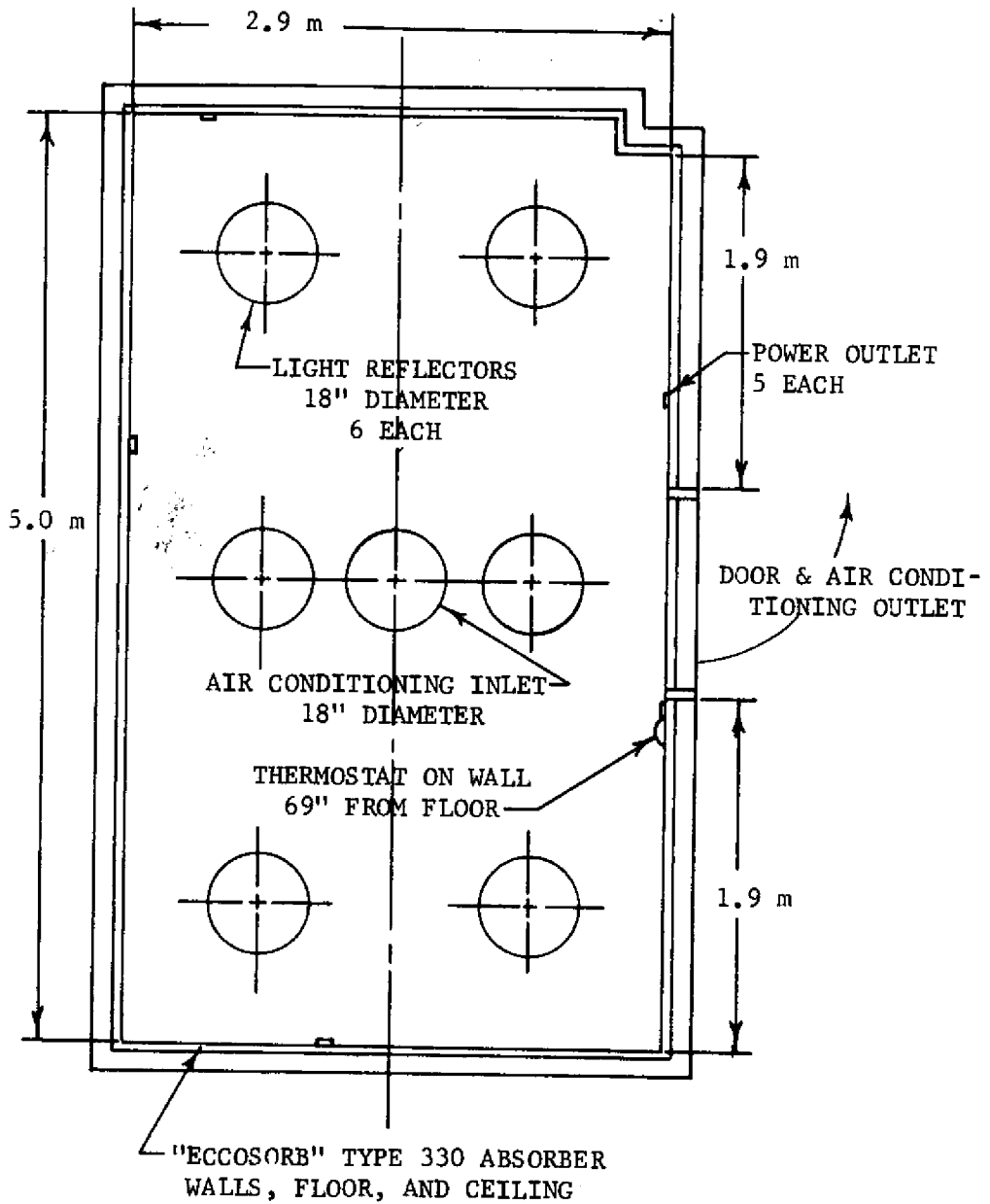

Note: Ceiling height is 2.67 m.

Figure 1. Floor Diagram of the Microwave Free Space Room.

(3) Air Conditioning Inlet: A circular air conditioning inlet 18 inches in diameter is located in the center of the ceiling. This metal inlet introduces a large metallic surface area which would cause reflections.

(4) Air Conditioning Outlet: A 16.5 inch by 38.5 inch metal rectangular air conditioning outlet is located over the door. This outlet also introduces a large metallic surface area.

(5) Power Outlets: There are five power outlets with 2.75 inch by 4.75 inch metal cover plates located around the room, introducing even more metallic surface area.

(6) Door: The door is located approximately in the center of one sidewall. The door itself is covered with absorbing material but the metal door frame is left exposed.

(7) Thermostat: The air conditioning thermostat is located approximately 69 inches from the floor near the door as shown in Figure 1. It is 5 inches in diameter with a metal cover.

It is the purpose of this research to evaluate this "microwave anechoic chamber" in terms of its electromagnetic characteristics in order to determine the expected accuracy of measurements made in the room and also to determine the type of measurements for which the room is most suited.

Review of Literature

Past research in the field of free space room evaluation has been carried on primarily by a few private companies engaged in the design of free space rooms. Several methods have been developed for the evaluation of a room for each of its functional capabilities.^{1,2}

The functional capabilities of a room are many but may be grouped into three general types of radiation measurements. These are 1) antenna pattern measurements, 2) radar cross section measurements, and 3) antenna-coupling and antenna-impedance measurements.² Because of the various functional capabilities of a free space room there is no single test that will completely describe a room's performance. Thus an accurate evaluation must include information concerning all three general types of radiation measurements. This information is provided in the form of performance capabilities which are experimentally measured and indicate the expected accuracy of radiation measurements to be made. There are, then, three performance capabilities corresponding to the three general functional capabilities listed above. In summary, the literature indicates that although relatively few people have been engaged in free space room evaluation, standard reliable test methods do exist.^{1,2}

General Considerations

Before discussing the detailed evaluation methods to be used, various general considerations must be pointed out.² The basic quantity to be measured in the evaluation is the magnitude of the perturbations caused primarily by reflections of the signal of interest. There are several factors which directly affect the magnitude of the reflections in the room and no evaluation is complete without describing what these factors were during the evaluation tests. The relative degree of illumination of sidewalls, ceiling, and floor is important; thus, antenna electrical characteristics such as gain and beamwidth must be stated. Polarization and frequency have a direct effect on reflections. The orientation of antennas and distance between antennas also are important.

CHAPTER II

EVALUATION METHODS

Three separate methods of evaluation corresponding to the three functional capabilities listed above were used in this research. An explanation of the three performance capabilities and the method employed to measure each capability follows. In each case the exact procedure followed may be found in Chapter IV, PROCEDURE.

Antenna Pattern Measurements

Antenna pattern measurements require essentially that a plane wave be established in an area of the room of adequate size for pattern measurements. This area is termed the quiet zone. The wave in the quiet zone would, for all practical purposes, be plane were it not for reflections from the room surfaces and objects in the room. These reflections add constructively and destructively at various positions in the quiet zone. A performance capability, quiet zone reflectivity level, may be defined as the average ratio of the reflected Poynting vector to the direct transmitted Poynting vector in the quiet zone with antennas of stated directivity and polarization.

With a fixed transmitting antenna and with fixed frequency and polarization the perturbations of the direct signal in the region of the quiet zone will be entirely spatial. The spatial perturbations may be differentiated from the direct signal by direct measurement with a probe antenna. Consider the magnitude of the reflected signal to be

50 db below the magnitude of the direct signal, a peak to peak excursion of only 0.055 db would then occur in the peak signal detected by the probe antenna. This is, by far, much too small to be measured accurately with standard laboratory equipment. However, if the main lobe of the probe antenna is aimed so as to cause the direct transmitted signal to produce a response 20 db below the peak value, the peak to peak excursion corresponding to a quiet zone reflectivity level of -50 db would now be 0.55 db, a value easily measured with standard laboratory equipment. This is the basis of the off-peak pattern comparison method used in this research to determine quiet zone reflectivity level.^{1,3}

The off-peak pattern comparison method is as follows. The transmitting antenna is fixed in location, frequency, and polarization while the receiving antenna is mounted so that it may be rotated in azimuth and/or elevation and also moved in a transverse vertical plane. Patterns are then recorded with the receiving antenna located successively at adjacent test points along a horizontal traverse at an equal radius from the transmitting antenna. These patterns are then superimposed with their main lobes coinciding. The deviations in the patterns at various levels on each side of the peak are plotted versus the distance from the room axis to the test point along the arc of horizontal traverse. This plot will clearly show the cyclic interference of the direct transmitted signal by the reflected signal and allow calculation of the quiet zone reflectivity level. This procedure will be explained in greater detail in Chapter IV, PROCEDURE.

Radar Cross Section Measurements

The radar cross section of a target, σ , is a term which arises from the "radar equation" and has the dimensions of area at an equivalent target distance, R . It is a characteristic of the target and is a measure of its size as seen by the radar system.¹⁶ The power, P_r , reflected by the target and collected by the receiving antenna is⁸

$$P_r = P_t \left[\frac{\lambda^2 G^2}{(4\pi)^3 R^4} \right] [\sigma]$$

where:

P_t is the transmitted power

λ is the wavelength

G is the directive gain of the transmit-receive antenna

R is the distance to the target

σ is the radar cross section

The first term in brackets contains the constants of the antenna and range system. The second term in brackets, σ , describes the target and is an indication of the magnitude of the detected signal as compared to the transmitted signal.

Cross section measurements made in a free space room will contain errors caused by reflections from the room. A performance capability which corresponds to the functional capability of radar cross section measurements obviously is the equivalent radar cross section of the room. The simplest method of measuring the equivalent room radar cross section is to calibrate the detector of a typical reflectivity measurement system using objects of known radar cross section and then measuring

the reflection level of the room with the system set up as for typical cross section measurements. The reflection level from the room is then compared to the reflection level of the objects of known cross section and the equivalent room radar cross section may be determined.

Antenna-coupling and Antenna-impedance Measurements

In making antenna-coupling and antenna-impedance measurements in a free space room, the room may be considered as a termination of the radiating system. A performance capability called "Termination VSWR" may be defined as the VSWR indicated by a stationary probe in the line feeding the transmitting antenna as the transmitting antenna is moved along its line of sight.¹ The measurement of this usually small VSWR is complicated by the fact that it must be measured through a mismatch of the antenna and its transmission line which in most cases produces a VSWR much larger than the "Termination VSWR". A "moving termination" technique^{4,5,6} has been devised in which a stationary probe in the transmission line feeding the transmitting antenna is fixed with respect to the antenna-transmission line mismatch and is used to indicate VSWR as the antenna is moved with respect to the room. In this manner the room appears as a "moving termination" with respect to the transmitting system.

CHAPTER III

INSTRUMENTATION AND EQUIPMENT

A diagram of the system used in this research to measure quiet zone reflectivity level is shown in Figure 2. Photographs of the equipment shown mounted in position are shown in Figures 3 and 4. In order to accomplish the horizontal traverse of the receiving antenna at an equal distance from the transmitting antenna, an arc was drawn on the floor and two centimeter increments were marked off as shown in Figure 6. Two small strips of transparent plastic with hair lines were then attached to the bottom of the receiving system stand and this arrangement thus allowed the receiving antenna to be moved in equal increments along an equal distance from the transmitting antenna in a horizontal traverse. The receiving antenna was mounted on a small platform which could be rotated in azimuth only. An angle indicator was included on the receiving stand. The antenna mounting platform and the angle indicator are shown in Figures 5 and 6. The orientation of the transmitting and receiving stands with respect to the room is shown in Figure 7.

The basic requirements for measuring the equivalent room radar cross section are a reflectivity measuring system and a series of objects of known cross section. A single-antenna system for monostatic reflectivity measurements was chosen. A diagram of this system is shown in Figure 8. It should be noted that this is not the simplest monostatic system possible to make reflectivity measurements in that there is more than one method of achieving a null of the background

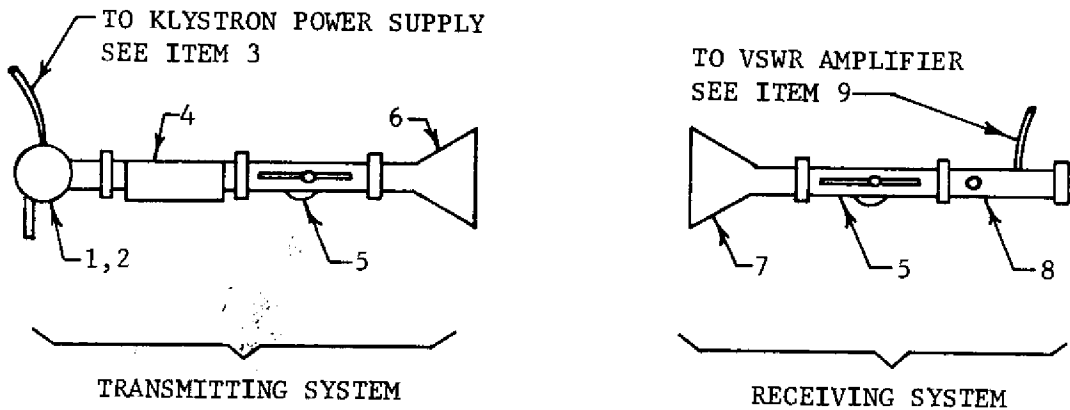

1. Klystron Mount, PRD 703
2. Klystron, Raytheon 723 A/B
3. Klystron Power Supply, PRD 809A
4. Variable Attenuator, Hewlett Packard X375A
5. Slide Screw Tuner, Hewlett Packard X870A
6. Horn Antenna, Constructed in the Laboratory
7. Horn Antenna, Constructed in the Laboratory
8. Detector Mount, Hewlett Packard X485B
9. VSWR Amplifier, Narda 441C

Figure 2. Equipment Diagram for Measurement of Quiet Zone Reflectivity.

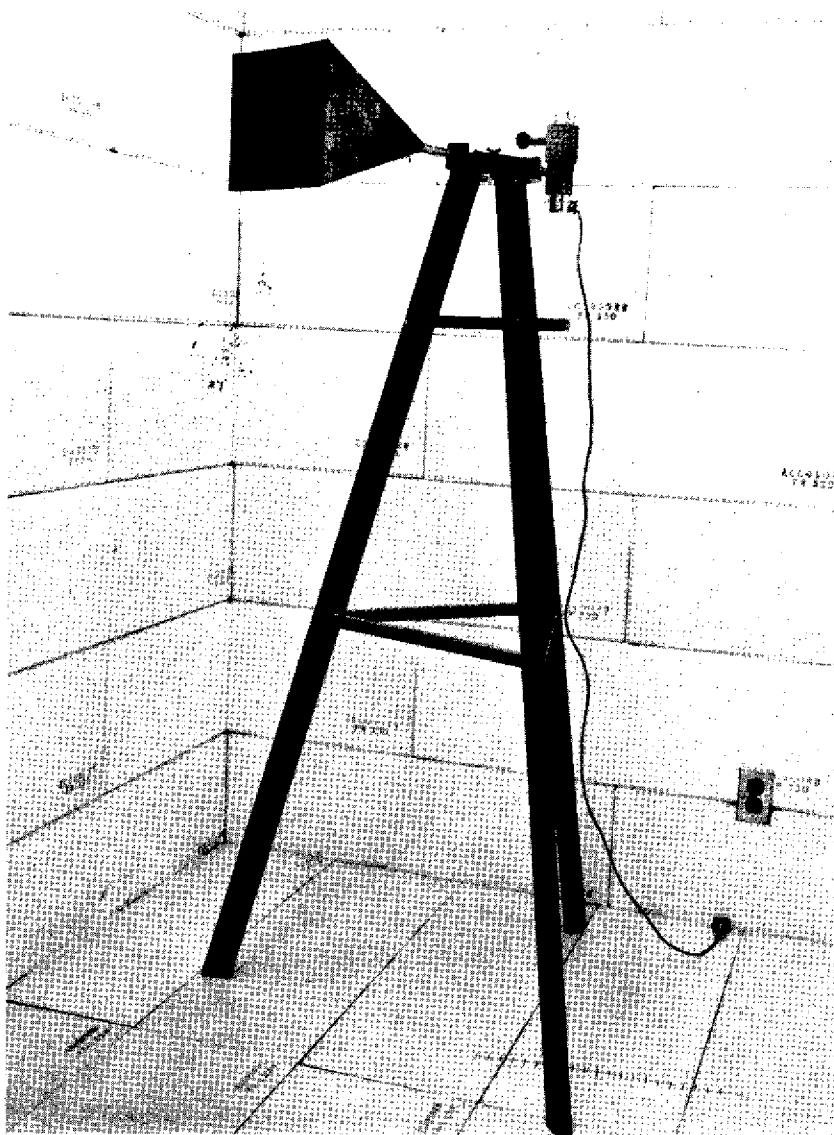

Figure 3. Transmitting System for Measurement of Quiet Zone Reflectivity.

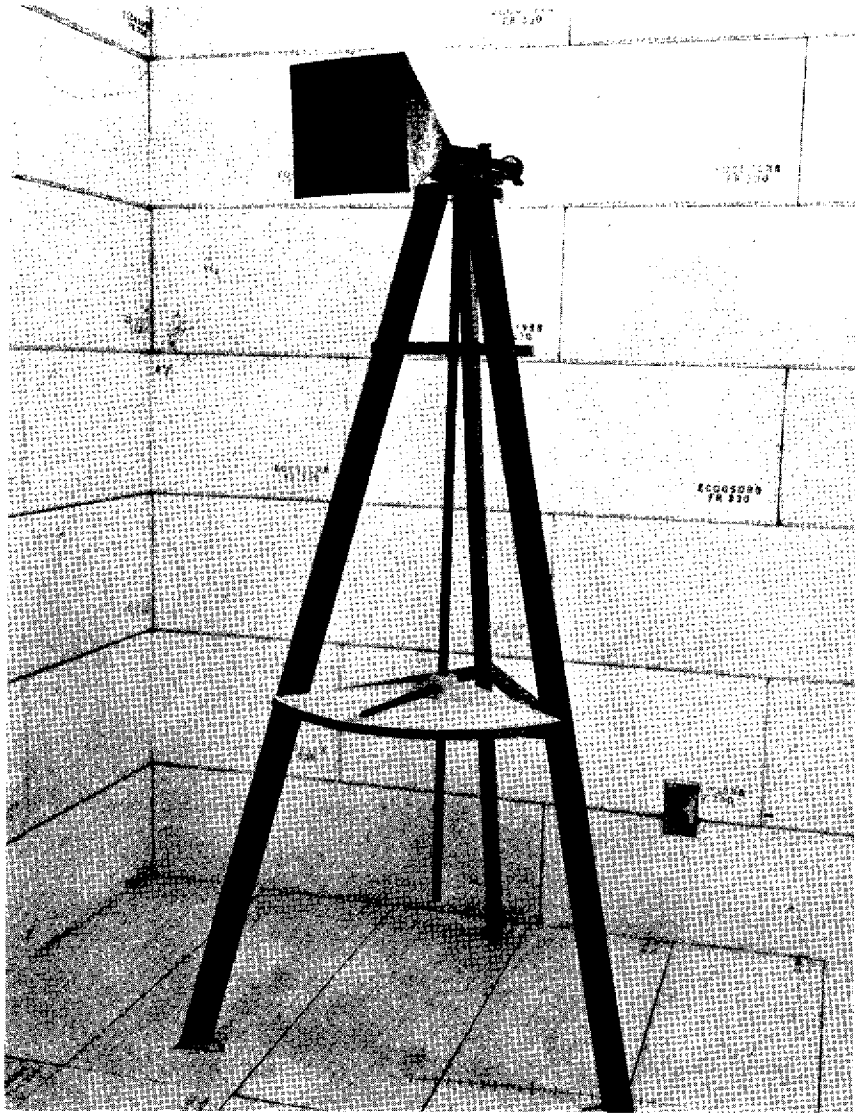

Figure 4. Receiving System for Measurement of Quiet Zone Reflectivity.

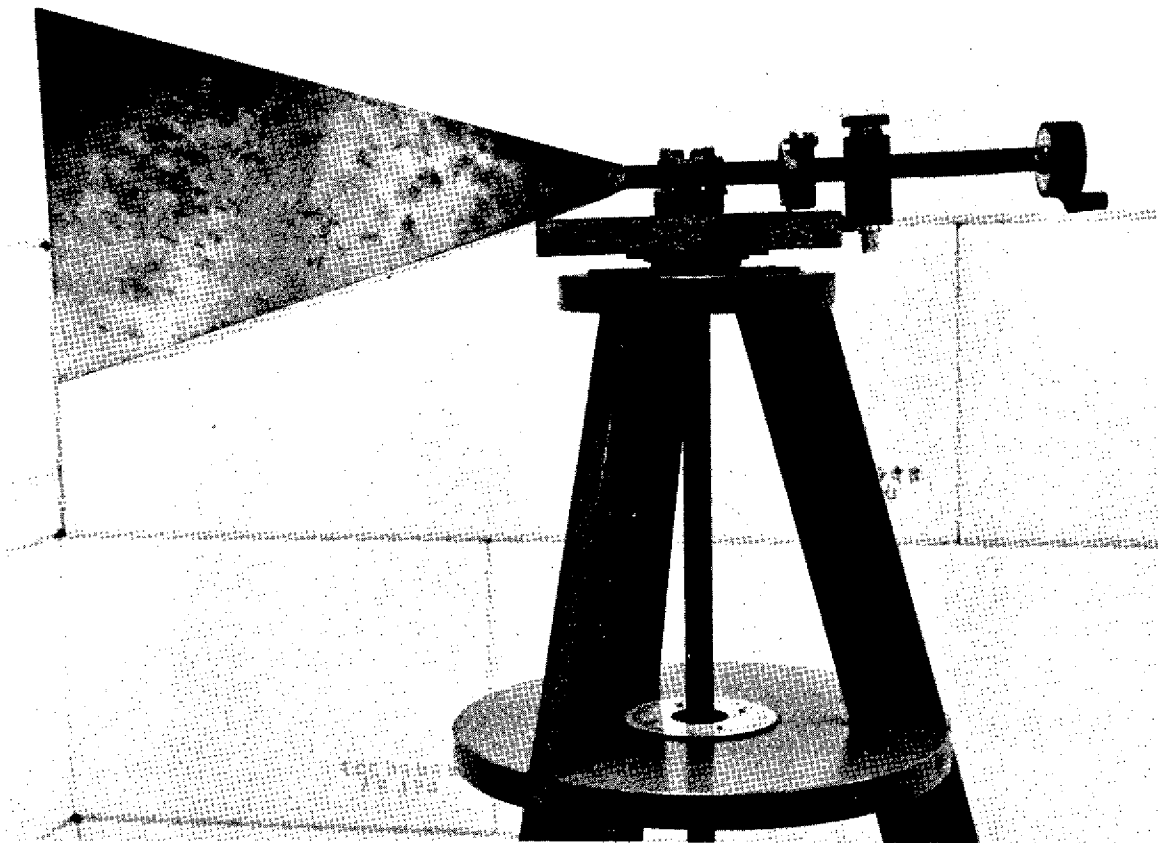

Figure 5. Photograph of Receiving Stand for Measurement of Quiet Zone Reflectivity Showing Antenna Mounting Platform.

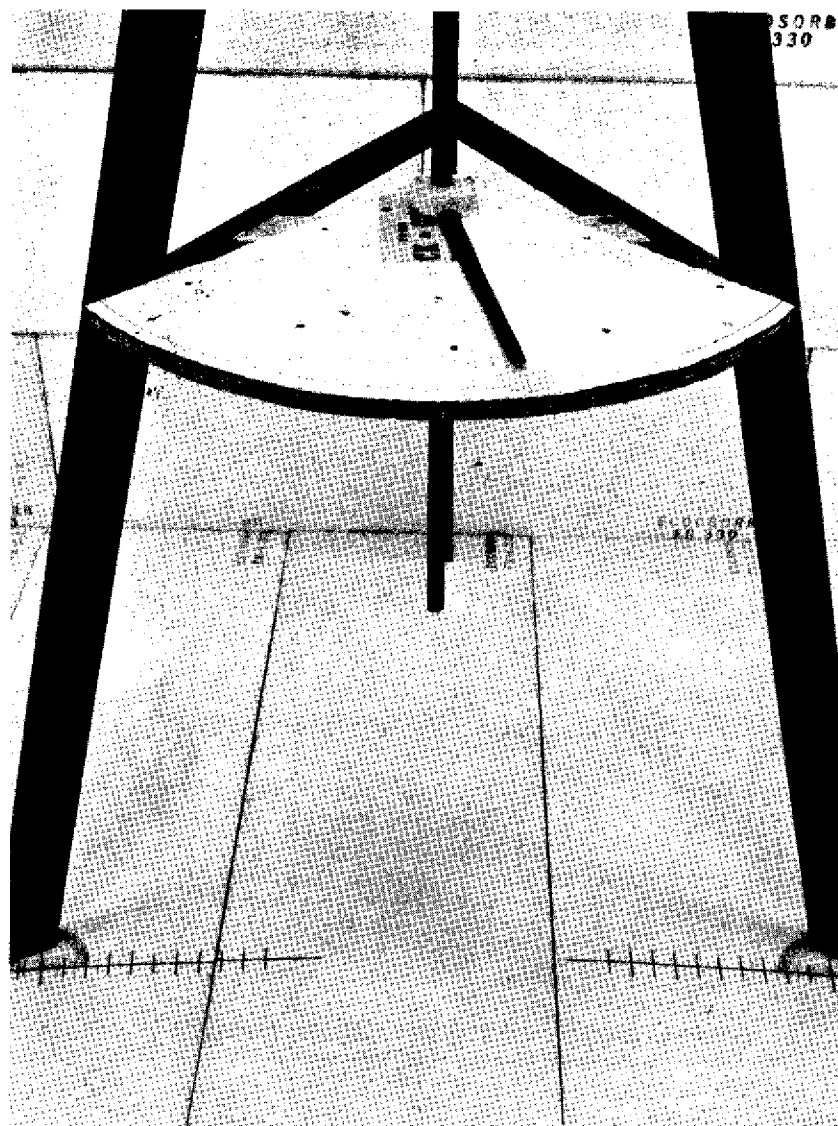
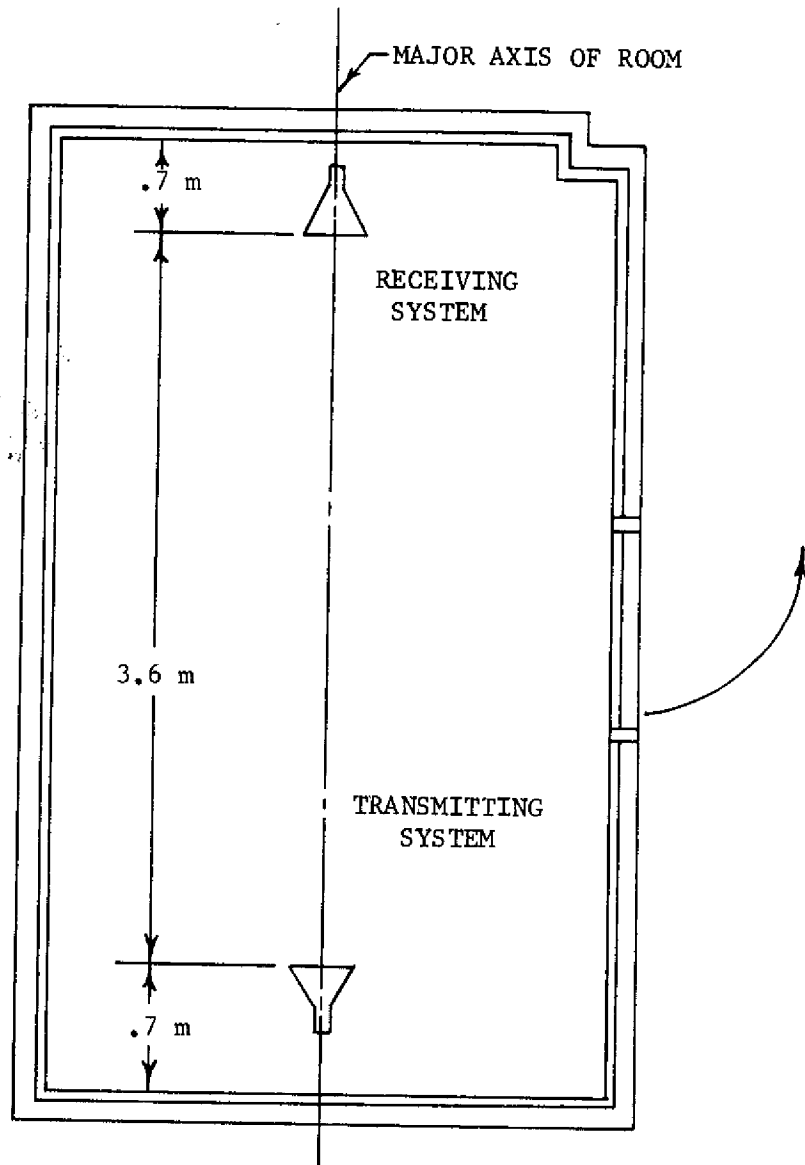

Figure 6. Photograph of Receiving Stand Showing Angle Indicator and Two Centimeter Increments Marked on Floor for Accomplishing the Horizontal Traverses.



Note: The center of each Antenna Aperture is 1.5 m from the floor.

Figure 7. Orientation of Equipment for Measurement of Quiet Zone Reflectivity.

signal using the system shown in Figure 8. A photograph of the assembled system is shown in Figure 9. Five wooden disks covered with aluminum foil on one side with diameters of six, eight, ten, twelve, and fourteen inches were used as standards to calibrate the detecting system.

The system used to measure the "Termination VSWR" is relatively simple. A diagram of the equipment is shown in Figure 11 and a photograph of the assembled system is shown in Figure 10. The system was mounted on a rolling table (not shown in the photograph) in order to accomplish the line of sight movement required to make measurements.

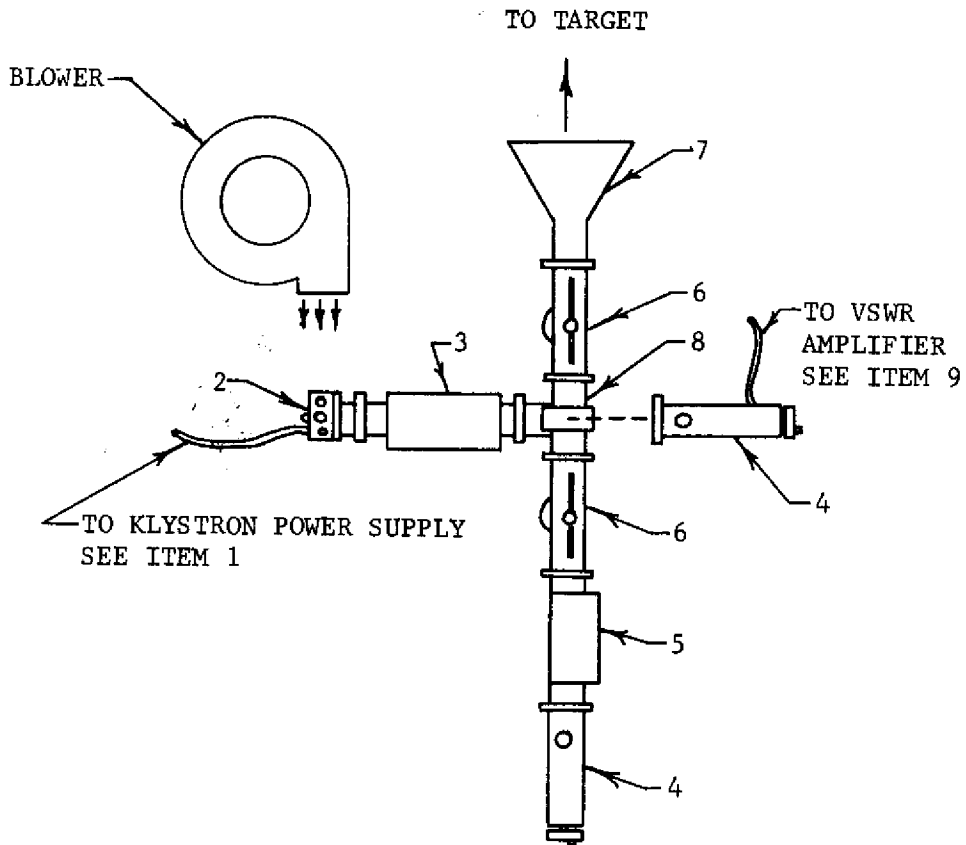

1. Klystron Power Supply, PRD 809A
2. Klystron, Varian V-55
3. Isolator, Kearfott G994 100 309
4. Detector Mount, Hewlett Packard X485B
5. Variable Attenuator, Hewlett Packard X375A
6. Slide Screw Tuner, Hewlett Packard X870A
7. Horn Antenna, Constructed in Laboratory
8. Magic Tee, PRD 481
9. VSWR Amplifier, Narda 441C

Figure 8. Diagram of Equipment for Measurement of Equivalent Room Radar Cross Section.

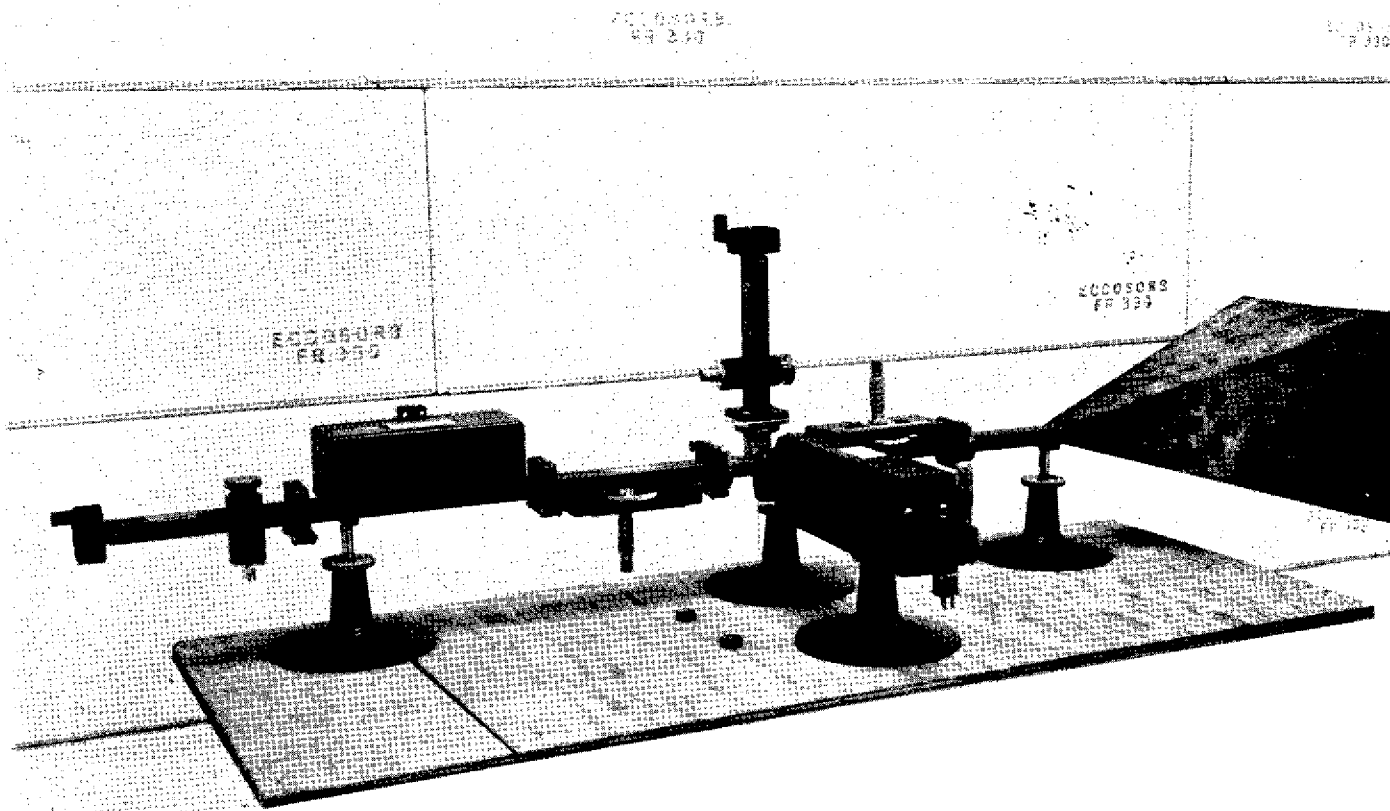

Figure 9. Photograph of System Used to Measure Equivalent Room Radar Cross Section.

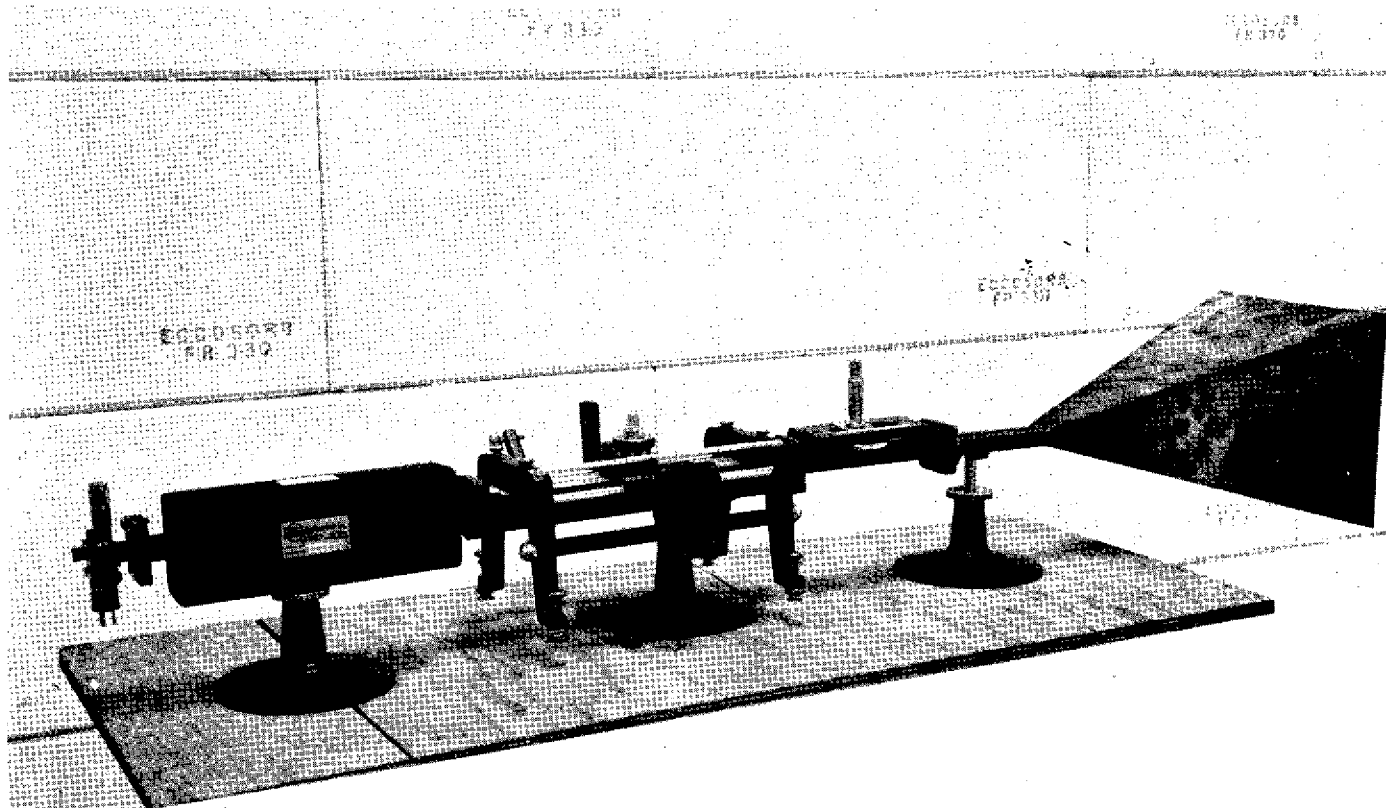
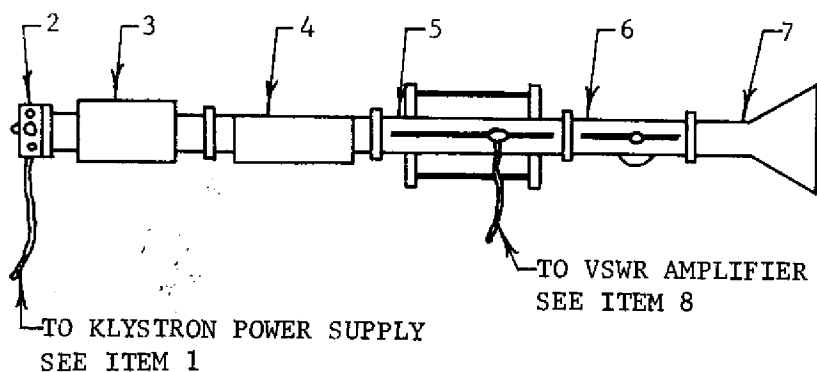

Figure 10. Photograph of System Used to Measure "Termination VSWR"



1. Klystron Power Supply, PRD 809A
2. Klystron, Varian V-55
3. Isolator, Kearfott G994 100 309
4. Variable Attenuator, Hewlett Packard X375A
5. Slotted Line, Consisting of:
 Carriage, Hewlett Packard 809B
 Slotted Section, Hewlett Packard X810B
 Probe, Hewlett Packard 444A
6. Slide Screw Tuner, Hewlett Packard X870A
7. Horn Antenna, Constructed in Laboratory
8. VSWR Amplifier, Narda 441C

Figure 11. Diagram of Equipment for Measurement of "Termination VSWR".

CHAPTER IV

PROCEDURE

Measurement of Quiet Zone Reflectivity

The length of the room, as shown in Figure 1 is five meters. Allowing minimum area behind the transmitting antenna for equipment, the maximum antenna separation is approximately 3.6 meters. At a frequency of 9.4 Gc, the maximum antenna aperture dimension for this distance of 3.6 meters to be a distance of $2D^2/\lambda$ from the transmitting antenna of aperture D is 24 centimeters. Thus the quiet zone must be a minimum of 24 centimeters square. A quiet zone of 36 centimeters square with the center on the major axis of the room, .7 m from the back-wall, and 1.5 meters from the floor was chosen for investigation. Vertical polarization was used throughout the test.

The transmitting and receiving stands were assembled and oriented as shown in Figure 7, the receiving antenna being centered on the major axis of the room using the floor marks shown in Figure 6. The transmitting and receiving antennas were constructed in the laboratory and have gains of approximately 20 db and half power azimuth beam widths of 13 degrees using vertical polarization. The dimensions of these antennas are given in the Appendix. A pattern recorder was not available but the required deviation plots were easily obtained in the following manner. The angles corresponding to the amplitude at 5, 10, 15, 20, 25, and 30 db down from the peak on both sides of the peak were recorded for reference. The receiving stand was then moved to one side of the assumed

quiet zone, again using the floor marks for reference, and the receiving antenna was peaked in azimuth and the angle indicator set to that value corresponding to the reference signal peak. The receiving antenna was then manually set at all of the angles corresponding to the off-peak reference levels and the value of the received signal was recorded. The receiving antenna was then moved along its horizontal traverse in two centimeter increments each time being peaked and the signal level recorded corresponding to the reference levels. The above procedure gives one traverse across the center of the "quiet zone." The receiving antenna was then raised 18 cm by inserting a sleeve between the mounting platform and the stand. The same procedure of obtaining reference angles and then moving the receiving antenna through a horizontal traverse of the quiet zone was repeated. The receiving antenna with the mounting platform and angle indicator was then mounted on a shorter stand and the height of the antenna was adjusted to be 18 cm lower than the first horizontal traverse. The procedure was then followed a third time. The final results are three horizontal traverses through the quiet zone with measurements being taken at two centimeter increments along the traverse arc. The deviation plots for this first test are shown in Figures 15 through 20 in the Appendix. Because reference levels were taken on both sides of the received pattern, each graph contains data labeled "Right Half" of Pattern and "Left Half" of Pattern. "Right Half" as used on the graphs corresponds to that signal received by the right side of the receiving antenna as viewed from behind the receiving antenna. An index to the deviation plots showing the traverse distance covered for each graph is shown in Figure 14. An equivalent of 19 antenna

patterns per horizontal traverse is contained in the deviation plots, thus three traverse arcs gives a total of an equivalent of 57 antenna patterns.

In order to investigate the effects of wider illumination of the room, the transmitting antenna was replaced with an antenna of approximately 15 db gain and 16 degree azimuth half power beam width using vertical polarization and the entire procedure of obtaining the equivalent of 57 patterns was repeated using the same horizontal traverse distances on the same two centimeter increments. The deviation plots for this test, Figures 21 through 26, follow the plots for the first test in the Appendix. The deviation plot index, Figure 14, is also applicable to this second test. The average quiet zone reflectivity level was determined graphically in the following manner. Let X be the magnitude of the off-peak direct ray vector and let Y be the magnitude of the reflected vector. The "Maximum Peak to Peak Deviation" shown on the deviation plots, Figures 15 through 26, thus, by definition is

$$\text{db spread} = 20 \log (X + Y) - 20 \log (X - Y)$$

$$= 20 \log \left[\frac{X + Y}{X - Y} \right]$$

Thus

$$\frac{X + Y}{X - Y} = \log^{-1} \frac{\text{db spread}}{20}$$

And

$$Y = X \frac{[\log^{-1} \frac{\text{db spread}}{20}] - 1}{[\log^{-1} \frac{\text{db spread}}{20}] + 1}$$

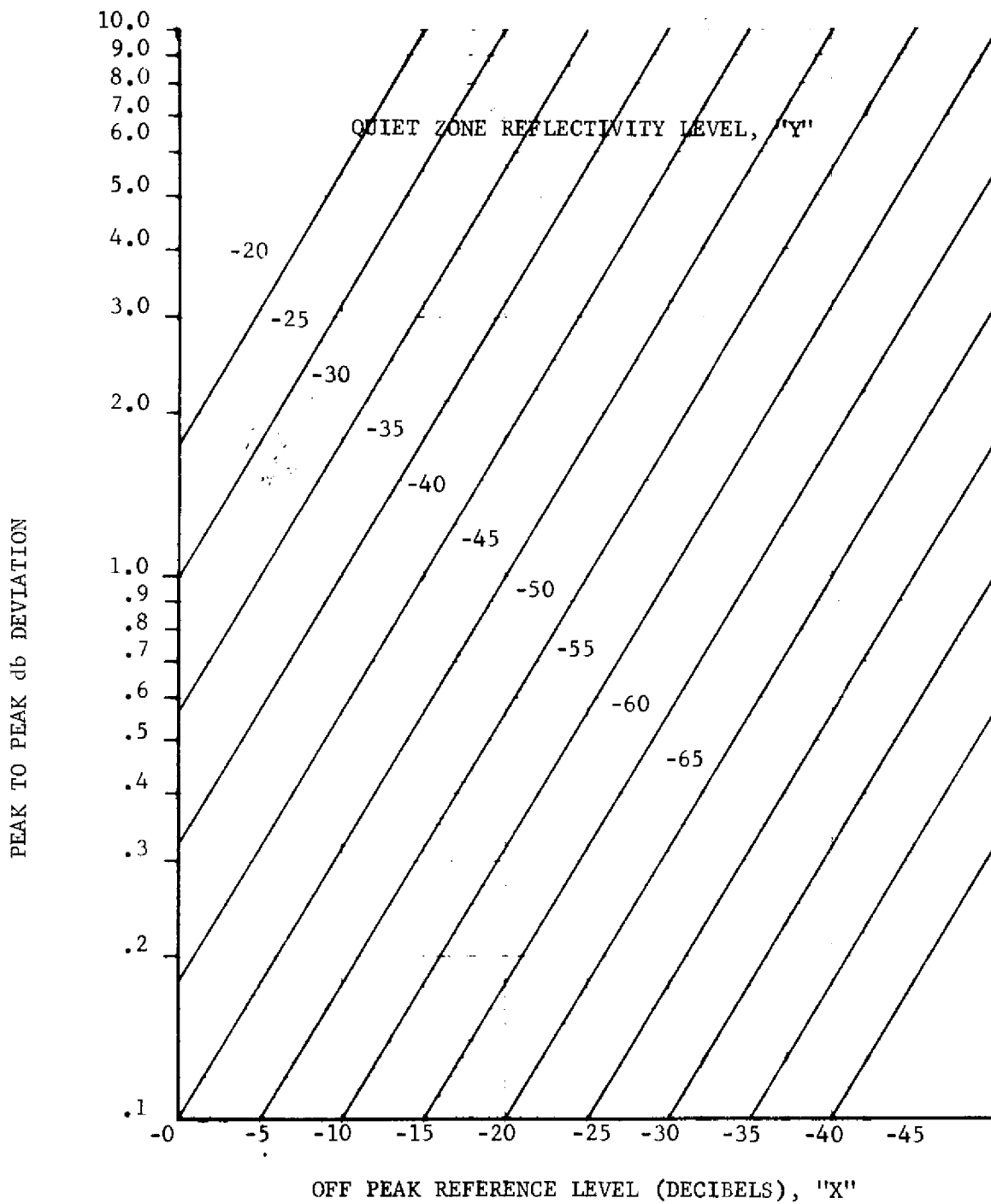

Figure 12. Antenna Pattern Perturbations Caused by Reflections.

The above equation is plotted in Figure 12 with db spread on the ordinate scale, X on the abscissa scale, and Y as the variable parameter. The quiet zone reflectivity level may then be read directly from the plot. For example, at 20 db off peak with a peak to peak deviation of 2.5 db, the quiet zone reflectivity level is -37 db.

The quiet zone reflectivity level was determined for each off-peak reference level as in the above example. The reflectivity levels were then averaged for both the "Left Half" and "Right Half" of the deviation plots. The total overall reflection level was also determined by taking the average of all the individual reflectivity levels for both halves.

Measurement of Equivalent Room Radar Cross Section

The monostatic system shown in Figure 8 was assembled and mounted on a rolling table. In order to calibrate the system, an area essentially free from return signals due to back scattering was required. In the Electrical Engineering Building the fifth floor in which the "free space" room is located does not entirely cover the fourth floor, leaving a large roof area exposed. The system was rolled onto this roof area and aimed over the roof edge in a direction for minimum return reflections. Calibration was then accomplished in the following manner. The ability of the system to maintain a null over a time period was first checked. The range of the detector was 70 db. A null was established down to 5 db above the noise level of the detector and this null was observed for 15 minutes. During this 15 minutes the null varied over a maximum of only ± 4 db, which was deemed a small enough variation not to affect measurements. The five disks were then suspended one at a time with nylon

monofilament line in a line of sight from the transmit-receive antenna at a distance of 3.6 meters. The maximum return signal from each of the disks was recorded two times, using the return signal from the 6 inch disk as the reference level, with the system being nulled periodically. Table 1 shows the actual values recorded. The system was then rolled into the "free space" room and the return signal from the room was recorded. After renulling on the outside, the return signal from the room was recorded a second time. This procedure was then repeated and a third measurement was recorded. This data is shown in Table 2. The equivalent room radar cross section was determined as described below.

Table 1. Calibration Data for Calculation of Equivalent Room Radar Cross Section.

Disk Diameter	Return Signal Level	
	Run 1	Run 2
6"	0.0 db	0.0 db
8"	4.8 db	3.7 db
10"	7.7 db	6.8 db
12"	11.4 db	10.9 db
14"	13.0 db	12.4 db

Table 2. Return Signal Level from the Room.

Measurement Number	Return Signal Level
1	-11.2 db
2	-12.8 db
3	-11.8 db

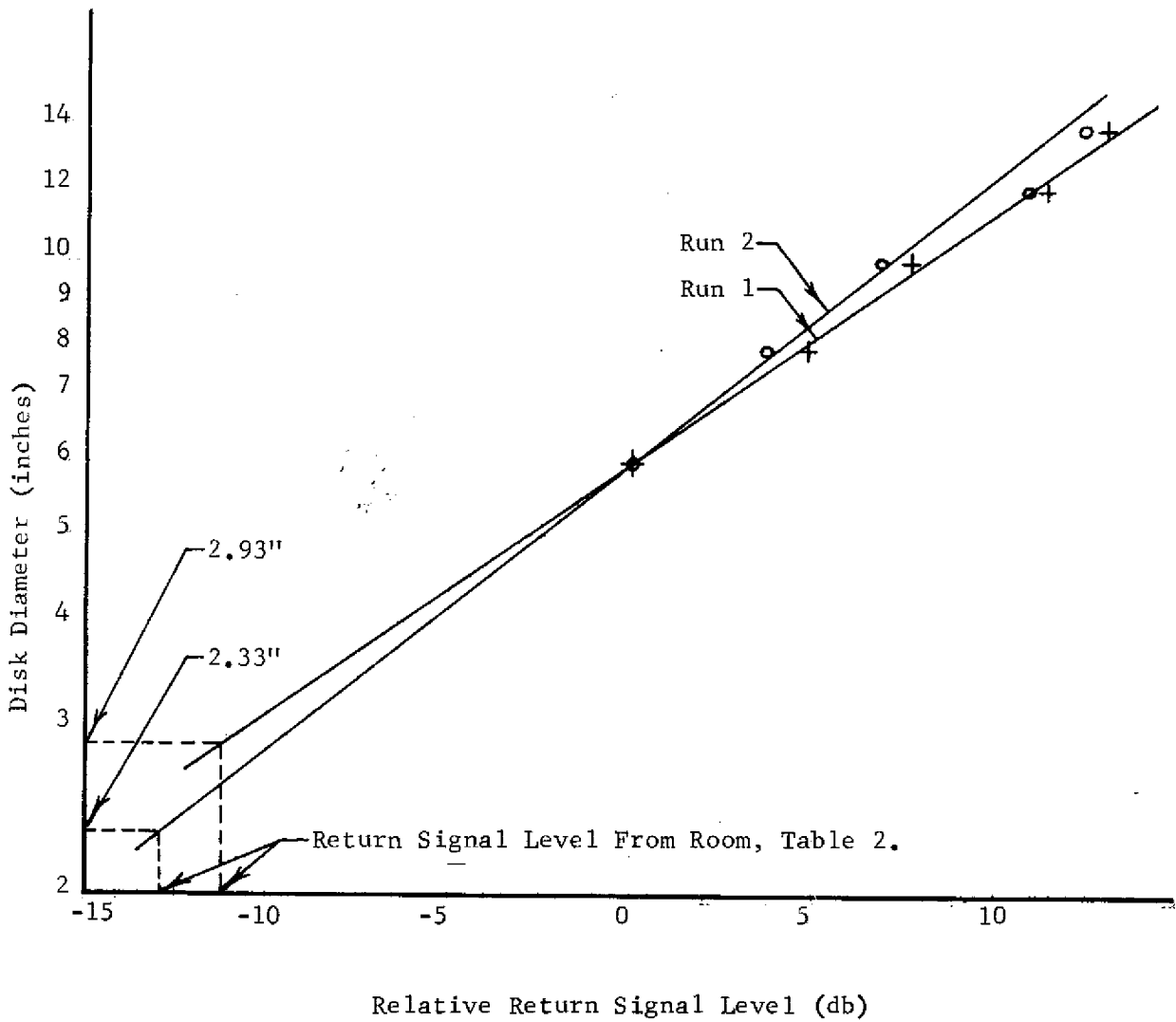

Figure 13. Calibration Curves for Determining the Equivalent Room Radar Cross Section

The return signal levels from each disk were plotted on semi-log paper, Figure 13. Two calibration curves were drawn approximately corresponding to the maximum and minimum return signal levels from each disk. The maximum and minimum equivalent disk diameters corresponding to the return signal levels from the room were obtained from Figure 13. These equivalent disk diameters are 2.33 inches and 2.93 inches. The equation for the theoretical radar cross section of a disk is⁸

$$\sigma = \frac{4\pi^3 r^4}{\lambda^2},$$

where σ is the radar cross section, r is the disk radius, and λ is the wavelength. Using this equation the approximate maximum and minimum equivalent room radar cross sections are 0.093 m^2 and 0.232 m^2 at 3.6 meters.

Measurement of "Termination VSWR"

The system shown in Figure 11 was assembled, mounted on a rolling table, and located in the same position as the equipment for measuring the equivalent room radar cross section. The slide screw tuner was adjusted to reduce the system VSWR to a minimum. The table was then moved in a straight line along the major axis of the room with the slotted line probe fixed and the VSWR was recorded. This "Termination VSWR" was 1.0035 ± 0.0002 . This corresponds to a maximum and minimum ratio of reflected power to incident power of -55.7 db and -54.6 db.

CHAPTER V

RESULTS

The results of the quiet zone reflectivity measurements are shown in Table 3 below. These results were obtained with the equipment oriented in the room as shown in Figure 7. Using vertical polarization at a frequency of 9.4 Gc and an antenna separation of 3.6 meters.

Table 3. Quiet Zone Reflectivity Results.

Test 1. 20 db Gain Transmitting Antenna	
Left Half Average	-34 db
Right Half Average	-34 db
Total Average	-34 db
Test 2. 15 db Gain Transmitting Antenna	
Left Half Average	-34 db
Right Half Average	-35 db
Total Average	-35 db

The equivalent room radar cross section is the equivalent of a metallic disk of 2.63 ± 0.30 inches in diameter. This corresponds to maximum and minimum room radar cross sections of 0.232 m^2 at 3.6 meters and 0.093 m^2 at 3.6 meters. The "Termination VSWR" was measured to be 1.0035 ± 0.0002 . Both the equivalent room radar cross section and the "Termination VSWR" were measured using vertical polarization at a frequency of 9.4 Gc. The orientation of the equipment with respect to the room was the same as the orientation of the transmitting stand for the measurement of quiet zone reflectivity.

CHAPTER VI

CONCLUSIONS

The object of the research was to obtain an evaluation of the room in order to determine the expected accuracy of measurements made in the room and also to determine the type measurements for which the room is most suited. The results presented in Chapter V provide this information. The conclusions to be reached are, of course, limited by the fact that the research was made using only one frequency and only one polarization with the antennas and orientations stated previously. Conclusions substantiated by the results for each general functional capability of the room are as follows.

Provided the far zone requirement of $2D^2/\lambda$ is satisfied, azimuth patterns can be made in the room using vertical polarization at a frequency of 9.4 Gc of antennas with 15 db gain or more with an expected accuracy at off-peak levels which can be read directly from Figure 11 using the quiet zone reflectivity level parameter of -34 db. For example, at 25 db off peak the average expected pattern variation would be ± 3 db. As antenna gain decreases, the average expected errors will increase. Modern anechoic chambers are normally designed to have a quiet zone reflectivity level somewhere in the range of from -40 db to -70 db.^{9,15} It must be pointed out here that the method used in this research to interpret the deviation plots was slightly different than the method used in the references.^{1,3} This research considered only the maximum peak to peak deviation at each off-peak reference level whereas references 1 and 3

consider the peak to peak deviation of each cycle of interference. The peak to peak deviation of each cycle of interference at each off-peak reference level will not be the maximum peak to peak deviation. Thus the references will in every case arrive at a lower reflection level (higher quality room) than the method used in this research for a given room. A quiet zone reflectivity level of -34 db, however, would still be a relatively poor reflectivity level compared to the reflectivity level of most modern anechoic chambers.

Cross section measurements made on any range will contain errors caused by shadowing of the range by the target. For an anechoic chamber, the larger the equivalent room radar cross section, the larger will be the errors caused by shadowing. Although the back scattering from the room is nulled when cross section measurements are being made, the shadowing of the room by the target will alter the return signal level and thus destroy the established null. Consequently, it is desirable to have as small an equivalent room radar cross section as possible. Typical equivalent room radar cross sections were found in the literature to be from $2.0 \times 10^{-7} \text{ m}^2$ at 25 ft to $.1 \text{ m}^2$ at 25 ft.^{9,15} A cross section of 0.162 m^2 at 3.6 m is the same as 3.24 m^2 at 25 ft. Thus the equivalent room radar cross section measured in this research is much larger than typical values. It can be stated that the performance of this room in terms of cross section measurements will be poor compared to the typical performance of other anechoic chambers.

It is interesting to note that the equivalent room radar cross section and "termination VSWR" actually are measurements of the same quantity, namely the ratio of reflected power to incident power. By

substituting the measured value of equivalent room radar cross section into the "radar equation," this ratio of reflected power to incident power may be calculated. This calculated value should be close to the value of -55.2 ± 0.5 db which corresponds to the "Termination VSWR". A simple form of the "radar equation" as indicated in Chapter II is

$$P_r = P_t \left[\frac{\lambda^2 G^2}{(4\pi)^3 R^4} \right] [\sigma].$$

Solving for P_r/P_t gives

$$\frac{P_r}{P_t} = \left[\frac{\lambda^2 G^2 \sigma}{(4\pi)^3 R^4} \right].$$

Substituting the values,

$$\lambda = 3.2 \text{ cm}$$

$$R = 3.6 \text{ m}$$

$$G = 20 \text{ db}$$

$$\sigma = 0.093 \text{ m}^2 \text{ and } 0.232 \text{ m}^2,$$

gives for the maximum and minimum power ratios, 7.12×10^{-6} and 2.85×10^{-6} . These values converted to db are -51.5 db and -55.5 db. These values compared to the values corresponding to the "Termination VSWR," -55.2 ± 0.5 db, indicate very consistent results.

CHAPTER VII

RECOMMENDATIONS

The research did not disclose specific reasons for the relatively poor quality of the room. However, it is this writer's personal opinion that the overall performance of the room can be improved by eliminating the obvious objectionable features. All the lights and their reflectors should be removed and the areas left exposed after their removal should be covered with absorbing material. Portable lamps could be used for light while making measurements. All the power outlets except a power outlet in one end of the room should be removed or covered with absorbing material. The airconditioning inlet and outlet should be covered with absorbing material. The absorber should be attached with spacers so that the air flow would not be impeded. With the above changes accomplished, the ceiling would be free of all metallic objects. This would mean that elevation antenna patterns would then be at least as accurate as azimuth antenna patterns because of the location of the door. It would not be practical to relocate the door because the improvement in measurements would not justify the expense. It would be possible to construct an absorber panel which would fit over the door and could be placed into position after entering the room. It is suggested that no other actions than the above be taken to improve the room performance because the improvement would not be great enough to warrant the expense.

The research described in this thesis has been made using particular antennas, frequency, polarization, and orientations in the room.

If it is desired to make measurements in the room using significantly different parameters than the ones indicated throughout the thesis it would be necessary to perform evaluation tests similar to the ones used in this research in order to obtain data concerning the expected accuracy of results. Reference 2 describes some rather simple evaluation procedures applicable to antenna pattern measurements.

The future microwave measurement requirements of the School of Electrical Engineering are not known but it is proposed that with the above changes for improvement the room would suffice for general microwave measurements until a specific problem requiring high accuracy arises.

APPENDIX

Index to Deviation Plots 37
Deviation Plots 38-49
Dimensions of Antennas Used in the Research 50

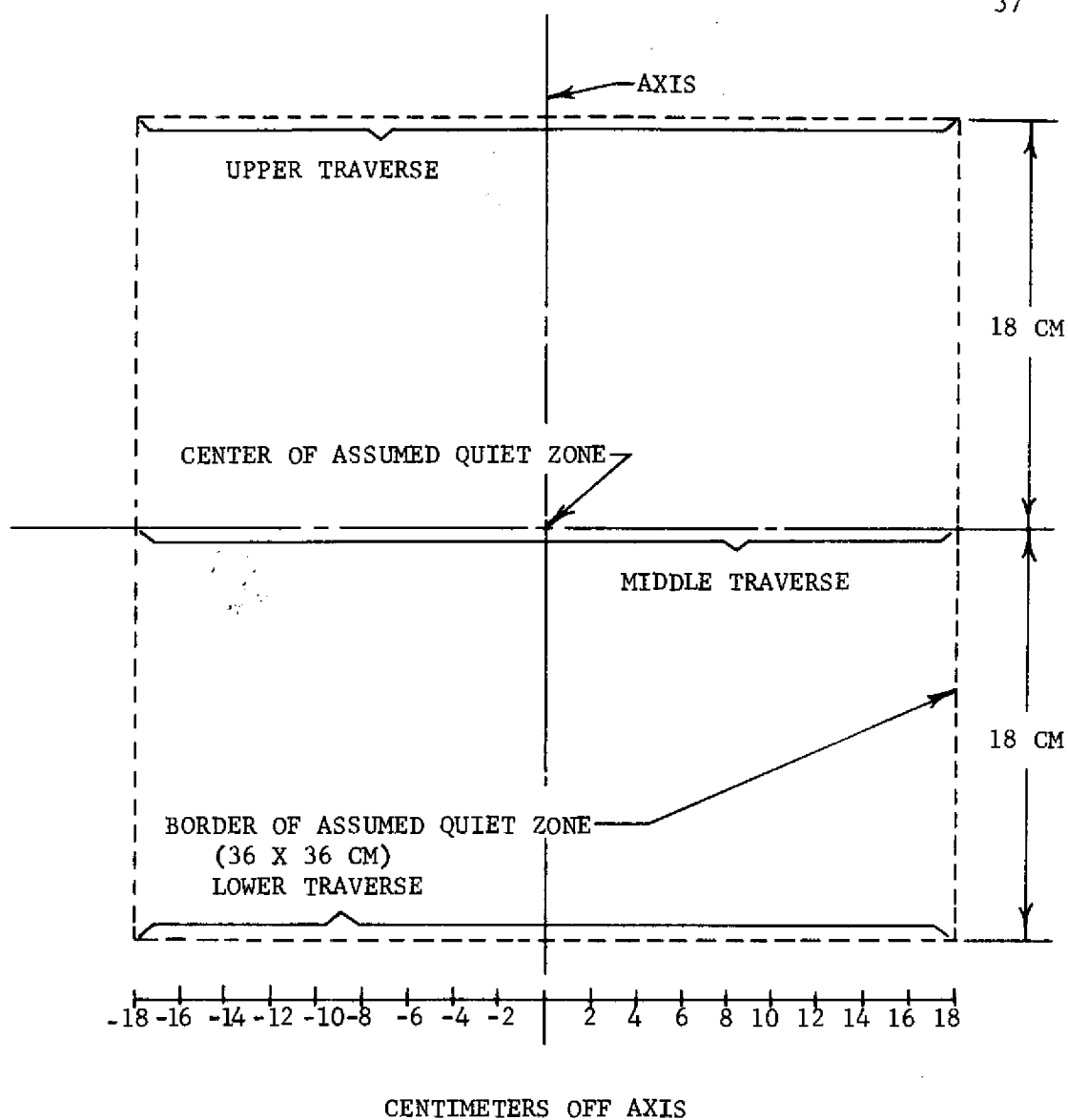

NOTE: The exact location of the Traverse for Each Deviation Plot is Determined by noting whether the Distance off Axis is Positive or Negative and also which Traverse (Upper, Middle, or Lower) the Plot Applies to.

Figure 14. Index to Deviation Plots.

ORIENT ZONE REFLECTIVITY LEVEL
 MAXIMUM PEAK TO PEAK DEVIATION

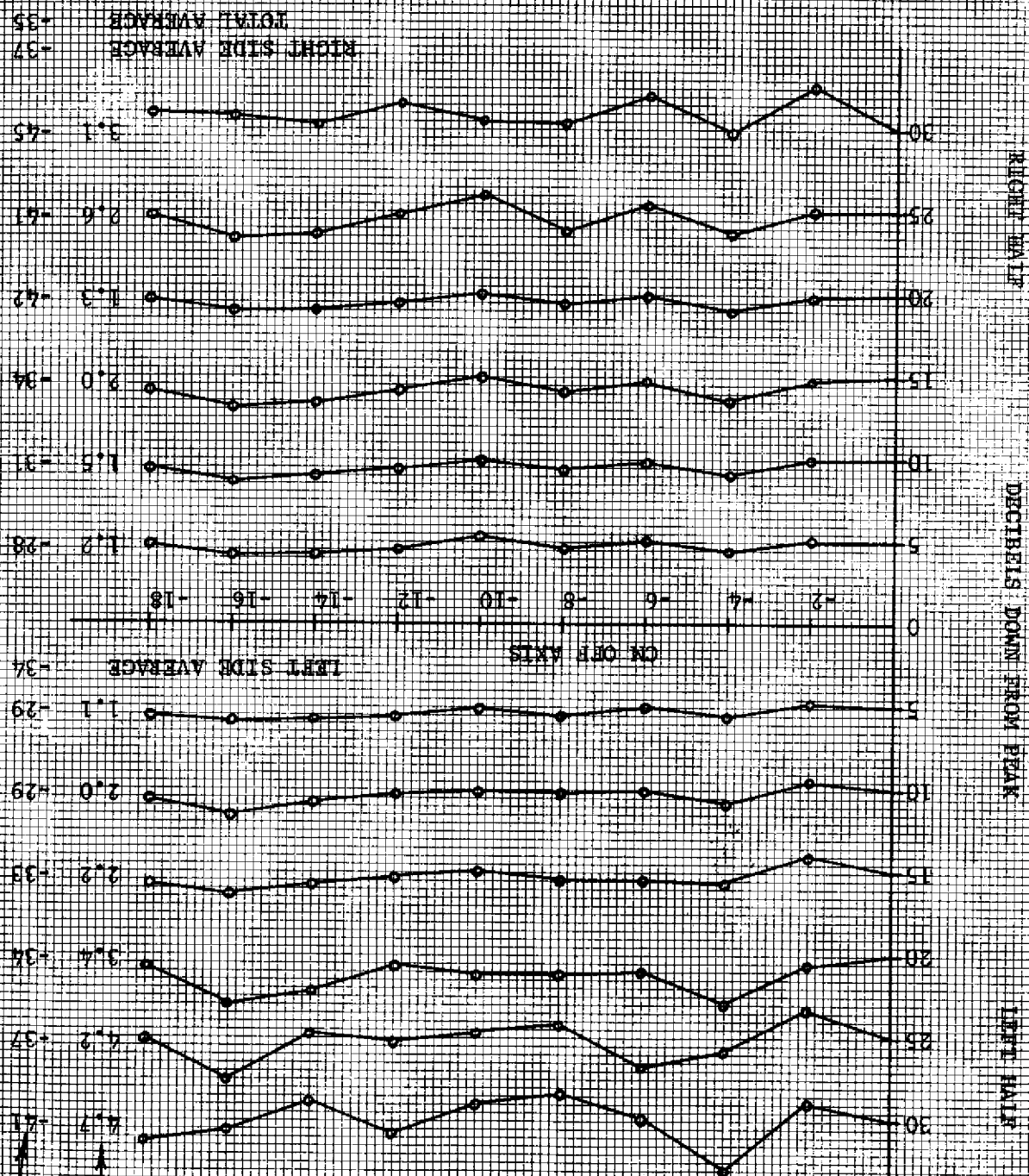
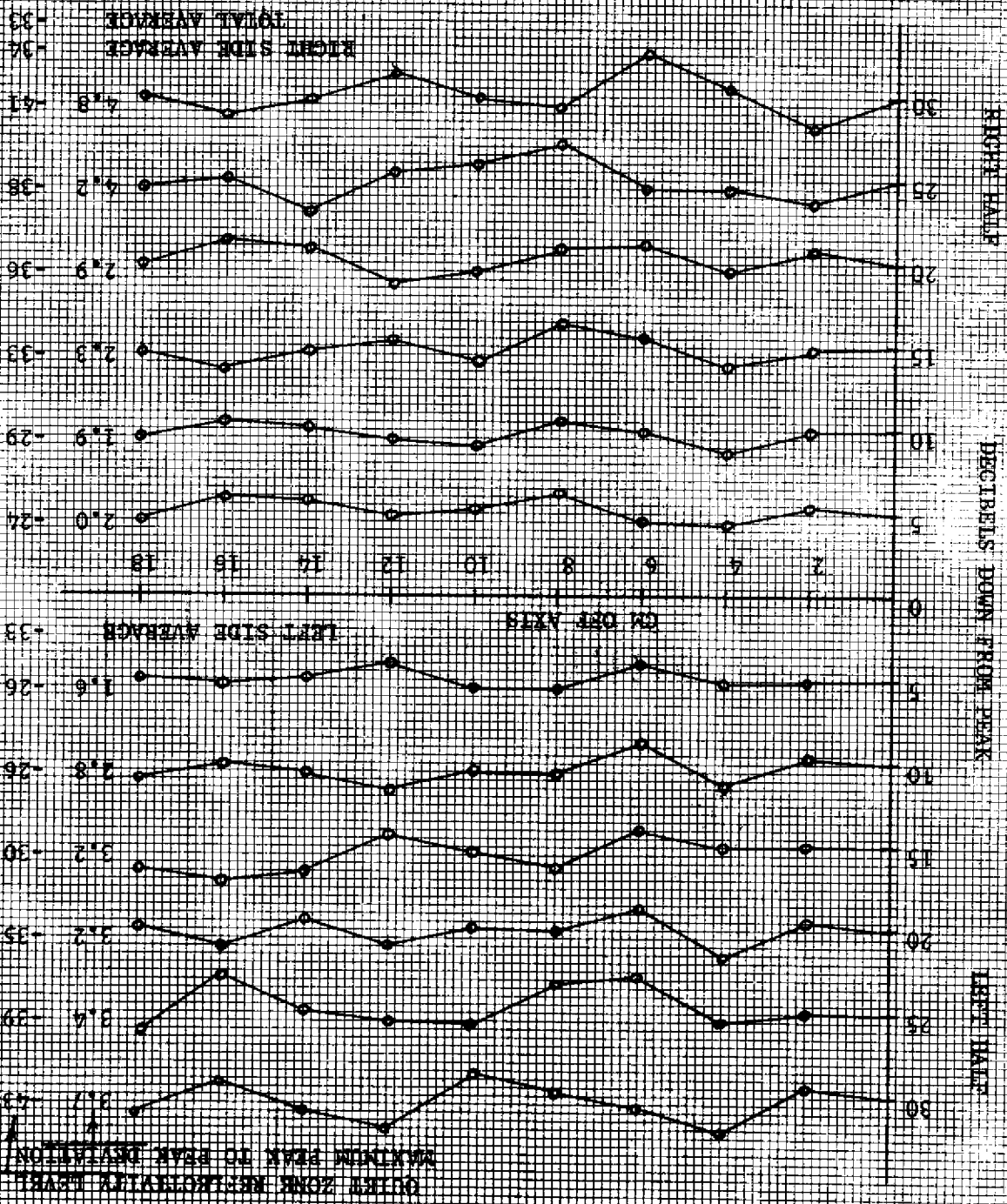

Figure 15. Deviation plot for test 1, upper legging, negative
 Distance from Axis

Figure 10: Deviation Plot for Test 7: Upper Traveler, Positive
 Distances from Axis



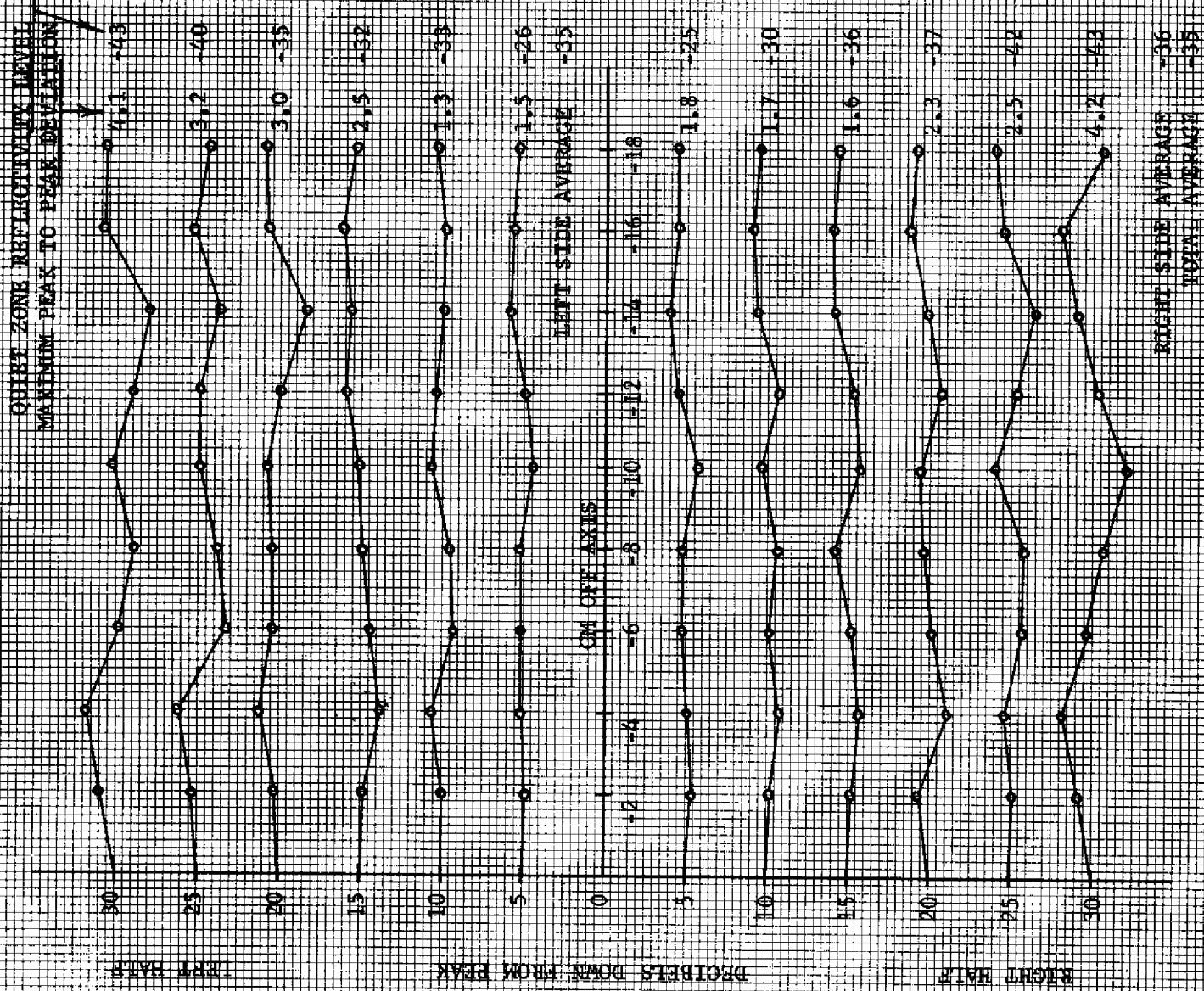

Figure 17. Deviation Plot for Test 1, Middle Traverse, Negative Distance from Axis.

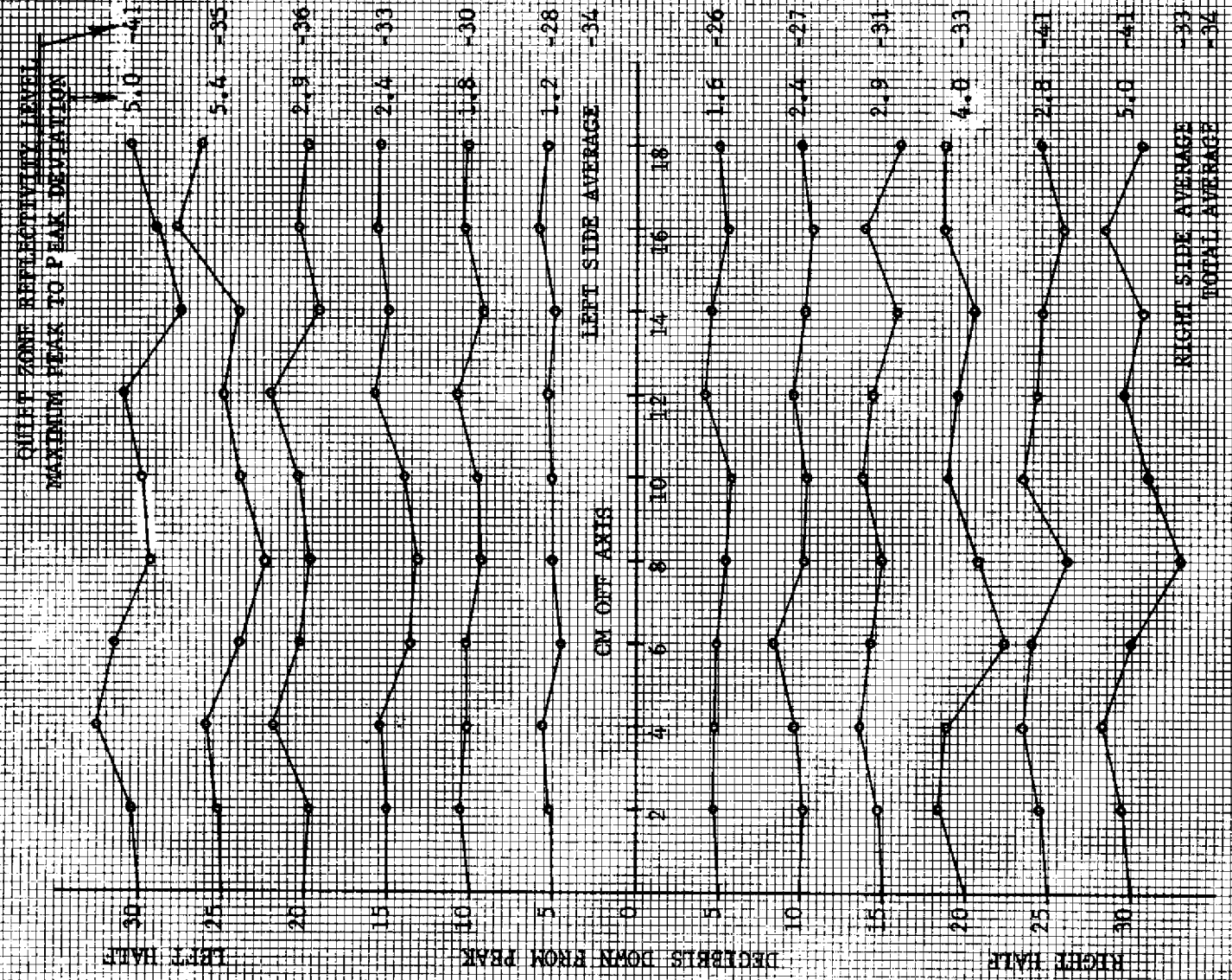

Figure 18. Deviation Plot for Test 1, Middle Traverse, Positive

Distance from Axis

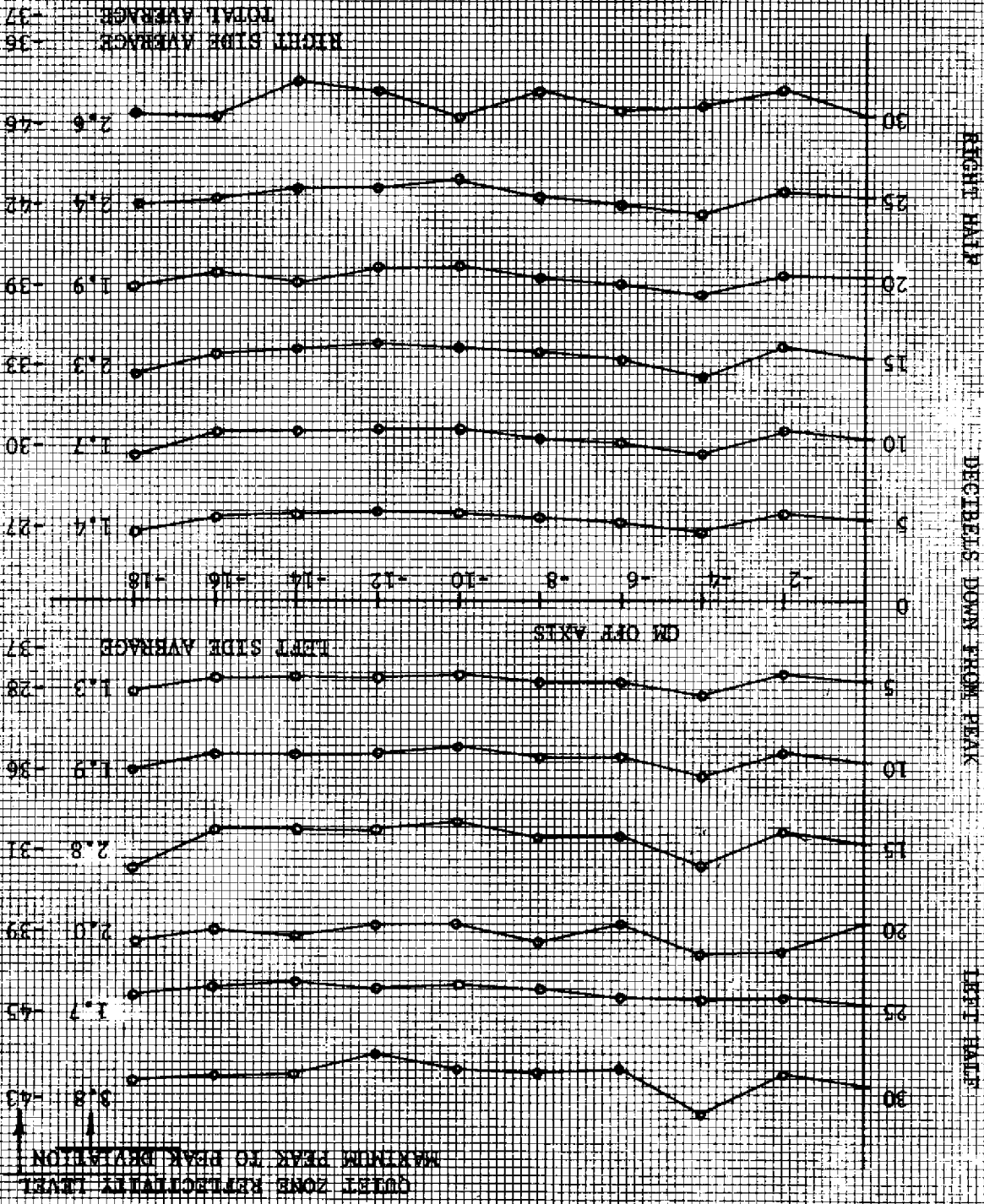

Figure 101 Deviation Plot for Test 1, Inner Diameter, Negative Distances from source

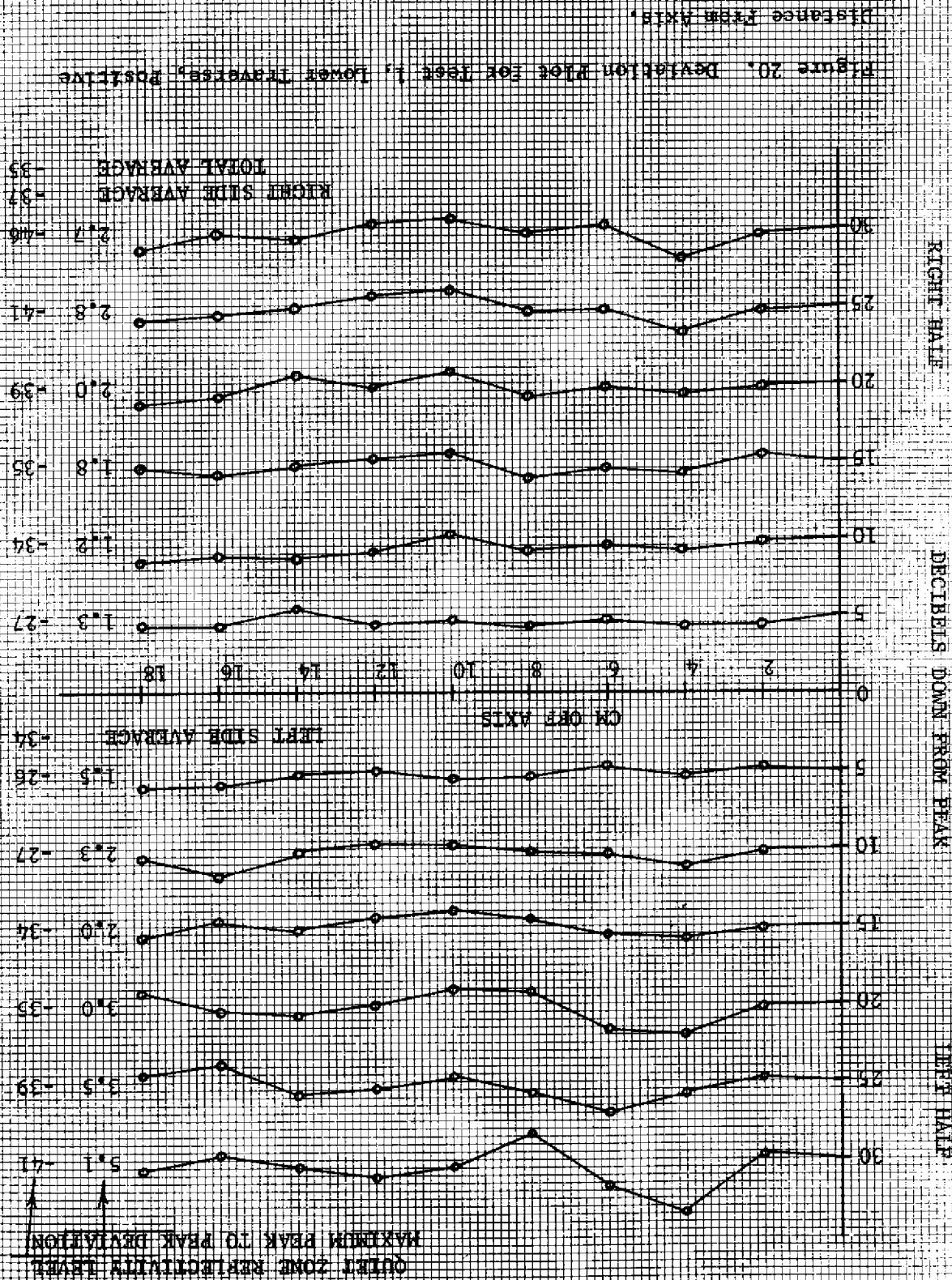
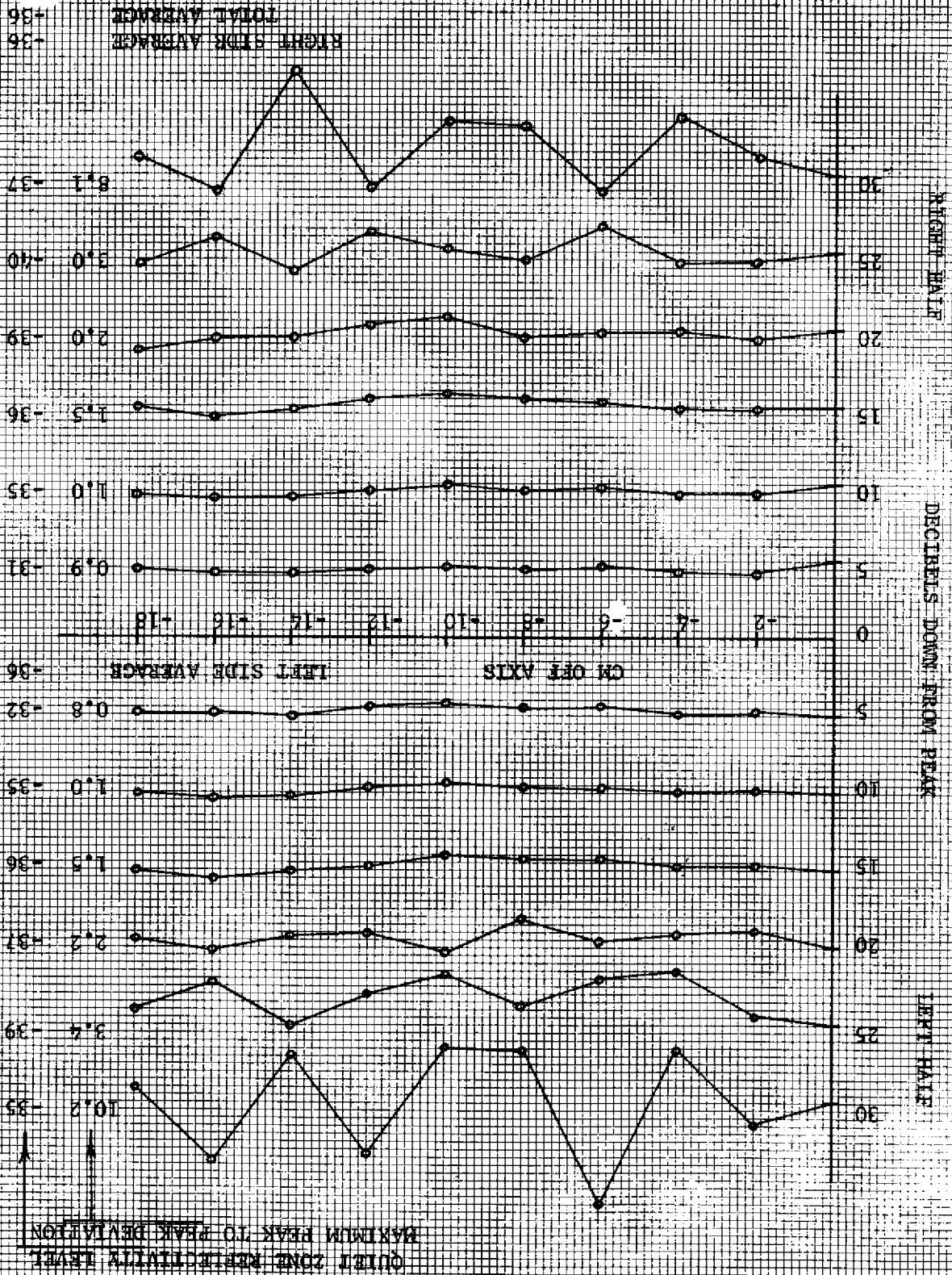

Figure 21. Deviation plot for Test 2, Upper Traverses, Negative



QUIET ZONE REFERENCE LEVEL
MAXIMUM PEAK TO PEAK DEVIATION

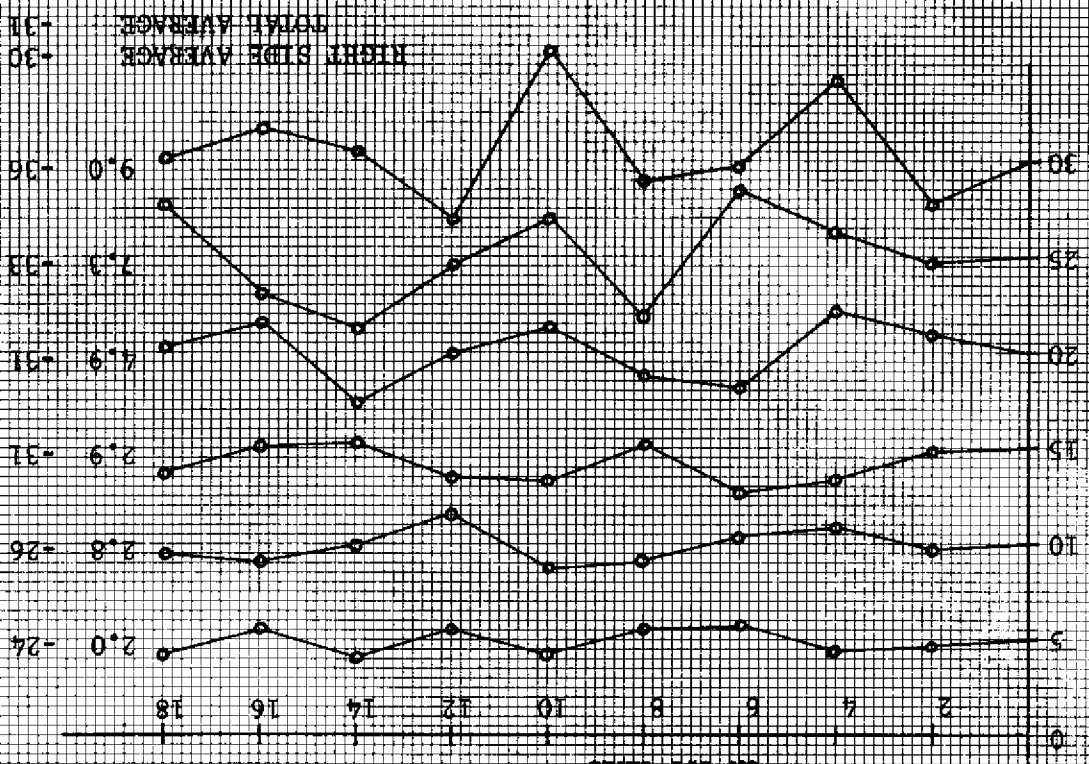
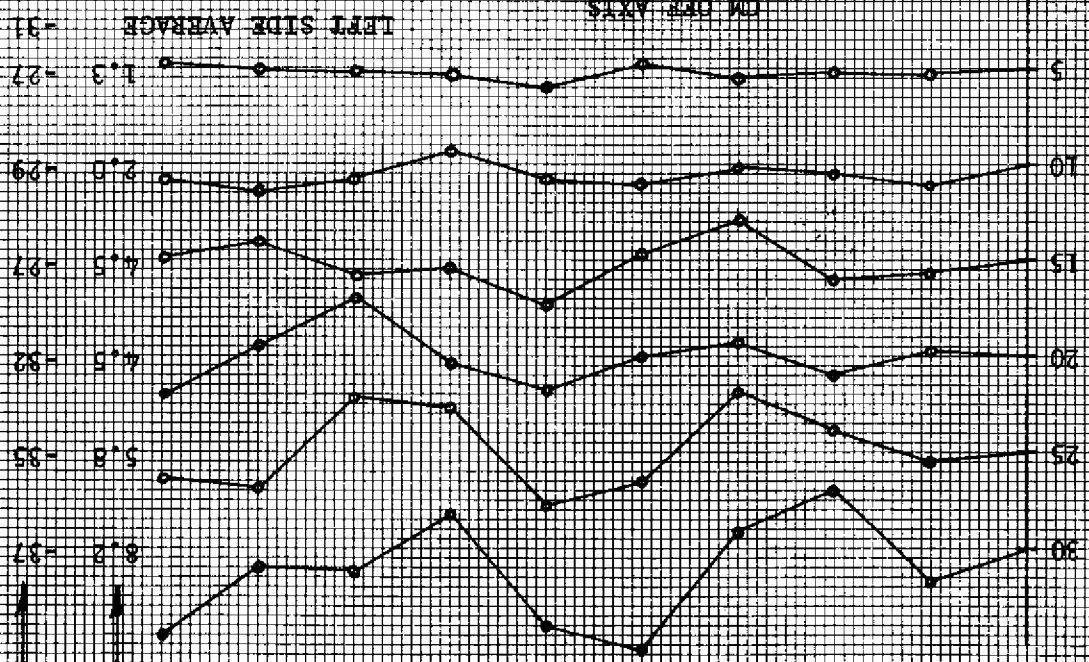
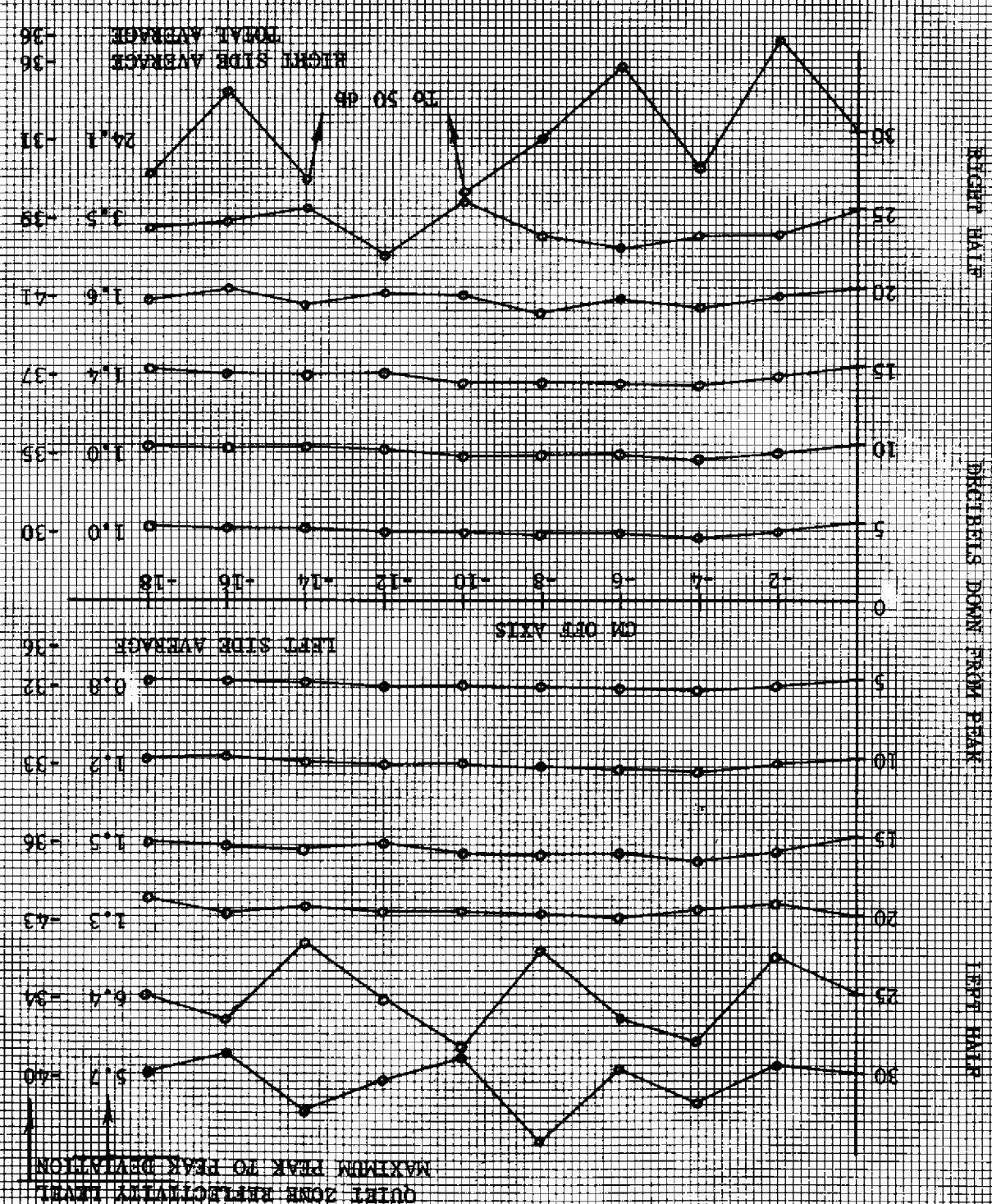

Figure 22. Deviation plot for test 2, upper threshold, positive distance from axis.

FIGURE 23. Deviation Plot for Test 2, Middle Tiercase, Negative Deviation from Peak



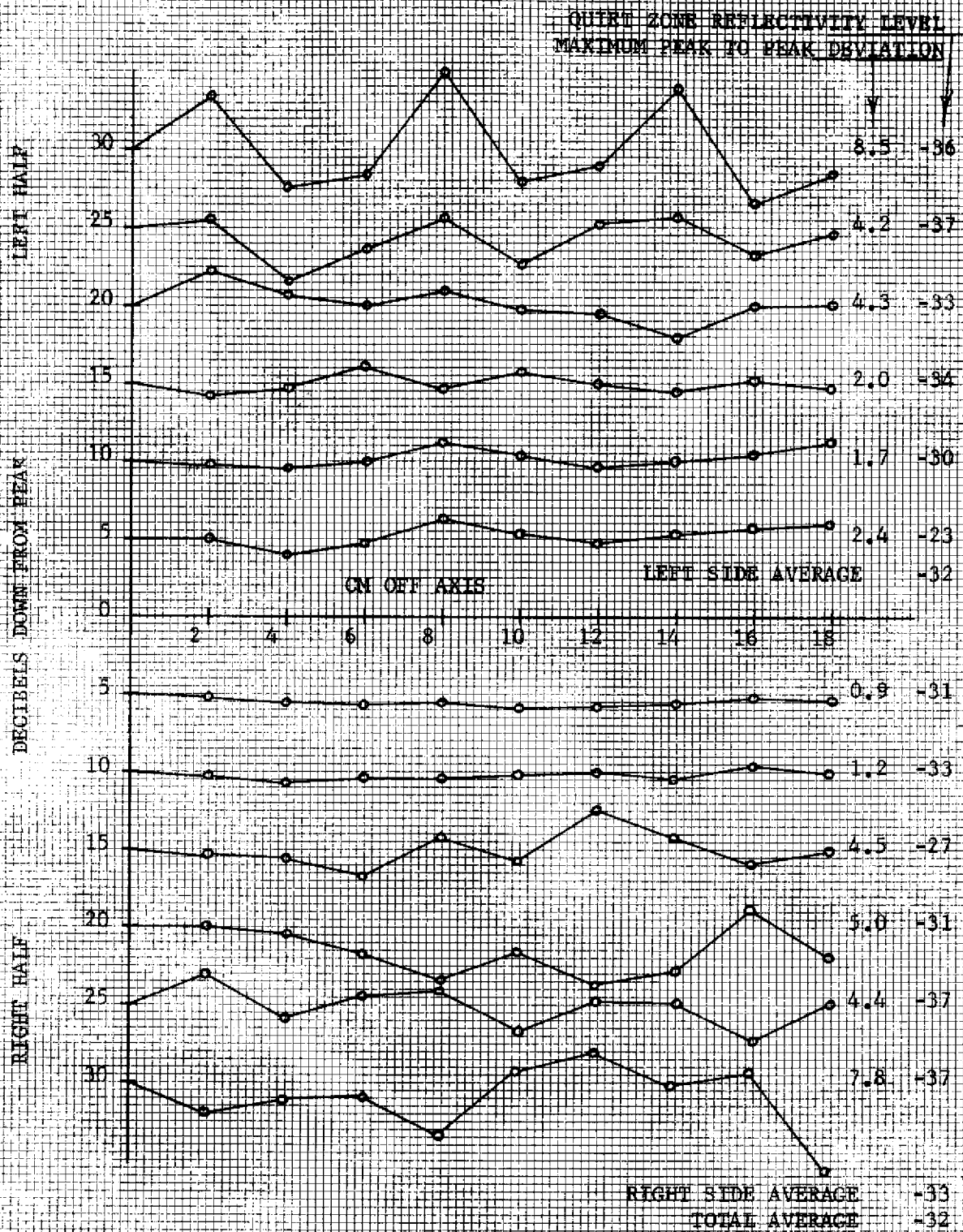

Figure 24. Deviation Plot for Test 2, Middle Traverse, Positive Distance from Axis.

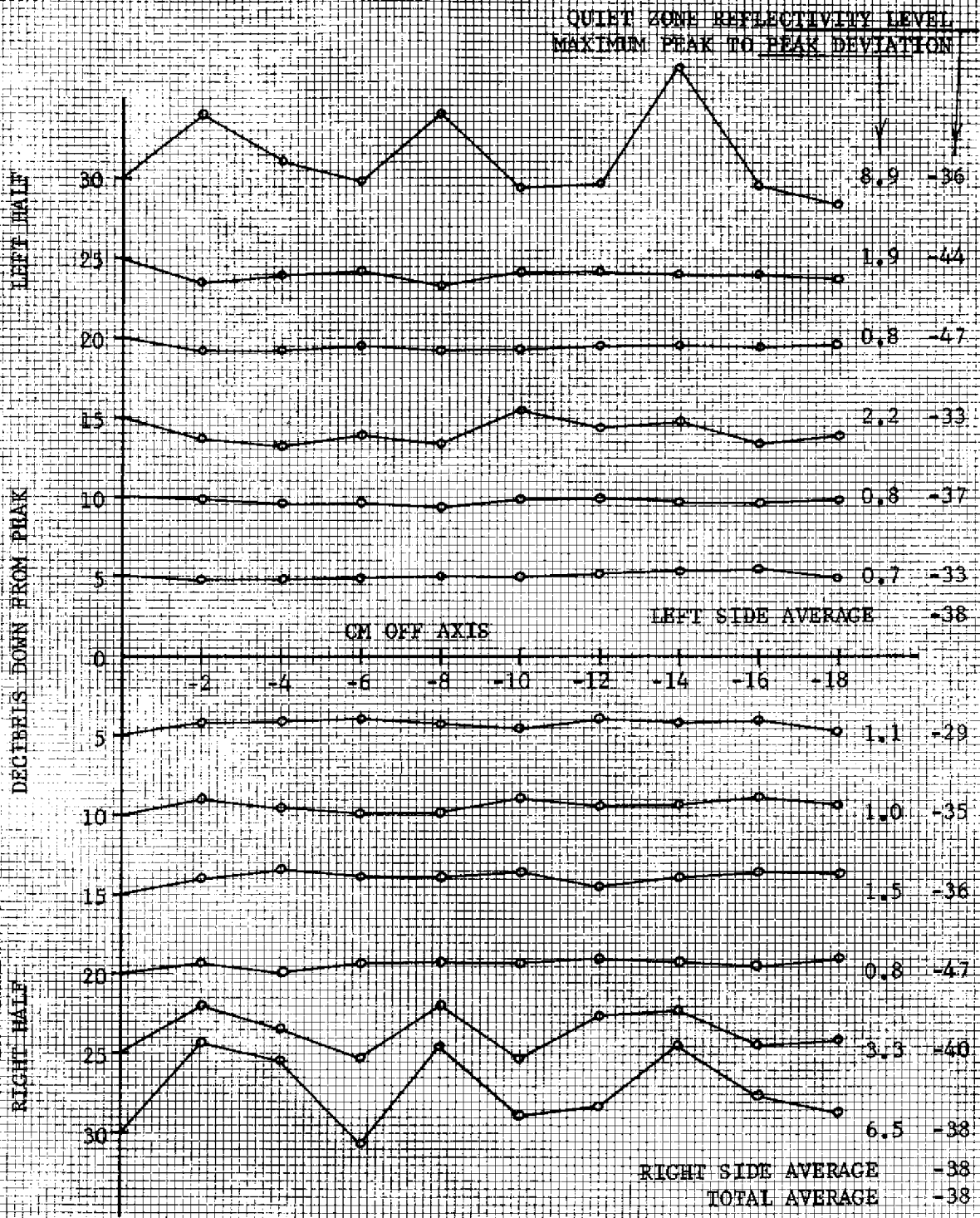

Figure 25. Deviation Plot for Test 2, Lower Traverse, Negative Distance from Axis.

QUIET ZONE REFLECTIVITY LEVEL
 MAXIMUM PEAK TO PEAK DEVIATION

RIGHT SIDE AVERAGE -32
 TOTAL AVERAGE -32

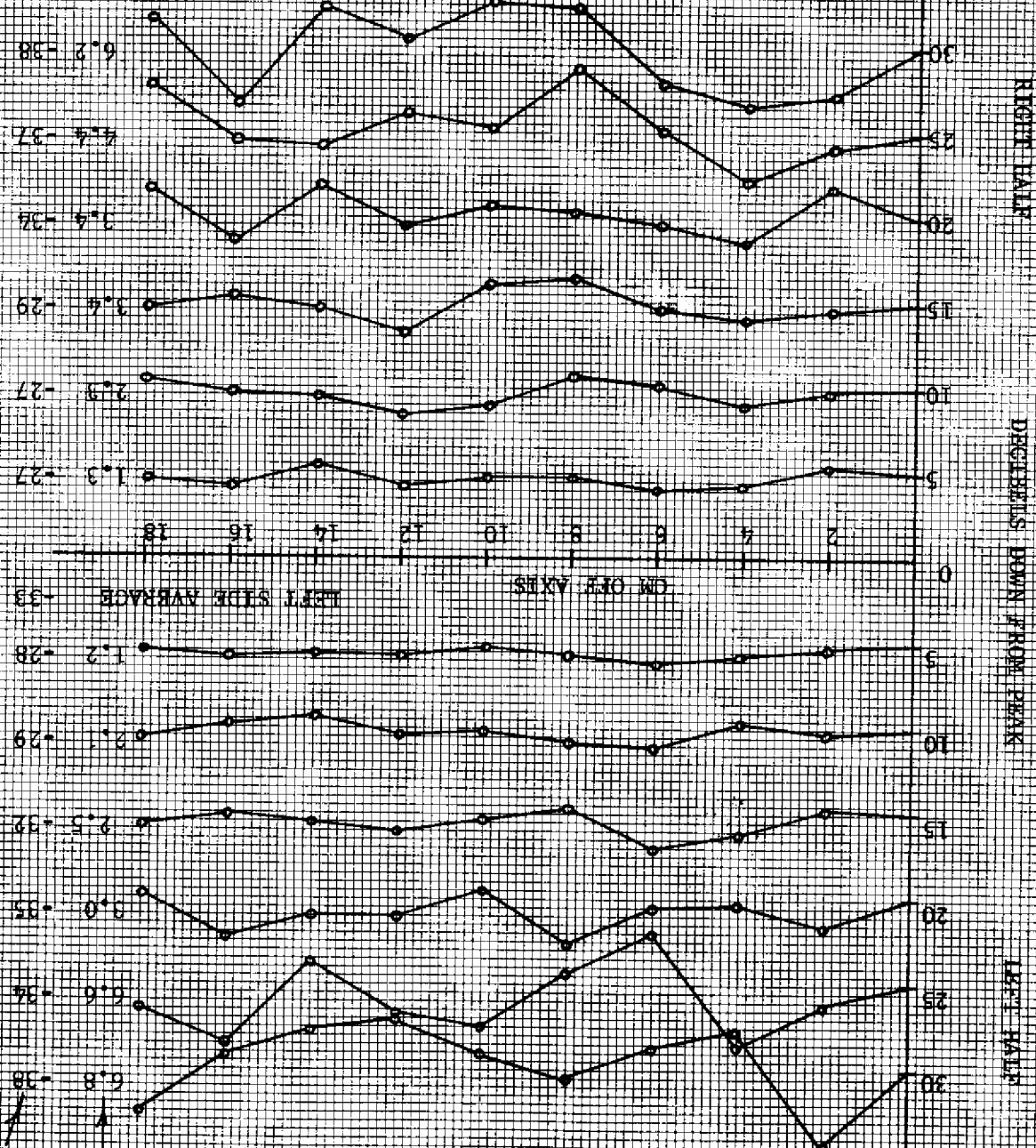

Figure 20. Deviation Plot for Level 2, Lower Inverse, Positive
 Deviation from Peak

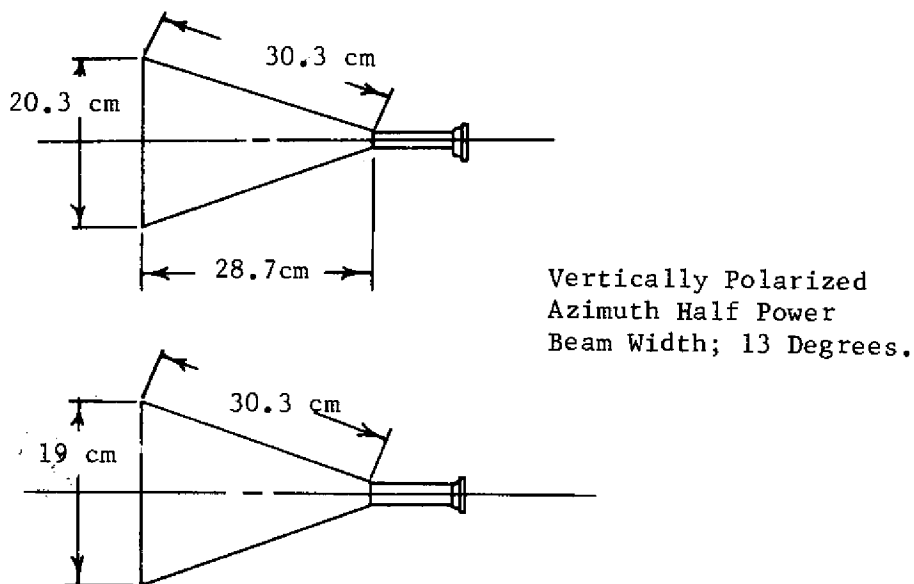

Figure 27. 20 db Gain Horns Used in the First Test for Measuring Quiet Zone Reflectivity, in the Test for Measuring Equivalent Room Radar Cross Section, and in the Test for Measuring "Termination VSWR".

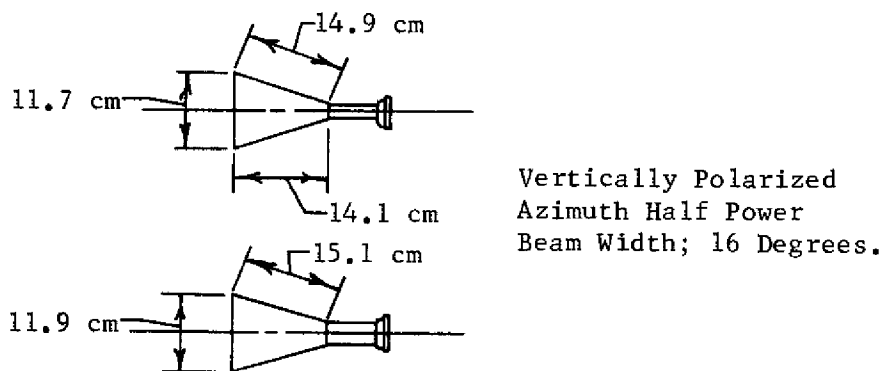

Figure 28. 15 db Gain Horn Used in the Second Test for Measuring Quiet Zone Reflectivity.

BIBLIOGRAPHY

1. E. F. Buckley, "Outline of Evaluation Procedures for Microwave Anechoic Chambers," Microwave Journal, August 1963.
2. "Testing of Absorbers and Free Space Rooms," McMillan Industrial Corporation, Report FS-4.
3. "Antenna Pattern Range Evaluation by Pattern Comparison Method," Emerson and Cuming, Inc.
4. C. G. Montgomery, Technique of Microwave Measurements, McGraw-Hill, 1947, pp. 607-608.
5. E. L. Ginzton, Microwave Measurements, McGraw-Hill, 1957, pp. 286-288.
6. Dowker and Redheffer, "Radome Bulletin No. 10: The Measurement of Small Reflections," Massachusetts Institute of Technology Radiation Laboratory, Report No. 483-10.
7. "Indoor Measurements of Electromagnetic Radiation," McMillan Industrial Corporation, Report FS-1.
8. E. F. Buckley, "Microwave Reflectivity Measurements-Theory and Practice," Electronic Design, March 15, 1962.
9. "Eccosorb Anechoic Chambers," Emerson and Cuming, Inc., 1961.
10. The Ohio State University Research Foundation, Final Engineering Report 1073-4, Contract AF 19(604)-6157, January 1, 1961, pp. 33-37.
11. C. C. Cutler, A. P. King, and W. E. Kock, "Microwave Antenna Measurement," Proceedings of the Institute of Radio Engineers, 35 (December 1942), p. 1462.
12. E. C. Jordan, Electromagnetic Waves and Radiating Systems, Prentice-Hall, Inc., 1950.
13. J. D. Kraus, Antennas, McGraw-Hill, 1950.
14. S. Silver, Microwave Antenna Theory and Design, McGraw-Hill, 1949.
15. "State of the Art", pamphlet, B. F. Goodrich Company.
16. M. I. Skolnik, Introduction to Radar Systems, McGraw-Hill, 1962.