

AEDC-TR-68-216

cy#1

**ARCHIVE COPY
DO NOT LOAN**

**AN INVESTIGATION OF EJECTOR SYSTEMS USING
VERY LARGE DIFFUSERS**



R. D. Herron

ARO, Inc.

PROPERTY OF U. S. AIR FORCE
AEDC LIBRARY
F40600-69-C-0001

November 1968

This document has been approved for public release
and sale; its distribution is unlimited.

TECHNICAL REPORTS
NOV 1968

**PROPULSION WIND TUNNEL FACILITY
ARNOLD ENGINEERING DEVELOPMENT CENTER
AIR FORCE SYSTEMS COMMAND
ARNOLD AIR FORCE STATION, TENNESSEE**

AEDC TECHNICAL LIBRARY



PROPERTY OF U. S. AIR FORCE
AEDC LIBRARY
F40600 - 69 - C - 0001

NOTICES

When U. S. Government drawings specifications, or other data are used for any purpose other than a definitely related Government procurement operation, the Government thereby incurs no responsibility nor any obligation whatsoever, and the fact that the Government may have formulated, furnished, or in any way supplied the said drawings, specifications, or other data, is not to be regarded by implication or otherwise, or in any manner licensing the holder or any other person or corporation, or conveying any rights or permission to manufacture, use, or sell any patented invention that may in any way be related thereto.

Qualified users may obtain copies of this report from the Defense Documentation Center.

References to named commercial products in this report are not to be considered in any sense as an endorsement of the product by the United States Air Force or the Government.

AN INVESTIGATION OF EJECTOR SYSTEMS USING
VERY LARGE DIFFUSERS

R. D. Herron
ARO, Inc.

This document has been approved for public release
and sale; its distribution is unlimited.

FOREWORD

The research reported herein was sponsored by the Arnold Engineering Development Center (AEDC), Air Force Systems Command (AFSC), under Program Element 6240518F, Project 5730, Task 573004.

The results of research presented in this report were obtained by ARO, Inc. (a subsidiary of Sverdrup & Parcel and Associates, Inc.), contract operator of the AEDC, AFSC, Arnold Air Force Station, Tennessee, under Contract F40600-69-C-0001. The work was performed from December 1965 to June 1968 under ARO Projects No. PW2621, PW2713, and PW5813, and the manuscript was submitted for publication on September 6, 1968.

This technical report has been reviewed and is approved.

Eules L. Hively
Research Division
Directorate of Plans
and Technology

Edward R. Feicht
Colonel, USAF
Director of Plans
and Technology

ABSTRACT

An experimental investigation was conducted to determine the characteristics of ejector systems using very large cylindrical diffusers. Tests were conducted with nitrogen, carbon dioxide, and helium gases in systems having diffuser cross section to nozzle throat area ratios from 950 to 15,300. Limited effects of ejector nozzle configuration, diffuser length, system size, and diffuser wall cooling were investigated. Excellent system performance was obtained, with test cell altitudes of 250,000 ft being produced by the pumping action of the ejector at nozzle total pressures of approximately 100 to 200 psia.

CONTENTS

	<u>Page</u>
ABSTRACT.	iii
NOMENCLATURE.	vii
I. INTRODUCTION	1
ii. APPARATUS AND TEST PROCEDURE	
2.1 18-in. Test Cell	1
2.2 Cold Wall Vacuum Chamber	2
2.3 Instrumentation	3
2.4 Procedure	3
III. GENERAL EJECTOR OPERATIONAL CHARACTERISTICS	
3.1 Operational Characteristics	4
3.2 One-Dimensional Theory	5
IV. RESULTS AND DISCUSSION	
4.1 Basic Ejector Performance	6
4.2 Ejector Configuration Effects	7
V. CONCLUDING REMARKS	9
REFERENCES	10

APPENDIXES

I. ILLUSTRATIONS

Figure

1. 18-in. Test Cell Installation	15
2. Ejector Installation in the 18-in. Test Cell.	16
3. Ejector Nozzle Tested in the 18-in. Test Cell	17
4. Cold Wall Vacuum Chamber Installation	18
5. Ejector Nozzles Tested in the Cold Wall Vacuum Chamber	
a. 16-deg Conical Nozzle	19
b. Contoured Nozzle	19
6. Ejector Installation in the Cold Wall Vacuum Chamber.	20
7. General Ejector Operational Characteristics	
a. Idealized Operating Cycle	21
b. Real Ejector Operating Conditions Corresponding to Point C of Fig. 7a	21

<u>Figure</u>	<u>Page</u>
8. Operational Characteristics of Ejector Systems in the 18-in. Test Cell with $A_D/A^* = 950$, $L/D = 10$	
a. CO ₂	22
b. N ₂	23
c. He	24
9. Operational Characteristics of Ejector Systems in the 18-in. Test Cell with $A_D/A^* = 2410$, $L/D = 10$	
a. CO ₂	25
b. N ₂	26
c. He	27
10. Operational Characteristics of Ejector Systems in the 18-in. Test Cell with $A_D/A^* = 6045$, $L/D = 10$	
a. CO ₂	28
b. N ₂	29
c. He	30
11. Operational Characteristics of Ejector Systems in the CWVC using CO ₂ and the 18-in. Cell Nozzle for $A_D/A^* = 15,300$, $L/D = 6$	31
12. Effect of Reynolds Number on the Diffuser Recovery for an L/D of 10	
a. CO ₂	32
b. N ₂	33
c. He	34
13. Effect of Ejector Area-Ratio on the Optimum System Performance	
a. Minimum Test Cell Pressure for $T_t = 100^\circ\text{F}$	35
b. Minimum Test Cell Pressure for $T_t = 1000^\circ\text{F}$	36
c. Maximum Exhauster Pressure	37
14. Effect of Diffuser Length on the Operational Characteristics of the 18-in. Test Cell System Using Nitrogen	
a. $T_t = 1000^\circ\text{F}$, $A_D/A^* = 950$	38
b. $T_t = 100^\circ\text{F}$, $A_D/A^* = 6045$	39
c. $T_t = 1000^\circ\text{F}$, $A_D/A^* = 6045$	40
15. Effect of System Scale on the Operating Characteristics of the Ejector System Using CO ₂ with $A_D/A^* = 6045$ and $L/D = 6$	41

<u>Figure</u>	<u>Page</u>
16.	Effect of Ejector Nozzle Exit Angle and Diffuser Wall Cooling on the Operational Characteristics of the CWVC System Using CO ₂ at T _t = 100°F
a.	A _D /A* = 950 42
b.	A _D /A* = 2410 43
c.	A _D /A* = 6045 44
 II. TABLES	
I.	Diffuser Dimensions. 45
II.	Test Cell and Maximum Exhauster Pressure Ratios as Calculated from the One-Dimensional Theory. 46
III.	REYNOLDS NUMBER CORRELATION 47

NOMENCLATURE

A _D /A*	Diffuser cross section to nozzle throat area ratio
D	Diffuser diameter
d*	Ejector nozzle throat diameter
L	Diffuser length
p ₂	Static pressure behind a normal shock occurring at the Mach number defined by γ and A _D /A*
p _c	Test cell pressure
p _{ex}	Exhauster pressure
p _t	Ejector nozzle total pressure
Re _D	Reynolds number, $\frac{\rho V D}{\mu}$
T _t	Ejector gas total temperature
V	Velocity
γ	Ratio of specific heats
η	Diffuser recovery, p _{ex} /p ₂

θ_N	Ejector nozzle exit half-angle
μ	Gas viscosity
ρ	Density

SECTION I INTRODUCTION

The requirement for simulated high altitude testing of rocket systems is complicated by the extremely high volume pumping rates required for even a small mass flow of propellant gases. Many tests have been successfully conducted at moderate altitudes (100,000 to 150,000 ft) by exhausting the rocket into a diffuser, thereby compressing the gases before entering into conventional exhaust machinery. This technique usually requires that the diffuser be of fairly small diameter, and therefore the cell altitude produced is only moderate. Also, the small diffuser prohibits tests requiring large undisturbed exhaust plumes. For tests requiring large plumes and/or high altitudes, very large cryogenically pumped test cells are used. These tests have been limited to very small propulsion systems, and the limited test cell pumping capacity usually leads to testing with an altitude transient.

One possible method for obtaining the high altitudes and large portions of undisturbed exhaust plumes would be to use very large exhaust diffusers. This "high-area-ratio" (diffuser cross section to nozzle throat area) ejector system theoretically should provide a high test altitude. However, the gain in test cell altitude obtained must be balanced against a low diffuser exhaust pressure required to maintain the ejector action.

The purpose of the present investigation was to study the basic performance of simple, high-area-ratio ejector systems, to provide data for comparison with existing ejector theories, and to allow the designer of high altitude test systems to optimize the design of the system. Experimental tests were conducted in an 18-in. test cell and also in the Cold Wall Vacuum Chamber (CWVC). Nitrogen (N_2), carbon dioxide (CO_2), and helium (He) were used as the ejector gases. Exhaust diffuser to nozzle throat area ratios up to 15,300 were investigated for simple cylindrical exhaust diffusers. In addition, limited data were obtained on the effects of diffuser length, system size, ejector nozzle configuration, and diffuser wall cooling.

SECTION II APPARATUS AND TEST PROCEDURE

2.1 18-IN. TEST CELL

The majority of testing reported herein was conducted in an 18-in.-diam test cell with the ejector diffusers connected to a six-stage steam

ejector. The test cell installation is shown in Fig. 1 (Appendix I). Tests were conducted using N_2 , CO_2 , and He as the ejector gases. Test gases were heated by an electric resistance-type heater and expanded through the conical ejector nozzle into the test cell and the diffuser. The ejector nozzle had a throat diameter of approximately 0.1 in., an exit area ratio of approximately 26, and an exit half-angle of 16 deg. Details of the test cell and diffuser installation are shown in Fig. 2, and the ejector nozzle configuration is shown in Fig. 3.

Tests were conducted with three cylindrical diffusers corresponding to diffuser cross section to nozzle throat area ratios of 950, 2410, and 6045. Diffuser length to diameter (L/D) ratios of 6 and 10 were tested for all three area ratios; and in addition, an L/D ratio of 20 was tested for the diffuser with an area ratio of 950. The diffuser dimensions are given in Table I (Appendix II).

2.2 COLD WALL VACUUM CHAMBER

In addition to the tests in the 18-in. test cell, tests were conducted in the PWT Cold Wall Vacuum Chamber (CWVC) using CO_2 as the ejector gas. The CWVC is a liquid-nitrogen (LN_2)-cooled chamber which cryopumps the CO_2 exhaust gas. The test cell installation is shown in Fig. 4. A complete description of the CWVC and its operating characteristics are given in Ref. 1. The greater pumping capacity of the CWVC over that of the steam ejector system allowed tests to be conducted with larger ejector system sizes and higher ejector nozzle total pressures than possible in the 18-in. test cell. Two ejector nozzles were tested, both having a throat diameter of approximately 0.16 in. and an exit area ratio of approximately 25. The larger size of the CWVC made possible the construction of a 0-deg exit contoured nozzle in addition to a nozzle having a 16-deg exit half-angle. A radius-of-curvature nozzle contour was chosen for the 0-deg nozzle to keep the nozzle length and boundary layer small and still give a reasonable exit Mach number profile. Based on an ideal gas with a specific heat ratio of 1.28, the exit Mach number varies from 4.01 at the nozzle wall to 4.69 at the centerline. The ejector nozzle configurations are shown in Fig. 5.

Tests were conducted with cylindrical diffusers at the same three nominal area ratios as were tested in the 18-in. test cell - 950, 2410, and 6045. In addition, limited tests were conducted with a combination of the largest CWVC diffuser and the nozzle used in the 18-in. cell tests. This combination gave an area ratio of approximately 15,300. All diffusers had an L/D ratio of approximately six, and all were tested with and without the walls cooled with LN_2 . Small flow rates of LN_2 up to a maximum of 2 gal/min were used. However, this rate was

sufficient to condense CO_2 on the diffuser walls. A schematic of the CWVC installation is shown in Fig. 6, and the dimensions of the ejector diffusers are given in Table I.

2.3 INSTRUMENTATION

Identical instrumentation systems were used in the 18-in. test cell and in the CWVC for all test instrumentation. Primary test measurements were the ejector gas total temperature and three pressures. The three pressures required to evaluate system performance are the ejector nozzle total pressure, p_t , the test cell pressure, p_c , and the pressure to which the diffuser exhausts, p_{ex} .

Since p_t ranged from 10 to approximately 700 psia, three instruments were used for this measurement. Two Precision Pressure Balance Transducers were used for the ranges from 0 to 50 psia and 0 to 500 psia, and a strain-gage transducer was used for pressures above 500 psia.

The p_c and p_{ex} were measured on Datametric Barocells. Dual measurements were made for the p_c . The Barocells have a maximum pressure range of 0 to 10 torr and have the capability of being "down-ranged" over seven ranges to a minimum pressure range of 0 to 10^{-2} torr. The high range of p_{ex} was measured with a 0- to 5-psia Precision Pressure Balance Transducer.

Test cell pressures were not corrected for possible thermomolecular pressure effects (Ref. 2). Such a noncontinuum flow correction would be required only for the high temperature data and only for the lowest test cell pressures obtained. This correction was not applied because of the generally small value of the correction and the uncertainty of defining a gas temperature at the measurement orifice.

For tests in the CWVC, thermocouples were installed in the LN_2 exhaust passage from the diffuser. The output of these thermocouples was monitored and recorded during the tests with cooled diffuser walls to determine if the LN_2 flow was sufficient to cool the diffuser.

2.4 PROCEDURE

Because of the very low test cell pressures, He leak detectors were used prior to the start of testing to ensure that the test cell was free of leaks. The cell was also rechecked after configuration changes.

Leaks into the exhauster system were not critical, and no major effort was made to locate them.

The test procedure was the same for both the CWVC and the 18-in. test cell. A typical run consisted of setting p_t and T_t at some set of constant values while maintaining p_{ex} as low as possible. The p_{ex} was then slowly increased over the operating range of the ejector. Usually p_{ex} was then decreased to check for possible hysteresis effects. Data were recorded continuously throughout the run.

In the 18-in. test cell, p_{ex} was controlled by a throttling valve at the entrance to the steam ejector; in the CWVC, p_{ex} was controlled by inbleeding air, which is noncondensable on the LN₂ cryosurfaces.

SECTION III GENERAL EJECTOR OPERATIONAL CHARACTERISTICS

3.1 OPERATIONAL CHARACTERISTICS

A thorough discussion of the operational characteristics of ejectors without induced (secondary) flow has been given in Ref. 3, and only a brief summary will be given here to aid in understanding the discussion to follow.

An idealized ejector operating cycle is shown in Fig. 7a. For values of p_{ex} greater than that at point B, C, the flow in the ejector diffuser is "collapsed" and supersonic flow does not extend to the diffuser walls. The system is then said to be "unstarted." As a result, changes in p_{ex} cause changes in p_c as well. However, p_c remains lower than p_{ex} because of viscous entrainment by the nozzle flow.

When p_{ex} decreases to point B, C, a sudden decrease in p_c occurs as the nozzle flow expands to fill the diffuser with supersonic flow. Thereafter as p_{ex} is decreased toward point D, no change occurs in p_c as downstream disturbances cannot propagate upstream through the supersonic diffuser flow. The system is then said to be "started."

Ideally, the cycle will repeat exactly if p_{ex} is increased from point D to point A. However, in practice, hysteresis is sometimes observed, with the ejector remaining started to a slightly higher value of p_{ex} than was originally required to start it.

Since an ejector system operating at point C will require the least possible exhauster equipment or allow the largest possible mass flow

for a given exhaust system, the location of point C is of prime interest. This point corresponds to the highest possible "rise ratio," p_{ex}/p_c , for the system.

3.2 ONE-DIMENSIONAL THEORY

A simple method for rapidly estimating the system performance, referred to as a one-dimensional theory in Ref. 3, is based on the assumption that the minimum cell and the maximum exhaust pressure ratios are defined by a one-dimensional flow corresponding to the Mach number determined by the ratio of cylindrical diffuser cross section to nozzle throat area. Therefore, the cell to total pressure ratio, p_c/p_t , corresponds to the static to total pressure ratio of the one-dimensional flow. Also, for straight cylindrical diffusers the maximum exhaust to total pressure ratio, p_{ex}/p_t , corresponds to the ratio of the static pressure after the normal shock to the total pressure before the normal shock. This method does not include variables such as nozzle exit flow conditions or Reynolds number effects but does include changes of specific heat ratios. For the calculations given in this report, specific heat ratios of 1.28, 1.40, and 1.667 were used for CO_2 , N_2 , and He, respectively. Pressure ratios as calculated from the one-dimensional theory are given in Table II.

Ideally, for a given configuration, the cycle shown in Fig. 7a is valid for all nozzle total pressures, being completely characterized by the cell and exhaust to nozzle total pressure ratios. However, as illustrated in Fig. 7b, these ratios are actually functions of the nozzle total pressure (Reynolds number). This dependence is particularly pronounced for the test cell pressure (Ref. 4). A much more detailed theory for the test cell pressure, proposed by Korst (Ref. 5) and modified by Bauer (Ref. 6), accounts for the viscous mixing on the boundary of the ejector jet and requires a detailed calculation of the jet impingement and turning at the diffuser wall. However, this detailed theory does not indicate a dependence on ejector total pressure (or Reynolds number) for turbulent jets. The effect of total pressure on the test cell pressure is thought to be due to its effect on the nozzle boundary layer, which is not accounted for, and to the effect of regions of laminar flow. High jet gas temperatures will affect the test cell pressure through its effect on the Reynolds number and also by the creation of a noniso-energetic mixing process. Note that real-gas behavior such as condensation, varying ratio of specific heats, and possibly molecular non-equilibrium, can cause the ejector performance to be dependent on the temperature, pressure, and system scale. Generally, the exhaust pressure ratio is constant for moderate to high Reynolds numbers.

However, for the lower densities considered in this report, the characteristics shown in Fig. 7b are exhibited.

SECTION IV RESULTS AND DISCUSSION

4.1 BASIC EJECTOR PERFORMANCE

The experimental operational characteristics of the basic ejector systems are shown in Figs. 8 through 11. Results are shown for simple cylindrical diffusers with an L/D of 10 with the exception of Fig. 11 which is for an L/D of 6. The data are shown in the form of Fig. 7b, giving the cell and exhaustor pressure ratios corresponding to the conditions just before the diffuser unstarts (point C, Fig. 7a). In general, very little difference was found between this point and the point at which the ejector would become started when the exhaustor pressure was initially lowered (small hysteresis in the start-unstart cycle).

The data for the test cell pressure show an effect of the nozzle total pressure and a large effect of the nozzle total temperature (Reynolds number, nonisoenergetic mixing, and real-gas effects as discussed in Section 3.2). Whereas the data for CO₂ and N₂ can reflect real-gas behavior, the data for He are for a truly perfect gas. Note that the data for CO₂ and N₂ show the same general trends as the data for He, with a significant decrease in the test cell pressure being caused by an increase in the gas temperature.

A Reynolds number correlation of the diffuser recovery (the exhaustor pressure ratioed to the theoretical one-dimensional normal shock static pressure) is shown in Fig. 12. The Reynolds number is based on the diffuser diameter and the one-dimensional flow properties defined by the diffuser cross section to nozzle throat area ratio. The method of calculating the Reynolds number and the values of viscosity used are given in Appendix III. The Reynolds number correlation is excellent for each gas. It should be noted that the optimum diffuser recovery is not affected by the ejector gas temperature, whereas the test cell pressure ratio is affected. For the higher values of Reynolds number (when p_{ex}/p_t is constant), the diffuser recovery is quite good, corresponding to approximately 85 to 90 percent of the one-dimensional normal shock value for N₂ and CO₂ and up to 80 percent for He.

It should be noted that the ejector performance shown in Figs. 8 through 11 is for one of the simplest possible configurations. Refinements in ejector design, such as conical jet impingement surfaces (Ref. 7) and secondary pumping of the test cell (Ref. 8), would be expected to lower the test cell pressure. Also, the addition of a subsonic diffuser and/or a diffuser second-throat (Refs. 9 and 10) would be expected to raise the maximum exhaust pressure. However, quite excellent performance is provided by the simple cylindrical diffuser, with rise ratios (p_{ex}/p_c) up to 100 obtained at test cell to total pressure ratios as low as 2×10^{-6} . This test cell pressure, produced by the pumping action of the ejector, would correspond to an altitude of 250,000 ft for nozzle total pressures of approximately 100 to 200 psia.

The disadvantage of the system is the low exhaust pressures required to maintain the started diffuser. An exhaust pressure corresponding to an altitude of about 150,000 ft would be required for the previous example. Although second-throat diffusers would help, the system might perhaps be best adapted to cryogenically pumped chambers, where the chamber could act as the exhaust system. The ejector would provide a steady-state high altitude test condition for a short period until noncondensable gases or the heat load to the cryo-surfaces caused the exhaust (chamber) pressure to rise to the point of unstating the diffuser.

The effect of the exhaust diffuser to nozzle throat area ratio can be seen in Fig. 13, in which the optimum performance values from Figs. 8 through 11 are given. The optimum data shown are the lowest test cell and the highest exhaust pressure ratios obtained for the test condition and configuration shown. Also shown are data for smaller area ratio systems taken from Refs. 3 and 11 for air at stagnation temperatures of approximately 100°F and for solid-propellant rockets. This figure demonstrates the lower cell pressures obtainable by increasing the diffuser size as well as the resulting requirement for lower exhaust pressures. It is encouraging that the optimum performance values do not diverge greatly from the simple one-dimensional theory predictions, although as previously shown, careful consideration must be given to phenomena associated with the low Reynolds numbers of these systems.

4.2 EJECTOR CONFIGURATION EFFECTS

The decrease in the maximum exhaust pressure at low Reynolds numbers is analogous to the decrease in efficiency of low density wind

tunnel diffusers (Refs. 12 and 13). Such wind tunnels frequently employ very long constant area diffuser sections to improve their performance. Therefore, in addition to the tests with an L/D of 10, tests were conducted in the 18-in. test cell with diffusers with an L/D of 6 for all area ratios and with an L/D of 20 for the diffuser with an area ratio of 950. Typical results of these tests are shown in Fig. 14. Similar to the wind tunnel experience, diffuser performance is improved by lengthening the diffuser to longer values than the optimum length for conventional high density ejector systems (Ref. 11).

Since the decrease in the maximum exhaust pressure is primarily due to viscous forces associated with the low Reynolds numbers, an improvement in performance would be expected for larger size systems. Some measure of this effect can be obtained by comparing data from the 18-in. test cell with that obtained in the CWVC. Diffusers tested in the CWVC had an L/D of 6 and the diameters were approximately 60 percent larger than those tested in the 18-in. test cell. The effect of size is shown in Fig. 15. For the tests with the higher gas temperatures, the larger size diffuser does show an improvement in performance by delaying the decrease in the maximum exhaust pressure to a lower nozzle total pressure. Also, a small decrease in the CWVC test cell pressure is shown for the low temperature ejector gas, which may be caused by real-gas effects.

In the more detailed theories of ejector performance (Refs. 5 and 6), the angle of the jet impingement on the diffuser wall is a significant factor in establishing the test cell pressure. The jet with the smallest impingement angle will produce the lowest cell pressure, other factors being equal. For the same exit Mach number ejector nozzle, the initial angle of the jet outside the nozzle, and therefore the jet impingement angle, may be decreased by decreasing the angle of the nozzle exit. Therefore, tests were conducted in the CWVC with a 16-deg conical ejector nozzle and with a 0-deg contoured nozzle. Results of these tests are shown in Fig. 16. A decrease in the test cell pressure is shown for the 0-deg nozzle; however the decrease is small, becoming very small for the larger diffusers. Perhaps the jet boundary viscous mixing is becoming large enough to overshadow the change in the jet impingement angle. In any event, for the systems tested, changes in the ejector nozzle exit angle have a small effect on the test cell pressure.

Since the flow in high-area-ratio ejector diffusers is of a very low density, some improvement in performance might be expected by cooling or cryopumping the walls of the diffuser. The requirement for LN₂ for the CWVC operation makes cooled diffuser tests relatively simple

in that chamber. Results of these tests are also shown in Fig. 16. A consistent, small increase in the maximum exhaustor pressure was found with the cooled diffusers. Also, cooling has a very significant effect on the test cell pressures, particularly at the low ejector total pressures. As much as an order-of-magnitude decrease in the cell pressure is easily obtained. Part of the decrease may be caused by the cryopumping of cell gas by the small amount of the diffuser wall exposed to the test cell; however, the major contribution is probably because of some cryopumping of low energy mixing layer gas in the jet impingement region. The smaller effect of wall cooling on the test cell pressure at the higher total pressures may be because of the higher density of the flow and/or insufficient cooling of the impingement region because of the higher heat loads.

SECTION V CONCLUDING REMARKS

The investigation of ejector systems using very large diffusers indicates the following conclusions:

1. Excellent performance is provided by even the simple cylindrical diffusers tested, with rise ratios (p_{ex}/p_c) up to 100 obtained at test cell to total pressure ratios as low as 2×10^{-6} . This test cell pressure would correspond to test altitudes of 250,000 ft for nozzle total pressures of approximately 100 to 200 psia.
2. A large effect on the test cell pressure of driving gas total pressure and temperature was found, similar to results obtained for smaller diffusers.
3. A significant decrease in the maximum exhaustor pressure was found at high stagnation temperatures and low pressures. A Reynolds number correlation was found that gives excellent agreement for the exhaustor pressure.
4. At the higher Reynolds numbers, diffuser recoveries corresponded to approximately 85 to 90 percent of the one-dimensional normal shock value for N_2 and CO_2 and up to 80 percent for He.
5. The decrease in diffuser recovery may be delayed to lower Reynolds numbers by increasing the diffuser length. Similarly, an increase in the system size will delay the decrease to lower unit Reynolds number.

6. Limited tests on the effect of ejector nozzle configuration were conducted and the effects were found to be small.
7. A small increase in the maximum exhaust pressure and as much as an order-of-magnitude decrease in the test cell pressure was found with the cryogenically cooled diffuser walls and CO₂ as the ejector gas.

REFERENCES

1. Herron, R. D. and Binion, T. W. Jr. "The Application of Cryogenic Pumping in a High Mass Flow System." AEDC-TDR-63-199 (AD420057), October 1963.
2. Kinslow, Max and Arney, George D. Jr. "Thermo-Molecular Pressure Effects in Tubes and at Orifices." AGARDograph 119, August 1967.
3. Barton, D. L. and Taylor, D. "An Investigation of Ejectors without Induced Flow Phase I." AEDC-TN-59-145 (AD229860), December 1959.
4. Bauer, R. C. and German, R. C. "Some Reynolds Number Effects on the Performance of Ejectors without Induced Flow." AEDC-TN-61-87 (AD262734), August 1961.
5. Korst, H. H. "Theory for Base Pressures in Transonic and Supersonic Flow." Journal of Applied Mechanics, December 1956, pp. 593-600.
6. Bauer, R. C. "Theoretical Base Pressure Analysis of Axisymmetric Ejectors without Induced Flow." AEDC-TDR-64-3 (AD428533), January 1964.
7. Taylor, D., Barton, D. L., and Simmons, M. "An Investigation of Cylindrical Ejectors Equipped with Truncated Conical Inlets Phase II." AEDC-TN-60-224 (AD252634), March 1961.
8. Taylor, D., Bauer, R. C., and Simmons, M. "A Technique for Producing Very Low Ambient Densities in Ground Test Facilities during Tests of Rocket Engines." AEDC-TR-65-14 (AD457893), February 1965.
9. Bauer, R. C. and German, R. C. "The Effect of Second Throat Geometry on the Performance of Ejectors without Induced Flow." AEDC-TN-61-133 (AD267263), November 1961.

10. German, R. C. and Panesci, J. H. "Improved Methods for Determining Second-Throat Diffuser Performance of Zero-Secondary-Flow Ejector Systems." AEDC-TR-65-124 (AD466580), July 1965.
11. German, R. C. and Bauer, R. C. "Effects of Diffuser Length on the Performance of Ejectors without Induced Flow." AEDC-TN-61-89 (AD262888), August 1961.
12. Boylan, David E. "An Experimental Study of Diffusers in an Open-Jet, Low-Density, Hypersonic Wind Tunnel." AEDC-TDR-64-47 (AD434380), April 1964.
13. White, James J., III. "An Experimental Investigation of Fixed-Geometry Diffusers in an Open-Jet Wind Tunnel at Mach Numbers between 14 and 18 and Reynolds Numbers between 8,900 and 25,000." AEDC-TR-67-3 (AD648552), March 1967.

APPENDIXES

- I. ILLUSTRATIONS**
- II. TABLES**
- III. REYNOLDS NUMBER CORRELATION**

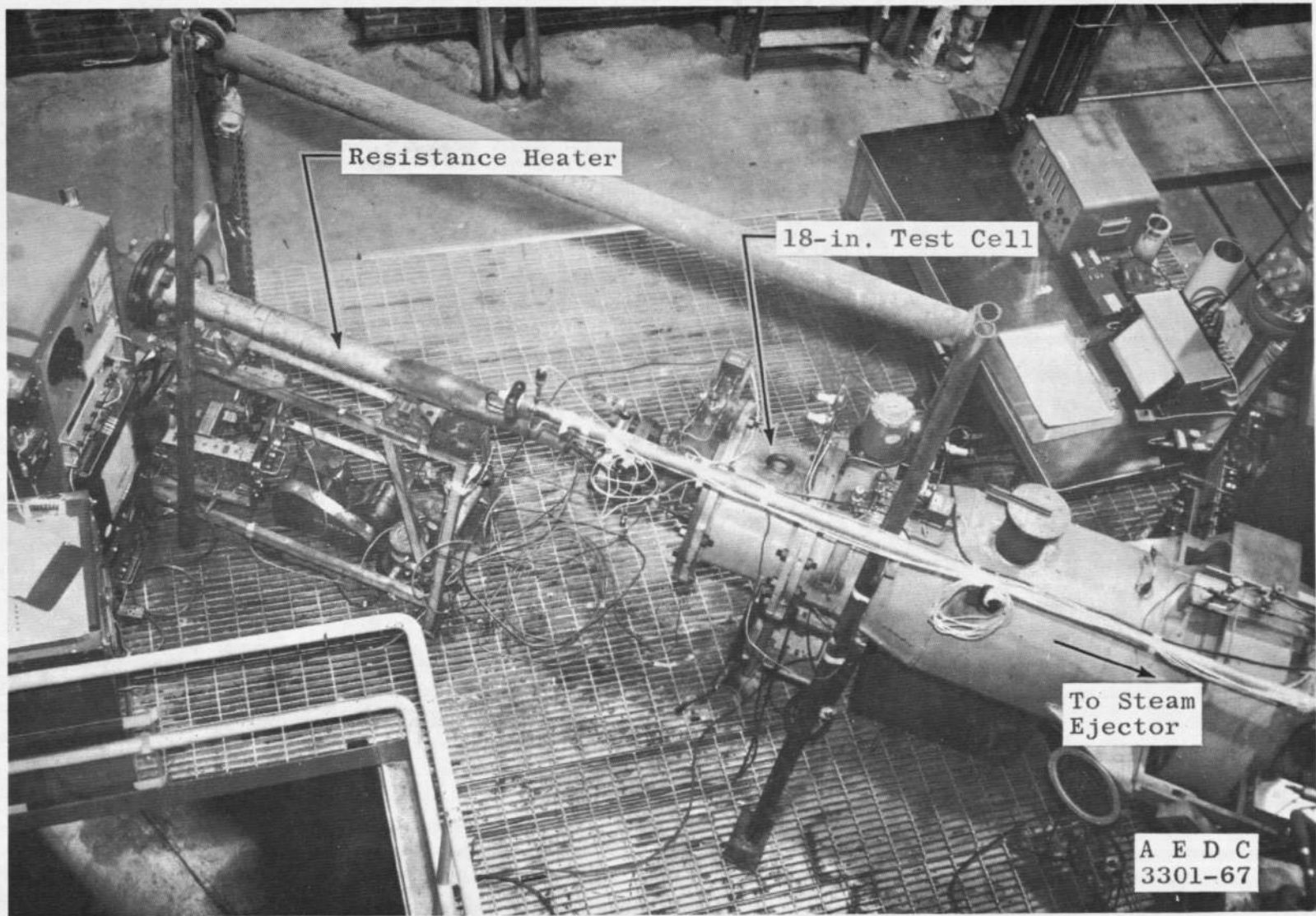

Fig. 1 18-in. Test Cell Installation

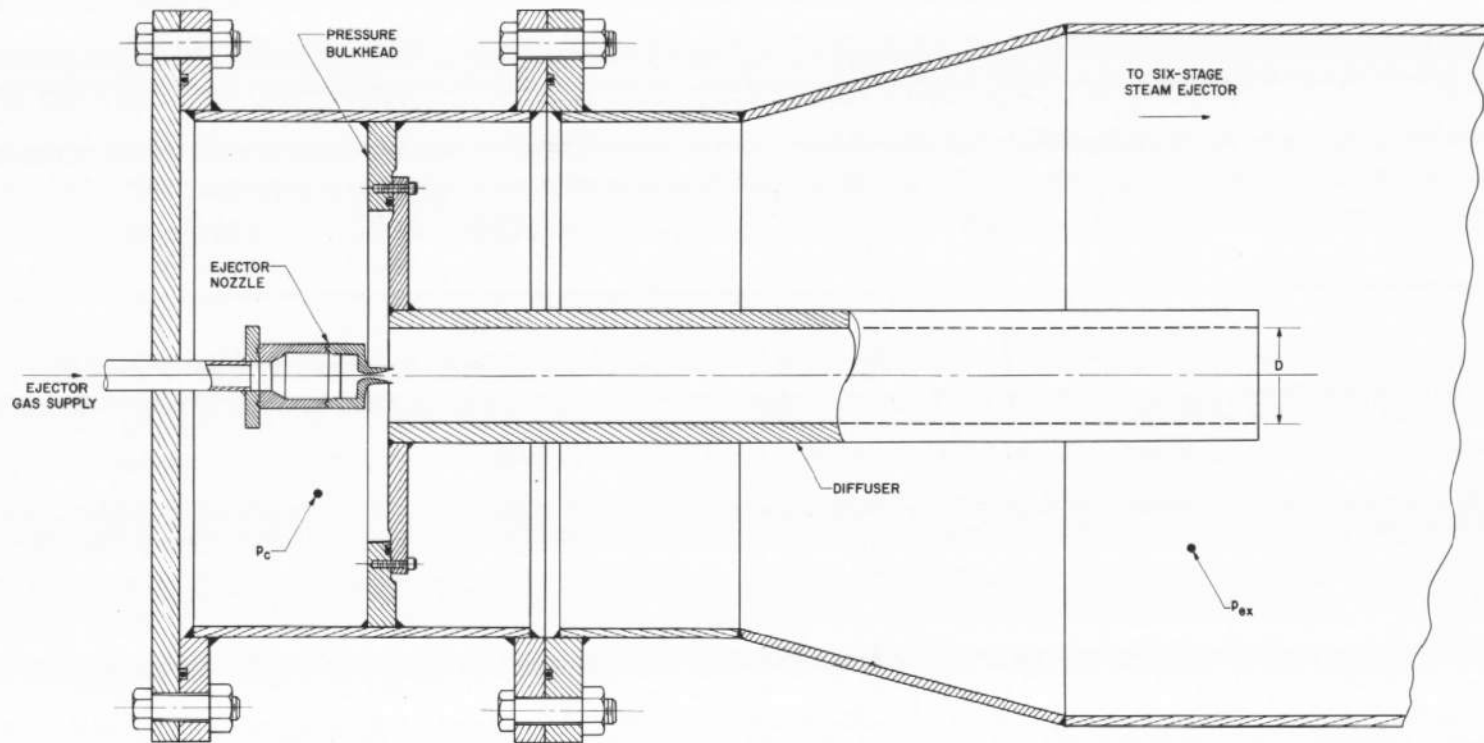
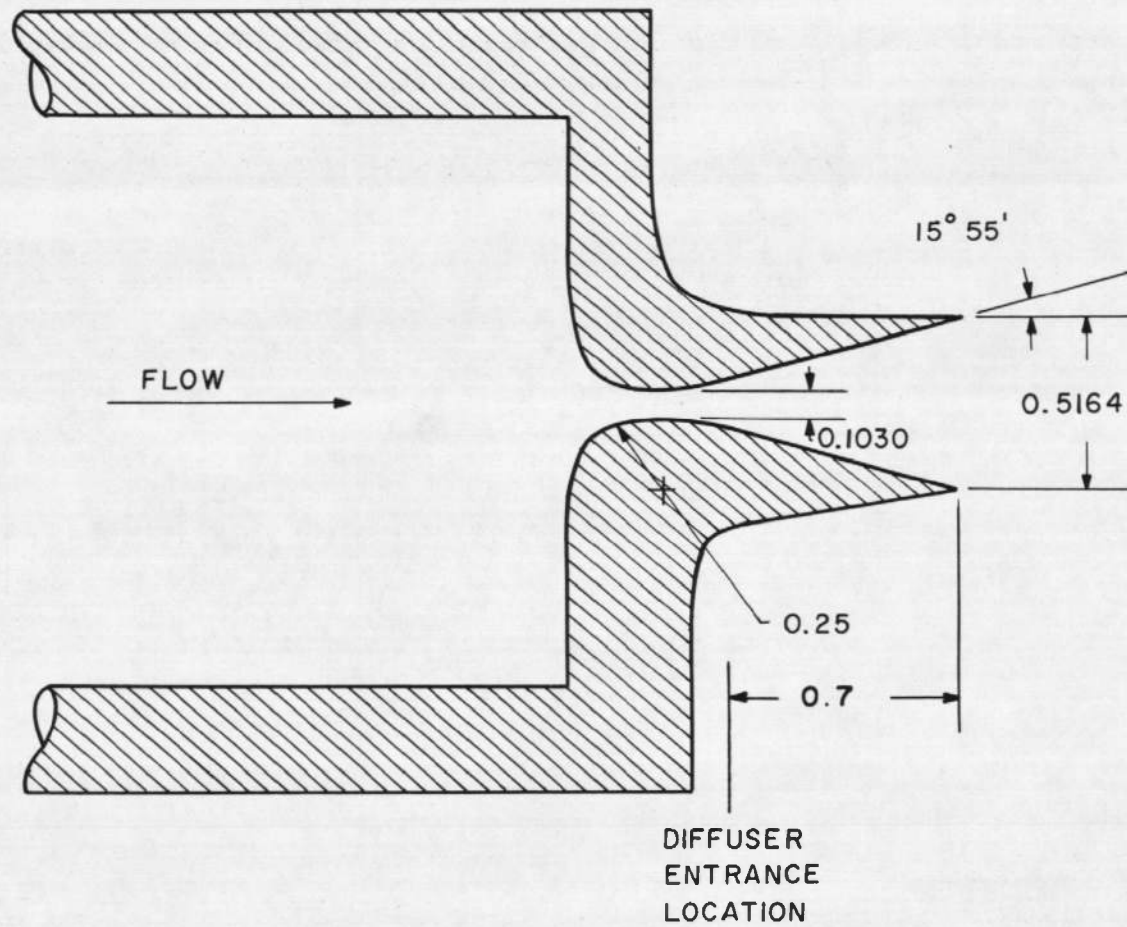

Fig. 2 Ejector Installation in the 18-in. Test Cell



ALL DIMENSIONS IN INCHES

Fig. 3 Ejector Nozzle Tested in the 18-in. Test Cell

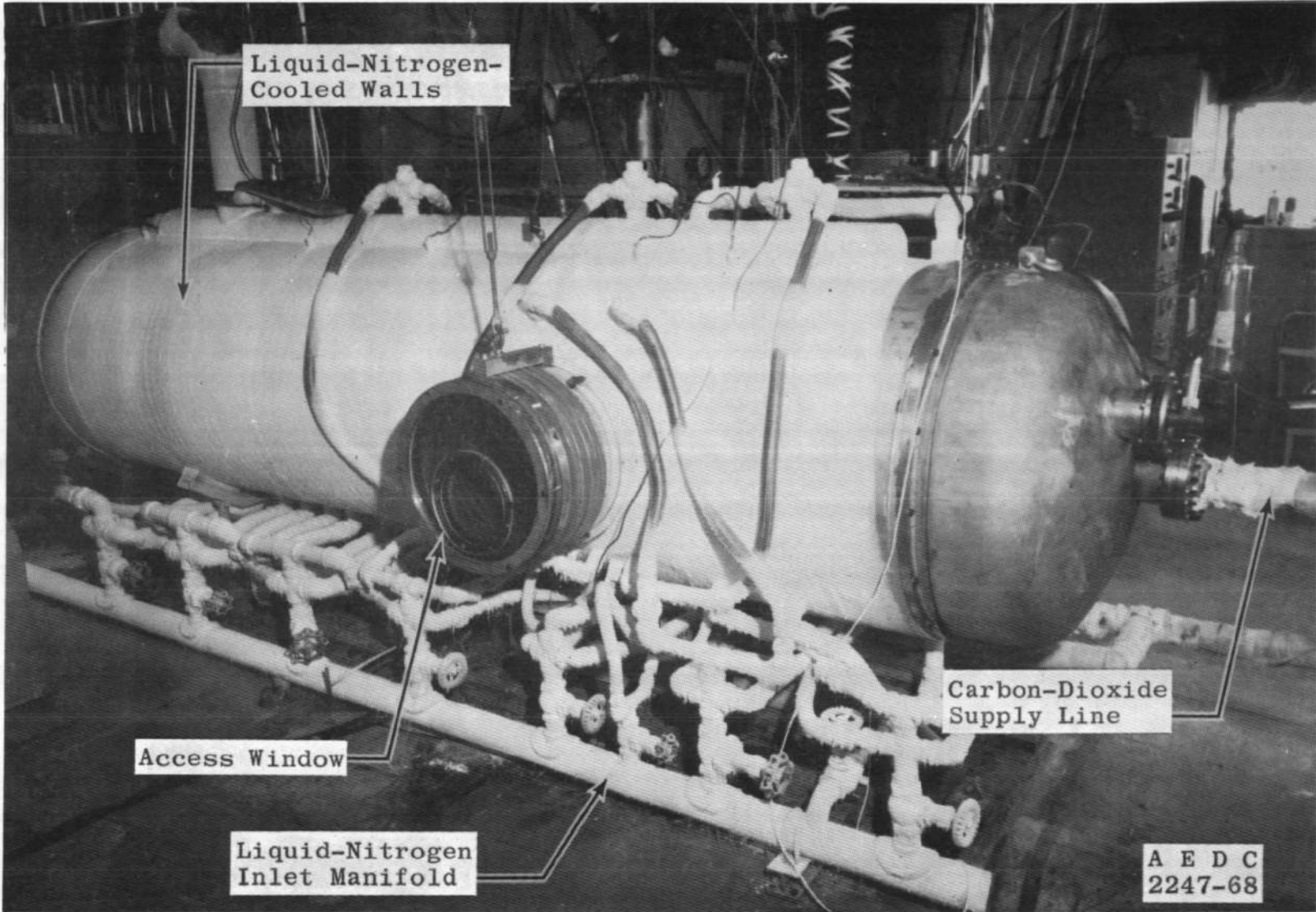
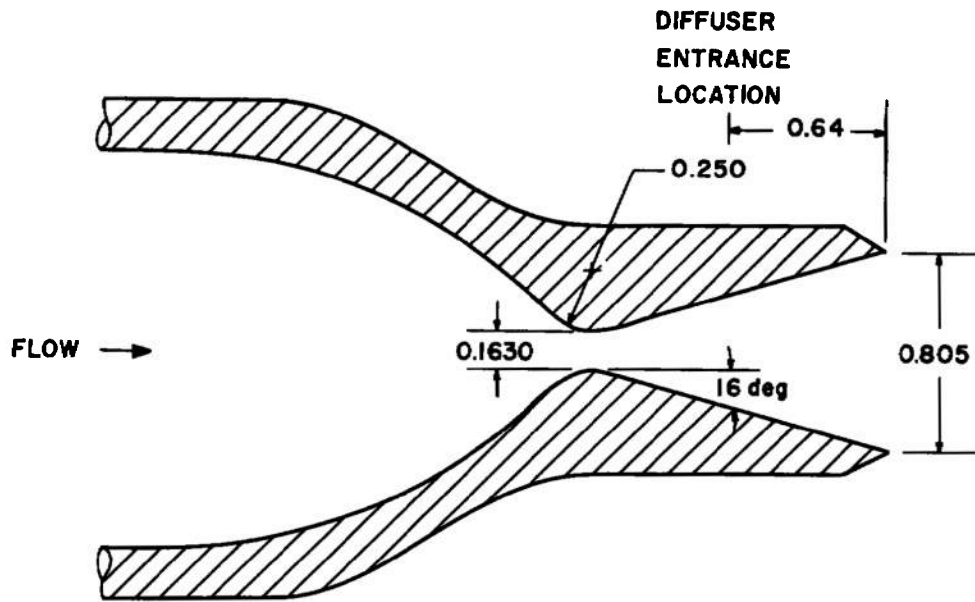
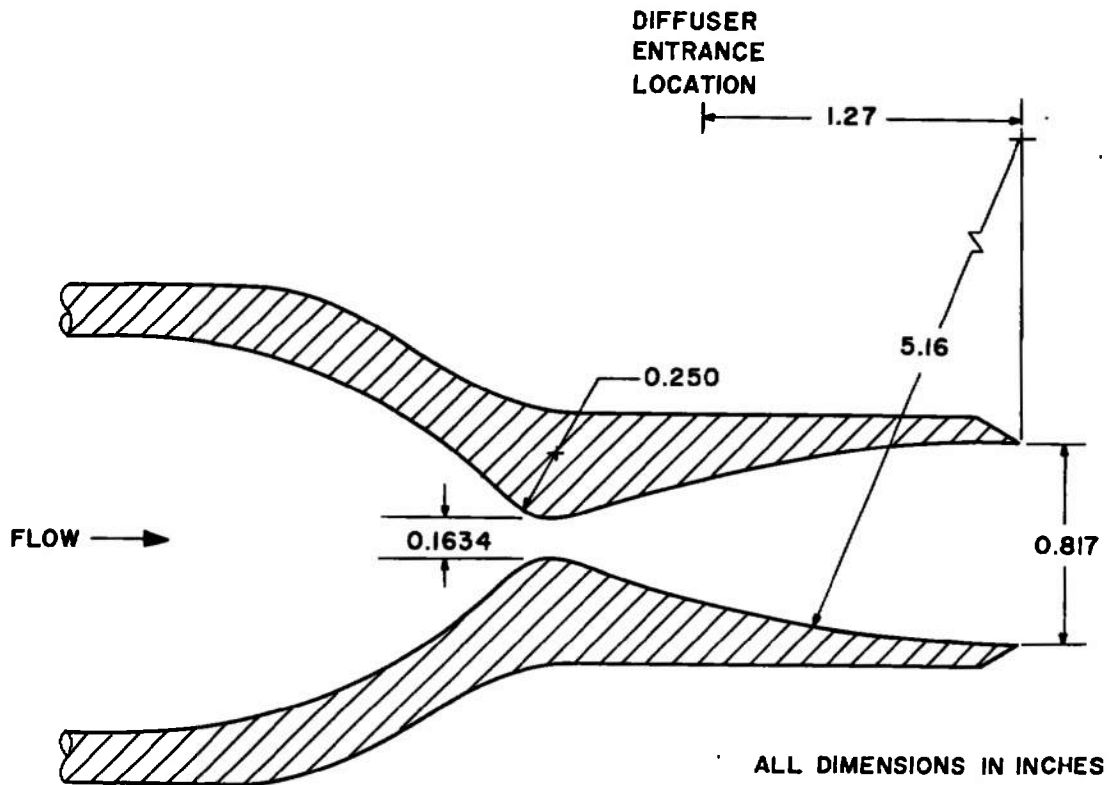

Fig. 4 Cold Wall Vacuum Chamber Installation



a. 16-deg Conical Nozzle



ALL DIMENSIONS IN INCHES

b. Contoured Nozzle

Fig. 5 Ejector Nozzles Tested in the Cold Wall Vacuum Chamber

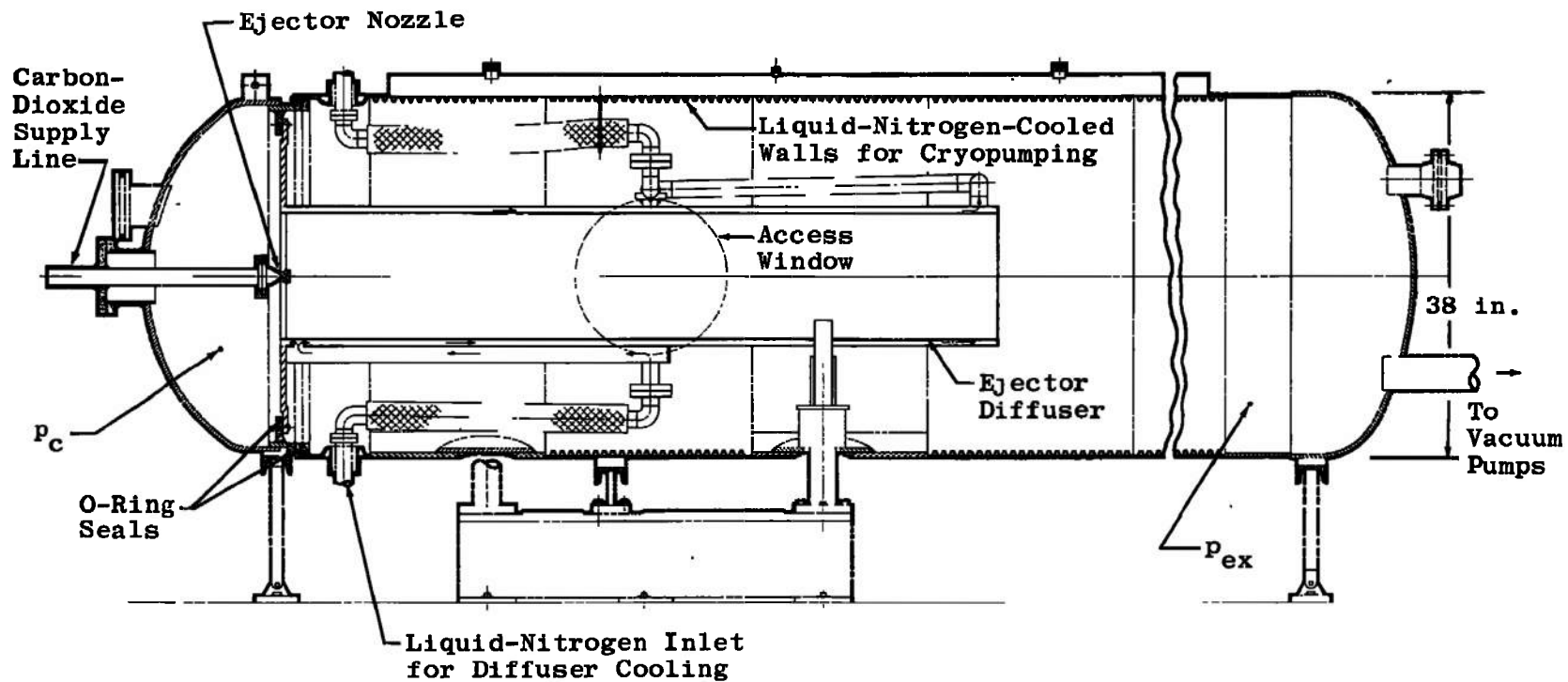
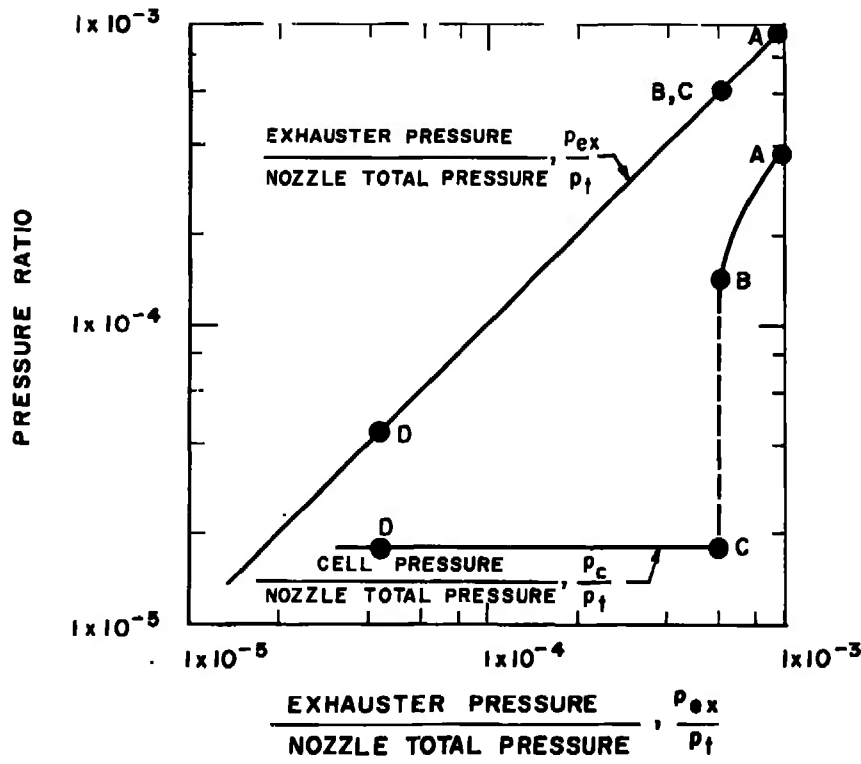
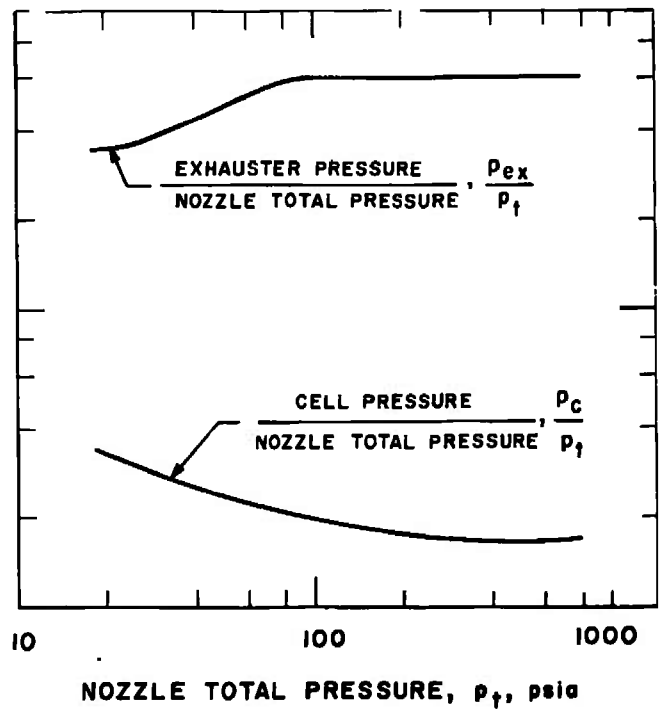

Fig. 6 Ejector Installation in the Cold Wall Vacuum Chamber



a. Idealized Operating Cycle



b. Real Ejector Operating Conditions Corresponding to Point C of Fig. 7a

Fig. 7 General Ejector Operational Characteristics

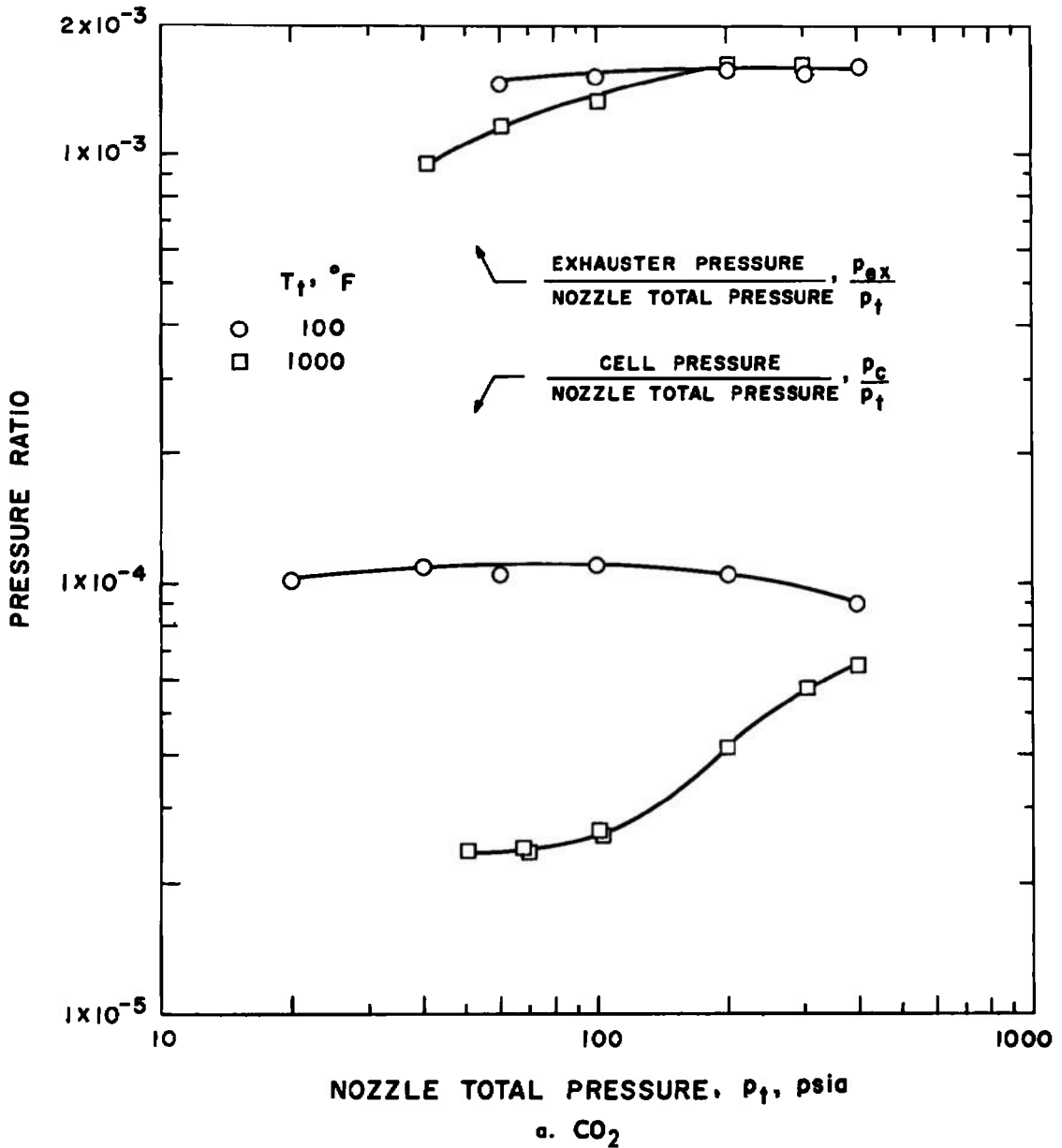
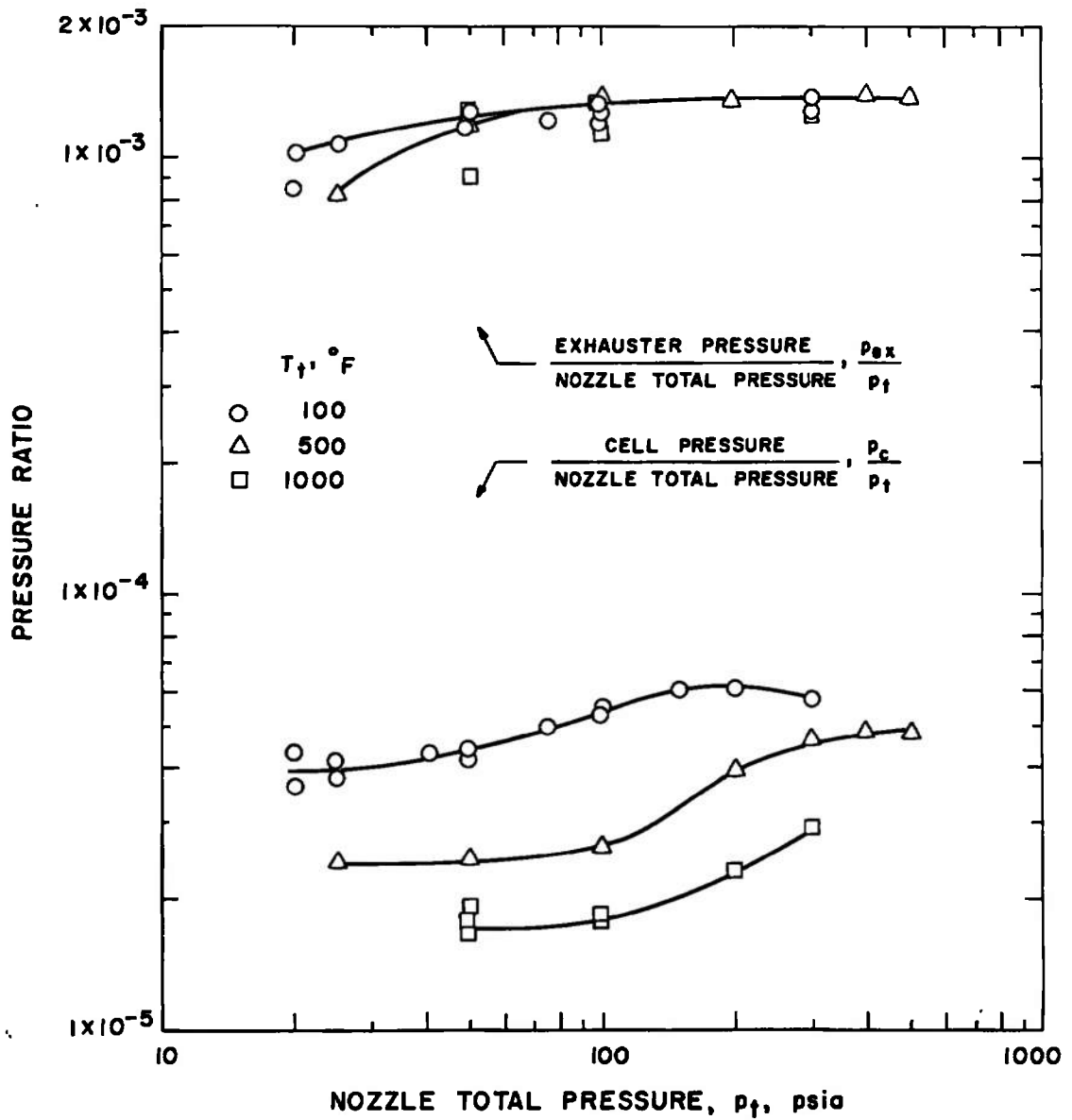
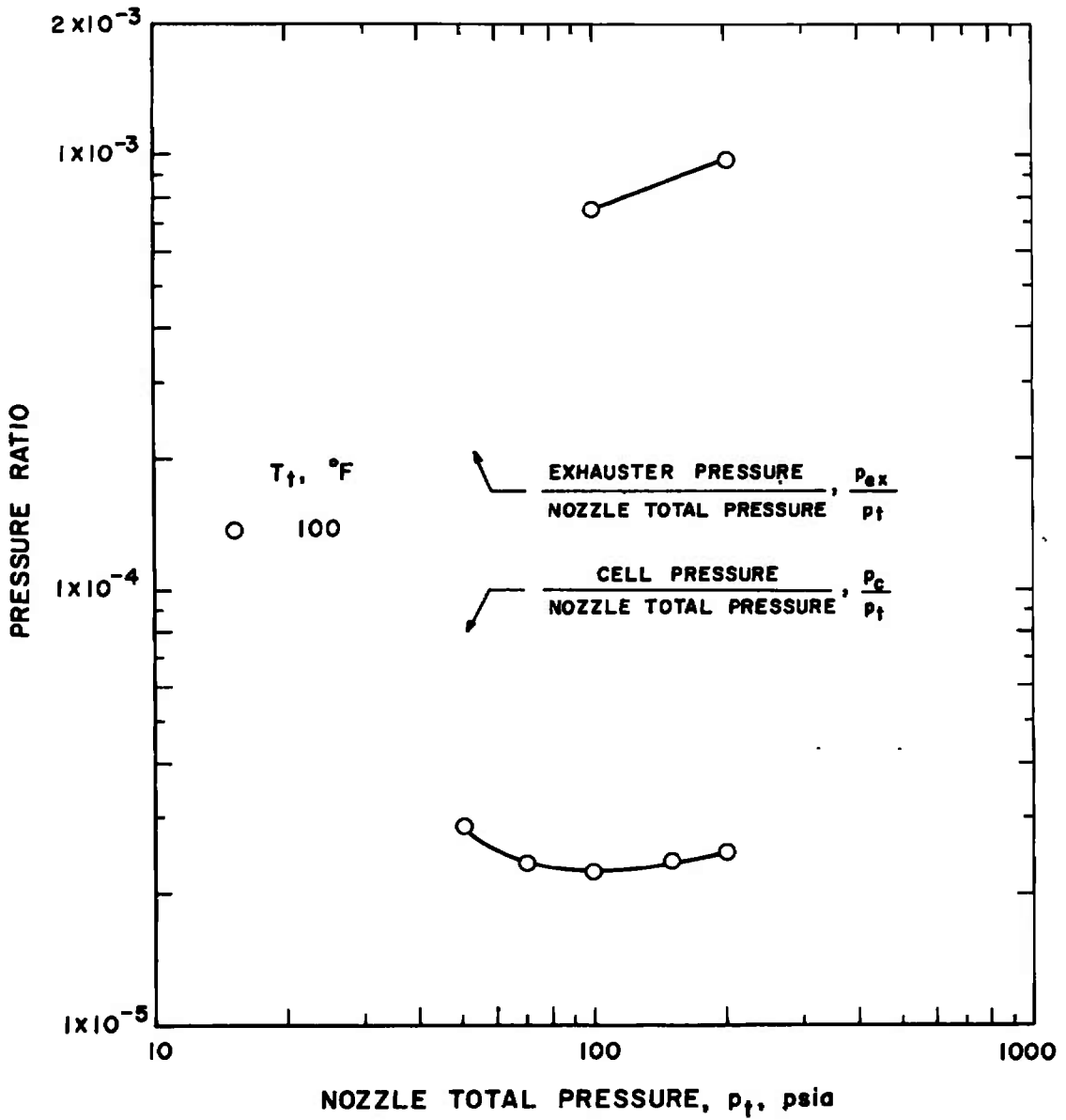

Fig. 8 Operational Characteristics of Ejector Systems in the 18-in. Test Cell with $A_D/A^* = 950$, $L/D = 10$



b. N₂

Fig. 8 Continued



c. He

Fig. 8 Concluded

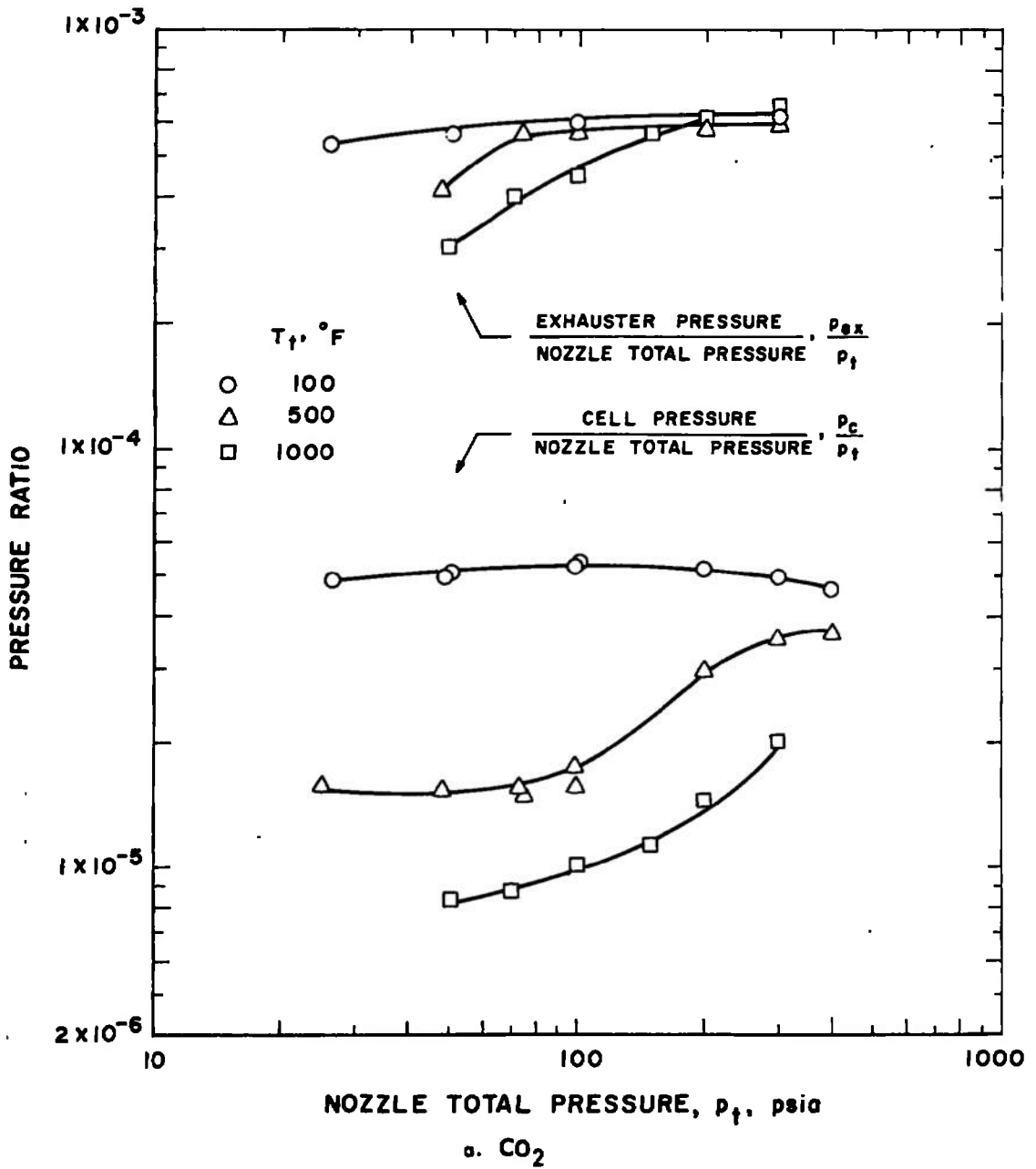
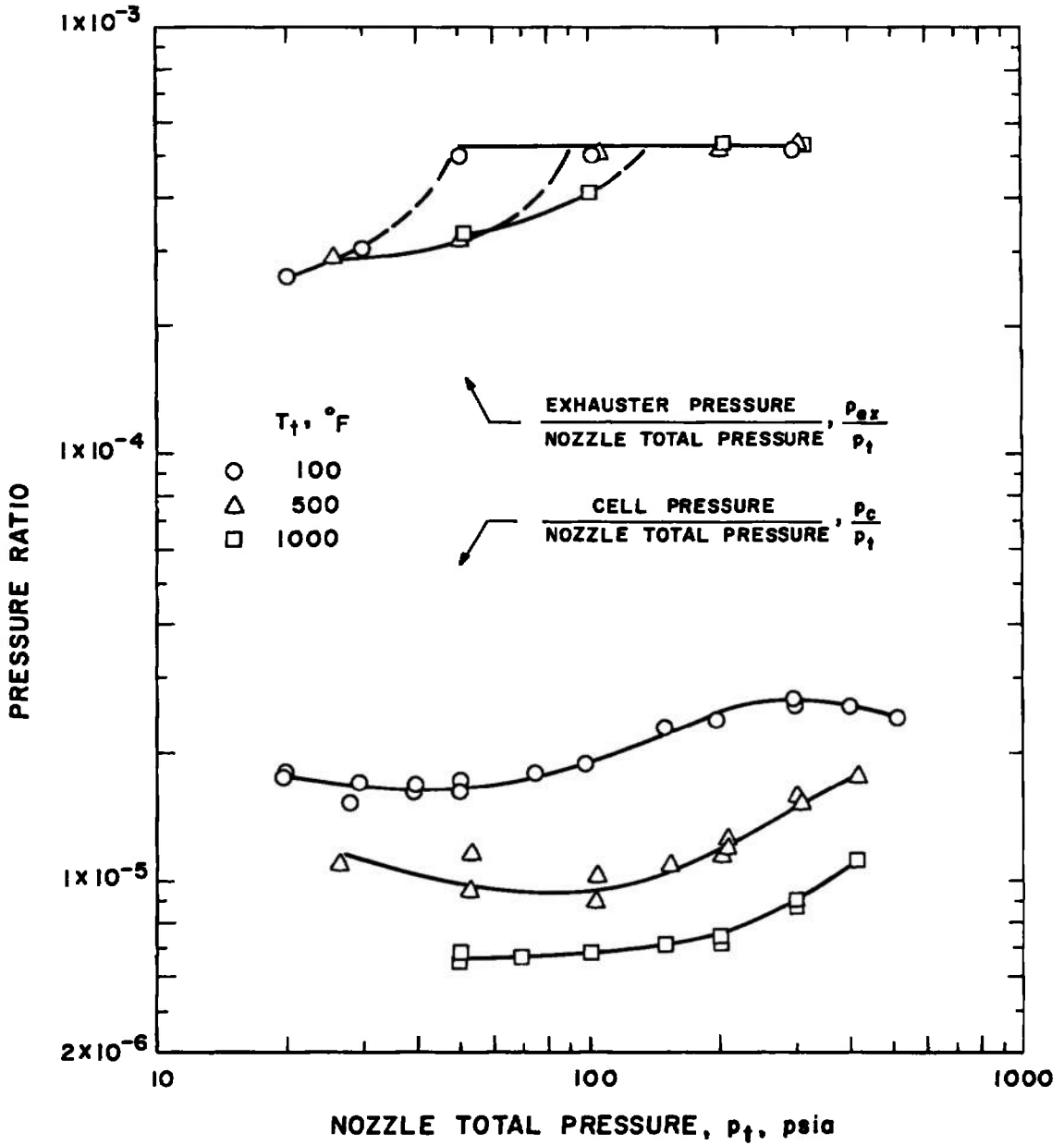
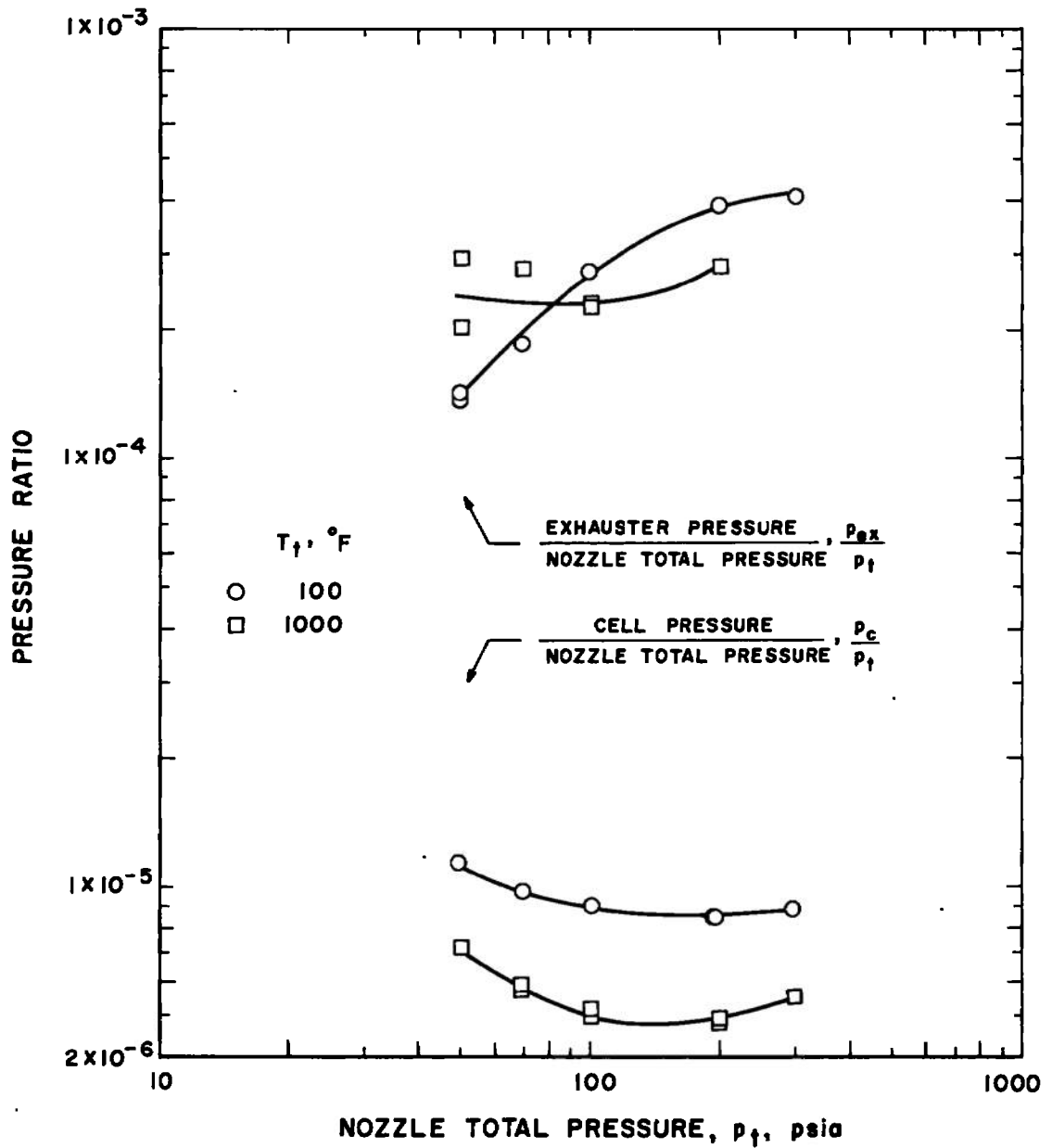

Fig. 9 Operational Characteristics of Ejector Systems in the 18-in. Test Cell with $A_D/A^* = 2410$, $L/D = 10$



b. N_2
 Fig. 9 Continued



c. He

Fig. 9 Concluded

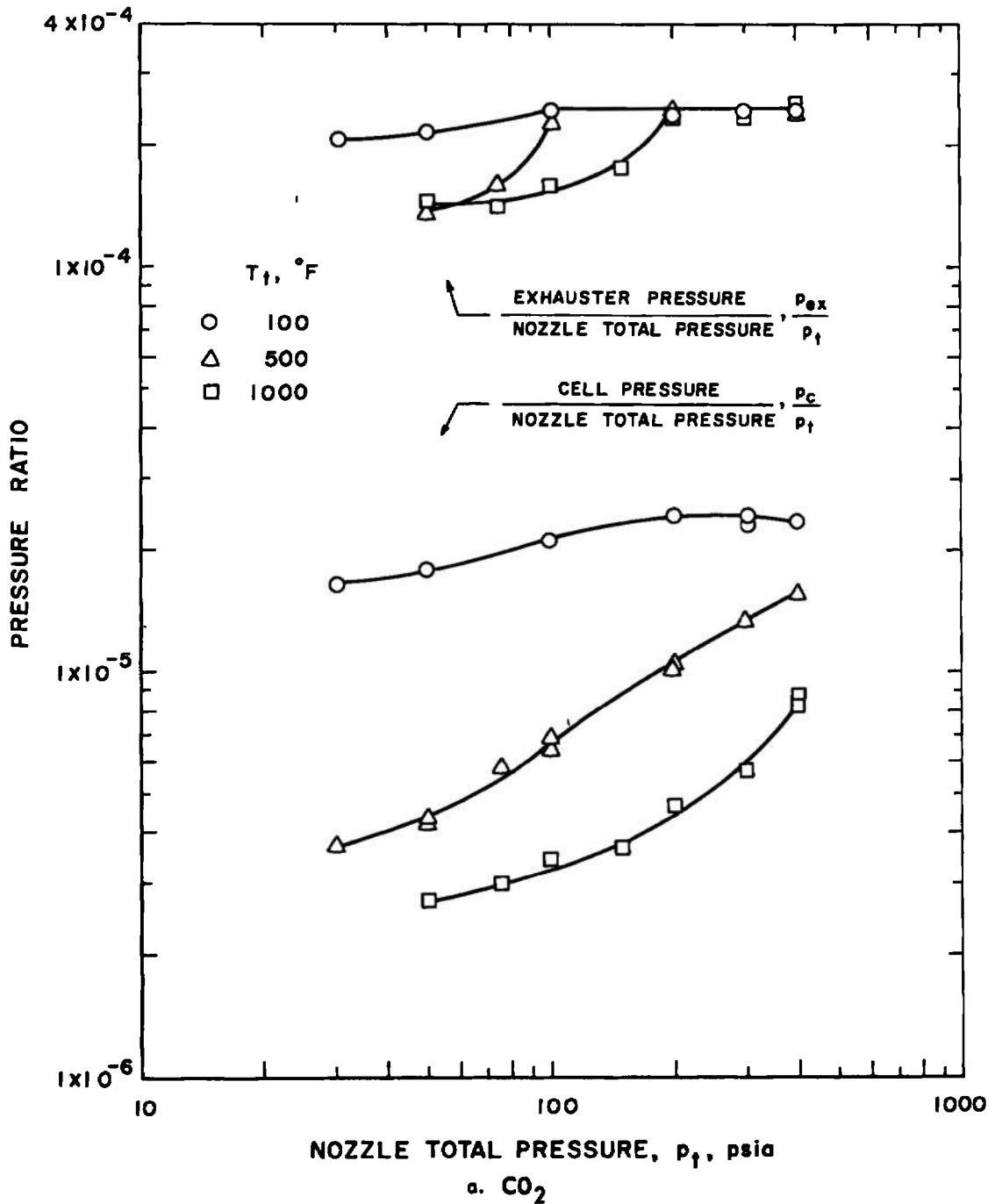
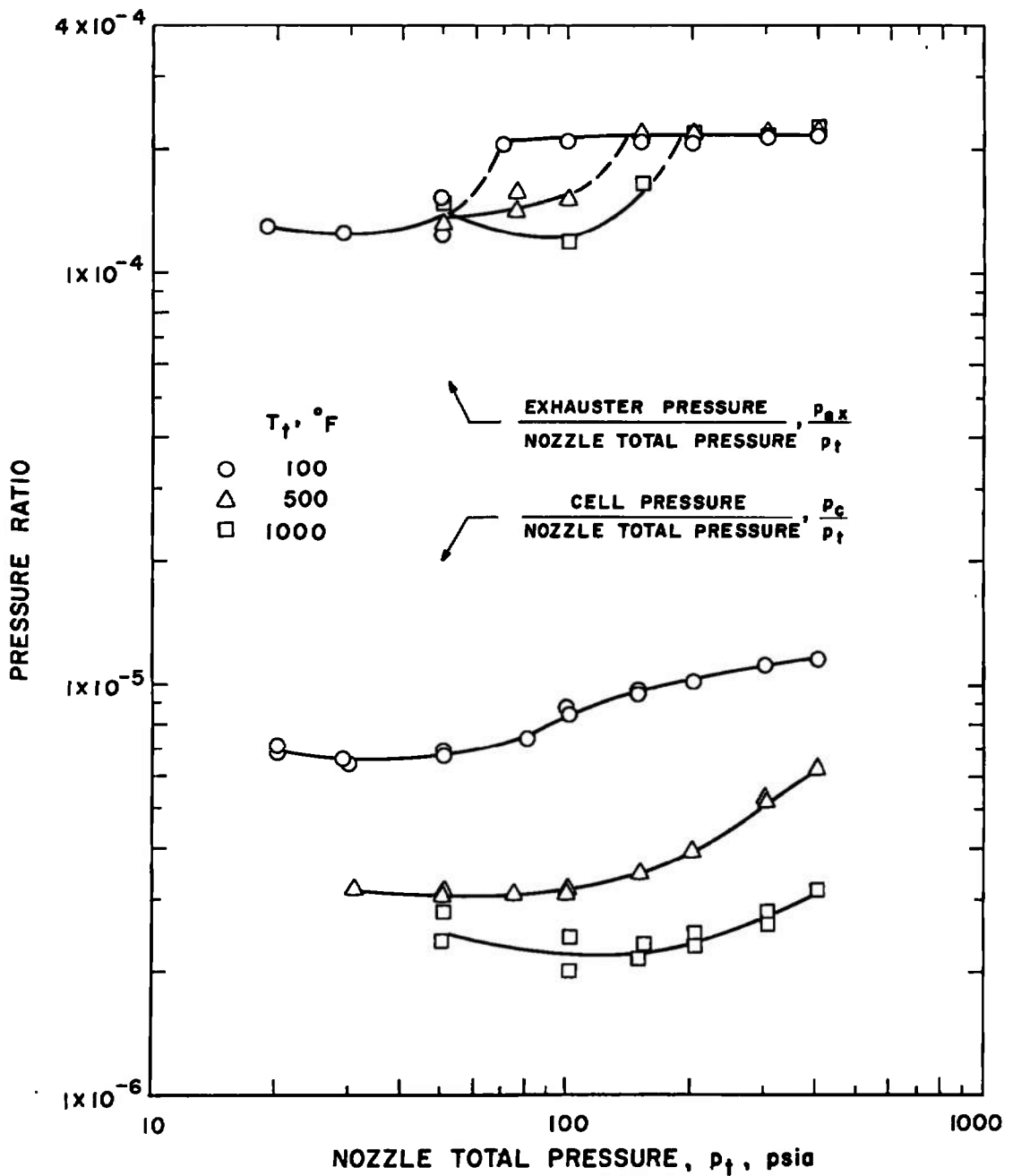
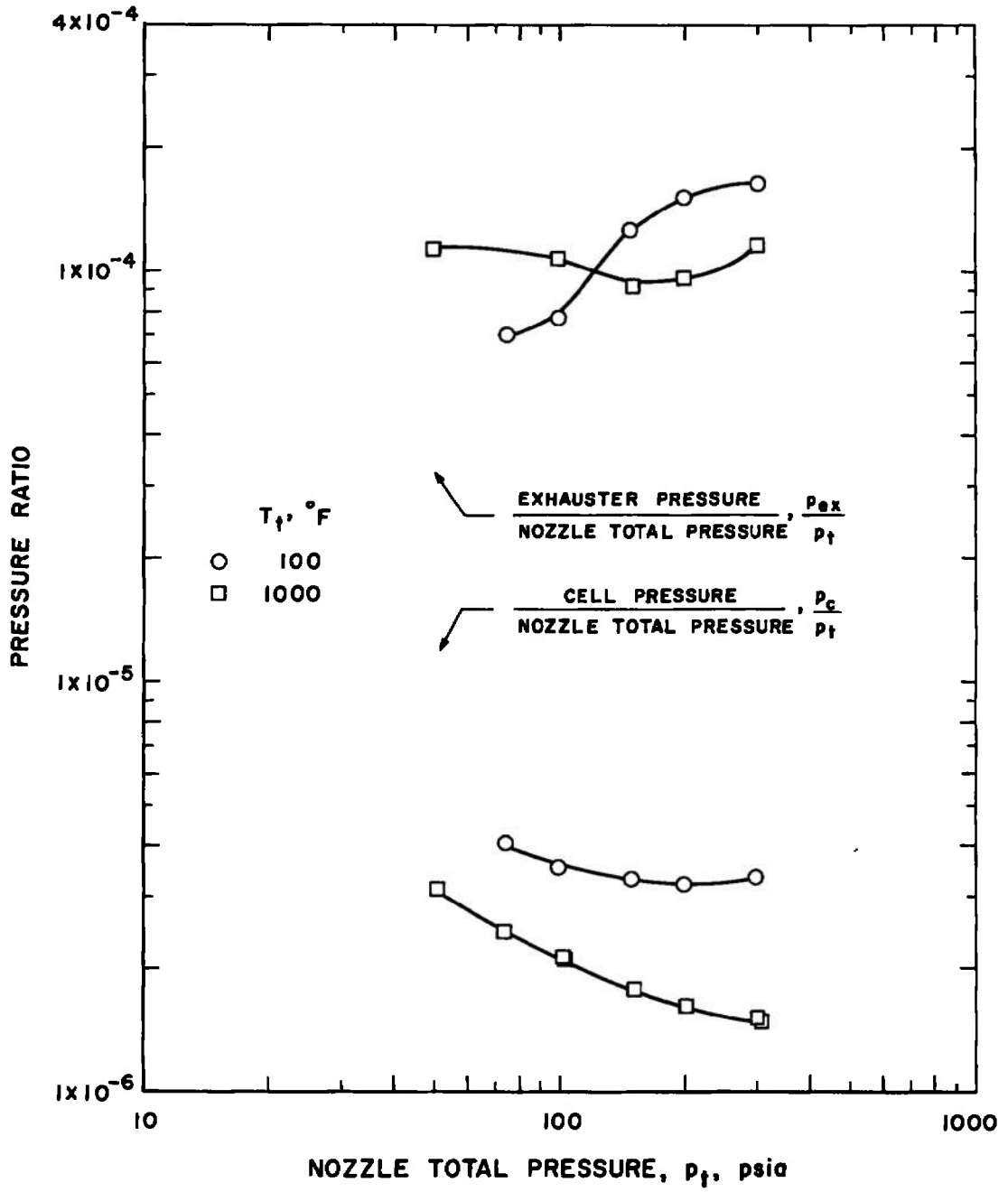

Fig. 10 Operational Characteristics of Ejector Systems in the 18-in. Test Cell with $A_D/A^* = 6045$, $L/D = 10$



b. N₂

Fig. 10 Continued



c. He

Fig. 10 Concluded

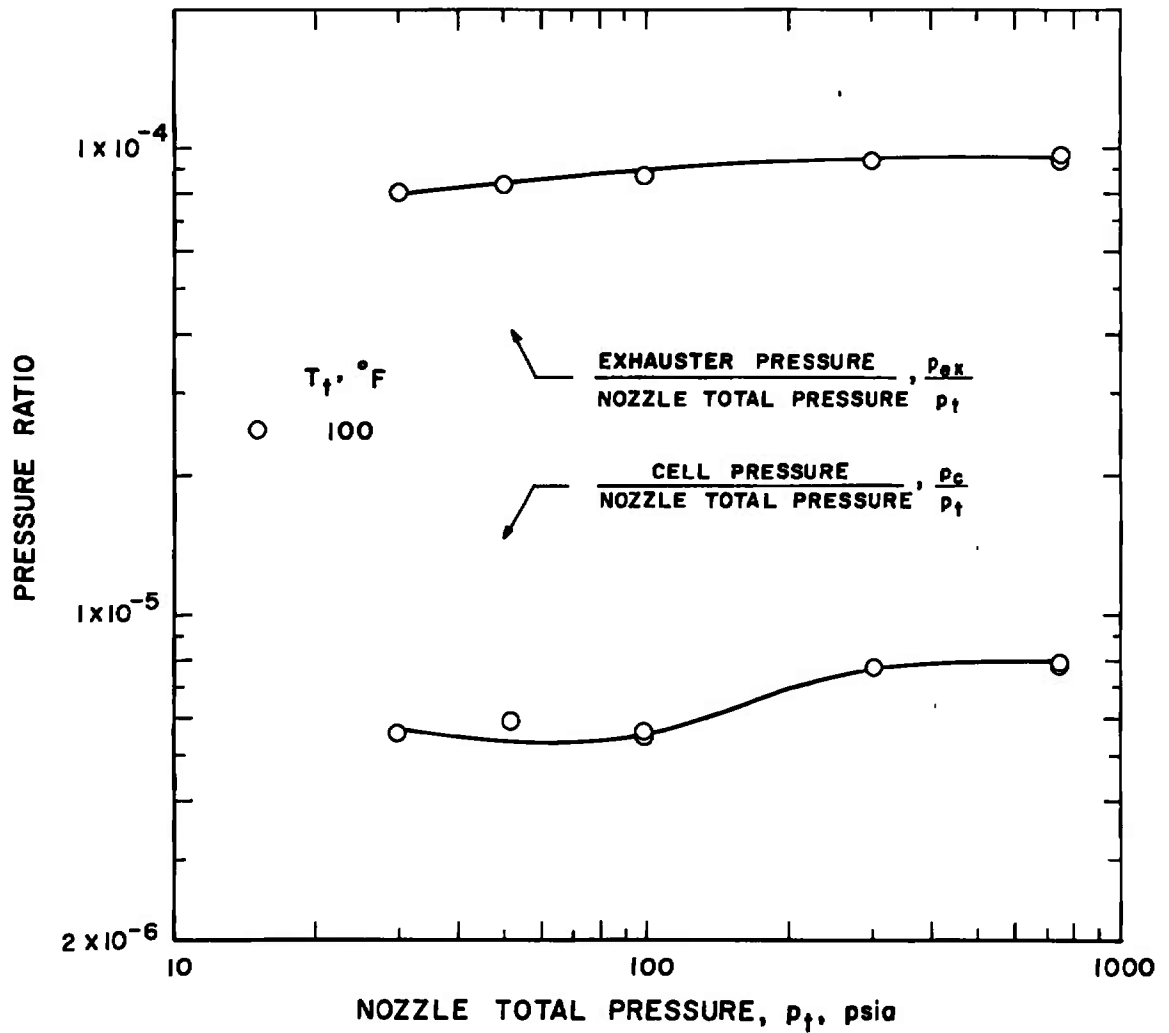

Fig. 11 Operational Characteristics of Ejector Systems in the CWVC Using CO_2 and the 18-in. Cell Nozzle for $A_D/A^* = 15,300$, $L/D = 6$

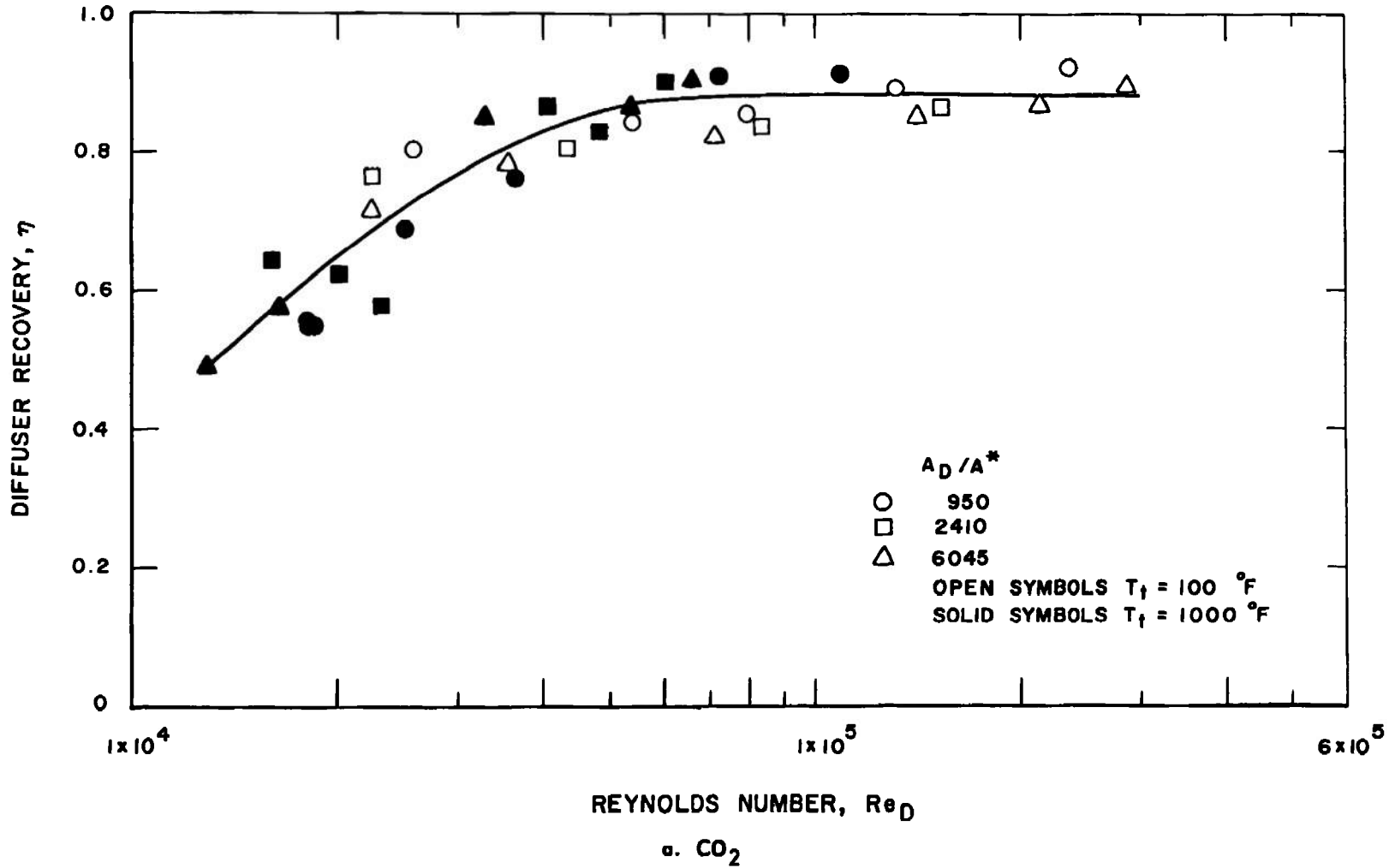

Fig. 12 Effect of Reynolds Number on the Diffuser Recovery for an L/D of 10

b. N_2

Fig. 12 Continued



c. He
 Fig. 12 Concluded

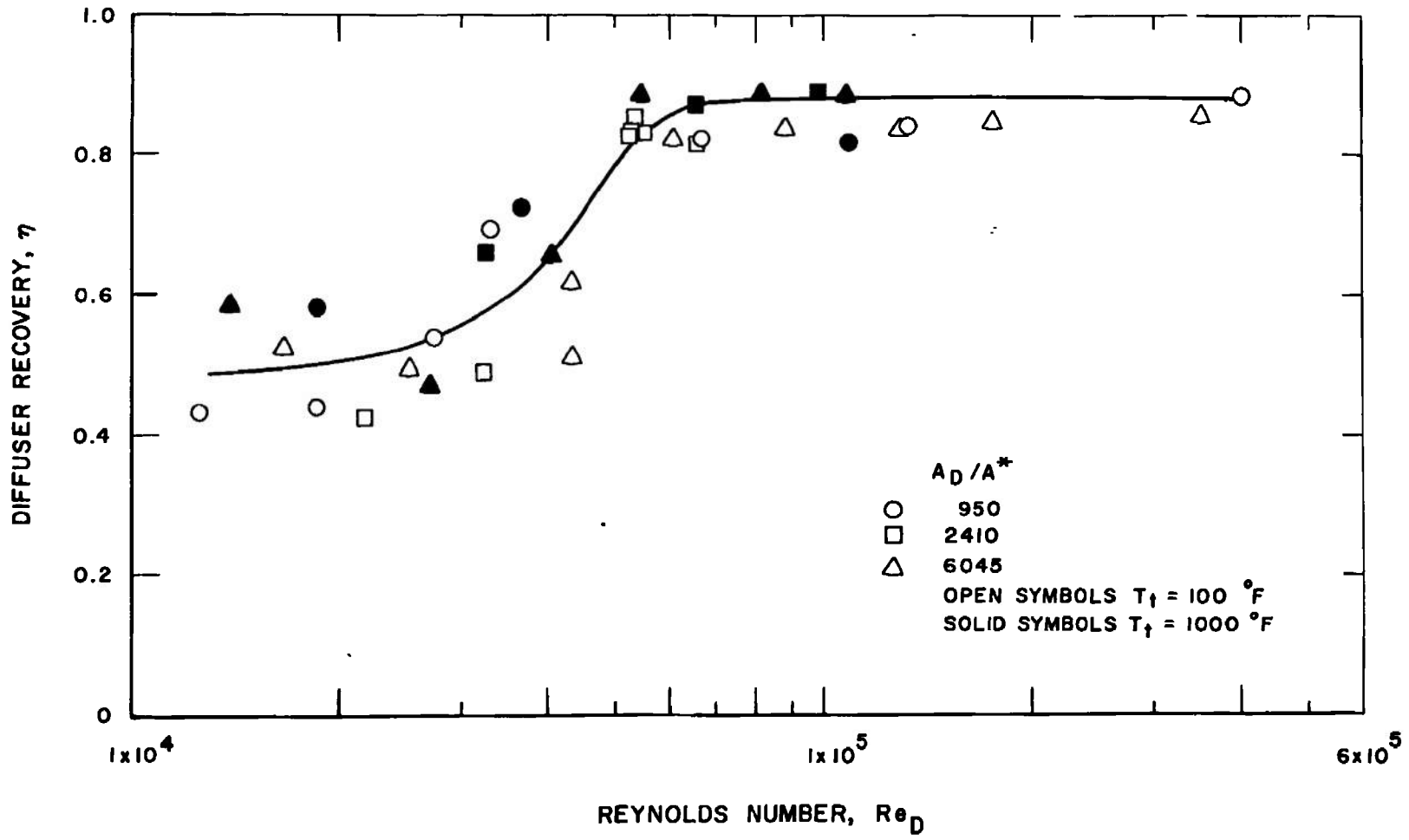
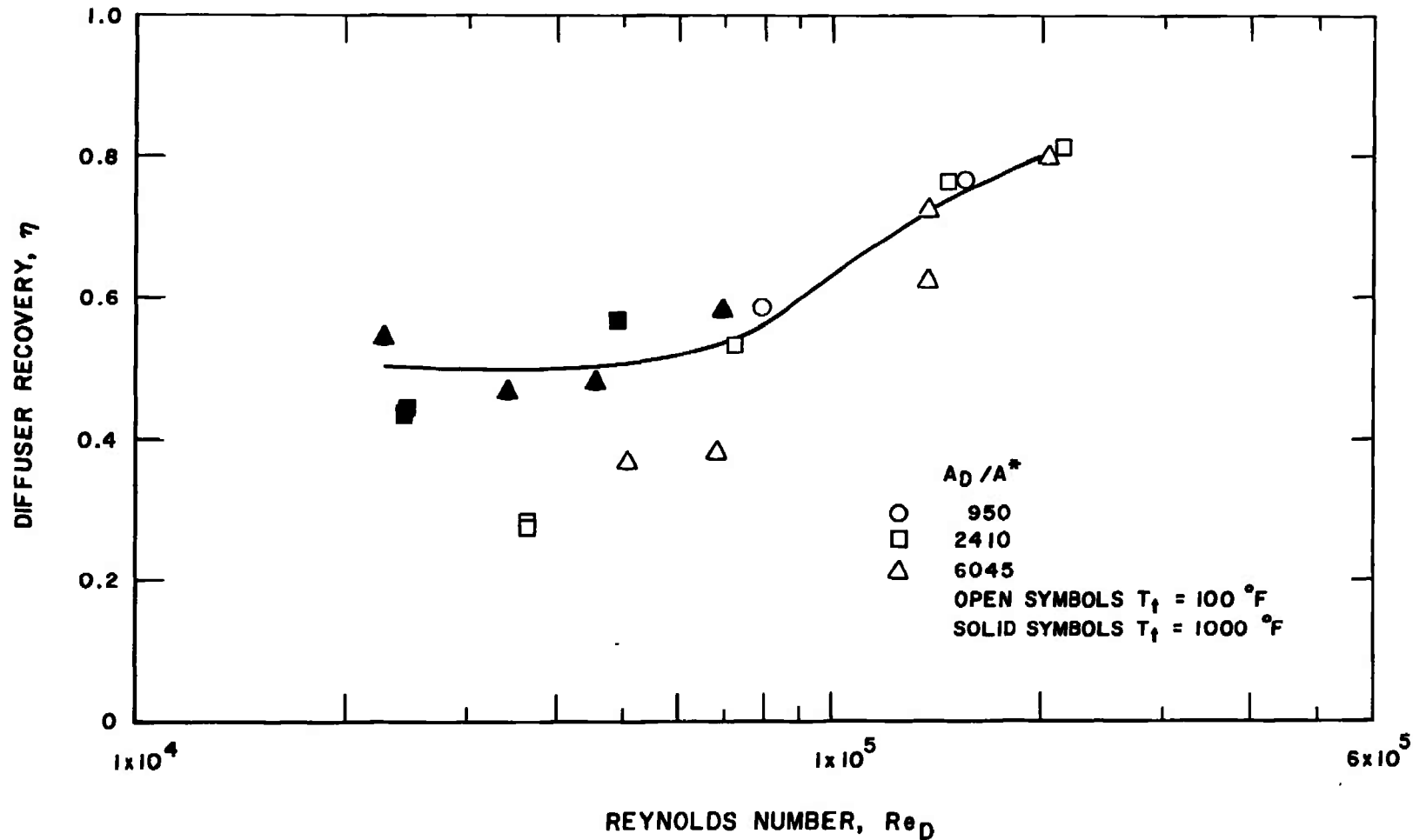
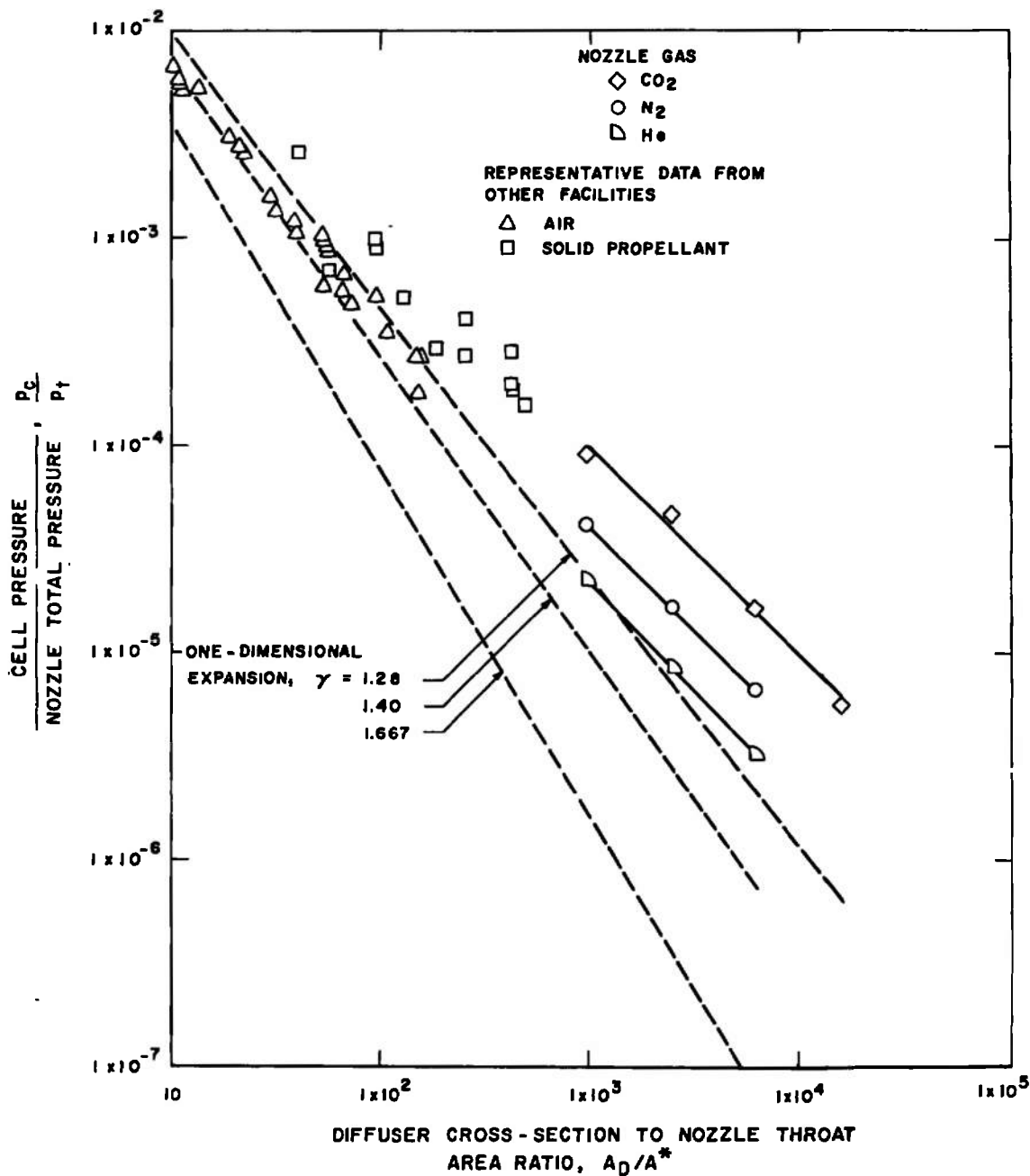

a. Minimum Test Cell Pressure for $T_t = 100^\circ\text{F}$

Fig. 13 Effect of Ejector Area-Ratio on the Optimum System Performance

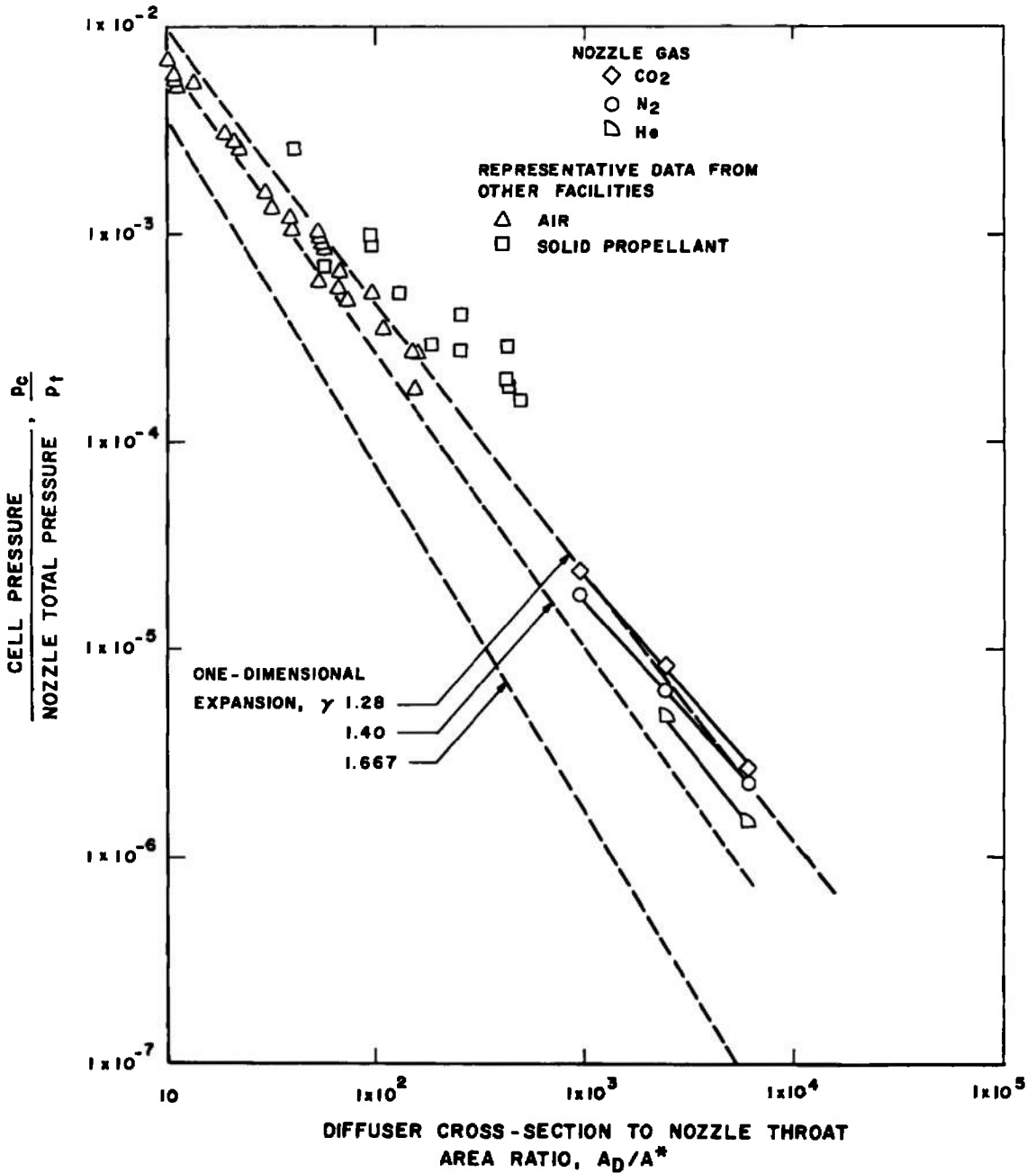

b. Minimum Test Cell Pressure for $T_t = 1000^\circ\text{F}$

Fig. 13 Continued

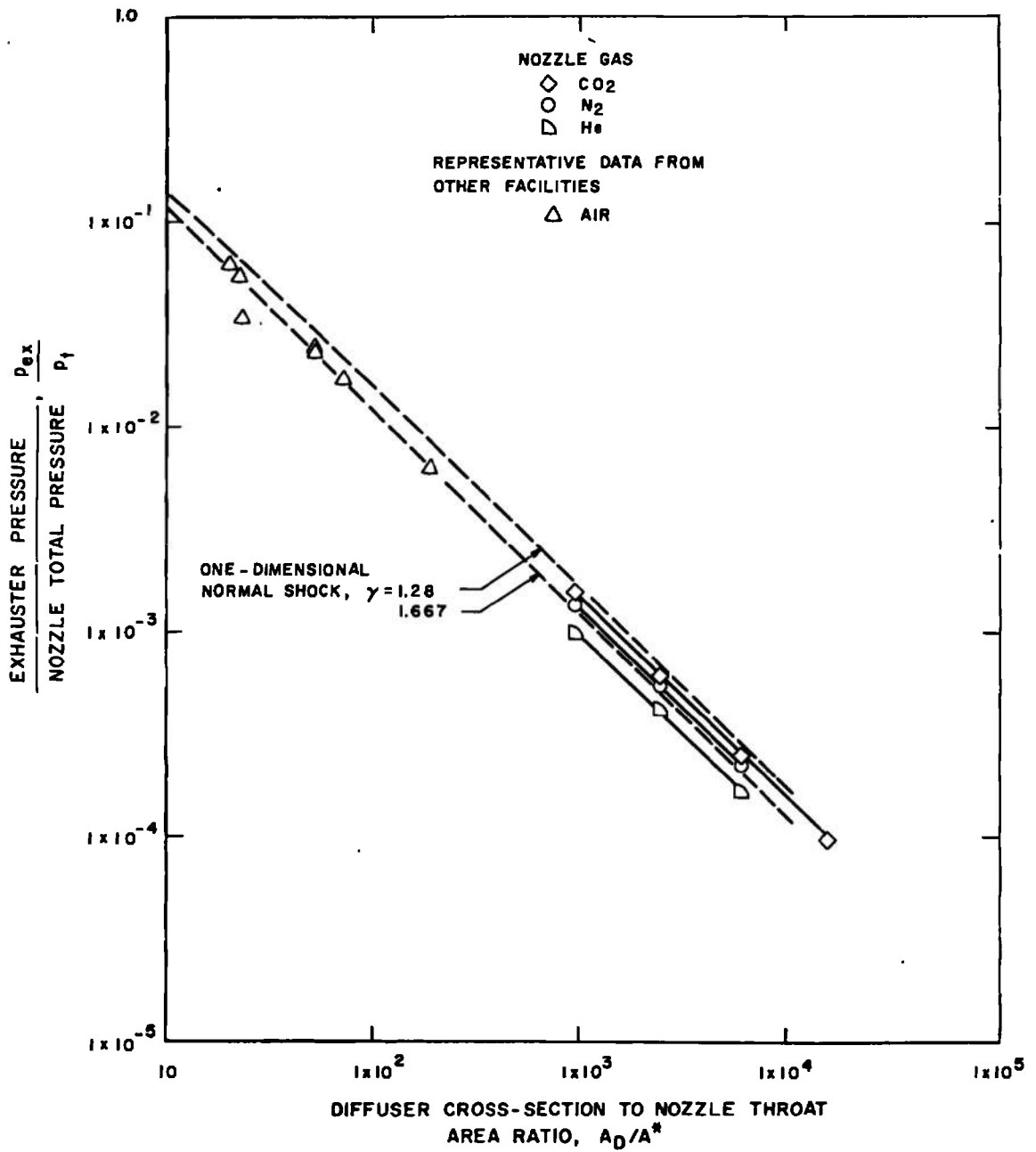

c. Maximum Exhauster Pressure

Fig. 13 Concluded

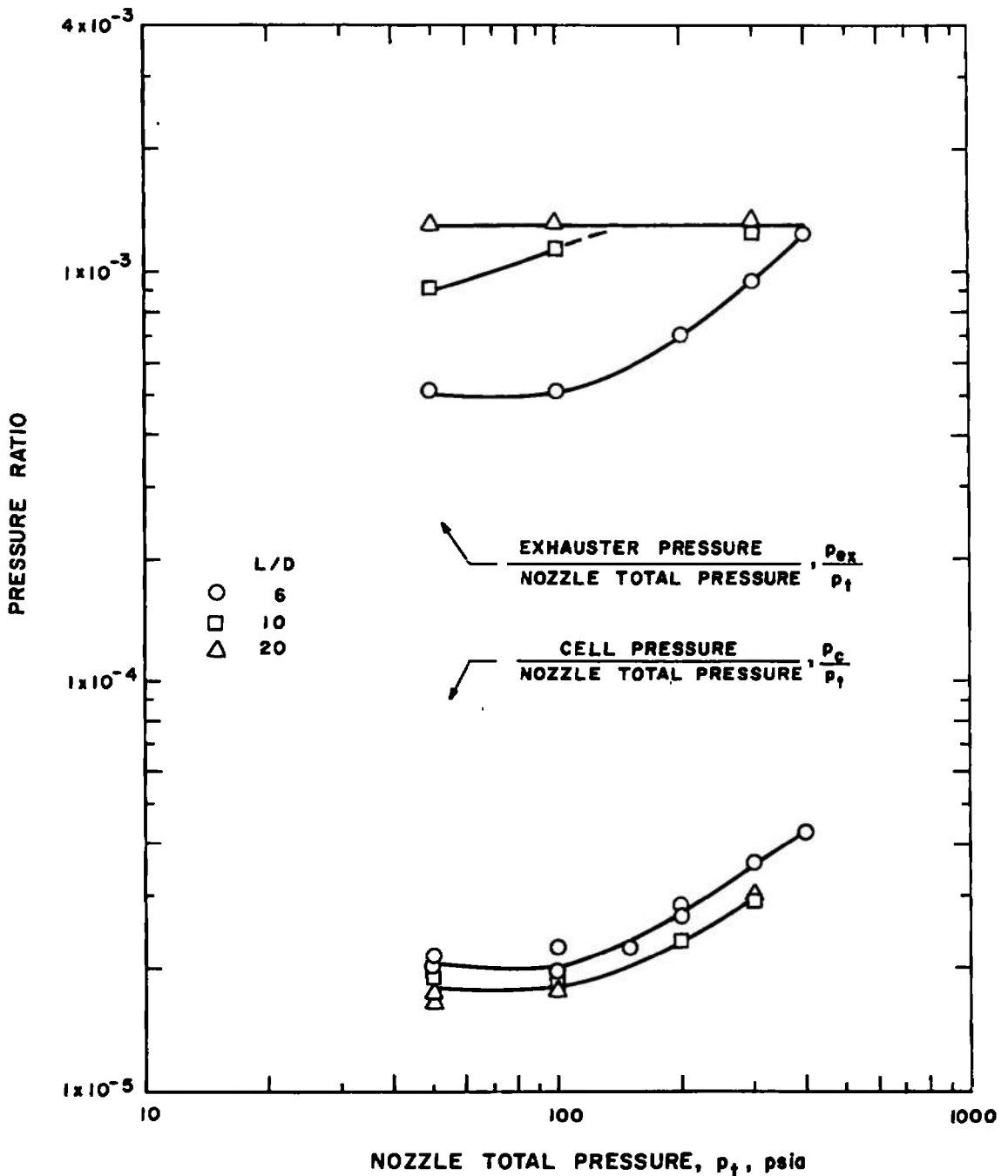

a. $T_t = 1000^\circ\text{F}$, $A_D/A^* = 950$

Fig. 14 Effect of Diffuser Length on the Operational Characteristics of the 18-in. Test Cell System Using Nitrogen

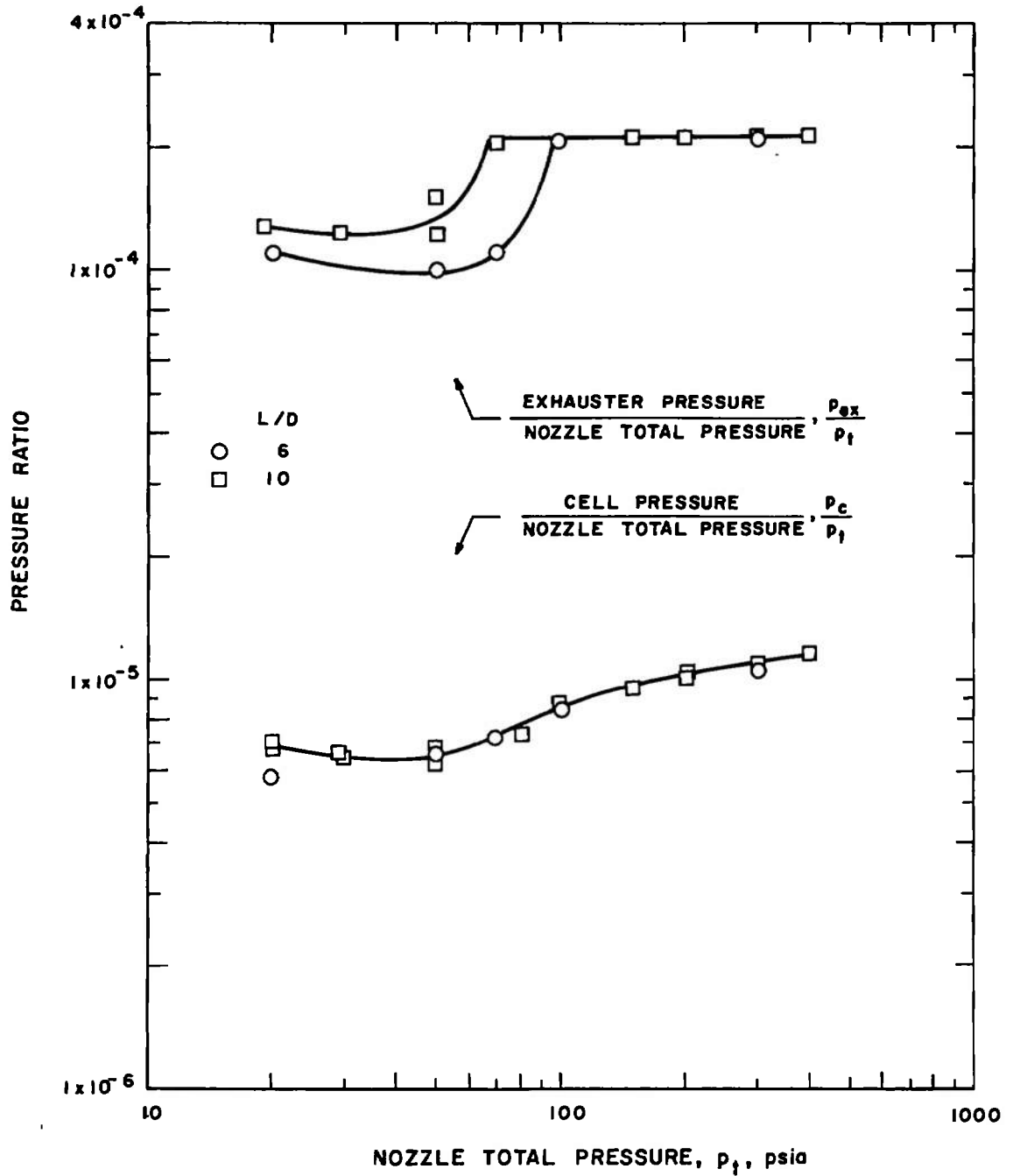

b. $T_t = 100^\circ\text{F}$, $A_D/A^* = 6045$

Fig. 14 Continued

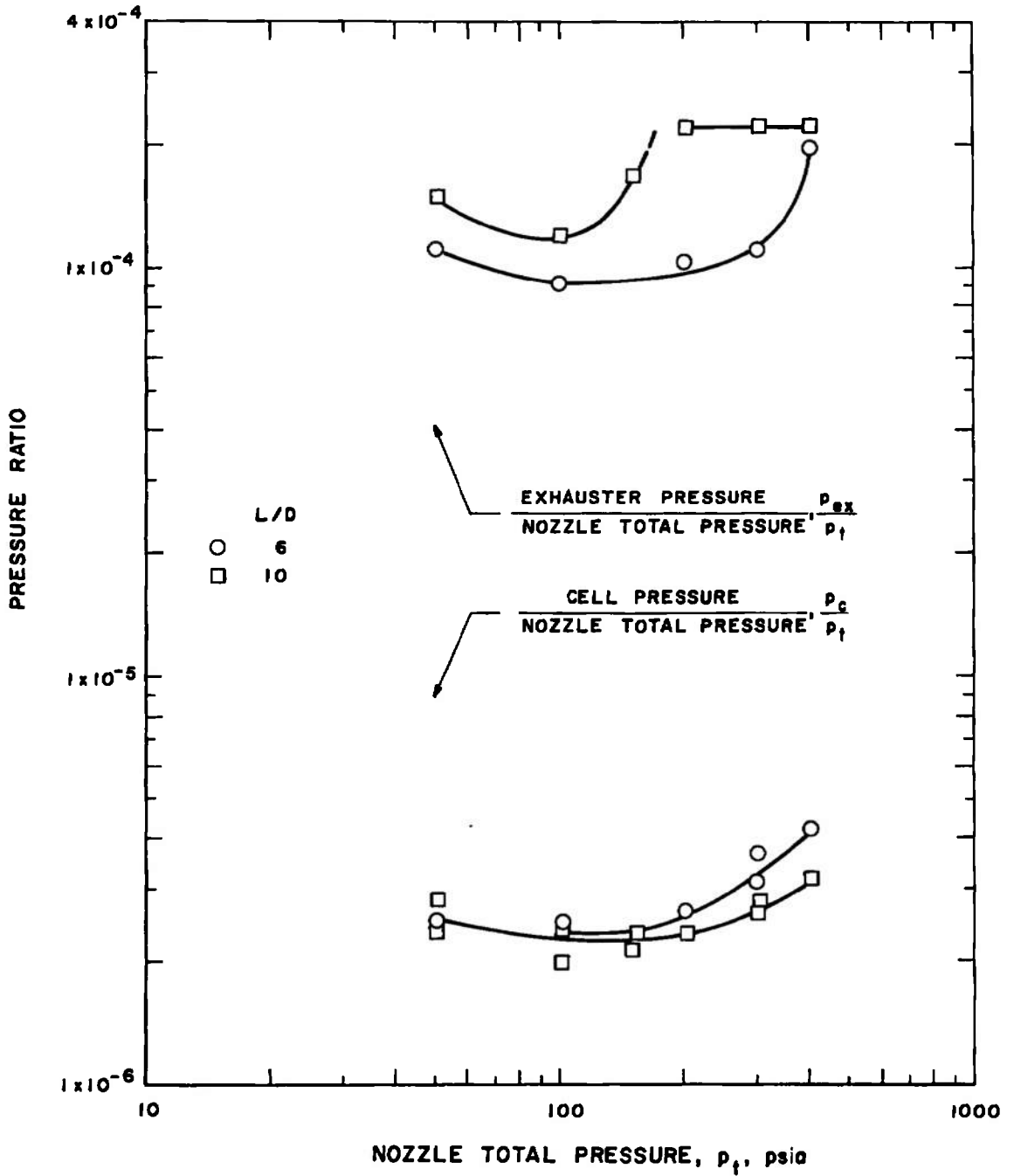

c. $T_t = 1000^\circ\text{F}$, $A_D/A^* = 6045$

Fig. 14 Concluded

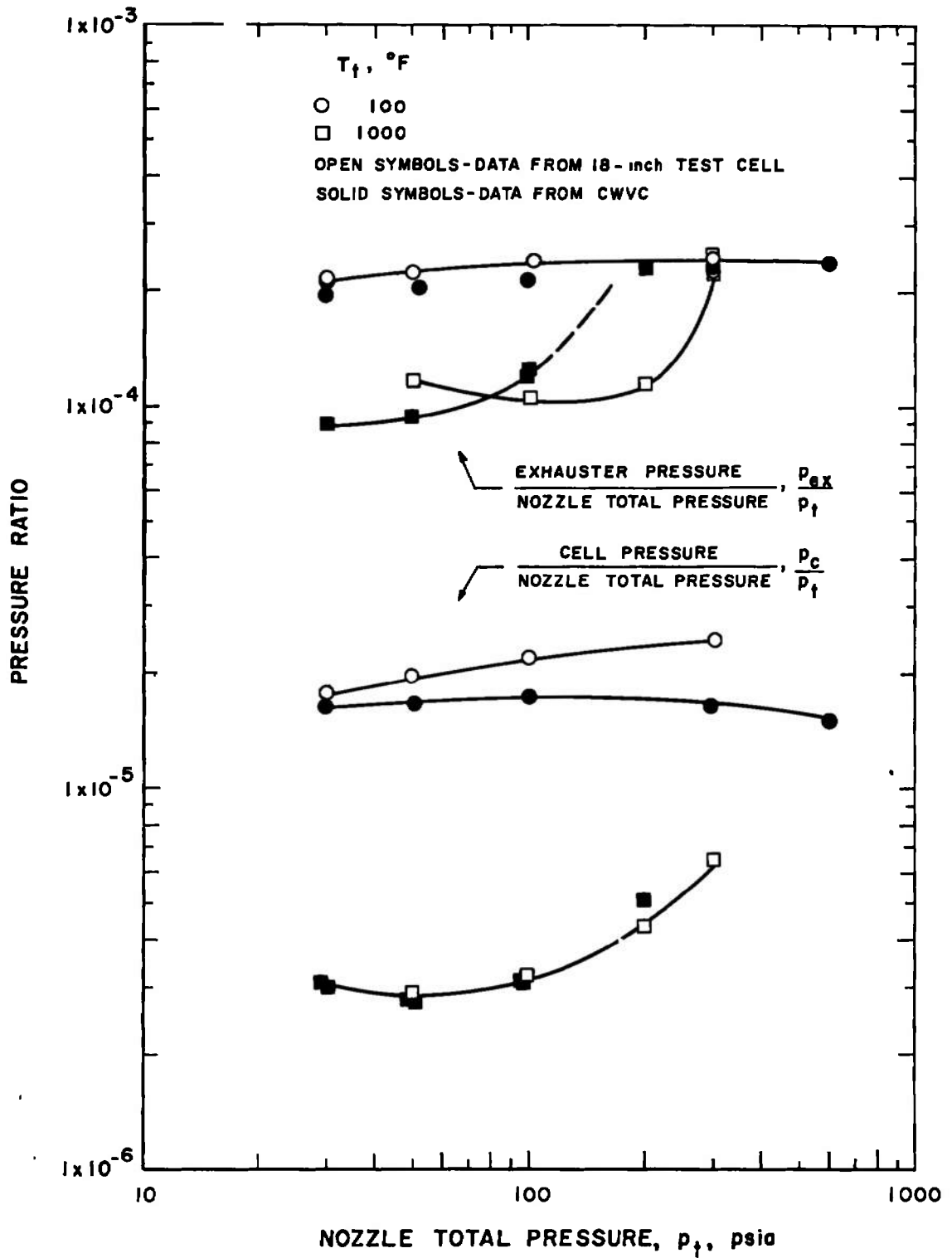

Fig. 15 Effect of System Scale on the Operating Characteristics of the Ejector System Using CO₂ with $A_D/A^* = 6045$ and $L/D = 6$

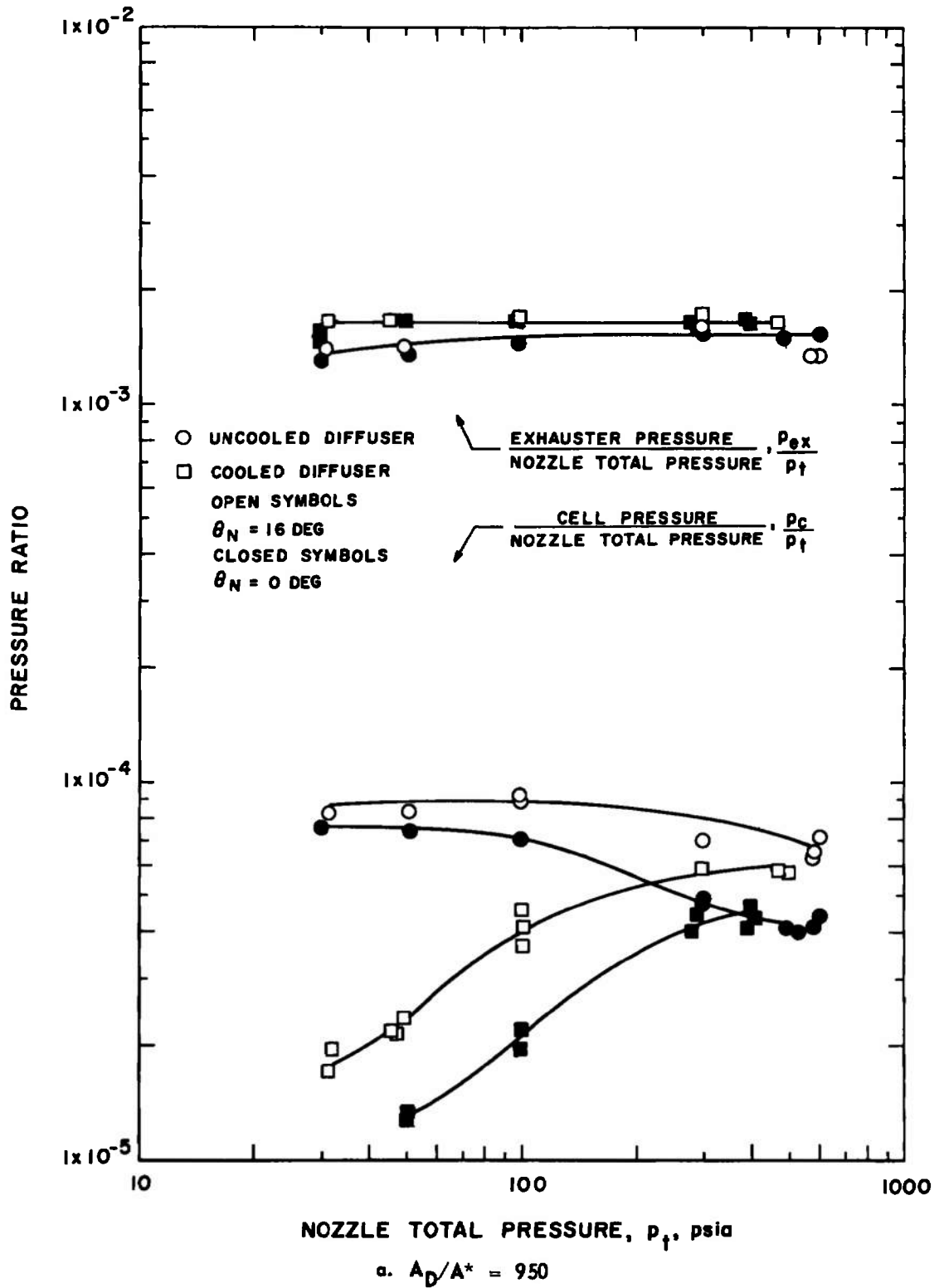
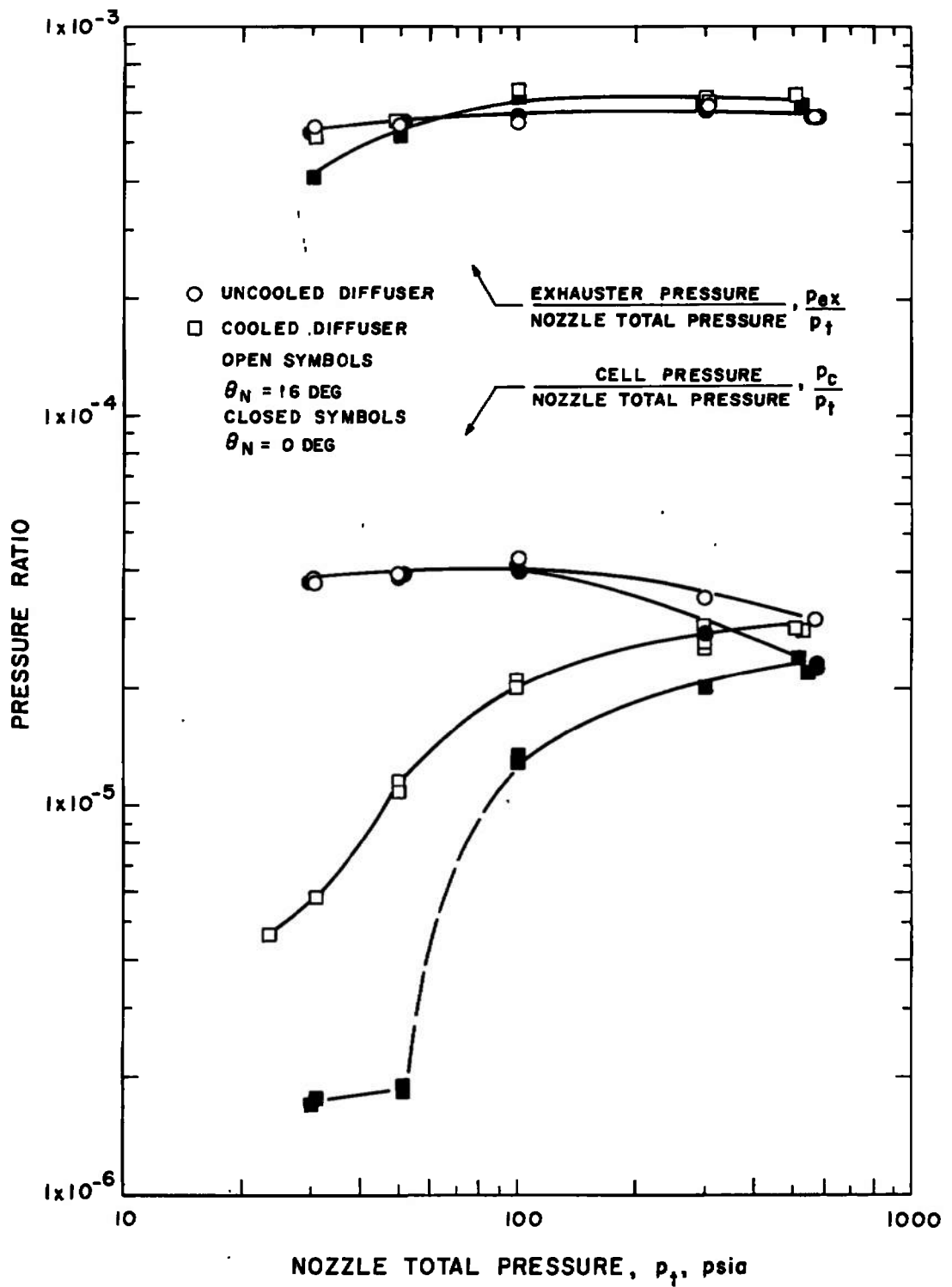
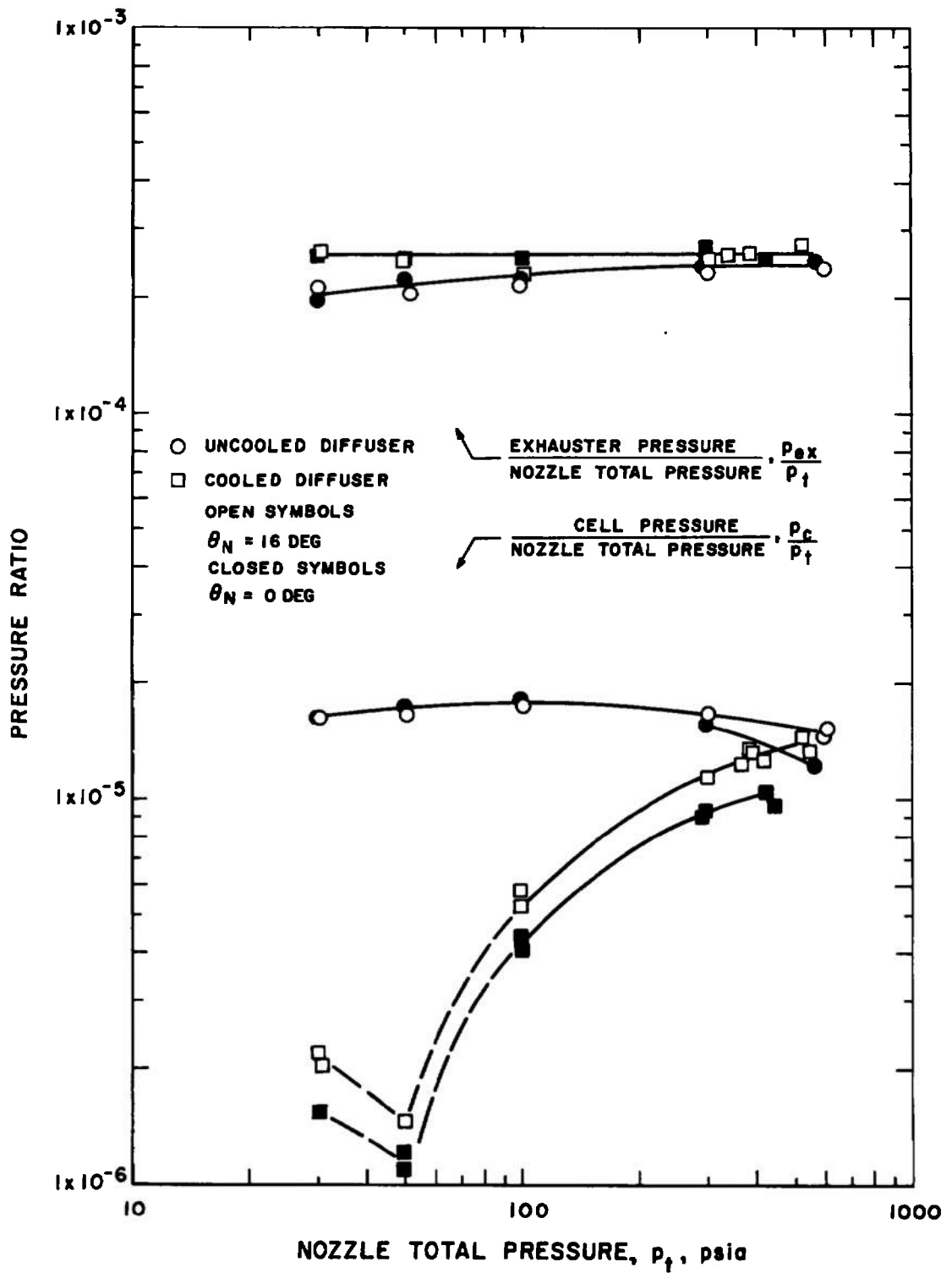

Fig. 16 Effect of Ejector Nozzle Exit Angle and Diffuser Wall Cooling on the Operational Characteristics of the CWVC System Using CO₂ at T_t = 100°F



b. $A_D/A^* = 2410$

Fig. 16 Continued



c. $A_D/A^* = 6045$
 Fig. 16 Concluded

TABLE I
DIFFUSER DIMENSIONS

<u>18-in. Test Cell</u>		
<u>Nominal A_D/A^*</u>	<u>Diameter, in.</u>	<u>Length, in.</u>
950	3.18	32.1, 19.4
950	3.20	64.3
2410	5.05	51.1, 30.9
6045	8.01	80.4, 48.4
<u>Cold Wall Vacuum Chamber</u>		
950	5.05	30.3
2410	7.97	47.9
6045	12.75	76.1

TABLE II
TEST CELL AND MAXIMUM EXHAUSTER PRESSURE RATIOS
AS CALCULATED FROM THE ONE-DIMENSIONAL THEORY

<u>A_D/A^*</u>	<u>γ</u>	<u>P_c/P_t</u>	<u>P_{ex}/P_t</u>
950	1.28	2.37×10^{-5}	1.76×10^{-3}
	1.40	1.05×10^{-5}	1.56×10^{-3}
	1.667	1.72×10^{-6}	1.28×10^{-3}
2,410	1.28	7.06×10^{-6}	7.00×10^{-4}
	1.40	2.83×10^{-6}	6.18×10^{-4}
	1.667	3.70×10^{-7}	5.10×10^{-4}
6,045	1.28	2.16×10^{-6}	2.82×10^{-4}
	1.40	7.75×10^{-8}	2.47×10^{-4}
	1.667	8.10×10^{-8}	2.05×10^{-4}
15,300	1.28	6.50×10^{-7}	1.12×10^{-4}

APPENDIX III REYNOLDS NUMBER CORRELATION

Because of the nonuniformity of the expanded flow approaching the diffuser, free-stream conditions on which to base a Reynolds number cannot be readily defined. However, flow conditions can be based on the same fictitious one-dimensional flow that is used to estimate the ejector performance (Section 3.2). Therefore, a Reynolds number based on these properties and the diffuser diameter for a characteristic length was chosen.

Perhaps the largest uncertainty in the Reynolds numbers calculated lies in the choice of values for the viscosity of CO_2 and N_2 at the very low temperature of the expanded flow. The values used are given in Fig. III-1. Values for He are experimentally verified and are taken from Ref. III-1. However, both CO_2 and N_2 are expanded near or below gas saturation conditions, and equilibrium values for the viscosity do not exist at some conditions. Therefore, the values shown in Fig. III-1 were obtained from Ref. III-2 and by extrapolating to zero viscosity at zero temperature.

REFERENCES

- III-1. Scott, R. B. Cryogenic Engineering. D. Van Nostrand Company, Inc., Princeton, New Jersey, 1959, p. 315.
- III-2. Hilsenrath, Joseph, Beckett, Charles W., et al. Tables of Thermodynamic and Transport Properties of Air, Argon, Carbon Dioxide, Carbon Monoxide, Hydrogen, Nitrogen, Oxygen, and Steam. Pergamon Press, 1960, p. 191, 357.

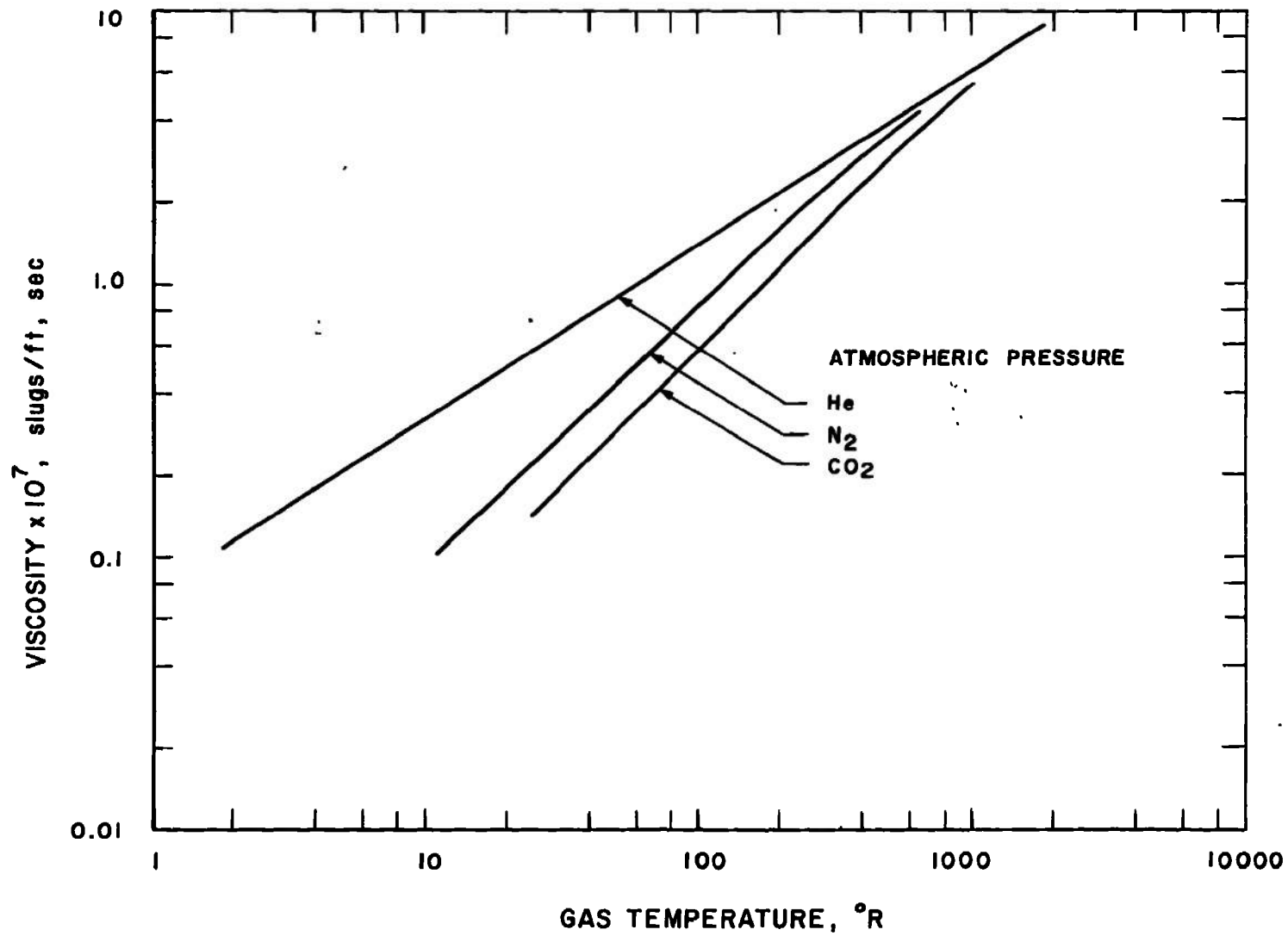



Fig. III-1 Gas Viscosity

DOCUMENT CONTROL DATA - R & D

(Security classification of title, body of abstract and indexing annotation must be entered when the overall report is classified)

1. ORIGINATING ACTIVITY (Corporate author) Arnold Engineering Development Center ARO, Inc., Operating Contractor Arnold Air Force Station, Tennessee		2a. REPORT SECURITY CLASSIFICATION UNCLASSIFIED	
		2b. GROUP N/A	
3. REPORT TITLE AN INVESTIGATION OF EJECTOR SYSTEMS USING VERY LARGE DIFFUSERS			
4. DESCRIPTIVE NOTES (Type of report and inclusive dates) December 1965 to June 1968 - Final Report			
5. AUTHOR(S) (First name, middle initial, last name) R. D. Herron, ARO, Inc.			
6. REPORT DATE November 1968	7a. TOTAL NO. OF PAGES 56	7b. NO. OF REFS 13	
8a. CONTRACT OR GRANT NO. F40600-69-C-0001	9a. ORIGINATOR'S REPORT NUMBER(S) AEDC-TR-68-216		
b. PROJECT NO 5730	9b. OTHER REPORT NO(S) (Any other numbers that may be assigned this report) N/A		
c. Program Element 6240518F			
d. Task 573004			
10. DISTRIBUTION STATEMENT This document has been approved for public release and sale; its distribution is unlimited.			
11. SUPPLEMENTARY NOTES Available in DDC		12. SPONSORING MILITARY ACTIVITY Arnold Engineering Development Center, Air Force Systems Command, Arnold Air Force Station, Tennessee	
13. ABSTRACT <p>An experimental investigation was conducted to determine the characteristics of ejector systems using very large cylindrical diffusers. Tests were conducted with nitrogen, carbon dioxide, and helium gases in systems having diffuser cross section to nozzle throat area ratios from 950 to 15,300. Limited effects of ejector nozzle configuration, diffuser length, system size, and diffuser wall cooling were investigated. Excellent system performance was obtained, with test cell altitudes of 250,000 ft being produced by the pumping action of the ejector at nozzle total pressures of approximately 100 to 200 psia.</p>			

14 KEY WORDS	LINK A		LINK B		LINK C	
	ROLE	WT	ROLE	WT	ROLE	WT
1 diffusers 2 ejectors -- <i>Performance</i> wind tunnel tests 4 nitrogen 5 carbon dioxide 6 helium 3 cryopumping operational characteristics supersonic flow 3. Ejectors --  1 - 2						