

Energy & Environmental Science

www.rsc.org/ees

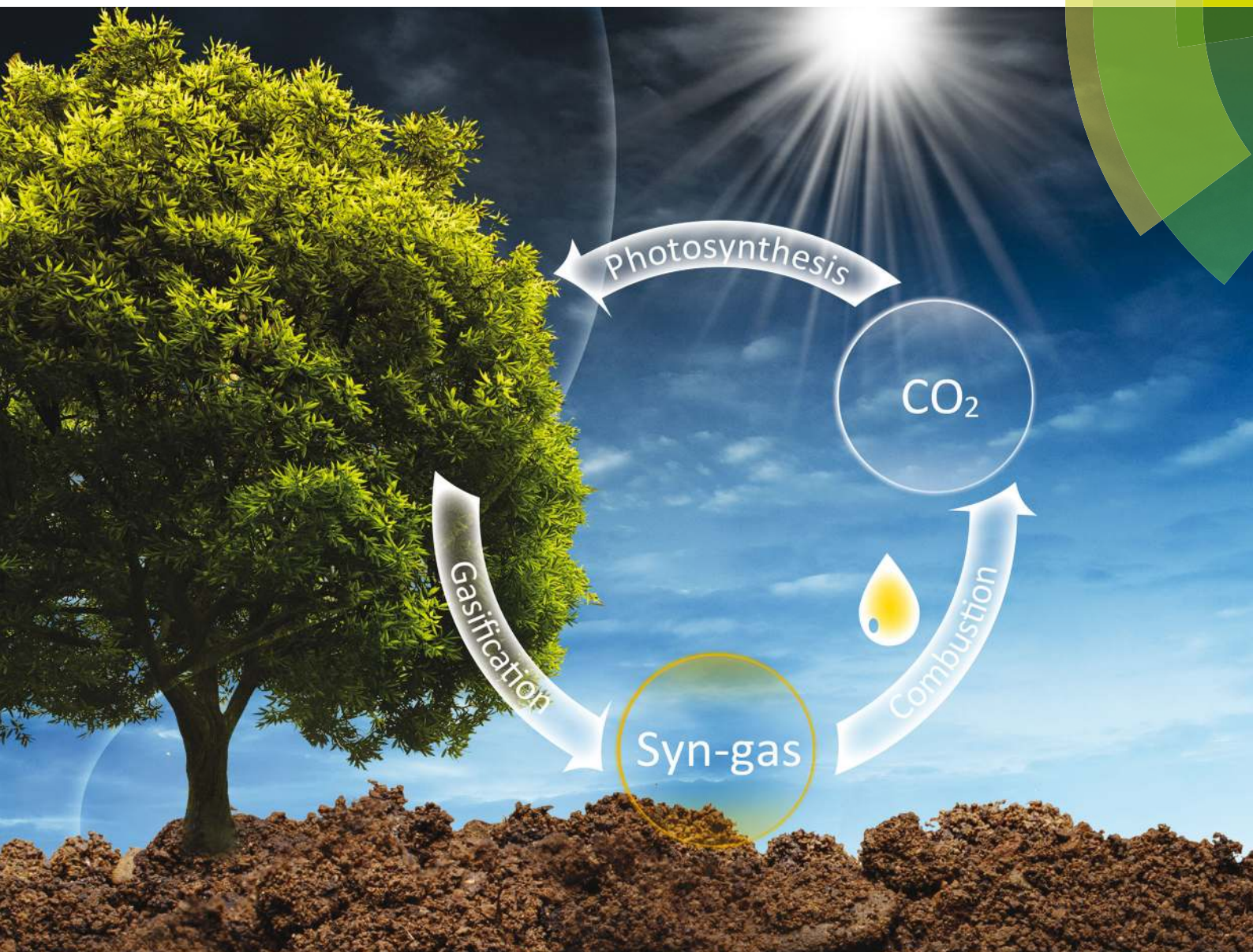

ISSN 1754-5692



REVIEW ARTICLE
Ming Zhao, Paul S. Fennell *et al.*
An overview of advances in biomass gasification

175 YEARS



Cite this: *Energy Environ. Sci.*, 2016, 9, 2939

An overview of advances in biomass gasification

Vineet Singh Sikarwar,^a Ming Zhao,^{*abc} Peter Clough,^d Joseph Yao,^d Xia Zhong,^e Mohammad Zaki Memon,^a Nilay Shah,^d Edward J. Anthony^f and Paul S. Fennell^{*d}

Biomass gasification is a widely used thermochemical process for obtaining products with more value and potential applications than the raw material itself. Cutting-edge, innovative and economical gasification techniques with high efficiencies are a prerequisite for the development of this technology. This paper delivers an assessment on the fundamentals such as feedstock types, the impact of different operating parameters, tar formation and cracking, and modelling approaches for biomass gasification. Furthermore, the authors comparatively discuss various conventional mechanisms for gasification as well as recent advances in biomass gasification. Unique gasifiers along with multi-generation strategies are discussed as a means to promote this technology into alternative applications, which require higher flexibility and greater efficiency. A strategy to improve the feasibility and sustainability of biomass gasification is *via* technological advancement and the minimization of socio-environmental effects. This paper sheds light on diverse areas of biomass gasification as a potentially sustainable and environmentally friendly technology.

Received 30th March 2016,
Accepted 2nd June 2016

DOI: 10.1039/c6ee00935b

www.rsc.org/ees

Broader context

Biomass energy is one of the most widely explored research fields in energy and environmental science. The major driver for biomass gasification research is to exploit low-cost feedstocks, to increase process efficiency, decrease installation and operational costs and socio-environmental effects. This work gives a holistic view of current research, development and deployment, and how we could move forward towards economically and socially acceptable biomass gasification technologies. We elucidate various areas and compare various conventional gasification technologies, current developments, and challenges to advance gasification as a viable and environmentally sustainable technology for using renewable fuel resources.

1. Introduction

Alterations to the climate due to temperature rise caused by the greenhouse effect pose a risk to humanity, and other species. Greenhouse gas (GHG) emissions from anthropogenic activities such as the burning of fossil fuels for power generation are major contributors to climate change. This necessitates a switch from conventional to renewable power sources, for example, solar photovoltaic (PV), wind, biomass and hydroelectric generation.

Biomass utilization has an advantage over other renewable sources as it is less dependent on location and climate and biomass is easily storable and transportable. In addition, it is abundantly available, currently provides more than 10% of the global energy supply, and ranks among the top four energy sources in terms of world final energy consumption in 2011.^{1–3}

Rural areas in underdeveloped nations are dependent upon biomass for essential activities such as cooking and heating. India has substantial coal reserves of around 223 billion tonnes, but these are concentrated in specific locations (central and eastern India) unlike biomass, which is evenly and extensively spread over the whole nation.^{4,5} Furthermore, waste biomass is often more readily available and can be equally as useful as a low-cost fuel. This makes it viable and promising as an energy source. Developed countries are also focusing on biomass as a sustainable energy option since it is abundant and has a lower environmental impact compared to fossil fuels.

An interesting account of global gasification history can be found in the National Energy Technology Laboratory, USA database and investigation performed by Rajvanshi.^{6,7} The earliest research on gasification was done by Thomas Shirley in 1659.

^a School of Environment, Tsinghua University, Beijing 100084, China.

E-mail: ming.zhao@tsinghua.edu.cn; Tel: +86 10 62784701

^b Key Laboratory for Solid Waste Management and Environment Safety, Ministry of Education, Beijing 100084, China

^c Collaborative Innovation Center for Regional Environmental Quality, Tsinghua University, Beijing 100084, China

^d Department of Chemical Engineering, Imperial College London, South Kensington, London, SW7 2AZ, UK. E-mail: p.fennell@imperial.ac.uk; Tel: +44 (0)20 7594 6637

^e School of Chemical & Biomolecular Engineering, The University of Sydney, Sydney NSW 2006, Australia

^f Cranfield University, Cranfield, Bedfordshire MK43 0AL, UK



His investigation led to the production of carbureted hydrogen, presently known as methane. In 1739, Dean Clayton moved a step forward and distilled coal in a closed vessel. The earliest patents in gasification were acquired by Robert Gardner and

John Barber in the years 1788 and 1791 respectively. Robert Gardner investigated the usage of waste thermal energy of furnaces to generate steam by burning the products in a boiler. John Barber's patent was about the usage of producer gas to



Vineet Singh Sikarwar

Vineet Singh Sikarwar is a PhD researcher working in the Laboratory for Biomass Energy & CCS Technologies, School of Environment, Tsinghua University for the past 2 years. He is working on experimental and theoretical investigations of biomass gasification with CO₂ capture under the supervision of Dr Ming Zhao. He has pursued his Bachelor's and Master's degrees in Mechanical Engineering from Rajiv Gandhi Technical University India with focus on Renewable Energy Systems.



Ming Zhao

Ming Zhao is an associate professor in the School of Environment at Tsinghua University. He obtained his PhD in Chemical Engineering from the University of Sydney in 2010. He was elected into China's Recruitment Program of Global Youth Experts (The National Youth 1000-Talent Program) after he completed his work at Imperial College London in 2014. He is now the director of the Laboratory for Biomass Energy & CCS Technologies. The research interests of his group include thermo-chemical conversion of solid fuels (e.g. coal and biomass) into clean energy and value-added chemicals, advanced materials and processes for CO₂ capture, modelling study for fuel processing, waste-to-energy and CCS processes, and LCA-based techno-economic assessment towards commercialization.

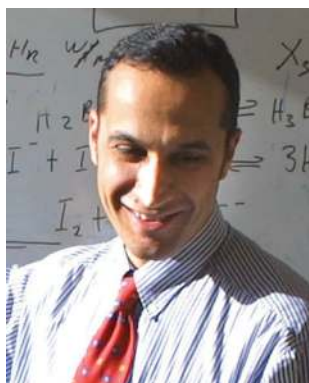

Nilay Shah

Nilay Shah is the Director of the Centre for Process Systems Engineering (CPSE) and co-director of the Urban Energy Systems project at Imperial College London. His research interests include the application of process modelling and mathematical/systems engineering techniques to analyze and optimize complex, spatially- and temporally-explicit low-carbon energy systems, including hydrogen infrastructures, carbon capture and storage systems, urban energy systems and bioenergy systems. He is also interested in devising process systems engineering methods for complex systems such as large scale supply chains and bio-renewable processes, and in the application of model-based methods for plant safety assessment and risk analysis. He has published widely in these areas and is particularly interested in the transfer of technology from academia to industry.



Edward J. Anthony

Dr Anthony is the head of the Combustion and Carbon Capture and Storage Centre at Cranfield University and a Professor in Energy Process Systems. Previously he was a senior research scientist with Natural Resources Canada, where he headed the Gasification and Fluidized Bed Combustion Group. His interests include thermal energy processes that can offer pure CO₂ streams for sequestration, and gasification technology, both in its high-pressure and atmospheric forms. Dr Anthony is the author of 215+ journal papers on various aspects of combustion and gasification, along with a similar number of conference papers, 13 book chapters, and he is the co-editor of the first book on Pressurized Fluidized Beds and a new book with Dr Paul Fennel on Ca and Chemical Looping. Dr Anthony's current R&D pursuits are strongly focused on calcium looping cycles, oxy-fired CFBC technology and pressurized, entrained-flow gasification and lime-based chemistry. Dr Anthony was an adjunct Professor with the Chemical Engineering Department at the University of Ottawa from 2005 to 2013, and is a guest Professor with Southeast University in Nanjing, China and a visiting Professor at Imperial College. He is also a Fellow of the Institution of Chemical Engineers, the Royal Society of Chemistry and the Institute of Energy and he is a Chartered Scientist, and a Chartered Engineer.



run an internal combustion (IC) engine. However, the first confirmed application of producer gas from coal was reported in 1792 when William Murdoch produced gas from coal to light his residence. The 19th century saw the exploitation of the water-gas shift reaction in 1801 by Fourcroy, and installation of the first successful gasifier unit, the Siemens gasifier, in 1861. The 20th century witnessed groundbreaking development. Fully continuous gasification using cryogenic separation of air was contrived by Carl Linde in 1920. This was followed by the development of the fluidized bed gasifier (FBG) in 1926 and the pressurized moving bed process in 1931. These were stepping stones in the biomass gasification (BG) arena, which led to the establishment of the first commercial gasification plant in the US in December 1999. This was a coal gasification plant known as the Wabash River Coal Gasification Project.⁸ Post 2001, biomass gasification has increasingly come under the spotlight, on account of rising oil prices and concerns over climate change. This led to the expansion of more advanced biomass gasification projects around the world.^{9–12}

Biomass gasification has a high potential for application in waste processing compared to other existing techniques such as land-fill, incineration, *etc.*, because it can accept a wide variety of inputs and multiple useful products can be produced. Biomass gasification is an intricate process involving drying the feedstock followed by pyrolysis, partial combustion of intermediates, and finally gasification of the resulting products. It is performed in the presence of a gasifying media which can be air, oxygen (O₂), steam (H₂O) or carbon dioxide (CO₂), inside a reactor called a gasifier. The calorific value of the product gas is dependent on the gasifying agent. The product gas from air gasification gives a heating value of around 4–7 MJ Nm⁻³ whereas when gasifying utilizing pure O₂, the heating value can be as much as 12–28 MJ Nm⁻¹.¹³ Biomass gasification reduces the carbon-to-hydrogen (C/H) mass ratio resulting in increased calorific content of the product on account of enhanced H₂ fraction.¹⁴ The gasifying medium also plays a vital role of

converting solid char and heavy hydrocarbons (HC) to low-molecular-weight gases such as carbon monoxide (CO) and H₂. The quality and properties of the product are dependent on the feedstock material, gasifying agent, feedstock dimensions, temperature and pressure inside the reactor, design of reactor and the presence of catalyst and sorbent.¹⁵

There are many useful products from the gasification of biomass, which include: syngas, heat, power, bio-fuels, fertilizer and bio-char. Syngas can be further processed by means of the Fischer-Tropsch process into methanol, dimethyl ether and other chemical feedstocks. Generally, biomass feedstocks are classified into four main groups: woody biomass, herbaceous biomass, marine biomass and manures.¹⁶ The gasifier is usually designed to generate a given product; however, the feedstock material is an important parameter to specify and optimize where possible.

Tar formation during biomass gasification is a serious problem. Tar is a thick and viscous liquid containing heavy aromatic hydrocarbons and often a high content of heavy metals.¹⁷ It has the potential to cause operational issues through downstream blockage and quality degradation of product gas. Furthermore, tars are never the desired product and thus the efficiency of production is reduced. Tar can be reduced by thermal cracking, steam reforming, dry reforming, carbon formation and partial oxidation as presented in reactions (1), (2), (3), (4) and (5), respectively.

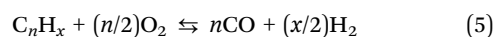
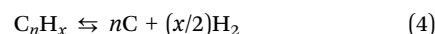
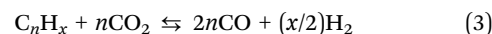
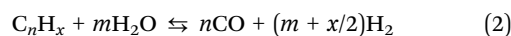
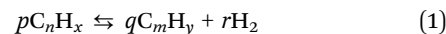

In the above series of reactions, C_nH_x represents tar, which is the combination of numerous organic compounds, and C_mH_y represents a lighter HC compared to C_nH_x.¹⁸ The work presented here also reviews various research related to the formation, quantification, growth and minimization of tar production.

The goal of this review is to assess conventional and advanced biomass gasification technologies. In the next section we compare conventional and emerging designs to characterize the current state of the art and classify encouraging novel technologies. In Section 3, we discuss feedstocks and the effects of feedstock properties on system performance. Section 4 explains the influence of various operating parameters on the gasification process and Section 5 discusses various dimensions of tar formation, measurement and minimization. It is followed, in Section 6, by discussion of various multi-generation approaches, including potential barriers. This paper also sheds light on the various mathematical modelling techniques such as thermodynamic modelling, kinetic modelling, computational fluid dynamics (CFD), artificial neural network modelling (ANN), and their associated limitations, along with tar models. The social and environmental impact of biomass gasification (hereafter BG) is also discussed in the last section.



Paul S. Fennell

Paul Fennell is a Reader in Clean Energy at Imperial College London. He obtained his degree in Chemical Engineering and PhD from the University of Cambridge. He chaired the Institution of Chemical Engineers Energy Conversion subject panel (2014–2016), and has acted as an advisor for numerous UK government departments. He is the joint director of IC's Centre for Carbon Capture and Storage and is the Research Area Champion for

Industrial CO₂ Capture and Storage for the UK CO₂ Capture and Storage Research Centre. He has published 50+ papers since 2005 and is the 2015 winner of the IChemE Ambassador prize.



2. Biomass gasification – conventional vs. emerging

Over the past decade, biomass gasification has been developed to utilize wastes and to obtain useful products such as syngas, H₂, methane (CH₄) and chemical feedstocks. These gases can additionally be produced from biomass through biochemical routes. Thermochemical pathways have an edge over the other routes, as commercialized biochemical processes currently have issues treating biomass rich in lignocellulose⁹ (importantly, new methods to valorize lignocellulosic biofuels are under development, but currently are not commercialized at full scale, *e.g.* the ionosolv¹⁹ and organosolv²⁰ treatment methods). In addition, they operate in batch mode, are relatively slow and produce a dilute product stream, with large amounts of water recirculating in the processes. The thermochemical route also has the advantage of being able to accommodate a more diverse range of biomass.²¹ Moreover, it has a higher efficiency and a lower cost.²² One of the main limitations with this process is the small range of products.^{21,22}

The most commonly used gasifiers are fixed bed gasifiers (FXBG), fluidized bed gasifiers (FBG) and entrained flow gasifiers (EFG). These are shown in Fig. 1(a), (b), 2 and 3, respectively. The difference between updraft and downdraft is shown in Fig. 1(c). Briefly, a fixed-bed gasifier can be either updraft (fuel enters from the top, gasifying agent from the bottom) or downdraft (both fuel and gasification agent enter from the top), with the fuel coming in from a lock-hopper. In updraft gasification, the char at the bottom of the bed meets the gasifying agent first, and complete combustion occurs, producing H₂O and CO₂ and raising the temperature to ~1000 °C. The hot gases percolate upwards through the bed, driving endothermic reactions with unreacted char to form H₂ and CO, with consequent cooling to ~750 °C. The gases pyrolyze the dry biomass which is descending, and also (near the top of the reactor) dry the incoming biomass. Updraft gasifiers typically produce between 10 and 20 wt% tar in the produced gas, which is far too high for many advanced applications.¹⁰

The allowable tar levels depend on the downstream application. These are around 0.05 g Nm⁻³, 0.005 g Nm⁻³ and 0.001 g Nm⁻³ for gas engines, gas turbines and fuel cells, respectively.²³ In contrast to an updraft gasifier, in a downdraft gasifier (closed top) the gas flows co-currently with the fuel. A “throated” gasifier has a restriction part-way down the gasifier where air or O₂ is added, and where the temperature rises to 1200–1400 °C, and the fuel feedstock is either burned or pyrolyzes. The combustion gases then pass down over the hot char at the bottom of the bed, where they are reduced to H₂ and CO. The high temperature within the throat ensures that the tars formed during pyrolysis are significantly cracked (homogeneous cracking), with further cracking occurring as the gas meets the hot char on the way out of the bed (heterogeneous cracking), leading to a less tarry off-gas. Some disadvantages of a throated gasifier are:⁹

- The constriction at the throat affects the types of biomass that can be successfully gasified.
- A low moisture content is required (<25 wt%).

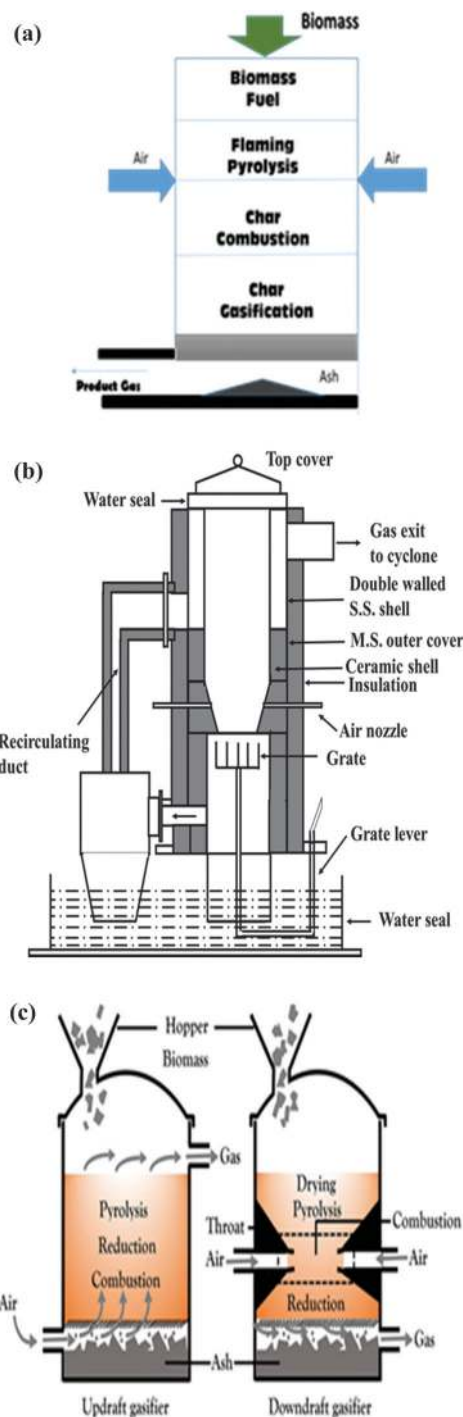

Fig. 1 (a) Schematic diagram of conventional fixed bed gasifier (downdraft).²⁸ (b) Open-top gasifier (downdraft).²⁷ (c) Difference between updraft and downdraft fixed bed gasifiers.

- Ash and dust are significantly present in the exhaust.
- Tar can still be up to 5 g Nm⁻³, needing further clean-up.

Another interesting and efficient design for fixed bed was devised by the scientists of the Indian Institute of Science.^{24–27} This open top fixed bed reactor has been found to be more efficient and reliable especially with high moisture content feedstock and produces a high quality gas with low tar content.



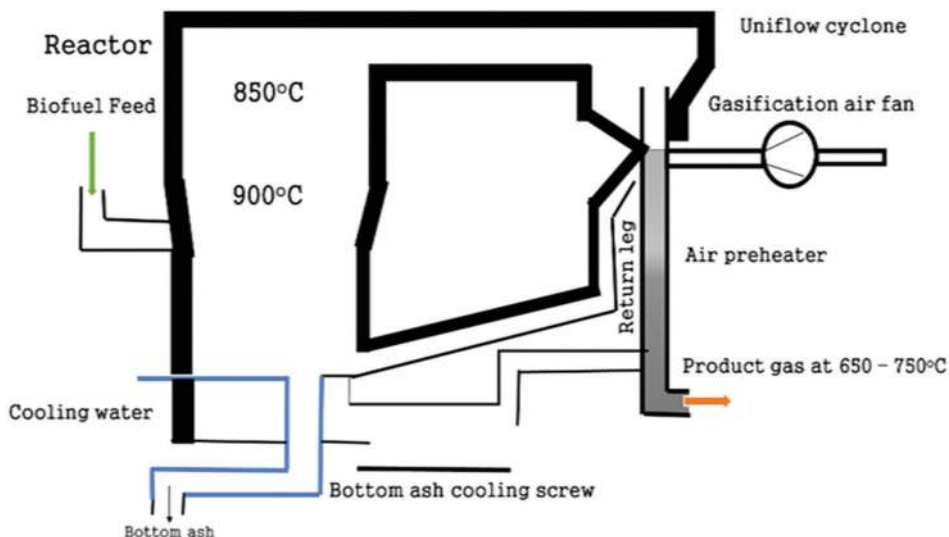

Fig. 2 Schematic diagram of a conventional fluidized bed gasifier (circulating).²⁸

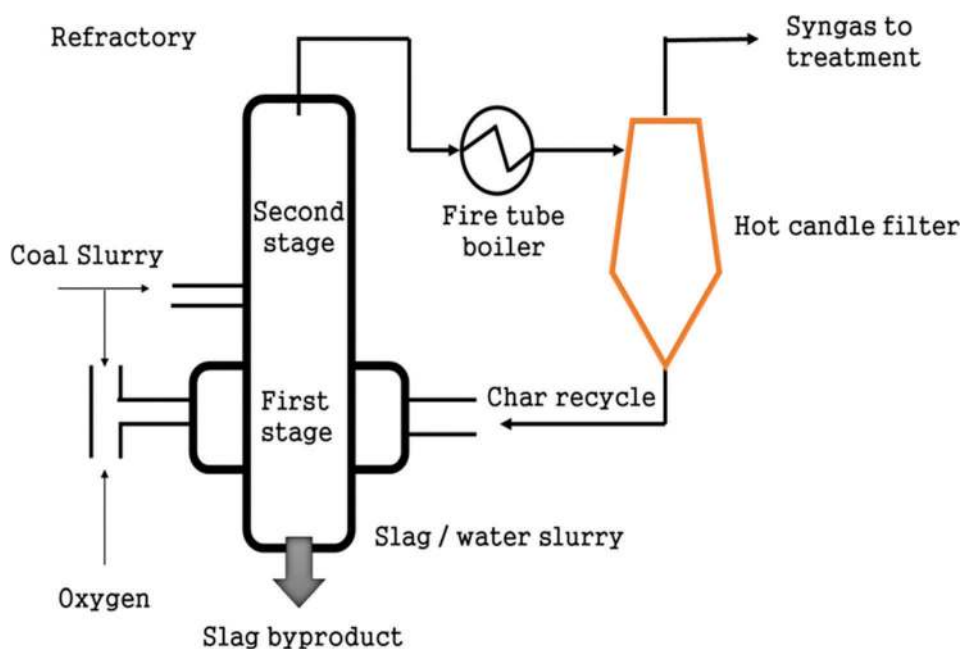

Fig. 3 Schematic diagram of an entrained flow gasifier (side-fed).²⁸

The gasifier consists of a vertical tube with an open top and water seal at the bottom, as depicted in Fig. 1(b). The top third of the reactor is made of stainless steel, with an annular jacket around it. The remaining lower part is made of ceramic material to avoid high-temperature corrosion ($> 600\text{ }^{\circ}\text{C}$) caused by the different gases prevailing at that point in the gasifier. The hot combustible gases produced are taken to the upper annulus of the gasifier *via* a grate and an insulated pipe. These gases transfer the heat to the feedstock, aid in drying and enhance the thermal efficiency of the process. A re-circulating duct connects the upper annular part of the gasifier to the lower part and is insulated with alumino-silicate blankets. Constant homogeneous air flow through the bed resulting in a final fuel-

rich state enhances the gasifier performance. Furthermore, a superior quality syngas with lower tar content is obtained on account of gas movement through a deep hot bed of charcoal.²⁷ Currently, there are more than 40 combined heat and power (CHP) plants based on this design operating worldwide.²⁴

Fluidized bed gasifiers come in three basic types:

■ **Bubbling fluidized bed (BFB):** here, the biomass is fed from the side, and/or below the bottom of the bed, and the gasifying agent's velocity is controlled so that it is just greater than the minimum fluidization velocity of the bed material. The product gas exits from the top of the gasifier and ash is either removed from the bottom or from the product gas using a cyclone.



■ Circulating fluidized bed (CFB) systems use two integrated units. In the first unit (the riser) the bed material is kept fluidized by the gasifying agent, with a higher velocity than that found in a BFB. This allows the bed material to be fluidized to a greater extent than in the BFB and the overall residence time is higher, due to the circulation, which is effected by passing the product gas and entrained bed material through a cyclone which separates the product gas from the bed material which is recirculated back to the riser.

■ Dual fluidized bed (DFB) gasifiers separate the gasification and the combustion parts of the process using two separate fluidized beds. The biomass is fed into the base of the gasifier bed, usually fluidized by steam. The second bed acts as a char combustor using air in a fast fluidized bed which heats the bed material. The bed material acts as the heat transfer medium between beds and this avoids gas transfer, allowing a nitrogen-free syngas to be produced; the bed material is separated from the combustion flue gases in a cyclone and recirculated to the gasifier.

Entrained flow gasifiers are highly efficient and useful for large-scale gasification, and are commonly employed for coal, biomass and refinery residues. Their requirement for highly pulverized fuel particles presents problems when gasifying biomass. On the other hand, gasification in these gasifiers is above 1000 °C which aids in cracking tar; they are therefore advantageous for biomass gasification where tar is a serious issue. They are basically classified in two families:

■ Top-fed gasifier: these are vertical reactors of cylindrical shape where finely refined particles of fuel and gasifying agent are fed from the top end in the form of a jet. An inverted burner results in their combustion followed by gasification. Product gas is taken out from the side of the lower section whereas slag is deposited at the bottom of the reactor.

■ Side-fed gasifier: here, pulverized fuel and the gasifying agent are fed through nozzles present in the lower part of the reactor. This design results in appropriate mixing of fuel and oxygen. The product gas is collected from the top and the slag from the bottom of the vessel.

Other important issues that process designs need to deal with are slagging, fouling and corrosion. These issues arise out of the inorganic species present in the biomass and are, therefore, dependent to a large part on the biomass composition. Corrosion can occur from the generation of acid gases in the gasification process, which in turn have their origin in species such as sulphur and chlorine. Corrosion concerns may require temperature management (*e.g.*, rapid cooling of the syngas while maintaining it above the acid dew points), active maintenance strategies or attention to materials of construction or coatings. Slagging and fouling are dependent on the ash content of the biomass, and the propensity for these problems is also related to the alkali metal content of the biomass, as explained in Section 3.1.

Among advanced approaches is the concept of unique gasifiers which integrate biomass gasification, a pollutant removal process, and gas conditioning within a single reactor. This reduces space requirements resulting in lower investment costs.²⁹

An analysis of other strategies such as multistage gasification, pyrolysis and gasification at different locations, supercritical water gasification (SCWG) and plasma gasification³⁰ are also presented in this section of the review.

2.1 Conventional approaches

Biomass gasification consists of many overlapping processes: drying, pyrolysis and partial oxidation. The feasible gasification routes are shown in Fig. 4. Pyrolysis is the process of producing solid, liquid or gaseous fuels or valuable chemicals by transforming biomass in an O₂-deficient environment. The process can be categorized as mild pyrolysis, slow pyrolysis or as fast pyrolysis. A very simple way of representing the gasification reaction is shown below (6):

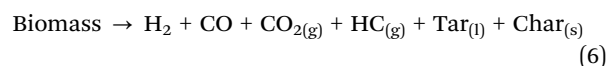

Fast pyrolysis is considered to be an efficient thermochemical route to transform biomass into liquid fuel, followed by partial oxidation and subsequent gasification to yield the desired products. Elevated temperatures, high heating rates and long volatile stage residence times are vital for syngas or H₂ production.³⁵ Since the liquid yield through fast pyrolysis is high, the gaseous yield is reduced. This approach does not allow the production directly of usable fuels (or feedstock for blending), but produces pyrolytic oils requiring further upgrading owing to their high acidity. Gasification is an alternative thermo-chemical route to treat biomass, which reduces these limitations. The different stages of gasification are depicted in Scheme 1.

Steam gasification is an efficient and established method for H₂ production.^{36,37} The char and tar production is small since the steam transforms them to CO and H₂ through gasification, water-gas shift and reforming reactions. Several researchers^{38–41} have established that the H₂ yield through steam BG is three times higher than the yield from air BG. They have also reported an improvement in cost-effectiveness with higher H₂ production while using steam as the medium in gasification. Aravind *et al.*^{42,43} state that gas cleaning is a vital step between gas production in the gasifier and gas utilization. The outlet gas exiting the biomass gasification system is contaminated with tar, alkali metals, particulate matter, nitrogen (N₂), sulphur (S), and chlorine (Cl). Table 1 shows the issues caused by these contaminants and methods to eliminate them.

2.1.1 Applications of syngas. Syngas is one of the key products of biomass gasification and is a blend of CO and H₂. Syngas is a vital source of environmentally benign fuels and chemicals. Moreover, it is a suitable fuel for the production of electricity. Employing the Fischer Tropsch (FT) process, gasoline, diesel and other chemicals can be manufactured.⁴⁴ Syngas can be readily converted to methanol or DME, which in turn can be transformed to gasoline in the presence of zeolites, or methyl tertiary butyl ethylene (MTBE) in the presence of isobutylene. Hydrogen is produced from syngas, employing the water gas shift reaction, which has numerous applications including in fuel cells. SNG (synthetic natural gas, CH₄) is also one of the significant uses of syngas. Synthesis gas has also

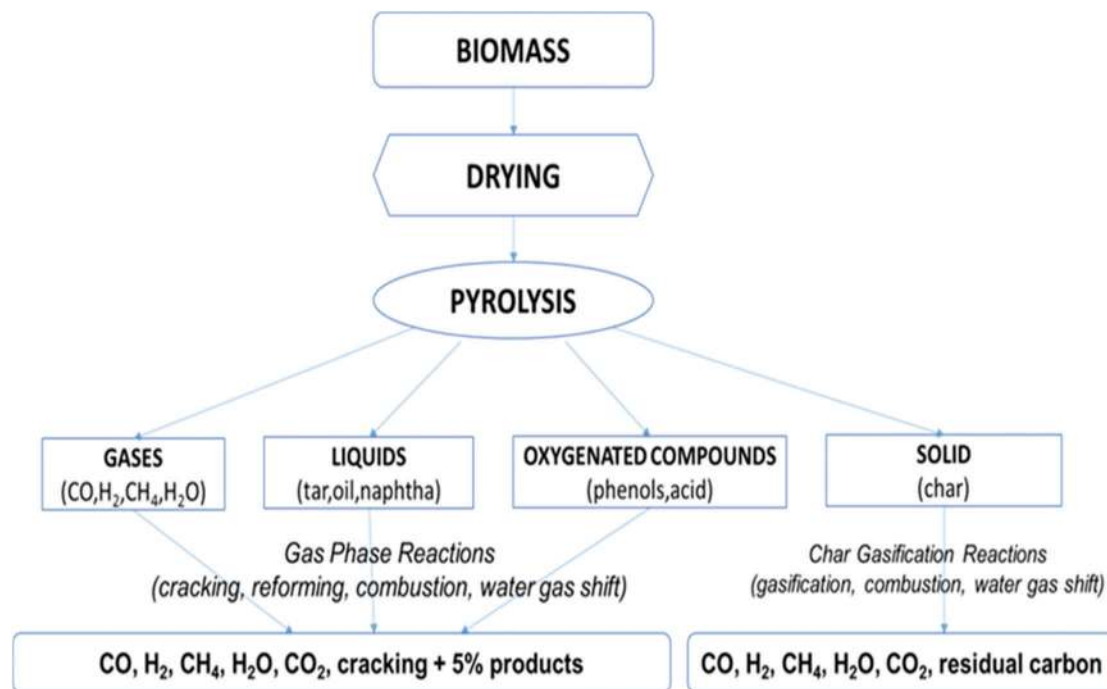
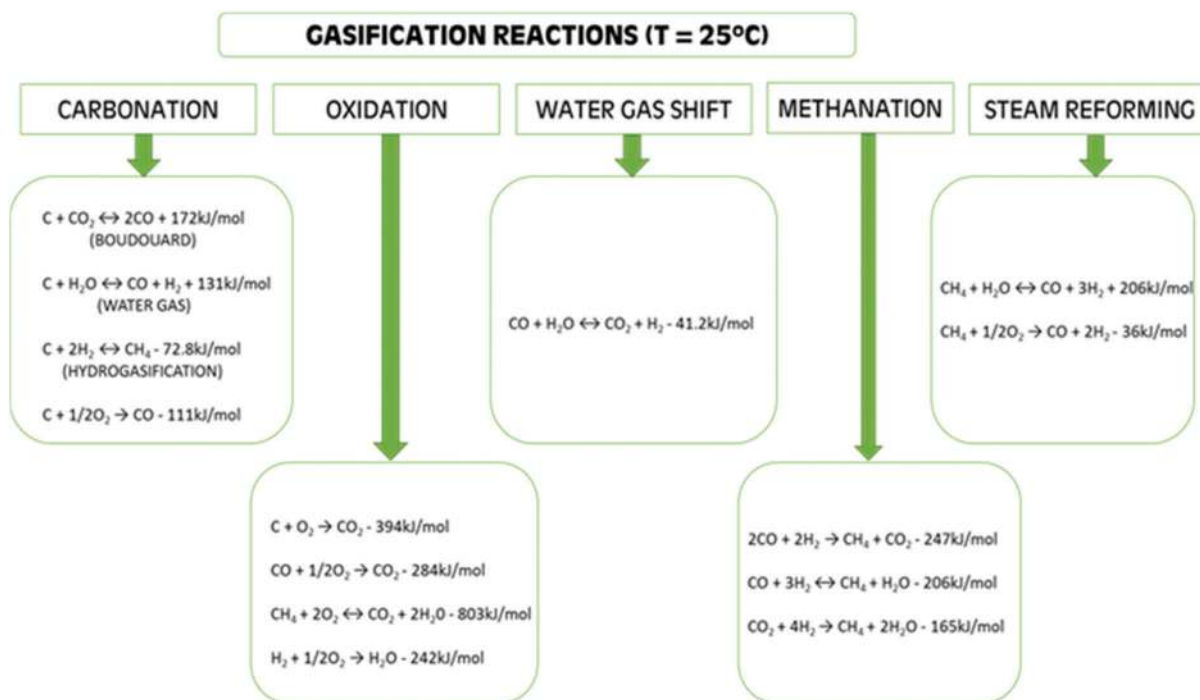

Fig. 4 Gasification routes.³¹Scheme 1 Gasification reactions.^{12,14,32}

found applications in producing medium-BTU gas which is used as turbine fuel and in integrated gasification combined cycle (IGCC).⁴⁵

Contaminants such as particulates, tars, nitrogenous compounds such as NH₃ and HCN, sulphur-containing inorganic compounds such as H₂S, COS and CS₂, halogens such as HCl

and Cl, and traces of metals such as Na and K are present in varying quantities in syngas produced from gasification. As compared to other contaminants, tar is present in huge quantities per unit wt of feedstock.⁴⁶ The type of biomass, operational conditions and the gasifier type are the variables which determine tar concentrations. These contaminants in



Table 1 Raw gas contaminants³³

Contaminant	Example	Issue	Removal technique
Particulate	Ash, char	Erosion	Cyclone, filter, ESP
Tar	Cyclic & polycyclic hydrocarbon	Clogging, deposition	Physical, chemical & catalytic methods
Alkali metal	Sodium & potassium compounds	Hot gas corrosion	Gas cooler + cyclone/ESP
Fuel nitrogen	NH ₃ , HCN	NO _x	Scrubbing
Sulphur	H ₂ S, SO ₂	Corrosion	Scrubbing, activated carbon
Chlorine	HCl	Corrosion, catalyst poisoning	Scrubbing, activated carbon

Table 2 Maximum permissible limits of contaminants present in syngas for various applications³⁴

Contaminants	Applications		
	Gas turbine	FT synthesis	Methanol synthesis
Tar (mg Nm ⁻³)	na	<0.1–1	<1
Sulphur contaminants (ppmv)	<20	0.01	<1
Nitrogen contaminants (ppmv)	<50	0.02	0.1
Alkali (ppmv)	<0.02	0.01	na
Halides (ppmv)	<1	0.01	0.1

syngas pose numerous technical and working problems. For example, H₂S is responsible for equipment corrosion, tar causes fouling and catalyst deactivation occurs due to tar, H₂S, NH₃, HCl and trace metals.^{47–49} The maximum permissible limits of contaminants, for various applications, present in syngas from biomass gasification are depicted in Table 2.

2.2 Emerging approaches

Currently, in biomass gasification plants, clean gas is produced at ambient temperature after filtration and scrubbing, limiting its applications. The reduction in gas temperature owing to cleaning followed by conditioning reduces the overall profitability of the plant (although the syngas cooling step generates high-quality steam which can be of use elsewhere in the process or exported depending on the setup). Moreover, if the tar separation is not very effective, the gas quality and yield will suffer, making it unfit for applications where high levels of purity are essential. Therefore, gas conditioning preceded by clean-up at elevated temperatures (*i.e.*, “hot gas cleanup”, HGCU) is necessary, to ensure high efficiency in industrial applications, especially in the case of steam gasification. An example is NETL's sorbent-based cleanup process.⁵⁰ Progress in catalysts, sorbents and filtration techniques operating at high temperatures have paved a way to integrate gasification and gas clean-up in one reactor. Unique gasification technology investigated by research and development (R&D) establishments and industries in Europe and the US has made it possible to have immediate and efficient conversion of the outlet gas. They are used in fuel cells and micro gas turbines along with power plants.³ An example of a novel HGCU process is the use of plasma torches to crack tars; this differs from plasma gasification where the plasma is used for energy generation by gasifying biomass, MSW and refuse derived fuel (RDF).^{51,52} Relevant features, advantages and limitations of these technologies are presented in Table 3.

2.2.1 Combination of gasification and gas clean-up in one reactor.

The unique strategy to unite biomass gasification with product gas clean-up followed by conditioning has been thoroughly examined by joint R&D projects and also through industrial testing campaigns and a more detailed analysis of this technology and its early history can be found in the two volume series on Plasma assisted combustion edited by Matveev.^{53,54} In chapter 7, of volume 2 of the two books, Hrabovsky, explores the use of plasma gasification for organic waste and biomass. In particular, the technology is recommended if high quality and high syngas heating values are required. Particle and tar removal is done by employing catalytic filter elements in the freeboard of the FBG as shown in Fig. 5. The entire arrangement for gas conditioning is incorporated inside the gasifier to simplify the design, making it more compact, along with reduction in thermal losses and plant space. As there is no cooling step, thermal efficiency is retained, with no particle capture in the outlet gas, along with enhanced catalyst and sorbent activities. Consequently, conventional primary fuel gas treatment followed by secondary curing are integrated. This minimizes catalyst clogging and loss of thermal energy.

The presence of tars is considered the most inconvenient problem to deal with, especially while operating large-scale BG systems. Traditionally, steam reforming at elevated temperatures is employed as the solution.^{55,56} A FBG with low-cost bed material which can also act as catalyst to reduce the requisite temperature for tar cracking in the presence of steam is a viable alternative.^{55,56} The catalyst not only has a strong selectivity for the desired gas product, but it also has a high resistance to attrition and carbon deposition. A detailed discussion on tar abatement is given in Section 5.3 in this paper.

A very large volume of research has been conducted using dolomite and/or olivine as the catalyst bed material for the catalytic tar cracking. Calcined dolomite (CaMg(CO₃)₂), limestone (CaCO₃) and magnesite (MgCO₃) are reported to enhance H₂ yield.^{57–61} Rapagna *et al.*,¹³ Corella *et al.*⁶² and Devi *et al.*⁶³ demonstrated that dolomite shows a higher reactivity for BG towards tar reforming compared to olivine, but it is more susceptible to attrition. Nickel-based (Ni) catalysts suffer from mechanical instability, rapid deactivation in the presence of S, alkali metals and Cl, and sintering. On the other hand they allow the system to achieve higher H₂ yields.⁶⁴ Interestingly, it has been reported that when olivine was impregnated with Ni, the aforementioned issues with Ni-based catalysts were alleviated substantially.^{56,65,66} Olivine impregnated with iron (Fe) has also been tested. The results showed different catalytic mechanisms which were dependent on the extent of integration



Table 3 Features, advantages and limitations of emerging technologies in biomass gasification

Strategy employed	Features	Advantages	Limitations
Combination of gasification and gas clean-up in one reactor	Integration of gasification of biomass feedstock and syngas cleaning in single reactor	<ul style="list-style-type: none"> Robust process design Cost-effective 	More research is needed for large-scale commercial applications
Multi-staged gasification concept	Execution of pyrolysis and gasification within divided zones in a gasifier, in single-controlled stages	<ul style="list-style-type: none"> High quality clean syngas generation Improved process efficiency 	Enhanced complexity
Integration of distributed pyrolysis plants with central gasification plant	Production of char-oil slurry in distributed pyrolysis plants and gasification in central plant for syngas generation and biofuel synthesis	<ul style="list-style-type: none"> Usage of distributed, low-grade biomass Cost-effective transportation of char-oil slurry 	Gasoline and olefins production <i>via</i> this process is not economical
Plasma gasification	Usage of plasma as a heat source during gasification or as a tar-cracking agent downstream	<ul style="list-style-type: none"> Decomposition of any organic matter Treatment of hazardous waste 	<ul style="list-style-type: none"> High investment cost High power requirement Low efficiency High energy requirement High investment cost
Super critical water gasification	Gasification is carried out in super-critical water	<ul style="list-style-type: none"> Liquid and biomass with high moisture content are treated 	Development of advanced catalysts cum sorbents is needed
Sorption enhanced reforming and biomass gasification with CO ₂ capture	Gasification of feedstock is performed in the presence of catalyst and sorbent	<ul style="list-style-type: none"> No pre-treatment is required <i>In situ</i> CO₂ capture Enhanced H₂ production 	Only decentralized heat and power production is feasible as heat needs to be produced near the consumer
Co-generation of thermal energy with power	Combined generation of heat and power	<ul style="list-style-type: none"> Reduced tar content Enhanced process efficiency 	Enhanced complexity in process design
Poly-generation of heat, power and H ₂	Combined generation of heat, power and H ₂	<ul style="list-style-type: none"> Enhanced process efficiency Generation of renewable H₂ 	Not economical in the absence of a natural gas distribution system
Poly-generation of SNG with heat and power	Combined generation of heat, power and SNG	<ul style="list-style-type: none"> Generation of renewable fuel for transportation 	Enhanced complexity in process design
FT process coupled with gasifier	Syngas generated <i>via</i> gasification is utilized for FT-fuels synthesis	<ul style="list-style-type: none"> Enhanced process efficiency Production of clean, carbon-neutral liquid biofuels 	



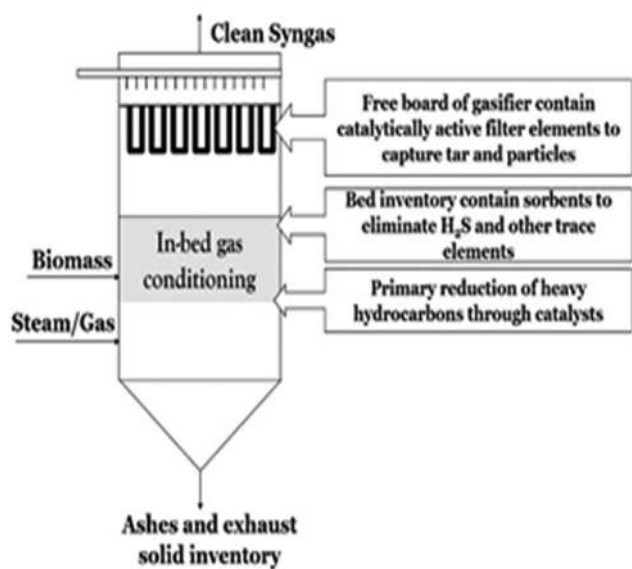

Fig. 5 Schematic of unique combination of gasification with *in situ* gas cleaning and conditioning.³

with Fe into their corresponding crystalline structure.⁶⁷ Calcination of Fe-bearing olivines has been reported to form oxides whose amount is dependent upon calcination time and temperature.^{67,68} Rapagna *et al.*⁴¹ and Virginie *et al.*^{69,70} found that when 10 wt% Fe-olivine was utilized in a pilot gasifier instead of olivine alone, total gas yield was increased by 40%, H₂ yield by 88%, CH₄ was curtailed by 16% and tar generation by 46%, encouraging the accretion of Fe in olivine.

The research above has shown that Ni-catalysts are suitable to convert tarry fuel gas into clean syngas even if hydrogen sulphide (H₂S) is present.⁷¹ In most of the cases, catalytic activity is slightly reduced; however, the residual activity remained constant even after considerable operation time and complete transformation of naphthalene, which is a key component of tar, was achieved.^{72,73} Ni-based catalysts have also been examined using a model gas (a mixture of benzene, naphthalene and CH₄) treatment, employing a catalytic filter.^{71–73} High H₂S concentrations are a serious risk for downstream chemical synthesis and fuel cell applications below 1000 °C.⁴² Ca-based sorbents have a high affinity for H₂S at elevated temperatures. The sulphidation of calcined and non-calcined CaCO₃ was examined extensively by Hu *et al.*^{74,75} Elseviers *et al.*⁷⁶ carried out extensive experimental work in real life settings for H₂S removal, and with simulated coal gas.^{76–78} They concluded that fuel gas composition does not influence the desulphurization performance of the sorbents.

Various studies have been conducted to assess the influence of sorbents on H₂S, hydrochloric acid (HCl) and other elements such as alkali and heavy metals, in a new concept called the Unique gasifier as shown in Fig. 5.³ Stemmler *et al.*⁷⁹ investigated the effects of varying the inlet feedstock and gasifier temperatures using thermodynamic models applying Gibbs free energy minimization on the elimination of alkali metals and toxic gases. Some experimental work was also carried out to back the theoretical findings. It was established that the

contaminants are removed in downstream equipment, giving a supplementary advantage of enhanced tar reforming.³ Aluminosilicates are reported to degrade alkali species' concentrations to ppb levels, along with the elimination of Cl and zinc (Zn).^{80,81}

The major problem with alkali and other heavy metals is their condensation and consequent induction of fouling and corrosion. Barisano *et al.*⁸² reported the utility of aluminosilicate sorbents to eliminate alkali halides during gasification. They used a FBG operating at ambient pressure with bauxite to degrade potassium chloride and sodium chloride. Bauxite was the preferable choice as it, along with bentonite, kaolinite and naturally occurring zeolites, is abundantly available, cheap and does not have a negative environmental impact on disposal.

2.2.2 Integration of pyrolysis and gasification. Biomass gasification is an integration of numerous overlapping steps, which makes it impossible to control and optimize these different steps distinctly in a single-stage gasifier. The contact between volatiles and char produced during pyrolysis has an adverse effect on the gasification of char.⁸³ Hence, char gasification in volatile-deficient environments improves the efficacy of biomass gasifiers.

An atypical gasification strategy separates pyrolysis and biomass gasification into separate stages with individual control, which are then subsequently integrated, *i.e.*, a multistage gasification. It avoids mixing of produced volatiles and char, consequently adverse impacts on the reactivity and gasification of char are eradicated. Enhanced exit gas purity, char transformation rate and efficiency, coupled with low levels of tar formation, can be achieved when employing this strategy. Two distinct modes of operation have been applied by the Danish Technical University, Denmark, and Karlsruhe Institute of Technology, Germany.^{84,85} In the first method, pyrolysis and biomass gasification are integrated in either a 2- or 3-stage process with different stages combined in a single overall unit with separated pyrolysis or biomass gasification zones or different reactors utilized in succession. In the other method, pyrolysis plants are positioned at diverse locations near sources of biomass pyrolysis. The pyrolysis products are transported to a central biomass gasification unit, thus improving the energy density of the energy vector transported, and hence the supply chain economics. Energy density is markedly enhanced when biomass is transformed to pyrolytic oils or oil – char slurry. For example, the energy densities of straw and woodchips is 2 GJ m⁻³ and 8 GJ m⁻³, respectively while in pyro-oil and char-oil slurry, the density increases to 30 GJ m⁻³ and 26 GJ m⁻³.⁸⁶ This concept is described in the following section – Integration of distributed pyrolysis plants with central gasification plant.

Multi-staged gasification concept. Pyrolysis and gasification are executed within divided zones inside a gasifier. This enables biomass conversion into usable products to take place under optimized operational settings for each individual step. The main motive behind this concept is to obtain a high-quality clean syngas with a low tar content. Moreover, improved efficiency and larger throughput have resulted utilizing this multi-zoned reactor setup.³



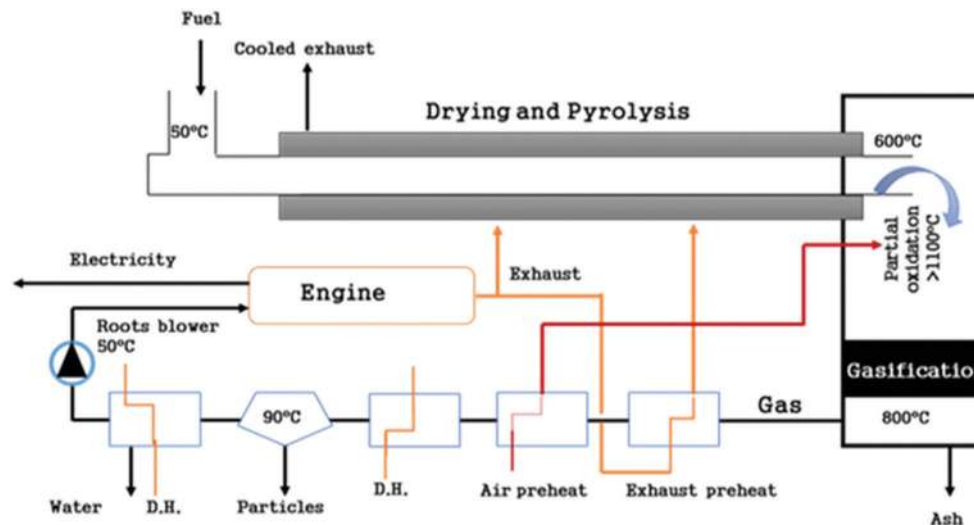

Fig. 6 Schematic diagram of Viking gasifier.⁸⁴

Some examples of this split reactor operation include the 75 kW_{th} Viking gasifier installed at the Danish Technical University; the FLETGAS process developed at the University of Sevilla, Spain; and a low-temperature circulating fluidized bed (LT-CFB) by DONG Energy Company in Denmark.^{83,84,87} As shown in the Fig. 6, the Viking gasifier is a 2-stage unit with a screw pyrolysis reactor followed by a downdraft gasifier. Material exiting the pyrolysis reactor is mixed with air to partly oxidize it before it enters the biomass gasification reactor. This degrades the tar content in the product gas to less than 15 mg m⁻³ (s.t.p.). Exit gases from the gasifier contain around 32% H₂ and 16% CO with traces (2%) of CH₄ with an upper calorific content of gas of 6.6 MJ Nm⁻³.^{84,88} This gasifier is presently working at 200 kW_e and will soon be up-scaled to 500 kW_e.⁸⁹

The FLETGAS process is a 3-stage gasification system. Devolatilization in a FBG takes place with low transformation of tar and char between 700 °C and 750 °C, in the first stage, with high production of reactive tar. The reactive tar is then reformed with steam in the second stage at 1200 °C. Char generated in the first step undergoes gasification in a downdraft gasifier, which in turn forms the third stage. Char formed in the primary step is directly conveyed to the third stage *via* solid transport in a sealed system and gas coming from the second step passes into the bed of char, which also serves as catalyst for further tar reduction.^{83,90}

Researchers have performed modelling work to investigate the advantages and disadvantages of multi-staged reactors over single-stage reactors. A noteworthy decline in the tar concentration to 10 mg Nm⁻³, coupled with char conversion of 98% and an overall excellent gasification efficiency of 81% has been simulated, prompting further investment and investigation. The higher heating value of the product was found to be 6.4 MJ Nm⁻³.⁸⁷ This procedure is under development at pilot scale⁸⁷ with continued experimental work to improve the process.^{91,92} The main limitation is the intricate reactor set-up which may limit its scale-up possibilities.

The LT-CFB gasifier has two inter-connected stages with a circulating fluidized bed pyrolysis reactor operating at around 650 °C in the first stage and a bubbling FBG operating at 730 °C in the second stage for the gasification of char. This is shown in Fig. 7. A high residence time in this gasification strategy reduces the temperature required for char gasification. Sand and ash are used as the heat transfer medium, which takes the thermal energy from the lowest part of the gasifier to the pyrolysis reactor. Moreover, vaporized char in the form of gas is also redirected to the pyrolysis reactor. Char and sand are separated from the gas with the aid of the cyclone installed between the two reactors.

The process has already been tested in 100 kW_{th} and 500 kW_{th} units and a demonstration plant has been installed by DONG Company at 6 MW_{th} capacity, where the produced gas is co-fired with coal. This process was developed for challenging feedstocks such as pig manure, straw, sewage sludge, organic wastes, *etc.*³ The maximum calorific content of the exit gas employing pig manure as fuel, was reported as 7 MJ Nm⁻³ with a composition of 3.5% H₂, 16.3% CO, 4.3% CH₄ and 59% N₂. Thomsen *et al.*⁹³ found that low process temperatures are responsible for retention of alkalines in ash; however, the output gas contains high tar concentrations (>4.8 g m⁻³), making it less likely to be usable in most applications, without a cleaning step. This process has been found to be robust, cost effective and has low maintenance. It can be seen from the aforementioned multi-stage processes that higher char transformation and gasification efficiencies are achieved *vis-à-vis* single-stage biomass gasification, with an exception of the entrained flow gasifier, which is single-staged but has high oxygen requirements and limited biomass feedstock fraction allowed, as major limitations. However, the multi-stage process is significantly more complex and requires high capital investment.

Integration of distributed pyrolysis plants with central gasification plant. The strategy to employ pyrolysis and gasification at different locations was developed in Germany as the Bioliq



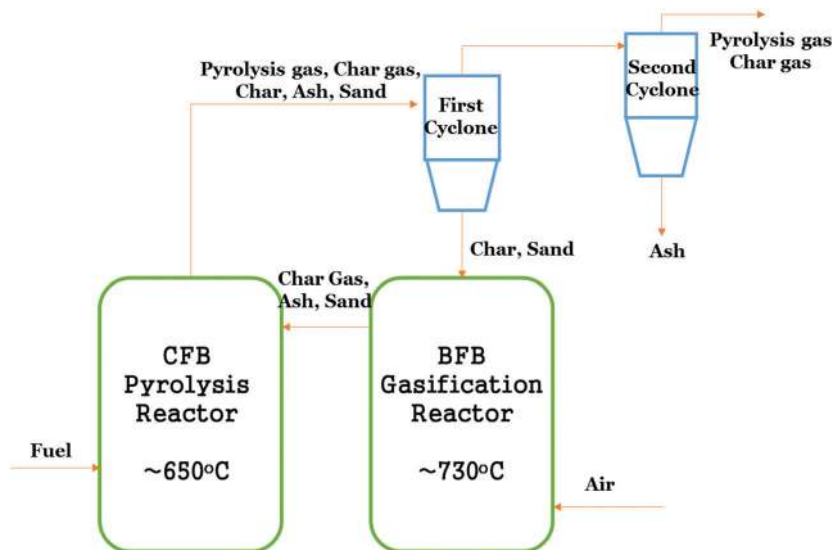

Fig. 7 Simple schematic diagram of LT-CFB gasifier.³

concept.⁸⁵ Here, biomass is treated in several pyrolysis plants in different locations and then the char-oil slurry produced is transported to the centralized BG unit, for gasification and bio-fuel synthesis. The main advantage of this strategy is its ability to use distributed, low-grade ligno-cellulosic biomass coupled with the cost-effective transportation of char-oil slurry instead of the biomass itself. Biomass with an energy density of about 2 GJ m^{-3} is upgraded to an oil-char slurry which has an energy density of about 25 GJ m^{-3} , which is equivalent to coal and easier to transport in tankers, for example. This enhancement in energy density is stated to make this process highly economical.⁹⁴ A flow diagram depicting the Bioliq concept is presented in Fig. 8.

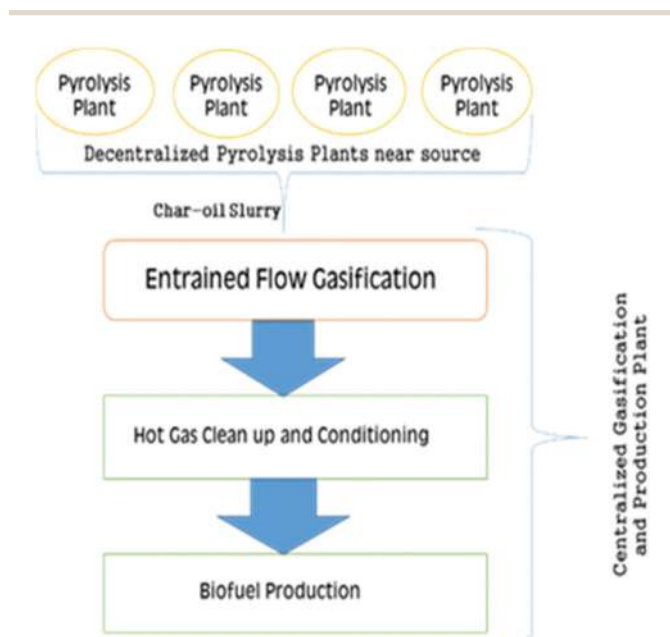

Fig. 8 Simplified scheme of the Bioliq concept.

A demonstration plant has been constructed in Germany employing 4 process steps: production of an oil-char slurry through pyrolysis at different locations, gasification of the slurry, clean-up of product gas and production of biofuel. Fast pyrolysis at $500 \text{ }^\circ\text{C}$ was selected for feedstock preparation for BG owing to its short reaction time and high yield.⁹⁵ The slurry is then gasified with oxygen as the gasifying medium to produce 5 MW_{th} in an EFG operating at $1200 \text{ }^\circ\text{C}$ with two pressure stages of 40 and 80 bar.⁹⁶ This type of slurry gasification is quite novel and has been associated with the experimental investigations of the char-oil slurry coupled with the modeling of the slurry.⁹⁷

Ceramic hot gas filters are installed to clean up impurities of the syngas such as alkalis, chloride, furfurals, phenols and sulphur at $800 \text{ }^\circ\text{C}$.⁹⁸ This is different from the conventional vertical hanging filters in a tube sheet in terms of design and position.⁹⁹ The horizontal design imparts compactness along with a reduced vessel size. Chlorides and sulphurous gas components are removed by sorbents such as CaO and ZnO. Tar is subsequently cracked in the presence of catalysts. Areas for research include the changes in the properties of char-oil slurry due to stand-time, and its effect on gasification.¹⁰⁰ Bio-oil derived from pyrolysis of biomass is a mix of furfurals, phenols with fractions of aldehydes, ketones, esters and ethers, and varying percentages of O_2 and H_2O , where O_2 makes up 35% to 40% and H_2O is 15% to 30%.¹⁰¹ Moreover, char-oil slurry from numerous locations is most likely to have varying composition, thus the need to test for stable atomization and uniform gasification for these slurries arises.

2.3 Special gasification techniques

Several special processes have been developed to convert different types of biomass into usable gas and/or heat and electricity.

2.3.1 Plasma gasification for toxic organic waste. Plasma is one of the fundamental states of matter and can be generated either by heating a gas or by exposing it to a strong



electromagnetic (EM) field. There are two types of plasma – thermal plasma and cold plasma. Thermal plasma is created at ambient pressure while cold plasma is produced in a vacuum. Thermal plasma is generally produced with gases such as argon (Ar), N₂, H₂, H₂O vapor or a gas mixture at a temperature of around 4700 °C or higher. In plasma gasification, AC or DC arc plasma torch generators are used.¹⁰²

Plasma is used in two different ways in the gasification process: (1) plasma is used as a heat source during gasification; (2) plasma is used for tar cracking after standard gasification. Primarily, plasma gasification is employed for the decomposition of toxic organic wastes, along with rubber and plastics, although the first reason and currently the main application for plasma gasification is the treatment of hazardous biomass waste. However, the technology has also gained interest for syngas production and electricity generation in recent years as the costs have entered into a commercially competitive range. A plasma gasification plant at Utashinai, Japan has been operating since 2002 and as of 2014, gasifies 268 tonnes of municipal solid waste per day and thus produces 7.9 MW h electricity.¹⁰²

Fig. 9 shows a plasma gasifier where the reactor chamber is connected to a non-transferred DC arc plasma torch generator.¹⁰³ Due to the very high temperatures produced it can be employed for toxic wastes, rubber and plastic treatment. Energy is simultaneously produced from the BG as mentioned above for the Japanese plasma gasification unit at Utashinai. Though this concept was originally designed for municipal and other waste treatment, it was later extended for high-quality syngas generation. At elevated temperature, gasification of feedstock occurs in milliseconds.¹⁰⁴

The main purported benefits of this process are syngas yield with high H₂ and CO content, improved heat content, low CO₂

yield and low tar content.^{105,106} The process is employed for wet biomasses such as sewage sludge which are otherwise difficult to gasify, and minor effect of particle dimension and structure of feedstock is noted. Major limitations are high construction and maintenance costs because of the high electricity consumption to generate plasma, resulting in low overall efficiency. For instance, a base case scenario with a 680 tonne per day waste gasification plant which would be appropriate for a small town or regional facility, would cost an estimated £97 million to construct, which is almost three times the cost of other waste treatment facilities (e.g. incineration).

Rutberg *et al.*,¹⁰⁷ Shie *et al.*¹⁰⁸ and Tang *et al.*¹⁰⁹ have investigated the plasma biomass gasification technique in detail. Plasma gasification of wood for combined heat and power was investigated by Rutberg *et al.*¹⁰⁷ They used alternating current air plasma with an input power of 2.2–3.3 MJ kg⁻¹ and produced syngas with a calorific content of 13.8–14.3 MJ kg⁻¹. It was proved by their calculations that there is a potential to achieve 46% net electric energy conversion.

Four different biomass feedstocks – wood sawdust, wood pellets, waste plastic and oil from pyrolysis of waste tires were studied by Hlina *et al.*¹¹⁰ in a DC electric arc plasma, with 100 kW torch input power. A small quantity of argon with H₂O vapor was used as the plasma gas with CO₂ or H₂O vapor as oxidizing medium. High-quality syngas comprising 90 vol% H₂ and CO was reported for all four kinds of feedstock. Despite having high heat content of exit gases recorded for all data sets, the process efficiency is low due to the high electricity input, which is largely the limiting factor for this technology.

Janajreh *et al.*¹⁰³ conducted non-stoichiometric chemical thermodynamic modelling for diverse biomass and compared conventional air biomass gasification with DC arc plasma gasification. Plasma gasification efficiency was stated to be 42% as compared to 72% for air gasification, on account of high energy consumption for plasma generation. Some researchers worked to decrease the high energy and investment requirements for DC arc plasma by employing microwave plasma, for carbonaceous biomass feedstocks.^{111–114} These investigations were performed at the lab scale ranging from 1–5 kW. Yoon *et al.*¹¹⁴ examined biomass gasification of glycerol from biodiesel production using a microwave plasma, and obtained an H₂-rich syngas (57% H₂, 35% CO), without any O₂ feed, with a carbon conversion efficiency of 80%. Feeding O₂ decreased the H₂ yield and the calorific content of the gas, with an increase in CO₂ content and carbon conversion. Almost the same findings were presented for coal and charcoal gasification.¹¹³ Plasma gasification has also seen some setbacks as a technology. One of the most recent was due to the City of Ottawa's decision to terminate its relationship with Plasco in February 2015, in spite of the company raising over \$300 million since 2005.¹¹⁵ It was unable to meet its commitment to successfully operate a 150 000 tons per annum plasma arc gasification unit. Currently, the gasification council website notes that there are functioning plasma gasifiers operating in Japan, Canada and India. Currently, Westinghouse Plasma Corporation also lists commercial operating facilities in all three countries, with a new 2000 tonnes/d MSW plant in commissioning in

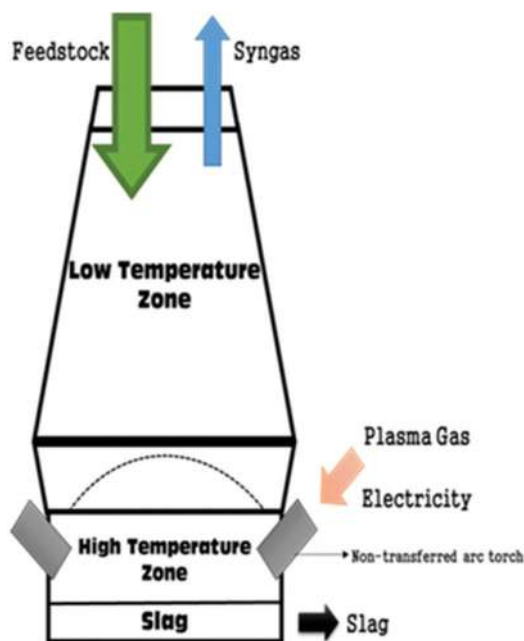

Fig. 9 Schematic of plasma gasifier.¹⁰³



Tee Valley, UK and when built this will be the largest plasma gasifier unit in the world.¹¹⁶

Currently, no commercial-scale H₂ production plant has been reported employing plasma biomass gasification. Significant research is required to decrease energy input and thereby enhance efficiency.

2.3.2 Supercritical water gasification (SCWG) for wet biomass. Water above its critical point ($T = 374.12\text{ }^{\circ}\text{C}$ and $P = 221.2\text{ bar}$) is termed as supercritical. Under these settings, the liquid and gas phases do not exist and supercritical water shows distinctive reactivity and solvency characteristics. Solubilities of organic materials and gases which are normally insoluble, are enhanced, with a decrease in solubility for inorganics. The properties of supercritical water lie between those of the liquid and gaseous phases. This unique property was found by MIT scientists in the mid-1970s and research on SCWG was initiated then. In the last decade, several developments were made and papers which examined both fundamentals and potential reactions along with the potential technical issues were published.^{117–119}

SCWG has been applied to wet biomass without the need for pre-drying, which is a major advantage over other more conventional gasification techniques. Numerous investigations on diverse feedstocks such as agricultural wastes, leather wastes, switch grass, sewage sludge, algae, manure and black liquor have been performed.^{122–127} Employing SCWG, even liquid biomass such as olive mill water can be utilized with the production of low-tar H₂ gas.¹²⁴ A simplified schematic of a SCWG setup is shown in Fig. 10.

Product gas from SCWG mainly comprises H₂, CO₂, CH₄ and CO. The CO yield is comparatively low as CO transforms into CO₂ through the water-gas-shift reaction.¹²⁷ Tar and coke formation are curtailed by rapid dissolution of product gas components in supercritical H₂O.¹²¹ Guo *et al.*¹²¹ and Feng *et al.*¹²⁸ found that above 600 °C, H₂ is the dominant component of the produced gas, since H₂O is a strong oxidant which reacts with carbon to release H₂ and CO, whereas CH₄ is the main component below 450 °C. Heating of H₂O to the reaction temperature necessitates a great amount of energy input. However, employing appropriate catalysts can lower the

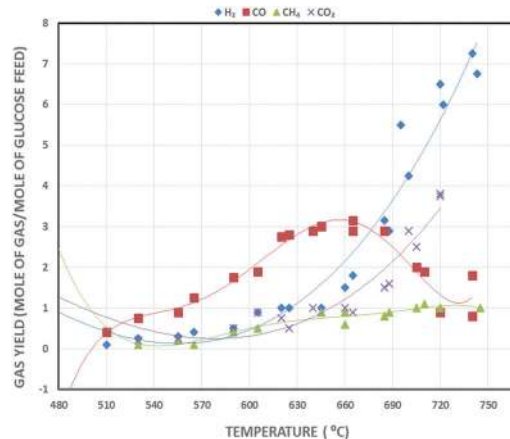

Fig. 11 Diagram showing the variation in product distribution vs. reactor temperature in SCWG.¹²¹

reaction temperature. This reduces the operational and equipment cost and increases conversion efficiency and H₂ production. This is depicted in Fig. 11. This graph shows different gas yields vs. temperature. It reflects that H₂ production enhances exponentially after 600 °C while CO increases from 500 to 660 °C and then decreases. CH₄ decreases to 540 °C and then remains almost constant even when temperature is increased.

A number of catalysts, such as Ni and Ru, activated carbon, Pt-based catalysts, and alkali metal-based materials such as Na₂(CO₃)(HCO₃)·2H₂O (trona), KOH, NaOH, K₂CO have been tested.^{121,129,130} Other investigators have also studied the energy efficiency of SCWG. Biomass gasification of vinasse (a byproduct of the sugar industry) in supercritical H₂O was modelled by Marias *et al.*¹³¹ They found a maximum efficiency of 87% at 600 °C. Lu *et al.*¹³² explained thermal losses during heat transfer at the heat exchanger, cooler, pre-heater and reactor, and demonstrated that these were responsible for the decrease in efficiency. Efficient heat exchangers may not be necessary if traces of O₂ are allowed, which have been stated would make the process self-sustainable energetically at the expense of a very small loss of exit gas heating value.¹³³

Wet biomass treatment without pre-drying, liquid biomass treatment such as olive mill waste water, high H₂ yield, high gasification efficiency and low tar formation are the main benefits of SCWG.¹²⁴ Major limitations include requirements of high-pressure- and high-temperature-resistant and rust-resistant materials, consequently increasing the investment costs, and high energy requirements. SCWG has been significantly improved since its initial conception and presents an interesting and possibly feasible technology especially for wet biomass but large-scale or commercial gasification requires further research.

2.3.3 Sorption-enhanced reforming (SER) and biomass gasification with CO₂ capture. In steam reforming of biomass, separation of H₂ from a product gas containing CO₂ and tar incurs large cost penalties. Therefore, a solution where the CO₂ and tar produced during steam reforming are simultaneously captured has significant potential to make the process more cost-effective.^{134,135} The primary method employs catalysts

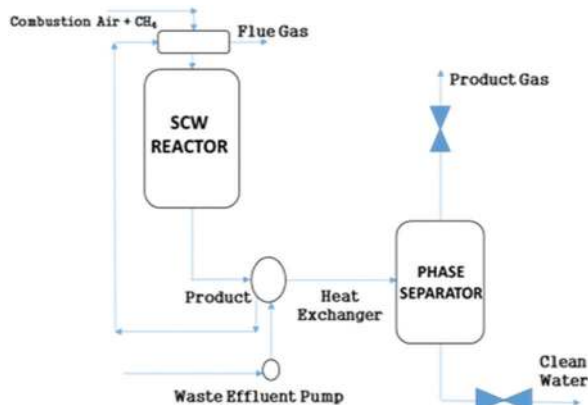

Fig. 10 Simplified schematic of SCWG.¹²⁰



inside the gasifier while the secondary method uses them downstream.^{136,137} Although the secondary method is more effective, the primary method has gained more attention on account of avoiding intricate downstream clean-up.¹³⁸

Calcium oxide (CaO) is now an almost established catalyst to yield H₂-rich product gas,^{39,139–142} because of its cost effectiveness and abundance,^{134,136,143} it has gained much attention. It acts not only as a sorbent but also as a tar cracker and heat carrier in FBG.¹³⁶ Removal of CO₂ during the BG process shifts the equilibrium of the product gas. This enhances the H₂ yield.¹⁴³ In the same manner, tar cracking increases the exit gas quantity, leading to high H₂ yield and conversion efficiency.^{144,145} Therefore, *in situ* CO₂ capture with CaO during the steam reforming of biomass for H₂-rich gas production is highly attractive and promising.^{146–151}

Since CaO captures CO₂ according to the carbonation reaction (7), it will lead to a reduction in the partial pressure of CO₂ under gasification conditions. This reduction in CO₂ partial pressure drives the water–gas-shift reaction (8) forward in accordance with Le Châtelier's principle. This leads to an increased yield of H₂.¹⁴⁷ Later CaO is recovered by calcination (9). The efficacy of the reaction is a subset of other parameters also, such as steam-to-biomass ratio (S/B), temperature, pressure, and the amount of CaO.

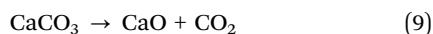
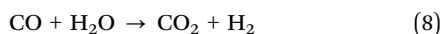
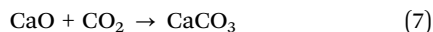

In situ CO₂ adsorption was studied by Pfeifer *et al.*¹⁵² in a dual FBG for H₂-rich syngas production. They compared adsorption-enhanced reforming (AER) using CaO as bed material with traditional BG without CaO. In AER, 75 vol% H₂ yield was reported with 0.5 g Nm⁻³ of tar at 600–700 °C whereas in the latter process, at 850 °C, 40 vol% of H₂ in the product gas with 2–5 g Nm⁻³ was found. Hence, high H₂ vol% with low tar content can be produced even at lower temperatures in the presence of CaO, thus making it a desirable choice for a sorbent in the steam reforming of biomass. AER has been studied by only a few researchers.^{152,153} Further research is required to explore different options to optimize energy efficiency.

A major limitation of using a CaO sorbent in steam-assisted BG is irregular H₂ production due to deactivation of CaO during the regeneration. Although CaO is potentially promising in tar reforming and CO₂ capture, the process would not be economically viable if the CaO could not be regenerated after the carbonation reaction. Consequently, the supply of CaO must be replenished.¹⁵⁴ In order to overcome this problem to some extent, calcium looping gasification (CLG) was introduced. CaO-assisted CLG was first employed in the CO₂ acceptor process, which was developed in the 1970s and terminated in 1977 after positive tests in a pilot plant.¹⁵⁵ CaO-assisted CLG consists of two reactors as shown in Fig. 12. Steam reforming of biomass takes place in the gasifier in the presence of CaO, which captures CO₂ and is converted to CaCO₃ *via* the carbonation reaction (7).

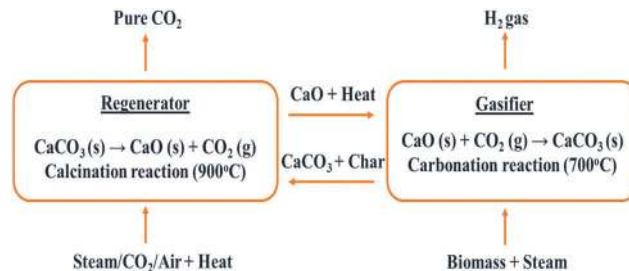

Fig. 12 CaO looping in SER.

This enhances the H₂ yield. CaCO₃ particles are circulated to the regenerator or combustor, where they are calcined back to CaO, with the production of a pure CO₂ stream (9), which can be sent for storage. CaO is recycled back to the gasifier along with the heat of calcination which it carries and aids in compensating endothermic reactions in the gasifier.¹⁴⁶ Therefore, this is a low-energy demanding and eco-friendly process of H₂ production with enhanced efficiency of H₂ production.

Several researchers employed this concept of CaO-based CLG.^{146,152,153,156} They used a bubbling FBG, circulating fluidized bed regenerator and a cyclone. The theoretical system efficiency was reported to be 87.49% with a 71 vol% H₂ yield. Moghtaderi *et al.*¹⁵⁶ found, using CaO from calcined feedstocks such as dolomite that CaCO₃ suffers from particle attrition and deactivation. They used construction and demolition waste (CDW) as sorbent and found high H₂ yields with low CO₂ in the product gas, with very limited attrition or erosion after repeated cycles.

3. Inputs and outputs

3.1 Raw material

Researchers and industry characterize feedstocks for thermochemical conversion in numerous ways. One of the simplest ways to classify them is as suggested by McKendry:¹⁶ timbered biomass, herbaceous biomass, marine plants and manures. We can further sub-categorize herbaceous plants into 2 classes – high-moisture-content plants and low-moisture-content plants. Generally, BG employs low-moisture waste to avoid the energy penalty in drying; woody biomass and herbaceous plants with low moisture contents are the primary choices because of their controllable moisture content. Biomass can also be classified as terrestrial biomass, marine biomass and waste. This classification along with sub-classification and significance is depicted in Table 4.

Biomass feedstocks in loose or powdery form with density less than 200 kg m⁻³ are also promising options as raw material for BG.²⁷ They include agricultural wastes such as bagasse, sugar cane trash, rice husk, rice straw, coir pith, groundnut shell, *etc.* Their calorific content varies from 12 to 16 MJ kg⁻¹ (dry basis) with bagasse on the higher end and rice husk on the lower end, with ash content up to 20%. However, pulverization is needed prior to their usage as feedstock to enhance their bulk density and to reduce transportation cost.



Table 4 Biomass classification, sub-classification and significance

Classification	Sub-classification	Examples	Significance
Terrestrial ^{16,178}	—	Forest biomass	Ideal for gasification due to high cellulose and hemicellulose percentages
		Grasses	Non-suitable for gasification due to high moisture. Suitable for fermentation
		Energy crops	Suitable for power generation through biological treatment
		Cultivated crops	Some crops are ideal for gasification while others are consumed directly by humans and animals
Marine ^{16,179,180}	—	Algae	Suitable for biological treatment because of high moisture content
		Water plant	Ideal for biological treatment
Waste ^{178,181,182}	Municipal waste	MSW, biosolids, sewage, landfill gas	Suitable for plasma or SCW gasification
	Agricultural solid waste	Livestock and manures, agriculture crop residue bark, leaves, floor residues	Most suitable for composting and other biological treatments
	Forestry residues	Demolition wood, sawdust, waste oil	Ideal for gasification albeit pre-treatment is required
	Industrial waste		Wastes like wood, sawdust are commonly employed for gasification. Others are used in biological treatments

Currently, sea and farmed algae have gained much attention for the generation of renewable biofuels on account of their carbon fixation potential and very high growth rate.¹⁵⁷ Furthermore, they can easily be cultivated in seawater or fresh water. Extensive investigations performed by Shirvani *et al.*¹⁵⁸ demonstrated that algae-based biofuels are more promising provided that mass production is employed. Several researchers have employed numerous varieties of micro algae such as *Spirulina*, *Chlorella*, *C. vulgaris*, *Tetraselmis Chuii*, *etc.* in gasification, pyrolysis, liquefaction and direct combustion. A significant volume of research related to thermochemical conversion (gasification,^{159–164} pyrolysis,^{164–167} liquefaction^{168–172} and direct combustion¹⁷³) of algal biomass has been published.

All biomass contains cellulose, hemicellulose and lignin in varying percentages, along with an inorganic component which is the source of ash. Cellulose is a straight-chain polymer comprising anhydroglucopyranose joined with ether bonds. Hemicellulose is an amorphous polysaccharide containing sugar units which are branched and have varied sugar types. Lignin is the most complex constituent with crosslinked 3-D polymer structure of phenylpropane units.¹⁷⁴

Proteins, starch and sugar may be extracted from biomass and separated by treatment with solvents followed by recovery through evaporation. Proteins perform diversified functions within living organisms, which include catalyzing metabolic reactions, replication and transporting molecules from one location to another.¹⁷⁵ Granulated sugars have multiple uses in the home. Starch is a vital component in food additives, paper making, clothing starch and corrugated board adhesives.¹⁷⁶ Table 5 shows the respective compositions of some commonly gasified biomass. Their relative lignocellulose composition plays an important role in the decomposition and energy conversion while undergoing gasification.¹⁷⁷

The cellulose, hemicellulose and lignin fractions present in biomass feedstocks degrade at different temperature ranges of 305 to 375 °C, 225 to 325 °C and 250 to 500 °C respectively during gasification.¹⁸⁵ The variation in these constituents in

Table 5 Composition of some biomass varieties^{183,184}

Type of biomass	Cellulose (%)	Hemicellulose (%)	Lignin (%)	Other (%)
Softwood	41	24	28	7
Hardwood	39	35	20	7
Wheat straw	40	28	17	15
Rice straw	30	25	12	33
Bagasse	38	39	20	3
Oak wood	34.5	18.6	28	—
Pine wood	42.1	17.7	25	—
Birch wood	35.7	25.1	19.3	—
Spruce wood	41.1	20.9	28	—
Sunflower seed hull	26.7	18.4	27	—
Coconut shell	24.2	24.7	34.9	—
Almond shell	24.7	27	27.2	—
Poultry litter	27	17.8	11.3	20
Deciduous plant	42	25	21.5	11.5
Coniferous plant	42	26	30	2
Willow plant	50	19	25	6
Larch plant	26	27	35	12

biomass raw materials yields products with different calorific values. Gasification of pure cellulose yields water-soluble tars in the early stages. Interestingly, this is in contrast to full biomass gasification where lower amounts of water-soluble tars are formed.³⁶ It seems that thermal polymerization of levoglucosan is inhibited along with the enhancement in light molecular weight species' formation from cellulose, by lignin during lignin-cellulose interactions in pyrolysis. Consequently, char yields and secondary char formation from lignin are decreased considerably as well as production of lignin-derived compounds (guaiacol, 4-vinylguaiacol and 4-methylguaiacol) are improved.¹⁸⁶

Lv and co-authors¹⁸⁷ studied the influence of cellulose-lignin during pyrolysis and gasification of biomass. They reported a swift reduction in mass on account of cellulose volatilization during pyrolysis followed by slow mass decrease because of lignin degradation. The rate of pyrolysis is directly related to cellulose fractions and inversely dependent upon lignin content in the feedstock. Tar yields and amount of gas produced were enhanced with a decrease in char, when the cellulose



fraction was increased during fast pyrolysis in FBG. Furthermore, a rise in gasification temperature and time was observed with increasing cellulose content, reflecting the significance of cellulose-lignin interactions during BG.

Extensive investigations performed by Azadi *et al.*¹⁸⁸ regarding lignin gasification proved that the ultimate products ($\text{CO} + \text{H}_2 + \text{CO}_2 + \text{CH}_4$) are similar to those formed during gasification of other biomass feedstocks. Ash and H_2S are also included in the products *via* lignin gasification on account of the presence of sulphur and inorganics induced during fractionation from biomass, depending on the treatment method.

In general, the higher the cellulose and hemicellulose content, the greater the volume of gaseous products formed. Therefore, softwood, hardwood, wheat straw and bagasse with much higher cumulative percentages of cellulose and hemicellulose are preferred over sunflower seed hull, coconut shell, almond shell, larch plant or poultry litter, when attempting to obtain gas as the final product. This makes the selection of an appropriate feedstock for the desired products a vital consideration (as shown in Table 5).

Other important constituents are silica (fouling and slagging and ash disposal issues), chlorine and sulphur (acid gas mitigation) and alkali metals (slagging, fouling and high-temperature corrosion concerns).

Many researchers have conducted extensive investigations into the effects on H_2 yield through non-catalytic BG of different biomass types using FBGs and UGs. Previous research has shown that in general, H_2 production from gasification of biomass varies between 10 to 65 vol%.^{39,189–195} It is, however, difficult to assess whether the alterations are caused by the variety of biomass, type of gasifier or its operating parameters.

Characterization of feedstock is a prime factor in gasifier selection. Generally, woody biomass has an ash content below 2% and hence it is appropriate for use in a FXBG.¹⁹⁶ This is because high-ash-content feedstocks are prone to agglomeration in FXBG during gasification, leading to a drop in conversion efficiency and possible reliability issues. An updraft-fixed-bed gasifier (UG) yields a product gas with high tar and high-volatile-content raw material, which is unsuitable for many high-purity applications like fuel cells and engines. Therefore, a DG is more fitting in this case, as simple cleaning of the outlet gases would make it practical for operation in engines. In the case of sawdust, DG can generate large tar yields, with a large pressure drop within the reactor.⁹ Agricultural residues such as coconut shells, maize cobs, palm kernels and other shells are commonly used as a biomass feedstock for BG, especially in under-developed countries where these materials are readily available. They are unlikely to create any problems in FXBGs. Fibrous feedstocks, such as coconut husks and empty fruit bunch are reported to create spanning problems in the feeder section, thus usually require pretreatment prior to gasification. Spanning means the material matts together because of the needle-like structure of the biomass, thus spanning and blocking the entrances to processing sections. Pretreatment can involve torrefaction or densification to avoid this problem.

Most herbaceous biomasses have high ash content and cause slagging problems in DG.¹⁹⁷ Ash fouling during gasification is a function of gasifier operating temperature. It is observed that a low amounts of ash are released between 100 to 500 °C while ash emissions rise sharply beyond 600 °C.³⁶ Slagging occurs because of the low melting temperature of the ash. Ca, Mg, K and Na silicates are often found to have lower melting temperatures. With temperature rise, SiO_2 content is found to increase. When the alkali species evaporate, they can form eutectic mixtures with SiO_2 , resulting in slagging. Low-temperature operation of the gasifier (below the flow temperature of ash) or elevated-temperature operation (above the melting point of ash) can minimize slagging to a considerable extent.⁷ Of course, some gasifiers, such as the British Gas/Lurgi slagging gasifier, require slagging to occur, with the slag forming a protective coating on the gasifier wall. In this case, the viscosity of the slag is equally significant. Ash can also be mixed with cement or concrete as pozzolanic material, which can decrease the consumption of cement/concrete as well as lighten the burden on landfill.¹⁹⁸ In addition, it can positively aid in environmental conservation by reducing energy consumptions and GHG emissions of cement/concrete manufacturing plants.

Numerous indices have been published which relate slagging propensity to the fuel's elemental structure. Amongst these indices, one in particular has been quoted in a number of publications.^{199–201} This is the alkali index, which is the ratio of the alkaline components of the fuel ash ($+\text{Fe}_2\text{O}_3$) to the acidic compounds (in this case, for a fluidised bed). The greater the alkali index, the higher would be the tendency of the fuel to cause agglomeration of the bed. However, the use of any single index is not recommended, given the potential complexity of the components present, and tests of slag properties for different materials possibly utilized are always recommended.

3.2 Syngas

Biofuels synthesized from syngas have been exploited in many households for daily applications such as cooking food, heating water and lighting. The energy which can be produced annually from biomass is potentially three or four times greater than the worldwide energy demand.²⁰² Huber *et al.*²⁰³ and Rajagopal *et al.*²⁰⁴ found that thermochemical paths like pyrolysis and gasification can convert non-edible biomass feedstock into syngas, as depicted in reaction (10). The syngas can be further transformed into bio-synthetic natural gas (Bio-SNG) through methanation reactions (11) and (12) or transformed into liquid hydrocarbons (HC) *via* other processes.²⁰⁵ Syngas contains 30–60% CO , 25–30% H_2 , 5–15% CO_2 , 0–5% CH_4 and traces of water vapor, H_2S , ammonia (NH_3) and others, depending on the feedstock variety and operating variables.²⁰⁶



Wan *et al.*²⁰⁷ found that the carbon conversion rate of woody biomass to syngas is around 92%, 71% for H_2 conversion with a total energy conversion efficiency of 62%, post syngas clean-up. Syngas yield is about 1.2 Nm^{-3} per kg of wood. Biomass which is low in ash content is generally employed for syngas production,



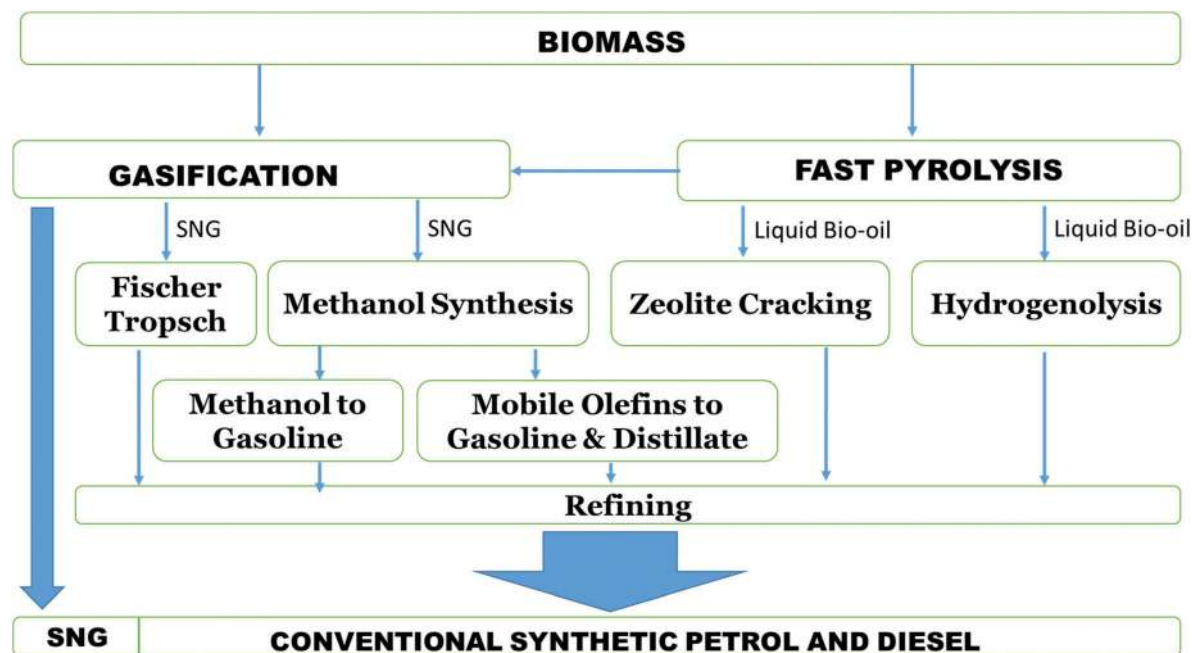
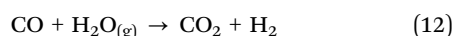
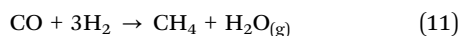

Fig. 13 Biomass gasification and pyrolysis routes to synthetic biofuels.²⁰⁸

because high ash content causes slagging. This is a problem encountered when herbaceous feedstocks are used. Still, rice husk is frequently used in gasification all over Asia due to its easy availability.

Bio-SNG is produced by syngas methanation at elevated temperatures of 800 °C to 1000 °C as shown in reactions (11) and (12). The conventional gasification processes employ these reactions.²⁰⁸ One of the important benefits of Bio-SNG is its high octane number which is appropriate for spark-ignition (SI) engines. On the other hand, the low cetane number renders it unsuitable for compression-ignition (CI) engines.^{209,210} At ambient conditions, Bio-SNG is present in the gaseous phase so it needs to be compressed and liquefied.



Syngas can be directly transformed to liquid HCs such as diesel and kerosene fuels and/or gases *via* a number of distinct processes, leading to a variety of bio-fuels.²⁰² These transport fuels include bio-alcohols such as methanol, ethanol, heavy straight-chain alcohol mixtures and liquefied gas such as DME.²⁰⁸ DME shares the same method of production as bio-methanol, albeit it can also be produced *via* catalytic dehydration of bio-methanol. It finds significant applications such as diesel substitute and cooking.^{211–213} Fig. 13 shows the different pyrolysis and gasification routes taken to produce bio-fuels.

Interestingly, it is possible to produce SNG (a mixture of H₂, CH₄, CO and CO₂) at low temperatures (250 °C to 400 °C) without producing tars. This is achieved by gasifying feedstock under the influence of catalysts and within supercritical water in a process known as SCWG.^{205,206} This method is especially

applicable for wet biomasses which are otherwise unsuitable for conventional biomass gasification. Unfortunately, there are several issues related to this process: high energy requirements, wet biomass feeding problems and drop in gasification efficiency with a rise in dry content in the feedstock.²¹⁰

4. Parametric impact

There are many parameters which have a significant impact on the product quality during biomass gasification. They include the following:^{13,57,60,214–216}

- Feedstock type, quality and inherent moisture content
- Particle size and density
- Operating conditions
- Steam-(or other gasification gas)-to-biomass ratio (S/B)
- Air equivalence ratio (ER)
- Catalyst
- SER – sorbent-to-biomass ratio

4.1 Feedstock and moisture content

The most prominent constituent of biomass is lignocellulose, which consists of the non-starch, fibrous part of plant material. Cellulose, hemicellulose and lignin are the three main elements of biomass. These constituents play an indispensable role during thermochemical conversion processes such as BG.^{16,217} Normally, in a typical biomass, the cellulose-to-lignin ratio varies from 0.5 to 2.7 and hemicellulose-to-lignin ratio ranges from 0.5 to 2.0. The proportion of cellulose and hemicellulose are directly related to the gaseous products yield, while the lignin content determines the oil in the product. Therefore, the higher the ratio of cellulose and hemicellulose to lignin in a given biomass, the higher the gaseous product yields from gasifying it.

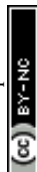

Predominantly, two types of moisture content are taken into consideration in a biomass feedstock, namely the intrinsic moisture, which is the water content of the material without taking the impact of weather into account; and the extrinsic moisture, which incorporates the influence of weather conditions. The characteristics of the exit gases and optimal operation of the gasifier depend on the moisture content to a significant extent. Woody and low-moisture herbaceous biomasses contain less than 15 wt% moisture. This makes them more suitable for thermal conversion, since most gasifiers are designed to accommodate biomass feedstock with a moisture content of 15–30 dry wt%. The problem with high moisture content is the energy penalty associated with drying the biomass before gasification.

For every kilogram of moisture in biomass, at least 2260 kJ of extra energy is needed to evaporate the water and that spent energy is not readily recoverable.⁹

The moisture contents of some biomass varieties are shown in Table 6. It can be clearly seen that fir, Danish pine, rice husk, and wheat straw are preferred over rice straw, food waste, cattle manure, and water hyacinth for BG, on account of the low moisture content. The low moisture content is favorable since it has a lower energy penalty in the drying process prior to gasification.

Researchers found that as the biomass storage time increases so does its moisture content. This is a common notion; however, its moisture can also be decreased depending upon the type of seasoning adopted prior to its use as a biomass fuel.²¹⁸ Therefore, in almost all cases, by the time feedstock enters the gasifier, the moisture content is likely to be higher than the reported or supplied value. This is something that has to be accounted for in the design of the reactor.^{214,219} Updraft fixed bed gasifiers can tolerate a maximum moisture content up to 60% (wet% basis) whereas downdraft gasifiers can work efficiently with feedstock containing a maximum 25% (wet% basis) moisture.⁹ Usually, drying is done prior to gasification to counter this problem. Schuster *et al.*²²⁰ established that a feedstock with more than 30 wt% moisture adversely affects

the process temperature resulting in less gas produced, which also has a higher tar content. They concluded that biomass moisture content has a secondary but still significant impact on the thermal, chemical and overall efficiency of the BG process. It is, therefore, crucial that the actual moisture content is accounted for while calculating the steam-to-biomass ratio.

4.2 Particle size and density

Researchers have established the direct impact of feedstock particle dimensions on the product gas yield.^{37,39,147,192,221,222}

De Lasa and co-authors³⁶ argue that temperature and particle heating rate have a vital influence on weight loss of biomass during BG. Fluid-particle heat transfer is excellent in the particles of smaller dimensions. More controlled gasification is achieved if temperatures remain uniform throughout the feedstock particle. In addition, rate of gasification is enhanced exponentially, according to the Arrhenius rate law, with increasing temperature only when internal kinetics control the gasification process.

It is observed that residual char yield is higher on account of incomplete pyrolysis due to higher heat transfer resistance offered by larger particles.²²³ Enhancement in carbon conversion and amount of H₂ was reported when the particle dimension was reduced.²²⁴ Furthermore, a decrease in particle size improves syngas efficiency and decreases tar yields.^{225–227} However, it should be noticed that particle size should not be smaller than that needed, as particle size reduction requires intense energy.³⁶ Downdraft and updraft fixed bed gasifiers are less sensitive to particle size (<51 mm) than are entrained flow gasifiers, owing to the longer particle residence times within them. Entrained flow gasifiers should have particle sizes of up to 0.15 mm maximum.²²⁸ Fluidized bed reactors have an intermediate tolerance of less than 6 mm for feed size.⁹

Normally biomass feedstocks have low density with a porous structure. Kirubakaran *et al.*²²⁹ suggested that the interactions between reactants and products occur *via* non-restricted molecular transport. In addition, the low density of feedstock due to the presence of numerous pores results in uniform temperature throughout the particles, which in turn manifests in homogeneous gasification and uniform product composition. In dense biomass raw materials, temperatures vary from the exterior to the interior of the pellet, resulting in simultaneous drying, pyrolysis and gasification. Consequently, a non-homogeneous gas composition is obtained.

4.3 Operating conditions

The partial pressure of the gasifying agent, temperature and heating rate within the gasifier are other vital parameters which have the potential to influence the exit gas yield and overall biomass conversion.^{36,221,230–236} Partial pressure of the gasifying agent has a direct relationship with the reactivity of biomass char while an increase in temperature generally increases the heating rate of the feedstock particles by providing a greater temperature difference. Normally, the reactor pressure in EFG is between 20 and 70 bar.⁹ It has been shown that a faster heating rate leads to greater gas production and

Table 6 Moisture content of some biomass species^{16,178}

Type of biomass	Moisture% (wet basis)
Water hyacinth	95.3
Dairy cattle manure	88.0
Rice straw	50.0–80.0
Food waste	70.0
Corn stalks	40.0–60.0
Willow	60.0
Wood bark	30.0–60.0
Bagasse	45.0–50.0
Poplar	45.0
Saw dust	25.0–55.0
Wheat straw	8.0–20.0
Switchgrass	13.0–15.0
RDF pellets	25.0–35.0
Rice husk	7.0–10.0
Miscanthus	11.5
Danish pine	8.0
Fir	6.5



less tar production. Furthermore, a slower heating rate can actually lead to lower gas yields and higher tar yields. These two heating rate operations largely influence the design of the gasifier and the desired product. The slower heating rate leads to a higher tar production rate owing to the recombination of lower-volatility hydrocarbons on the surface of the char particles. In addition, a higher temperature can lead to an increase in the degradation of the tars by transforming them to the product gases. This is caused by the volatilization of the active components of tar. The Boudouard reaction (13) and the thermal cracking reaction (14) effectively degrade residual char and tar when the temperature is increased.²³¹ Therefore, maintaining a high temperature can contribute productively for BG when product gas is the desired product. Reactor temperature in fixed bed gasifiers is normally around 1100 °C, although UG requires more time to reach the working temperature than DG. Temperatures in FBG are normally kept below 1000 °C to avoid ash fusion and agglomeration. EFG works at an elevated temperature of greater than 1900 °C.⁹

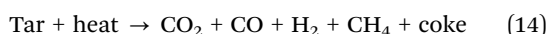
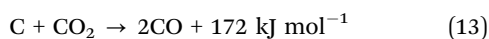

4.4 Steam-to-biomass ratio (S/B)

The ratio of steam to biomass is an influential parameter that affects the input energy requirements, outlet gas quality and product yields. Low S/B ratios result in higher amounts of char and CH₄ whereas increasing S/B positively enhances the reforming reactions by providing an oxidative environment, thereby raising the oxidized product gas yield.¹⁵

Increasing S/B results in a higher H₂ yield and therefore the syngas has high calorific content. It also produces a low amount of tar. This is due to water gas shift, reforming and cracking reactions.²³⁷ Sharma *et al.*²³⁸ demonstrated an existence of threshold limit beyond which any increase in S/B produces excess steam in the syngas. Energy contained in the excess steam along with enthalpy losses in generating this steam, result in reducing process efficiencies. It also negatively influences the temperature inside the gasifier which in turn results in low tar cracking. Such issues necessitate identifying an optimum S/B in steam biomass gasification. Usually fixed bed gasifiers have the highest capacity for S/B followed by fluidized reactors and entrained flow gasifiers.⁹

4.5 Air equivalence ratio (ER)

The ratio of actual air provided to stoichiometric air needed for the process is known as air equivalence ratio (ER) and is one of the important parameters in gasification. Narvaez *et al.*²³⁷ observed that H₂ and CO fractions in syngas are inverse functions of ER. Higher ER results in lower H₂ and CO yields, with an increase in CO₂ amount. This reduces the calorific content of the product gas. On the other hand, a high ER aids in cracking tar on account of higher O₂ availability for volatile species to react with. However, a negligible effect of ER was reported on nitrogenous products, during gasification.

Zhou *et al.*²³⁹ demonstrated a small rise in NH₃ yield when ER is increased from 0.25 to 0.37 at 800 °C, employing saw dust as feedstock. Bed temperature has a positive impact and increases linearly with ER provided feeding-rate is kept constant.³⁶ ER is also influenced by the amount of moisture and volatiles present in the feedstocks.^{240,241} A moisture content up to 15% results in an increase in ER and gas amount but the presence of moisture above 15% causes irregular temperature variations. A high volatile fraction in biomass feedstock produces higher tar yield.

Gasification takes place in an air-deficient environment.⁹ In downdraft gasifiers, ER ~ 0.25 gives an optimal product gas yield. A lower ER results in incomplete char-to-gas conversion and hence is desirable in the case of charcoal as a final product.²⁴² In FBG, efficiency is enhanced with the value of ER ~ 0.26 due to high combustion heat, and then declines. The same reasoning holds for higher bed temperatures in FBG. In practical scenarios, an optimum value of ER ~ 0.2–0.3 is desired. If it is less than 0.2, it results in incomplete gasification and hence, more char formation, with a low-calorific product gas, while higher ER will alter gasification into combustion at the cost of overall efficiency.^{243–246} Oxidant requirement is highest in entrained flow gasifiers (usually 20% higher).⁹

4.6 Catalysts

Catalysts ease the thermal and mass transfer resistance through the particles while providing an alternative lower-energy pathway for the reaction to proceed and, hence, they play an important role in BG. Many researchers have found a positive impact of using catalysts to promote the gasification and reformation of the products. Catalysts can be employed *in situ* or after gasification reactions.⁹

Some of the types of catalysts that have been studied are alkaline (predominantly Na and K) metal, alumina and zeolites, dolomites and limestones, Ni-based, Zn-based, as well as some other exotic and rarer metals such as platinum- and ruthenium-based materials. Alkaline metal oxides, dolomite and Ni-based catalysts have a favorable effect on gasification extent because of their ability to promote the reformation reactions.¹⁸⁹

Alumina silicates are found to be more effective at enhancement of char gasification, whereas Ni-based catalysts are more effective at the conversion of lighter hydrocarbons.²⁴⁷ Still, advancement to more efficient and economical catalysts is under progress, with the aim being to enhance the quality and yield of the desired product while minimizing the residual char and tar.^{58,63,137,247–249}

4.7 SER – sorbent-to-biomass ratio

Olivares *et al.*,⁵⁸ amongst others, classified biomass as a carbon-neutral fuel, since it has already captured CO₂ while growing. They further stated that it can be a carbon-negative fuel, if the CO₂ produced is captured and stored, during gasification of biomass. Researchers have studied many materials, including aluminum oxide, dolomite, metal-based sorbents, Ni-based sorbents and rhodium, for their role as sorbents in biomass gasification.^{13,139,147,148,250–260}



Table 7 Tar classification

Basis of classification	Nomenclature	Compound name	Example	Temperature of formation
Appearance ²⁶⁶	Primary	Oxygenated compounds	Syringols, furans	400–700 °C
	Secondary	Aromatic compounds	Phenolics, olefins	700–850 °C
	Tertiary	Complex aromatic compounds	Toluene, indene	850–1000 °C
	Class-I	GC-undetectable tars		
	Class-II	Heterocyclic compounds	Phenol, cresol	
Molecular weight ^{266,267}	Class-III	1-Ring aromatic compounds	Xylene, toluene	
	Class-IV	2–3-Ring aromatic compounds	Naphthalene, phenanthrene	
	Class-V	4–7-Ring aromatic compounds	Fluoranthene, coronene	

Investigators found that solid sorbents have a better efficiency for CO₂ capture during BG in comparison to liquid sorbents.^{147,250} CaO has also been suggested as a good choice.^{253,256,260} Harrison *et al.*^{261–263} and other researchers¹⁵ established the basic idea for the usage of sorbent is that it removes CO₂ from the gasification reactions thus shifting the equilibrium, which in turn enhances H₂ yield. Therefore, usage of a suitable sorbent in steam gasification of biomass is desirable provided it does not hamper the economic considerations.

5. Tar

Tar is a significant potential problem in the gasification of biomass as it can lead to equipment blockages, increased maintenance and makes operation difficult. It is usually a thick, dark-coloured liquid with a low condensation temperature and hence can lead to blockages in downstream equipment. In particular, light-(C_{2–6}) hydrocarbons can actually avoid condensation and instead form tarry aerosols, which in turn degrade the quality of outlet gas and potentially make it unsuitable for use in high-purity applications, *e.g.*, applications other than boilers.^{17,264,265} The approximate weight percentages of key components of tar are listed here: benzene (38%), toluene (14.5%), single-ring aromatic HCs (14%), naphthalene (9.5%), dual-ring aromatic HCs (8%), heterocyclic compounds (6.5%), phenolic compounds (4.5%), triple-ring aromatic HCs (3.5%), quadruple-ring aromatic HCs (1%), and other compounds in trace amounts.

One standard classification of tar is by molecular weight.²⁶⁶ The classes are presented in Table 7.

Different gasifiers with different desired products can lead to a diverse tar yield and relative component concentrations. Basu *et al.*¹⁷ reported that by average tar production, the order of reactor types was EFG (~0.4 g Nm⁻³) < DG (<1 g Nm⁻³) < FBG (10 g Nm⁻³) < UG (50 g Nm⁻³). As a reference, fuel cells have minimum tar tolerance less than 1 g Nm⁻³ and gas turbines have a tolerance between 0.05 and 5 g Nm⁻³. Furthermore, internal combustion engines can endure a tar concentration of up to 100 g Nm⁻³ and compressors can bear up to 500 g Nm⁻³. There is no limit on tar presence if the fuel gas is used for direct combustion (*e.g.* in a boiler), provided the gasifier outlet and burner inlet do not allow the gas to cool down below the dew point of tar. However, flue gas produced after burning should be in accordance with the local emission standards.

Tar minimization methods are classified as primary or secondary depending upon the location of tar removal. Tar degradation methods are also divided into mechanical, thermal, catalytic, self-modification and plasma.²⁶⁷ Modelling of tar will not be presented in great depth within this review but for more information the reader is recommended to consult the work by Font Palma *et al.*¹⁸⁴ who gave a detailed review of tar modelling.

5.1 Tar production

During the heating of biomass, the order of mass loss is as follows: first, moisture evaporation takes place from 30 °C to 120 °C, followed by hemicellulose breakdown between 150 °C to 220 °C, lignin breakdown around 220 °C to 400 °C and cellulose being the most stable around 315 °C to 450 °C. Lignin degrades over the widest range due to the diverse range of chemical structures and bonds present.²⁶⁸ Devolatilization and biomass conversion can occur across a range of temperatures for different kinds of biomass; this is commonly investigated using thermogravimetric analysis (TGA).

Zhang *et al.*²⁶⁹ conducted experiments with sawdust to analyze pyrolysis, gasification and oxidation conditions, and found that pyrolysis at 600 °C produces primary tars whereas pyrolysis and gasification yield secondary and tertiary tars at around 900 °C to 1000 °C. They also found substantial tar degradation during pyrolysis, steam gasification and oxidation above 1100 °C. During pyrolysis, dehydrogenation of cellulose, hemicellulose, lignin and carbon gasification generate H₂ as shown in (15). Condensable volatile gasification is shown in (16) and water–gas–shift is shown in (17).

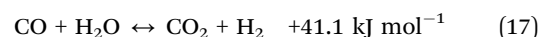
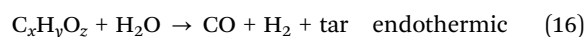
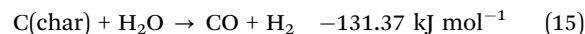

where, C_xH_yO_z represents tar species in the intermediate phase, which eventually decompose to generate gases and final tars. Partial combustion reactions are depicted in (18) and (19).

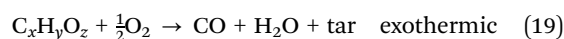
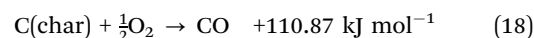

Reactions (20) and (21) are endothermic in nature so their reaction rate increases above 1000 °C, reflected by the increase in CO production. In pyrolysis and gasification, above 900 °C,



secondary degradation of light HCs and some tar species is the major reason for coke formation as depicted in reaction (22).

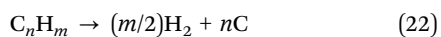
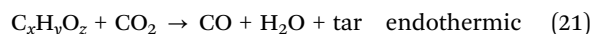
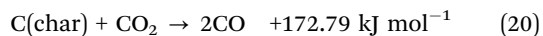

Therefore, the carbon conversion rate is very significantly enhanced above 1000 °C and 1100 °C, with a drop in coke and CO₂ yield and an increase in CO and H₂ generation. This reflects the significance of understanding the pyrolysis reaction mechanisms of tar precursors when attempting to predict tar degradation during biomass gasification.

Lignin is an intricate and vastly cross-branched polymer of phenylpropane linked to other smaller chemical constituents. Water, phenolics and gases are the common groups produced during lignin decomposition.^{270,271} However, it is uncertain whether they are derived from the original structure or if they are the result of reactions with previous products or other reactant gases added into the system.

Cellulose is also a primary constituent of plant cell walls' structure and is responsible for primary tar compounds. These compounds from cellulose degradation apart from levoglucosan, can include furfurals, hydroxyacetone and organic acid.²⁷² Hemicellulose is the least stable constituent among all the others in biomass; it degrades faster and at a lower temperature.²⁷³ Xylan is the main hemicellulose component of hardwoods and softwoods and its degradation yields acids, phenols, aldehydes, ketones and esters with small amounts of other carbohydrates also produced.²⁷²

5.2 Tar measurement and development

Analytical approaches have been evolved over the decades to define the composition of biomass, such as fractionation of biomass samples followed by quantification of isolated and purified fractions. Although these conventional methods are validated by the American Society for Testing and Materials (ASTM), they are time consuming and costly and, therefore, are not frequently applied in commercial applications.^{175,184}

Over the past few years, analytical techniques such as Near Infrared (NIR) spectroscopy, Thermogravimetric Analyses (TGA) coupled with spectrometers, and TGA coupled with Differential Thermogravimetric Analyses (DTG) have been employed to quantify isolated fractions obtained from the fractionation of biomass samples. These methods offer an advantage over the traditional methods as they are cheaper, precise and rapid.¹⁷⁵

5.3 Tar minimization

Fundamentally, tar minimization is divided into two different classifications depending upon the location where tar is deposited. If tar is degraded inside the gasifier it can be referred to as primary tar reduction, which requires an appropriate selection of functional parameters discussed earlier such as the design of the gasifier and the use of catalysts during gasification. Secondary methods include thermal, mechanical or catalytic

cracking of tar in a separate step after BG where the tar is deposited further downstream.²⁶⁴

Self-modification can reduce tar to a considerable extent just by varying operating parameters. Luo and co-authors²²⁴ have explored the significance of particle size on tar formation through extensive experimental investigations. They employed pine saw dust of variable particle sizes in a fixed bed gasification system. Higher amounts of dry gas and improved carbon conversion with lower tar yields were observed with smaller particles at the same temperature on account of enhanced thermal conductivity. Smaller particles (<0.075 mm) produced low tar (0.4%) whereas particles with 0.075 to 0.6 mm sizes generated higher amounts of residual solids and tar, at 700 °C. The largest particles with 0.6 to 1 mm sizes gave maximum char and tar yield (> 10%) even at an elevated temperature of 900 °C. This can be explained on the basis of heat transfer. Gasification is kinetically controlled with smaller feedstock particles, while larger particles offer resistance to thermal conductivity leading to incomplete devolatilization and higher tar yields.

Mahapatra *et al.*²⁷⁴ evaluated the influence of surface area-to-volume ratio of biomass raw material in a packed bed gasifier. They concluded that a larger surface area-to-volume ratio leads to a higher pyrolysis rate which results in increased amounts of higher molecular weight compounds as fast pyrolysis products.

It should be noted that closed-top fixed bed gasification systems generate higher tar yields as compared to open-top fixed bed systems. Elaborate tests were performed in a collaborative India-Switzerland project and it was demonstrated that open-top gasification systems produce the lowest amount of tar and particulates *vis-à-vis* other gasification systems.²⁵ It is on account of the establishment of front moving propagation toward the top end of the gasifier due to dual air entry from the top and nozzles. This ensures higher residence time for gases at high temperatures and degradation of higher molecular weight species.

With reference to the secondary tar removal and destruction strategy, tar minimization is categorized in numerous ways²⁶⁷ as presented in Table 8. Mechanical methods are further sub-classified into dry gas cleaning and wet gas cleaning. Dry gas cleaning removes tar from the product gases using cyclones, rotating particle separators and a variety of filters. Wet methods employ electrostatic precipitators, wet scrubbers, solvent extraction and wet cyclones. Wet treatment of the gases also requires treating of the collected waste H₂O from the gas treatment system.²⁷⁵ Tar yield is an inverse function of the operating temperature.²⁷⁶ An inverse relationship is also reported between the tar yield and equivalency ratio. Knight *et al.*²⁷⁷ provided evidence experimentally with wood chips in a FBG which suggested that an increase in pressure from 8 bar to 21 bar degrades oxygenated components like phenols into PAHs.

Other methods of minimizing tar production include plasma gas cleaning and thermal methods, as discussed in the earlier section – Emerging approaches. Plasma gas cleaning can be employed to minimize both tar and particle quantities. Nair *et al.*²⁷⁸ found that the naphthalene content was reduced by half with 40 J L⁻¹ of corona discharge at 400 °C over 3 minutes.



Table 8 Post-combustion tar elimination methods

Method	Sub-classification	Technique used	Details/examples
Mechanical method ²⁷⁵	Dry	Usage of mechanical device or equipment	Cyclone, rotary partial separator, fabric filter, ceramic filter, activated carbon adsorber, sand bed filter
Self modification method ²⁷⁶	Wet	Usage of mechanical device or equipment Alteration in gasifier design and operational variables	Electrostatic precipitator, wet cyclone, wet scrubber Appropriate operating parameters like temperature, pressure, equivalence ratio, gasifying media, biomass types along with gasifier design are selected
Thermal cracking ^{267,279}		Application of high temperature with residence time	Maximum tar destruction was found at 1250 °C and 0.5 s
Catalytic cracking ²⁷⁵		Usage of appropriate catalyst	Tar cracking catalysts are divided into 5 major groups, namely Ni-based, non-Ni-based, alkali metal-based, acid catalysts, basic catalysts and activated carbon-based catalysts
Plasma method ²⁷⁸		Application of high energy corona discharge	—

The thermal method uses cracking of tars into lighter HC gases by employing high temperatures. Fagbemi *et al.*²⁷⁹ showed that at high temperatures the products which are mainly char are transformed to gases and, therefore, it is easier to determine a residence time. Then using this residence time, a reactor can be built to maximize the overall conversion. This does, however, lead to greater char production in the process of tar removal.

Most of the work for tar minimization has been done in the area of catalytic cracking of the tar because of the multiple advantages of catalytic degradation compared to the alternatives previously mentioned.^{61,66,280–283} Catalytic cracking, decomposition and reforming of biomass can enable a near-complete elimination of tars. Catalysts are able to degrade comparatively stable compounds such as aromatics and PAHs. Catalysts within the gasifying reactor not only minimize tar to a significant extent but they also enhance the quality, quantity and heat content of the produced gas. The most commonly applied catalysts are Ni-based (on Al₂O₃ or SiO₂ or dolomite, *etc.*), alkali metal-based (K₂CO₃), basic catalysts (MgO, CaO, *etc.*), acid catalysts (zeolite, silica–alumina, *etc.*) and activated carbon.²⁷⁵ Nickel-based catalysts are usually used when syngas or H₂ is the desired output. Ni is characterized by high catalytic activity for the reformation reactions but its resistance to sulphur poisoning, sintering and carbon deposition strongly depends on the support material, promoters and other additives that are utilized in its manufacture.²⁷⁵ Ni-based are the best reforming catalysts for industrial applications in BG. However, they require the right environment and cheap carbon sorbents to have a profound effect. Some limitations are also present with non-Ni metal catalysts, in particular those containing expensive, noble metals like rhodium.²⁸⁴ Development in known catalysts and work into new, more novel catalysts are promising options for tar minimization.

6. Power generation methods

Biomass gasification was initially conceived to utilize organic wastes to produce usable products such as fuel gas or a chemical feedstock. Later, the technology was extended to treat hazardous waste, with the invention of plasma BG, along with power generation. Examination of the distinctive characteristics of

supercritical water led to SCWG for wet biomass which is otherwise untreatable by gasification, due to technical limitations of the former gasification technologies. Advancement in BG paved the way for the poly-generation concept where two or more usable products are generated, for instance, co-generation of thermal power with electricity; poly-generation of heat, fertilizer and bio-char; poly-generation of heat, SNG/bio-fuels; and poly-generation of H₂ with heat and electricity. All these approaches not only optimize the thermal efficiency of the process but also provide flexibility and sustainability, thereby enhancing the economic advantage in the long run.

6.1 Existing applications

6.1.1 Power generation. Electricity production from the products of BG is just one potential application which has recently gained ground over conventional combustion. However, this is widely driven by emission legislation changes and the simplicity of the application rather than economic or technological advances. Syngas is a highly desirable product. However, it carries particulate matter and lighter HCs produced during gasification. Post gas clean-up, it can be combusted in conventional burners employing steam cycles for electricity generation. The gas clean-up stage has a variety of available methods: mechanical cleaning, catalytic treatment, thermal treatment and plasma cleaning. This is one of the most decisive and costly steps which decides the final application of the exit gases. Unfortunately, there have been closures of some BG electricity production plants due to technical issues regarding gas-clean up and ash problems.²⁸⁵

Combustion of the syngas can be undertaken within a boiler, which is commonly employed in case of low-quality gas. However, the net efficiency of such boiler-based electricity generation is ~20%, which when compared to a maximum of ~38–50% for conventional gas engines and gas turbines is a less attractive commercial choice. Gas engines have emerged as a promising technology for dispersed power production. This is due to their compact nature, power generators' long-standing experience with natural gas engines, the potential to capture waste heat easily, simplified process technology and low investment and operational costs at a large scale.²⁸⁶ A schematic is shown in Fig. 14 presenting conventional multi-generation



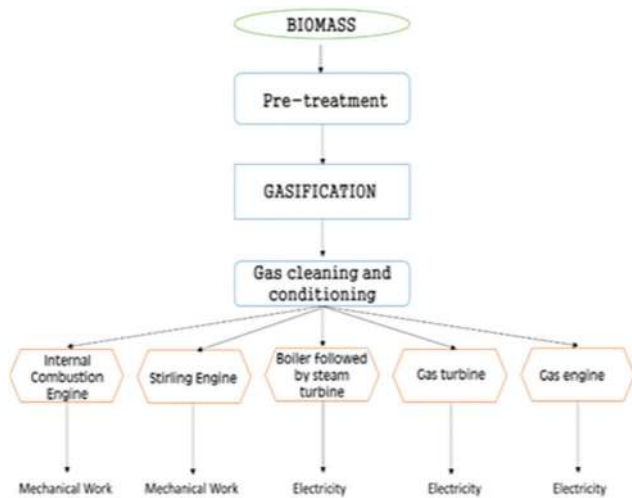

Fig. 14 Flow chart of conventional multi-generation scheme employing biomass gasification.

approaches. The syngas generated is used in diversified applications such as IC engines, Stirling engine, gas engines, steam and gas turbines.

6.1.2 Producer gas-driven internal combustion (IC) engine.

The heating value of the produced gas is a primary factor in evaluating the potential power of the engine. Syngas is blended with air prior to induction into the cylinder in order to improve the likelihood of complete combustion, as is done with all internal combustion engines. The heating value is reported to be about 2500 kJ m^{-3} , which is relatively low compared to the petrol-air mixture heating value of 3800 kJ m^{-3} . Consequently, there is a substantial power loss of about 35%.²⁸⁷ Since the volume of the cylinder remains constant for a particular engine, the amount of combustible gas entering the cylinder is dependent upon the gas pressure. When the engine is combined with a fixed bed gasifier, there is an important drop in pressure at the inlet of the IC engine. On account of this pressure drop, the volumetric efficiency is significantly reduced. Consequently, the amount of exit gas mixture in the cylinder is reduced. This adversely affects the IC engine power output. However, by using a booster, this pressure drop can be reduced to 1%. In addition, the number of strokes per unit time is reduced when an IC engine is fueled by the syngas mixture due to the lower heating value.

A potential solution to this drop in power output is to enhance the compression ratio (volume of the gas before compression to the volume post compression) from around 8 to 12 by increasing the H_2 percentage in the inlet gas.²⁸⁷ This increase in compression ratio does raise the engine power but is limited by the increased potential for vibrations and knocking which are responsible for reduced engine life.²⁰⁹

6.1.3 The Stirling engine. The main problem with gasification product gas is the presence of tar and alkali metals in low amounts produced from eutectic mixtures at elevated temperatures. Some researchers examined the Stirling engine as a substitute for the IC engine. It was proposed that this was a feasible

option on account of the low operating costs, low lubricant requirement, better efficiency and the simple design which does not demand a highly pure gas.²⁸⁸

6.2 Advanced concepts

6.2.1 Co-generation of thermal energy with power. Power generation is the most common goal of BG. Despite this, it is inevitable that during this process heat is also generated, and as with other combustion processes in recent years, the idea of co-generating heat and power has become highly attractive. This idea provides a useful resource with a profitable secondary market that makes use of what was previously a waste stream. Power can be effectively transmitted over long distances with minimal losses but thermal losses prohibit heat transfer over a similar distance. This constrains the location of the co-generation plant and, therefore, it must be placed near the producer. Small decentralized co-generation plants are established and are successfully in operation across the world. Indeed, the B&W Harboøre installation has run two Jenbacher gas engines (648 kW_e and 648 kW_e upgraded in 2001 to 768 kW_e) for over 120 000 hours of operation in a CHP context. This is notable since the gasifier is an updraft gasifier.²⁸⁹ Additionally, a 26 MW_{th} plant in Denmark and a 15 MW_{th} plant in Germany started in 2006 and 2012, respectively.^{290,291} Cogeneration units can provide heat and power to industrial, commercial and residential buildings. Co-generation of heat and power by biomass combustion is prevalent,²⁹² albeit gasification is better in terms of electrical efficiency and the acceptable range of biomass qualities.^{89,285} However, many co-generation units for the production of thermal energy with electricity employing gas engines are installed and working successfully around the globe.^{89,285,290,291,293–298}

Many researchers have investigated the co-generation strategy to enhance electricity production.^{42,290,291,299–313} Investigators have coupled a Rankine cycle with two gas engines, which additionally transforms 10–15% of heat into electricity, and improves biomass power efficiency from 25–30% to 40% or more.^{290,291} Another tactic to optimize the efficiency is to couple gas and steam turbines to generate power. This is commonly referred to as Integrated Gasification Combined Cycles (IGCC). This approach has a reported efficiency of 46% for coal gasification and power efficiency of around 32% for biomass gasification.^{307,308}

6.2.2 Fertilizer and bio-char production. This concept, which has been mentioned earlier in this paper under ‘multi-stage biomass gasification concept’, uses two different reactors for pyrolysis and BG. The absence of PAH opens the door to utilize ash as a fertilizer, for some gasifiers. Some researchers³¹⁴ have already investigated the ash content from LT-CFB. A surprising and welcome finding was that the ash contained 40% calcium, up to 6% phosphorus and 5% Fe with traces of heavy metals. This makes it feasible to re-circulate nutrients.³¹⁵ Studies were carried out on fields with different plants. It was found that leaching of the nutrients was lower and the phosphorus uptake was identical to that from conventional fertilizer. However, an initial delay was noted for the plants’ take-up of phosphorus,



which in turn suppressed plant growth. Acid removal by extracting lime solved the problem, making ash a promising substitute for mineral fertilizer.

This gasification technology can also support the enhancement of the amount of organic carbon in soil, which has an additional benefit of being a method of sequestering carbon. The term, 'Bio-char', has been coined to describe char which has been deliberately left un-gasified and is added to farm soil. Bio-char is known for recirculating organic carbon back into the ground and aiding in ionic adsorption, thus preventing leaching of vital nutrients and minerals into ground water.³¹⁶ In addition, enhanced water holding capability results when bio-char is mixed with sandy soils.^{317–319} Although leaving some char un-gasified would decrease the efficiency of the BG process, it may provide a carbon-neutral alternative for fertilizer and bio-char production.

6.2.3 Poly-generation of heat, power and hydrogen. Hydrogen from BG has found numerous applications. Air as a gasifying medium gives a low H₂ purity in the produced gases because of dilution by N₂. CO₂ as gasifying agent enhances CO content through the Boudouard reaction (13). On the other hand, gasification in the presence of O₂ or steam generates H₂-rich gas because of steam reforming and the water–gas-shift reaction (17) that take place. This also has an impact on the heating values of the gases generated. Obviously, more H₂, CH₄ and CO in the gas would be beneficial over CO₂.

Some researchers have modelled H₂ generation in conjunction with heat and power production.^{320–324} H₂ production from rice husk in BG with O₂ as the gasifying agent was studied theoretically.³²³ Investigators used two Rankine thermodynamic cycles during power generation for maximal heat retrieval with a H₂ production efficiency of 40%. Electric power generation efficiency was 3.25% in the absence of CO₂ compression for storage and 1.5% with compression. Poly-generation of H₂, thermal energy and electricity was also modelled by investigators to evaluate H₂ generation costs and process applicability in practical scenarios.³²⁰ Ten distinct processes were modelled employing different reactors for BG, and an exergy analysis was carried out for cases with and without thermal energy retrieval.³²¹ Investigators also did thermo-economic modelling to inspect the repercussions of this new process to obtain H₂, coupled with heat, electricity and CO₂ sequestration. They found positive effects when combining different sub-systems to optimize thermal energy retrieval along with waste heat utilization.³²⁴

Apart from these theoretical investigations, large-scale experiments were also carried out under a project funded by the European Union to examine heat and power production with H₂ generation.³²² Unique gasifiers, as mentioned in the earlier section of this paper, were coupled with a secondary reactor for H₂O gas shift reactions and a pressure swing adsorption unit to capture CO₂. They report a H₂ conversion efficiency of >66%.

6.2.4 Fischer–Tropsch process coupled with gasifier. In 1923, Franz Fischer, Hans Tropsch and Helmut Pichler invented the Fischer–Tropsch (FT) process in Germany. Presently, it is a well-known process to synthesize higher HCs using syngas

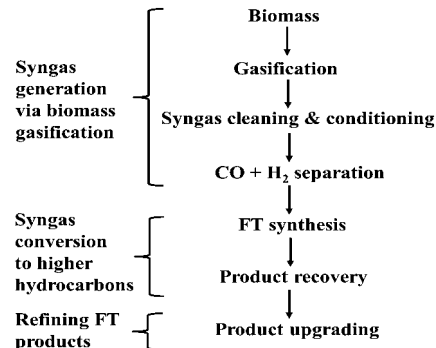

Fig. 15 Flow chart depicting FT-fuel synthesis from biomass.

from gasification. It is a typical example of the Biomass-to-Liquid concept as depicted in Fig. 15. Higher HCs such as diesel and gasoline are generated *via* the FT process; these are normally used as liquid fuels for the transportation sector. All large-scale commercial plants hitherto are either based on CH₄ reforming or coal gasification systems.³²⁵

Biomass gasification produces syngas which can act as a raw material for an FT process. If the fraction of H₂ is low in syngas, then a water gas shift reactor is needed prior to FT synthesis. Syngas is converted to liquid fuels and/or chemicals *via* the FT process in the presence of Co-based or Fe-based catalysts. Co-based catalysts require higher H₂ content in the syngas for fuel production. However, their productivity is more at higher conversion levels, than Fe-based catalysts.³²⁶

Climate change and fossil fuel depletion necessitate renewable transportation fuels. The gasifier-coupled FT plant concept presents an encouraging option in this regard. Investigations prove that FT fuels result in low emissions when employed in IC engines on account of the low volume of nitrogenous and aromatic species. Furthermore, these fuels do not contain sulphur which is considered as one of the major pollutants in IC engine exhaust gases.³²⁷ This process presents a promising alternative for the production of renewable liquid fuels. The FT process coupled with gasification is a feasible option to reduce the burden on conventional transportation fuel; however, it requires significant development and scale-up efforts for commercial-scale installations.

6.2.5 SNG and other biofuels. Bio-SNG or SNG is a potential substitute for natural gas, with similar chemical composition, and thus benefits from the use of pre-existing transportation and storage facilities. Several researchers have investigated SNG generation from the gasification of diverse feedstocks for process optimization and applications.^{328–332}

All methanation reactions (23)–(25) are exothermic in nature.⁹ Detailed methanation processes and clean-up techniques are mentioned in the literature.^{333–335}

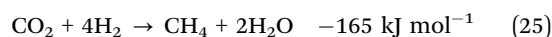
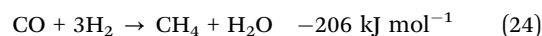
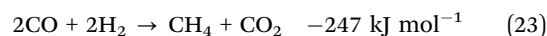

SNG has been investigated by some researchers for its use as a transportation fuel.^{328–330} SNG was reported to be more favorable than other bio-fuels with lower environmental impacts. However, it requires some pre-treatment before usage, unlike other bio-fuels. Furthermore, it has been suggested that SNG can be economically generated on a small scale. This contrasts with bio-fuels, which require larger production scales to be cost-effective.³²⁸ However, in the case of residential applications such as cooking or heating, syngas has proved to be more efficient than SNG, due to the efficiency drop incurred by the latter for an extra processing step. Furthermore, it must be considered that syngas is more efficient as a fuel source for the production of electricity than SNG, using suitable equipment in IGCC plants, on account of the same reason.³³¹

Liquid bio-fuels such as di-methyl ether (DME) or methanol are potential alternatives to oil-based conventional fuels such as gasoline or diesel on account of their suitable characteristics. Existing IC engine design, fuel filling station infrastructure and market acceptability coupled with low emissions make them a promising option over SNG or H₂, though the main benefit of any liquid fuel is energy density and ready transportation. Benefits of multi-production of bio-fuels coupled with thermal energy and electricity production are similar to those for SNG multi-production.⁸⁹ Researchers have investigated multi-production of heat, power and bio-fuels such as methanol, ethanol, methyl acetate, and FT diesel. They reported it to be cost-effective, more favorable and flexible than separate generation.^{336–339} However, it is less economical compared to fossil fuel generation when the oil price is low. This difference in economics could be mitigated by government-level subsidies or larger-scale generation benefits.^{94,340,341}

Current state of commercialization of SNG. Throughout the last decade, many pilot plants have been installed to study the feasibility of SNG generation from syngas.^{334,342–344} Sweden is the first country to have a commercial unit to generate SNG from BG-produced syngas. The setup is located in Goteborg, with 20 MW capacity already installed out of a total of 100 MW. A 200 MW plant at Eon in Sweden was installed in March 2014 and is working successfully.^{345–347} A 1 MW plant was established in Gussing, Austria, to produce SNG from BG syngas, and is also working successfully.³⁴⁸ Thorough investigations undertaken by Wirth *et al.*³⁴⁴ demonstrated that in order for a Bio-SNG plant to be economical, the installed size should be equal to or greater than 20 MW (output basis). This value was based on the inclusion of intricate and costly processes such as gasification, gas cleaning and conditioning, catalytic methanation and carbon dioxide removal.

7. Mathematical modelling of gasification

Product gas characteristics and more general performance measures such as process economics and energy efficiency in BG depend on several parameters like the selection of a suitable gasifier as well as the choice and concentration of feedstock

and other variables.¹⁸⁹ Operating conditions such as pressure, temperature and flow inside the gasifier need to be optimized to achieve the desired performance. Evaluation of optimal conditions is frequently carried out through experiments which are quite costly and time consuming.⁹

The solution to this problem is partially provided by mathematical modelling, where models can be generated to evaluate a variety of conditions quickly and cheaply. This simulation work saves time and resources and imparts qualitative data for real-life scenarios, albeit not as precisely as the experimentation work. Such models can be used to derive ideal conditions and permissible limits for gasifiers operating at elevated temperatures and pressures. Thus, they also enable the safety of the plant to be assessed before construction.³⁴⁹ It is also very helpful in testing various feedstocks and their behavior in different kinds of reactors without actually building them. Generally, the simulation of biomass gasification can be divided into 5 categories:

- (i) Thermodynamic Equilibrium Models
- (ii) Kinetic Models
- (iii) Computational Fluid Dynamics Models (CFD)
- (iv) Artificial Neural Network Models (ANN)
- (v) Tar Models

Thermodynamic models aid in deriving outlet gas characteristics for a specific set of conditions employing a specific gasifier. While generating a thermodynamic model, it is assumed that reacting species are left for an infinite amount of time.³¹ It reveals the thermodynamic boundaries which exist for the given set of parametric conditions. Practically, it has been found that while the results reflect the system potential, they can vary considerably from real-life scenarios, thus necessitating a more accurate approach.

Kinetic modelling partially transcends this limitation. It considers the kinetics of key reactions which occur inside the gasifier during biomass gasification, along with gasifier hydrodynamics.³⁵⁰ It takes into account the process of biomass gasification for a fixed time and determinate volume, thus, making it more exact than the previous modelling method. The disadvantage is that although great strides have been made in the last few decades, the kinetic pathways and reaction rate constants are still not perfectly understood.

CFD includes a variety of processes such as heat and mass transfer, flow transfer, temperature dissemination, and gas yield, *etc.*, by employing the solutions of numerous mathematical equations.³⁵¹ It is highly useful and can be quite accurate, though is complex.

ANN is a comparatively new approach which is analogous to machine learning. When data from experiments are fed to the model, it produces numerical results, learning by itself.³⁵² Its drawbacks include the lack of analytical results and failure in the cases of limited data.

7.1 Thermodynamic modelling

Application of the first and second laws to reacting systems, together with species mass balances result in equilibrium models, where the concentrations of reacting species minimize Gibbs free energy. Researchers have employed thermodynamic



models to study gasification in BG.^{353–359} Antonopoulos *et al.*³⁵³ examined the impact of temperature inside the reactor and H₂O content in the biomass (olive wood, miscanthus, and cardoon). They found that the reactor temperature was directly related to CO yield and inversely related to H₂ and CO₂ fractions in gas. In addition, they observed that the lower heating value of the outlet gas was indirectly related to the reactor temperature. More H₂O in the inlet was responsible for less net energy in the fuel, as additional energy was required to vaporize the H₂O. Their simulation results were very close to the experimental data, reflecting the significance of thermodynamic modelling.

The impact of process variables, namely pressure, temperature and feedstock moisture, while employing agricultural wastes as biomass feedstock, were studied for biomass gasification by developing an equilibrium model.³⁵⁴ CH₄ percentage was found to be a function of increasing pressure inside the reactor. However, this model was not very accurate and miscalculated the H₂ and CH₄ yield. Babu *et al.*³⁵⁵ employed the reactivity of char in the reduction zone as the basis to construct an equilibrium model for a BG. They studied steady state configuration and temperature contours over the entire length of the reduction area of the reactor. They validated the modelling results with experiments and reported that the char reactivity factor changed exponentially through the length of reduction zone in a BG. This research suggested the incorporation of an exponentially-varying char reactivity factor when constructing thermodynamic models to obtain more precise predictions.

Sandeep and Dasappa³⁶⁰ investigated air and oxy-steam biomass gasification based on the first and second law of thermodynamics. The model was generated for oxy-steam gasification in an open-top fixed bed downdraft gasifier with variable ER and S/B. At S/B of 0.75 (molar basis), maximum exergy efficiency obtained was 85% with energy efficiency of 82%. Drops in these efficiencies were found on increasing S/B on account of enthalpy loss in steam generation coupled with physical exergy loss of steam (in the product gas). Furthermore, decreases in efficiencies were observed for air gasification due to the presence of N₂. A carbon boundary point was observed at S/B of 1.5 and ER of 0.23. This study demonstrated that higher S/B is needed for high H₂ yield while lower S/B ensures an efficient process with high energy syngas.

Rokni and co-authors³⁶¹ developed an equilibrium model for MSW gasification coupled with a solid oxide fuel cell (SOFC), which was combined with a Stirling engine to recover thermal energy of the off gases from SOFC cycles. The SOFC basically acted as a topping cycle for a Stirling engine. The whole system capacity was 120 kW, which acted as a de-centralized CHP plant. Equilibrium modelling was performed employing a 2-stage air-blown (autothermal) fixed bed reactor, using the Gibbs free energy minimization approach. The plant electrical efficiency varied from 43 to 48% as a function of MSW composition and plant design. The maximum plant efficiency was found to be 48% and CHP efficiency as 95%, at SOFC operating temperature of 690 °C, provided there was an unaltered fuel mass flow rate.

Vakalis *et al.*³⁶² devised a novel approach called 'Multi-box' for thermodynamic modelling where they divided the whole reactor into multiple zones or boxes *vis-à-vis* gasification stages.

They evaluated solid–vapour equilibria in small-scale downdraft gasifiers. Gases and char compositions were obtained for different ERs (0.2–0.3) and the results were compared with conventional modelling approach results. CO, H₂, CO₂, CH₄ and char yields were closer to the real case scenario than what was found *via* conventional single-stage equilibrium modelling, reflecting the efficiency and accuracy of the technique.

Researchers have also applied thermodynamic models to study the influence of numerous parameters in the gas composition and yield when gasifying with a FBG^{363–369} and the unique gasifier.^{90,321,370–372} It is relatively easy to develop a thermodynamic model to forecast exit gas properties along with the maximum thermal efficiency. This approach can be made more accurate by utilizing empirical correlations deduced from experimental data.

The previously mentioned restrictions of equilibrium models can be alleviated by using kinetic modelling for gasification.³⁷³

7.2 Kinetic modelling

Kinetic modelling considers reaction kinetics and hydrodynamics of the gasifier and is thus potentially more accurate in deducing exit gas yield and composition.^{350,374} Unlike thermodynamic models, kinetic models can be applied to low-temperature gasification. Although it is more intricate than equilibrium models and its intricacy increases with the complexity of gasifier design, it is a more precise mathematical approach. The Arrhenius eqn (26) reflects the kinetic parameters which are significant to the model. It also quantifies the dependency on temperature.⁹ The laws of conservation of energy, mass and momentum are also included in the model.

$$k = A \exp\left(\frac{-E_a}{RT}\right) \quad (26)$$

where k is the reaction rate constant; A the pre-exponential factor; E_a the activation energy; R is universal gas constant; and T the absolute reaction temperature.

Researchers have developed kinetic models to study the parametric impact of various process variables on the gas composition and yield, using different feedstocks in different types of gasifiers.^{375–378} The reaction temperature and S/B were taken as parameters and a kinetic model was constructed by Inayat *et al.*³⁷⁶ using oil palm empty fruit bunch as the feedstock with steam as the gasifying media, coupled with *in situ* CO₂ capture by CaO. The H₂ produced was directly proportional to both reaction temperature and S/B. However, the efficiency was reported to drop when increasing S/B beyond a point. In addition, this model also deduced that temperature was a more important process variable than S/B. A kinetic model was developed to study temperature and species concentration profiles in both steady and dynamic states using biochar as a feedstock in a downdraft solar packed bed gasifier.³⁷⁵ It was found that a downdraft gasifier coupled with solar power was a feasible design. H₂-rich exit gas was generated from the concept with an efficiency of 55%. These predictions were in accordance with the experimental measurements.



Sreejith and co-authors³⁷⁹ generated a kinetic model employing air-steam as the gasifying medium and wood as the feedstock in a fluidized bed gasifier, to study the influence of CaO as sorbent for *in situ* CO₂ capture. The lower heating value of the syngas was enhanced from 5.58 to 6.12 MJ Nm⁻³ when the sorbent-to-biomass ratio was increased from 0.75 to 1.5, at ER of 0.25 and S/B of 1. Moreover, they reported an increase of 14 to 16% in H₂ yield when sorbent was introduced in the system. The maximum H₂ yield was 53% in the syngas at ER of 0.25, S/B of 1.5, sorbent-to-biomass ratio of 2.7 and temperature of 727 °C. Furthermore, they proved that from an energy efficiency point of view, air-steam gasification is better than steam gasification.

Khonde *et al.*³⁸⁰ developed a single reaction model (SRM) and a distributed activation energy model (DAEM) for rice husk gasification in a 2-stage BG with variable temperatures (700–900 °C) and residence times (12–48 s). They correlated the experimental data and investigated the kinetics of individual gases and tar cracking. Increase in temperature and residence time resulted in H₂ rich syngas and maximum tar conversion of 91% was observed. They argued that N₂ and air are more influential for secondary gaseous products. In addition, they asserted that the DAEM is more appropriate than the SRM on account of its accuracy in correlating tar conversion activity over a diverse range of conditions.

The use of computational software packages (Mathematica, MATLAB, ASPEN PLUS, are examples of such) can be incredibly useful at saving time, money and resources when applied correctly. Models have previously been applied to predict potential issues with designs and have been utilized to test novel ideas before the purchasing of capital equipment.⁹

7.3 Computational fluid dynamics modelling

CFD has emerged as a powerful and vital tool in modelling thermochemical reactors such as gasifiers. It is effective in deriving the optimum operating conditions and geometry, heat and mass transfer along with the gas yield to a reasonably good degree of accuracy, especially in FBGs, provided the reactor hydrodynamics are known.³⁸¹ CFD models for BG necessitate sub-modelling of various stages such as vaporization, pyrolysis, char oxidation, *etc.*, making it the most complicated modelling approach amongst the three discussed so far.³⁸²

Some researchers have constructed CFD models to study different types of gasifiers taking diverse parameters.^{97,357,383} The cold gas efficiency, gas composition, conversion efficiency and temperature profile of a BG were investigated using wood as feedstock with the finite volume approach.³⁸³ Numerical simulation was performed on a high-resolution mesh which considered both solid and gaseous phases. Temperature profiles were deduced and matched with the experimental data along with the species density. The average temperature profile derived from the CFD model was higher than the experimental value while cold gas efficiency was lower than the ideal case. This variation was due to inability to capture the fine details of the highly complex phenomena taking place inside the gasifier. However, other gasifiers such as EFG, which have higher

temperatures and less intricate gas–solid flow profiles can be modelled with greater precision.

Coute and co-authors³⁸⁴ developed a 2D CFD model based on the Eulerian–Eulerian approach to study the influence of O₂ rich air on BG employing coffee husks as feedstock. The kinetic theory of granular flow was used to analyze the characteristics of dispersed phase and gas phase behaviors. The impact of O₂ on operating temperature, S/B and syngas composition was also evaluated. It was reported that N₂ and H₂ molar fractions were enhanced with increasing O₂ content while CO₂ decreased. In addition, cold gas efficiency increased with increasing O₂ whereas it decreased with S/B. This study was found to be in good agreement with the experimental results.

Savuto *et al.*³⁸⁵ generated a CFD code to evaluate the behavior of catalytic filters situated inside the freeboard of the reactor and to analyze their performance in steam reforming of CH₄ and tar species. Parameters such as filtration velocity (70–110 m h⁻¹) and temperature (750–850 °C) were investigated, which have impact on the filters' performance. It was observed that CH₄ and C₇H₈ conversion doubled whereas C₆H₆ and C₁₀H₈ conversion were quadrupled, with a 100 °C rise in temperature. Furthermore, maximum conversion for tar and CH₄ was reported at maximum temperature (850 °C) and minimum filtration velocity (70 m h⁻¹). At these conditions, CH₄ conversion was 33% while C₆H₆, C₇H₈ and C₁₀H₈ conversions were 41%, 75% and 85% respectively.

The latest advancements in CFD modelling have paved new ways for the optimization of biomass gasification coupled with reactor design.³⁵¹ The capability of CFD to infer gasifier performance under a broad range of process variables makes it a highly promising option.

7.4 Artificial neural network modelling

ANN is a relatively fresh approach for the modelling of complex processes. It is a tool which is already in use in different areas such as signal processing but its application in outcome predictions in BG is quite new. A significant advantage of ANNs is that they do not require the formulation of complex mathematical equations and they can learn and identify non-linear relations themselves.³⁸⁶ Thus, ANNs may be an interesting option to evaluate BG where complex non-linearities occur in the data-set.

Very few researchers have modelled biomass gasification using the ANN approach.^{352,387} A model was constructed to derive exit gas characteristics and heat content along with the temperature profile in a FBG.³⁸⁷ Predictions were very close to the experimental data. At a S/B of 2.53, the highest H₂ yield was reported to be 29.1% in experiments. The ANN predicted this value as 28.2%, reflecting the potential of ANN models to simulate complex gasification to significant precision.

Mikulandric *et al.*³⁸⁸ developed advanced control solutions centred on a 'feedforward-feedback' control strategy employing collected operational data from a 75 MW_{th} fixed bed gasification plant operated by Technical University, Dresden. The influence of the control approach was evaluated by employing an ANN-based prediction model. It was reported that the



introduction of advanced control systems for numerous process variables can increase process efficiency by 25% on account of alterations in air and fuel distribution on partial product gas generation loads. Furthermore, this approach decreased the adverse environmental effects of BG systems. This work demonstrates the significance of advanced modelling strategies such as ANN for optimizing gasification process.

ANN modelling is seen as an encouraging approach especially for UG and dual FBG which are difficult to model by other methods; however, it requires large amounts of data in different regions of the operating space to produce a sufficiently large database for ANN training and model development.

7.5 Tar formation and destruction models

Tar models are classified as either single-compound models, lumped models or kinetic models.¹⁸⁴ Single-compound models represent simple versions of biomass and they reflect how this biomass would react whereas lumped and kinetic models utilize heat and mass transfer information along with rate of reactions. Font-Palma *et al.*¹⁸⁴ reported, *via* comprehensive experimental investigations, acetol, acetic acid and guaiacols as primary tar model compounds, phenols, cresols and toluene as secondary tar model compounds and naphthalene as tertiary tar species. Zhao *et al.*^{389,390} studied toluene and Ji *et al.*^{389,390} investigated phenol with a single-compound model and developed a thermodynamic model for tar formation. Benzene and naphthalene were the only HCs produced when toluene was chosen as the tar model and in the latter case, phenol cracking generated naphthalene and benzene followed by their decomposition to non-condensable gases and H₂O. These simulation results are in close agreement with the experimental work done and, therefore, demonstrate the applicability of tar model compounds when attempting to understand tar destruction while minimizing time-consuming and expensive experiments.

To facilitate the simulation of bubbling FBG, many researchers^{356,391–395} conducted tar modelling using a lumped-model approach, while Abdelouahed *et al.*³⁹⁶ developed lumped models for dual FBG. Their simulation results were in agreement with the experimental investigations. Detailed kinetic models can be studied in the work done by many investigators.^{397–401} The single compound model approach using stable compounds like toluene, benzene and naphthalene or the lumped-model approach are considered the best for tar modelling, although these compounds appear as secondary and tertiary tars with no knowledge of kinetics of their development. Comprehensive kinetic models employ numerous species and, therefore, are considered to be very complex when simulating biomass inside a gasifier. A more feasible approach is to keep to a minimum the number of tar species while modelling tar development during gasification.¹⁸⁴ Detailed work can be found in the literature.^{184,266,356,389–395,397–403}

8. Socio-environmental analysis

The major motivation behind biomass gasification is to exploit a large variety of waste materials as feedstock, to increase resource efficiency and reduce adverse climate change *via*

CO₂ mitigation. Although gasification is a key technology to utilize biomass waste, it poses many potential kinds of risks which have a significant impact on society and the environment at large.⁴⁰⁴ One of the main problems is the potential emissions of particulates (PM₁₀ or PM_{2.5}, dioxins, PAH), CO, SO_x, NO_x and volatile organics.⁴⁰⁵ These pollutants can interact with humans through inhalation, ingestion and dermal contact and thus pose a grave threat to human health.⁴⁰⁶ A detailed analysis has been depicted in Table 9.

On the other hand, biomass combustion can also emit complex mixtures of particles (PM_{2.5}), semi-volatile matter and gases. Particulate organic matter in PM_{2.5} ranges from alkanes, aromatic compounds to carboxylic acids. These have soluble organic emissions with high concentration of organic tracers (from lignin and cellulose combustion).^{410–412} These pollutants are carcinogenic in nature and can induce potentially fatal tumors. Their rates of discharge are very high when compared to efficient biomass gasification. Therefore, as far as harmful emissions are concerned, biomass gasification and even fossil fuel combustion are generally better than biomass combustion if the latter does not have pollution mitigation, especially SO_x and NO_x.⁴¹² Consequently, gasification is preferred for biomass utilization on account of very low emissions after an efficient gas clean-up and conditioning unit.

Gasification is a system which has an inherent risk for fire and explosion vulnerability, especially since the gasifiers operate at high temperature and pressure.⁴¹³ This probability enhances significantly when H₂ is the desired product. It is highly flammable and, therefore, necessitates a great amount of caution. Ash and tars are noteworthy elements which have potential for environmental contamination. The waste streams formed require a suitable disposal system to be implemented that meets all legislative guidelines. Techniques like low-temperature CFB which can produce ash with negligible PAH impurity pose little threat to the environment, meaning that this ash can also be used as a fertilizer.⁴¹⁴

The idea of gasifying biomass resources in remote or sparsely populated areas to provide heat and electricity is one that has received substantial attention over many years, albeit the progress has been slow.^{4,415,416} Currently, there are major rural gasification programs in countries as diverse as China such as crop straw-based projects like the Xiaoliujia project, projects in Jincheng City and elsewhere;⁴¹⁷ India has also seen deployment in places such as Karnataka, where two 500 kW gasifiers have been built, along with Africa and elsewhere.^{418,419}

One of the successful projects employing a decentralized biomass gasification-based power generation system in an un-electrified Indian village called Hosahalli village in Karnataka province emphatically reflects the promising nature of gasification systems.⁴²⁰ Power derived from a biomass gasification system was employed for lighting, drinking water supply *via* pipes, irrigation water supply and flour milling. A 20 kW gasifier-engine generator system with all the accessories for fuel processing and electricity distribution was installed in 1988 and operated until 2004. It met all the electricity needs of the entire village. Cost of fuel and, operation and maintenance costs were calculated



Table 9 Analysis of gasification pollutants and their effects^{40,6–409}

Type of pollutant	Feature	Effect on respiratory system	Effect on cardio-vascular system	Effect on nervous system	Effect on digestive system	Congenital problems
Particulates	Size <2.5 μm is harmful; toxicity varies depending upon chemical composition; PAH, dioxins, Pb, Hg are considered toxic	Nose and throat irritation, COPD, asthma, lung cancer	Mycocardial infraction	Headache, fatigue	Liver cell damage, liver cancer, gastro-intestinal cancer	Reduced fetal growth, preterm birth, low birth weight, motor and cognitive disabilities
CO	Incomplete combustion produces CO; atmospheric half-life of 1–2 months	Asthma, COPD, bronchitis, dyspnoea	Lung inflammation, angina infraction, cardiac arrest	Schizophrenia	—	Preterm birth, cardiac defects
SO _x	Oxides of sulphur; atmospheric life span is 4–10 days	Nose and throat irritation, asthma	—	—	—	Preterm birth
NO _x	Oxides of nitrogen; life span of 1–2 weeks	Bronchitis, COPD, asthma, lung cancer	Cardiac mortality and morbidity	Sleep disorders, fatigue	—	Reduced fetal growth, preterm birth
Volatile organics	Large range of chemicals which are easily evaporated at room temperature; examples – benzene, toluene, etc.	Asthma	Lung inflammation	Nausea, dizziness	Liver failure, kidney failure	Preterm birth, motor and cognitive disabilities

as INR 5.85 per kW h at a load of 5 kW and INR 3.34 per kW h at a load of 20 kW. The Hosahalli project has proved the technical and operating viability of biomass gasification systems in rural areas of developing countries. Among all the renewable energy power generation technologies, decentralized power generation *via* biomass gasification offers great potential for meeting rural energy needs on account of its technological maturity, availability in different capacity scales, feasibility of operation during different times of day/year, economic feasibility, biodiversity preservation and aid in climate change mitigation.

Often the goal of using biomass as an energy source is simply to replace the cook stove in small communities with a reliable and relatively clean source of heating.^{421,422} This is especially attractive if the biomass can replace polluting fuels like coal briquettes, and is also interesting given the very large amounts of such material available in some locations (*e.g.* for India resources are estimated as 120–150 million metric tonnes per annum which represents a potential of about 18 000 MW energy).⁴²² Such units are usually small, typically no more than 10 to 200 hundred kW_{th} and are expected to be robust non-polluting devices, which can be operated in a communal setting with diverse feedstock ranging from straws to materials like coconut shells.⁴²³ Such systems can also be combined with economic stimulus packages such as soft loans to rural communities to pay for the capital cost of such systems and to provide start-up funding to operate such systems in conjunction with NGOs or other organizations.⁴ In some circumstances small gasifiers have proven to be more economic for electricity generation than for instance importing diesel fuels to remote communities⁴²⁴ and gasification technology is being seen as a vital method for dealing with energy poverty.^{425,426} Such technologies also offer the possibility of avoiding pollution associated with the disposal of agricultural wastes,⁴²⁷ although it has been noted that to date there has been relatively little testing of such technologies in real settings, and this is essential if gasification technologies are to fully displace conventional systems in rural locations.

Researchers including Luque *et al.*²⁰⁸ and Demirbas *et al.*²¹⁰ have conducted extensive investigations on diverse aspects of biofuels. Synthetic biofuels like Bio-DME, Bio-H₂, hydrothermal upgraded (HTU) diesel, and linear chain HCs, *etc.*, are prepared from gasification product gases by employing different processes. In the absence of contaminants such as particulates, tar and other toxic gases, they are considered cleaner. With a high cetane value, they can be used in IC engines (except Bio-DME) with advantages such as clean combustion, albeit with a requirement for engine modification.²⁰⁸ Production of bio-ethanol is also an interesting idea to help curb crude oil usage and environmental pollution. However, the technologies available for the majority of these biofuels are in their infancies with respect to production, storage and transportation. Moreover, production of these fuels is a costly affair on account of high installation and production costs.^{208,210}

Biofuels have some other adverse environmental effects which should also be considered in their long-term sustainability assessment. Direct GHG emissions such as from fertilizer usage

and indirect from land use change, coupled with the adverse impact on biodiversity forms the main threat to wide-scale deployment of biomass growth for biofuel generation.^{428,429} Soil preservation issues and water utilization are other factors that militate against the use of biofuels.^{430,431} The main concerns related to societal impact should be land use change and fiscal sustainability along with proper administrative guidelines. On the other hand, the independent production of biofuel directly improves a country's energy security and their current and expected future energy mix. Biomass gasification also provides an opportunity to provide additional jobs in R&D, engineering and procurement.

9. Conclusions

Biomass is a significant non-conventional energy reserve. Its topographical independence and comparatively ample availability makes it a promising choice over other renewable sources such as solar, wind or hydroelectric storage. Bioenergy technologies such as gasification can utilize a variety of biomass types to produce useful products including electrical power and hydrogen. A deep understanding and knowledge of the process along with the alternative approaches to gasification are required for optimization and advancements in a cost-effective manner.

An in-depth survey throughout this paper has provided evidence about various biomass feedstocks and the applications of the potential gasification products. The impacts of different parameters on the properties and yields of the individual products have been discussed with the aim to aid optimization of future research and the process as a whole. Unique gasifier designs, including large-scale multi-stage gasification and smaller decentralized pyrolysis plants near the biomass source coupled with a centralized gasification unit are interesting and potentially economical ways to optimize biomass utilization. More novel technologies, such as plasma gasification and SCWG could be effective ways to make the most of toxic and wet biomass to generate power. Various poly-generation approaches to produce heat and power along with other products like syngas, H₂, fertilizer or biochar demonstrate the developments and opportunities in gasification.

Understanding of tar formation, and advancements in modelling have been mentioned to pave the way for future expansion in discovering and designing new catalysts, to make the gasification process cleaner and operate with a higher efficiency. Conventional modelling is being supplemented and in some cases replaced by CFD and ANN. Although gasification has some adverse social and environmental impacts, they can be minimized through appropriate technological and policy implementations.

This paper presents a positive case for biomass gasification as a promising, viable and economically beneficial technology. It has been shown that the process is not limited to a particular feedstock and specific product, but is flexible towards the treatment of biomass wastes that may be toxic or contaminated, for the generation of diversified usable products.

Acknowledgements

M. Zhao thanks for the support by the National Recruitment Program of Global Youth Experts (The National Youth 1000 – Talent Program) of China (grant number: 20151710227); M. Zhao, V. S. Sikarwar and M. Z. Memon are grateful for the funding support by Tsinghua University Initiative Scientific Research Program (grant number: 20161080094) and the Volvo Group in a research project of the Research Center for Green Economy and Sustainable Development, Tsinghua University (grant number: 20153000181). P. Clough thanks the EPSRC for funding a DTA studentship and J. Yao thanks Imperial College for funding a studentship. We also thank Ms Shujuan Zhang for her assistance.

References

- 1 R. Saidur, E. A. Abdelaziz, A. Demirbas, M. S. Hossain and S. Mekhilef, *Renewable Sustainable Energy Rev.*, 2011, **15**, 2262–2289.
- 2 International Energy Agency Energy Database, <http://www.worldenergyoutlook.org/resources/energydevelopment/energyaccessdatabase/>, accessed November 2015.
- 3 S. Heidenreich and P. U. Foscolo, *Prog. Energy Combust. Sci.*, 2015, **46**, 72–95.
- 4 B. Buragohain, P. Mahanta and V. S. Moholkar, *Renewable Sustainable Energy Rev.*, 2010, **14**, 73–92.
- 5 Ministry of Coal, Government of India, <http://coal.nic.in/content/coal-reserves>, accessed September 2014.
- 6 National Energy Technology Laboratory, USA, <http://www.netl.doe.gov/File%20Library/Research/Coal/energy%20systems/gasification/gasifipedia/index.html>, accessed March 2016.
- 7 A. K. Rajvanshi, *Alternative energy in agriculture*, 1986, **2**, 82–102.
- 8 National Energy Technology Laboratory USA, <http://www.netl.doe.gov/research/coal/energy-systems/gasification/gasifipedia/wabash/>, accessed September 2000.
- 9 P. Basu, *Biomass Gasification and Pyrolysis*, Elsevier, Oxford, 2010.
- 10 J. P. Ciferno and J. J. Marano, presented in part at US Department of Energy, National Energy Technology Laboratory, June 2002.
- 11 G. Foley and G. Barnard, *Biomass gasification in developing countries-Technical Report*, International Institute for Environment and Development, Earthscan, UK, 1983.
- 12 H. Knoef and J. Ahrenfeldt, *Handbook biomass gasification*, BTG biomass technology group, The Netherlands, 2005.
- 13 S. Rapagnà, N. Jand, A. Kiennemann and P. U. Foscolo, *Biomass Bioenergy*, 2000, **19**, 187–197.
- 14 C. Higman and M. v. d. Burtg, *Gasification*, Gulf Professional Publishing, Elsevier, USA, 2008.
- 15 P. Parthasarathy and K. S. Narayanan, *Renewable Energy*, 2014, **66**, 570–579.
- 16 P. McKendry, *Bioresour. Technol.*, 2002, **83**, 37–46.
- 17 P. Basu, in *Biomass Gasification and Pyrolysis*, ed. P. Basu, Academic Press, Boston, 2010, pp. 97–116.



- 18 C. Li and K. Suzuki, *Renewable Sustainable Energy Rev.*, 2009, **13**, 594–604.
- 19 A. George, A. Brandt, K. Tran, S. M. N. S. Zahari, D. Klein-Marcuschamer, N. Sun, N. Sathitsuksanoh, J. Shi, V. Stavila and R. Parthasarathi, *Green Chem.*, 2015, **17**, 1728–1734.
- 20 R. El Hage, N. Brosse, L. Chrusciel, C. Sanchez, P. Sannigrahi and A. Ragauskas, *Polym. Degrad. Stab.*, 2009, **94**, 1632–1638.
- 21 H. L. Chum and R. P. Overend, *Fuel Process. Technol.*, 2001, **71**, 187–195.
- 22 K. J. Ptasinski, *Biofuels, Bioprod. Biorefin.*, 2008, **2**, 239–253.
- 23 P. H. Hasler and T. Nussbaumer, *Biomass Bioenergy*, 1999, **16.6**, 385–395.
- 24 Combustion Gasification and Propulsion Laboratory, IISc, India, <http://cgpl.iisc.ernet.in/site/Portals/0/Technologies/Gasification%20Technology.pdf>, accessed August 2011.
- 25 S. Dasappa, P. Paul, H. Mukunda, N. Rajan, G. Sridhar and H. Sridhar, *Curr. Sci.*, 2004, **87**, 908–916.
- 26 P. Giaordano and S. Dasappa, Test of different biomass into the IISc open top co-current gasifier, Swiss Federale Office of Energy, Project 39772 Contract 80847, 2001.
- 27 H. S. Mukunda, S. Dasappa, P. J. Paul, N. K. S. Rajan and U. Shrinivasa, *Energy Sustainable Dev.*, 1994, **1**, 27–38.
- 28 P. Basu, *Biomass Gasification and Pyrolysis*, Academic Press, Boston, 2010, pp. 167–228.
- 29 K. Gallucci, P. U. Foscolo, presented in part at 16th European Biomass Conference and Exhibition, Valencia, Spain, May 2008.
- 30 G. Galeno, M. Minutillo and A. Perna, *Int. J. Hydrogen Energy*, 2011, **36**, 1692–1701.
- 31 P. Basu, *Biomass Gasification and Pyrolysis*, Academic Press, Boston, 2010, pp. 117–165.
- 32 D. L. Klass, *Biomass for renewable energy, fuels, and chemicals*, Academic press, USA, 1998.
- 33 G. Tomlinson, D. Gray, M. Berger, Produced by MITRE Corporation for National Renew. Energ. Laboratory, USA, under contract number AL-4159, 1996.
- 34 P. J. Woolcock and R. C. Brown, *Biomass Bioenergy*, 2013, **52**, 54–84.
- 35 A. Demirbaş, *Energy Convers. Manage.*, 2002, **43**, 897–909.
- 36 H. De Lasa, E. Salaices, J. Mazumder and R. Lucky, *Chem. Rev.*, 2011, **111**, 5404–5433.
- 37 N. Nipattummakul, I. I. Ahmed, A. K. Gupta and S. Kerdsuwan, *Int. J. Hydrogen Energy*, 2011, **36**, 3835–3843.
- 38 I. Dincer, *Int. J. Hydrogen Energy*, 2012, **37**, 1954–1971.
- 39 C. Franco, F. Pinto, I. Gulyurtlu and I. Cabrita, *Fuel*, 2003, **82**, 835–842.
- 40 N. Nipattummakul, S. Pathumsawad and S. Kerdsuwan, International Conference on Thermal Treatment Technologies and Hazardous Waste Combustors, California, USA, May 2010.
- 41 L. Wei, S. Xu, L. Zhang, C. Liu, H. Zhu and S. Liu, *Int. J. Hydrogen Energy*, 2007, **32**, 24–31.
- 42 P. V. Aravind and W. De Jong, *Prog. Energy Combust. Sci.*, 2012, **38**, 737–764.
- 43 M. Asadullah, *Renewable Sustainable Energy Rev.*, 2014, **29**, 201–215.
- 44 D. J. Wilhelm, D. R. Simbeck, A. D. Karp and R. L. Dickenson, *Fuel Process. Technol.*, 2001, **71**, 139–148.
- 45 I. Wender, *Fuel Process. Technol.*, 1996, **48**, 189–297.
- 46 N. Abdoulmoumine, A. Kulkarni and S. Adhikari, *Ind. Eng. Chem. Res.*, 2014, **53**, 5767–5777.
- 47 H. Cui, S. Q. Turn, V. Keffer, D. Evans, T. Tran and M. Foley, *Energy Fuels*, 2010, **24**, 1222–1233.
- 48 S. Hurley, C. C. Xu, F. Preto, Y. Shao, H. Li, J. Wang and G. Tourigny, *Fuel*, 2012, **91**, 170–176.
- 49 Y. Ohtsuka, N. Tsubouchi, T. Kikuchi and H. Hashimoto, *Powder Technol.*, 2009, **190**, 340–347.
- 50 L. A. Bissett, An engineering assessment of entrainment gasification, U.S. Department of Energy, MERC/RI-78/2, Morgantown, USA, 1978.
- 51 F. Fabry, C. Rehmert, V. Rohani and L. Fulcheri, *Waste Biomass Valorization*, 2013, **4**, 421–439.
- 52 N. Agon, M. Hrabovský, O. Chumak, M. Hlína, V. Kopecký, A. Mašláni, A. Bosmans, L. Helsen, S. Skoblja and G. Van Oost, *Waste Manage.*, 2016, **47**, 246–255.
- 53 I. Matveev, *Plasma Assisted Combustion, and Pollution Control, Methods of Plasma Generation for PAC*, Publishers Outside Press Inc., Denver, 2016, vol. 1.
- 54 I. Matveev, *Plasma Assisted Combustion, and Pollution Control, Methods of Plasma Generation for PAC*, Publishers Outside Press Inc., Denver, 2016, vol. 2.
- 55 K. A. Magrini-Bair, S. Czernik, R. French, Y. O. Parent, E. Chornet, D. C. Dayton, C. Feik and R. Bain, *Appl. Catal., A*, 2007, **318**, 199–206.
- 56 C. Pfeifer, R. Rauch and H. Hofbauer, *Ind. Eng. Chem. Res.*, 2004, **43**, 1634–1640.
- 57 J. Delgado, M. P. Aznar and J. Corella, *Ind. Eng. Chem. Res.*, 1997, **36**, 1535–1543.
- 58 A. Olivares, M. P. Aznar, M. A. Caballero, J. Gil, E. Francés and J. Corella, *Ind. Eng. Chem. Res.*, 1997, **36**, 5220–5226.
- 59 A. Orío, J. Corella and I. Narváez, *Ind. Eng. Chem. Res.*, 1997, **36**, 3800–3808.
- 60 S. Rapagnà, N. Jand and P. U. Foscolo, *Int. J. Hydrogen Energy*, 1998, **23**, 551–557.
- 61 P. A. Simell, E. K. Hirvensalo, V. T. Smolander and A. O. I. Krause, *Ind. Eng. Chem. Res.*, 1999, **38**, 1250–1257.
- 62 J. Corella, J. M. Toledo and R. Padilla, *Energy Fuels*, 2004, **18**, 713–720.
- 63 L. Devi, K. J. Ptasinski, F. J. J. G. Janssen, S. V. B. Van Paasen, P. C. A. Bergman and J. H. A. Kiel, *Renewable Energy*, 2005, **30**, 565–587.
- 64 R. L. Bain, D. C. Dayton, D. L. Carpenter, S. R. Czernik, C. J. Feik, R. J. French, K. A. Magrini-Bair and S. D. Phillips, *Ind. Eng. Chem. Res.*, 2005, **44**, 7945–7956.
- 65 D. Świerczyński, C. Courson, L. Bedel, A. Kiennemann and J. Guille, *Chem. Mater.*, 2006, **18**, 4025–4032.
- 66 D. Swierczynski, C. Courson and A. Kiennemann, *Chem. Eng. Process.*, 2008, **47**, 508–513.
- 67 H. O. A. Fredriksson, R. J. Lancee, P. C. Thüne, H. J. Veringa and J. W. H. Niemantsverdriet, *Appl. Catal., B*, 2013, **130–131**, 168–177.



- 68 M. Virginie, J. Adánez, C. Courson, L. F. De Diego, F. García-Labiano, D. Niznansky, A. Kiennemann, P. Gayán and A. Abad, *Appl. Catal., B*, 2012, **121–122**, 214–222.
- 69 S. Rapagnà, K. Gallucci, M. Di Marcello, P. U. Foscolo, M. Nacken, S. Heidenreich and M. Matt, *Fuel*, 2012, **97**, 718–724.
- 70 M. Virginie, C. Courson, D. Niznansky, N. Chaoui and A. Kiennemann, *Appl. Catal., B*, 2010, **101**, 90–100.
- 71 H. Depner and A. Jess, *Fuel*, 1999, **78**, 1369–1377.
- 72 L. Ma, H. Verelst and G. V. Baron, *Catal. Today*, 2005, **105**, 729–734.
- 73 M. Nacken, M. Lina, K. Engelen, S. Heidenreich and G. V. Baron, *Ind. Eng. Chem. Res.*, 2007, **46**, 1945–1951.
- 74 Y. Hu, M. Watanabe, C. Aida and M. Horio, *Chem. Eng. Sci.*, 2006, **61**, 1854–1863.
- 75 M. Stemmler, A. Tamburro and M. Müller, *Fuel*, 2013, **108**, 31–36.
- 76 W. F. Elseviers and H. Verelst, *Fuel*, 1999, **78**, 601–612.
- 77 V. Patrick, G. R. Gavalas, M. Flytzani-Stephanopoulos and K. Jothimurugesan, *Ind. Eng. Chem. Res.*, 1989, **28**, 931–940.
- 78 Y. Zeng, S. Kaytakoglu and D. P. Harrison, *Chem. Eng. Sci.*, 2000, **55**, 4893–4900.
- 79 M. Stemmler and M. Müller, *Ind. Eng. Chem. Res.*, 2010, **49**, 9230–9237.
- 80 M. Diaz-Somoano and M. R. Martínez-Tarazona, *Energy Fuels*, 2005, **19**, 442–446.
- 81 K. J. Wolf, M. Müller, K. Hilpert and L. Singheiser, *Energy Fuels*, 2004, **18**, 1841–1850.
- 82 D. Barisano, C. Freda, F. Nanna, E. Fanelli and A. Villone, *Bioresour. Technol.*, 2012, **118**, 187–194.
- 83 A. Gómez-Barea, P. Ollero and B. Leckner, *Fuel*, 2013, **103**, 42–52.
- 84 U. Henriksen, J. Ahrenfeldt, T. K. Jensen, B. Gøbel, J. D. Bentzen, C. Hindsgaul and L. H. Sørensen, *Energy*, 2006, **31**, 1542–1553.
- 85 F. Trippe, M. Fröhling, F. Schultmann, R. Stahl and E. Henrich, *Fuel Process. Technol.*, 2011, **92**, 2169–2184.
- 86 S. Czernik and A. Bridgwater, *Energy Fuels*, 2004, **18**, 590–598.
- 87 A. Gómez-Barea, B. Leckner, A. Villanueva Perales, S. Nilsson and D. Fuentes Cano, *Appl. Therm. Eng.*, 2013, **50**, 1453–1462.
- 88 P. Hofmann, A. Schweiger, L. Fryda, K. D. Panopoulos, U. Hohenwarter, J. D. Bentzen, J. P. Ouweltjes, J. Ahrenfeldt, U. Henriksen and E. Kakaras, *J. Power Sources*, 2007, **173**, 357–366.
- 89 J. Ahrenfeldt, T. P. Thomsen, U. Henriksen and L. R. Clausen, *Appl. Therm. Eng.*, 2013, **50**, 1407–1417.
- 90 S. Nilsson, A. Gómez-Barea, D. Fuentes-Cano and P. Ollero, *Fuel*, 2012, **97**, 730–740.
- 91 A. Gomez-Barea, S. Nilsson, F. V. Barrero and M. Campoy, *Fuel Process. Technol.*, 2010, **91**, 1624–1633.
- 92 S. Nilsson, A. Gómez-Barea and D. F. Cano, *Fuel*, 2012, **92**, 346–353.
- 93 T. P. Thomsen, J. Ahrenfeldt and S. T. Thomsen, *Biomass Bioenergy*, 2013, **53**, 81–94.
- 94 P. Haro, F. Trippe, R. Stahl and E. Henrich, *Appl. Energy*, 2013, **108**, 54–65.
- 95 A. V. Bridgwater, *Biomass Bioenergy*, 2012, **38**, 68–94.
- 96 www.bioliq.de, accessed February 2016.
- 97 T. Jakobs, N. Djordjevic, S. Fleck, M. Mancini, R. Weber and T. Kolb, *Appl. Energy*, 2012, **93**, 449–456.
- 98 H. Leibold, A. Hornung and H. Seifert, *Powder Technol.*, 2008, **180**, 265–270.
- 99 S. Heidenreich, *Fuel*, 2013, **104**, 83–94.
- 100 Y. Somrang, PhD thesis, Imperial College London, 2012.
- 101 A. Oasmaa and S. Czernik, *Energy Fuels*, 1999, **13**, 914–921.
- 102 L. Tang, H. Huang, H. Hao and K. Zhao, *J. Electrostat.*, 2013, **71**, 839–847.
- 103 I. Janajreh, S. S. Raza and A. S. Valmundsson, *Energy Convers. Manage.*, 2013, **65**, 801–809.
- 104 L. Zhang, C. Xu and P. Champagne, *Energy Convers. Manage.*, 2010, **51**, 969–982.
- 105 Y. Kalinci, A. Hepbasli and I. Dincer, *Int. J. Hydrogen Energy*, 2011, **36**, 11408–11417.
- 106 A. Mountouris, E. Voutsas and D. Tassios, *Energy Convers. Manage.*, 2008, **49**, 2264–2271.
- 107 P. Rutberg, A. N. Bratsev, V. A. Kuznetsov, V. E. Popov, A. A. Ufimtsev and S. V. Shtengel, *Biomass Bioenergy*, 2011, **35**, 495–504.
- 108 J. L. Shie, F. J. Tsou and K. L. Lin, *Bioresour. Technol.*, 2010, **101**, 5571–5577.
- 109 L. Tang and H. Huang, *Fuel*, 2005, **84**, 2055–2063.
- 110 M. Hlina, M. Hrabovsky, T. Kavka and M. Konrad, *Waste Manage.*, 2014, **34**, 63–66.
- 111 C. J. Lupa, S. R. Wylie, A. Shaw, A. Al-Shamma'A, A. J. Sweetman and B. M. J. Herbert, *Fuel Process. Technol.*, 2012, **97**, 79–84.
- 112 D. H. Shin, Y. C. Hong, S. J. Lee, Y. J. Kim, C. H. Cho, S. H. Ma, S. M. Chun, B. J. Lee and H. S. Uhm, *Surf. Coat. Technol.*, 2013, **228**, S520–S523.
- 113 S. J. Yoon and J. G. Lee, *Int. J. Hydrogen Energy*, 2012, **37**, 17093–17100.
- 114 S. J. Yoon, Y. M. Yun, M. W. Seo, Y. K. Kim, H. W. Ra and J. G. Lee, *Int. J. Hydrogen Energy*, 2013, **38**, 14559–14567.
- 115 Ottawa Citizen Online News, <http://ottawacitizen.com/news/local-news/plasco-energy-group-files-for-creditor-protection>, accessed February 2015.
- 116 The Environment Media Group Ltd. News, <http://www.letsrecycle.com/news/latest-news/words-largest-gasification-plant-nears-completion/>, accessed May 2015.
- 117 A. Kruse, *Biofuels, Bioprod. Biorefin.*, 2008, **2**, 415–437.
- 118 A. Kruse, *J. Supercrit. Fluids*, 2009, **47**, 391–399.
- 119 Y. Matsumura, T. Minowa, B. Potic, S. R. A. Kersten, W. Prins, W. P. M. Van Swaaij, B. Van De Beld, D. C. Elliott, G. G. Neuenschwander, A. Kruse and M. J. Antal Jr, *Biomass Bioenergy*, 2005, **29**, 269–292.
- 120 P. Basu, *Biomass Gasification and Pyrolysis*, Academic Press, Boston, 2010, pp. 229–267.
- 121 Y. Guo, S. Z. Wang, D. H. Xu, Y. M. Gong, H. H. Ma and X. Y. Tang, *Renewable Sustainable Energy Rev.*, 2010, **14**, 334–343.
- 122 A. J. Byrd, S. Kumar, L. Kong, H. Ramsurn and R. B. Gupta, *Int. J. Hydrogen Energy*, 2011, **36**, 3426–3433.



- 123 Y. Chen, L. Guo, W. Cao, H. Jin, S. Guo and X. Zhang, *Int. J. Hydrogen Energy*, 2013, **38**, 12991–12999.
- 124 E. Kipçak and M. Akgün, *J. Supercrit. Fluids*, 2012, **69**, 57–63.
- 125 A. Miller, D. Hendry, N. Wilkinson, C. Venkatasamy and W. Jacoby, *Bioresour. Technol.*, 2012, **119**, 41–47.
- 126 V. Sricharoenchaikul, *Bioresour. Technol.*, 2009, **100**, 638–643.
- 127 J. Yanik, S. Ebale, A. Kruse, M. Saglam and M. Yüksel, *Fuel*, 2007, **86**, 2410–2415.
- 128 W. Feng, H. J. Van Der Kooi and J. De Swaan Arons, *Chem. Eng. Process.*, 2004, **43**, 1459–1467.
- 129 P. Azadi and R. Farnood, *Int. J. Hydrogen Energy*, 2011, **36**, 9529–9541.
- 130 D. C. Elliott, *Biofuels, Bioprod. Biorefin.*, 2008, **2**, 254–265.
- 131 F. Marias, S. Letellier, P. Cezac and J. P. Serin, *Biomass Bioenergy*, 2011, **35**, 59–73.
- 132 Y. Lu, L. Guo, X. Zhang and Q. Yan, *Chem. Eng. J.*, 2007, **131**, 233–244.
- 133 D. Castello and L. Fiori, *Bioresour. Technol.*, 2011, **102**, 7574–7582.
- 134 N. H. Florin and A. T. Harris, *Chem. Eng. Sci.*, 2008, **63**, 287–316.
- 135 P. McKendry, *Bioresour. Technol.*, 2002, **83**, 55–63.
- 136 L. Han, Q. Wang, Y. Yang, C. Yu, M. Fang and Z. Luo, *Int. J. Hydrogen Energy*, 2011, **36**, 4820–4829.
- 137 D. Sutton, B. Kelleher and J. R. H. Ross, *Fuel Process. Technol.*, 2001, **73**, 155–173.
- 138 X. Xiao, D. D. Le, L. Li, X. Meng, J. Cao, K. Morishita and T. Takarada, *Biomass Bioenergy*, 2010, **34**, 1505–1512.
- 139 N. H. Florin and A. T. Harris, *Int. J. Hydrogen Energy*, 2007, **32**, 4119–4134.
- 140 S. Rapagná, H. Provendier, C. Petit, A. Kiennemann and P. U. Foscolo, *Biomass Bioenergy*, 2002, **22**, 377–388.
- 141 D. Ross, R. Noda, M. Horio, A. Kosminski, P. Ashman and P. Mullinger, *Fuel*, 2007, **86**, 1417–1429.
- 142 P. Weerachanchai, M. Horio and C. Tangsathitkulchai, *Bioresour. Technol.*, 2009, **100**, 1419–1427.
- 143 S. Chen, D. Wang, Z. Xue, X. Sun and W. Xiang, *Int. J. Hydrogen Energy*, 2011, **36**, 4887–4899.
- 144 M. Balat, M. Balat, E. Kirtay and H. Balat, *Energy Convers. Manage.*, 2009, **50**, 3158–3168.
- 145 A. Tanksale, J. N. Beltramini and G. M. Lu, *Renewable Sustainable Energy Rev.*, 2010, **14**, 166–182.
- 146 B. Acharya, A. Dutta and P. Basu, *Energy Fuels*, 2009, **23**, 5077–5083.
- 147 B. Acharya, A. Dutta and P. Basu, *Int. J. Hydrogen Energy*, 2010, **35**, 1582–1589.
- 148 H. Guoxin and H. Hao, *Biomass Bioenergy*, 2009, **33**, 899–906.
- 149 T. Hanaoka, T. Yoshida, S. Fujimoto, K. Kamei, M. Harada, Y. Suzuki, H. Hatano, S. Y. Yokoyama and T. Minowa, *Biomass Bioenergy*, 2005, **28**, 63–68.
- 150 N. Howaniec and A. Smoliński, *Int. J. Hydrogen Energy*, 2011, **36**, 2038–2043.
- 151 L. Wei, S. Xu, J. Liu, C. Liu and S. Liu, *Energy Fuels*, 2008, **22**, 1997–2004.
- 152 C. Pfeifer, B. Puchner and H. Hofbauer, *Int. J. Chem. React. Eng.*, 2007, **5**, A9, DOI: 10.2202/1542-6580.1395.
- 153 C. Pfeifer, B. Puchner and H. Hofbauer, *Chem. Eng. Sci.*, 2009, **64**, 5073–5083.
- 154 V. Manovic and E. J. Anthony, *Int. J. Environ. Res. Public Health*, 2010, **7**, 3129–3140.
- 155 L. S. Fan and F. Li, *Ind. Eng. Chem. Res.*, 2010, **49**(21), 10200–10201.
- 156 B. Moghtaderi, *Energy Fuels*, 2012, **26**, 15–40.
- 157 A. Raheem, W. A. K. G. Wan Azlina, Y. H. Taufiq Yap, M. K. Danquah and R. Harun, *Renewable Sustainable Energy Rev.*, 2015, **49**, 990–999.
- 158 T. Shirvani, X. Yan, O. R. Inderwildi, P. P. Edwards and D. A. King, *Energy Environ. Sci.*, 2011, **4**, 3773–3778.
- 159 A. G. Chakinala, D. W. Brilman, W. P. van Swaaij and S. R. Kersten, *Ind. Eng. Chem. Res.*, 2009, **49**, 1113–1122.
- 160 A. Demirbas, *Energy Sources, Part A*, 2009, **31**, 746–753.
- 161 A. Hirano, K. Hon-Nami, S. Kunito, M. Hada and Y. Ogushi, *Catal. Today*, 1998, **45**, 399–404.
- 162 X. Miao and Q. Wu, *J. Biotechnol.*, 2004, **110**, 85–93.
- 163 T. Minowa and S. Sawayama, *Fuel*, 1999, **78**, 1213–1215.
- 164 W. Peng, Q. Wu and P. Tu, *J. Appl. Physiol.*, 2000, **12**, 147–152.
- 165 S. Grierson, V. Strezov, G. Ellem, R. Mcgregor and J. Herbertson, *J. Anal. Appl. Pyrolysis*, 2009, **85**, 118–123.
- 166 A. E. Harman-Ware, T. Morgan, M. Wilson, M. Crocker, J. Zhang, K. Liu, J. Stork and S. Debolt, *Renewable Energy*, 2013, **60**, 625–632.
- 167 X. Miao, Q. Wu and C. Yang, *J. Anal. Appl. Pyrolysis*, 2004, **71**, 855–863.
- 168 T. M. Brown, P. Duan and P. E. Savage, *Energy Fuels*, 2010, **24**, 3639–3646.
- 169 Y. Dote, S. Sawayama, S. Inoue, T. Minowa and S.-y. Yokoyama, *Fuel*, 1994, **73**, 1855–1857.
- 170 T.-o. Matsui, A. Nishihara, C. Ueda, M. Ohtsuki, N.-o. Ikenaga and T. Suzuki, *Fuel*, 1997, **76**, 1043–1048.
- 171 T. Minowa, S.-y. Yokoyama, M. Kishimoto and T. Okakura, *Fuel*, 1995, **74**, 1735–1738.
- 172 S. Zou, Y. Wu, M. Yang, C. Li and J. Tong, *Energy Environ. Sci.*, 2010, **3**, 1073–1078.
- 173 K. L. Kadam, *Energy*, 2002, **27**, 905–922.
- 174 M. Carrier, A. Loppinet-Serani, D. Denux, J. M. Lasnier, F. Ham-Pichavant, F. Cansell and C. Aymonier, *Biomass Bioenergy*, 2011, **35**, 298–307.
- 175 D. J. Lloyd, *Chemistry of the Proteins and its Economic Applications.*, J & A Churchill, London, 1926.
- 176 T. Werpy, G. Petersen, A. Aden, J. Bozell, J. Holladay, J. White, A. Manheim, D. Eliot, L. Lasure and S. Jones, Department of Energy, Washington USA, Aug 2004.
- 177 P. Parthasarathy and K. S. Narayanan, *Renewable Energy*, 2014, **66**, 570–579.
- 178 P. Basu, in *Biomass Gasification, Pyrolysis and Torrefaction*, ed. P. Basu, Academic Press, Boston, 2nd edn, 2013, pp. 47–86.
- 179 K. Gao and K. R. McKinley, *J. Appl. Physiol.*, 1994, **6**, 45–60.
- 180 L. Sanchez-Silva, D. López-González, J. Villaseñor, P. Sanchez and J. Valverde, *Bioresour. Technol.*, 2012, **109**, 163–172.
- 181 A. Bridgwater, *Fuel*, 1995, **74**, 631–653.



- 182 E. Henrich, S. Bürkle, Z. Meza-Renken and S. Rumpel, *J. Anal. Appl. Pyrolysis*, 1999, **49**, 221–241.
- 183 P. C. A. Bergman, *ECN Report, Energy Research Center of the Netherlands, ECN-C-05-073*, The Netherlands, 2005.
- 184 C. Font Palma, *Appl. Energy*, 2013, **111**, 129–141.
- 185 J. Hrdlicka, D. Carpenter, M. Pomeroy, in *Technical report, Parametric gasification of oak and pine feedstocks using the TCPDU and slipstream water–gas shift catalysis*, National Renewable Energy Laboratories, NREL/TP-510-44557, Golden, Colorado, USA, 2008.
- 186 T. Hosoya, H. Kawamoto and S. Saka, *J. Anal. Appl. Pyrolysis*, 2007, **80**, 118–125.
- 187 D. Lv, M. Xu, X. Liu, Z. Zhan, Z. Li and H. Yao, *Fuel Process. Technol.*, 2010, **91**, 903–909.
- 188 P. Azadi, O. R. Inderwildi, R. Farnood and D. A. King, *Renewable Sustainable Energy Rev.*, 2013, **21**, 506–523.
- 189 M. Ni, D. Y. C. Leung, M. K. H. Leung and K. Sumathy, *Fuel Process. Technol.*, 2006, **87**, 461–472.
- 190 A. A. Boateng, W. P. Walawender, L. T. Fan and C. S. Chee, *Bioresour. Technol.*, 1992, **40**, 235–239.
- 191 A. C. C. Chang, H. F. Chang, F. J. Lin, K. H. Lin and C. H. Chen, *Int. J. Hydrogen Energy*, 2011, **36**, 14252–14260.
- 192 N. Gao, A. Li and C. Quan, *Bioresour. Technol.*, 2009, **100**, 4271–4277.
- 193 N. Gao, A. Li, C. Quan and F. Gao, *Int. J. Hydrogen Energy*, 2008, **33**, 5430–5438.
- 194 J. Herguido, J. Corella and J. González-Saiz, *Ind. Eng. Chem. Res.*, 1992, **31**, 1274–1282.
- 195 S. Turn, C. Kinoshita, Z. Zhang, D. Ishimura and J. Zhou, *Int. J. Hydrogen Energy*, 1998, **23**, 641–648.
- 196 M. Asadullah, T. Miyazawa, S.-i. Ito, K. Kunitomi and K. Tomishige, *Appl. Catal., A*, 2003, **246**, 103–116.
- 197 C. Di Blasi, *Prog. Energy Combust. Sci.*, 2009, **35**, 121–140.
- 198 S. Sinthaworn and P. Nimityongskul, *Waste Manage.*, 2009, **29**, 1526–1531.
- 199 L. Fryda, K. Panopoulos, P. Vourliotis, E. Pavlidou and E. Kakaras, *Fuel*, 2006, **85**, 1685–1699.
- 200 D. Vamvuka, D. Zografos and G. Alevizos, *Bioresour. Technol.*, 2008, **99**, 3534–3544.
- 201 M. Sakawa, Y. Sakurai and Y. Hara, *Fuel*, 1982, 717.
- 202 M. Guo, W. Song and J. Buhain, *Renewable Sustainable Energy Rev.*, 2015, **42**, 712–725.
- 203 G. W. Huber and A. Corma, *Angew. Chem., Int. Ed.*, 2007, **46**, 7184–7201.
- 204 D. Rajagopal, S. E. Sexton, D. Roland-Holst and D. Zilberman, *Environ. Res. Lett.*, 2007, **2**, 044004, DOI: 10.1088/1748-9326/2/4/044004.
- 205 T. Yoshida, Y. Oshima and Y. Matsumura, *Biomass Bioenergy*, 2004, **26**, 71–78.
- 206 Y. Richardson, J. Blin and A. Julbe, *Prog. Energy Combust. Sci.*, 2012, **38**, 765–781.
- 207 C. Wan, F. Yu, Y. Zhang, Q. Li and J. Wooten, *J. Biobased Mater. Bioenergy*, 2013, **7**, 690–695.
- 208 R. Luque, L. Herrero-Davila, J. M. Campelo, J. H. Clark, J. M. Hidalgo, D. Luna, J. M. Marinas and A. A. Romero, *Energy Environ. Sci.*, 2008, **1**, 542–564.
- 209 J. M. Bergthorson and M. J. Thomson, *Renewable Sustainable Energy Rev.*, 2015, **42**, 1393–1417.
- 210 A. Demirbas, *Prog. Energy Combust. Sci.*, 2007, **33**, 1–18.
- 211 A. Eliassi, L. Savadkoobi and A. Kargari, *Chem. Eng. Commun.*, 2007, **194**, 1495–1502.
- 212 J. Pickett, D. Anderson, D. Bowles, T. Bridgwater, P. Jarvis, N. Mortimer, M. Poliakoff and J. Woods, *Sustainable Biofuels: Prospects and Challenges*, The Royal Society, London, UK, 2008.
- 213 F. Yaripour, F. Baghaei, I. Schmidt and J. Perregaard, *Catal. Commun.*, 2005, **6**, 147–152.
- 214 O. Beaumont and Y. Schwob, *Ind. Eng. Chem. Process Des. Dev.*, 1984, **23**, 637–641.
- 215 C. Di Blasi, *Ind. Eng. Chem. Res.*, 1996, **35**, 37–46.
- 216 C. Di Blasi and C. Branca, *Energy Fuels*, 2003, **17**, 247–254.
- 217 M. Van de Velden, J. Baeyens, A. Brems, B. Janssens and R. Dewil, *Renewable Energy*, 2010, **35**, 232–242.
- 218 UK Forestry Commission Publication, [http://www.forestry.gov.uk/pdf/eng-yh-seasoningwoodforfuel.pdf/\\$FILE/eng-yh-seasoningwoodforfuel.pdf](http://www.forestry.gov.uk/pdf/eng-yh-seasoningwoodforfuel.pdf/$FILE/eng-yh-seasoningwoodforfuel.pdf), accessed November 2011.
- 219 H. Balat and E. Kirtay, *Int. J. Hydrogen Energy*, 2010, **35**, 7416–7426.
- 220 G. Schuster, G. Löffler, K. Weigl and H. Hofbauer, *Bioresour. Technol.*, 2001, **77**, 71–79.
- 221 S. Luo, B. Xiao, X. Guo, Z. Hu, S. Liu and M. He, *Int. J. Hydrogen Energy*, 2009, **34**, 1260–1264.
- 222 L. Wei, S. Xu, J. Liu, C. Liu and S. Liu, *Energy Fuels*, 2008, **22**, 1997–2004.
- 223 P. Lv, Z. Xiong, J. Chang, C. Wu, Y. Chen and J. Zhu, *Bioresour. Technol.*, 2004, **95**, 95–101.
- 224 S. Luo, B. Xiao, X. Guo, Z. Hu, S. Liu and M. He, *Int. J. Hydrogen Energy*, 2009, **34**, 1260–1264.
- 225 J. J. Hernández, G. Aranda-Almansa and A. Bula, *Fuel Process. Technol.*, 2010, **91**, 681–692.
- 226 N. Jand and P. U. Foscolo, *Ind. Eng. Chem. Res.*, 2005, **44**, 5079–5089.
- 227 S. Rapagnà and G. M. di Celso, *Biomass Bioenergy*, 2008, **32**, 1123–1129.
- 228 A. v. d. Drift, H. Boerrigter, B. Coda, M. K. Cieplik and K. Hemmes, *Entrained flow gasification of biomass*, ECN and Shell Global Solutions, ECN-C-04-039, The Netherlands, 2004.
- 229 V. Kirubakaran, V. Sivaramkrishnan, R. Nalini, T. Sekar, M. Premalatha and P. Subramanian, *Renewable Sustainable Energy Rev.*, 2009, **13**, 179–186.
- 230 A. Demirbas, *Energy Sources, Part A*, 2009, **31**, 1728–1736.
- 231 M. He, Z. Hu, B. Xiao, J. Li, X. Guo, S. Luo, F. Yang, Y. Feng, G. Yang and S. Liu, *Int. J. Hydrogen Energy*, 2009, **34**, 195–203.
- 232 A. Inayat, M. M. Ahmad, M. I. A. Mutalib and S. Yusup, *J. Appl. Sci.*, 2010, **10**, 3183–3190.
- 233 A. Kumar, K. Eskridge, D. D. Jones and M. A. Hanna, *Bioresour. Technol.*, 2009, **100**, 2062–2068.
- 234 J. Li, Y. Yin, X. Zhang, J. Liu and R. Yan, *Int. J. Hydrogen Energy*, 2009, **34**, 9108–9115.
- 235 P. M. Lv, Z. H. Xiong, J. Chang, C. Z. Wu, Y. Chen and J. X. Zhu, *Bioresour. Technol.*, 2004, **95**, 95–101.



- 236 M. Massoudi Farid, H. J. Jeong and J. Hwang, *Fuel*, 2015, **162**, 234–238.
- 237 I. Narvaez, A. Orio, M. P. Aznar and J. Corella, *Ind. Eng. Chem. Res.*, 1996, **35**, 2110–2120.
- 238 S. Sharma and P. N. Sheth, *Energy Convers. Manage.*, 2016, **110**, 307–318.
- 239 J. Zhou, S. M. Masutani, D. M. Ishimura, S. Q. Turn and C. M. Kinoshita, *Ind. Eng. Chem. Res.*, 2000, **39**, 626–634.
- 240 C. Hanping, L. Bin, Y. Haiping, Y. Guolai and Z. Shihong, *Energy Fuels*, 2008, **22**, 3493–3498.
- 241 M. C. Palancar, M. Serrano and J. M. Aragón, *Powder Technol.*, 2009, **194**, 42–50.
- 242 T. Reed and A. Das, *Handbook of biomass downdraft gasifier engine systems*, Biomass Energy Foundation, USA, 1988.
- 243 M. A. Hamad, A. M. Radwan, D. A. Heggo and T. Moustafa, *Renewable Energy*, 2016, **85**, 1290–1300.
- 244 J. H. Kihedu, R. Yoshiie and I. Naruse, *Fuel Process. Technol.*, 2016, **141**(part 1), 93–98.
- 245 Z. Ud Din and Z. A. Zainal, *Renewable Sustainable Energy Rev.*, 2016, **53**, 1356–1376.
- 246 Z. Wang, T. He, J. Qin, J. Wu, J. Li, Z. Zi, G. Liu, J. Wu and L. Sun, *Fuel*, 2015, **150**, 386–393.
- 247 P. Corte, C. Lacoste and J. P. Traverse, *J. Anal. Appl. Pyrolysis*, 1985, **7**, 323–335.
- 248 J. Arauzo, D. Radlein, J. Piskorz and D. S. Scott, *Ind. Eng. Chem. Res.*, 1997, **36**, 67–75.
- 249 L. Garcia, A. Benedicto, E. Romeo, M. L. Salvador, J. Arauzo and R. Bilbao, *Energy Fuels*, 2002, **16**, 1222–1230.
- 250 D. Alvarez, M. Peña and A. G. Borrego, *Energy Fuels*, 2007, **21**, 1534–1542.
- 251 M. Asadullah, K. Fujimoto and K. Tomishige, *Ind. Eng. Chem. Res.*, 2001, **40**, 5894–5900.
- 252 A. K. Dalai, E. Sasaoka, H. Hikita and D. Ferdoust, *Energy Fuels*, 2003, **17**, 1456–1463.
- 253 B. Feng, H. An and E. Tan, *Energy Fuels*, 2007, **21**, 426–434.
- 254 J. Gil, M. A. Caballero, J. A. Martín, M. P. Aznar and J. Corella, *Ind. Eng. Chem. Res.*, 1999, **38**, 4226–4235.
- 255 J. Guan, Q. Wang, X. Li, Z. Luo and K. Cen, *Renewable Energy*, 2007, **32**, 2502–2515.
- 256 H. Gupta and L. S. Fan, *Ind. Eng. Chem. Res.*, 2002, **41**, 4035–4042.
- 257 S. Lin, M. Harada, Y. Suzuki and H. Hatano, *Fuel*, 2006, **85**, 1143–1150.
- 258 M. R. Mahishi and D. Y. Goswami, *Int. J. Hydrogen Energy*, 2007, **32**, 2803–2808.
- 259 B. Moghtaderi, *Fuel*, 2007, **86**, 2422–2430.
- 260 A. B. Rao and E. S. Rubin, *Environ. Sci. Technol.*, 2002, **36**, 4467–4475.
- 261 D. P. Harrison, *Greenhouse Gas Control Technologies*, Elsevier Science Ltd, Oxford, UK, 2005.
- 262 D. P. Harrison, *Energy Procedia*, 2009, **1**, 675–681.
- 263 A. Silaban, M. Narcida and D. P. Harrison, *Resour. Conserv. Recycl.*, 1992, **7**, 139–153.
- 264 L. Devi, K. J. Ptasinski and F. J. G. Janssen, *Biomass Bioenergy*, 2002, **24**, 125–140.
- 265 E. M. Fitzpatrick, K. D. Bartle, M. L. Kubacki, J. M. Jones, M. Pourkashanian, A. B. Ross, A. Williams and K. Kubica, *Fuel*, 2009, **88**, 2409–2417.
- 266 P. Morf, P. Hasler and T. Nussbaumer, *Fuel*, 2002, **81**, 843–853.
- 267 J. Han and H. Kim, *Renewable Sustainable Energy Rev.*, 2008, **12**, 397–416.
- 268 H. Yang, R. Yan, H. Chen, C. Zheng, D. H. Lee and D. T. Liang, *Energy Fuels*, 2006, **20**, 388–393.
- 269 Y. Zhang, S. Kajitani, M. Ashizawa and Y. Oki, *Fuel*, 2009, **89**, 302–309.
- 270 M. Asmadi, H. Kawamoto and S. Saka, *J. Anal. Appl. Pyrolysis*, 2011, **92**, 417–425.
- 271 H. E. Jegers and M. T. Klein, *Ind. Eng. Chem. Process Des. Dev.*, 1985, **24**, 173–183.
- 272 A. L. Sullivan and R. Ball, *Atmos. Environ.*, 2012, **47**, 133–141.
- 273 L. Burhenne, J. Messmer, T. Aicher and M. P. Laborie, *J. Anal. Appl. Pyrolysis*, 2013, **101**, 177–184.
- 274 S. Mahapatra and S. Dasappa, *Energy Sustainable Dev.*, 2014, **19**, 122–129.
- 275 S. Anis and Z. A. Zainal, *Renewable Sustainable Energy Rev.*, 2011, **15**, 2355–2377.
- 276 C. M. Kinoshita, Y. Wang and J. Zhou, *J. Anal. Appl. Pyrolysis*, 1994, **29**, 169–181.
- 277 R. A. Knight, *Biomass Bioenergy*, 2000, **18**, 67–77.
- 278 S. A. Nair, K. Yan, A. J. M. Pemen, G. J. J. Winands, F. M. van Gompel, H. E. M. van Leuken, E. J. M. van Heesch, K. J. Ptasinski and A. A. H. Drinkenburg, *J. Electrostat.*, 2004, **61**, 117–127.
- 279 L. Fagbemi, L. Khezami and R. Capart, *Appl. Energy*, 2001, **69**, 293–306.
- 280 Z. Abu El-Rub, E. A. Bramer and G. Brem, *Fuel*, 2008, **87**, 2243–2252.
- 281 L. Devi, K. J. Ptasinski and F. J. G. Janssen, *Fuel Process. Technol.*, 2005, **86**, 707–730.
- 282 P. Gilbert, C. Ryu, V. Sharifi and J. Swithenbank, *Bioresour. Technol.*, 2009, **100**, 6045–6051.
- 283 P. Lv, Z. Yuan, L. Ma, C. Wu, Y. Chen and J. Zhu, *Renewable Energy*, 2007, **32**, 2173–2185.
- 284 M. Asadullah, T. Miyazawa, S.-i. Ito, K. Kunimori, S. Koyama and K. Tomishige, *Biomass Bioenergy*, 2004, **26**, 269–279.
- 285 S. O. Negro, R. A. A. Suurs and M. P. Hekkert, *Technol. Forecast. Soc.*, 2008, **75**, 57–77.
- 286 L. Dong, M. Asadullah, S. Zhang, X. S. Wang, H. Wu and C. Z. Li, *Fuel*, 2013, **108**, 409–416.
- 287 UN Food and Agriculture Organization Papers, <http://www.fao.org/forestry/62269/en/>, accessed 1986.
- 288 E. C. Beagle, *Proceedings of the first international producer gas conference*, Colombo, Sri Lanka, 1982.
- 289 Babcock and Wilcox Volund Brochures, http://www.volund.dk/~media/downloads/brochures-BIO/biomass_gasification_plants.pdf, accessed 2011.
- 290 Swedish Energy Agency Report, http://www.ieatask33.org/app/webroot/files/file/publications/new/Small%20Small_scale_gasification_overview.pdf, accessed May 2011.



- 291 R. Rauch, J. Hrbek and H. Hofbauer, *Wiley Interdiscip. Rev.: Energy Environ.*, 2014, **3**, 343–362.
- 292 International Energy Agency Report, http://www.ieabcc.nl/meetings/32_03_meeting_SaltLakeCity.pdf, accessed February 2003.
- 293 International Energy Agency Report, http://www.ieabcc.nl/meetings/32_03_meeting_SaltLakeCity.pdf, accessed February 2003.
- 294 R. Rauch, M. Bolhar-Nordenkampf, K. Bosch, C. Aichernig, H. Hofbauer, *International Conference on Biomass Utilization*, Thailand, June 2002.
- 295 A. F. Kirkels and G. P. J. Verbong, *Renewable Sustainable Energy Rev.*, 2011, **15**, 471–481.
- 296 R. Kramreiter, M. Url, J. Kotik and H. Hofbauer, *Fuel Process. Technol.*, 2008, **89**, 90–102.
- 297 M + W Group Germany Brochure, http://www.mwgroup.net/wp-content/uploads/2014/11/Brochure_CHP_Generation_EN.pdf, accessed 2014.
- 298 Z. Zhou, X. Yin, J. Xu and L. Ma, *Energy Policy*, 2012, **51**, 52–57.
- 299 U. Arena, F. Di Gregorio and M. Santonastasi, *Chem. Eng. J.*, 2010, **162**, 580–590.
- 300 C. Bang-Møller, M. Rokni and B. Elmegaard, *Energy*, 2011, **36**, 4740–4752.
- 301 C. Bang-Møller, M. Rokni, B. Elmegaard, J. Ahrenfeldt and U. B. Henriksen, *Energy*, 2013, **58**, 527–537.
- 302 S. Bengtsson, *Biomass Bioenergy*, 2011, **35**, S2–S7.
- 303 F. Hamdullahpur, C. O. Colpan, I. Dincer, *Proceedings of the 18th World Hydrogen Energy Conference*, 2010, pp. 305–313.
- 304 W. Doherty, A. Reynolds and D. Kennedy, *Energy*, 2010, **35**, 4545–4555.
- 305 A. Giuffrida, M. C. Romano and G. Lozza, *Energy*, 2013, **53**, 221–229.
- 306 Gussing and Trisaia Plants Online Report, <http://www.uniqueproject.eu/public/deliverables/D7.2.pdf>, accessed December 2010.
- 307 US Environmental Protection Agency, http://www3.epa.gov/chp/documents/biomass_chp_catalog.pdf, accessed September 2007.
- 308 A. J. Minchener, *Fuel*, 2005, **84**, 2222–2235.
- 309 M. Morandin, F. Maréchal and S. Giacomini, *Biomass Bioenergy*, 2013, **49**, 299–314.
- 310 F. P. Nagel, S. Ghosh, C. Pitta, T. J. Schildhauer and S. Biollaz, *Biomass Bioenergy*, 2011, **35**, 354–362.
- 311 F. P. Nagel, T. J. Schildhauer, N. McCaughey and S. M. A. Biollaz, *Int. J. Hydrogen Energy*, 2009, **34**, 6826–6844.
- 312 K. Ståhl and M. Neergaard, *Biomass Bioenergy*, 1998, **15**, 205–211.
- 313 S. Wongchanapai, H. Iwai, M. Saito and H. Yoshida, *J. Power Sources*, 2012, **216**, 314–322.
- 314 K. K., PhD thesis, Aalborg University, 2009.
- 315 P. Stoholm, R. G. Nielsen, L. Sarbaek and L. Tobiasen, 12th European Biomass Conference, Amsterdam, 2002.
- 316 J. Lehmann and S. Joseph, *Biochar for Environmental Management – Science and Technology*, Earth Scan, London, 2009.
- 317 L. D., *North American Biochar Conference*, Boulder, Colorado, USA, Aug 2009.
- 318 S. Joseph and J. Lehmann, *Biochar for Environmental Management – Science and Technology*, Earth Scan, London, 2009.
- 319 M. Rillig and J. E. Thies, *Biochar for Environmental Management – Science and Technology*, Earth Scan, London, 2009.
- 320 A. Abuadala and I. Dincer, *Int. J. Hydrogen Energy*, 2011, **36**, 12780–12793.
- 321 A. Bhattacharya, A. Bhattacharya and A. Datta, *Int. J. Hydrogen Energy*, 2012, **37**, 18782–18790.
- 322 Unique Gasifier for Hydrogen Production Research Project Report, <http://www.unifhy.eu>, accessed September 2012.
- 323 S. Shabani, M. Aghajani Delavar and M. Azmi, *Int. J. Hydrogen Energy*, 2013, **38**, 3630–3639.
- 324 R. Toonsen, N. Woudstra and A. H. M. Verkooijen, *Int. J. Hydrogen Energy*, 2008, **33**, 4074–4082.
- 325 S. S. Ail and S. Dasappa, *Renewable Sustainable Energy Rev.*, 2016, **58**, 267–286.
- 326 E. van Steen and M. Claeys, *Chem. Eng. Technol.*, 2008, **31**, 655–666.
- 327 J. M. Bergthorson and M. J. Thomson, *Renewable Sustainable Energy Rev.*, 2015, **42**, 1393–1417.
- 328 M. Åhman, *Energy Policy*, 2010, **38**, 208–217.
- 329 E. Fahlén and E. O. Ahlgren, *Energy*, 2009, **34**, 2184–2195.
- 330 R. Felder and R. Dones, *Biomass Bioenergy*, 2007, **31**, 403–415.
- 331 L. Shuying, W. Guocai and P. DeLaquil, *Energy Sustainable Dev.*, 2001, **5**, 47–53.
- 332 B. Steubing, R. Zah and C. Ludwig, *Biomass Bioenergy*, 2011, **35**, 2950–2960.
- 333 T. Gröbl, H. Walter and M. Haider, *Appl. Energy*, 2012, **97**, 451–461.
- 334 J. Kopyscinski, T. J. Schildhauer and S. M. A. Biollaz, *Fuel*, 2010, **89**, 1763–1783.
- 335 C. M. van der Meijden, H. J. Veringa and L. P. L. M. Rabou, *Biomass Bioenergy*, 2010, **34**, 302–311.
- 336 E. Dotzauer, D. Djuric Ilic, L. Trygg and G. Broman, *J Clean Prod.*, 2013.
- 337 P. Haro, P. Ollero, A. L. Villanueva Perales and A. Gómez-Barea, *Appl. Energy*, 2013, **102**, 950–961.
- 338 J. C. Meerman, A. Ramírez, W. C. Turkenburg and A. P. C. Faaij, *Renewable Sustainable Energy Rev.*, 2012, **16**, 6083–6102.
- 339 A. Narvaez, D. Chadwick and L. Kershenbaum, *Appl. Energy*, 2014, **113**, 1109–1117.
- 340 K. S. Ng and J. Sadhukhan, *Biomass Bioenergy*, 2011, **35**, 3218–3234.
- 341 E. Wetterlund, S. Leduc, E. Dotzauer and G. Kindermann, *Energy*, 2012, **41**, 462–472.
- 342 P. Hottinger, S. Biollaz, C. Pitta, J. Karl, *Proceedings of 17th European Biomass Conference and Exhibition*, Hamburg, Germany, 2009.
- 343 C. R. Vitasari, M. Jurascik and K. J. Ptasiniski, *Energy*, 2011, **36**, 3825–3837.
- 344 S. Wirth and J. Markard, *Technol. Forecas. Soc.*, 2011, **78**, 635–649.



- 345 B. F. Möller, A. Molin and K. Stahl, *The Third International Conference on Thermo-chemical Conversion of Biomass*, Chicago USA, 2013.
- 346 GoBiGas Project Online Information, <http://gobigas.goteborgenergi.se/En/>, accessed 2013.
- 347 G. I, presented in part at *Baltic Bioenergy*, Oslo, May, 2013.
- 348 T. Schildhauer, S. Biollaz, D. Ulrich, H. Tremmel, R. Rauch and M. Koch, *Proceedings of 17th European Biomass Conference and Exhibition*, Hamburg, Germany, 2009.
- 349 M. L. de Souza-Santos, *Solid Fuels Combustion and Gasification: Modeling, Simulation*, CRC Press, 2010.
- 350 A. K. Sharma, *Sol. Energy*, 2008, **82**, 918–928.
- 351 Y. Wang and L. Yan, *Int. J. Mol. Sci.*, 2008, **9**, 1108–1130.
- 352 M. Puig-Arnavat, J. A. Hernández, J. C. Bruno and A. Coronas, *Biomass Bioenergy*, 2013, **49**, 279–289.
- 353 I. S. Antonopoulos, A. Karagiannidis, A. Gkouletsos and G. Perkoulidis, *Waste Manage.*, 2012, **32**, 710–718.
- 354 E. Azzone, M. Morini and M. Pinelli, *Renewable Energy*, 2012, **46**, 248–254.
- 355 B. V. Babu and P. N. Sheth, *Energy Convers. Manage.*, 2006, **47**, 2602–2611.
- 356 N. S. Barman, S. Ghosh and S. De, *Bioresour. Technol.*, 2012, **107**, 505–511.
- 357 J. Gao, Y. Zhao, S. Sun, H. Che, G. Zhao and J. Wu, *Chem. Eng. J.*, 2012, **213**, 97–103.
- 358 A. Melgar, J. F. Pérez, H. Laget and A. Horillo, *Energy Convers. Manage.*, 2007, **48**, 59–67.
- 359 A. K. Sharma, *Energy Convers. Manage.*, 2008, **49**, 832–842.
- 360 K. Sandeep and S. Dasappa, *Int. J. Hydrogen Energy*, 2014, **39**, 19474–19484.
- 361 M. Rokni, *Int. J. Hydrogen Energy*, 2015, **40**, 7855–7869.
- 362 S. Vakalis, F. Patuzzi and M. Baratieri, *Bioresour. Technol.*, 2016, **206**, 173–179.
- 363 W. Doherty, A. Reynolds and D. Kennedy, *Biomass Bioenergy*, 2009, **33**, 1158–1167.
- 364 A. Gungor, *Int. J. Hydrogen Energy*, 2011, **36**, 6592–6600.
- 365 I. Hannula and E. Kurkela, *Biomass Bioenergy*, 2012, **38**, 58–67.
- 366 P. Kaushal, T. Proell and H. Hofbauer, *Biomass Bioenergy*, 2011, **35**, 2491–2498.
- 367 C. Loha, P. K. Chatterjee and H. Chattopadhyay, *Energy Convers. Manage.*, 2011, **52**, 1583–1588.
- 368 T. D. B. Nguyen, S. I. Ngo, Y. I. Lim, J. W. Lee, U. D. Lee and B. H. Song, *Energy Convers. Manage.*, 2012, **54**, 100–112.
- 369 J. Xie, W. Zhong, B. Jin, Y. Shao and H. Liu, *Bioresour. Technol.*, 2012, **121**, 36–46.
- 370 P. Baggio, M. Baratieri, L. Fiori, M. Grigante, D. Avi and P. Tosi, *Energy Convers. Manage.*, 2009, **50**, 1426–1435.
- 371 A. Deydier, F. Marias, P. Bernada, F. Couture and U. Michon, *Biomass Bioenergy*, 2011, **35**, 133–145.
- 372 A. Pirc, M. Sekavčnik and M. Mori, *Stroj. Vestn.-J. Mech. E.*, 2012, **58**, 291–299.
- 373 X. T. Li, J. R. Grace, C. J. Lim, A. P. Watkinson, H. P. Chen and J. R. Kim, *Biomass Bioenergy*, 2004, **26**, 171–193.
- 374 M. K. Karmakar and A. B. Datta, *Bioresour. Technol.*, 2011, **102**, 1907–1913.
- 375 E. D. Gordillo and A. Belghit, *Biomass Bioenergy*, 2011, **35**, 2034–2043.
- 376 A. Inayat, M. M. Ahmad, M. I. A. Mutalib and S. Yusup, *Fuel Process. Technol.*, 2012, **93**, 26–34.
- 377 M. B. Nikoo and N. Mahinpey, *Biomass Bioenergy*, 2008, **32**, 1245–1254.
- 378 A. Saravanakumar, M. J. Hagge, T. M. Haridasan and K. M. Bryden, *Biomass Bioenergy*, 2011, **35**, 4248–4260.
- 379 C. C. Sreejith, C. Muraleedharan and P. Arun, *Fuel Process. Technol.*, 2015, **130**, 197–207.
- 380 R. Khonde and A. Chaurasia, *Int. J. Hydrogen Energy*, 2016, **41**, 8793–8802.
- 381 P. Pepiot, C. J. Dibble and T. D. Foust, Computational fluid dynamics modeling of biomass gasification and pyrolysis, in *Computational Modeling in Lignocellulosic Biofuel Production*, ACS Symposium Series, National Renewable Energy Laboratory, USA, 2010, vol. 1052, pp. 273–298.
- 382 C. Di Blasi, *Prog. Energy Combust. Sci.*, 2008, **34**, 47–90.
- 383 I. Janajreh and M. Al Shrah, *Energy Convers. Manage.*, 2013, **65**, 783–792.
- 384 N. Couto, V. Silva, E. Monteiro, P. Brito and A. Rouboa, *Renewable Energy*, 2015, **77**, 174–181.
- 385 E. Savuto, A. Di Carlo, E. Bocci, A. D’Orazio, M. Villarini, M. Carlini and P. U. Foscolo, *Int. J. Hydrogen Energy*, 2015, **40**, 7991–8004.
- 386 M. Kasiri and A. R. Khataee, *Artificial neural network modeling of water and wastewater treatment processes*, NOVA Science Publisher, Inc., USA, 2011.
- 387 C. Sreejith, C. Muraleedharan and P. Arun, *Biomass Convers. Biorefin.*, 2013, **3**, 283–304.
- 388 R. Mikulandrić, D. Lončar, D. Böhning, R. Böhme and M. Beckmann, *Energy Convers. Manage.*, 2015, **104**, 135–146.
- 389 P. Ji, W. Feng and B. Chen, *Chem. Eng. Sci.*, 2009, **64**, 582–592.
- 390 B. Zhao, X. Zhang, L. Chen, R. Qu, G. Meng, X. Yi and L. Sun, *Biomass Bioenergy*, 2010, **34**, 140–144.
- 391 J. Corella, M. A. Caballero, M. P. Aznar and C. Brage, *Ind. Eng. Chem. Res.*, 2003, **42**, 3001–3011.
- 392 W. de Jong, Ö. Ünal, J. Andries, K. R. G. Hein and H. Spliethoff, *Appl. Energy*, 2003, **74**, 425–437.
- 393 R. Radmanesh, J. Cnaouki and C. Guy, *AIChE J.*, 2006, **52**, 4258–4272.
- 394 K. Umeki, T. Namioka and K. Yoshikawa, *Appl. Energy*, 2012, **90**, 38–45.
- 395 K. Umeki, K. Yamamoto, T. Namioka and K. Yoshikawa, *Appl. Energy*, 2010, **87**, 791–798.
- 396 L. Abdelouahed, O. Authier, G. Mauviel, J. P. Corriou, G. Verdier and A. Dufour, *Energy Fuels*, 2012, **26**, 3840–3855.
- 397 J. C. G. Andrae, *Fuel*, 2013, **107**, 740–748.
- 398 K. Norinaga and O. Deutschmann, *Ind. Eng. Chem. Res.*, 2007, **46**, 3547–3557.
- 399 K. Norinaga, O. Deutschmann, N. Saegusa and J. i. Hayashi, *J. Anal. Appl. Pyrolysis*, 2009, **86**, 148–160.
- 400 K. Norinaga, Y. Sakurai, R. Sato and J. I. Hayashi, *Chem. Eng. J.*, 2011, **178**, 282–290.

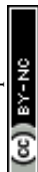

- 401 K. Norinaga, T. Shoji, S. Kudo and J. I. Hayashi, *Fuel*, 2013, **103**, 141–150.
- 402 T. Faravelli, A. Frassoldati, G. Migliavacca and E. Ranzi, *Biomass Bioenergy*, 2010, **34**, 290–301.
- 403 A. Jess, *Fuel*, 1996, **75**, 1441–1448.
- 404 B. Kjellström, *Hazards of producer gas operation*, The Beijer Institute, Stockholm, Sweden, 1984.
- 405 G. San Miguel, M. P. Domínguez, M. Hernández and F. Sanz-Pérez, *Biomass Bioenergy*, 2012, **47**, 134–144.
- 406 M. Kampa and E. Castanas, *Environ. Pollut.*, 2008, **151**, 362–367.
- 407 L. Curtis, W. Rea, P. Smith-Willis, E. Fenyves and Y. Pan, *Environ. Int.*, 2006, **32**, 815–830.
- 408 Q. Sun, X. Hong and L. E. Wold, *Circulation*, 2010, **121**, 2755–2765.
- 409 L. Trasande and G. D. Thurston, *J. Allergy Clin. Immunol.*, 2005, **115**, 689–699.
- 410 L. B. Clarke, *Fuel*, 1993, **72**, 731–736.
- 411 H. Cui, S. Q. Turn, V. Keffer, D. Evans, T. Tran and M. Foley, *Fuel*, 2013, **108**, 1–12.
- 412 J. Lewtas, *Mutat. Res.*, 2007, **636**, 95–133.
- 413 G. Genon, D. Panepinto and F. Viggiano, *WIT Trans. Ecol. Environ.*, 2014, **2**, 995–1006.
- 414 Dong Energy Demnark, <http://www.dongenergy.com/en/investors/company-announcements/company-announcement-detail?omxid=536723>, accessed 2010.
- 415 R. V. Siemons, *Biomass Bioenergy*, 2001, **20**, 271–285.
- 416 H. E. Stassen, in *World Bank Technical Paper*, Small-scale biomass gasifiers for heat and power: a global review, Record Number 19951812605, 1995, pp. xvii + 61.
- 417 Z. Zhang, W. Zhao and W. Zhao, *Sustainability*, 2014, **6**, 9159–9178.
- 418 [https://energypedia.info/wiki/Biomass_Gasification_\(Small-scale\)](https://energypedia.info/wiki/Biomass_Gasification_(Small-scale)), accessed May 2016.
- 419 UNDP India, http://www.in.undp.org/content/india/en/home/operations/projects/environment_and_energy/biomass_energy_forruralindia.html, accessed May 2016.
- 420 N. Ravindranath, H. Somashekar, S. Dasappa and J. C. Reddy, *Curr. Sci.*, 2004, **87**, 932–941.
- 421 H. Garrido, V. Vendeirinho and M. Brito, *Renewable Energy*, 2016, **92**, 47–57.
- 422 K. A. Motghare, A. P. Rathod, K. L. Wasewar and N. K. Labhsetwar, *Waste Manage.*, 2016, **47**, 40–45.
- 423 V. C. J. Singh and S. J. Sekhar, *Appl. Therm. Eng.*, 2015, **97**, 22–27.
- 424 A. Sánchez, E. Torres and R. Kalid, *Renewable Sustainable Energy Rev.*, 2015, **49**, 278–290.
- 425 H. F. V. Flores, T. Furubayashi and T. Nakata, *Clean Technol. Environ.*, 2016, 1–18.
- 426 C. S. Li, N. Mustafa, T. Doevendans, S. A. Chin and A. W. A. Karim Ghani, *Chem. Eng. Trans.*, 2015, **45**, 1441–1446.
- 427 T. Zhang, J. Ni and D. Xie, *Environ. Sci. Pollut. Res.*, 2015, **22**, 16453–16462.
- 428 US Environmental Protection Agency, <https://yosemite.epa.gov/ee/epa/eed.nsf/webpages/biofuels.html>, accessed May 2016.
- 429 A. D. Watt, R. H. W. Bradshaw, J. Young, D. Alard, T. Bolger, D. Chamberlain, F. Fernández-González, R. Fuller, P. Gurra, K. Henle, R. Johnson, Z. Korsós, P. Lavelle, J. Niemelä, P. Nowicki, M. Rebane, C. Scheidegger, J. P. Sousa, C. Van Swaay and A. Vanbergen, *Issues Environ. Sci. Technol.*, 2007, 135–160.
- 430 J. Gressel, *Plant Sci.*, 2008, **174**, 246–263.
- 431 J. C. Lovett, *Afr. J. Ecol.*, 2007, **45**, 117–119.

