



Aalborg Universitet

AALBORG UNIVERSITY
DENMARK

An RF Pulse Width Modulator for Switch-Mode Power Amplification of Varying Envelope Signals

Nielsen, Michael; Larsen, Torben

Published in:
Topical Meeting on Silicon Monolithic Integrated Circuits in RF Systems, 2007

Publication date:
2007

Document Version
Publisher's PDF, also known as Version of record

[Link to publication from Aalborg University](#)

Citation for published version (APA):
Nielsen, M., & Larsen, T. (2007). An RF Pulse Width Modulator for Switch-Mode Power Amplification of Varying Envelope Signals. In *Topical Meeting on Silicon Monolithic Integrated Circuits in RF Systems, 2007* (pp. 277-280). IEEE Signal Processing Society.

General rights

Copyright and moral rights for the publications made accessible in the public portal are retained by the authors and/or other copyright owners and it is a condition of accessing publications that users recognise and abide by the legal requirements associated with these rights.

- Users may download and print one copy of any publication from the public portal for the purpose of private study or research.
- You may not further distribute the material or use it for any profit-making activity or commercial gain
- You may freely distribute the URL identifying the publication in the public portal -

Take down policy

If you believe that this document breaches copyright please contact us at vbn@aub.aau.dk providing details, and we will remove access to the work immediately and investigate your claim.

An RF Pulse Width Modulator for Switch-Mode Power Amplification of Varying Envelope Signals

Michael Nielsen & Torben Larsen

Aalborg University, Department of Electronic Systems, Technology Platforms Section,
Aalborg, Denmark. Phone: +45 96358664, Email: {mn, tl}@kom.aau.dk

Abstract—This paper presents the design of a RF Pulse Width Modulator (RF-PWM) for switched-mode power amplification of varying envelope signals. The general idea is to modulate the varying envelope signal using squarewave signals with varying width and subsequently drive a class D-type power amplifier. The linearity in the modulator is ensured by a novel combination of low frequency feedback combined with predistortion.

Measurements on a frequency wise down-scaled prototype show that the RF-PWM modulator modulates a UMTS signal with more than 17 dB margin to the modulation mask and EVM below 0.5% RMS. This leads to the conclusion that sufficient linearity and modulation accuracy can be obtained using RF Pulse Width Modulation.

I. INTRODUCTION

Traditionally, highly efficient Power Amplifiers (PAs) like class D amplifiers have been limited to transmit constant envelope signals as they are driven as switches. This limitation can be mitigated by combining the PA with a modulator that translates the RF signal with varying envelope into square waves. The resulting system, illustrated in Fig. 1, is a potential candidate to increase the power efficiency while maintaining the necessary linearity [1]. The principle of operation is as follows: The square wave modulator modulates the varying envelope signal into square waves, which is amplified by the highly efficient power amplifier. The envelope and phase information is then contained in the square waves as width and/or timing of the pulses, respectively. An output filter is needed to restore the signal around the carrier frequency.

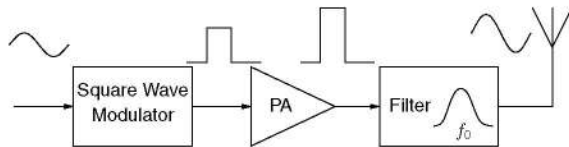

Fig. 1. Illustration of transmitter using modulator and switch-mode PA.

Recently, there has been some interest in utilizing $\Delta\Sigma$ -techniques in the modulator in Fig. 1 [2], [3], [4]. However, because of the inherent quantization noise, $\Delta\Sigma$ -modulators require significant post-PA filtering for communication systems with high requirements for spurious noise such as EDGE and UMTS. The challenge with

spurious noise is an inherent problem with $\Delta\Sigma$ -techniques. RF Pulse Width Modulation (RF-PWM) has been more or less unseen in the wireless world since the early 70's, where Raab presented the concept in 1973 [5]. Unlike $\Delta\Sigma$ -modulation, RF-PWM does not quantize the signal and consequently does not suffer from quantization noise.

This paper presents an RF-PWM modulator where linearity is ensured in a novel configuration utilizing low frequency feedback combined with predistortion. The paper is organized as follows. First, an introduction to RF-PWM is given in Section II. Then, Sections III and IV present the modulator and the prototype design. Finally, Sections V and VI show the measurements along with a conclusion and some remarks on the perspective of implementing the modulator at GHz frequencies.

II. RF PULSE WIDTH MODULATION

The main idea of RF-PWM is to transmit one pulse with a fixed amplitude and varying width of the pulse in each RF period. The envelope and phase are in this case represented by the width and timing of the pulses. The signal is illustrated in time domain in Fig. 2(a).

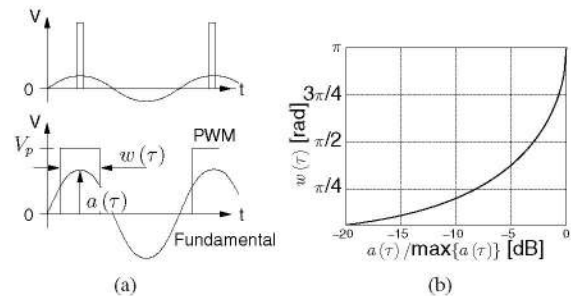

Fig. 2. Illustration of the RF-PWM concept. (a) Time domain representation of PWM signal and its fundamental component. (b) Width of pulse versus normalized envelope ($a(\tau)$). The maximum width is π , which corresponds to a duty-cycle of 50 %.

The envelope of the fundamental frequency component of the pulses can be found by Fourier series expansion as

$$a(\tau) = \frac{2V_p}{\pi} \sin\left(\frac{w(\tau)}{2}\right), \quad (1)$$

where $w(\tau)$ is the width in radians, and τ represents the time in modulation domain. $w(\tau)$ is related to the RF-period by

$$w(\tau) = \frac{T_w}{T_{RF}} 2\pi \text{ [rad]} \quad (2)$$

where T_w and T_{RF} is the duration of the pulse and the RF period, respectively. By solving Eq. (1) with respect to $w(\tau)$, the width as function of the envelope can be found as shown in Fig. 2(b). With the finite rise and fall time of real world signals, the pulses are likely to be trapezoidal in nature and possibly triangular for small values of $a(\tau)$. For systems with large dynamic range it can be expected that some of the pulses will be triangular for small values of the envelope.

III. DESIGN OF A PULSE WIDTH MODULATOR

The modulator can be implemented by a comparator and a DSP with the latter implementing the mapping function as illustrated in Fig. 3(a). The pulses are generated from the comparison in the comparator between an RF-sinewave and the slow varying signal (denoted $A_M(\tau)$) as depicted in Fig. 3(b). The relationship between the

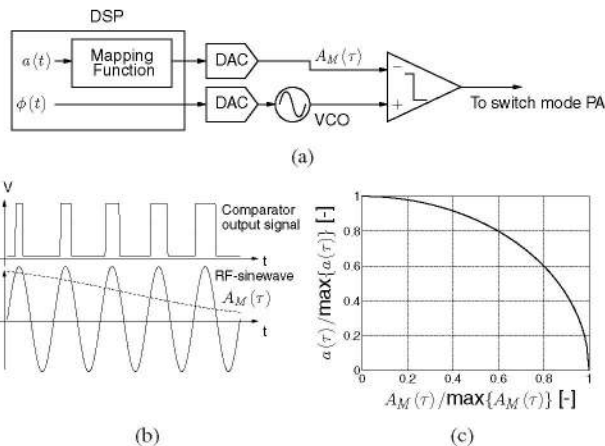

Fig. 3. Generation of RF-PWM signals using DSP mapping function and comparator. (a) Configuration. (b) Illustration of signal waveforms in and out of comparator. (c) Input/output relationship for the comparator. Generally, $a(\tau)$ is the envelope of the RF output signal.

envelope $a(\tau)$ and the input signal, denoted $A_M(\tau)$ is depicted in Fig. 3(c). Intuitively, if the RF-sinewave is phase modulated then the fundamental frequency component of the output pulses has the same phase as intended. In practice the finite rise and fall time alter the function Fig. 3(c) slightly and the envelope input $a(\tau)$ needs to be mapped into $A_M(\tau)$ using a priori measured input–output relationship of the comparator.

The configuration depicted in Fig. 3(a) suffers from some practical problems such as drift, sensitivity to small changes in RF input power etc. All of these are sources to

error in the mapping function and cause spectral regrowth. These problems can be alleviated by introducing feedback. The most straight forward method is to implement envelope feedback using a bandpass filter and an envelope detector. Unfortunately, the delay of the bandpass filter and the envelope detector reduces the bandwidth significantly. Instead, feedback of the low frequency component of the output pulses is used. The configuration is illustrated in Fig. 4(a)–4(c). As a fundamental property of feedback, the

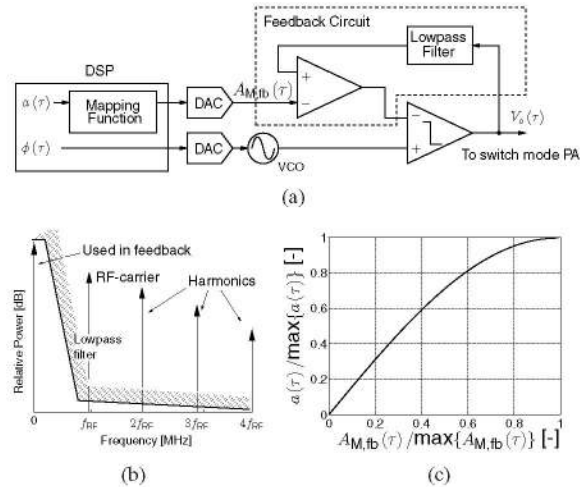

Fig. 4. Generation of RF-PWM signals using feedback of the low frequency component. (a) Configuration. (b) Frequency domain interpretation. (c) Input-output relationship. $a(\tau)$ is the envelope of RF output signal.

low frequency component of the output pulses is the same as the input to the modulator, $A_{M,fb}(\tau)$. Consequently, the relationship between the fundamental of the output pulses (which is the wanted signal) and the input is the same as the relationship between the “DC-value” and the fundamental component of the output pulses. This in turn is a quarter sinewave as depicted in Fig. 4(c). The finite rise- and fall-time of real world signals does not alter this relationship significantly, which is demonstrated in Sec. V.

The novel feedback based configuration in Fig. 4 has two major advantages compared to the stand alone comparator: (i) The input–output relationship is essentially immune against bias drift, and variations of the power and signal waveform of the RF input. Simulations show that a variation of more than ± 0.1 dB in the RF input power (output of the VCO) is enough for the stand alone comparator (Fig. 3(a)) to fail the UMTS modulation mask. When feedback is used, the predistortion curve is determined by the relationship between the fundamental and the low frequency component of the output signal. This is to a certain degree independent of the RF input signal and therefore, the requirement for tight tolerances to the input

signal is significantly reduced.¹ (ii) The conversion gain in the input–output relationship does not vary as much as it is the case for the stand alone comparator. This relaxes the requirements of the mapping function (or predistortion) of the DSP. A complete proof of this is beyond the scope of this paper. It is nevertheless clear from Fig. 3(c) that a small error of $A_M(\tau)$ has a large impact on the output signal $a(\tau)$ when $A_M(\tau)$ is around 0.9–1. The same tendency can not be observed in Fig. 4(c).

As always, when feedback is used, the time delay in the loop is a critical parameter which often reduces the usable bandwidth [6]. In this case it is worth noting that no high Q filters are involved and consequently the time delay in the loop is relatively small compared to systems with high Q filters inside the loop.

IV. IMPLEMENTATION OF PROTOTYPE

To prove the modulator concept and to get an indication of the practical limitations, the RF-PWM modulator has been designed and fabricated using standard discrete components on a FR4 PCB layout. Needless to say, such an environment does not perform as good in terms of speed as an integrated solution in a high speed process. Therefore, the frequencies were down-scaled to an RF carrier frequency of 100 MHz. As input signal a UMTS signal ($PAR \simeq 3.5$ dB, $DR \simeq 20$ dB) is used similarly down-scaled such that the symbol rate is 195 ksymbols/s. Thereby the relative bandwidth of the signal is sustained. This down-scaling has been considered fully acceptable as the prototype measurements serve only to prove the modulator concept and to compare the theoretical and measured results.

The key component of the RF-PWM modulator is the comparator. A commonly used comparator configuration is a differential amplifier with a common emitter current source (see Fig. 5). The configuration shown in Fig. 5 provides 28 dB voltage gain (differential in - single-ended out). The feedback is implemented with a single operational amplifier using both branches of the comparator (denoted A and B in Fig. 5). By using both branches the common mode DC offset at the output is cancelled and the feedback voltage is zero at full power.

In the layout, a couple of critical implementation aspects deserve to be mentioned. The load of the comparator must be constant inside the baseband bandwidth. Secondly, the 100 pF capacitor at the input of the right most transistor is necessary to provide the base with current when the transistor switches. Finally, the voltage division at the output of the operational amplifier is used to protect the

¹In practice there is always a connection between the input RF signal and the output. However, the requirements to the input signal is much relaxed compared to those of the stand alone comparator.

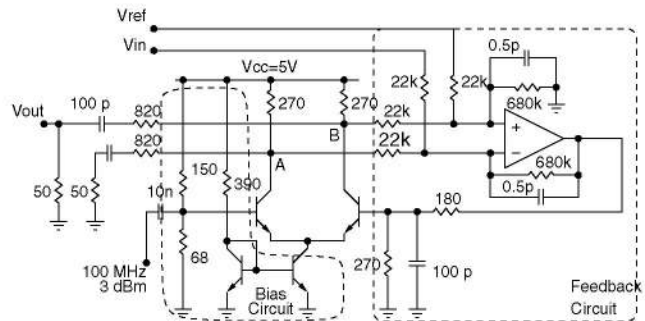

Fig. 5. Schematic of the designed and implemented RF-PWM modulator using feedback of the low frequency component.

transistors from a high reverse breakdown voltage. The transistors are standard NPN silicon RF transistors with $f_T = 8$ GHz (BFS481).

V. RESULT AND DISCUSSION

Fig. 6(a) shows the measured AM/AM and AM/PM characteristics. The AM/AM curve was measured dynamically using a 10 kHz input tone. This was done because a significant temperature dependency in the current mirror was observed. As the power dissipation in the current sourcing transistor depends on the average output power, with time constants in the ~ 500 ms range, the AM/AM curve had to be measured with a dynamic input. The mea-

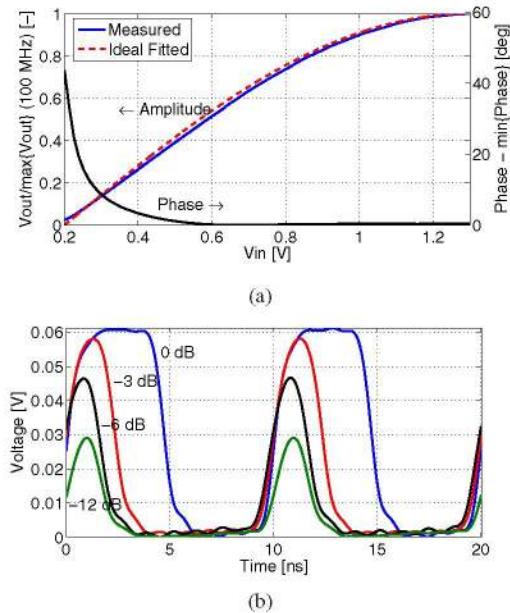

Fig. 6. (a) Relative output voltage and phase distortion versus input voltage. (b) Measured output voltage versus time. Time domain waveforms for various output power levels captured by a 4 GSa/s oscilloscope.

sured AM/AM characteristics for the RF-PWM modulator

are shown together with the ideal quarter sine wave in Fig. 6(a). Despite the final rise and fall time, shown in Fig. 6(b), the two curves are remarkably similar which leads to the conclusion that the AM/AM characteristics are more or less independent of the finite rise and fall time. This is an important observation because a redesign optimized for high switching speed (and subsequently better efficiency in the following PA) can be done without sacrificing the linearity. It is apparent from Fig. 6(b) that this particular comparator is relatively slow, which implies that true class D operation of the following PA is not possible. Since the prototype only serves to prove the concept, and since the rise and fall time are technology dependent, this is not considered a problem.

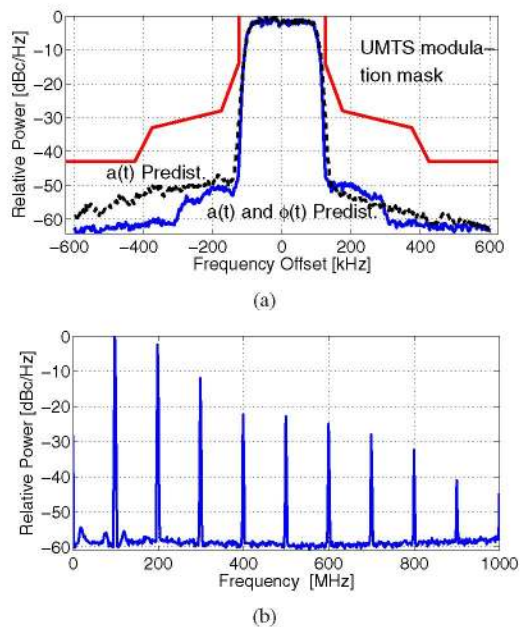

Fig. 7. Relative output power density versus frequency. (a) Modulation mask of down-scaled UMTS. (b) Spectrum from DC to 1 GHz. As expected, there is a significant content of harmonics in the signal. The three small peaks located at 20 MHz, 80 MHz and 120 MHz are measurement artifacts and can be traced back to the clock frequency of the used arbitrary waveform generator.

The measured AM/AM and AM/PM characteristics were used in a lookup table to predistort the input. The resulting spectrum can be seen in Figs. 7(a) and 7(b). It is seen that the signal is well within the down-scaled UMTS spectrum mask, which proves that the concept of feedback of low frequency component combined with predistortion can provide the necessary linearity. Finally, EVM was measured to 0.5% RMS and 1.5% peak.²

²EDGE was used for EVM measurements for convenience. The modulator does also meet the EDGE spectrum mask.

VI. CONCLUSIONS AND PERSPECTIVE

The design of a RF Pulse Width Modulator (RF-PWM) has been presented. The modulator presented employs a novel feedback of the low frequency component of the output pulses combined with predistortion to obtain high linearity and robustness. The configuration has to the authors knowledge not been demonstrated before.

Concept proving measurements on a frequency down-scaled prototype with a similar down-scaled UMTS signal show that the linearity is excellent with more than 17 dB margin to the UMTS spectrum mask, and EVM well below 1 % RMS (the standard prescribes a maximum of 17.5% RMS).

Clearly, the ability of the comparator to generate narrow pulses is a critical parameter for RF-PWM. Comparators operating at 16 GHz have been presented in [7], which indicate that it is possible to generate narrow pulses for a carrier frequency around 2 GHz. Currently the design of a 2 GHz implementation in HBT is ongoing. The preliminary results show that the performance is comparable with the results presented here.

ACKNOWLEDGMENT

The authors thank RF Microdevices, Nørresundby, Denmark for providing state-of-the-art laboratory equipment, assistance with the measurements and numerous fruitful technical discussions.

REFERENCES

- [1] F. H. Raab, P. Asbeck, S. Cripps, P. B. Kenington, Z. B. Popovich, N. Pethecary, J. F. Sevic, and N. O. Sokal, "RF and Microwave Power Amplifier and Transmitter Technologies – Part 5," *High Frequency Electronics*, pp. 46–54, January 2004.
- [2] C. Berland, I. Hibon, J. F. Bercher, M. Villegas, D. Berlot, D. Pache, and V. L. Goascoz, "A Transmitter Architecture for Nonconstant Envelope Modulation," *IEEE Transactions on Circuits and Systems –II: Express Briefs*, vol. 53, no. 1, pp. 13–17, January 2006.
- [3] T. Johnson and S. Stapleton, "Available Load Power in a RF Class D Amplifier with a Sigma-Delta Modulator Driver," *Radio and Wireless Conference, Atlanta*, pp. 439–442, September 19–22th 2004.
- [4] J. Ketola, J. Sommarek, J. Vankka, and K. Halonen, "Transmitter Utilizing Bandpass Delta-Sigma Modulator and Switching Mode Power Amplifier," *IEEE International Symposium on Circuits and Systems, Vancouver*, pp. 633–636, May 23–26 2004.
- [5] F. H. Raab, "Radio Frequency Pulsewidth Modulation," *IEEE Transactions on Communication*, vol. 21, no. 8, pp. 958–966, August 1973.
- [6] S. C. Cripps, *Advanced Techniques in RF Power Amplifier Design*. Artech House, 2002.
- [7] J. C. Jensen and L. E. Larson, "A 16-GHz ultra-high-speed Si-SiGe HBT comparator," *IEEE Journal of Solid-State Circuits*, vol. 38, no. 9, pp. 1584–1589, September 2003.