



# MIT Open Access Articles

## *Analysis and synthesis of randomized modulation schemes for power converters*

The MIT Faculty has made this article openly available. **Please share** how this access benefits you. Your story matters.

<b>Citation</b>	Stankovic, A.M., G.E. Verghese, and D.J. Perreault. "Analysis and Synthesis of Randomized Modulation Schemes for Power Converters." IEEE Trans. Power Electron. 10, no. 6 (1995): 680–693. © Copyright 1995 IEEE.
<b>As Published</b>	<a href="http://dx.doi.org/10.1109/63.471288">http://dx.doi.org/10.1109/63.471288</a>
<b>Publisher</b>	Institute of Electrical and Electronics Engineers (IEEE)
<b>Version</b>	Final published version
<b>Citable link</b>	<a href="http://hdl.handle.net/1721.1/86944">http://hdl.handle.net/1721.1/86944</a>
<b>Terms of Use</b>	Article is made available in accordance with the publisher's policy and may be subject to US copyright law. Please refer to the publisher's site for terms of use.

# Analysis and Synthesis of Randomized Modulation Schemes for Power Converters

Aleksandar M. Stanković, *Member, IEEE*, George C. Verghese, *Member, IEEE*,  
and David J. Perreault, *Member, IEEE*

**Abstract**—After establishing that the proper objects of study for randomized modulation of converters are the power spectra of signals, we classify such modulation schemes and present associated spectral formulas, several of which are new. We also discuss numerical (Monte Carlo) verification issues for power spectral formulas. A general spectral formula for stationary randomized modulation schemes is presented, and specialized to several modulation schemes of practical interest for dc/dc converters. Analytical results are then given for block-stationary randomized modulation schemes that are suitable for inverter operation. In the process, we present results for several modulation schemes that have been reported in the literature without analytical explanations. Experimental verifications of some of our analytical results are presented. We formulate narrow-band and wide-band synthesis problems in randomized modulation, and solve them numerically. Our results suggest that randomized modulation is very effective in satisfying narrow-band power constraints, but has limited effectiveness in meeting wide-band constraints.

## I. INTRODUCTION

**R**ANDOMIZED modulation is of increasing interest in power electronics. While implementation results have been impressive, theoretical analysis has been limited so far. This paper and the thesis [39] describe the basic theoretical framework needed to address analysis and synthesis problems for a large variety of randomized switching schemes, and they also provide representative results.

Over the last three decades power converter designers have resorted to randomized switching for different reasons. The randomized switching concept apparently originated [6] at a time when the switching frequency in dc/dc converters was typically limited to the audible range. Faster devices eventually offered a simple solution to the acoustic noise problem, at least in dc/dc conversion, and randomized switching was set aside. As PWM technology and microprocessors matured during the early eighties, new methods became available to address the effects of acoustic noise and of electromagnetic interference (EMI). While most of the engineering effort was directed toward the optimization of deterministic PWM waveforms ("programmed switching"), an alternative in the form of randomized modulation using a microprocessor implementation was offered for dc/ac conversion in [48]. The same idea has been pursued in a dc/dc setup in [45], and in numerous

references afterwards, for example [11], [2], [20], [49], [47], [21], [19], [12], [3], [44], [37], and [35]. When compared with standard, periodic switching, randomized modulation tends to increase the maximal time excursions of output waveforms that depend on the switching function. These waveforms, however, cease to be periodic and their properties in the time domain are best characterized in a probabilistic framework.

As pointed out in [50], programmed and randomized switching are complementary techniques, and by combining them a designer can achieve improved results. The theoretical setup needed to analyze randomized switching schemes is, however, quite different from the deterministic PWM analysis approach. The natural quantity to study in a randomized switching setup is the **power spectrum** (the Fourier transform of the **autocorrelation** of a signal), and not the harmonic spectrum (i.e., the Fourier transform of the signal itself). Note that the Fourier transform of a random signal is itself a random function, i.e., it is a random variable at each frequency. The power spectrum, on the other hand, has much better properties and can be estimated reliably from the available signal (see, for example, [36]).

The lack of a proper framework for analyzing randomized modulation is, in our opinion, the main reason why most references contain only rudimentary analysis, and rely on plausibility arguments. Judging by a sharp increase in the number of papers describing randomized switching implementations (over a dozen in 1992 alone), there exists a definite need for a unifying analysis framework. This will not only make evaluation and verification of different schemes possible, but will also point out capabilities and limitations of randomized modulation, which are largely not known at present.

Section II of this paper classifies randomized modulation schemes. Section III provides an interpretation of present standards for harmonic distortion that allows them to be applied to the power spectra arising from randomized modulation. Section IV introduces the autocorrelation and power spectrum for the class of signals of interest. In Section V we discuss issues in numerical (Monte Carlo) verification of power spectral formulas. Section VI characterizes the class of stationary randomized modulation schemes, presents a general formula for the power spectra of associated switching functions, and describes specializations to randomized modulation procedures of practical interest in dc/dc converters. The power spectrum of a waveform that is related to the switching function through a linear time-invariant relation is easily derived from the power spectrum of the switching function. However, not all

Manuscript received November 19, 1993; revised June 4, 1995.

A. M. Stanković is with the Department of Electrical and Computer Engineering, Northeastern University, Boston, MA 02115 USA.

G. C. Verghese and D. J. Perreault are with the Laboratory for Electromagnetic and Electronic Systems, Massachusetts Institute of Technology, Cambridge, MA 02139 USA.

IEEE Log Number 9414907.

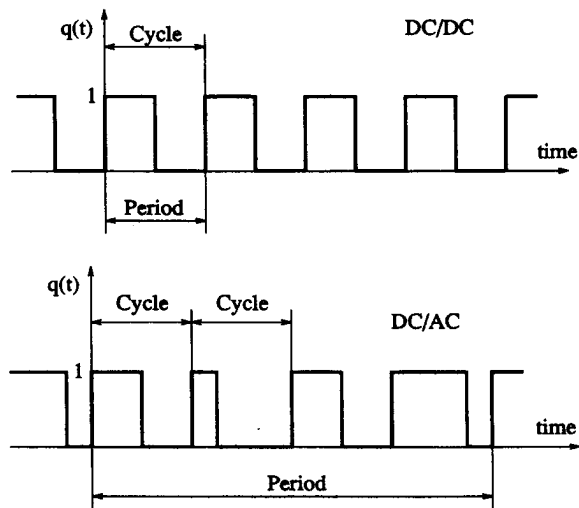

Fig. 1. Nominal switching functions in power converters: (a) dc/dc converters, and (b) dc/ac converters.

waveforms of interest are this simply related to the switching function, and Section VII illustrates how to deal with these cases. Section VIII discusses block-stationary randomized modulation schemes that are suitable for dc/ac converters. In Section IX we discuss synthesis problems in randomized modulation, and present numerical results that suggest that randomized modulation is well suited to meet narrow-band constraints, while it is much less effective in satisfying wide-band constraints.

## II. CLASSIFICATION OF RANDOMIZED SWITCHING STRATEGIES

To find a common ground for comparisons among different randomized modulation methods, we concentrate on the switching function, denoted by  $q(t)$ , which takes the value 0 when the controllable converter switch is off, and the value 1 when it is on (see Fig. 1). As already mentioned, the power spectra of variables related to  $q(t)$  by linear, time-invariant operations can easily be derived from the power spectrum of  $q(t)$ . Power spectra for waveforms that are not related to  $q(t)$  by such operations take more effort to determine (see Section VII).

The main elements characterizing randomized modulation schemes are the underlying (deterministic) nominal switching patterns and the probability laws governing the random dithering of the nominal patterns. We have to check if the nominal patterns, e.g., duty ratios, vary from one cycle to the next, as they do in inverter operation. The other issue is the time variation of the probability densities used to pick the dither at each cycle. If the probabilistic structure is constant from cycle to cycle, we call the switching **stationary**; if it is constant only over a block of cycles (as in inverters), we call it **block-stationary**. More general Markovian schemes, where the probability density used for dither at a cycle depends on past cycles via the state of a Markov chain at the beginning of that cycle are discussed in [39], [41], and [42].

The basic **analysis** problem in randomized modulation is to relate the spectral characteristics of  $q(t)$  and other related waveforms in a converter to the probabilistic structure that governs the dithering. The **synthesis** problem in randomized

modulation is to design a randomized switching procedure that minimizes given criteria for power spectra. Practically useful synthesis procedures include the minimization of discrete spectral components (which we term narrow-band optimization), and the minimization of signal power in a given frequency segment (which we call wide-band optimization); these are examined in Section IX, see also [39] and [41].

## III. PERFORMANCE SPECIFICATIONS

International standards for power electronic converters [8], [32], [38], [26], [5], [46], [51], [17], [18] that operate off an electric utility or in an FCC regulated environment are aimed at periodically operated converters, and are given in terms of Fourier components of the relevant waveforms. Thus, constraints are on the harmonic spectrum, rather than on the power spectrum. Note, however, that the power density spectrum of a periodic function comprises impulses at the fundamental and its harmonics, with strengths that are the squares of the magnitudes of the corresponding Fourier components. We can therefore map existing standards to the power spectrum domain by simply squaring them. These power spectral constraints can be carried over to the nonperiodic waveforms obtained by randomized modulation. Thus, we interpret the standards as follows:

- Take the constraints on the power density spectrum to equal the square of the magnitudes of the allowed harmonic spectrum at any given frequency.
- For lower frequencies, where limits on the strength of the 60 Hz (or 50 Hz) fundamental are specified in existing standards, take the corresponding power to be associated with the total signal power in the frequency segment that extends halfway toward the neighboring harmonics.

Present military standards are the only specifications with both narrow-band and wide-band limits: the signal power for waveforms of interest is subject to an integral constraint over a band of frequencies (e.g., of 1 MHz width in the MHz range), in addition to the more common narrow-band constraints that are part of all civilian standards. The latest draft of new military standards [30] replaces the two constraints with a ‘‘medium-band’’ constraint (10 kHz in the MHz range). It is shown in [39] that this revision of standards favors randomized modulation.

## IV. AUTOCORRELATION AND POWER SPECTRUM

A **random signal** may be thought of as a signal selected from an ensemble (family) of possible signals by a random experiment governed by some specification of probabilities. The ensemble and the specification of probabilities together comprise what is termed the **random process** (or stochastic process) generating the random signal. The signal is termed a realization of the process. We shall not distinguish notationally between the process and a realization of it.

The (time-averaged) **autocorrelation** of a continuous-time random process  $x(t)$  is defined as

$$R_x(\tau) = \lim_{W \rightarrow \infty} \frac{1}{2W} \int_{-W}^W E[x(t)x(\tau+t)] dt \quad (1)$$

where the expectation operation  $E[\cdot]$  is taken over the whole ensemble. (The more common definition omits the time-averaging, but the definition in (1) specializes in the desired way to deterministic signals, where the ensemble consists of just a single member.) The **power density spectrum**  $S_x(f)$  is defined as the Fourier transform of  $R_x(\tau)$ :

$$S_x(f) = \int_{-\infty}^{\infty} e^{-j2\pi f\tau} R_x(\tau) d\tau. \quad (2)$$

In cases of practical interest  $S_x(f)$  can have both a continuous and an impulsive part [4], [52], [24]. The impulsive part of  $S_x(f)$  is referred to as the **discrete** spectrum, and is characterized entirely by the locations  $f_1, f_2, \dots$  of the impulses ("line frequencies", "harmonic frequencies") and by positive numbers  $p_1, p_2, \dots$  representing the strengths of the impulses, which equal the signal power at the harmonic frequencies. When integrated over a frequency range, the continuous part of  $S_x(f)$  yields the signal power in that frequency range.

An important result for applications concerns the transformation of the autocorrelation of a process  $x(t)$  when it is passed through a stable linear, time-invariant filter. Such a filter is characterized by its impulse response  $h(t)$  and corresponding frequency response  $H(f)$ , which is the Fourier transform of  $h(t)$ . The output  $y(t)$  of the system is given by convolution

$$y(t) = \int_{-\infty}^{\infty} x(t)h(t-u)du. \quad (3)$$

Using this relation, it can be shown [52] that the process  $y(t)$  has a well-defined autocorrelation, whenever  $x$  does, and that its power spectrum is

$$S_y(f) = |H(f)|^2 S_x(f). \quad (4)$$

This relation can be used to evaluate the power spectrum of any waveform related to the switching waveform  $q(t)$  through a convolution, once the power spectrum of  $q(t)$  is known.

A random process  $x(t)$  for which

$$E(x(t)) = m_x \quad (5)$$

and

$$E[x(t)x(t+\tau)] = R_x(\tau), \quad \forall t, \tau \quad (6)$$

is termed wide-sense stationary (WSS, weakly stationary). Thus, a WSS random process has a mean and autocorrelation that are independent of the time origin (so that the time averaging in (1) becomes unnecessary). Any stationary randomized modulation generates a switching function that is wide-sense stationary. This can be shown rigorously using the concept of regenerative processes [24]. Special cases of this result can also be found in [9], for example, or in [1] which uses theory of stationary point processes.

Let  $X_{2W}(f)$  denote the Fourier transform of the symmetrically **truncated** version of  $x(t)$ , extending from  $-W$  to  $+W$ . An important result of the Fourier theory [4], [7], [23] due to Einstein, Wiener and Khintchine, shows that if  $x(t)$  is a wide-sense stationary process then  $S_x(f)$  is related to  $X_{2W}(f)$  as follows:

$$S_x(f) = \lim_{W \rightarrow \infty} E\left(\frac{1}{2W} |X_{2W}(f)|^2\right). \quad (7)$$

The quantity  $\frac{1}{2W} |X_{2W}(f)|^2$  is called the **periodogram** of  $x(t)$ . For nonstationary processes that have a well defined autocorrelation via (1), a weaker version of (7) holds, where the equality is in the sense of distributions.

## V. VERIFICATION ISSUES

The formulas that will be developed shortly for power spectra of different randomized modulation schemes are rather involved, and a need arises to verify and explore them through simulation. (We also provide experimental verification in some cases.) The power spectrum of a (Monte Carlo) simulation of a randomized switching waveform  $q(t)$  is obtained through an estimation procedure. Power spectrum estimation is one of the most important problems in signal processing and has a very rich history [34], [25], [31], [36], [27].

The discussion in this section deals primarily with direct estimation methods that yield estimates of the power spectrum  $S_q(f)$  without first estimating the autocorrelation. We concentrate on nonparametric, classical estimation methods, which are well understood and for which software is readily available [36].

Classical direct estimation methods may be thought of as approximate implementations of the operations specified in the Wiener-Khinchine theorem (7). Typically, a single sampled-data realization of the random process of duration  $2KW$  is divided into  $K$  sections, and the (sampled-data version of the) periodogram is computed for each section. The availability of the Fast Fourier Transform (FFT) to calculate the Fourier transforms involved is a major advantage. The expectation operation in (7) is then approximated by averaging the  $K$  individual periodograms. This is referred to as Bartlett's method. Under appropriate conditions (related to ergodicity of the stochastic process, which permits time averages to be substituted for ensemble averages) this computation produces a consistent, asymptotically unbiased estimate of the power spectrum [14], [36], so the estimate converges to the true spectrum as  $K \rightarrow \infty, W \rightarrow \infty$ . We shall assume that the switching functions  $q(t)$  of interest to us satisfy the conditions required for validity of such an estimation procedure. The close match between our analytical formulas and the Monte Carlo verifications suggest that this is indeed a good assumption.

Although the above estimation procedure is asymptotically unbiased, in practice  $K$  and  $W$  are finite, so there is inevitable bias. The use of appropriate windows in the time domain contributes to bias reduction. An unpleasant effect of windowing is known as leakage and has its source in the frequency-domain sidelobes of the windows used.

Welch [36] modified Bartlett's method by allowing data segments to overlap, in addition to windowing data in the time domain. This method is widely used and is available in the Matlab [28] software package. A 50% overlap between the data segments produces good results in many applications [36].

A brief discussion of the choice of parameters in implementing Welch's method is presented next; some further discussion may be found in [40]. Let  $N$  denote the number of data points in the simulated random signal, let  $M$  denote the number of points in a data segment ( $N = KM$ ), and let  $R$  denote

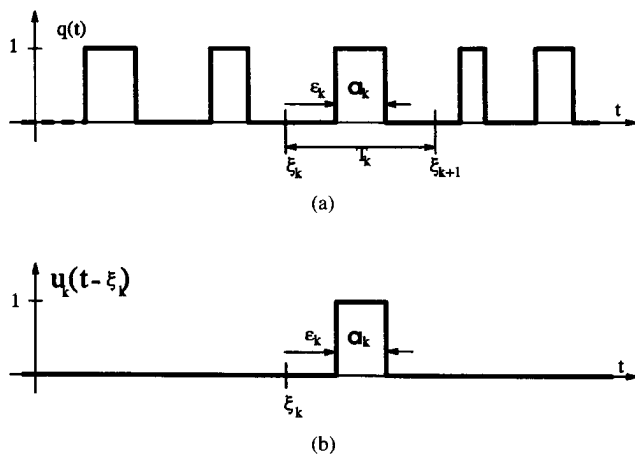

Fig. 2. (a) The switching waveform  $q(t)$ , and (b) the pulse  $u_k(t - \xi_k)$  representing just the  $k$ -th cycle of  $q(t)$ .

the number of points per cycle of the switching function  $q(t)$ . If  $R$  is set to 64, so that the duty ratio resolution is better than 2%, then the spectrum can be estimated up to the 32nd harmonic (which is the Nyquist frequency). The spectral estimate contains  $M/2$  points (for positive frequency), and if 32 points per unit frequency are desired, then  $M = 2048$ . Thus, if  $K = 8$ , a total of  $N = 16,384$  points is needed, which is reasonable within the Matlab package. Given a constraint on  $N$ , either  $M$  can be increased, thus improving resolution but decreasing  $K$  and getting a more “jittery” estimate, or  $K$  can be increased, thus reducing the frequency resolution but obtaining smoother estimates. An overlap of  $M/2$  between the data segments improves the estimation results, essentially by increasing the effective number of data segments  $K$ , while keeping  $N$  fixed.

The trade-offs in spectral estimation described in this section apply directly to digital spectral analyzers [13]. Similar trade-offs arise with analog systems for spectral analysis [29], [10] which utilize band-pass filters to isolate a narrow frequency band of interest, followed by squaring devices and low-frequency filters to provide a spectral estimate.

## VI. STATIONARY RANDOMIZED MODULATION SCHEMES

Stationary randomized modulation schemes are characterized by invariant deterministic and probabilistic structure, namely:

- The nominal or reference on-off pattern that is being dithered does not change from one switching cycle to the next—there are no variations in the requirements on average quantities such as the duty ratio;
- At each new cycle, the same probabilistic structure is used—the dithering (in time) is based on independent trials.

Stationary switching schemes can be further classified, and the most important classes are randomized pulse position modulation (PPM), randomized pulse width modulation (PWM), and asynchronous schemes [45], [43].

Referring to Fig. 2(a),  $\xi_k$  is the time at which the  $k$ -th cycle starts,  $T_k$  is the duration of the  $k$ th cycle,  $a_k$  is the duration of

the on-state within this cycle, and  $\epsilon_k$  is the delay to the turn-on within the cycle. Note that the duty ratio is  $d_k = a_k/T_k$ . The switching function  $q(t)$  that we analyze consists of a concatenation of such switching cycles.

In general, one can dither  $\epsilon_k$ ,  $d_k$ , or  $T_k$ , individually or simultaneously. Some combinations used in power electronics are

- randomized pulse position modulation (PPM):  $\epsilon_k$  changes;  $T_k$ ,  $a_k$  fixed;
- randomized pulse width modulation (PWM):  $a_k$  changes;  $\epsilon_k = 0$ ;  $T_k$  fixed;
- simplified asynchronous modulation [43]:  $T_k$  changes;  $a_k$  fixed;
- asynchronous modulation [45]:  $T_k$  changes;  $\epsilon_k = 0$ ;  $d_k$  fixed.

The tools for analysis of the first three cases have been available from the communication theory literature of the 1960s [29], [22]. This literature seems to have been largely overlooked by the power electronics community. Results for all four categories are presented here.

### A. A General Formula for Stationary Randomized Modulation

With  $u_k(t - \xi_k)$  denoting the single-pulse waveform defined in Fig. 2(b), we can write the switching function as

$$q(t) = \sum_{k=-\infty}^{\infty} u_k(t - \xi_k). \quad (8)$$

Let  $U_k(f)$  denote the Fourier transform of  $u_k(t)$ . The power spectrum of  $q(t)$  can now be computed using the procedure described in detail in [39] and based on [29]. This procedure in effect computes the autocorrelation and takes its Fourier transform, exactly as required by the definition of power spectrum. Alternatively, one could derive the power-spectrum using the Wiener-Khinchine relation (7). The result is

$$S_q(f) = \frac{1}{T} \sum_{k=-\infty}^{\infty} E[U_0(f)U_k^*(f)e^{j2\pi f(\xi_k - \xi_0)}] \quad (9)$$

where  $T$  is  $E[T_k]$ , the expected duration of a cycle.

The result (9), in which  $U_k(f)$  is a function of  $\epsilon_k$ ,  $a_k$ ,  $d_k$ ,  $T_k$  and possibly other randomization parameters, is very general. The specialization of this formula to various stationary randomized modulation schemes of interest in power electronics is considered in the following subsections. A case of great practical interest is where the randomized modulation in different cycles is based on statistically independent trials and where all cycles are of duration  $T$ , but the duration  $a_k$  and/or position  $\epsilon_k$  of the pulse are randomized. In this case the expectation in formula (9) factors into a product of expectations, and we add and subtract the term  $|E[U(f)]|^2/T$  that corresponds to  $k = 0$ . After invoking the Poisson identity [29]

$$\sum_{k=-\infty}^{\infty} e^{j2\pi k f T} = \frac{1}{T} \sum_{k=-\infty}^{\infty} \delta(f - \frac{k}{T})$$

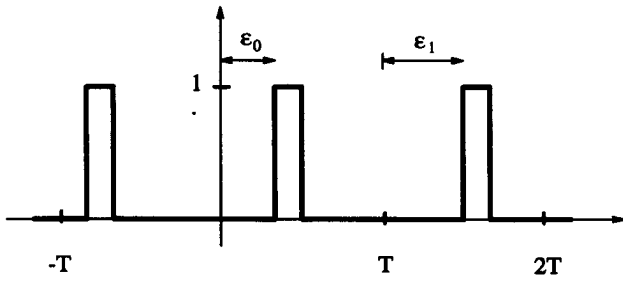

Fig. 3. Randomized pulse position modulation (PPM).

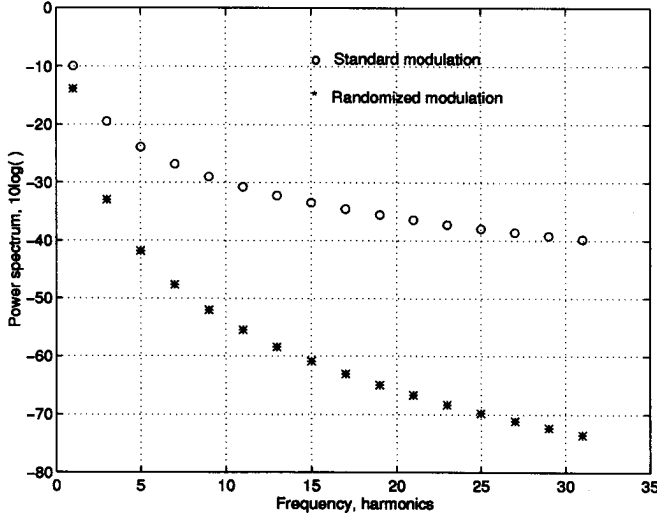

Fig. 4. Discrete spectrum: Comparison of conventional and randomized PPM modulation, period  $T = 1$ , duty ratio  $D = 0.5$ .

the power spectrum is shown to equal

$$S_q(f) = \frac{1}{T} \{ E[|U(f)|^2] - |E[U(f)]|^2 + \frac{1}{T} |E[U(f)]|^2 \sum_{k=-\infty}^{\infty} \delta(f - \frac{k}{T}) \} \quad (10)$$

where we have dropped the now unnecessary subscript on  $U_k(f)$ .

### B. Randomized Pulse Position Modulation

In this section the case of randomized pulse position modulation (PPM) is considered, where each cycle has the same length  $T$ , and the pulse in each cycle has the same duration  $a$ , but now we allow an independent random variation in the position  $\varepsilon_k$  of the pulse in the  $k$ -th cycle, see Fig. 3. Let the probability density function for  $\varepsilon$  be  $p_\varepsilon(t)$  and let the Fourier transform (or characteristic function) of this be denoted by  $P_\varepsilon(f)$ . We also introduce the notation  $\bar{U}(f)$  for the Fourier transform of a rectangular pulse of width  $a$  that starts at 0, so that  $U(f) = \bar{U}(f)e^{-j2\pi f\varepsilon}$ . Then  $E[|U(f)|^2] = |\bar{U}(f)|^2$  and  $E[U(f)] = \bar{U}(f)P_\varepsilon(f)$ , so (10) becomes

$$S_q(f) = \frac{|U_0(f)|^2}{T} \{ (1 - |P_\varepsilon(f)|^2) + \frac{|P_\varepsilon(f)|^2}{T} \sum_{k=-\infty}^{\infty} \delta(f - \frac{k}{T}) \}. \quad (11)$$

This expression is found, for example, in [29].

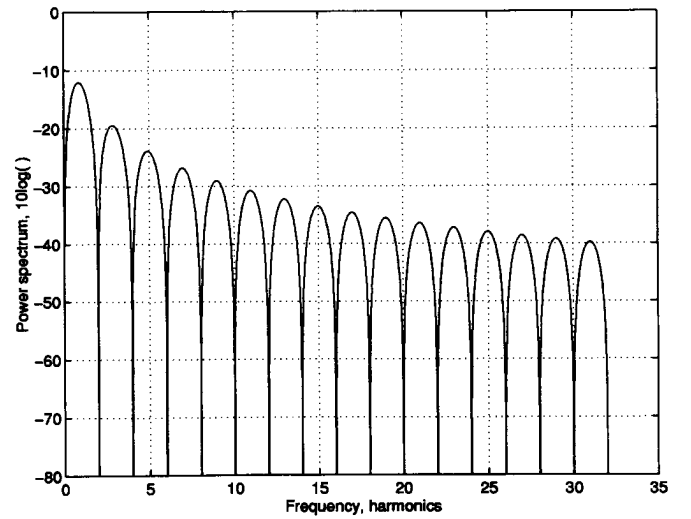

Fig. 5. Continuous spectrum: Randomized PPM, period  $T = 1$ , duty ratio  $D = 0.5$ .

As an example, assume  $T = 1$ . Then for rectangular pulses of width  $D$

$$S_q(f) = \left( \frac{\sin(\pi f D)}{\pi f} \right)^2 \cdot \{ (1 - |P_\varepsilon(f)|^2) + |P_\varepsilon(f)|^2 \sum_{k=-\infty}^{\infty} \delta(f - k) \}. \quad (12)$$

The nondithered case is easily recovered. For  $\varepsilon_i = 0$ ,  $p_\varepsilon(t) = \delta(t)$ , and  $P_\varepsilon(f) = 1$ , so

$$S_q(f) = \left( \frac{\sin(\pi f D)}{\pi f} \right)^2 \sum_{k=-\infty}^{\infty} \delta(f - k) \quad (13)$$

as expected for a periodic train of rectangular pulses.

Since  $p_\varepsilon(t)$  is a probability density function, it must integrate to 1, so  $P_\varepsilon(0) = 1$ . Given that  $|P_\varepsilon(f)| \leq 1$  [33], and that from Parseval's equality

$$\int_{-\infty}^{\infty} |P_\varepsilon(f)|^2 = 1, \quad (14)$$

it follows that  $|P_\varepsilon(f)| < 1$  in some frequency range. The expression (12) shows that in this frequency range the discrete part of the spectrum will be decreased, when compared to the conventional switching strategy. The price paid for this result is the introduction of the continuous part of the spectrum (the "fill-in"),  $(\sin(\pi f D)/\pi f)^2 (1 - |P_\varepsilon(f)|^2)$ . This might be quite acceptable, given the predominantly narrow-band form of the standards described in Section III, and this is the rationale behind a growing number of applications of randomized modulation.

For illustration, specialize to  $D = 0.5$  and  $\varepsilon_i$  uniformly distributed in the interval  $[0, (1 - D)T]$ , or  $[0, 0.5]$ . For these values, the discrete, nondithered spectrum is shown in Fig. 4 together with the discrete spectrum for randomized PPM, and the continuous spectrum is shown in Fig. 5.

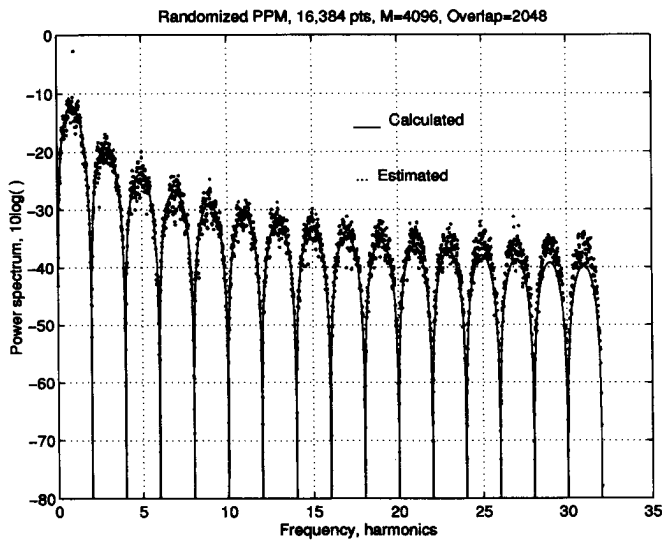

Fig. 6. Randomized PPM: Estimated and calculated spectrum, with  $M = 4096$  points.

We now describe the application of Welch's method (which is implemented in the signal processing toolbox of the Matlab package) to numerically verify (12) via Monte Carlo simulations, following Section V. The parameter values for the simulation are  $D = 0.5$  and  $T = 1$ , as in the previous example. In each cycle, a random number uniformly distributed between 0 and 0.5 is chosen as the offset for the pulse, and the waveform for that pulse is thereby completely defined. A total of 256 cycles is generated, with 64 samples in each cycle. The total number of points is thus  $N = 16,384$  and the width of an individual data segment  $M$  can be varied. The approximate frequency resolution of Welch's method, defined as the minimum distance of two distinguishable sinusoids, is approximately  $41/M$  in this case [36].

In Figs. 6 and 7 the estimated power spectrum (dotted) is shown together with the calculated continuous spectrum from (12). Welch's procedure generates the estimate of the total power spectrum, i.e., of the sum of continuous and discrete spectra, so the large deviations between the estimated and calculated continuous spectrum near the peaks are due to discrete spectral components. This remark holds for all examples presented in this paper. The general agreement with the calculated continuous spectrum is good.

In Fig. 7 the first two harmonics are magnified. These figures show a "jittery" estimate, as expected for the large  $M (= N/4)$  that we have used. To estimate the coefficient associated with the impulse at the unit frequency, we can proceed as follows. From the known width of the frequency segment,  $1/64$  for this particular value of  $M$ , a value of 0.0296 is obtained for the area of the peak centered at  $f = 1$ , and 0.0083 and 0.0084 for the neighboring segments (of width  $1/64$  each) to the left and right, respectively. The calculated value for the discrete component at  $f = 1$  is 0.0411, and the integrals of the calculated continuous spectral component over segments of width  $1/64$  to the left and to the right are only 0.0009. The discrepancy in total signal power over all three segments between the estimated and calculated spectra is

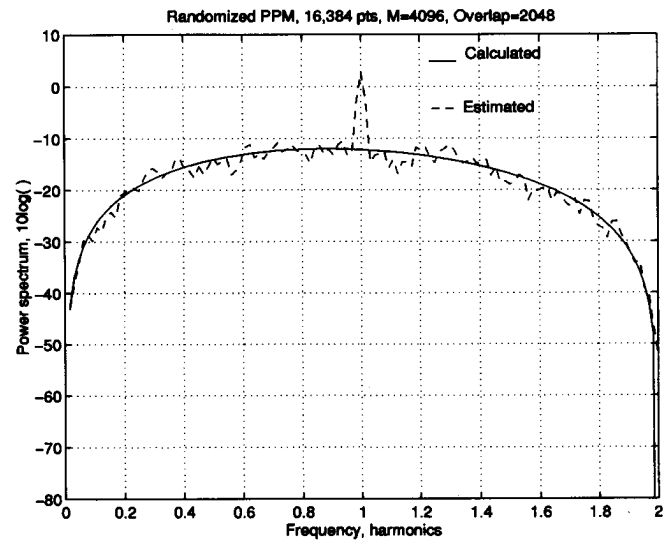

Fig. 7. Randomized PPM: Estimated and calculated spectrum, first two harmonics, corresponding to  $M = 4096$  points.

approximately 5%. The reason for looking at the contributions of three segments rather than one is the spectral "leak" inevitable due to windowing in the time domain [36]. In this particular case the frequency resolution (defined as the minimum frequency difference between the two sinusoids that permits them to be resolved) is approximately 0.01 [36], while the width of a frequency segment is  $1/64 = 0.015$ . Thus, when estimating coefficients associated with impulses it is necessary to take into account the spectral leak by integrating the signal power over a sufficiently wide frequency segment, and subtracting the contribution of the continuous spectrum.

### C. Randomized Pulse Width Modulation

In randomized pulse width modulation (PWM), the on-state duration  $a_k$  is varied within a fixed period  $T$ . Consider the case where  $T = 1$  and  $a_k$  lies in the interval  $[0, 1]$ , with a uniform probability density. With  $\alpha = \pi f$ , the spectrum is given by

$$S_q(f) = \frac{1}{4\alpha^2} \left[ 1 - \frac{\sin^2 \alpha}{\alpha^2} + \frac{\sin^4 \alpha + (\alpha - \sin \alpha \cos \alpha)^2}{\alpha^2} \sum_{k=-\infty}^{\infty} \delta(f - k) \right]. \quad (15)$$

This result is presented in [29] with an unfortunate typographical error (the term  $\alpha^2$  is missing in the last fraction). Conventional switching yields the discrete spectrum given in Fig. 8; the figure also shows the discrete spectrum for randomized PWM. Randomized PWM yields discrete harmonics at even multiples of the switching frequency as well (for  $D = 0.5$  conventional modulation has only odd harmonics). In this example, randomized PWM reduces the fundamental more than randomized PPM does (see Fig. 4), but randomized PPM is more efficient at reducing the higher discrete harmonics. The continuous spectrum for randomized PWM is given in Fig. 9, which can be contrasted with the result for randomized PPM in Fig. 5.

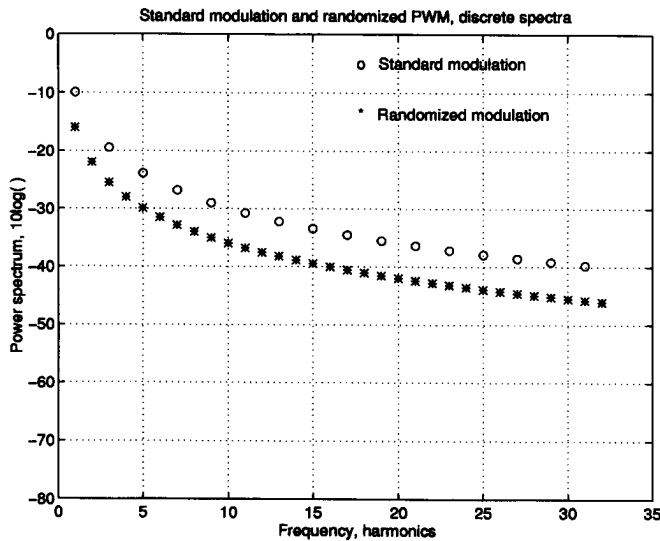

Fig. 8. Discrete spectrum: Comparison of conventional and randomized PWM modulation, period  $T = 1$ , duty ratio  $D = 0.5$ , pulse width uniformly distributed in the interval  $[0, T]$ .

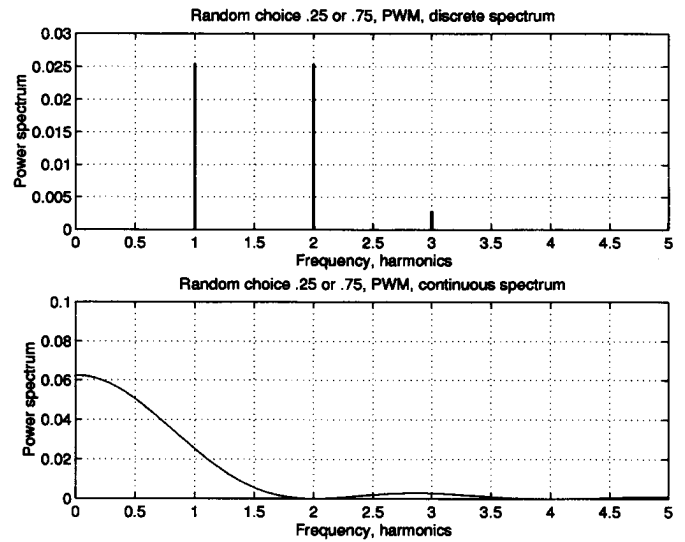

Fig. 10. Randomized PWM: Calculated discrete and continuous spectrum, period  $T = 1$ , equally probable pulses of duration 0.25 and 0.75.

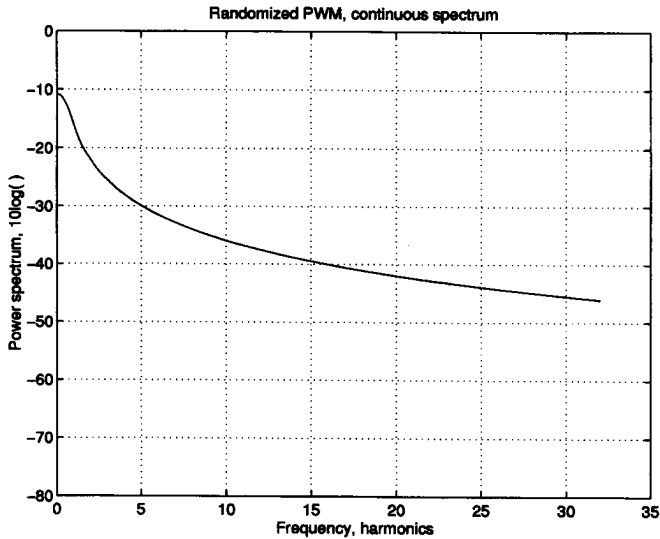

Fig. 9. Continuous spectrum: Randomized PWM, period  $T = 1$ , duty ratio  $D = 0.5$ , pulse width uniformly distributed in the interval  $[0, T]$ .

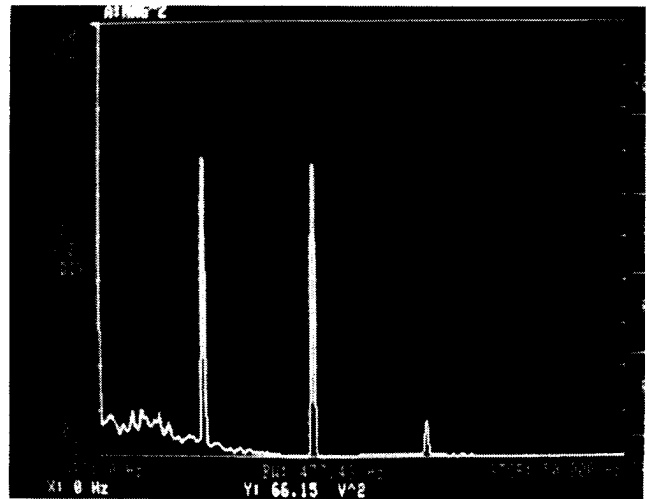

Fig. 11. Randomized PWM: Measured power spectrum, equally probable pulses of durations 0.25 and 0.75.

Another case of interest is the example of equally probable pulses of lengths 0.25 and 0.75. In this case application of (10) goes as follows. The Fourier transform of a single unit pulse of duration  $a_k$  equals  $U(f) = (1 - e^{-j2\pi a_k}) / (j2\pi f)$ . After taking into account that  $a_k$  can take only two values, namely 0.25 and 0.75, we obtain

$$E[|U(f)|^2] = \frac{1}{(2\pi f)^2} [2 - \cos(\frac{2\pi f}{4}) - \cos(\frac{6\pi f}{4})] \quad (16)$$

and

$$E[U(f)] = \frac{1}{2} \left[ \frac{1 - e^{-j2\pi f 0.25}}{j2\pi f} + \frac{1 - e^{-j2\pi f 0.75}}{j2\pi f} \right]. \quad (17)$$

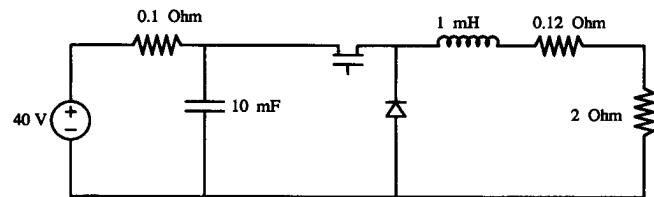

Fig. 12. Buck converter used in verification of power spectral formulas for stationary modulation.

Then the formula (10) yields the power spectrum shown in Fig. 10. These theoretical results can be compared with the experimental results for a buck converter shown in Fig. 11. Good agreement can be observed.

We have used the buck converter circuit shown in Fig. 12 to obtain experimental verification of some of our formulas for power spectra under randomized modulation. The fundamental switching frequency in this circuit is 10 kHz. The transistor in our implementation is controlled by a microprocessor, which



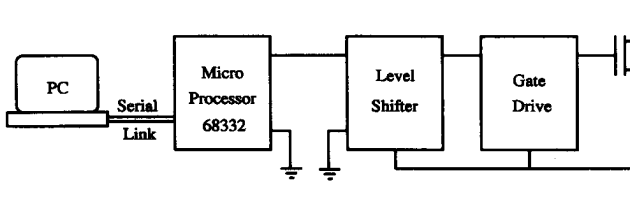

Fig. 13. Block diagram of the experimental setup for verification of power spectral formulas in randomized modulation.

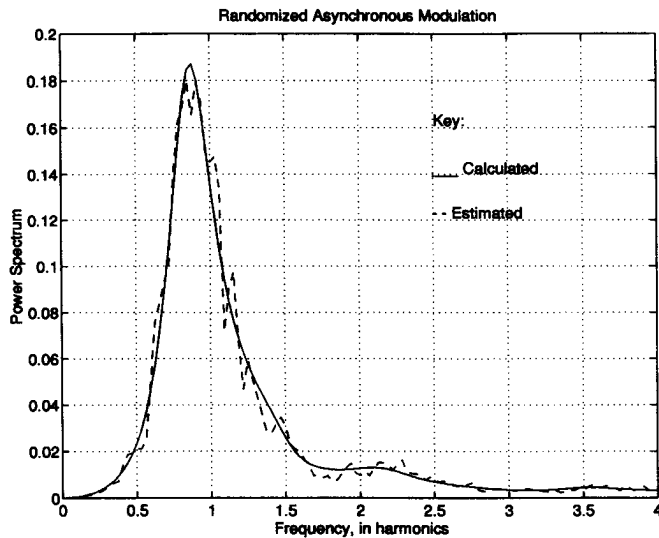

Fig. 14. Calculated and estimated power spectra for  $q(t)$  in asynchronous modulation.

is in turn connected to a personal computer. The main role of the personal computer is to facilitate development of the microcode for randomized switching. A block diagram of the experimental system is shown in Fig. 13. Note, however, that practical randomized modulation schemes can be implemented with much simpler hardware, for example with a pseudo-random number generator and auxiliary circuitry.

#### D. Randomized Aperiodic Modulation

In this section we consider the **asynchronous** dc/dc randomized modulation scheme introduced (but without power spectral formulas) in [45]. In this scheme, the lengths of successive cycles  $T_k$  are randomized, while the duty ratio is kept fixed at its nominal value. The scheme is different from the simplified asynchronous version used by the same authors later [43], in which  $T_k$  is again random, but the duration of the on-state is constant. This latter simplified scheme has been analyzed in [29] and [22], building on a formula for the power spectrum of a dithered impulse train. The original scheme in [45], where the duty ratio is fixed, is harder to analyze, as two **correlated** dithered impulse trains have to be used; this is the case we treat here.

At this point in our development we can either specialize the formula (9) to the case of aperiodic randomized modulation, or build on the formula presented in [22] for the power spectrum of a dithered impulse train. It has been shown in [39] that both approaches lead to the same results. If we denote by  $P_T(f)$

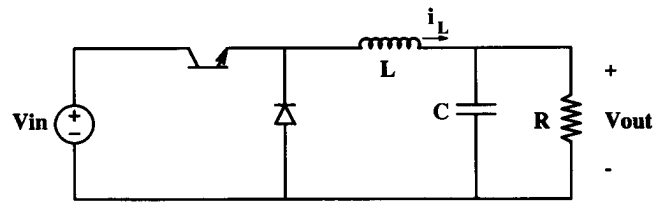

Fig. 15. Standard configuration of a buck dc/dc converter.

the Fourier transform of the probability density function used to determine successive cycle lengths  $T_k$ , then our derivation [39] shows that the power spectrum of the asynchronous pulse train is

$$S_q(f) = \frac{2}{(2\pi f)^2} \left[ 1 + \operatorname{Re} \left( \frac{P_T(f)}{1 - P_T(f)} \right) + \operatorname{Re} \left( \frac{P_T^2\left(\frac{f}{2}\right)}{1 - P_T(f)} \right) - 2 \operatorname{Re} \left( \frac{P_T\left(\frac{f}{2}\right)}{1 - P_T(f)} \right) \right]. \quad (18)$$

(Note that  $P_T(f) \neq 1$  for  $f > 0$ , unless  $T_k$  is governed by a very special ‘lattice’ probability density function; this case is addressed in [39].)

In Fig. 14 we show the calculated spectrum (dotted line) computed using (18), and the estimated spectrum obtained via Monte Carlo simulations and Welch’s estimation method, see Section V. The agreement is evidently very good.

## VII. CURRENT SPECTRA

Our results so far allow us to directly determine the power spectra of certain other waveforms in power converters from the spectrum of the switching function  $q(t)$ . A simple analysis of the standard buck converter [15] shown in Fig. 15 establishes that the inductor current equals the **integral** of

$$\frac{q(t)V_{in} - V_{out}}{L}$$

where  $V_{in}$  is the input voltage,  $V_{out}$  is the output voltage, and  $q(t)$  is the switching function. The average (dc) component of the inductor current is controlled by a separate (outer loop) controller. This allows us to apply (4) to determining the power spectrum of the inductor current at positive frequencies:

$$S_{iL}(f) = \frac{V_{in}}{L} \frac{1}{f^2} S_q(f). \quad (19)$$

For that case calculated and measured spectra are given in Figs. 16 and 17, and good agreement is evident.

Similar relations between the switching function and the inductor current can be observed for other basic dc/dc converters in the continuous conduction mode. In the case of a standard boost converter [15], the inductor current (which happens to be the input current) is the integral of

$$\frac{V_{in} - V_{out} + q(t)V_{out}}{L}$$

In the case of an buck/boost converter, the inductor current is the integral of

$$\frac{q(t)(V_{in} + V_{out}) - V_{out}}{L}.$$

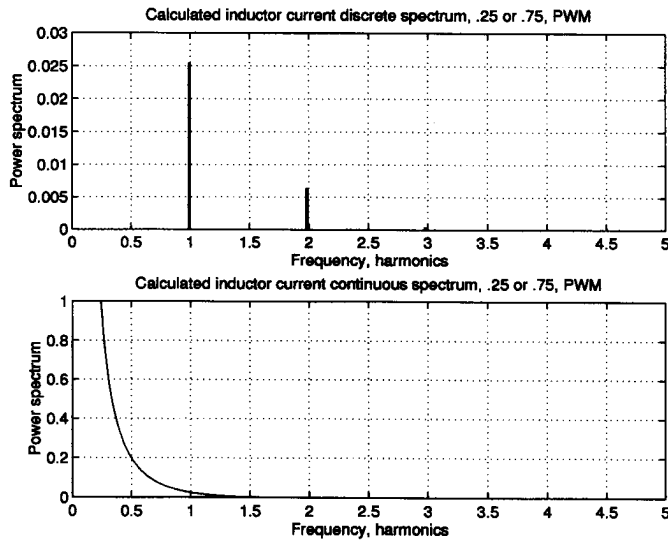

Fig. 16. Calculated spectrum of the inductor current for a buck converter in continuous conduction mode with randomized PWM.



Fig. 17. Measured spectrum of the inductor current for a buck converter in continuous conduction mode with randomized PWM.

Analogous relationships could be derived for output voltages  $V_{out}$ .

Computation of the power spectrum of the **input** current in buck and buck/boost converters is more intricate. In the remainder of this section, we show how (10) can be used to determine the spectrum of the input current for these converters.

Fig. 18 applies to a buck converter operating in continuous conduction mode, and shows a typical nominal switching function, together with the nominal inductor current and the input current. The input current at the  $k$ th cycle under randomized PPM is shown in Fig. 19. Note that the inductor current at the beginning of each dithered cycle is still at its nominal value  $I_0$ . The input current at the  $k$ th cycle depends only on  $\epsilon_k$ , and we can specialize (10) to that case.  $U(f)$  is the Fourier transform of the input current waveform, a single

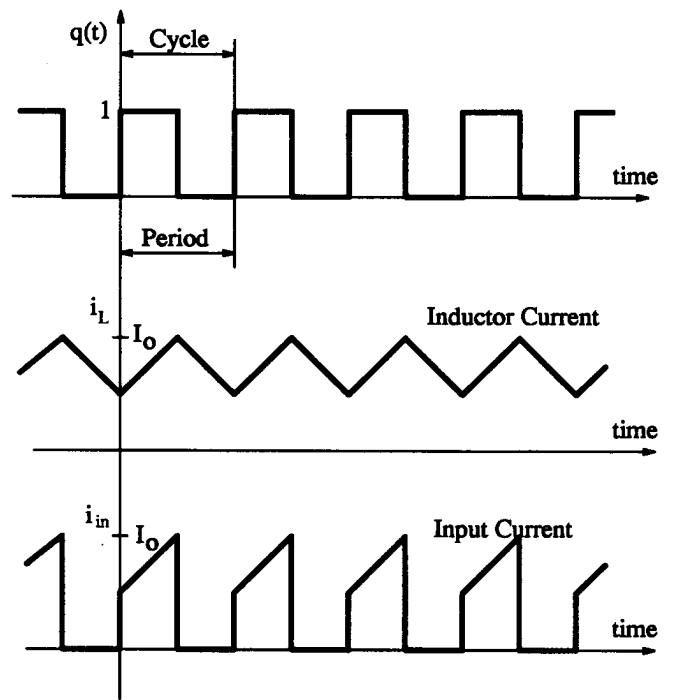

Fig. 18. Nominal switching function, inductor current, and input current for a buck converter in continuous conduction mode.

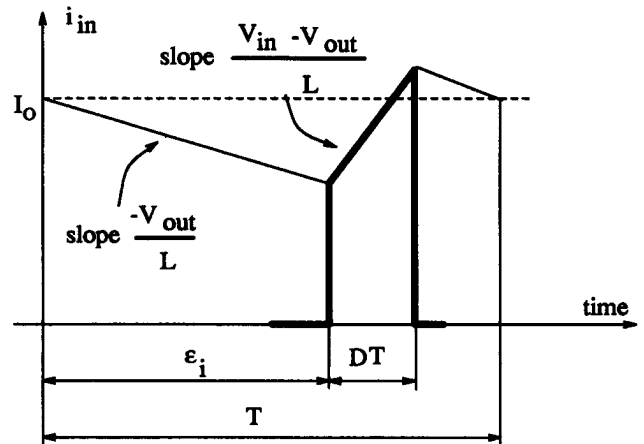

Fig. 19. Input current for a buck converter in continuous conduction mode with randomized PPM.

cycle of which is shown in Fig. 19. After writing equations for the straight line segments shown in Fig. 19,  $U(f)$  turns out to be (for  $f > 0$ ):

$$U(f) = \left\{ \left( I_0 - \frac{V_{out}\epsilon}{L} \right) \frac{\sin(\pi f DT)}{\pi f} e^{-j\pi f DT} + \frac{V_{in} - V_{out}}{j2\pi f L} e^{-j\pi f DT} \left[ \frac{\sin(\pi f DT)}{\pi f} - DT e^{-j\pi f DT} \right] \right\} e^{-j2\pi f \epsilon} \quad (20)$$

Equation (10) can then be evaluated, once probability densities for  $\epsilon$  are specified. As an example, we consider the case of randomized pulse position modulation where the delay  $\epsilon_k$  is either 0, or  $T/2$ , each with probability 1/2. For this case calculated and simulated spectra are given in Fig. 20 (there are no discrete spectral components in this example).

It turns out that the power spectrum of the input current in buck and buck/boost converters is harder to calculate for some other randomized modulation schemes, notably for randomized PWM.

### VIII. RANDOMIZED MODULATION FOR INVERTERS

In this section, the nominal on–off pattern is assumed to change from one switching cycle to the next, but repeats periodically over a **block** of cycles, as would be required for inverter operation. The randomization then involves dithering this pattern in each cycle using a set of mutually independent trials with a statistical structure that remains constant from block to block, hence the label of block-stationary randomized modulation. Most of the results presented here are either novel, or represent generalizations of previously available results. Their derivation follows the one outlined in Section VI-A, but requires additional algebraic manipulations. We restrict ourselves to single-phase schemes. Power spectra for line-to-line or line-to-neutral variables in a **three-phase** system can be found easily, once the spectrum corresponding to one phase is known.

Two modulation schemes of particular interest in practice are block-stationary PPM and block-stationary aperiodic modulation. In this section we consider block-stationary PPM, and refer the interested reader to [39] for details on block-stationary aperiodic modulation.

Consider the case of  $N$  cycles in a block (see Fig. 1 (b)), with possibly different cycle lengths  $T_k$ , and possibly different probability densities (with characteristic functions  $P_k$ ). Let  $U_k(f)$  denote the Fourier transform of the pulse  $u_k(t)$  in the  $k$ -th cycle of the block (defined with respect to a time origin at the start of the corresponding cycle), and let

$$U(f) = \begin{bmatrix} U_1(f) \\ U_2(f)e^{-j2\pi f T_1} \\ \vdots \\ U_N(f)e^{-j2\pi f \sum_{k=1}^{N-1} T_k} \end{bmatrix}$$

and

$$\hat{U}(f) = \begin{bmatrix} U_1(f)P_1(f) \\ U_2(f)P_2(f)e^{-j2\pi f T_1} \\ \vdots \\ U_N(f)P_N(f)e^{-j2\pi f \sum_{k=1}^{N-1} T_k} \end{bmatrix}.$$

Let  $\mathbf{1}$  denote an  $N \times 1$  vector of ones, and let  $\sum_{i=1}^N T_i = \tilde{T}$ . Then the power spectrum of the resulting waveform can be shown to equal

$$S_q(f) = \frac{1}{\tilde{T}}(\|U\|^2 - \|\hat{U}\|^2) + \frac{1}{\tilde{T}^2} \mathbf{1}^T \hat{U} \hat{U}^H \mathbf{1} \sum_{k=-\infty}^{\infty} \delta(f - \frac{k}{\tilde{T}}) \quad (21)$$

where  $\|U\|^2$  is the sum of magnitudes squared of the elements of vector  $U$ , and  $U^H$  is the complex conjugate transpose (Hermitian) of  $U$ . Note the similarity to (11). A special case of (21) governs the setup considered in [16].

We now present experimental verification for the previous formula, with an experimental circuit comprising a single

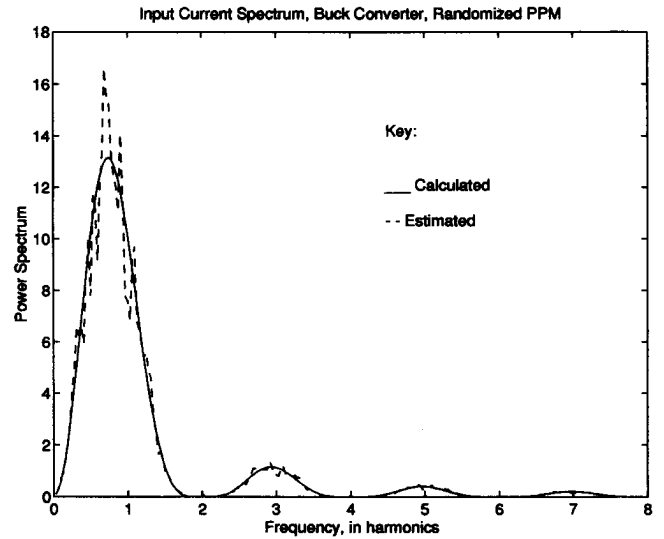

Fig. 20. Calculated and simulated spectrum of the input current for a buck converter in continuous conduction mode with randomized PPM.

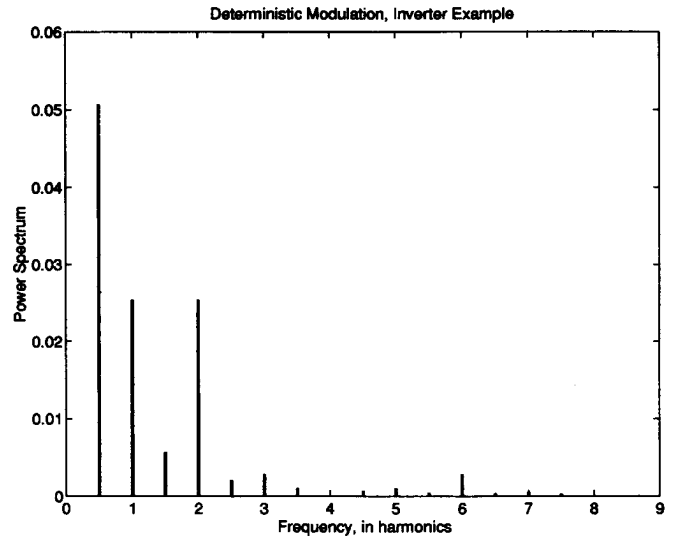

Fig. 21. Calculated power spectrum in deterministic modulation example.

phase of a three-phase inverter. The average switching frequency was kept at 250 Hz, as the experiments were aimed at verifying our analytical results. Consider the case  $N = 2$ , with uniform dither between 0 and  $\frac{T}{4} = 0.25$ . The basic pulses have  $D_1 = 0.25$  and  $D_2 = 0.75$ . The reference case of deterministic switching with alternate duty ratios  $D_1$  and  $D_2$  is shown in Fig. 21. The calculated spectrum for this randomized PPM is given in Fig. 22. The results shown in Fig. 22 are in close agreement with the experimental results for the same case, which are shown in Fig. 23. In this example the discrepancies between theoretical and experimental results for discrete harmonics are under 5%.

### IX. SYNTHESIS PROBLEMS

In this section the goal is to explore how effective randomized modulation is in achieving various performance specifications in the frequency domain. Desirable properties of power

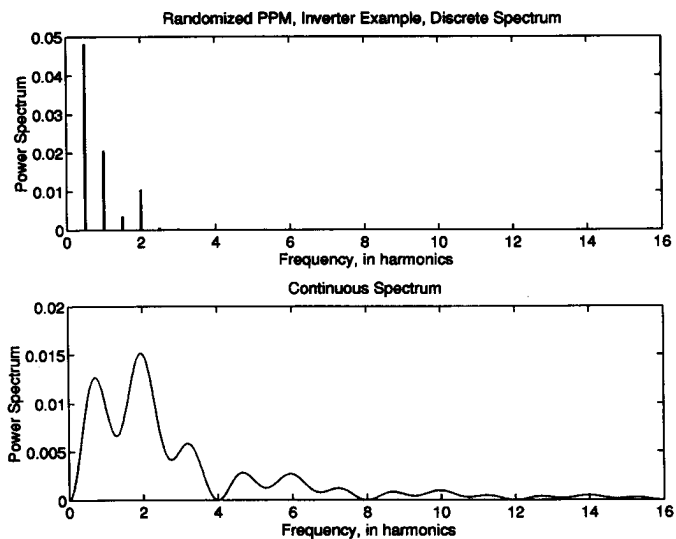

Fig. 22. Calculated spectrum for block-stationary randomized modulation example.

spectra are dependent on the particular application. Requirements of particular interest in practice are the following:

- Minimization of one or multiple, possibly weighted, discrete harmonics. This criterion corresponds to cases where narrow-band characteristics of discrete harmonics are particularly harmful, as for example in acoustic noise, or in narrow-band interference.
- Minimization of signal power (integral of the power spectrum) in a frequency segment that is of the order of an integral multiple of the switching frequency. This criterion corresponds to wide-band constraints in military specifications, and it could be of interest for EMI interference problems.

All the optimization problems in this section are presented for the case of randomized PPM. Formulations for other modulation schemes are analogous, and could be specified using the analytic expressions derived in [39]. To streamline the notation, it is assumed that the period of the reference (deterministic) switching waveform is unity,  $T = 1$ . In this case the power spectrum for randomized PPM is given by (11):

$$S_q(f) = W(f)\{1 - |P(f)|^2 + |P(f)|^2 \sum_{k=-\infty}^{\infty} \delta(f - k)\} \quad (22)$$

where the non-negative function  $W(f)$  represents the square of the Fourier transform of a rectangular pulse of unit height and width  $D$  centered at 0. Note that the  $k$ th discrete harmonic has intensity  $|P(k)|^2$ .

A typical narrow-band optimization criterion, which corresponds to the minimization of the sum of discrete harmonics between the  $l$ -th and  $L$ -th, can now be written as

$$J_{l,L}^{NB} = \sum_{k=l}^L W(k) |P(k)|^2 \quad (23)$$

where a weighting function could be absorbed in  $W(f)$ .

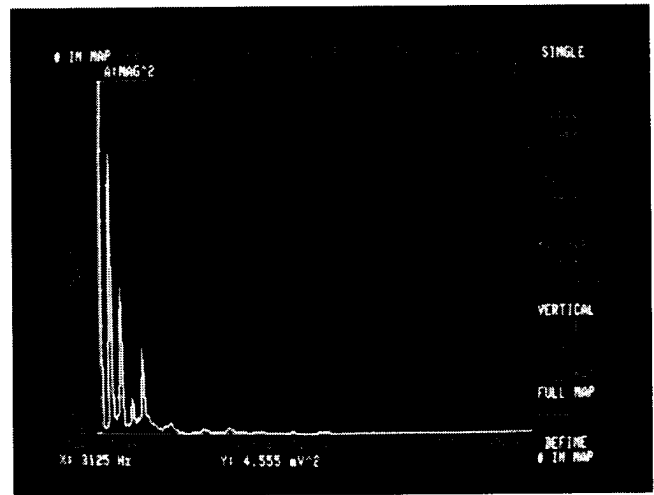

Fig. 23. Measured power spectrum in block-stationary randomized modulation example.

The wide-band optimization criterion used for illustration in this section corresponds to the minimization of the signal power for randomized PPM in the frequency segment  $[0 \ 1.5]$ , where the switching frequency is 1. This criterion can be written as

$$J_1^{WB} = \int_0^{\frac{3}{2}} W(f)(1 - |P(f)|^2)df + W(1) |P(1)|^2. \quad (24)$$

Both the narrow-band criterion  $J^{NB}$  and the wide-band criterion  $J^{WB}$  are in general nonlinear in  $P(f)$ ; in the PPM case, they are quadratic functions of  $P(f)$ .

The optimization process, which is performed in the frequency domain, has to generate a *function* that satisfies constraints in the time domain. In the case of stationary modulation schemes, the optimization is performed over the space of candidate probability densities  $\mathcal{P}$ . In all cases of practical interest these densities have finite support (extent). Not surprisingly, the performance achievable by randomized modulation depends on the extent of the imposed dither (i.e. the width of the support of the dither probability density), which is in turn limited by the duty ratio of the nominal switching waveforms. In the case of PPM, the dither is constrained to lie in the range  $[0, 1 - D]$ , where  $D$  is the nominal (undithered) duty ratio.

If global optimality of solutions to optimization problems in randomized modulation is needed, then a complete parametrization of the domain  $\mathcal{P}$  in the frequency domain is required. None of the results from Fourier theory known to us establishes a complete parametrization of the set of  $P(f)$ , even in the absence of constraints in the time domain. Thus, for our optimization purposes, we make do with partial parametrizations of the domain  $\mathcal{P}$ . Several simple parametrizations of  $\mathcal{P}$  were used in our numerical procedures, and together they enable optimization over many probability distributions of interest in implementations. The parametrizations used in the optimization problems here are defined in the time domain as

$$p(t) = \sum_{l=1}^N \alpha_l p_l(t) \quad (25)$$

TABLE I  
NARROW-BAND OPTIMIZATION  $J_{41}^{NB}$ : CRIT. ( $\times 10^4$ )

Modulation	D=0.1	D=0.5	D=0.9
Undithered	450.0	1250.0	450.0
Point Masses	71.8	0.0	197.0
Hanning	3.3	153.0	232.0
Rectangles	3.5	208.0	242.0
Uniform	3.5	417.0	283.0
Uniform Pt. Masses	255.0	211.0	240.0

where the  $p_l$  are known probability densities (“basis functions”) with appropriate finite support, and the  $\alpha_l$  are coefficients to be determined in the optimization. The coefficients satisfy  $\sum_{l=1}^N \alpha_l = 1$ , and  $\alpha_l \geq 0$ . It turns out that optimal probability densities obtained with different basis functions are very similar, and that they yield very similar performance in terms of the criterion values. This gives some assurance that the choice of basis functions is not critical for the optimization.

The basis functions used to parametrize the domain of candidate probability densities in this paper are

- rectangles, dividing the available probability density support ( $[0, 1 - D]$  in the PPM case) into  $N$  segments of equal width;
- Hanning windows (“raised cosine” functions), with  $p_1$  and  $p_N$  being “half-windows”.
- discrete probability densities of  $N$  point masses summing to 1, at fixed or variable locations;
- $\beta$ -densities, given (on the segment  $[0, 1 - D]$ ) by the expression

$$p(t) = \frac{1}{B(a, b)} t^{a-1} (1-t)^{b-1}$$

where  $B(a, b)$  is the normalizing constant

$$B(a, b) = \int_0^{1-D} t^{a-1} (1-t)^{b-1} dt.$$

A  $\beta$ -density depends on only two parameters, and it can approximate probability densities having a single maximum or minimum.

Other probability densities used for comparison are the uniform density, and a density comprising  $N$  equally spaced probability masses with coefficients  $\frac{1}{N}$ .

Optimization of the narrow-band criterion  $J_{1,41}^{NB} = J_{41}^{NB}$  is considered first, with  $N = 4$  basis functions in each parametrization. The criterion values at the numerically computed optimum are given in Table I. These optimization results are in agreement with the intuition that in cases when there is a large “dithering length” available (i.e., when the nominal duty ratio  $D$  is small), then a large reduction in the size of harmonics should be achievable. Though none of our parametrizations for probability densities ends up being

TABLE II  
WIDE-BAND OPTIMIZATION  $J_1^{WB}$ ,  $D = 0.5$ : CRIT. ( $\times 10^4$ )

Modulation	Criterion	Coefficients
Undithered	1013	
Point Masses	965	0.5 at 0.16 and 0.34
Hanning	973	[0.33, 0.17, 0.17, 0.33]
Rectangles	973	[0.35, 0.15, 0.15, 0.35]
$\beta$ -density	975	$a = b = 0.76$

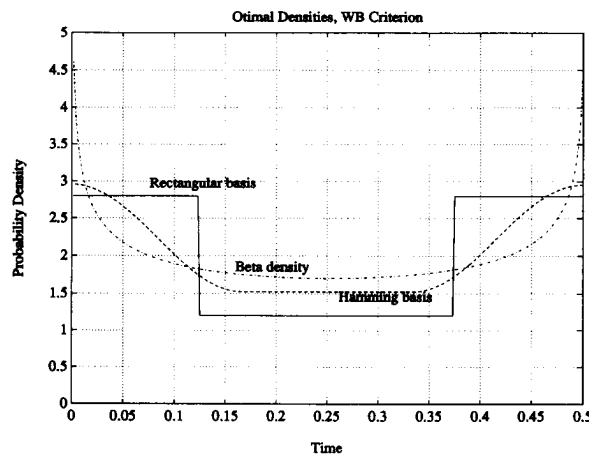

Fig. 24. Optimal probability densities in the wide-band optimization example.

superior for all cases, the optimal solutions for different parametrizations are in fact similar. For example, for  $D = 0.5$ , the optimal rectangle coefficients are  $[0.5, 0, 0, 0.5]$ , while the optimal peak height ratios for the Hanning basis functions are  $[0.5, 0, 0, 0.5]$  in general.

In the case of the duty ratio  $D = 0.5$ , with equal point masses at 0 and 0.5, the orthogonality of  $W(f)$  and  $|P(f)|$  yields 0 as the value of the criterion. This modulation scheme is sometimes referred to as *dual modulation*. Such extreme effectiveness in the reduction of discrete harmonics is not always a characteristic of randomized modulation, but it might account for some dramatic improvements reported in implementations.

The criterion  $J_1^{WB}$  is considered next, and results obtained for randomized PPM are given in Table II. The results suggest a limited effectiveness in reducing the total signal power in a wide frequency band (relative peak heights are given in the third column for the Hanning basis). Fig. 24 plots the optimal densities corresponding to the cases in Table II.

These examples suggest that randomized modulation is in general very effective in reducing the size of discrete components, thus providing a quantitative basis for wide-spread applications of randomized modulation to acoustic noise reduction. As pointed out earlier, the recent draft of new military specifications [30] introduces a single frequency

window for all spectral measurements. For example, the width of that window is 10 kHz for measurements in the range 250 kHz–30 MHz, thus favoring randomized modulation for switching frequencies  $10^5$ – $10^6$  Hz.

On the other hand, randomized modulation is much less effective in addressing wide-band spectral requirements. Spectral changes introduced by randomized modulation are mostly localized in frequency.

## X. CONCLUSIONS

The main motivation for the use of randomized modulation so far has been the possibility of acoustic noise reduction in inverter-based motor drives. It is argued in this paper that randomized modulation could be beneficial for operation of any power converter. The main benefit from randomized switching strategies in this context is better utilization of the allowable harmonic content of waveforms at the equipment/utility interface. Randomized modulation is not merely a way to take advantage of present regulations, which have been written for a deterministic switching discipline, but also a flexible approach to solving problems caused by electromagnetic or acoustic noise. To that end, the analytical results presented here might serve as an aid to assessment of the potential benefits of randomized modulation, and as a basis for design.

We have presented results for the power spectra of the switching functions for various stationary randomized modulation schemes, and have analyzed input currents as examples of waveforms that are not related to the switching function through a linear relationship. Synthesis problems in randomized modulation were considered in the last section of the paper, where both optimization criteria and numerical results are described. It is shown that randomized modulation can be very efficient in reducing the size of discrete harmonics and in satisfying narrow-band constraints, but is much less effective in dealing with wide-band requirements.

Results on stationary modulation can be generalized additional cases, described in detail in [39]. If one randomized modulation scheme, say randomized PPM, is applied to an already aperiodically modulated pulse train, the procedure is denoted as *cascaded* randomized modulation. In *alternate* modulation two different randomized modulation schemes are applied in alternation. In *random choice* of randomized modulation, at each cycle a random choice between two modulation schemes is made, and independent random experiments are performed afterwards to get values for the associated random parameters. These results are described in [39].

Switching based on a Markov chain possesses additional generality when compared to the randomized switching strategies described in this paper. The switching pattern in each cycle is made dependent on the state of the underlying Markov chain, thus providing an additional degree of flexibility. State transition probabilities can be chosen so that large local deviations from desired average steady-state behavior are discouraged or prevented altogether. This permits simultaneous control of spectral characteristics and time-domain ripple, for instance. Results on randomized modulation governed by Markov chains are presented in [39] and [42].

Modern motor drive systems require tailored PWM schemes. Deterministic PWM optimization, often labeled "programmed switching," is very successful in meeting the wide-band spectral requirements, while it has deficiencies in dealing with narrow-band spectral constraints. This paper shows that randomized modulation could play a complementary role.

## REFERENCES

- [1] F. J. Beutler and O. A. Z. Leneman, "Random sampling of random processes: Stationary point processes," *Information and Control*, vol. 9 pp. 325–346, 1966.
- [2] J. T. Boys and P. G. Handley, "Harmonic analysis of space vector modulated PWM waveforms," *IEE Proc.—Pt. B*, vol. 137, no. 4, pp. 197–204, July 1990.
- [3] ———, "Spread spectrum switching—low noise modulation technique for PWM inverter drives," *IEE Proc.—Pt. B*, vol. 139, no. 3, pp. 252–260, May 1992.
- [4] D. C. Champeney, *A Handbook of Fourier Transforms*. Cambridge: Cambridge Univ. Press, 1987.
- [5] B. Christiansen, "Analyzing and controlling harmonic distortion," *Powertechnics Mag.*, pp. 24–30, Nov. 1990.
- [6] P. W. Clarke, "Self-commutated thyristor dc-to-dc converter," *IEEE Trans. Magnetics*, vol. 6, no. 1, pp. 10–15, Mar. 1970.
- [7] J. Dupraz, *Probability, Signals, Noise*. New York: McGraw-Hill, 1986.
- [8] J. C. Fluke, *Controlling Conducted Emissions by Design*. New York: Van Nostrand Reinhold, 1991.
- [9] L. E. Franks, *Signal Theory*, rev. ed. Dowden and Culver, 1981.
- [10] W. A. Gardner, *Introduction to Random Processes*. New York: McGraw-Hill, 1990.
- [11] T. G. Habetler and D. M. Divan, "Acoustic noise reduction in sinusoidal PWM drives using a randomly modulated carrier," *IEEE Trans. Power Electron.*, vol. 6, no. 3, pp. 356–363, July 1991.
- [12] P. G. Handley, M. Johnson, and J. T. Boys, "Elimination of tonal acoustic noise in chopper-controlled dc drives," *Appl. Acoustics*, vol. 32, pp. 107–119, 1991.
- [13] C. W. Helstrom, *Probability and Stochastic Processes for Engineers*, 2nd ed. New York: Macmillan, 1991.
- [14] G. M. Jenkins and D. G. Watts, *Spectral Analysis and Its Applications*. Oakland, CA: Holden-Day, 1968.
- [15] J. G. Kassakian, M. F. Schlecht, and G. C. Verghese, *Principles of Power Electronics*. Reading, MA: Addison-Wesley, 1991.
- [16] R. L. Kirlin, S. Legowski, A. M. Trzynadlowski, Y. Cui, and S. Kwok, "Power spectra of a three phase inverter with random pulse width modulation modes," *Electron. Lett.*, 1992.
- [17] J. Klein and M. K. Nalbant, "Power factor correction—Incentives, standards and techniques," *PCIM Mag.*, pp. 26–31, June 1990.
- [18] F. Kravitz and M. Lemke, *Communications/Electronics Receiver Performance Degradation Handbook*, Tech. Rep., DoD EMC Analysis Center, 1975.
- [19] S. Legowski, J. Bei, and A. M. Trzynadlowski, "Analysis and implementation of a grey-noise technique based on voltage space vectors," in *IEEE APEC Proc.*, Feb 1992, p. 586–593.
- [20] S. Legowski and A. M. Trzynadlowski, "Hypersonic MOSFET-based power inverter with random pulse width modulation," in *Proc. IEEE Ind. Applicat. Soc. Annu. Meeting*, Oct. 1989, pp. 901–903.
- [21] S. Legowski and A. M. Trzynadlowski, "Advanced random pulse width modulation technique for voltage-controlled inverter drive systems," in *IEEE APEC Proc.*, Mar. 1991, pp. 100–106.
- [22] O. A. Z. Leneman, "Random sampling of random processes: Impulse processes," *Information and Control*, vol. 9, pp. 347–363, 1966.
- [23] A. Leon-Garcia, *Random Processes for Electrical Engineering*, 2nd ed. Reading, MA: Addison-Wesley, 1994.
- [24] H. Lev-Ari, "Nonstationary lattice-filter modeling," Ph.D. thesis, Stanford University, 1983.
- [25] L. Ljung, *System Identification: Theory for the User*. Englewood Cliffs, NJ: Prentice-Hall, 1987.
- [26] M. T. Ma, M. Kanda, M. L. Crawford, and E. B. Larsen, "A review of electromagnetic compatibility/interference measurement methodologies," *Proc. IEEE*, vol. 73, no. 3, pp. 388–411, Mar. 1985.
- [27] S. L. Marple, *Digital Spectral Analysis with Applications*. Englewood Cliffs, NJ: Prentice-Hall, 1987.
- [28] *Matlab User's Guide*. The MathWorks, Natick, MA, 1989.
- [29] D. Middleton, *An Introduction to Statistical Communication Theory*. New York: McGraw-Hill, 1960.

- [30] U.S. Department of Defense, MIL SPEC 461/462 e. Tech. Rep., DoD EMC Analysis Center, 1993. Draft.
- [31] A. V. Oppenheim and R. W. Schaffer, *Discrete-Time Signal Processing*. Englewood Cliffs, NJ: Prentice-Hall, 1989.
- [32] H. W. Ott, *Noise Reduction Techniques in Electronic Systems*. New York: Wiley, 1988.
- [33] A. Papoulis, *The Fourier Integral and Its Applications*. New York: McGraw-Hill, 1962.
- [34] ———, *Probability, Random Variables and Stochastic Processes*, 2nd ed. New York: McGraw-Hill, 1984.
- [35] J. K. Pedersen and F. Blaabjerg, "Implementation and Test of a digital quasi-random modulated SFAVM PWM in a high performance drive system," in *IEEE Ind. Electron. Conf. IECON*, 1992.
- [36] J. G. Proakis and D. G. Manolakis, *Digital Signal Processing: Principles, Algorithms and Applications*. New York: Macmillan, 1992.
- [37] J. M. Retif and B. Allard, "A PWM ASIC Using Stochastic Coding," in *PESC Proc.*, July 1992, p. 587–594.
- [38] R. M. Showers, R. B. Schulz, and S. Y. Lin, "Fundamental limits on EMC," *Proc. IEEE*, vol. 69, no. 2, pp. 183–195, Feb. 1981.
- [39] A. M. Stanković, "Random pulse modulation with applications to power electronic converters," Ph.D. thesis, EECS Dept., M.I.T., 1993.
- [40] A. M. Stanković, G. C. Verghese, and R. O. Hinds, "Monte Carlo verification of power spectrum formulas for random modulation schemes," in *Third IEEE PELS Workshop Comput. Power Electron.*, Aug. 1992, pp. 187–194.
- [41] A. M. Stanković, G. C. Verghese, and D. J. Perreault, "Analysis and synthesis of random modulation schemes for power converters," in *PESC Proc.*, June 1993, p. 1068–1074.
- [42] ———, "Randomized modulation schemes for power converters governed by Markov chains," submitted to *IEEE Trans. Contr. Syst. Technol.*, 1995.
- [43] T. Tanaka, H. Kameda, and T. Ninomiya, "Noise analysis of dc-dc converter with random switching control," in *Proc. Intelec'91*, Nov. 1991, pp. 283–290.
- [44] T. Tanaka and T. Ninomiya, "Random-switching control for DC-DC converter: Analysis of noise spectrum," in *IEEE PESC Proc.*, 1992, pp. 579–586.
- [45] T. Tanaka, T. Ninomiya, and K. Harada, "Random-switching control in DC-DC converters," in *IEEE PESC Proc.*, 1989, pp. 500–507.
- [46] R. E. Tarter, *Principles of Solid-State Power Conversion*. Indianapolis, IN: Howard H. Sams, 1985.
- [47] A. M. Trzynadlowski, S. Ji, and S. Legowski, "Random pulse width modulation of delta inverter for automotive applications," in *Proc. IEEE Ind. Applicat. Soc. Annu. Meeting*, Oct. 1991, pp. 826–833.
- [48] A. M. Trzynadlowski, S. Legowski, and R. L. Kirilin, "Random pulse width modulation technique for voltage-controlled power inverters," in *Proc. IEEE Ind. Applicat. Soc. Annu. Meeting*, Oct. 1987, pp. 863–868.
- [49] ———, "Random pulse width modulation technique for voltage-controlled power inverters," *Int. J. Electron.*, vol. 68, no. 6, pp. 1027–1037, 1990.
- [50] A. Wang and S. R. Sanders, "Random and programmed pulse-width modulation techniques for dc-dc converters," in *Proc. IEEE Int. Conf. Syst. Eng.*, 1990, pp. 589–592.
- [51] B. Wilkenson, "Power factor correction and IEC 555-2," *Powertechnics Mag.*, pp. 20–24, Feb. 1991.
- [52] A. M. Yaglom, *Correlation Theory of Stationary and Related Random Functions*. Berlin: Springer-Verlag, 1987.



**Aleksandar M. Stanković** (S'91–M'93) obtained the Dipl. Ing. degree from the University of Belgrade, Yugoslavia, in 1982, the M.S. degree from the same institution in 1986, and the Ph.D. degree from Massachusetts Institute of Technology in 1993, all in electrical engineering.

He has been an Assistant Professor with the Department of Electrical and Computer Engineering at Northeastern University, Boston, MA, since 1993. His research interests are in modeling and control problems in power electronics and power systems,

and his work concerns random modulation in power electronic converters, analysis and controller design to counter low-frequency oscillations in power systems and electrical drives and switching pattern design methodologies for motion control systems.

Dr. Stanković is a member of IEEE Power Electronics, Control Systems and Power Engineering Societies. His work has been supported by NSF and ONR.



**George C. Verghese** (S'74–M'78) received the B. Tech. degree from the Indian Institute of Technology at Madras in 1974, the M.S. degree from the State University of New York at Stony Brook in 1975, and the Ph.D. degree from Stanford University in 1979, all in electrical engineering.

He is Professor of Electrical Engineering and a member of the Laboratory for Electromagnetic and Electronic Systems at the Massachusetts Institute of Technology, which he joined in 1979. His research interests and publications are in the areas of systems, control, and estimation, especially as applied to power electronics, electrical machines, large power systems, and signal processing.

Dr. Verghese has served as an Associate Editor of *Automatica* and of the IEEE TRANSACTIONS ON AUTOMATIC CONTROL. He is on the AdCom of the IEEE Power Electronics Society, which he has served in various other capacities as well, including as founding chair of its technical committee and workshop on Computers in Power Electronics. He is co-author (with J.G. Kassakian and M.F. Schlecht) of *Principles of Power Electronics* (Reading, MA: Addison-Wesley, 1991).

**David J. Perreault** (S'91), for a photograph and biography, see p. 262 of the May 1995 issue of this TRANSACTIONS.