

A software pilot application to calculate the parameters involved in subsidiaries interconnection based on FSO technology

Desarrollo de una aplicación piloto de software para calcular los parámetros que involucran la interconexión de sedes basada en la tecnología FSO

Desenvolvimento de uma aplicação piloto de software para calcular os parâmetros que envolvem a interconexão de sedes baseada na tecnologia FSO

Fecha de recepción: 14 de mayo de 2016
Fecha de aprobación: 1 de noviembre de 2016

Jorge Enrique Salamanca*
Danilo Alfonso López-Sarmiento**
Adriana Patricia Gallego-Torres***

Abstract

Free Space Optics (FSO) technology transmits information using free space optical signals similar to those that travel through optical fibers. The capacity of FSO to connect buildings close together is covered in this paper. Four optical wireless links between three buildings of a fictitious company, considering a building that obstructs the sight line between two of them, are designed here. As part of the design process, several issues such as distance between the equipment, weather conditions, some features of the FSO equipment, and system losses were addressed; moreover, an application that performs the calculations and displays the results of the most important aspects in the design was implemented. The importance of such links is given by their flexibility, low implementation costs, mobility, rapid deployment, high throughput, great bandwidth, reliability, and high security level due to their operating principles, among others; therefore, this type of links are an ideal option to implement a backbone for the proposed network.

Keywords: atmospheric attenuation; backbone; FSO technology; geometric attenuation; link margin; optical wireless access; subsidiary interconnection.

* Universidad Distrital “Francisco José de Caldas” (Bogotá-Distrito Capital, Colombia). jsalamanca@udistrital.edu.co.

** Universidad Distrital “Francisco José de Caldas” (Bogotá-Distrito Capital, Colombia). dalfonsol@udistrital.edu.co.

*** Ph. D. Universidad Distrital “Francisco José de Caldas” (Bogotá-Distrito Capital, Colombia). adpgallegot@udistrital.edu.co.

Resumen

La Tecnología Free Space Optics (FSO) transmite información por el espacio libre, utilizando señales ópticas similares a las que viajan a través de las fibras ópticas. Las FSO permiten conectar edificios cercanos entre sí, como se aborda en el presente artículo. Se presenta aquí el diseño de cuatro enlaces inalámbricos **ópticos** entre tres edificaciones de una empresa ficticia, contemplando un edificio que obstaculiza la línea de visión entre dos de ellas; dentro del proceso de diseño se consideraron varios aspectos, como la distancia entre los equipos, las condiciones climáticas, algunas características propias de los equipos de FSO y las pérdidas producidas en el sistema; además, se implementó una aplicación que efectúa dichos cálculos y muestra los resultados de los aspectos más importantes en el diseño; la importancia de este tipo de enlaces radica en su flexibilidad, sus bajos costos de implementación, su movilidad, su rápido despliegue, la alta tasa de transferencia, el gran ancho de banda que maneja, la confiabilidad y el alto índice de seguridad, debido a sus principios de funcionamiento, entre otros, que hacen de ellos una opción ideal para implementar un backbone para la red propuesta.

Palabras clave: acceso inalámbrico óptico; atenuación atmosférica; backbone; interconexión de sedes; margen de enlace; tecnología FSO.

Resumo

A Tecnologia Free Space Optics (FSO) transmite informação pelo espaço livre, utilizando sinais óticos similares às que viajam através das fibras óticas. As FSO permitem conectar edifícios próximos entre si, como é abordado no presente artigo. Apresenta-se aqui o desenho de quatro conexões sem fio óticas entre três edificações de uma empresa fictícia, contemplando um edifício que obstaculiza a linha de visão entre duas delas; dentro do processo de desenho consideraram-se vários aspectos, como a distância entre os equipamentos, as condições climáticas, algumas características próprias dos equipamentos de FSO e as perdas produzidas no sistema; além disso, implementou-se uma aplicação que efetua tais cálculos e mostra os resultados dos aspectos mais importantes no desenho; a importância deste tipo de conexões radica em sua flexibilidade, seus baixos custos de implementação, sua mobilidade, seu rápido desdobramento, a alta taxa de transferência, a grande largura de banda que maneja, a confiabilidade e o alto índice de segurança, devido aos seus princípios de funcionamento, entre outros, que fazem deles uma opção ideal para implementar um backbone para a rede proposta.

Palavras chave: Aceso sem fio ótico, Atenuação atmosférica, Backbone, Interconexão de sedes, Margem de conexão, Tecnologia FSO.

Cómo citar este artículo:

J. E. Salamanca, D. A. López-Sarmiento, and A. P. Gallego-Torres, "A software pilot application to calculate the parameters involved in subsidiaries interconnection based on FSO technology," *Rev. Fac. Ing.*, vol. 26 (44), pp. 147-156, Ene. 2017

I. INTRODUCTION

A Free Space Optics (FSO) system, also called “optical wireless access”, can be thought either as a wireless system that uses infrared light instead of radio waves, or an optical communication system that transmits laser light point-to-point through air, instead of using an optical fiber cable [1].

In developed countries, contrary to the radio and microwave systems, to apply FSO is not usually necessary to get a spectrum license or frequency coordination with other users, because interference from one system to another is not an issue to be considered, and the laser signal transmitted point-to-point is extremely difficult to intercept, therefore, it is highly secure [2]. Data transfer rates are comparable with those of the fiber-optic; data can be transmitted with minimal error rates, while the thin laser beam assures the localization of multiple transceivers without mutual interference at any point [1]. In some countries, the freedom resulted from not having to comply with regulations or to obtain licenses is translated into ease, speed, and low cost of deployment.

Because the optical wireless transceivers can transmit and receive through windows, it is possible to set them up inside buildings, reducing the need for using roof space, simplifying cabling, and allowing the equipment to work in a highly favorable environment. The only essential requirement is the existence of a sight line between the two linked points [3]. The main benefit of FSO technology is its high capacity offered at low costs and high availability.

II. FSO SYSTEM

A FSO system (Fig. 1) is composed by a transmitter, a receiver, and an optical subsystem. The transmitter utilizes a variety of light sources, and is used to transfer data that comply with characteristics such as low consumption, high reliability, small size, and high exit power. The receiver is characterized by its high sensitivity, minimal error rate, low noise, and high efficiency; it converts the optical signal into electric signal, and then regenerates it. The optical subsystem is composed by lenses or mirrors that have an important function in such equipment.

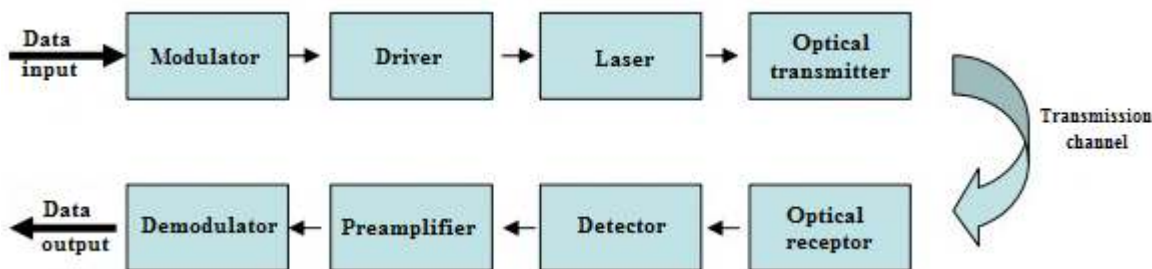

FIG. 1. Block diagram of the FSO system [1, 4].

Correct design and installation of the FSO system are fundamental for optimal long-term performance. Design involves the assessment of needs, considering the customer and the work network because they determine the main network parameters, as well as the assessment of the environment, weather conditions, link distance, and sight line. This paper takes into account aspects regarding the study of the place of installation, topology, and calculations using an application created in MATLAB.

A. Assessment of the installation place

- We analyzed the assembly of the backbone in three buildings belonging to a fictitious company (building A, building B, and building C), as well as aspects such as weather conditions, geographic

and topographic layout of the buildings, existence of sight line between buildings, characteristics of the equipment employed for the links, among other aspects that will be approached later in this paper.

First, we visually analyzed the geographical layout and height of the buildings (Table 1), and concluded that it was necessary to use a connection point between buildings A and B because building X is interrupting their sight line. Measurements between the proposed points to assembly the FSO equipment in the three buildings were made using Google Earth [5]; the UTM geographic coordinates, and the building heights measured with an altimeter were used to estimate the real distance between equipment. These results were tabulated (Table 1), and can be observed in the structures in Google Earth (Fig. 2).



FIG. 2. Different views of the three buildings taken in Google Earth.

TABLE 1

GEOGRAPHIC COORDINATES AND HEIGHT OF THE PROPOSED POINTS FOR THE ASSEMBLY

Building	Geographic position		Height (m)
	Point 1 (E, N)	Point 2 (E, N)	
A	(603379.48, 510604.68)	(603384.91, 510618.78)	2757
B	(603290.78, 510629.51)	(603294.54, 510643.79)	2681
C	(603360.54, 510666.47)	(603331.14, 510681.03)	2658
X	(603340.79, 510623.37)	(603321.88, 510626.98)	2717

In order to estimate the distance between the FSO link points, we used the geographic position to calculate the Euclidian distance between buildings, and because the buildings have different elevations, we estimated the real distance between the link points in each building (Fig. 3).

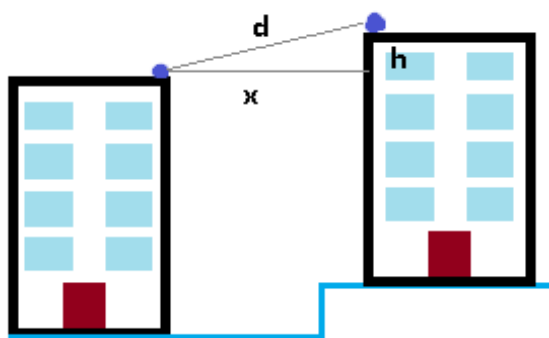

FIG. 3. Distance between buildings and link points.

As shown in figure 3, to find the real distance (d) between the link points, it is necessary to calculate the Euclidian distance between them using equation (1) [6].

$$d = \sqrt{x^2 + h^2} \quad (1)$$

With the real distance between points, it is possible to find the main characteristics to evaluate the design and feasibility of the FSO link, as shown below.

B. Link margin

The feasibility analysis of the design in a particular environment indicates the relationship between power transmitted and power received, taking into account some losses in the FSO system; the value of this relationship determines whether the implementation of a link is feasible. Link margin is calculated using equation (2) [7].

$$M_{\text{link}} = P_e + |S_r| + A_{\text{geo}} + A_{\text{atm}} + P_{\text{er}}$$

P_e is the transmit power (dB)

S_r is the receptor sensitivity (dB)

A_{geo} is the geometric attenuation (dB)

A_{atm} is the atmospheric attenuation (dB)

P_{er} are the system losses (dB)

C. Transmit power

Data of signal transmit power and receptor sensitivity are provided by the FSO equipment manufacturers. For optical wireless links between core switches, a SONABEAM 155-M FSO equipment will be used, whose transmit and sensitivity powers are [8]:

$$P_e = 640 \text{ dB}$$

$$S_r = -31 \text{ dB}$$

D. Geometric attenuation

The beam emitted by the transmitter will undergo divergence; hence, the receptor cell will receive only a fraction of the emitted energy. Attenuation is described by equation (3) [7].

$$A_{\text{geo}} = \frac{\frac{\pi}{4} * (d * \theta)^2}{S_{\text{capt}}} \quad (3)$$

d is the distance traveled by the beam (m)

θ is the beam divergence (milliradians)

S_{capt} is the capture area of the receptor (m^2)

Geometric attenuation is a function of the distance, beam divergence, and receptor capture area. For the design, beam divergence is 3 milliradians (maximum possible typical value with the link characteristics), and capture area (FSO equipment manufacturer standard) is usually 0.025 m^2 [9]. Geographic attenuation limits the useful link distance, and may reduce system availability.

E. Atmospheric attenuation

Atmospheric attenuation is defined by Beer's law,

which describes an empirical relationship between light absorption and the characteristics of the material through which the light is traveling. Beer's law, described with equation (4), explains that the relationship between light transmission through a substance and the substance's concentration is exponential [7].

$$\frac{P(d)}{P(0)} * e^{-\sigma * d} \quad (4)$$

$P(d)$ is the signal power at a distance d (W)

$P(0)$ is the transmit power (W)

e is the exponential relationship

σ is the attenuation coefficient

d is the distance traveled by the beam (km)

The attenuation coefficient is the sum of the four terms described in equation (5) [7].

$$\sigma = \alpha_m + \alpha_n + \beta_m + \beta_n \quad (5)$$

α_m is the molar attenuation coefficient

α_n is the aerosol absorption coefficient

β_m is the Rayleigh scattering coefficient

β_n is the Mie scattering coefficient

The absorption and attenuation coefficients refer to the energy that the atmosphere and certain particles absorb; the Rayleigh scattering coefficient results from the interaction of light with particles of smaller size with respect to its wavelength; the Mie scattering coefficient refers to the light incident on particles of similar size to its wavelength. Considering the spectrum used by the FSO, which ranges from 780 nm to 1550 nm [11], we can disregard the molar attenuation coefficient, the aerosol absorption coefficient, and the Rayleigh scattering coefficient.

Mie scattering coefficient is a function of the visibility; therefore, the attenuation coefficient is given by the equation (6) [8].

$$\sigma = \beta_n \quad (6)$$

Visibility (Table 2) is defined as the distance at which light intensity decreases 2 % of its initial value. The variation of the attenuation coefficient with respect to the visibility is described by the Kruse model and the equation (7) [7].

$$\sigma = \beta_n = \frac{3.912}{V} * \left(\frac{\lambda}{550}\right)^{-q} \quad (7)$$

V is visibility (km)

λ is wavelength (nm)

q is the dispersion of a particle in a medium where:

$$q = 1.6 \quad V > 50 \text{ km}$$

$$1.3 \quad 6 \text{ km} < V < 50 \text{ km}$$

$$0.16 * V + 0.34 \quad 1 \text{ km} < V < 6 \text{ km}$$

$$*V - 0.5 \quad 0.5 \text{ km} < V < 1 \text{ km}$$

TABLE 2
VISIBILITY VALUES [12]

Environmental conditions	Precipitation	mm/hr	Visibility [m]	
Very heavy fog	-----		0 m	
	-----		50 m	
heavy fog	-----		500 m	
	-----		600 m	
	Storm	100	770 m	
	-----		1 Km	
Moderate fog	Snow	Heavy rain	25	1,9 Km
		-----		2 Km
		Moderate rain	12,5	2,8 Km
		-----		4 Km
Fog	-----	Light rain	2,5	5,9 Km
		-----		10 Km
Clear	-----	Drizzle	0,25	18,1 Km
		-----		20 Km
Very clear	-----		23 Km	
	-----		50 Km	

According to Table 2, under the worst possible weather conditions, visibility has an approximate value of 770 m; in this way, we obtain the value of the attenuation coefficient.

Optical transmittance is defined as the fraction of incident light, at a specific wavelength, that travels through a material; it is described by equation (8) [13].

$$\tau(d) = \frac{P(d)}{P(0)} \quad (8)$$

$\tau(d)$ is the transmittance at a distance d from the transmitter

P(d) is the signal power at a distance d (W)

P(0) is the transmit power (W)

Finally, we equal equation (4) with equation (8) to obtain equation (9).

$$\tau(d) = e^{-\sigma * d} \quad (9)$$

$\tau(d)$ is the transmittance at a distance d from the transmitter

e is the exponential relationship

σ the attenuation coefficient

d is the distance traveled by the beam (km)

Atmospheric attenuation is related to transmittance according to equation (10) [7]. The atmospheric attenuation values increase proportionally to the distance the beam must travel through the medium.

$$A_{atm} = 10 * \log_{10} \left(\frac{1}{\tau(d)} \right) \quad (10)$$

F. System losses

Losses arise from inherent factors of the FSO equipment. Losses may occur in connectors, which, usually, have low values; losses also may occur at signal reception due to equipment misalignment, which should be considered in the design to avoid mistakes during installation, or problems caused by wind, blows, or the oscillation of the support structure. For design purposes, we assumed a system loss of 4 dB

that represents the sum of such losses, and a considerable value to emulate the worst-case scenario [10].

G. Topology

Currently, the buildings have their own LAN but they are not interconnected, therefore, a defined topology among them is missing. The proposed topology (Fig. 4) for this backbone, it a tree topology, which is a variation from the bus network; the tree topology has

a main link node, generally occupied by a router or switch, from which the other nodes branch out. With this topology, failure in one node does not imply interruption in communication; the same communication medium is shared, which works in diffusion mode since the information is propagated toward all stations. One of the restrictions is congestion; because many stations share the same transmission medium, interference between signals may occur when two or more stations transmit at the same time [14].

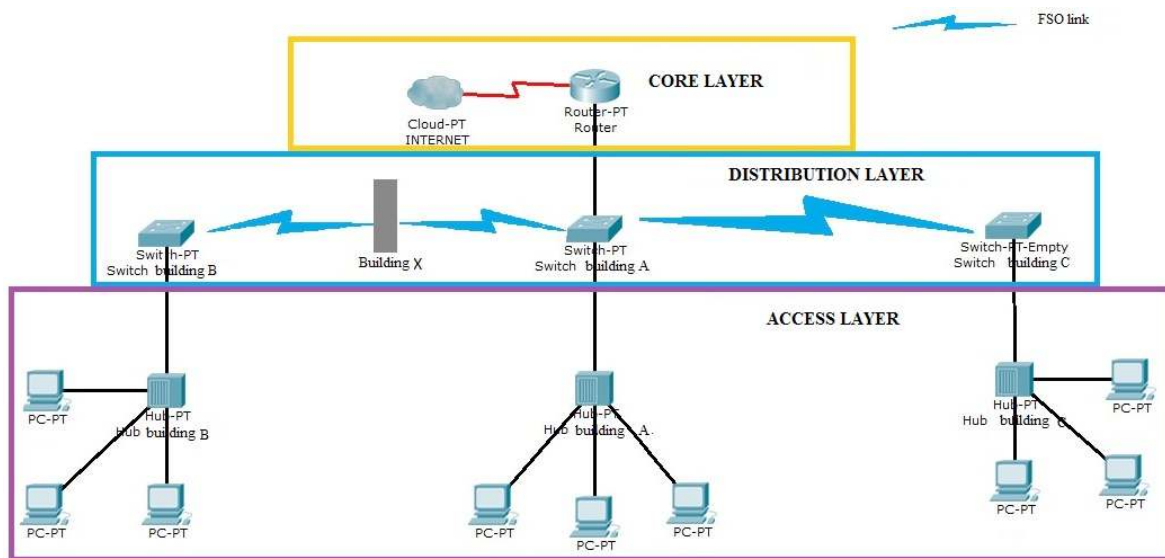

FIG. 4. Proposed topology for the implementation.

The topology proposes a hierarchical model with three layers:

1) *Core*. It allows optimal transport among the different network points, provides connectivity and commutation policies, and constitutes the network backbone. The core works over layers 2 and 3 of the OSI model, with high commutation speed and without manipulating packets.

2) *Distribution*. In this layer, the packets are manipulated, which allow to apply network management policies, and put filters to the packets that circulate in the network; this prevents the packets for affecting the layer core and its commutation speed.

3) *Access*. It constitutes the entry to the stations, work equipment, and network server. The used devices are switches or hubs, but for the present design, we propose to use layer 2 switches, whose advantage

is that each station broadband is determined by the connection, in addition to allow the segmentation and division of the collision domains [15].

H. Calculations

A Graphic User Interface (GUI) was created with the software MATLAB v7.10.0.499 (R2010a) to perform the pertinent calculations (Fig. 5). The most relevant data for the design and feasibility analysis are entered into the GUI, which, in turn, generates several tables with the results for all the items mentioned above.

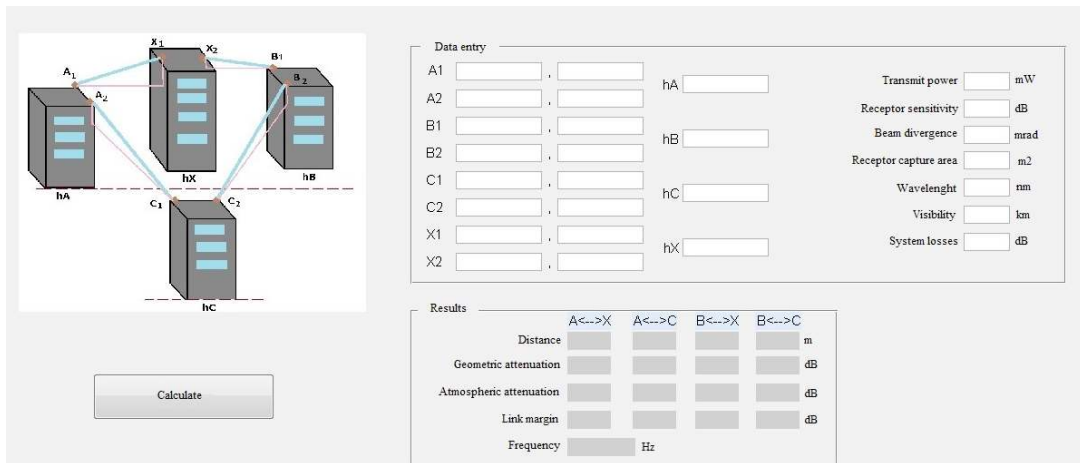

FIG. 5. Graphic User Interface (GUI) created to design the proposed FSO.

Initially, geographic coordinates data for each point of the respective links are entered: building height, device transmit power, receptor sensitivity, beam di-

vergence, receptor capture area, wavelength used in the links, visibility, and system losses (Fig. 6).

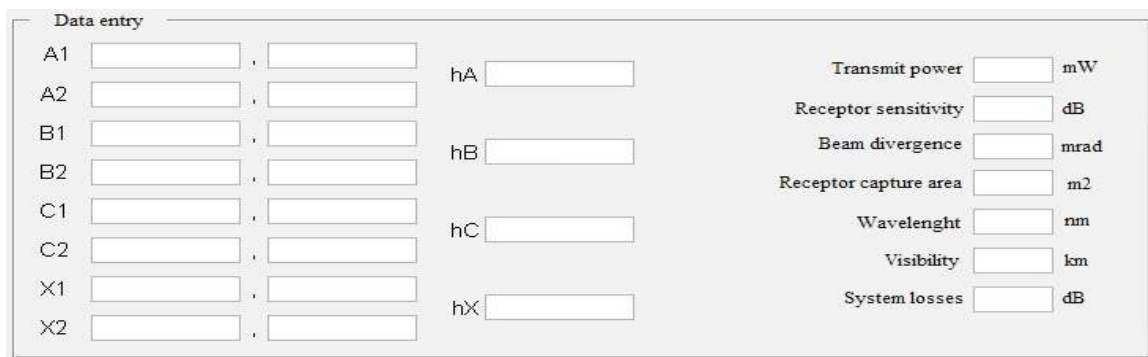

FIG. 6. Application panel where the data relevant to the design is introduced.

Subsequently, the “*calcular*” button is pressed, and the results for every link are displayed, showing some of the values per link, such as real distance

between points, geometric attenuation, atmospheric attenuation, link margin, and frequency used in the link (Fig. 7).

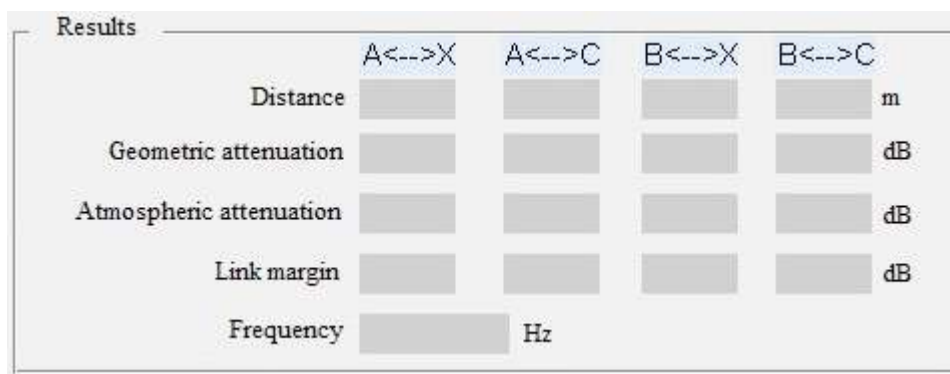

FIG. 7. Result panel where the values for every link of the proposed FSO are displayed.

III. RESULTS

After designing the links, we obtained the following results for the proposed topology (Fig. 8):

The minimal distance between the optical wireless links is 47.64 m, which refers to the free space distance between the terraces of buildings B and X.

The largest free space distance that must be covered is the one between the terraces of buildings A and C, which is 112.55 m.

The maximum attenuation value due to fog (atmospheric attenuation) corresponds to 65.541 dB for the link proposed between buildings A and C; this attenuation value is directly proportional to the distance covered by such link.

The losses corresponding to atmospheric attenuation due to fog reach values between 2.5916 dB and 2.016 dB.

Geometric attenuation values between 58.073 dB and 65.541 dB correspond to the shortest distance (*química- deléctrica* and *química-dmecánica*) and longest distance (*cugi-observatorio*) links, respectively.

The link margin value, that allows to know whether a link is feasible, ranges between 9.4796 dB and 4.74 dB.

Regarding the logic level, the network requires a layer 2/layer 3 commutation device that complies with the current hierarchizing, to perform the functions of a distribution level.

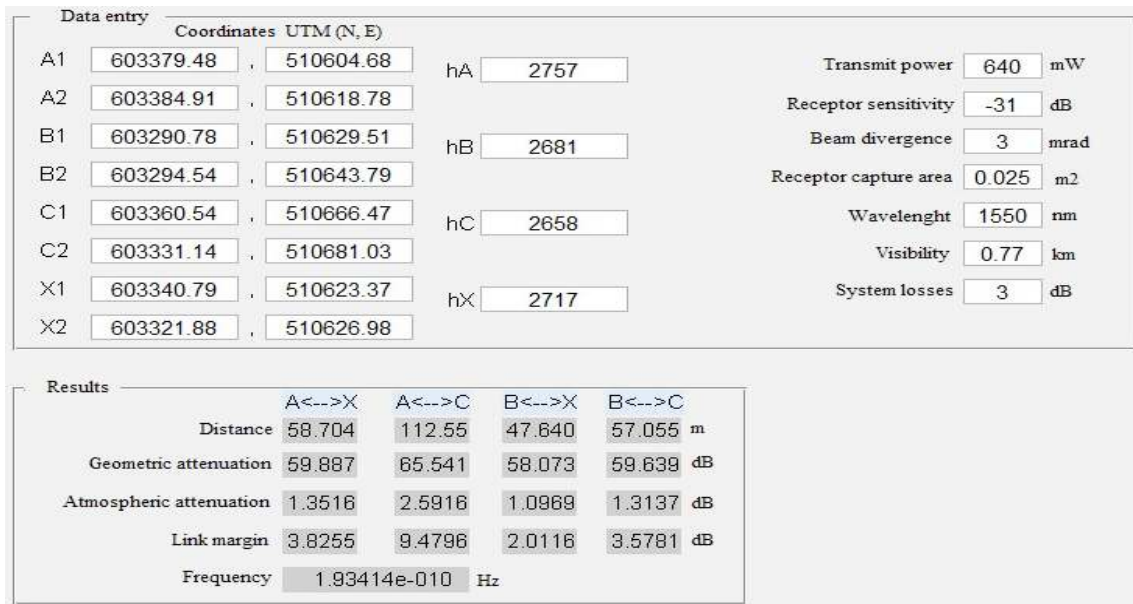

FIG. 8. Results obtained for the proposed FSO.

IV. CONCLUSIONS

FSO is an interconnection technology able to optimize the data transmission efficiency when connecting multiple subsidiaries is necessary. Despite being a promising technology, the FSO network cost is comparable to the optic-fiber because the equipment is expensive; however, the easy installation and access to locations where installing optic-fiber would be difficult and expensive due to the topology and distance

between buildings, is a great advantage of the FSO technology.

Regarding the design, we implemented a pilot system based on a software (developed in MATLAB), which allowed to perform the necessary calculations to interconnect the subsidiaries, based on the FSO system.

REFERENCES

- [1] L. Quiroz, N. Moreno, and N. Vera, "Modelo para una red híbrida óptica inalámbrica," *Revista Redes de Ingeniería*, vol. 3(1), pp. 56-65, Jul. 2012.
- [2] F. Santamaría, J. Ballesteros, and J. S. González, "Plataforma cloud computing como infraestructura tecnológica para laboratorios virtuales, remotos y adaptativos," *Revista Científica*, vol. 3(23), pp. 103-116, 2016. DOI: <http://doi.org/10.14483/udistrital.jour.rc.2015.23.a8>.
- [3] J. W. Escobar, "Rediseño de una red de distribución con variabilidad de demanda usando la metodología de escenarios," *Revista Facultad de Ingeniería*, vol. 21(32), pp. 9-19, 2013.
- [4] H. Willebrand and B. Ghuman, *Free Space Optics: Enabling Optical Connectivity in Today's Networks*, Sams Publishing, USA, 2002.
- [5] Google Earth, [en línea]. Disponible en: <http://www.google.es/intl/es/earth/index.html>.
- [6] X. Zhu, V. S. Hsu, and J. M. Kahn, "Optical modeling of MEMS corner cube retroreflectors with Misalignment and Nonflatness," *IEEE J. on Selected Topics in Quantum Electronics*, vol. 8(1), pp. 26-32, Jan. 2002. DOI: <http://doi.org/10.1109/2944.991396>.
- [7] O. Bouchet, H. Sizun, C. Boisrobert, F. De Fornel, and P. Favennec, *Free Space Optics: Propagation and Communication*, ISTE, United Kingdom, 2006. DOI: <http://doi.org/10.1002/9780470612095>.
- [8] J. Pérez, F. López, and N. Mosquera, "Arquitectura de seguridad de un entorno computacional para e-Ciencia en la nube," *Revista Científica*, vol. 3(26), pp. 59-69, 2016.
- [9] Z. Karakehayov, "Zero power design for smart dust networks," *Proceeding of 2002 First International IEEE Symposium*, vol. 1, 10-12, pp. 302-305, Sep. 2002. DOI: <http://doi.org/10.1109/is.2002.1044272>.
- [10] H. D. Páez-Logreira, R. Zamora-Musa, J. Bohórquez-Pérez, "Programación de controladores lógicos (PLC) mediante ladder y Lenguaje de control estructurado (SCL) en MATLAB," *Revista Facultad de Ingeniería*, vol. 24 (39), pp 109-119, 2015. DOI: <http://doi.org/10.19053/01211129.3555>.
- [11] Z. Chair and P. Varshney, "Optimum data fusion in multiple sensor detection systems," *IEEE Transactions on Aerospace and Electronic Systems*, vol. 22(1), pp. 98-101, 1986. DOI: <http://doi.org/10.1109/TAES.1986.310699>.
- [12] M. Born and E. Wolf, *Principles of Optics*, Sixth Edition, Pergamon Press, 1980.
- [13] L. Zhou, J. M. Kahn, "Corner cube retroreflectors based on structure assisted assembly for free space optical communication," *Journal of Microelectromechanical Systems*, vol. 12(3), Jun. 2003.
- [14] P. Djahani and J. M. Kahn, "Analysis of infrared wireless links employing multibeam transmitters and imaging diversity receivers," *IEEE Transactions on Communications*, vol. 48 (12), pp. 2077-2088, Dec. 2000. DOI: <http://doi.org/10.1109/26.891218>.
- [15] W. Fuertes, F. Rodas, and D. Toscano, "Evaluación de ataques UDP Flood utilizando escenarios virtuales como plataforma experimental," *Facultad de Ingeniería*, vol. 20(31), pp. 37-53, 2012.