

Analysis on Resonator Coupling and its application to CMOS Quadrature VCO at 8 GHz

Donghyun Baek, Taeksang Song, Sangsoo Ko, Euisik Yoon, and Songcheol Hong

Dept. EECS, Korea Advanced Institute of Science and Technology (KAIST) 373-1, Guseong-dong, Yuseong-gu, Daejeon, 305-701, Republic of Korea

Abstract — A low phase noise CMOS quadrature VCO is presented. A transformer resonator coupling is analyzed. It is founded that the coupled resonator has high frequency selectivity. The Q factor of a coupled resonator is $(1+k)$ times higher than a single LC resonator. This enhancement leads to low phase noise and low power consumption of a VCO. The VCO is implemented using 0.18 μm CMOS technology. Two VCOs are linked to generate I-Q signals by the direct current modulation method. The VCO shows low phase noise performances of -110 and -117 dBc/Hz at the offset frequencies of 600 kHz and 1 MHz respectively. The oscillation frequency is 8 GHz. The tuning range of 250 MHz is achieved with the control voltage from 0 to 1 V. The VCO draws 8 mA in core circuits with 3 V supply.

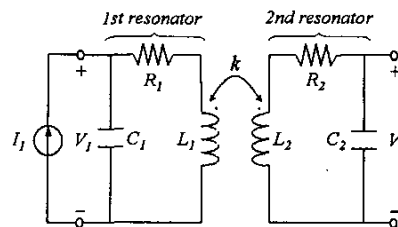

Fig. 1. Transformer coupled resonator.

I. INTRODUCTION

The fully integrated CMOS have been attracted a great deal of attention due to their low cost and integrability with other analog and logic circuits in a single chip. The main obstacle of a CMOS VCO is low quality factor of integrated inductors owing to high loss of Si substrate. It is recent years that a higher-order resonator can increase the frequency selectivity of a band-pass filter. It is very useful to improve poor phase noise of a CMOS VCO. A transformer-coupled resonator is second-order band-pass filter, hence its quality factor is higher than a conventional single LC resonator [1-3]. The VCOs using coupled resonators have shown lower phase noise characteristics than that employing a single LC tank [4, 5]. However no one gives full analyses of this coupled resonator.

In this paper, a quadrature VCO using drain to gate feedback through a transformer-coupled resonator is presented. And the analysis of the quality factor enhancement in a transformer-coupled resonator is given. The VCO employing this concept shows low phase noise performance at 8 GHz as compared to previously reported VCOs [7, 8].

II. RESONATOR COUPLING

A. Transformer coupled resonator.

Fig. 1 shows a transformer-coupled resonator, which is a second-order band-pass filter. It consists of two LC resonators, where two resonators are coupled each other by the mutual inductance (M) of the transformer. For simplicity, capacitors are modeled as ideal components and inductors are expressed as inductors with series-connected resistors.

The frequency selectivity can be derived from the transimpedance (V_2/I_1) or impedance (V_1/I_1) of a resonator. It determines the phase noise shaping of a VCO. These are expressed by two port network equations as

$$Z_{21}(s) = \frac{sM}{(s^2L_1C_1 + sR_1C_1 + 1)(s^2L_2C_2 + sR_2C_2 + 1) - k^2s^4C_1C_2L_1L_2}$$

$$Z_{11}(s) = \frac{(sL_1 + R_1)(1 + sR_2C_2) + sC_2(s^2(L_1L_2 - M^2) + sR_1L_2)}{(s^2L_1C_1 + sR_1C_1 + 1)(s^2L_2C_2 + sR_2C_2 + 1) - k^2s^4C_1C_2L_1L_2} \quad (1)$$

When two LC resonators are coupled, its impedance characteristics (Z_{21} , Z_{11}) show interesting behaviors. The transformer-coupled resonator has superior resonance mode at low frequency and inferior resonance mode at high frequency. When mutual inductance ($M = k\sqrt{L_1L_2}$) is small, two mode peaks appears clearly. As the value of k increase, the superior resonance mode is shifted to lower frequency and shows sharper frequency selectivity, at the

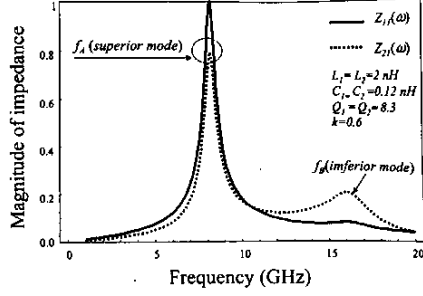

Fig. 2. Normalized magnitude plot of $Z_{11}(\omega)$ and $Z_{22}(\omega)$ of a transformer-coupled resonator.

same time, the inferior resonance mode is shifted to higher frequency as shown Fig. 2.

B. Analysis of a coupled resonant

When resonance frequencies ω_b and quality factors Q_0 in first and second resonators are the same, the transimpedance is expressed by

$$Z_{11}(s) = \frac{skL_0}{\{(1+k)L_0C_0s^2 + sR_0C_0s + 1\}\{(1-k)L_0C_0s^2 + sR_0C_0s + 1\}} \quad (2)$$

where $L_0 = L_1 = L_2$, $R_0 = R_1 = R_2$, $C_0 = C_1 = C_2$. It can be thought as two series-connected resonators. The oscillation frequencies and the quality factors can be extracted by setting the denominator to zero. There are two resonant frequencies ω_A and ω_B in the coupled resonator. Each frequency is as follow;

$$\{\omega_A, \omega_B\} = \left\{ \frac{\omega_0}{\sqrt{1+k}}, \frac{\omega_0}{\sqrt{1-k}} \right\} \quad 0 \leq k \leq 1 \quad (3)$$

where $\omega_0 = 1/\sqrt{L_0C_0}$, ω_A and ω_B represent superior mode and inferior mode. As the value of k increase, the superior mode is shifted to lower frequency, while the inferior mode moves to higher frequency and its amplitude drastically decreases. And the quality factors of a transformer-coupled resonator are given by

$$\{Q_A, Q_B\} = \{\sqrt{1+k} \cdot Q_0, \sqrt{1-k} \cdot Q_0\} \quad 0 \leq k \leq 1 \quad (4)$$

The quality factor of the superior is enhanced $\sqrt{1+k}$ times than that of original resonance mode Q_0 . When it is compared to a single LC resonator, since the quality factor Q_S at the same resonant frequency ω_A , is higher by the factor of $\sqrt{1+k}$ than Q_0 at the resonance frequency ω_A . Hence, the quality factor enhancement of a transformer-coupled resonator is obtained as

$$\frac{Q_A}{Q_S} = (1+k) \quad (5)$$

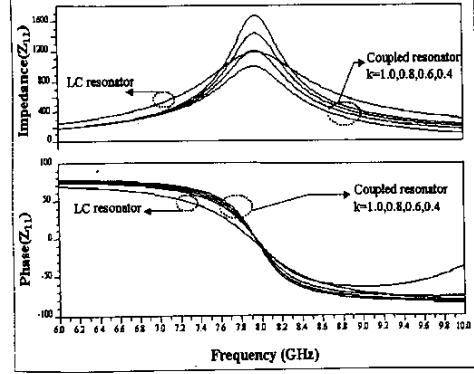

Fig. 3. Impedance and Phase comparisons of Coupled resonator as a function of k factor and a single LC resonator.

This is clear in the graphs that plot amplitudes and phases of the trans-impedance (Z_{11}) of a coupled resonator and the impedance of a single LC resonator as a function of k factor in Fig. 3. The quality factor can be obtained the following relation.

$$Q = \frac{\omega}{2} \left| \frac{\delta\phi}{\delta\omega} \right| \quad (6)$$

Theoretically, when $k = 1$, Q factor increases 2 times than that of a single LC resonator, this means about 6 dB phase noise improvement considering Lesson's phase noise formula [6]. Furthermore, if k is large than 0.5, since tank impedance is larger than a single LC resonator low current is needed to obtain same tank voltage.

C. Transformer design.

Since high coupling coefficient k of a transformer is important in improving the quality factor of a coupled resonator. The metal spacing S between two inductor windings in a transformer is designed to be the minimum width, $1.5 \mu\text{m}$ allowed in the process. The transformer with center taps as shown in Fig 4(a) is symmetric structure, which is adequate for differential circuits such as differential VCOs as the center points can be grounded or connected to bias voltage without disturbing differential signals. We designed our octagonal-shape transformer with $15\text{-}\mu\text{m}$ wide top metal on Si substrate as shown Fig 4(b). The transformer is modeled with 6 ports including two bias feeding ports ($P5$, $P6$). The inductances of L_{11} and L_{21} are 0.66 nH and L_{31} and L_{41} , 0.56 nH respectively. The coupling coefficient of k_{13} is 0.7 . When the transformer model is converted to the two-port

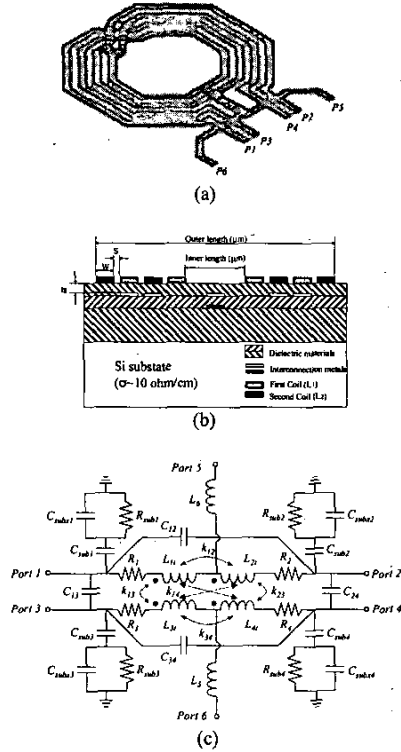

Fig. 4. (a) Octagonal-transformer (b) cross sectional view of a transformer in Si substrate (c) transformer model.

model as show Fig 1, L_1 and L_2 are 2 and 1.6 nH respectively. And the k factor is 0.7.

III. LOW PHASE NOISE VCO DESIGN

Fig 5 shows the circuit schematic of a quadrature CMOS VCO using a transformer-coupled resonator. The coupled resonator is composed of L_1 and C_1 in the primary winding and L_2 and C_2 in the secondary winding. The tank voltages in drains are coupled to gates by mutual inductance. As expected from above analysis, the VCO using a coupled resonator has lower phase noise and lower power consumption than a conventional VCO using a single LC resonator. For frequency tuning, accumulation-mode varactors are used.

To make VCO satisfy the Barkhausen criterion for oscillation, the secondary windings are cross-connected with gates. The drain and gate biases are separately

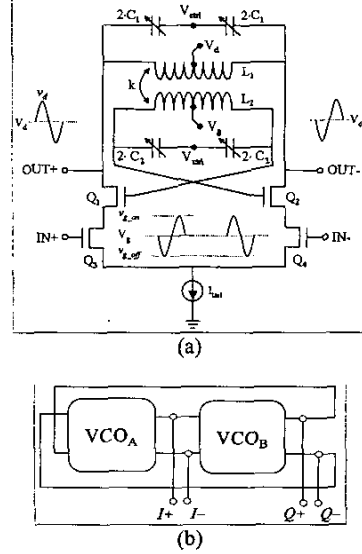

Fig. 5. (a) Schematic circuits of a VCO using resonator coupling. (b) VCO connections for quadrature signals.

controlled and optimized for low phase noise. The quadrature signals are generated by the direct current modulation of negative resistance core circuits that consist of Q_1 and Q_2 . Fig 5(b) shows the connections of two VCOs. This direct current modulation method has less I-Q phase-mismatch and requires low current than parallel tank-voltage modulation method [8].

IV. EXPERIMENT RESULTS

The VCO is implemented using 0.18 μm CMOS technology, which provides 5 layers of Al metal and 2 μm thick top AlCu metal. The transformer is realized using the top metal layer and 4 and 5 layers for interconnections. Fig 6 shows the micro-photograph of a fabricated VCO. The chip size is 900 \times 750 μm^2 including bonding pads.

The VCO was measured on wafer using GSSG microprobes. The output spectrums and the phase noise were obtained from HP8764E spectrum analyzer. The Fig. 7 shows the measured phase noise plot across the offset frequency range from 100 kHz to 1 MHz at the center frequency of 7.91 GHz. The phase noise performances are -110 and -117 dBc/Hz at 600 kHz and 1 MHz offset, respectively. These values are about 10 dB lower than that

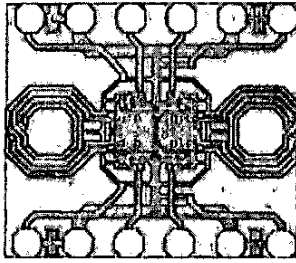

Fig. 6. Microphotograph (chip size is $900 \times 750 \mu\text{m}^2$).

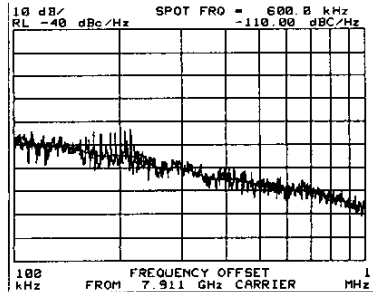

Fig. 7. Phase noise at offset frequencies from 100 kHz to 1 MHz.

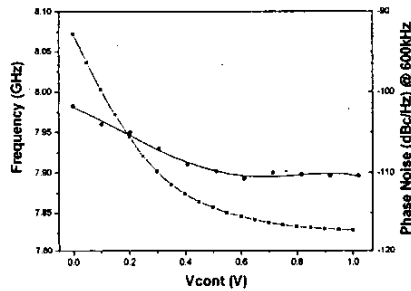

Fig. 8. Frequency characteristics as a function of the varactor control bias from 0 to 1 V

of previous reported quadrature VCOs thanks to the quality factor enhancement [7, 8]. And also, low F.O.M of -181 dBc/Hz is obtained. Fig.8 shows frequency tuning characteristics. The tuning range is 250 MHz and the output power is about -8 dBm from 3-V supply. The value of phase noise varies from -110 to -102 dBc/Hz at the offset frequency of 600 kHz over the tuning ranges. In simulation, the phase error is less than about 0.2 degree, however, to estimate the phase error, the direct

measurement is performed, but unfortunately, it is not reliable due to its high frequency. The amplitude mismatch is less than 0.1 dB within the measurement error.

V. CONCLUSION

We presented a fully integrated quadrature VCO at 8 GHz. And an analysis of a coupled resonator is given. This coupled resonator can compensate low Q factor of an inductor integrated on high-loss Si substrate and improve phase noise performance of a Si VCO. The VCO is implemented using $0.18 \mu\text{m}$ CMOS technology, which employs new transformer drain to gate feedback configuration. To generate I-Q signal, the direct current modulation method is used. The oscillation frequency is 8 GHz with 250 MHz tuning range. The VCO shows low phase noise of -110 and -117 dBc/Hz at 600 kHz and 1 MHz offset respectively and also has low F.O.M of -181 dBc.

ACKNOWLEDGEMENT

This work was supported by KOSEF under the ERC program through the MINT research center at Dongguk University.

REFERENCES

- [1] M. Stmayer, J. Cabanillas, and G. M. Rebeiz, "A low-noise transformer-based 1.7GHz CMOS VCO," *IEEE Solid-State Circuits Conf.*, vol. 2, pp. 224-484, 2002.
- [2] D. Ham, and A. Hajimiri, "Concepts and Methods in Optimization of Integrated LC VCOs," *IEEE Solid-State Circuits.*, vol. 36, pp 896-909,2001.
- [3] D. A. Hitko, and C. G. Sodini, "Adaptive biasing of a 5.8 GHz CMOS oscillator," *IEEE Solid-State Circuits Conf.*, vol. 2, pp. 230-231,2002.
- [4] H. Jacobsson, B. Hansson, H. Berg, and S. Gevorgian, "Very low phase-noise fully-integrated coupled VCOs," *IEEE RFIC Symp.*, pp. 467-470, 2002.
- [5] J. Cabanillas, L. Dussopt, J. M. Lopez-Villegas, and G. M. Rebeiz, "A 900 MHz low phase noise CMOS quadrature oscillator," *IEEE RFIC Symp.*, pp. 63-66, 2002.
- [6] D. B. Lesson, "A simple model of feedback oscillator noise spectrum," in *Proc. IEEE*, pp 329-330, Feb 1996
- [7] J. Tang, P. Ven, D. Kasperkoviz, and A Roermund, "Analysis and Design of an optimally coupled 5-GHz quadrature LC oscillator," *IEEE J. Solid-State Circuits.*, vol 37, No 5, pp 657-661, May 2002.
- [8] H. C. Shin, Z. Xu, and M. F. Chang, "A 1.8-V 6/9-GHz Switchable Dual-Band Quadrature LC VCO in SiGe BiCMOS Technology," *IEEE RFIC Symp.*, pp 71-74, 2002.