

ANALYTIC BOUND STATE SOLUTIONS IN A RELATIVISTIC TWO BODY  
 FORMALISM WITH APPLICATIONS IN MUONIUM AND POSITRONIUM

G. Peter Lepage

Stanford Linear Accelerator Center  
 Stanford University, Stanford, California 94305

ERRATUM

The total contribution from diagram (b) in Fig. 4 should read

$$\left(-1 - \frac{m_e}{m_\mu}\right) \alpha^2 \frac{m_e m_\mu}{(m_e + m_\mu)^2} \log \alpha^{-1} E_F$$

As a consequence the  $\alpha^2 \log \alpha E_F$  contributions are

$$\Delta E = 2 \alpha^2 \frac{m_e m_\mu}{(m_e + m_\mu)^2} \log \alpha^{-1} E_F(\mu e) = 0.0112 \text{ MHz} \quad \text{for muonium}$$

$$\Delta E = -\frac{1}{24} \alpha^2 \log \alpha^{-1} E_F(ee) = -0.0038 \text{ GHz} \quad \text{for positronium .}$$

and the total theoretical predictions for ground state splittings are:

$$\Delta E = 4463.304 (10) \text{ MHz} \quad \text{for muonium}$$

$$\Delta E = 203.3774 (100) \text{ MHz} \quad \text{for positronium .}$$

ANALYTIC BOUND STATE SOLUTIONS IN A RELATIVISTIC TWO BODY  
FORMALISM WITH APPLICATIONS IN MUONIUM AND POSITRONIUM\*

G. Peter Lepage

Stanford Linear Accelerator Center  
Stanford University, Stanford, California 94305

ABSTRACT

We advocate the use in atomic physics of a new relativistic two-body formalism equal in rigor to the Bethe-Salpeter formalism and clearly superior to it in several respects. Outstanding among these is the existence of a Coulomb-like kernel for which the exact analytic solutions of the bound state equations are known. These solutions are derived and applied in a calculation of the  $\mathcal{O}(\alpha^6 m \log \alpha^{-1})$  contributions to hfs in muonium and positronium. Three previously unknown contributions are found. Theory and experiment are compared.

(Submitted to Phys. Rev. A.)

---

\*Work supported by the Energy Research and Development Administration.

## I. INTRODUCTION

In this paper we treat the bound states of spinor QED using a new two-body bound state formalism. The general framework is based upon a bound state equation for the Bethe-Salpeter (BS) amplitude with one particle on mass shell which originated with Gross<sup>1</sup> and has subsequently been discussed by several authors.<sup>2-5</sup> Though similar in spirit to quasi-potential methods,<sup>6</sup> this treatment is equal in rigor to that of Bethe and Salpeter. Furthermore, it is clearly superior to the BS formalism in several respects:

- a. The bound state equation in the Coulomb ladder approximation reduces to the Dirac-Coulomb equation when the mass of the particle held on mass shell is taken to infinity. This is very important as the Dirac equation is the exact bound state equation in this limit. As is well known, the BS equation reduces to the Dirac equation in the limit of infinite mass only when all cross ladders of all orders are included in the kernel.
- b. The bound state equation is essentially a single particle equation, the dynamics of the second particle being greatly simplified by keeping it effectively on mass-shell.
- c. In this paper we show that the bound state equation can be rewritten as a Dirac equation for a single effective particle not only in the infinite mass limit but for arbitrary constituent masses. One of the most important advantages of this approach is that there exists a Coulomb-like kernel for which an exact analytic solution is known. Clearly it is most desirable that an exactly soluble 0<sup>th</sup> order problem exists when computing corrections to energy levels or decay rates in high orders of perturbation theory. No similar solution exists for the BS equation, and in the past the unperturbed BS wave function has been found by iterating the equation. This latter procedure

is fraught with peril as will be well illustrated below [see also Ref. 9].

The method of solution used here was suggested by the work of Grotch and Yennie on an approximate version of this equation.

- d. Given the equivalence of this equation in the Coulomb ladder approximation to the single particle Dirac-Coulomb problem, the scattering amplitudes generated in this formalism (in the ladder approximation) eikonalize, reproducing the results of Ref. 7. This suggests that this approach might have some applications in the analysis of high energy diffractive scattering in field theory. These applications will not be pursued in the present paper.

This equation is most conveniently applied when one of the two constituents in a bound state stays very near mass shell - i.e., either when one mass is much greater than the other or when the binding is weak. However, we emphasize again that the formalism involves no approximation and so may be employed wherever the BS formalism is applicable.

To illustrate the use of this equation we compute the  $\alpha^6 m \log \alpha^{-1}$  contributions to the hyperfine splitting (hfs) in muonium ( $\mu^+ e^-$ ) and positronium ( $e^+ e^-$ ). This work is the first practical application of such a single-particle formalism in QED. Most of the results of Refs. 8-10 are reproduced. In addition we find three contributions not previously known. The asymmetric treatment of the constituents posed no problem in extending the results to positronium. Indeed the requirement of symmetry under exchange of constituent masses of the energy levels served as a useful check on the results.

In Section II we briefly derive the equation and orthonormality relations for the wave functions. The derivation given there is equivalent to that of Refs. 1, 3-4 but is more convenient for our purposes. In Section III we derive perturbation theory. These first two sections serve primarily to establish notation. In

Section IV we transform the bound state equation into a simple single-particle Dirac equation and obtain an analytic solution for particles of arbitrary mass interacting via a Coulomb-like potential. Finally in Section V we apply the formalism in computing the  $\alpha^6 \log \alpha^{-1}$  hfs contributions in muonium and positronium.

## II. THE BOUND STATE EQUATION

To arrive at a new formulation of the two-body bound state problem, we consider a Dyson equation for the two-particle Green's function with one particle ( $m_1$ ) on mass shell (Fig. 1):

$$\begin{aligned} \bar{G}(\vec{k} \vec{\ell} P) &= \frac{(k+m_1)^{(1)}}{(\not{P}-\not{k}-m_2)^{(2)}} \left\{ 2E_k (2\pi)^3 \delta^3(\vec{k}-\vec{\ell}) + \int \frac{d^3q}{(2\pi)^3} \frac{i\bar{K}(\vec{k} \vec{q} P)}{2E_q} \bar{G}(\vec{q} \vec{\ell} P) \right\} \quad (1) \\ &\equiv \frac{(k+m_1)^{(1)}}{(\not{P}-\not{k}-m_2)^{(2)}} \left\{ 2E_k (2\pi)^3 \delta^3(\vec{k}-\vec{\ell}) + \bar{G}_T(\vec{k} \vec{\ell} P) \frac{(\ell+m_1)^{(1)}}{(\not{P}-\not{\ell}-m_2)^{(2)}} \right\} \\ k^0 &= E_k \equiv \sqrt{\vec{k}^2 + m_1^2} \\ \ell^0 &= E_\ell \equiv \sqrt{\vec{\ell}^2 + m_1^2} \end{aligned}$$

where  $\bar{G}_T$  is the Green's function without external fermion legs. We define  $\bar{K}$  such that

$$\bar{G}_T(\vec{k} \vec{\ell} P) = \lim_{\substack{k^0 \rightarrow E_k \\ \ell^0 \rightarrow E_\ell}} iG(k\ell P) \quad (2)$$

where  $G(k\ell P)$ , the usual two-particle Green's function, satisfies the BS equation:

$$G(k\ell P) = K(k\ell P) + \int \frac{d^4q}{(2\pi)^4} K(kqP) \frac{i}{(\not{P}-\not{q}-m_2)^{(2)}} \frac{i}{(\not{q}-\not{\ell}-m_1)^{(1)}} G(q\ell P) . \quad (3)$$

Kernel  $K(k\ell P)$  is the two-particle irreducible BS kernel. Taking  $\bar{K} =$

$K|_{\substack{k^0=E_k, \ell^0=E_\ell}}$  is incorrect, but rather new terms must be added to account for the various poles and cuts in  $K(k\ell P)$  (Fig. 2):

$$\begin{aligned} \bar{K}(\vec{k} \vec{l} \vec{P}) = & K(klP) \Big|_{k^0=E_k, l^0=E_l} + \int \frac{d^4 q}{(2\pi)^4} K(klP) \frac{i}{(\vec{P}-\vec{q}-m_2)^{(2)}} \left\{ \frac{i}{(\vec{q}-m_1)^{(1)}} \right. \\ & \left. - \frac{2\pi\delta(q^0-E_q)}{2E_q} (\vec{q}+m_1)^{(1)} \right\} K(qlP) \Big|_{k^0=E_k, l^0=E_l} + \dots \end{aligned} \quad (4)$$

Formally this result is derived by solving the equation (which follows directly from (1))<sup>3</sup>

$$\bar{G}_T(\vec{k} \vec{l} \vec{P}) = i\bar{K}(\vec{k} \vec{l} \vec{P}) + \int \frac{d^3 \vec{q}}{(2\pi)^3 2E_q} i\bar{K}(\vec{k} \vec{q} \vec{P}) \frac{(\vec{q}+m_1)^{(1)}}{(\vec{P}-\vec{q}-m_2)^{(2)}} \bar{G}_T(\vec{q} \vec{l} \vec{P})$$

for  $\bar{K}$  where  $\bar{G}_T$  is related to kernel  $K$  by Eqs. (2) and (3). In cases where the binding is weak or where  $m_1 \gg m_2$  the approximation  $\bar{K} = K|_{k^0=E_k, l^0=E_l}$  is quite good and the remaining terms in (4) can be incorporated perturbatively. When the binding is not weak, the full BS kernel  $K$  itself exceeds (4) in complexity and so nothing is lost in using this formalism.

Like  $G(klP)$ ,  $\bar{G}(\vec{k} \vec{l} \vec{P})$  has poles at the  $m_1 m_2$  bound state energies

$$\bar{G}(\vec{k} \vec{l} \vec{P}) \rightarrow \frac{\Psi(\vec{k} \vec{P}_n) \bar{\Psi}(\vec{l} \vec{P}_n)}{P^0 - P_n^0} \quad (5)$$

as  $P^0 \rightarrow P_n^0 = \sqrt{\vec{P}^2 + M_n^2}$ ,  $M_n$  being the mass of the bound state. Substituting (5) into (1) and evaluating as  $P^0 \rightarrow P_n^0$ , we obtain finally the covariant bound state equations (Fig. 3):

$$(\vec{P}_n - \vec{k} - m_2)^{(2)} \Psi(\vec{k} \vec{P}_n) = (\vec{k} + m_1)^{(1)} \int \frac{d^3 \vec{l}}{2E_l (2\pi)^3} i\bar{K}(\vec{k} \vec{l} \vec{P}_n) \Psi(\vec{l} \vec{P}_n) \quad (6a)$$

$$\begin{aligned} (\vec{k} - m_1)^{(1)} \Psi(\vec{k} \vec{P}_n) &= 0 & k^0 &= E_k & (6b) \\ P_n &= (P_n^0, \vec{P}) \end{aligned}$$

Eq. (6a) is an eigenvalue equation for the total energy  $P^0$  of the bound state and for the sixteen component wave function  $\Psi$ . Eq. (6b) follows from (6a) and implies that

$$\Psi(\vec{k} \vec{P}) = \sqrt{E_k + m_1} \begin{bmatrix} \psi(\vec{k} \vec{P}) \\ \frac{\vec{\sigma}_1 \cdot \vec{k}}{E_k + m_1} \psi(\vec{k} \vec{P}) \end{bmatrix}$$

where  $\psi(\vec{k} \vec{P})$  is an eight component wave function having four spinor indices for  $m_2$  and two spin indices for  $m_1$ . In the limit  $m_1 \rightarrow \infty$ ,  $k^0$  becomes  $m_1$  and Eq. (6a) becomes the Dirac equation for particle  $m_2$  moving in an external field, as required (and for QED, one obtains the Dirac-Coulomb equation).

Eq. (5) fixes the normalization of the wave functions. This normalization condition is most simply obtained by rewriting Eq. (1) as follows:

$$\bar{G}(\vec{q} \vec{k} \vec{P})(\vec{P} - \vec{k} - m_2)^{(2)} = 2E_k (2\pi)^3 \delta^3(\vec{k} - \vec{q})(\vec{k} + m_1)^{(1)} + \int \frac{d^3 \ell}{2E_\ell (2\pi)^3} \bar{G}(\vec{q} \vec{\ell} \vec{P}) i\bar{K}(\vec{\ell} \vec{k} \vec{P})(\vec{k} + m_1)^{(1)}$$

If this equation when multiplied on the right by  $\Psi(\vec{k} \vec{P}_n)$  is subtracted from Eq. (6a) multiplied by  $\bar{G}(\vec{q} \vec{k} \vec{P})$  on the left, and the result integrated over all  $\vec{k}$  phase space, the following result emerges:

$$\int \frac{d^3 k}{2E_k (2\pi)^3} \frac{d^3 \ell}{2E_\ell (2\pi)^3} \bar{G}(\vec{q} \vec{k} \vec{P}) \mathcal{W}(\vec{k} \vec{\ell} \vec{P} \vec{P}_n) \Psi(\vec{\ell} \vec{P}_n) = \frac{\Psi(\vec{q} \vec{P}_n)}{P^0 - P_n^0} \quad (8)$$

$$P = (P^0, \vec{P})$$

$$P_n = (P_n^0, \vec{P})$$

where

$$\mathcal{W}(\vec{k} \vec{\ell} \vec{P} \vec{P}_n) \equiv \frac{\gamma_0^{(2)}}{2m_1} (2E_\ell (2\pi)^3 \delta^3(\vec{k} - \vec{\ell})) - \frac{i\bar{K}(\vec{k} \vec{\ell} \vec{P}) - i\bar{K}(\vec{k} \vec{\ell} \vec{P}_n)}{P^0 - P_n^0} \quad (9)$$



In the limit  $P^0 \rightarrow P_n^0$ ,  $\bar{G}$  is specified by (5) and, equating the residues of the poles on each side of (8), we obtain the normalization condition:

$$\int \frac{d^3k d^3l}{4E_k E_l (2\pi)^6} \bar{\Psi}(\vec{k} P_n) \left[ \frac{\gamma_0^{(2)}}{2m_1} 2E_l (2\pi)^3 \delta^3(\vec{k}-\vec{l}) - \frac{\partial}{\partial P^0} i\bar{K}(\vec{k} \vec{l} P) \right]_{P^0=P_n^0} \Psi(\vec{l} P_n) = 1. \quad (10)$$

We obtain an orthogonality relation by taking the limit  $P^0 \rightarrow P_m^0$  for  $m \neq n$  corresponding to a different eigenstate of (6a):

$$\int \frac{d^3k d^3l}{4E_k E_l (2\pi)^6} \bar{\Psi}(\vec{k} P_m) \mathcal{W}(\vec{k} \vec{l} P_m P_n) \Psi(\vec{l} P_n) = 0, \quad m \neq n.$$

### III. PERTURBATION THEORY

The stationary perturbation theory usually applied to the Schroedinger equation is easily adapted to this problem. The derivation will be sketched only briefly here; the reader is referred to Ref. 11 for further detail. For simplicity we work in the rest frame of the bound state ( $\vec{P}=0$ ). Furthermore all integrations over constituent momenta will be implicit; only the total energy ( $E$ ) carried by a given function will be exhibited. Assume that  $\Psi_j^0$  are the eigenfunctions with total energy  $E_j^0$  of Eq. (6a) with kernel  $\bar{K}_0(E)$ , and let  $\bar{G}_0(E)$  be the corresponding two-particle Green's function. Again for simplicity, we assume that the levels  $E_j^0$  are nondegenerate. If  $\bar{G}(E)$  is the Green's function for the kernel  $\bar{K}(E) = \bar{K}_0(E) + \delta\bar{K}(E)$ , then

$$\bar{G}(E) = \bar{G}_0(E) + \bar{G}_0(E)i\delta\bar{K}(E)\bar{G}(E) = \sum_{n=0}^{\infty} (\bar{G}_0(E)i\delta\bar{K}(E))^n \bar{G}_0(E) \quad (11)$$

and  $\bar{G}(E)$  has poles at the perturbed bound state energies  $E_j$ :

$$\bar{G}(E) \rightarrow \frac{\Psi_j \bar{\Psi}_j}{E - E_j} \quad \text{as } E \rightarrow E_j \quad .$$

We define an integration contour  $\Gamma_j$  in  $E$  space encircling  $E_j, E_j^0$  and no other poles of  $\bar{G}$ ,  $\bar{G}_0$ , or  $\bar{K}$ . Cauchy's theorem implies:

$$E_j [\bar{\Psi}_j^0 \mathcal{W}(E_j^0 E_j) \Psi_j] [\bar{\Psi}_j \mathcal{W}(E_j E_j^0) \Psi_j^0] = \oint_{\Gamma_j} \frac{E dE}{2\pi i} \bar{\Psi}_j^0 \mathcal{W}(E_j^0 E) \bar{G}(E) \mathcal{W}(E E_j^0) \Psi_j^0$$

$$[\bar{\Psi}_j^0 \mathcal{W}(E_j^0 E_j) \Psi_j] [\bar{\Psi}_j \mathcal{W}(E_j E_j^0) \Psi_j^0] = \oint_{\Gamma_j} \frac{dE}{2\pi i} \bar{\Psi}_j^0 \mathcal{W}(E_j^0 E) \bar{G}(E) \mathcal{W}(E E_j^0) \Psi_j^0 .$$

The contour integrations can be expressed in terms of known quantities by using Eq. (11) to remove  $\bar{G}(E)$  in favor of  $\delta\bar{K}(E)$  and  $\bar{G}_0(E)$ . The result is a

perturbative expansion for  $E_j$  in powers of  $\delta\bar{K}$  (using Eq. (8)):

$$E_j = E_j^0 + \frac{\oint_{\Gamma_j} \frac{dE}{2\pi i} \left( \frac{1}{E-E_j^0} \right) \bar{\Psi}_j^0 i\delta\bar{K}(E) \sum_{n=0}^{\infty} (\bar{G}_0(E) i\delta\bar{K}(E))^n \Psi_j^0}{1 + \oint_{\Gamma_j} \frac{dE}{2\pi i} \left( \frac{1}{E-E_j^0} \right)^2 \bar{\Psi}_j^0 i\delta\bar{K}(E) \sum_{n=0}^{\infty} (\bar{G}_0(E) i\delta\bar{K}(E))^n \Psi_j^0} .$$

The contour integrations in each term of the expansion can be performed as the only poles implicit in the integrand occur in  $\bar{G}_0(E)$  at  $E=E_j^0$  and have well-defined residues (using (5)). Carrying out these integrations we obtain the familiar perturbation series:

$$E_j = E_j^0 + (\bar{\Psi}_j^0 i\delta\bar{K} \Psi_j^0) \left[ 1 + (\bar{\Psi}_j^0 \frac{\partial}{\partial E} i\delta\bar{K} \Psi_j^0) \right]_{E=E_j^0} + (\bar{\Psi}_j^0 i\delta\bar{K} \left\{ \bar{G}_0 - \frac{\Psi_j^0 \bar{\Psi}_j^0}{E-E_j^0} \right\} i\delta\bar{K} \Psi_j^0)_{E=E_j^0} + \mathcal{O}(\delta\bar{K}^3) . \quad (12)$$

Similar arguments give the perturbed wave functions:

$$\Psi_j \propto \Psi_j^0 + \oint_{\Gamma_j} \frac{dE}{2\pi i} \sum_{n=1}^{\infty} (\bar{G}_0(E) i\delta\bar{K}(E))^n \frac{\Psi_j^0}{E-E_j^0} \propto \Psi_j^0 \left( 1 + \bar{\Psi}_j^0 \frac{\partial}{\partial E} i\delta\bar{K} \Psi_j^0 \right) + \left\{ \bar{G}_0 - \frac{\Psi_j^0 \bar{\Psi}_j^0}{E-E_j^0} \right\} i\delta\bar{K} \Psi_j^0 \Big|_{E=E_j^0} + \mathcal{O}(\delta\bar{K}^2) . \quad (13)$$

The perturbed wave functions are used primarily in computing decay rates, scattering amplitudes, and the like. They will not be needed in this paper.

#### IV. EFFECTIVE DIRAC EQUATION AND AN EXACT SOLUTION

Eq. (6a) is greatly complicated in coordinate space by the term on the left-hand side containing  $k^0 = \sqrt{\vec{k}^2 + m_1^2}$ . Grotch and Yennie,<sup>2</sup> in their treatment of a related quasi-potential equation, expanded  $k^0$  to first order in  $\vec{k}^2/m_1^2$  but this procedure is approximate and leads to divergences in high order terms that can be ignored only when  $m_1 \gg m_2$ .

To remove  $k^0$  from the left-hand side, we first rewrite (6a) as an equation for  $\psi(\vec{k} \mathbf{P})$ , the eight component spinor:

$$(\not{P} - \not{k} - m_2)\psi(\vec{k} \mathbf{P}) = \int \frac{d^3 \ell}{(2\pi)^3 2E_\ell} i\tilde{K}(\vec{k} \ell \mathbf{P})\psi(\vec{\ell} \mathbf{P}), \quad (14)$$

where  $\tilde{K}$  is defined such that

$$\bar{u}^{(1)}(\vec{k} \lambda') \bar{K}(\vec{k} \ell \mathbf{P}) u^{(1)}(\vec{\ell} \lambda) = \chi_{\lambda'}^{(1)\dagger} \tilde{K}(\vec{k} \ell \mathbf{P}) \chi_\lambda^{(1)}, \quad (15)$$

$\chi_\lambda$  being a two component spin wave function for particle 1. We note in passing that all of the formalism described in the previous two sections could easily have been developed in terms of  $\psi$ ,  $\tilde{K}$ , and  $\tilde{G}$  (defined analogously to  $\tilde{K}$ ) rather than  $\Psi$ ,  $\bar{K}$ , and  $\bar{G}$ . Working in the center of momentum frame ( $\vec{P} = 0$ ), we multiply both sides of (14) by  $\gamma^0(\not{P} + \not{k} - m_2)/4P^0 E_k$  to obtain:

$$\left[ \left( \frac{P_0^2 + m_2^2 - m_1^2}{2P_0} \right) \gamma^0 + \vec{\gamma} \cdot \vec{k} - m_2 \right] \frac{\psi(\vec{k} \mathbf{P})}{2E_k} = \frac{\gamma^0(\not{P} + \not{k} - m_2)}{4P_0 E_k} \int \frac{d^3 \ell}{(2\pi)^3} i\tilde{K}(\vec{k} \ell \mathbf{P}) \frac{\psi(\vec{\ell} \mathbf{P})}{2E_\ell}. \quad (16)$$

This is an effective Dirac equation for a particle of mass  $m_2$ , momentum  $-\vec{k}$ , and "energy"

$$\tilde{E} = \frac{P_0^2 + m_2^2 - m_1^2}{2P_0} = m_2 - \epsilon \frac{m_1}{P_0} + \frac{\epsilon^2}{2P_0} \rightarrow m_2 - \epsilon \text{ as } m_1 \rightarrow \infty,$$

where  $\epsilon$  is the binding energy ( $P^0 = m_1 + m_2 - \epsilon$ ). We emphasize that Eq. (16) is exact.

When seeking analytic solutions describing bound states in QED (muonium, positronium, etc.), the physics requires that (16) reduce to the Schroedinger equation with reduced mass in the nonrelativistic regime, and to the Dirac-Coulomb equation when  $m_1 \rightarrow \infty$ . This is accomplished if we take as our unperturbed kernel

$$i\tilde{K}_0(\vec{k}, \vec{\ell}; P) = \frac{4m_1 E_k}{P^0 + k^0 - m_2} \frac{-Ze^2}{|\vec{k} - \vec{\ell}|^2} \quad (17)$$

because then Eq. (16) becomes

$$(\tilde{E}\gamma^0 + \vec{k} \cdot \vec{\gamma} - m_2) \frac{\psi(\vec{k}; P)}{2E_k} = -Ze^2 \frac{m_1}{P^0} \int \frac{d^3\ell}{(2\pi)^3} \frac{\gamma_0}{|\vec{k} - \vec{\ell}|^2} \frac{\psi(\vec{\ell}; P)}{2E_\ell}.$$

The solutions of this equation are the familiar Dirac-Coulomb wave function  $\phi_{n'j}(-\vec{k})$  ( $N$  is a normalization constant):

$$\begin{aligned} \psi(\vec{k}; P) &= \frac{2E_k N}{\sqrt{2m_1}} \phi_{n'j}^{(2)}(-\vec{k}) \chi_\lambda^{(1)} \\ \Rightarrow \Psi(\vec{k}; P) &= \frac{2E_k N}{\sqrt{2m_1}} \phi_{n'j}^{(2)}(-\vec{k}) u^{(1)}(\vec{k}; \lambda) \end{aligned} \quad (18)$$

but with an effective fine structure constant:

$$\begin{aligned} Z\alpha \rightarrow Z\alpha' &\equiv Z\alpha \frac{m_1}{P^0} = Z\alpha \frac{m_1}{m_1 + m_2} + \mathcal{O}\left((Z\alpha)^3 \frac{m_2}{m_1}\right) \\ Z\alpha m_2 \rightarrow \gamma &\equiv Z\alpha' m_2 = Z\alpha \frac{m_1 m_2}{m_1 + m_2} + \mathcal{O}\left((Z\alpha)^2 \frac{m_2}{m_1} \gamma\right). \end{aligned}$$

The scale of nonrelativistic momenta in the wave functions is set by  $\gamma$ , which correctly incorporates the reduced mass of the system. The total energy of the bound states is obtained by solving the following equation for  $P^0$ :

$$\tilde{E} = \frac{P_0^2 + m_2^2 - m_1^2}{2P_0} = \frac{m_2}{\left\{ 1 + \frac{(Z\alpha')^2}{\left[ \sqrt{(j+\frac{1}{2})^2 - (Z\alpha')^2 + n'} \right]^2} \right\}^{\frac{1}{2}}} \quad \begin{array}{l} n'=0, 1, 2, \dots \\ j = \frac{1}{2}, \frac{3}{2}, \dots \end{array} \quad (19)$$

$$\Rightarrow P^0 = m_1 + m_2 - \frac{(Z\alpha)^2}{2n^2} \frac{m_1 m_2}{m_1 + m_2} - (Z\alpha)^4 \frac{m_1 m_2}{m_1 + m_2} \left\{ \frac{1}{2n^3(j+\frac{1}{2})} - \frac{3}{8n^4} \right\} + \mathcal{O}\left( (Z\alpha)^4 \frac{m_2^2}{m_1} \right)$$

$n = n' + j + \frac{1}{2}$

In the Appendix we show how, following Grotch and Yennie, this treatment can be modified when  $m_1 \gg m_2$  to incorporate part of the instantaneous transverse photon interaction (Breit interaction) into  $\tilde{K}_0$ , thereby obtaining the complete fine structure to  $\mathcal{O}\left( (Z\alpha)^4 \frac{m_2^2}{m_1} \right)$ .

We will require the 1s wave function in the next section. In momentum space, the wave function for particle 2 is:

$$\phi_{1s}^{(2)}(-\vec{k}) = \left( \frac{\gamma^3}{\pi} \right)^{\frac{1}{2}} \frac{8\pi}{\gamma^3 (1+k^2/\gamma^2)^{2-\xi/2}}$$

$$\left[ \left[ \cos\left(\xi \tan^{-1} \frac{k}{\gamma}\right) + \frac{k^2 - \gamma^2}{2k\gamma} \sin\left(\xi \tan^{-1} \frac{k}{\gamma}\right) \right] \chi \right.$$

$$\left. \left[ \cos\left(\xi \tan^{-1} \frac{k}{\gamma}\right) \left[ 1 + \xi \frac{\gamma^2 - k^2}{2k^2} \right] - \sin\left(\xi \tan^{-1} \frac{k}{\gamma}\right) \left[ \frac{3k^2 \gamma + \gamma^3 - 2\xi k^2 \gamma}{2k^3} \right] \right] \left( \frac{-\xi}{Z\alpha' \gamma (1-\xi)} \right)^{\vec{\sigma} \cdot \vec{k}} \chi \right]$$

$$\xi = 1 - \sqrt{1 - (Z\alpha')^2} \approx \frac{(Z\alpha')^2}{2} \quad k = |\vec{k}|$$

where  $\chi$  is the spin wave function for particle 2. It is convenient to expand  $\phi^{(2)}$  in powers of  $\xi$  as only the lowest and first order terms are required in the next section:

$$\begin{aligned}
 \phi_{1s}^{(2)}(-\vec{k}) &= \phi_0^{(2)}(-\vec{k}) + \delta\phi^{(2)}(-\vec{k}) \\
 \phi_0^{(2)}(-\vec{k}) &= \left(\frac{\gamma^3}{\pi}\right)^{\frac{1}{2}} \frac{8\pi\gamma}{(k^2+\gamma^2)^2} \left[ \frac{\chi}{2m_2} \right] \\
 \delta\phi^{(2)}(-\vec{k}) &= \left(\frac{\gamma^3}{\pi}\right)^{\frac{1}{2}} \frac{8\pi\gamma}{(k^2+\gamma^2)^2} \frac{(Z\alpha')^2}{4} \left[ \begin{aligned} &\left\{ \log\left(\frac{\gamma^2+k^2}{\gamma^2}\right) + \frac{k^2-\gamma^2}{k\gamma} \tan^{-1} \frac{k}{\gamma} \right\} \chi \\ &\left\{ \frac{\gamma^2+2k^2}{k^2} + \log\left(\frac{\gamma^2+k^2}{\gamma^2}\right) - \frac{3k^2\gamma+\gamma^3}{k^3} \tan^{-1} \frac{k}{\gamma} \right\} \frac{-\vec{\sigma}\cdot\vec{k}}{\gamma} \frac{\chi}{2m_2} \end{aligned} \right] \quad (20)
 \end{aligned}$$

As  $\tilde{K}_0(\vec{k} \vec{\ell} P)$  is not symmetric under exchange of  $\vec{k}$  and  $\vec{\ell}$  (i.e., nonhermitean), the adjoint wave function,  $\bar{\psi}(\vec{k} P)$ , is not simply  $\psi^\dagger \gamma^0$ . Rather it is easily shown that

$$\begin{aligned}
 \bar{\psi}(\vec{k} P) &= \psi^\dagger(\vec{k} P) \frac{P+k-m_2}{2E_k} \\
 &= \psi^\dagger(\vec{k} P) \gamma^0 \left\{ 1 + \frac{P-k-m_2}{2E_k} \gamma_0 \right\}
 \end{aligned}$$

Note that the correction to  $\psi^\dagger \gamma^0$  is of relative order  $\alpha^2 m_2/m_1$  when  $k \sim \mathcal{O}(\gamma)$ .

The normalization of this wave function is fixed by Eq. (10) with

$$\frac{\partial}{\partial P^0} i\tilde{K}_0(\vec{k} \vec{\ell} P) = \frac{-Ze^2}{|\vec{k}-\vec{\ell}|^2} 4E_k m_1 \left[ \frac{1}{P+k-m_2} (-\gamma_0) \frac{1}{P+k-m_2} \right] \simeq \frac{Ze^2}{|\vec{k}-\vec{\ell}|^2}$$

Setting  $E_k = m_1 + \vec{k}^2/2m_1$ , the normalization is determined to  $\mathcal{O}(\alpha^2)$  by:

$$\begin{aligned}
 1 &= N^2 \left\{ \int \frac{d^3\vec{k}}{(2\pi)^3} \left[ \bar{\phi}_{1s}^{(2)}(-\vec{k}) \gamma_0^{(2)} \phi_{1s}^{(2)}(-\vec{k}) + \bar{\phi}_0^{(2)}(-\vec{k}) \frac{\vec{k}^2}{2m_1} \phi_0^{(2)}(-\vec{k}) \right] \right. \\
 &\quad + \frac{1}{2m_1} \int \frac{d^3\vec{k}}{(2\pi)^3} \bar{\phi}_0^{(2)}(-\vec{k}) \gamma_0^{(2)} (P-k-m_2) \gamma_0^{(2)} \phi_0^{(2)}(-\vec{k}) \\
 &\quad \left. - \frac{1}{2m_1} \int \frac{d^3\vec{k} d^3\vec{\ell}}{(2\pi)^6} \bar{\phi}_0^{(2)}(-\vec{k}) \frac{Ze^2}{|\vec{k}-\vec{\ell}|^2} \phi_0^{(2)}(-\vec{\ell}) + \mathcal{O}(\alpha^4) \right\}
 \end{aligned}$$

The last two terms are equal to  $\mathcal{O}(\alpha^2)$  by Eq. (14) and thus

$$\begin{aligned} N &= 2^{-\xi} \Gamma(2-\xi) \sqrt{\frac{2-\xi}{\Gamma(3-\xi)}} + \frac{\gamma^2}{2m_1 m_2} \left(1 - \frac{m_2}{2m_1}\right) + \mathcal{O}(\alpha^4) \\ &= 1 + \left(\frac{1}{4} - \log 2\right) \frac{(Z\alpha')^2}{2} + \frac{\gamma^2}{2m_1 m_2} \left(1 - \frac{m_2}{2m_1}\right) + \mathcal{O}(\alpha^4) . \end{aligned}$$



## V. HYPERFINE SPLITTING IN MUONIUM AND POSITRONIUM

We now use this formalism to compute the hyperfine splitting of the 1s level in muonium where it is natural to set  $m_1 = m_\mu$  and  $m_2 = m_e$ .<sup>12</sup> Each term to be computed below is also a part of the positronium hfs and its contribution there is found simply by setting  $m_\mu = m_e$ . In addition there are annihilation kernels contributing to positronium hfs only but these will not be evaluated in this paper.<sup>10</sup>

The dominant contribution to muonium hfs is the Fermi splitting:

$$E_F = \frac{2}{3} \frac{\gamma^3 \alpha}{m_e m_\mu} \langle \sigma_e \cdot \sigma_\mu \rangle$$

$$\Rightarrow \Delta E = \frac{8}{3} \frac{\gamma^3 \alpha}{m_e m_\mu} .$$

All terms of  $\mathcal{O}(\alpha E_F)$ ,  $\mathcal{O}(\alpha^2 E_F)$ , and most radiative corrections of  $\mathcal{O}(\alpha^3 E_F)$  have also been computed and are discussed in the literature.<sup>13</sup> At present many terms of  $\mathcal{O}(\alpha^2 m_e/m_\mu E_F)$  remain uncalculated. In this paper we compute the  $\alpha^2 m_e/m_\mu \ln \alpha^{-1} E_F$  terms coming from single, double, and triple photon ladder kernels. The diagrams considered and their contributions are presented in Fig. 4. Contributions from diagrams (e), (g), and (a) were computed in Refs. 8 and 9 and agree with those computed by the author using the techniques described above. Diagram (f) has been computed for positronium only in Ref. 10. The calculation for constituents of arbitrary mass is described below. Diagrams (b), (c), and (d) were also considered ((b) explicitly, (c) and (d) implicitly) in Ref. 8, but the contributions listed in Figure 4 can only be found with BS techniques if the BS equation is iterated twice to produce a wave function (not just once as was done in Ref.8).<sup>14</sup> Such omissions cannot occur in our treatment as the unperturbed problem has been solved

exactly. The calculations for these diagrams will also be exhibited below.

Note that although contributions from individual kernels may not be symmetric under the interchange of masses  $m_e \leftrightarrow m_\mu$ , the sum of all terms is symmetric as it must be.

For all of these diagrams it is found that  $\log \alpha^{-1}$  terms come only from the region of nonrelativistic momentum in all integrations as only there are the propagators in the kernel sufficiently singular for the binding energy to be of importance. Therefore the general procedure to be adopted is to expand all propagators and energies in powers of  $\vec{k}^2/m^2$  and then to isolate the logarithmically divergent terms as these are the source of  $\log \alpha^{-1}$  contributions.<sup>15</sup> The coefficient of  $\log \alpha^{-1}$  is easily computed using Table I. Of course the divergences are ultimately cut off by the propagators when the momenta become relativistic. The one and two loop graphs contribute to  $\mathcal{O}(\alpha E_F)$  and  $\mathcal{O}(\alpha^2 E_F)$  respectively, this coming when the wave function momentum is nonrelativistic. As  $\delta\phi \sim \mathcal{O}(\alpha^2 \phi_0)$  in this regime and is of  $\mathcal{O}(\alpha \phi_0)$  elsewhere,  $\phi_{1S}^{(2)}$  may be replaced by  $\phi_0^{(2)}$  for all calculations of  $\mathcal{O}(\alpha E_F)$  and  $\mathcal{O}(\alpha^2 E_F)$  modulo  $\log \alpha^{-1}$  contributions from these graphs. In addition  $\bar{\psi} \simeq \psi^\dagger \gamma^0$  can be assumed in computing these contributions.

To verify the analytic results presented in this paper, all graphs (except for (f), which has been evaluated elsewhere) have been computed numerically without approximation. Furthermore the new contributions (b)-(d) have also been computed using a doubly iterated wave function in the Bethe-Salpeter formalism.

Finally we note that all calculations are performed in the Coulomb gauge. As in the BS formalism, the wave functions and kernels here are not gauge invariant, though physically measurable quantities such as energy levels and decay rates must be. The Coulomb gauge seems to be optimal for atomic physics

insofar as it incorporates the most physics in the simplest graphs.<sup>2</sup> Note that, because  $m_1$  propagates on mass shell, this formalism is invariant under the general class of gauge transformations

$$\frac{-g_{\mu\nu}}{k^2} \rightarrow \frac{-\left(g_{\mu\nu} + \xi \frac{\Lambda k_\nu}{\Lambda \cdot k}\right)}{k^2}$$

performed on all photons interacting with  $m_1$  (index  $\nu$ ) and, in particular, on all photons in simple ladder and cross ladder kernels.<sup>16</sup> Unfortunately this class of gauges does not include the Coulomb gauge, though any gauge dependent terms originating with these photon lines must vanish as  $m_1 \rightarrow \infty$  (the Dirac limit).

#### A. Single Transverse Photon Exchange

The kernel describing single transverse photon exchange is (Fig. 4b):<sup>17</sup>

$$i\bar{K}_T(\vec{k}, \vec{l}) = -\frac{e^2}{(k-l)^2} \gamma^i \gamma^j \delta_{ij}^\perp(\vec{k}-\vec{l})$$

$$k^0 = E_k$$

$$l^0 = E_l$$

where

$$\delta_{ij}^\perp(\vec{k}-\vec{l}) \equiv \delta_{ij} - \frac{(\vec{k}-\vec{l})^i (\vec{k}-\vec{l})^j}{|\vec{k}-\vec{l}|^2}.$$

The second term in  $\delta_{ij}^\perp$ , though very important for fine structure, is easily shown to contribute only to  $\mathcal{O}(\alpha^4 E_F)$  in hfs and so will be neglected here.

Noting that

$$\bar{u}(\vec{k}, \lambda') \gamma^i u(\vec{l}, \lambda) = \sqrt{(E_k + m_\mu)(E_l + m_\mu)} \chi_{\lambda'}^\dagger \left[ \frac{\vec{l} + i\vec{l} \times \vec{\sigma}}{E_l + m_\mu} + \frac{\vec{k} - i\vec{k} \times \vec{\sigma}}{E_k + m_\mu} \right]^i \chi_\lambda$$

the contributions of  $i\bar{K}_T$  to hfs from  $\phi_0$  and  $\delta\phi$  respectively are

$$\delta E_T = \delta E_0 + \delta E_1$$

$$\begin{aligned} \delta E_0 &= -\frac{e^2 N^2}{2m_\mu} \int \frac{d^3 \vec{k} d^3 \vec{l}}{(2\pi)^6} \frac{\sqrt{(E_{\vec{k}+m_\mu})(E_{\vec{l}+m_\mu})}}{(k-l)^2} \phi_0^\dagger(-\vec{k}) \left( \frac{\vec{p}+\vec{k}-m_e}{2E_{\vec{k}}} \right) \gamma^i \phi_0(-\vec{l}) \\ &\quad \cdot \chi(\mu)^\dagger \left\{ \frac{i\vec{l} \times \vec{\sigma}}{E_{\vec{l}+m_\mu}} - \frac{i\vec{k} \times \vec{\sigma}}{E_{\vec{k}+m_\mu}} \right\}^i \chi(\mu) \\ &= E_F \frac{N^2 \gamma^2}{\pi^4} \int \frac{d^3 \vec{k} d^3 \vec{l}}{(k^2+\gamma^2)^2 (\ell^2+\gamma^2)^2} \frac{\sqrt{(E_{\vec{k}+m_\mu})(E_{\vec{l}+m_\mu})}}{(E_{\vec{k}}-E_{\vec{l}})^2 - |\vec{l}-\vec{k}|^2} \left\{ \frac{k^2}{4m_e E_{\vec{k}}} \left[ \frac{\vec{l}^2}{E_{\vec{l}+m_\mu}} - \frac{\vec{k} \cdot \vec{l}}{E_{\vec{k}+m_\mu}} \right] \right. \\ &\quad \left. + \left( 1 + \frac{P^0 - E_{\vec{k}} - m_e}{2E_{\vec{k}}} \right) \left[ \frac{\vec{k} \cdot \vec{l} - \vec{l}^2}{E_{\vec{l}+m_\mu}} + \frac{\vec{k} \cdot \vec{l} - \vec{k}^2}{E_{\vec{k}+m_\mu}} \right] \right\} \end{aligned}$$

$$\begin{aligned} \delta E_1 &= -\frac{e^2 N^2}{2m_\mu} \int \frac{d^3 \vec{k} d^3 \vec{l}}{(2\pi)^6} \frac{\sqrt{(E_{\vec{k}+m_\mu})(E_{\vec{l}+m_\mu})}}{(k-l)^2} \chi(\mu)^\dagger \left\{ \frac{i\vec{l} \times \vec{\sigma}}{E_{\vec{l}+m_\mu}} - \frac{i\vec{k} \times \vec{\sigma}}{E_{\vec{k}+m_\mu}} \right\}^i \chi(\mu) \\ &\quad \cdot \left\{ \delta \phi^\dagger(-\vec{k}) \frac{\vec{p}+\vec{k}-m_e}{2E_{\vec{k}}} \gamma^i \phi_0(-\vec{l}) + \phi_0^\dagger(-\vec{k}) \frac{\vec{p}+\vec{k}-m_e}{2E_{\vec{k}}} \gamma^i \delta \phi(-\vec{l}) \right\} \\ &\simeq -E_F \frac{\gamma^2}{m_e m_\mu} \frac{\gamma^2}{4\pi^4} \int^{\sim m} \frac{d^3 \vec{k}}{(k^2+\gamma^2)^2} \frac{d^3 \vec{l}}{(\ell^2+\gamma^2)^2} \left( \frac{k}{\gamma} \tan^{-1} \frac{k}{\gamma} \right) \frac{\vec{k}^2}{|\vec{k}-\vec{l}|^2} \\ &\simeq -\frac{1}{2} E_F \frac{\gamma^2}{m_e m_\mu} \log \alpha^{-1} \end{aligned}$$

As  $\delta E_1$  is of order  $\alpha^2 E_F$ , we have approximated  $E_{\vec{k}}$  and  $E_{\vec{l}}$  by  $m_\mu$ , and have retained only the logarithmically divergent term. To check for such terms in  $\delta E_0$  (which also contains  $E_F$ ), we expand all factors in powers of  $\vec{k}^2/m_\mu^2$  or  $\vec{l}^2/m_\mu^2$ :

$$\delta E_0 \simeq E_F N^2 + E_F \frac{\gamma^2}{\pi^4} \int^{\sim m} \frac{d^3 \vec{k} d^3 \vec{l}}{(k^2+\gamma^2)^2 (\ell^2+\gamma^2)^2} \left\{ -\frac{\vec{k}^2}{4m_\mu^2} + \frac{\vec{k}^2 (\vec{k} \cdot \vec{l} - \vec{l}^2)}{4m_e m_\mu |\vec{l}-\vec{k}|^2} + \frac{\vec{k}^4 + \vec{l}^4 - 2\vec{k} \cdot \vec{l}}{8m_\mu^2 |\vec{l}-\vec{k}|^2} \right\}$$

The  $\vec{k}^{-2}$ ,  $\vec{k}^{-4}$  and  $\vec{\ell}^{-4}$  terms in the integrand result in linear divergences and correspond to an  $\mathcal{O}(\alpha m_e/m_\mu E_F)$  contribution from the relativistic region of phase space. The remaining terms are logarithmically divergent and, using Table I, contribute

$$\delta E_T (\alpha^6 \log \alpha^{-1}) = \left( -\frac{1}{2} - \frac{m_e}{m_\mu} \right) E_F \frac{\gamma^2}{m_e m_\mu} \log \alpha^{-1}$$

The total contribution to the hfs from single transverse photon exchange is found to be

$$\delta E_T = E_F \left[ 1 + \alpha' \frac{m_e}{m_\mu} + \frac{3}{2} \alpha^2 - \left( 1 + \frac{m_e}{m_\mu} \right) \frac{\gamma^2}{m_e m_\mu} \log \alpha^{-1} + \mathcal{O} \left( \alpha^2 \frac{m_e}{m_\mu} \right) \right].$$

The  $\mathcal{O}(\alpha m_e/m_\mu E_F)$  term is completely cancelled by terms from the Coulomb-transverse ladder kernels. The  $\frac{3}{2} \alpha^2 E_F$  is the usual Breit-Dirac wave function correction.

### B. Coulomb-Transverse Photon Ladders

The perturbation due to ladder graphs containing one Coulomb and one transverse photon is (Fig. 4c, 5):<sup>18</sup>

$$\begin{aligned} \delta E_{CT} = & \frac{2\gamma^5 \alpha^2}{\pi^6 m_\mu^2} \int \frac{d^3 k d^3 \ell}{(k^2 + \gamma^2)^2 (\ell^2 + \gamma^2)^2} \frac{1}{2\sqrt{(E_k + m_\mu)(E_\ell + m_\mu)}} \int \frac{d^4 q}{2\pi/i} \frac{\langle \gamma^i (P - q + m_e) \gamma^0 \rangle^{(e)}}{|\vec{\ell} - \vec{q}|^2 (k - q)^2 ((P - q)^2 - m_e^2)} \\ & \cdot \delta_{ij}^{\perp}(\vec{k} - \vec{q}) \left\{ \frac{\langle \gamma^j (q + m_\mu) \gamma^0 \rangle^{(\mu)}}{q^2 - m_\mu^2} + \frac{\langle \gamma^0 (k + \ell - q + m_\mu) \gamma^j \rangle^{(\mu)}}{(k + \ell - q)^2 - m_\mu^2} \right\} \end{aligned} \quad (21)$$

where (keeping only terms relevant to hfs):

$$\langle \gamma^j (q + m_\mu) \gamma^0 \rangle^{(\mu)} \equiv \frac{\bar{u}(\vec{k} \lambda') \gamma^j (q + m_\mu) \gamma^0 u(\vec{\ell} \lambda)}{\sqrt{(E_k + m_\mu)(E_\ell + m_\mu)}} = i \chi_{\lambda'}^\dagger \left\{ \frac{\vec{q} \times \vec{\sigma}_\mu}{q} - \frac{q^0 + m_\mu}{E_k + m_\mu} \frac{\vec{k} \times \vec{\sigma}_\mu}{\mu} + \frac{q^0 - m_\mu}{E_\ell + m_\mu} \frac{\vec{\ell} \times \vec{\sigma}_\mu}{\mu} \right\}^j \chi_\lambda$$

with similar expressions for  $\langle \gamma^i(\mathcal{P}-\mathcal{q}+m_e)\gamma^0 \rangle^{(e)}$  and  $\langle \gamma^0(k+l-\mathcal{q}+m_\mu)\gamma^j \rangle^{(\mu)}$ . For reasons to be discussed below, terms proportional to both  $k$  and  $l$  cannot contribute to  $\mathcal{O}(\alpha^2 m \alpha^{-1} E_F)$  hfs and so have been omitted. Furthermore only the  $\delta_{ij}$  part of  $\delta_{ij}^1$  contributes to this order. Thus the relevant terms in the numerator from each graph (ladder and cross ladder) are:

$$\begin{aligned} \langle \gamma^i(\mathcal{P}-\mathcal{q}+m_e)\gamma^0 \rangle^{(e)} \langle \gamma^i(\mathcal{q}+m_\mu)\gamma^0 \rangle^{(\mu)} &= \frac{\langle \sigma_e \cdot \sigma_\mu \rangle}{3} \left\{ 2\vec{q}^2 - \frac{(P^0 - q^0 + m_e)}{m_e} \vec{k} \cdot \vec{q} \right. \\ &- \frac{q^0 + m_\mu}{E_k + m_\mu} 2\vec{k} \cdot \vec{q} + \frac{(q^0 + m_\mu)(P^0 - q^0 + m_e)}{(E_k + m_\mu)m_e} \vec{k}^2 + \frac{(P^0 - q^0 - m_e)}{m_e} \vec{l} \cdot \vec{q} \\ &\left. + \frac{q^0 - m_\mu}{E_l + m_\mu} 2\vec{l} \cdot \vec{q} + \frac{(q^0 - m_\mu)(P^0 - q^0 - m_e)}{(E_l + m_\mu)m_e} \vec{l}^2 \right\} \end{aligned} \quad (22a)$$

$$\begin{aligned} \langle \gamma^i(\mathcal{P}-\mathcal{q}+m_e)\gamma^0 \rangle^{(e)} \langle \gamma^0(k+l-\mathcal{q}+m_\mu)\gamma^i \rangle^{(\mu)} &= \frac{\langle \sigma_e \cdot \sigma_\mu \rangle}{3} \left\{ 2\vec{q}^2 - \frac{(P^0 - q^0 + m_e)}{m_e} \vec{k} \cdot \vec{q} \right. \\ &- \frac{r^0 + E_k}{E_k + m_\mu} 2\vec{k} \cdot \vec{q} + \frac{(r^0 + E_k)(P^0 - q^0 + m_e)}{(E_k + m_\mu)m_e} \vec{k}^2 + \frac{(P^0 - q^0 - m_e)}{m_e} \vec{l} \cdot \vec{q} \\ &\left. + \frac{(E_k - q^0)}{E_l + m_\mu} 2\vec{l} \cdot \vec{q} + \frac{(E_k - q^0)(P^0 - q^0 - m_e)}{(E_l + m_\mu)m_e} \vec{l}^2 \right\} \end{aligned} \quad (22b)$$

with  $r \equiv k + l - q$ .

The ladder graph contains the iteration of the single transverse photon interaction with  $\tilde{K}_0$ , which must be removed to avoid double counting of its

contribution

$$\delta E_{IT} = \frac{\gamma^5 \alpha^2}{\pi^6 m_\mu^2} \int \frac{d^3 k d^3 l}{(k^2 + \gamma^2)^2 (l^2 + \gamma^2)^2} \sqrt{(E_k + m_\mu)(E_l + m_\mu)} \int \frac{d^3 q}{2E_q}$$

$$\frac{1}{|\vec{l} - \vec{q}|^2 (k - q)^2 ((P - q)^2 - m_e^2)} \frac{2m_\mu}{\sqrt{(E_q + m_\mu)(E_l + m_\mu)}} i\chi^{(\mu)\dagger} \left[ \frac{\vec{q} \times \vec{\sigma}_\mu}{E_k + m_\mu} - \frac{E_q + m_\mu}{E_k + m_\mu} \frac{\vec{k} \times \vec{\sigma}_\mu}{k^2} \right]^i \chi^{(\mu)}$$

$$\left\{ \frac{\langle \gamma^i (\vec{P} - \vec{q} + m_e)(\vec{P} + \vec{q} + m_e) \rangle^{(e)}}{2P^0} \frac{4E_q P^0}{(P + q)^2 - m_e^2} + \frac{\langle \gamma^i (\vec{P} - \vec{q} + m_e)(\vec{P} + \vec{l} + m_e) \rangle^{(e)}}{P^0 + m_e + E_l} \frac{2E_l (P^0 + m_e + E_l)}{(P + l)^2 - m_e^2} \right\}$$

(23)

This is actually not essential as we have already computed the contribution to hfs from exchange of a single transverse photon ( $\delta E_{IT} = 2\delta E_T$ ). However this procedure does provide an excellent check on the algebra and is well suited to numerical evaluation. The two electron traces compensate for the asymmetry of  $\bar{K}_0(\vec{q} \vec{l} P)$  under interchange of  $\vec{q} \leftrightarrow \vec{l}$  (i. e., the iterated diagram and its conjugate are not the same). Recalling that  $(\vec{P} - \vec{q} + m_e)(\vec{P} + \vec{q} + m_e) = 2P^0 (\tilde{E}\gamma^0 + \vec{q} \cdot \vec{\gamma} + m_e) \gamma^0$ , we have

$$i\chi^{(\mu)\dagger} \left[ \frac{\vec{q} \times \vec{\sigma}_\mu}{E_k + m_\mu} - \frac{E_q + m_\mu}{E_k + m_\mu} \frac{\vec{k} \times \vec{\sigma}_\mu}{k^2} \right]^i \chi^{(\mu)} \langle \gamma^i (\tilde{E}\gamma^0 + \vec{q} \cdot \vec{\gamma} + m_e) \gamma^0 \rangle^{(e)}$$

$$= \frac{\langle \vec{\sigma}_e \cdot \vec{\sigma}_\mu \rangle}{3} \left\{ 2\vec{q}^2 - \frac{\tilde{E} + m_e}{m_e} \vec{k} \cdot \vec{q} - \frac{E_q + m_\mu}{E_k + m_\mu} 2\vec{k} \cdot \vec{q} \right.$$

$$\left. + \frac{\tilde{E} + m_e}{m_e} \frac{E_q + m_\mu}{E_k + m_\mu} \vec{k}^2 + \frac{\tilde{E} - m_e}{m_e} \vec{l} \cdot \vec{q} \right\}$$





We examine first the  $\mu$ -pole contributions (ladder graph only). Following our general procedure, we expand all propagators and energies in the non-relativistic limit. By counting the number of powers of momenta ( $\sim \gamma$ ), including phase space, in the numerator and denominator of the integral, we find that terms quadratic in momentum in (22a) contribute at order  $E_F$ . Comparison with (24) indicates that these are all cancelled when  $\delta E_{IT}$  is subtracted. Terms quartic in momentum contribute to  $\mathcal{O}(\alpha^2 m_e/m_\mu E_F)$  modulo  $\log \alpha^{-1}$ . They also appear to diverge logarithmically for  $k, q, l$  nonrelativistic, but only when one or the other wave function integrations factors out - that is, when either  $k$  or  $l$  can be set to zero in the kernel. These are the  $\alpha^2 \log \alpha^{-1} E_F$  terms. Terms proportional to both  $k$  and  $l$  do not diverge in this region and thus need not be considered here, though power counting indicates that they do contribute to  $\mathcal{O}(\alpha^2 m_e/m_\mu E_F)$ . Subtracting the iteration,  $\delta E_{IT}$ , from the  $\mu$ -pole contribution, we are left with:

$$\begin{aligned} \delta E_{CT}(\mu) - \delta E_{IT} \Big|_{\alpha^6 \log \alpha^{-1}} &= E_F \frac{\gamma^3}{\pi} \int^{\sim m} \frac{d^3 k}{(k^2 + \gamma^2)^2} \frac{d^3 l}{(l^2 + \gamma^2)^2} \int^{\sim m} d^3 q \\ &\cdot \frac{1}{(q^2 + \gamma^2) |k-q|^2 |\ell-q|^2} \left\{ - \frac{(\vec{q}-\vec{k})^2 \vec{\ell}^2}{4m_e m_\mu} + \frac{\vec{q}^2 \vec{\ell} \cdot \vec{q}}{2m_\mu^2} \right. \\ &\quad \left. + \frac{\vec{q}^2 \vec{k} \cdot \vec{q}}{4m_\mu m_e} - \frac{\vec{q}^2 \vec{k}^2}{4m_\mu m_e} - \frac{\vec{q}^2 \vec{\ell} \cdot \vec{q}}{4m_\mu m_e} \right\} \end{aligned}$$

The final result follows immediately from Table I:

$$\delta E_{CT}(\mu) - \delta E_{IT} = \left( -2 + \frac{m_e}{m_\mu} \right) \frac{\gamma^2}{m_e m_\mu} E_F \log \alpha^{-1} .$$

We now examine the  $\gamma$ -pole contributions from (21). Power counting indicates that only terms quadratic and cubic in momentum in (22a), (22b) need be

considered to  $\mathcal{O}(\alpha^2 E_F)$  when  $k, q, l \sim \gamma$ . It is easily seen that when corrections from the muon propagators (25) are included, such terms in the ladder diagram are exactly cancelled by terms in the cross ladder diagram. Therefore the  $\gamma$ -poles generate no further contributions of order  $\alpha^2 \log \alpha^{-1} m_e/m_\mu E_F$ .

C. Double Coulomb - Single Transverse Photon Ladder Kernel

The most singular parts of this kernel (Figs. 4d, 6) contribute only to  $\mathcal{O}(\alpha^2 m_e/m_\mu \log \alpha^{-1} E_F)$  once the iteration of the Coulomb-transverse ladder has been subtracted. Thus we need consider only  $\mu$ -pole contributions to both the  $q^0$  and  $r^0$  integrals (when the contours are closed below the axes), and then only for  $\vec{r}, \vec{q}$  nonrelativistic. Also  $\log \alpha^{-1}$  terms are found only when both wave function integrations factor out (i.e.,  $\vec{k} = \vec{l} = 0$  in the kernel). Thus the perturbation is:

$$\delta E_{\text{CCT}} - \delta E_{\text{ICT}} \Big|_{\alpha^6 \ln \alpha^{-1}} = 2 \frac{\gamma^5 \alpha^3}{\pi^8} \left( \frac{d^3 k}{(k^2 + \gamma^2)^2} \right) \left( \frac{d^3 l}{(l^2 + \gamma^2)^2} \right) \int \frac{d^3 \vec{r}}{2m_\mu} \frac{m_\mu}{m_\mu + m_e}$$

$$\frac{1}{r^2 (r^2 + \gamma^2)} \int \frac{d^3 q}{2m_\mu} \frac{m_\mu}{m_\mu + m_e} \frac{1}{q^2 (q^2 + \gamma^2)} \frac{1}{|\vec{q} - \vec{r}|^2} \left\{ \langle \gamma^i (\vec{p} - \vec{q} + m_e) \gamma^0 (\vec{p} - \vec{r} + m_e) \right.$$

$$\left. \left[ \gamma^0 \sqrt{(E_r + m_\mu) 2m_\mu} - \frac{2E_r m_\mu}{(P+r)^2 - m_e^2} (\vec{p} + \vec{r} + m_e) - \gamma^0 m_\mu \right] \right\}^{(e)}$$

$$\cdot \delta_{ij}^\perp(\vec{q}) \langle \gamma^j (\vec{q} + m_\mu) \gamma^0 \rangle^{(\mu)}$$

For  $\vec{r}, \vec{q} \sim \gamma$

$$\langle \dots \rangle^{(e)} \simeq + i \chi^\dagger (\vec{q} \times \vec{\sigma}_e) \chi (\vec{r}^2/2)$$

$$\langle \gamma^j (\vec{q} + m_\mu) \gamma^0 \rangle^{(\mu)} \simeq i \chi^\dagger (\vec{q} \times \vec{\sigma}_e) \chi$$

and thus the hfs from this kernel is:

$$\begin{aligned} \delta E_{\text{CCT}} - \delta E_{\text{ICT}} \Big|_{\alpha^6 \log \alpha^{-1}} &= \frac{E_F \gamma^2}{4\pi^4 m_e m_\mu} \int^{\sim m} \frac{d^3 r}{r^2 (r^2 + \gamma^2)} \int^{\sim m} \frac{d^3 q}{q^2 (q^2 + \gamma^2)} \frac{-r^2 q^2}{|\vec{r}-\vec{q}|^2} \\ &= -\frac{\gamma^2}{m_e m_\mu} E_F \log \alpha^{-1} . \end{aligned}$$

#### D. Single Coulomb - Double Transverse Photon Ladder

The same approximations used in evaluating the previous graph may be applied to this graph (Fig. 7):

$$\begin{aligned} \delta E_{\text{TCT}} \Big|_{\alpha^6 \log \alpha^{-1}} &= \frac{\gamma^3 \alpha^3}{4\pi^4} \frac{1}{(m_\mu + m_e)^2} \int^{\sim m} \frac{d^3 r}{r^2 (r^2 + \gamma^2)} \int^{\sim m} \frac{d^3 q}{q^2 (q^2 + \gamma^2)} \frac{1}{|\vec{q}-\vec{r}|^2} \\ &\quad \left\{ \langle \gamma^i(\vec{p}-\vec{r}+m_e)\gamma^o(\vec{p}-\vec{q}+m_e)\gamma^j \rangle^{(e)} \delta_{ik}^\perp(\vec{r}) \delta_{jl}^\perp(\vec{q}) \langle \gamma^k(\vec{r}+m_\mu)\gamma^o(\vec{q}+m_\mu)\gamma^\ell \rangle^{(\mu)} \right\} \end{aligned}$$

where for  $r, q \sim \gamma$

$$M^{kl} \equiv \langle \gamma^k(\vec{r}+m_\mu)\gamma^o(\vec{q}+m_\mu)\gamma^\ell \rangle^{(\mu)} = i\chi^\dagger (\epsilon_{klm} \sigma_\mu^{m \rightarrow \vec{r} \cdot \vec{q} + (\vec{r} \times \vec{q})^k} \sigma_\mu^{l + (\vec{r} \times \vec{q})^l} \sigma_\mu^{k - \delta^{lk} \vec{r} \times \vec{q} \cdot \sigma_\mu}) \chi$$

$$E^{ij} \equiv \langle \gamma^i(\vec{p}-\vec{r}+m_e)\gamma^o(\vec{p}-\vec{q}+m_e)\gamma^j \rangle^{(e)} = M^{ij} \text{ with } \sigma_\mu \rightarrow \sigma_e .$$

Therefore

$$E^{ij} \delta_{ik}^\perp(\vec{r}) \delta_{jl}^\perp(\vec{q}) M^{kl} = \langle \sigma_e \cdot \sigma_\mu \rangle \left\{ 2(\vec{r} \cdot \vec{q})^2 + \frac{7}{3} |\vec{r} \times \vec{q}|^2 - \frac{4}{3} \vec{r} \cdot \vec{q}^2 \right\}$$

and the final contribution is

$$\delta E_{\text{TCT}} \Big|_{\alpha^6 \log \alpha^{-1}} = \frac{5}{4} \frac{\gamma^2}{m_e m_\mu} \log \alpha^{-1} E_F .$$

Taking  $m_\mu = m_e$  we obtain the result presented in Ref. 10 for positronium.

F. Other Diagrams

The diagrams in Fig. 8 appear to contribute to order  $\alpha^2 \log \alpha^{-1} E_F$  (note that there is no factor  $m_e/m_\mu$  as above). In fact, it is trivially shown that these terms exactly cancel to this order in pairs as indicated in Fig. 8. Note that the diagrams involve retardation corrections to single and double transverse photon exchange.

## VI. CONCLUSIONS

In this paper we argue that it is essential in atomic physics to have the exact analytic solution for some 0<sup>th</sup> order interaction which contains the basic physics. We have obtained just such a solution using an effective single-particle formalism equal in rigor to the Bethe-Salpeter formalism. This solution incorporates both reduced mass corrections of the sort encountered in Schrödinger theory as well as the correct Dirac fine structure in the limit of large mass for one of the constituents. The corrections to the basic interaction are specified unambiguously by perturbation theory (once a gauge has been chosen).

Applying these results, we have computed the first new results in QED obtained from an effective one-particle formalism. Theory and experiment are compared for muonium hfs in Table II and for positronium hfs in Table III. The  $\alpha^6 \ln \alpha^{-1}$  contributions to each are

$$\Delta E = 2 \alpha^2 \frac{m_e m_\mu}{(m_e + m_\mu)^2} \log \alpha^{-1} E_F(\mu e) = 0.0112 \text{ MHz for muonium}$$

$$\Delta E = \frac{-1}{24} \alpha^2 \log \alpha^{-1} E_F(e e) = -0.0038 \text{ GHz for positronium}$$

where corrections from the annihilation graphs have been included for positronium. No diagram other than those considered above seems sufficiently singular to contribute to  $\mathcal{O}(\alpha^2 \ln \alpha^{-1} E_F)$  hfs in either atom.

Little can be said about agreement with muonium experiments until all contributions of the form  $\alpha^2 \frac{m_e}{m_\mu} \ln \left( \frac{m_\mu}{m_e} \right) E_F$  ( $\sim 0.01$  MHz) have been computed.<sup>19</sup> Theory and experiment are consistent within errors for positronium. However the situation will be satisfactory for neither atom until all contributions of order  $\alpha^2 E_F$  for positronium and  $\alpha^2 \frac{m_e}{m_\mu} E_F$ ,  $\alpha^3 E_F$  for muonium have been computed.

We are greatly indebted to S. J. Brodsky for suggesting this problem and for many useful discussions. We also thank Y. J. Ng for calling our attention to some of the diagrams in Fig. 8.

APPENDIX

Here we show how  $\tilde{K}_0$  may be modified to include the entire Breit interaction (Coulomb and transverse instantaneous photon exchange), thereby obtaining the complete fine structure up to and including  $\mathcal{O}((Z\alpha)^4(m_2/m_1)m_2)$  for  $m_1 \gg m_2$ . The treatment given here is very similar to that of Grotch and Yennie<sup>2</sup> and so will be only briefly sketched. The main advantage of this approach over theirs is that  $k^0 = \sqrt{\vec{k}^2 + m_1^2}$  need not be expanded in powers of  $\vec{k}^2/m_1^2$ .

We work in coordinate space and only to first order in  $(m_2/m_1)$ . Eq. (14) can be rewritten

$$(P^0 - E_{\vec{k}} - V + \vec{\alpha} \cdot \vec{k} - \beta m_2) \psi = 0$$

where  $\vec{\alpha} = \gamma^0 \vec{\gamma}$ ,  $\beta = \gamma^0$ . Multiplying by  $(P^0 + E_{\vec{k}} - V + \vec{\alpha} \cdot \vec{k} - \beta m_2)$ , we obtain

$$\left[ \tilde{E} + \vec{\alpha} \cdot \vec{k} - \beta m_2 - V + \frac{V^2}{2P^0} - \left[ V, \frac{\vec{\alpha} \cdot \vec{k}}{2P^0} \right] + \left[ \frac{\beta m_2}{2P^0}, V \right] + \left[ V, \frac{E_{\vec{k}}}{2P^0} \right] \right] \psi = 0 \quad (26)$$

where  $\tilde{E} = m_2^2 - \epsilon \frac{m_1}{P^0} + \frac{\epsilon^2}{2P^0}$  (Eq. (16)). Ignoring hfs terms, the interaction due to exchange of a single instantaneous photon can be written (in Coulomb gauge):

$$V_{1\gamma} = U_C - \left[ U_C, \frac{\vec{\alpha} \cdot \vec{k}}{2P^0} \right] - \frac{1}{4P^0} \left[ \vec{\alpha} \cdot \vec{k}, [k^2, W] \right] + \mathcal{O}\left( (Z\alpha)^4 m_2 \left( \frac{m_2}{m_1} \right)^2 \right).$$

where  $U_C = -\alpha/r$  and  $W = -\alpha r$ . Recall that the momentum of  $m_2$  is  $-\vec{k}$ . Putting  $V = V_{1\gamma}$ , Eq. (26) becomes

$$\left[ \tilde{E} + \vec{\alpha} \cdot \vec{k} - \beta m_2 - \frac{P^0 - \beta m_2}{P^0} U_C \right] \psi = 0 \quad (27)$$

where we have used the following results of first order perturbation theory

$$\left[ U_C, E_{\vec{k}} \right] \simeq 0 \quad (\ll (Z\alpha)^4 m_2^2/m_1)$$

$$\frac{1}{4P^0} [\vec{\alpha} \cdot \vec{k}, [K^2, W]] \simeq -\frac{U_C^2}{2P^0}$$

and have dropped all terms that contribute only to  $\mathcal{O}(\alpha^4 m_2(m_2/m_1)^2)$  or higher.

Eq. (27) can now be solved exactly by mixing the components of  $\psi$  so that the Coulomb term is proportional to the identity matrix in spinor space:

$$\psi \equiv (1 + \lambda\beta) \tilde{\psi} \quad \lambda = \frac{P^0}{m_2} \left( 1 - \sqrt{1 - \left(\frac{m_2}{P^0}\right)^2} \right) \simeq \frac{m_2}{2P^0}$$

$$\Rightarrow (E' + \vec{\alpha} \cdot \vec{k} - \beta m') \tilde{\psi} = -\frac{Z\alpha'}{r} \tilde{\psi}$$

where (expanding to first power in  $m_2/m_1$ )

$$E' = \frac{(1+\lambda^2)\tilde{E} - 2m_2\lambda}{1-\lambda^2} \simeq \frac{m_1 m_2}{P^0} - \epsilon \frac{m_1 + m_2}{P^0} + \frac{\epsilon^2}{2P^0}$$

$$m' = \frac{m_2(1+\lambda^2) - 2\lambda\tilde{E}}{1-\lambda^2} \simeq \frac{m_1 m_2}{P^0}$$

$$Z\alpha' = \left( \frac{(1+\lambda^2)P^0 - 2m_2\lambda}{(1-\lambda^2)P^0} \right) Z\alpha \simeq Z\alpha .$$

Thus the binding energies  $\epsilon$  (where  $P^0 = m_1 + m_2 - \epsilon$ ) are found by solving:

$$-\epsilon = \frac{m_1 m_2}{m_1 + m_2} [f(n', j) - 1] - \frac{\epsilon^2}{2(m_1 + m_2)} \quad \begin{array}{l} n' = 0, 1, 2, \dots \\ j = \frac{1}{2}, \frac{3}{2}, \dots \end{array}$$

$$\simeq -\frac{(Z\alpha)^2}{2n^2} \frac{m_1 m_2}{m_1 + m_2} - (Z\alpha)^4 \frac{m_1 m_2}{m_1 + m_2} \left\{ \frac{1}{2n^3(j+\frac{1}{2})} - \frac{3}{8n^4} + \frac{1}{8n^4} \frac{m_1 m_2}{(m_1 + m_2)^2} \right\} + \mathcal{O}\left((Z\alpha)^4 m_2^3/m_1^2\right)$$

$$n = n' + j + \frac{1}{2}$$

where  $mf(n', j)$  are the usual Dirac-Coulomb energies (Eq. (19)). This equation contains the complete fine structure up to and including  $\mathcal{O}((Z\alpha)^4 m_2(m_2/m_1))$ , as desired. The wave functions are again directly related to the Dirac-Coulomb wave functions.



All calculations in this paper can be performed using this solution of the bound state equation. However it is generally simpler to use the solution described in Section IV, except possibly when working to low order in  $m_2/m_1 \ll 1$ .

REFERENCES

1. F. Gross, Phys. Rev. 186, 1448 (1969).
2. H. Grotch and D. R. Yennie, Rev. Mod. Phys. 41, 350 (1969).
3. C. Fronsdal and R. W. Huff, Phys. Rev. D 3, 933 (1971).
4. S. J. Brodsky, in Proc. 3rd Colloquium on Advanced Computing Methods in Theoretical Physics, Marseilles, 1973.
5. L. S. Duljan and R. N. Faustov, "Modified Dirac Equation in Quantum Field Theory," Joint Institute of Nuclear Research preprint P2-7995, Dubna, 1974 (in Russian); J. L. Gorelick and H. Grotch, Nucl. Phys. 3 1 (1977).
6. I. T. Todorov, in Proc. 9th Int. School of Physics, Erice, 1970, ed. A. Zichichi.
7. H. Cheng and T. T. Wu, Phys. Rev. 186, 1611 (1969); H. Abarbanel and C. Itzykson, Phys. Rev. Lett. 23, 53 (1969); M. Levy and J. Sucher, Phys. Rev. 186, 1676 (1969).
8. T. Fulton, D. A. Owen, and W. W. Repko, Phys. Rev. A 4, 1802 (1971).
9. V. K. Cung, T. Fulton, W. W. Repko and D. Schnitzler, Ann. Phys. (N.Y.) 96, 261 (1976); V. K. Cung, T. Fulton, W. W. Repko, A. Schaum and D. Devoto, Ann. Phys. (N.Y.) 98, 516 (1976).
10. R. Barbieri and E. Remiddi, Phys. Lett. 65B, 258 (1976).
11. A. Messiah, Quantum Mechanics, Vol. II (John Wiley & Sons, New York, 1962), Section 16.15.
12. No use of the fact  $m_\mu \gg m_e$  is made in this analysis, and so making the unnatural assignment  $m_1 = m_e$ ,  $m_2 = m_\mu$  (i.e., the electron effectively on mass shell) changes none of the results.
13. B. E. Lautrup, A. Peterman, and E. de Rafael, Phys. Rep. 3, 193 (1972).

14. The need for a doubly iterated wave function was first noted by Y. J. Ng, Ph.D. thesis, Harvard, 1974 (unpublished).
15. The techniques used here to estimate order of magnitude and to isolate  $\log \alpha$  terms are very similar in spirit to those used by G. W. Erickson and D. R. Yennie, *Ann. Phys. (N.Y.)* 35, 447 (1965).
16. This invariance, which is automatic in our formalism, was demonstrated to  $\mathcal{O}(\alpha^5 m)$  in hfs by direct computation using BS methods in V. K. Cung, T. Fulton and W. W. Repko, *Phys. Rev. A* 14, 552 (1976).
17. The conventions of J. D. Bjorken and S. D. Drell, Relativistic Quantum Fields (McGraw-Hill, New York, 1964), have been adopted throughout this paper except that spinors are normalized such that  $\bar{u}u = 2m$ ,  $\Sigma u\bar{u} = \not{P} + m$ , etc.
18. Ladder kernels in Fig. 4c - 4g are all second order perturbations as in Eq. (12). To  $\mathcal{O}(\alpha^6 m \log \alpha)$ ,  $\bar{G}_0 - \Psi_j^0 \bar{\Psi}_j^0 / (E - E_j^0)$  may be approximated by free propagators (Fig. 4c, 4e, 4g) together with a single Coulomb interaction (Fig. 4d, 4f). The entire Green's function (i.e., infinite Coulomb exchange) will be needed to compute to  $\mathcal{O}(\alpha^6 m)$ .
19. These are potentially larger than the  $\alpha^2 \frac{m_e}{m_\mu} \log \alpha^{-1} E_F$  contributions.
20. D. E. Casperson, T. W. Crane, A. B. Denison, P. O. Egan, V. W. Hughes, F. G. Mariam, H. Orth, H. W. Reist, P. A. Souder, R. D. Stambaugh, P. A. Thompson, and G. zu Putlitz, *Phys. Rev. Lett.* 38, 956 (1977).
21. P. O. Egan, W. E. Frieze, V. W. Hughes and M. H. Yam, *Phys. Lett.* 54A, 412 (1975).
22. A. P. Mills, Jr. and G. H. Berman, *Phys. Rev. Lett.* 34, 246 (1975).

TABLE I

Table of integrals required for analytic evaluations.<sup>8</sup>

$$\int_{\sim \alpha m}^{\sim m} \frac{d^3 k}{k^4} \frac{d^3 q}{q^4} \frac{f(k, q)}{|k-q|^2} = K \pi^4 \log \alpha^{-1}$$

f(k, q)	K
$k^4, q^4$	0
$k^2 q^2$	4
$k^2 k \cdot q, q^2 k \cdot q$	2
$(k \cdot q)^2$	2

TABLE II

Comparison of theory and experiment for muonium hfs. Uncertainties shown in theory due to uncertainties in  $\mu_\mu/\mu_P$  (Ref. 20). Terms of  $\mathcal{O}\left(\alpha^2 \frac{m_e}{m_\mu} \log \frac{m_\mu}{m_e} E_F\right) \sim 0.01$  MHz have yet to be computed and are not included.

---

<u>Theory</u>	
$E_F + \mathcal{O}\left(\alpha \frac{m_e}{m_\mu} E_F, \alpha^2 E_F, \alpha^3 E_F\right)$	4463.293 (6) MHz
$2\alpha^2 \frac{m_e}{m_\mu} E_F \log \alpha^{-1}$	<u>.011</u>
Total Theory	4463.304 (6) MHz
<u>Experiment</u>	
Ref. 20	4463.30235 (52) MHz

---

TABLE III

Comparison of theory and experiment for positronium hfs. Terms of  $\mathcal{O}(\alpha^2 m_e/2) \sim 0.01$  GHz are not yet computed.

---

<u>Theory</u>	
$\mathcal{O}(\alpha^4 m_e, \alpha^5 m_e)$	203.3812 GHz
$\frac{-1}{24} \alpha^6 m_e \log \alpha^{-1}$	<u>- .0038</u>
Total Theory	203.3774 GHz
<u>Experiment</u>	
Ref. 21	203.3849 (12) GHz
Ref. 22	203.3870 (16) GHz

---

FIGURE CAPTIONS

1. A Dyson equation for the two-particle Green's function with one particle on mass shell. Fermion lines marked with an  $\times$  are on mass shell.
2. Definition of the new kernel  $\bar{K}$  in terms of the usual BS kernel  $K$ .
3. The bound state equation.
4. Diagrams contributing to  $\mathcal{O}(\alpha^2 m_e/m_\mu \log \alpha^{-1} E_F)$  hfs in muonium. The contribution to positronium hfs is found by setting  $m_\mu = m_e$ . The double iteration of  $\tilde{K}_0$  has been omitted from (g) as it (like  $\tilde{K}_0$ ) contains no spin-spin interaction.
5. Coulomb-transverse photon ladder kernels.
6. Double Coulomb-single transverse photon ladder kernel.
7. Single Coulomb-double transverse photon ladder kernel.
8. Diagrams cancelling in pairs to  $\mathcal{O}(\alpha^2 \log \alpha^{-1} E_F)$ .

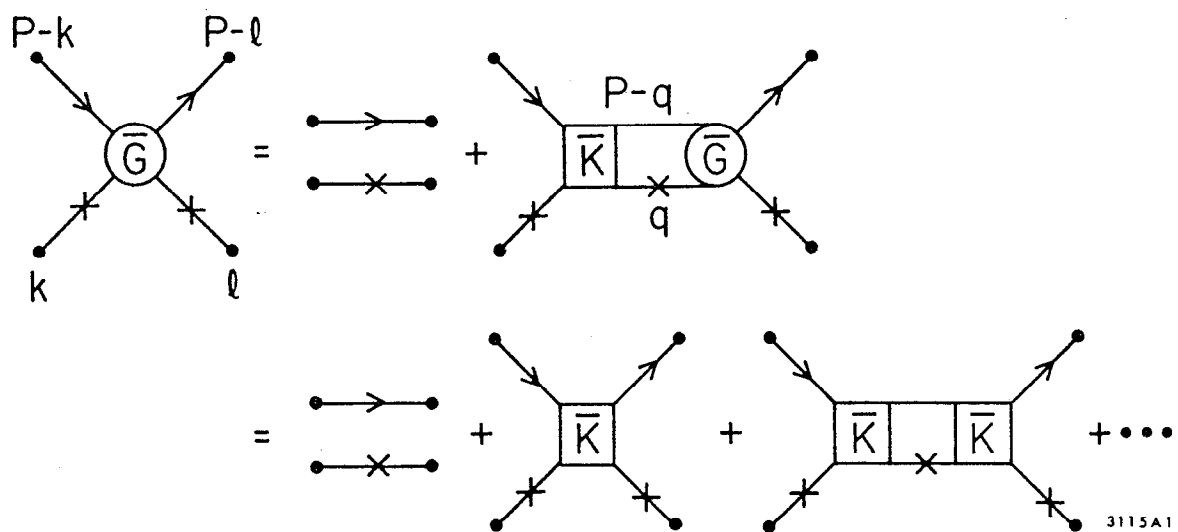
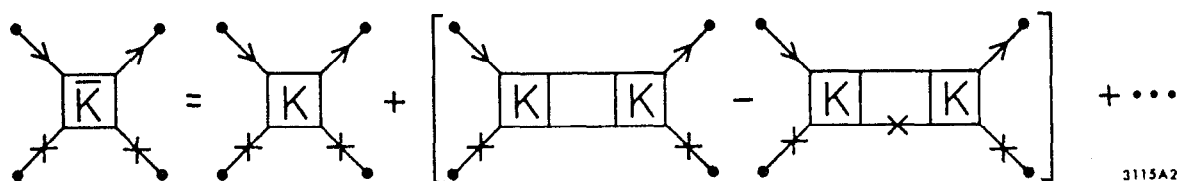

Fig. 1





3115A2

Fig. 2

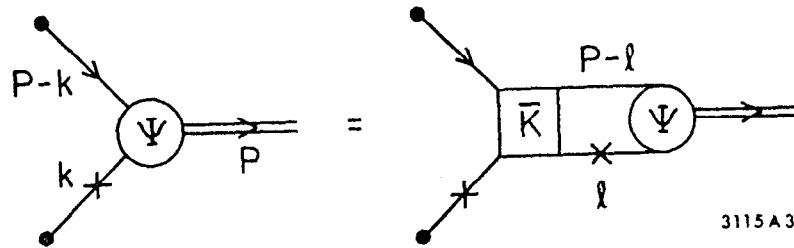

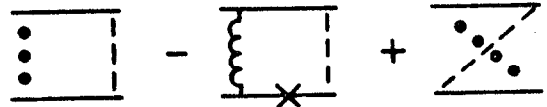
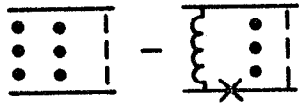
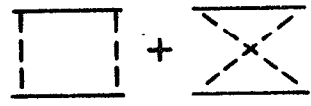

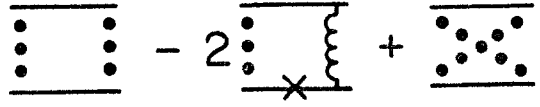

Fig. 3

COEFFICIENT OF

$$\alpha^2 \frac{m_e m_\mu}{(m_e + m_\mu)^2} \log \alpha^{-1} E_F$$

KERNEL

(a)		$\frac{1}{4}$	
(b)		-1	$-\frac{m_e}{m_\mu}$
(c)		-2	$+\frac{m_e}{m_\mu}$
(d)		-1	
(e)		$\frac{9}{2}$	
(f)		$\frac{5}{4}$	
(g)		0	

••• Coulomb Interaction

--- Transverse Photon Interaction

~ Unperturbed Kernel  $\tilde{K}_0$  3115A.4

Fig. 4

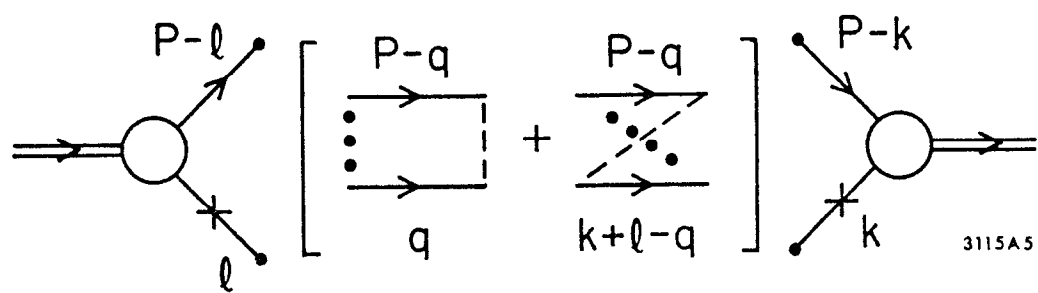

3115A5

Fig. 5

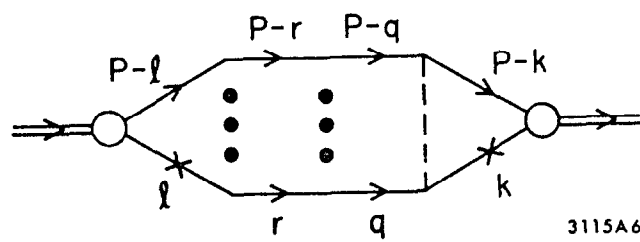

Fig. 6

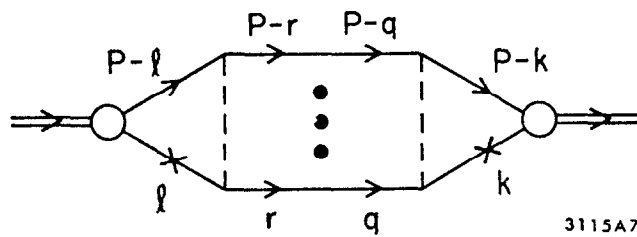
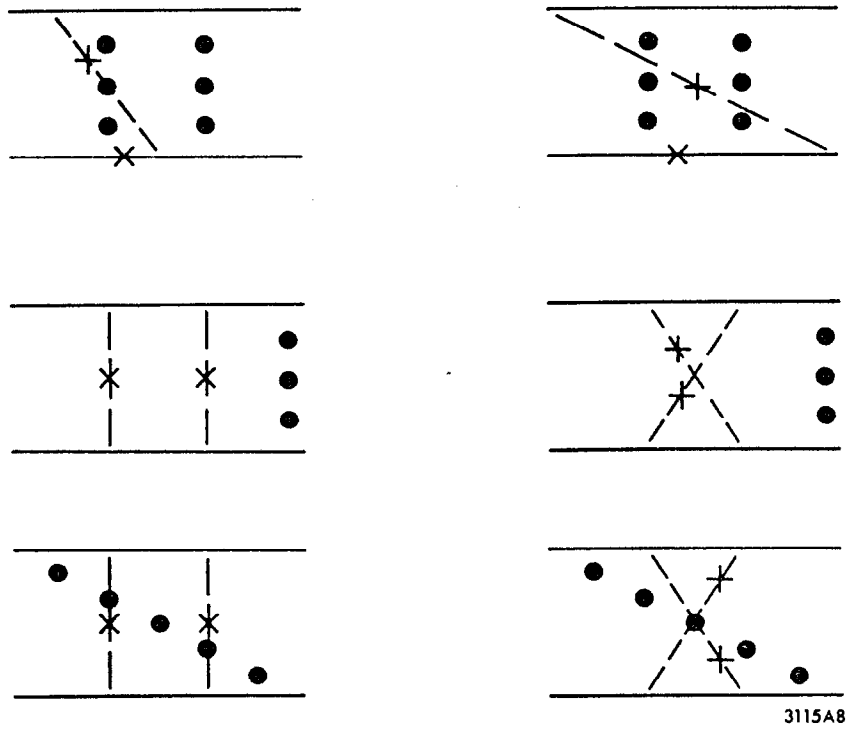

Fig. 7



3115A8

Fig. 8