

Published in final edited form as:

J Nutr Biochem. 2010 March ; 21(3): 171–179. doi:10.1016/j.jnutbio.2009.08.003.

Antiobesity Mechanisms of Action of Conjugated Linoleic Acid

Arion Kennedy¹, Kristina Martinez¹, Soren Schmidt², Susanne Mandrup², Kathleen LaPoint¹, and Michael McIntosh¹

¹Department of Nutrition, UNC-Greensboro, Greensboro, NC

²Department of Biochemistry and Molecular Biology, University of Southern Denmark, Odense, Denmark (Version 8-6-09)

Abstract

Conjugated linoleic acid (CLA), a family of fatty acids found in beef, dairy foods, and dietary supplements, reduces adiposity in several animal models of obesity and in some humans. However, the isomer-specific antiobesity mechanisms of action of CLA are unclear, and its use in humans is controversial. This review will summarize *in vivo* and *in vitro* findings from the literature regarding potential mechanisms by which CLA reduces adiposity including its impact on 1) energy metabolism, 2) adipogenesis, 3) inflammation, 4) lipid metabolism, and 5) apoptosis.

Keywords

CLA; obesity; adipose tissue; energy metabolism; PPAR γ ; adipogenesis; inflammation

1. Introduction

Conjugated linoleic acid (CLA) refers to a group of conjugated octadecadienoic acid isomers derived from linoleic acid, a fatty acid that contains 18 carbons and two double bonds in the *cis* configuration at the 9th and 12th carbons (i.e., *cis*-9, *cis*-12 octadecadienoic acid). Microbes in the gastrointestinal tract of ruminant animals convert linoleic acid into different isoforms of CLA through biohydrogenation. This process changes the position and configuration of the double bonds, resulting in a single bond between one or both of the two double bonds (i.e., *cis*-9, *trans*-11 (9,11) or *trans*-10, *cis*-12 (10,12) octadecadienoic acid).

Commercial preparations of CLA are made from the linoleic acid of safflower or sunflower oils under alkaline conditions. This type of processing yields a CLA mixture containing approximately 40% of the 9,11 isomer and 44% of the 10,12 isomer [reviewed in 1]. Commercial preparations also contain approximately 4% to 10% *trans*-9, *trans*-11 CLA and *trans*-10, *trans*-12 CLA, as well as trace amounts of other isomers.

The 9,11 isomer, also known as rumenic acid, is the predominant form of CLA found in naturally occurring foods. 9,11 CLA comprises approximately 90% of CLA found in ruminant meats and dairy products and the 10,12 isomer comprises the remaining 10%. Although several

© 2009 Elsevier Inc. All rights reserved.

Corresponding author: Michael K. McIntosh, Ph.D., R.D., Department of Nutrition, 318 Stone Building, PO Box 26170, University of North Carolina Greensboro, Greensboro, NC 27402-6170, Phone: 336/256-0325; Fax: 336/334-4129; mkmcinto@uncg.edu.

Publisher's Disclaimer: This is a PDF file of an unedited manuscript that has been accepted for publication. As a service to our customers we are providing this early version of the manuscript. The manuscript will undergo copyediting, typesetting, and review of the resulting proof before it is published in its final citable form. Please note that during the production process errors may be discovered which could affect the content, and all legal disclaimers that apply to the journal pertain.

other isoforms of CLA have been identified (i.e., trans-9, trans-11; cis-9, cis-11; trans-10, trans-11; and cis-10, cis-12), the 9,11 and 10,12 isomers appear to be the most biologically active [2].

The proportion of CLA ranges from 0.34% to 1.07% of the total fat in dairy products, and from 0.12% to 0.68% of the total fat in raw or processed beef products [reviewed in 3 and 4-5]. However, the CLA content of food is dependent on several factors including the season and the animal's breed, nutritional status, and age [reviewed in 3]. The average daily intake of CLA is approximately 152 mg to 212 mg for non-vegetarian women and men, respectively [6], and human serum levels range from 10 $\mu\text{mol/L}$ to 70 $\mu\text{mol/L}$ [7-8].

1.1 Antiobesity properties of CLA

CLA was initially discovered in 1987 by Pariza and colleagues, and it was first identified as an anti-carcinogen [9]. Subsequently, CLA was shown to exhibit anti-atherosclerotic [reviewed in 10] and antiobesity properties [reviewed in 11]. Due to the substantial rise in obesity prevalence over the past 30 years [12], interest in CLA as a weight loss treatment has been increasing. Supplementation with a CLA mixture (i.e., equal concentrations of the 10,12 and 9,11 isomers) or the 10,12 isomer alone decreases body fat mass (BFM) in many animal and some human studies [reviewed in 11 and 13]. Of the two major isomers of CLA, the 10,12 isomer specifically is responsible for the antiobesity effects [14-18].

1.2. CLA regulation of body weight

Park et al. [19] were the first to demonstrate that CLA modulated body composition. In this study, male and female mice given a 0.5% (w/w) CLA mixture had 57% and 60% lower BFM, respectively, compared to controls. Other researchers have subsequently demonstrated that CLA supplementation consistently reduces BFM in mice, rats, and pigs [20-24]. For example, dietary supplementation with 1% (wt/wt) CLA mixture for 28 days decreased body weight and periuterine white adipose tissue (WAT) mass in C57BL/6J mice [25]. Similarly, a 1.0% to 1.5% (wt/wt) mixture of CLA for 3 to 4 weeks decreased body weight and WAT mass in male ob/ob [26] and ICR [27] obese mice.

Studies investigating CLA's effects on BFM reduction in humans have produced less consistent results. Whereas some studies show that CLA decreases BFM and increases lean body mass (LBM) [reviewed in 13 and 16], others have shown no effect of CLA supplementation on body composition in humans [reviewed in 13]. For example, supplementation of a CLA mixture in overweight and obese people (3-4 g/day for 24 weeks) decreased BFM and increased LBM [28]. On the other hand, supplementation of CLA mixture in yogurt in healthy adults (3.76 g/day for 14 weeks) had no effect on body composition [29]. In addition, Larsen et al. [30] investigated the potential role of CLA for preventing body weight regain in moderately obese subjects who had lost approximately 10 kg after an 8-week dietary intervention on a low calorie diet. Supplementation for 1 year with a CLA mixture did not prevent body weight regain compared to controls in that study. Finally, supplementation with 3.2 g/day of a CLA mixture decreased total BFM and trunk fat compared to placebo in overweight subjects, but not obese subjects [31]. These contradictory findings among human studies may be due to the following differences in experimental design 1) CLA isomer combination versus individual isomers, 2) CLA dose and duration of treatment, and 3) gender, weight, age and metabolic status of the subjects.

The primary discrepancy between animal and human studies appears to be the dose of CLA administered. For example, moderately overweight humans with an average weight of 72.5 kg supplemented with a CLA mixture (3.76 g/day for 14 weeks) experienced no decrease in body weight, BMI, or BFM [29]. In contrast, C57BL/6 mice supplemented with 1.5% (w/w) CLA

mixture for 4 weeks weighed significantly less and had reduced adiposity compared to controls [32]. However, while subjects in the human study received approximately 0.05 g CLA/kg body weight, the mice received 1.07 g CLA/kg body weight, which was 20 times the human dose based on body weight. Supplementing humans with higher doses of CLA would address this dosing issue.

Because CLA has the potential to reduce BFM when given at high enough doses and is being taken as a supplement for that purpose, it is important to understand its mechanism of action. Therefore, this review will examine potential mechanisms by which the CLA mixture or 10,12 CLA alone reduces adiposity, with particular emphasis on its effects on WAT. Potential mechanisms to be discussed include regulation of 1) energy metabolism, 2) adipogenesis, 3) inflammation, 4) lipid metabolism, and 5) apoptosis.

2. Antiobesity Mechanisms of CLA

2.1. CLA regulation of energy metabolism

CLA decreases energy intake—Energy balance is a function of energy intake relative to energy expenditure. When energy intake exceeds energy expenditure, body weight and BFM increase, and vice-versa. Accordingly, potential mechanisms by which CLA reduces BFM include decreasing energy intake or increasing energy expenditure. Park et al. [19] demonstrated that mice supplemented with a CLA mixture or enriched 10,12 CLA for 4 weeks reduced their food intake. A number of subsequent studies in rodents produced similar results [16, 33–36]. No studies to date have demonstrated that CLA decreases food intake in humans [37–40].

A mechanism for this reduced food intake was suggested by So et al. [36], who reported that food intake was reduced by 23.6% in mice fed a low-fat diet supplemented with 10,12 CLA. In this study, mice receiving 10,12 CLA had a decreased gene expression ratio of proopiomelanocortin to neuropeptide Y (NPY) in the hypothalamus. These results suggest that CLA exerts an effect on hypothalamic appetite-regulating genes. In support of this hypothesis, injection of mixed isomers of CLA to the rat hypothalamus reduced the expression of NPY and agouti-related protein, neuropeptides that robustly increase food intake [41]. Alternatively, CLA supplementation may reduce food intake by affecting the palatability of the diet, but so far there are no reports to support this hypothesis.

A number of studies have reported reduced adiposity without changes in energy intake following administration of a CLA mixture in mice [42–45]. For example, supplementation of mice with a CLA mixture for 42 days decreased total body weight without reducing food intake [45]. These data indicate that CLA effects on body fat are not solely dependent on reductions of food or energy intake. Thus, although several studies show that CLA decreases energy intake, others show no effect, suggesting that CLA can decrease body fat independent of reducing energy intake.

CLA increases energy expenditure—Energy expenditure is a function of basal metabolic rate (BMR), adaptive thermogenesis, and physical activity. CLA has been proposed to reduce adiposity by elevating energy expenditure via increased BMR, thermogenesis, or lipid oxidation in animals [33, 43–47]. For example, in BALB/c male mice fed mixed isomers of CLA for 6 weeks, body fat was decreased by 50% compared to controls and was accompanied by increased BMR [45]. Enhanced thermogenesis may be associated with an upregulation of uncoupling proteins (UCPs), which facilitate proton transport over the inner mitochondrial membrane, thereby diverting energy from ATP synthesis to heat production. UCP1 was the first member of the family to be isolated and is exclusively expressed in brown adipose tissue; UCP3 is expressed in muscle and a number of other tissues; and UCP2 is expressed in a variety

of tissues, including WAT, and is the most highly-expressed UCP. Supplementation with a CLA mixture or 10,12 CLA in rodents has been shown to induce UCP2 transcription in WAT [27, 35, 48–50], but whether this plays a role in energy dissipation is unclear. CLA also increased the expression of another mitochondrial protein, carnitine palmitoyltransferase 1 (CPT1) in WAT of 10,12 CLA-treated mice [50, 51]. CPT1 is involved in mitochondrial FA uptake and catalyzes the rate-limiting step of FA oxidation. Consistent with these findings, 10,12 CLA increased beta-oxidation in differentiating 3T3-L1 mouse preadipocytes [52]. Similarly, CLA supplementation has been shown to increase UCP expression and beta oxidation in rodent muscle and liver [35, 53–57].

On the other hand, results from human studies concerning CLA regulation of energy expenditure are mixed. For example, a recent investigation of human supplementation with a CLA mixture (3.9 g/day for 12 weeks) revealed no change in BMR or BFM [39]. Similar results have been reported in other studies of humans supplemented with a CLA mixture [37, 58]. In contrast, healthy, moderately-overweight humans consuming a CLA mixture in yogurt (3.76 g/day for 14 weeks) exhibited higher BMR, although body weight was not affected [29]. Similarly, supplementation with a CLA mixture for 13 weeks increased the resting metabolic rate and fat-free mass in human subjects without a corresponding effect on BFM [59]. Thus far, only one human study has demonstrated both increased energy expenditure and decreased body weight in humans. In this study by Close et al., subjects supplemented with a CLA mixture (4 g/day for 6 months) had decreased body weight, and exhibited increased fat oxidation and energy expenditure while sleeping [60].

Other studies have demonstrated that CLA supplementation increases LBM, which is associated with higher levels of energy expenditure. For example, mixed CLA isomers (6.4 g/day for 12 weeks) increased LBM by 0.64 kg in healthy obese humans compared to controls [58]. Similarly, mice fed a 0.4% (w/w) CLA mixture exhibited increased LBM compared to controls [61]. Proposed mechanisms by which CLA increases LBM are via increased bone or muscle mass, which is supported by evidence from rodent studies. A 10-week 10,12 CLA supplementation (0.5% (wt/wt) mixed isomers) increased bone mineral density and muscle mass in C57BL/6 female mice [62]. CLA supplementation is thought to increase bone mineral density by upregulating osteogenic gene expression and downregulating osteoclast bone resorbing activity [62, 63]. Similarly, CLA supplementation alone or with exercise increased bone mineral density in middle-aged female mice compared to controls [64].

Alternatively, CLA may suppress the adipogenesis of pluripotent mesenchymal stem cells (MSCs) in bone marrow, and instead enhance their commitment to become osteoblasts (bone-forming cells). Indeed, 10,12 CLA has been shown to preferentially promote the differentiation of human MSCs into osteoblasts in culture [65]. In contrast, 9,11 CLA increased adipocyte differentiation and decreased osteoblast differentiation. Consistent with these *in vitro* data, CLA mixture supplementation of rats treated with corticosteroids, which decrease muscle and bone mass, prevented reductions in LBM, bone mineral density, and bone mineral content [66]. Collectively, these findings suggest CLA may reduce adiposity through increased energy expenditure via increased mitochondrial uncoupling and fatty acid oxidation in WAT, or via increased muscle or bone mass. However, the extent to which CLA regulates BMR or LBM, and how this contributes to the reduction in body weight or fat in humans, remains to be determined.

2.2. CLA regulation of adipogenesis

CLA inhibits adipogenesis—The conversion of preadipocytes to adipocytes involves the activation of key transcription factors such as peroxisome proliferator-activated receptor (PPAR) γ and CAAT/enhancer binding proteins (C/EBPs). During the differentiation process, increased C/EBP β and C/EBP δ activity induces the transcription of C/EBP α and PPAR γ , the

master regulators of adipocyte differentiation (Fig. 1). There is much evidence showing that CLA suppresses preadipocyte differentiation in animal [18, 52, 67–71] and human [72, 73] preadipocytes. 10,12 CLA treatment has been reported to reduce adipogenesis and lipogenesis specifically by attenuating PPAR γ , C/EBP α , sterol regulatory element binding protein 1c (SREBP-1c), liver X receptor (LXR α), and adipocyte fatty acid binding protein (aP2) expression [27, 71–75].

In rodents, 10,12 CLA supplementation decreased the expression of PPAR γ and its target genes [24, 50, 71, 76]. In mature, *in vitro*-differentiated primary human adipocytes or in mature 3T3-L1 adipocytes, 10,12 CLA treatment leads to a substantial decrease in the expression and activity of PPAR γ [18, 77], and a decrease in PPAR γ target genes and lipid content [73]. These and numerous other studies show that 10,12 CLA specifically is not only able to inhibit, but can reverse the adipogenic process and that this may, in part, be mediated by suppression of PPAR γ activity (Fig. 2). The decrease in PPAR γ target gene expression may be due to reduced PPAR γ expression or to posttranslational inhibition of PPAR γ activity *per se*. Because PPAR γ directly or indirectly induces its own expression, decreased PPAR γ activity would be expected to suppress PPAR γ expression, which makes it difficult to determine the level at which the inhibition occurs. Time course experiments conducted in our laboratories, however, indicate that inhibition of PPAR γ activity occurs prior to a decrease in PPAR γ expression [73], suggesting that inhibition of PPAR γ activity may be a primary event.

Many mechanisms exist by which CLA may posttranslationally regulate PPAR γ . Transient transfection assays with ectopically-expressed PPAR γ have been employed to assess CLA isomers as potential ligands for PPAR γ . In such assays, both CLA isomers have been shown to only modestly activate PPAR γ , even at high concentrations. However, they are able to effectively inhibit the action of full agonists such as rosiglitazone and darglitazone [18, 70, 77, 78], indicating that CLA may act as a low affinity partial agonist. Nonetheless, this mechanism cannot fully account for the 10,12 CLA-specific repression of PPAR γ activity.

PPAR γ activity may also be regulated by phosphorylation (Fig. 2), which can be mediated by the mitogen activated protein kinase (MAPK) pathway [79–81]. Ser-112 phosphorylation of PPAR γ 2, the form of PPAR γ required for adipocyte differentiation, may decrease its activity via ubiquitination and proteasome degradation [82], and by reducing both its ligand-dependent and ligand-independent transactivating functions [80, 83–85]. We have demonstrated that 24-hour treatment of 10,12 CLA increases PPAR γ phosphorylation [77] without significantly decreasing its protein levels, suggesting that the subsequent downregulation of PPAR γ target genes is due to decreased transactivating function. Intriguingly, robust extracellular signal-regulated kinase (ERK) phosphorylation is also observed 24 hours after CLA stimulation, suggesting a role for ERK in PPAR γ phosphorylation and inactivation. Consistent with these data, we demonstrated that ERK activation is a key player in CLA's suppression of adipogenic gene expression and insulin-stimulated glucose uptake [73]. Therefore, it is tempting to speculate that CLA antagonizes PPAR γ activity via activation of MAPKs like ERK, thereby leading to inhibition of PPAR γ target genes (Fig. 2).

Finally, CLA may interfere with PPAR γ activity by virtue of its proinflammatory effects in adipocytes (Fig. 3). We have shown that 10,12 CLA induces NF κ B activation in adipocytes, and that this induction leads to increased expression of proinflammatory cytokines [86, 87]. In addition, NF κ B or other proinflammatory transcription factors may interfere directly with PPAR γ activation of target genes (Fig. 1–Fig. 3). This will be discussed in more detail below.

2.3. CLA increases inflammation

Although the primary function of WAT is energy storage, it also has the ability to produce a number of pro-inflammatory cytokines. These adipokines (i.e., cytokines produced by adipose

tissue) can cause insulin resistance (Fig. 4), thereby suppressing lipid synthesis and increasing lipolysis in adipocytes (Fig. 5). Induction of these inflammatory genes is dependent on various cellular kinases including MAPK, and is driven by transcription factors like NF κ B, which have been reported to directly antagonize PPAR γ (Fig. 1–Fig. 3). Tumor necrosis factor (TNF) α in particular exerts potent antiadipogenic effects [88, 89], and interleukin (IL)-1 β and interferon (IFN) γ have been observed to induce delipidation of human adipocytes [90]. Treatment with 10,12 CLA has also been shown to increase the expression or secretion of IL-6 and IL-8 from murine [24, 50] and human [73, 77, 86] adipocyte cultures, as well as TNF α and IL-1 β suppressing PPAR γ activity and insulin sensitivity [32, 76, 77, 91].

In human subjects, 10,12 CLA supplementation also increases the levels of inflammatory prostaglandins (PG)s [58, 92]. For example, women supplemented with mixed CLA isomers (5.5 g/day for 16 weeks) exhibited higher levels of C-reactive protein in serum and the prostaglandin 8-iso-PGF $_{2\alpha}$ in urine [93]. Accordingly, the expression of cyclooxygenase 2 (COX-2), an enzyme involved in the synthesis of PGs, was elevated in cultures of newly differentiated human adipocytes treated with 10,12 CLA [71]. Furthermore, 10,12 CLA increased PGF $_{2\alpha}$ secretion from human adipocytes [87].

Inflammatory PGs like PGF $_{2\alpha}$ have been reported to inhibit adipogenesis via phosphorylation of PPAR γ by MAPKs [94], and via induction of the normoxic activation of the hypoxia inducible factor-1 (HIF-1). HIF-1 decreases PPAR γ and C/EBP α expression by upregulating transcriptional repressor DEC1 [95, 96]. In addition, PGF $_{2\alpha}$ may inhibit adipogenesis by inducing pro-inflammatory transcription factors that antagonize PPAR γ .

Notably, data from our laboratory show that ERK and NF κ B activation play a critical role in 10,12 CLA's suppression of adipogenic genes and insulin-stimulated glucose uptake [73, 86]. The molecular mechanisms by which NF κ B and other inflammatory transcription factors inhibit PPAR γ activity are not completely understood, but results from a study in the bone marrow stromal cell line ST2 suggest that NF κ B interacts directly with PPAR γ , preventing it from binding DNA [97, 98]. In a different study using chromatin immunoprecipitation, the DNA binding activity of PPAR γ did not appear to be affected by TNF α stimulation in 3T3-L1 adipocytes or human embryonic kidney 293 cells. Instead suppression of PPAR γ activity involved IKK activation, leading to I κ B α degradation and nuclear localization of histone deacetylase (HDAC)3, a component of the PPAR γ corepressor complex [99, 100]. NF κ B may also repress PPAR γ activity via interaction with the DNA-bound retinoid X receptor (RXR)-PPAR γ heterodimer, thereby interfering with coactivator recruitment.

Taken together, these data suggest that 10,12 CLA antagonizes PPAR γ activity via inflammatory mediators such as MAPKs and NF κ B, and/or via induction of the inflammatory PG and adipocytokine production that in turn antagonizes PPAR γ activity.

2.4. CLA regulation of lipid metabolism

CLA suppresses lipogenesis—Storage of FA as TG is a major function of adipocytes. Numerous proteins involved in lipogenesis, such as lipoprotein lipase (LPL), acetyl-CoA carboxylase (ACC), fatty acid synthase (FAS), and stearoyl-CoA desaturase (SCD), have been found to be decreased by supplementation with mixed isomers of CLA or 10,12 CLA alone [50, 72, 73, 101]. PPAR γ is a major activator of many lipogenic genes including glycerol-3-phosphate dehydrogenase (GPDH), LPL, and lipin, as well as many genes encoding lipid droplet-associated proteins such as perilipin, adipocyte differentiation-related protein (ADRP), cell death-inducing DFFA-like effector c (CIDEC), and S3-12 [102]. Thus, 10, 12 CLA may exert its anti-lipogenic effects, in part, through its ability to inhibit PPAR γ activity. CLA repression of the lipogenic transcription factor SREBP-1 and its target genes may also play an important role. Finally, CLA suppression of insulin signaling may also affect the activation or

abundance of a number of lipogenic proteins including LPL, ACC, FAS, SCD-1, and the insulin-dependent glucose transporter 4 (GLUT4).

Interestingly, 10,12 CLA or a CLA mixture have also been reported to reduce levels of monounsaturated FAs in rodents [27, 51] and in primary human adipocyte cultures [72]. This may be due to the ability of CLA to repress SCD1 expression [69] and function required for monounsaturated FA synthesis [103, 104]. However, 10,12 CLA supplementation was able to reduce body weight even in SCD-1 knockout mice, simultaneously increasing the ratio of 16:0/16:1 fatty acids and decreasing the ratio of 18:0/18:1 fatty acids [49]. These results suggest that the antiobesity properties of CLA may also rely on other desaturases, which may include the isoenzyme SCD-2. For instance, body fat loss in mice fed a CLA mixture has been shown to require $\Delta 6$ -desaturase [105].

CLA causes insulin resistance—Insulin-stimulated glucose uptake in WAT is mediated via GLUT4 (Fig. 4). Defects in insulin signaling or suppression of GLUT4 translocation to the plasma membrane are primary causes of insulin resistance in adipocytes (Fig. 4, 5). Insulin resistance has been reported in overweight or obese mice [50] or humans [92, 106–108] and in cultures of 3T3-L1 [71] or human adipocytes [72, 86, 87] following supplementation with a CLA mixture or 10,12 CLA alone. Moreover, supplementation with a CLA mixture or 10,12 CLA has been shown to induce hyperinsulinemia, associated with insulin resistance in animals and humans [reviewed in 13]. CLA may inhibit insulin signaling by 1) activating inflammatory pathways and stress kinases, and 2) downregulating expression of genes involved in the insulin signaling and glucose uptake pathways.

In addition, some studies in 3T3-L1 cells [24] and cultures of newly differentiated human adipocytes [71] have suggested that CLA inhibits insulin signaling via increased expression of suppressor of cytokine signaling (SOCS)-3. SOCS-3 impairs insulin signaling and glucose uptake by promoting the phosphorylation of the inhibitory serine 307 on insulin receptor substrate (IRS-1), leading to its ubiquitination and proteasome degradation [109]. CLA appears to induce SOCS-3 indirectly via inflammatory cytokines such as TNF α and IL-6 [73, 110]. 10,12 CLA treatment has also been demonstrated to decrease the protein levels of insulin receptor (IR) β [24] and IRS-1 [24, 86], signaling proteins critical for insulin sensitivity. In addition, 10,12 CLA treatment reduced tyrosine phosphorylation (i.e., activation) of insulin receptor (IR) β and IRS-1 in 3T3-L1 adipocytes [24].

10,12 CLA may also directly impair the uptake of glucose and fructose by suppressing the expression of their transporters. 10,12 CLA decreased GLUT4 gene and protein expression [71, 73, 86] in cultures of newly differentiated human adipocytes. In addition, CLA reduced the gene expression of GLUT4 and the glucose/fructose transporter SLC2A5 in WAT and 3T3-L1 adipocytes supplemented with 10,12 CLA [50].

CLA may also cause insulin resistance via its effects on the insulin-sensitizing hormone adiponectin. Adiponectin mRNA levels were decreased following supplementation with 10,12 CLA in mice [24] and in cultures of human adipocytes [73]. Consistent with these data, 10,12 CLA or a CLA mixture decreased adiponectin assembly or secretion in cultures of murine adipocytes, respectively [18, 112]. Because adiponectin is a target gene of PPAR γ [113], its suppression may be due, in part, to 10,12 CLA antagonizing PPAR γ activity. Accordingly, the PPAR γ agonist rosiglitazone was able to prevent CLA-induced suppression of adiponectin serum levels and insulin resistance in mice [95]. However, another PPAR γ agonist, troglitazone, did not prevent the 10,12 CLA suppression of adiponectin expression, although it prevented 10,12 CLA suppression of TG levels and adiponectin oligomer assembly in 3T3-L1 adipocytes [18]. These results indicate that CLA may also suppress adiponectin expression by a PPAR γ -independent mechanism.

CLA stimulates lipolysis—Lipolysis is the process by which stored TG is mobilized, releasing free fatty acids (FFA) and glycerol through the action of hormone-sensitive lipase (HSL). Typically, when energy demand is increased, lipolysis is upregulated via cAMP-mediated signaling. CLA may induce lipolysis in WAT through its activation of proinflammatory pathways, thereby liberating FFA for uptake in metabolically-active tissues (i.e., liver and muscle) (Fig. 5). Acute treatment with mixed CLA isomers or 10,12 CLA alone increased lipolysis in 3T3-L1 [19, 101, 114] and newly differentiated human adipocytes [115]. Furthermore, LaRosa et al. [50] observed increased mRNA levels of HSL in C57BL/6J mice fed 10,12 CLA for 3 days; however, HSL levels subsequently decreased following chronic (17 day) treatment.

Numerous studies in other species have investigated the effect of long-term CLA supplementation on lipolysis. Studies with mice or hamsters have demonstrated that chronic supplementation with a mixture of CLA has no effect on lipolysis [116, 117, 118]. In contrast chronic treatment with CLA (1–200 $\mu\text{mol/L}$ mixed isomers) reduced glycerol release from isolated rat adipocytes [112]. Consistent with these data, FFA levels have been reported to be lower in the serum of OLETF rats supplemented with a CLA mixture (1.0% (w/w) for 4 weeks) compared to controls [119]. The lack of a chronic lipolysis effect may be due to depleted TG stores in WAT, which can lead to ectopic lipid accumulation seen in lipodystrophy syndromes. For example, supplementation with a CLA mixture or 10,12 CLA alone was shown to increase lipid accumulation in the liver of mice [120, 121] and hamsters [122, 123]. In summary, CLA induces inflammatory adipokines that likely impair insulin signaling, thereby decreasing TG synthesis and increasing lipolysis, leading to decreased WAT mass (Fig. 5).

2.5. CLA regulation of apoptosis

CLA induces (pre)adipocyte apoptosis—Apoptosis is another mechanism by which CLA may be able to reduce BFM. Studies using mice [33, 34, 50] or 3T3-L1 murine adipocytes [52, 114] supplemented with 10,12 CLA or a CLA mixture have reported apoptosis in adipocytes. For example, mice fed a high-fat diet containing a 1.5% (w/w) CLA mixture had an increased ratio of BAX relative to Bcl2, an inducer and suppressor of apoptosis in the mitochondrial apoptotic pathway, respectively [76]. Furthermore, supplementation of C57BL/6J mice with a 1% (w/w) CLA mixture reduced BFM and increased apoptosis and TNF α gene expression in WAT [124]. TNF α gene expression and secretion have also been reported to be induced in mice by 10,12 CLA alone [16, 24]. TNF α is a potent inducer of apoptosis [125] and plays a critical role in adipocyte function [126]. TNF α gene expression was likewise induced by 10,12 CLA in cultures of newly differentiated human adipocytes, although its secretion was not detected [73, 91].

Besides the TNF α /death receptor and mitochondrial pathways, apoptosis can occur via activation of the integrated stress response (ISR) (Fig. 6). Microarray analysis revealed that 10,12 CLA treatment of mice [1% (w/w)] and 3T3-L1 adipocytes (100 $\mu\text{mol/L}$) increased the mRNA levels of genes involved in the ISR, such as activating transcription factor 3 (ATF3), C/EBP homologous protein (CHOP), pseudokinase Tribbles 3/SKIP 3 (TRIB3), X-box binding protein (XBP-1), and growth arrest and DNA damage inducible protein (GADD34) [75]. CHOP is known to possess apoptotic characteristics and activation of this protein can lead to induction of GADD34 and TRIB3 [127, 128]. Notably, CLA-induced ISR activation in adipocytes was preceded by the induction of inflammatory genes such as IL-6 and IL-8 [75]. In mouse mammary tumor cells, 10,12 CLA treatment (20–40 $\mu\text{mol/L}$) increased CHOP expression and ER stress leading to apoptosis [129, 130]. Collectively, these data suggest that CLA may induce adipocyte apoptosis via ER stress and the ISR, depending on the dose and isomer used. *In vivo* studies are needed to investigate whether the apoptotic effects of CLA in humans are specific to WAT.

3. Conclusion and Implications

Supplementation with a mixture of CLA isomers or 10,12 CLA alone reduces adiposity consistently in animal models, especially in rodents, but has been shown to reduce adiposity in only some human studies. Potential reasons for these species differences include 1) the CLA isomers used, 2) the dosage administered, and 3) age, body weight, body fat, or metabolic status of the animals or subjects. Of the major isomers, only 10,12 CLA reduces adiposity or TG content of WAT. Dosage differences among species can be considerable; rodent studies generally use ~20 times more CLA/kg body weight compared to human studies.

Potential mechanisms responsible for these antiobesity properties of 10,12 CLA include 1) decreasing energy intake by suppressing appetite 2) increasing energy expenditure in WAT, muscle, and liver tissue, or LBM, 3) decreasing lipogenesis or adipogenesis, 4) increasing lipolysis or delipidation, and 5) apoptosis via adipocyte stress, inflammation, and/or insulin resistance.

Based on these data, we propose the following working model (Fig. 7) depicting the mechanisms by which 10,12 CLA decreases WAT mass. We speculate that 10,12 CLA binds to a cell surface FA receptor, or diffuses or flip-flops into adipocytes, thereby activating upstream signals. These upstream signals induce an ISR, FFA release, and activation of NF κ B and MAPKs that may directly antagonize PPAR γ activity. Increased release of PGs and cytokines may further antagonize PPAR γ activity, leading to insulin resistance and delipidation. The resulting FFA accumulation in blood, liver, and muscle increases FFA oxidation and FFA-induced insulin resistance in these tissues. If energy expenditure is not sufficient to completely oxidize these elevated levels of FFAs, hyperlipidemia, hyperglycemia, and lipodystrophy can result.

Future studies are needed to identify potential upstream mediators of this proposed stress cascade in adipocytes. Elucidating these mechanisms will provide valuable information on the efficacy, specificity, and potential side effects of CLA isomers as dietary strategies for weight loss or maintenance. Such knowledge is essential for the effective and safe use of CLA supplements to control obesity.

Acknowledgments

Support provided by NIH R01 DK063070-07 to MKM and SM, and from the NIH F31DK076208 and the United Negro College Fund-Merck predoctoral fellowships to AK.

References

1. Pariza MW, Park Y, Cook ME. The biologically active isomers of conjugated linoleic acid. *Prog Lipid Res* 2001;40:283–298. [PubMed: 11412893]
2. Wallace RJ, McKain N, Shingfield KJ, Devillard E. Isomers of conjugated linoleic acids are synthesized via different mechanisms in ruminal digesta and bacteria. *J Lipid Res* 2007;48:2247–2254. [PubMed: 17644775]
3. Dhiman TR, Nam SH, Ure AL. Factors affecting conjugated linoleic acid content in milk and meat. *Crit Rev Food Sci Nutr* 2005;45:463–482. [PubMed: 16183568]
4. Silveira M, Carraro R, Monereo S, Tébar J. Conjugated linoleic acid (CLA) and obesity. *Public Health Nutr* 2007;10(10A):1181–1186. [PubMed: 17903328]
5. Mendis S, Cruz-Hernandez C, Ratnayake WM. Fatty acid profile of Canadian dairy products with special attention to the trans-octadecenoic acid and conjugated linoleic acid isomers. *J AOAC Int* 2008;91:811–819. [PubMed: 18727541]

6. Ritzenthaler KL, McGuire MK, Falen R, Schultz TD, Dasgupta N, McGuire MA. Estimation of conjugated linoleic acid intake by written dietary assessment methodologies underestimates actual intake evaluated by food duplicate methodology. *J Nutr* 2001;131:1548–1554. [PubMed: 11340114]
7. Mougios V, Matsakas A, Petridou A, Ring S, Sagredos A, Melissopoulou A, Tsigilis N, Nikolaidis M. Effect of supplementation with conjugated linoleic acid on human serum lipids and body fat. *J Nutr Biochem* 2001;12:585–594. [PubMed: 12031264]
8. Petridou A, Mougios V, Sagredos A. Supplementation with CLA: isomer incorporation into serum lipids and effect on body fat of women. *Lipids* 2003;38:805–811. [PubMed: 14577658]
9. Ha YL, Grimm NK, Pariza MW. Anticarcinogens from fried ground beef: heat-altered derivatives of linoleic acid. *Carcinogenesis* 1987;8:1881–1887. [PubMed: 3119246]
10. Mitchell PL, McLeod RS. Conjugated linoleic acid and atherosclerosis: studies in animal models. *Biochem Cell Biol* 2008;86:293–301. [PubMed: 18756324]
11. Whigham LD, Watras AC, Schoeller DA. Efficacy of conjugated linoleic acid for reducing fat mass: a meta-analysis in humans. *Am J Clin Nutr* 2007;85:1203–1211. [PubMed: 17490954]
12. CDC. Obesity- Halting the epidemic by making health easier- At a Glance 2009 [Internet]. Atlanta: Centers for Disease Control and Prevention; c2009. [cited 2009 April 24]. Available from <http://www.cdc.gov/NCCDphp/publications/AAG/obesity.htm#aag>
13. Wang YW, Jones PJ. Conjugated linoleic acid and obesity control: efficacy and mechanisms. *Int J Obes Relat Metab Disord* 2004;28:941–955. [PubMed: 15254484]
14. Park Y, Storkson J, Albright K, Liu W, Pariza M. Evidence that trans-10, cis-12 isomer of conjugated linoleic acid induces body composition changes in mice. *Lipids* 1999;34:235–241. [PubMed: 10230716]
15. Brown JM, Halverson YD, Lea-Currie R, Geigerman C, McIntosh M. Trans-10, cis-12, but not cis-9, trans-11, conjugated linoleic acid attenuates lipogenesis in primary cultures of stromal vascular cells from human adipose tissue. *J Nutr* 2001;131:2316–2321. [PubMed: 11533273]
16. House RL, Cassady JP, Eisen EJ, McIntosh MK, Odle J. Conjugated linoleic acid evokes delipidation through the regulation of genes controlling lipid metabolism in adipose and liver tissue. *Obes Rev* 2005;6:247–258. [PubMed: 16045640]
17. Brandebourg TD, Hu CY. Isomer-specific regulation of differentiating pig preadipocytes by conjugated linoleic acids. *J Anim Sci* 2005;83:2096–2105. [PubMed: 16100064]
18. Miller JR, Siripurkpong P, Hawes J, Majdalawieh A, Ro HS, McLeod RS. The trans-10, cis-12 isomer of conjugated linoleic acid decreases adiponectin assembly by PPARgamma-dependent and PPARgamma-independent mechanisms. *J Lipid Res* 2008;49:550–562. [PubMed: 18056926]
19. Park Y, Albright KJ, Liu W, Storkson JM, Cook ME, Pariza MW. Effect of conjugated linoleic acid on body composition in mice. *Lipids* 1997;32:853–858. [PubMed: 9270977]
20. Sisk MB, Hausman DB, Martin RJ, Azain MJ. Dietary conjugated linoleic acid reduces adiposity in lean but not obese Zucker rats. *J Nutr* 2001;131:1668–1674. [PubMed: 11385051]
21. Clement L, Poirier H, Niot I, Bocher V, Guerre-Millo M, Krief S, Staels B, Besnard P. Dietary trans-10,cis-12 conjugated linoleic acid induces hyperinsulinemia and fatty liver in the mouse. *J Lipid Res* 2002;43:1400–1409. [PubMed: 12235171]
22. Meadus WJ, MacInnis R, Dugan M. Prolonged dietary treatment with conjugated linoleic acid stimulates porcine muscle peroxisome proliferator activated receptor gamma and glutamine-fructose aminotransferase gene expression in vivo. *J Mol Endocrinol* 2002;28:79–86. [PubMed: 11932205]
23. Yamasaki M, Ikeda A, Oji M, Tanaka Y, Hirao A, Kasai M, Iwata T, Tachibana H, Yamada K. Modulation of body fat and serum leptin levels by dietary conjugated linoleic acid in Sprague-Dawley rats fed various fat-level diets. *Nutrition* 2003;19:30–35. [PubMed: 12507636]
24. Poirier H, Shapiro JS, Kim RJ, Lazar MA. Nutritional supplementation with trans-10,cis-12 conjugated linoleic acid induces inflammation of white adipose tissue. *Diabetes* 2006;55:1634–1640. [PubMed: 16731825]
25. Poirier H, Rouault C, Clement L, Niot I, Monnot M, Guerre-Millo M, Besnard P. Hyperinsulinemia triggered by dietary conjugated linoleic acid is associated with a decrease in leptin and adiponectin plasma levels and pancreatic beta cell hyperplasia in the mouse. *Diabetologia* 2005;48:1059–1065. [PubMed: 15868135]

26. Wendel AA, Purushotham A, Liu LF, Belury MA. Conjugated linoleic acid fails to worsen insulin resistance but induces hepatic steatosis in the presence of leptin in ob/ob mice. *J Lipid Res* 2008;49:98–106. [PubMed: 17906221]
27. House RL, Cassady JP, Eisen EJ, Eling TE, Collins JB, Grissom SF, Odle J. Functional genomic characterization of delipidation elicited by trans-10, cis-12-conjugated linoleic acid (t10c12-CLA) in a polygenic obese line of mice. *Physiol Genomics* 2005;21:351–361. [PubMed: 15888570]
28. Gaullier JM, Halse J, Høivik HO, Høye K, Syvertsen C, Nurminiemi M, Hassfeld C, Einerhand A, O'Shea M, Gudmundsen O. Six months supplementation with conjugated linoleic acid induces regional-specific fat mass decreases in overweight and obese. *Br J Nutr* 2007;97:550–560. [PubMed: 17313718]
29. Nazare JA, de la Perrière AB, Bonnet F, Desage M, Peyrat J, Maitrepierre C, Louche-Pelissier C, Bruzeau J, Goudable J, Lassel T, Vidal H, Laville M. Daily intake of conjugated linoleic acid-enriched yoghurts: effects on energy metabolism and adipose tissue gene expression in healthy subjects. *Br J Nutr* 2007;97:273–280. [PubMed: 17298695]
30. Larsen TM, Toubro S, Gudmundsen O, Astrup A. Conjugated linoleic acid supplementation for 1 y does not prevent weight or body fat regain. *Am J Clin Nutr* 2006;83:606–612. [PubMed: 16522907]
31. Laso N, Brugué E, Vidal J, Ros E, Arnaiz JA, Carné X, Vidal S, Mas S, Deulofeu R, Lafuente A. Effects of milk supplementation with conjugated linoleic acid (isomers cis-9, trans-11 and trans-10, cis-12) on body composition and metabolic syndrome components. *Br J Nutr* 2007;98:860–867. [PubMed: 17623486]
32. Purushotham A, Wendel AA, Liu L, Belury MA. Maintenance of adiponectin attenuates insulin resistance induced by dietary conjugated linoleic acid in mice. *J Lipid Res* 2007;48:444–452. [PubMed: 17050906]
33. Miner JL, Cederberg CA, Nielsen MK, Chen X, Baile CA. Conjugated linoleic acid (CLA), body fat, and apoptosis. *Obes Res* 2001;9:129–134. [PubMed: 11316347]
34. Hargrave KM, Li C, Meyer BJ, Kachman SD, Hartzell DL, Della-Fera MA, Miner JL, Baile CA. Adipose depletion and apoptosis induced by trans-10, cis-12 conjugated linoleic Acid in mice. *Obes Res* 2002;10:1284–1290. [PubMed: 12490673]
35. Takahashi Y, Kushiro M, Shinohara K, Ide T. Dietary conjugated linoleic acid reduces body fat mass and affects gene expression of proteins regulating energy metabolism in mice. *Comp Biochem Physiol B Biochem Mol Biol* 2002;133:395–404. [PubMed: 12431407]
36. So MH, Tse IM, Li ET. Dietary fat concentration influences the effects of trans-10, cis-12 conjugated linoleic acid on temporal patterns of energy intake and hypothalamic expression of appetite-controlling genes in mice. *J Nutr* 2009;139:145–151. [PubMed: 19056663]
37. Zambell KL, Keim NL, Van Loan MD, Gale B, Benito P, Kelley DS, Nelson GJ. Conjugated linoleic acid supplementation in humans: effects on body composition and energy expenditure. *Lipids* 2000;35:777–782. [PubMed: 10941879]
38. Medina EA, Horn WF, Keim NL, Havel PJ, Benito P, Kelley DS, Nelson GJ, Erickson KL. Conjugated linoleic acid supplementation in humans: effects on circulating leptin concentrations and appetite. *Lipids* 2000;35:783–788. [PubMed: 10941880]
39. Lambert EV, Goedecke JH, Bluett K, Heggie K, Claassen A, Rae DE, West S, Dugas J, Dugas L, Meltzer S, Charlton K, Mohede I. Conjugated linoleic acid versus high-oleic acid sunflower oil: effects on energy metabolism, glucose tolerance, blood lipids, appetite and body composition in regularly exercising individuals. *Br J Nutr* 2007;97:1001–1011. [PubMed: 17381964]
40. Tholstrup T, Raff M, Straarup EM, Lund P, Basu S, Bruun JM. An oil mixture with trans-10, cis-12 conjugated linoleic acid increases markers of inflammation and in vivo lipid peroxidation compared with cis-9, trans-11 conjugated linoleic acid in postmenopausal women. *J Nutr* 2008;138:1445–1451. [PubMed: 18641189]
41. Cao ZP, Wang F, Xiang XS, Cao R, Zhang WB, Gao SB. Intracerebroventricular administration of conjugated linoleic acid (CLA) inhibits food intake by decreasing gene expression of NPY and AgRP. *Neurosci Lett* 2007;418:217–221. [PubMed: 17466453]
42. Azain MJ, Hausman DB, Sisk MB, Flatt WP, Jewell DE. Dietary conjugated linoleic acid reduces rat adipose tissue cell size rather than cell number. *J Nutr* 2000;130:1548–1554. [PubMed: 10827208]

43. West DB, Blohm FY, Truett AA, DeLany JP. Conjugated linoleic acid persistently increases total energy expenditure in AKR/J mice without increasing uncoupling protein gene expression. *J Nutr* 2000;130:2471–2477. [PubMed: 11015475]
44. Terpstra AH, Beynen AC, Everts H, Kocsis S, Katan MB, Zock PL. The decrease in body fat in mice fed conjugated linoleic acid is due to increases in energy expenditure and energy loss in the excreta. *J Nutr* 2002;132:940–945. [PubMed: 11983818]
45. Terpstra AH, Javadi M, Beynen AC, Kocsis S, Lankhorst AE, Lemmens AG, Mohede IC. Dietary conjugated linoleic acids as free fatty acids and triacylglycerols similarly affect body composition and energy balance in mice. *J Nutr* 2003;133:3181–3186. [PubMed: 14519807]
46. Ohnuki K, Haramizu S, Oki K, Ishihara K, Fushiki T. A single oral administration of conjugated linoleic acid enhanced energy metabolism in mice. *Lipids* 2001;36:583–587. [PubMed: 11485161]
47. Nagao K, Wang YM, Inoue N, Han SY, Buang Y, Noda T, Kouda N, Okamatsu H, Yanagita T. The 10trans, 12cis isomer of conjugated linoleic acid promotes energy metabolism in OLETF rats. *Nutrition* 2003;19:652–656. [PubMed: 12831953]
48. Ealey KN, El-Sohemy A, Archer MC. Effects of dietary conjugated linoleic acid on the expression of uncoupling proteins in mice and rats. *Lipids* 2002;37:853–861. [PubMed: 12458620]
49. Kang K, Miyazaki M, Ntambi JM, Pariza MW. Evidence that the antiobesity effect of conjugated linoleic acid is independent of effects on stearoyl-CoA desaturase1 expression and enzyme activity. *Biochem Biophys Res Commun* 2004;315:532–537. [PubMed: 14975733]
50. LaRosa PC, Miner J, Xia Y, Zhou Y, Kachman S, Fromm ME. Trans-10, cis-12 conjugated linoleic acid causes inflammation and delipidation of white adipose tissue in mice: a microarray and histological analysis. *Physiol Genomics* 2006;27:282–294. [PubMed: 16868072]
51. Martin JC, Grégoire S, Siess MH, Genty M, Chardigny JM, Berdeaux O, Juanéda P, Sébédio JL. Effects of conjugated linoleic acid isomers on lipid-metabolizing enzymes in male rats. *Lipids* 2000;35:91–98. [PubMed: 10695929]
52. Evans M, Geigerman C, Cook J, Curtis L, Kuebler B, McIntosh M. Conjugated linoleic acid suppresses triglyceride accumulation and induces apoptosis in 3T3-L1 preadipocytes. *Lipids* 2000;35:899–910. [PubMed: 10984113]
53. Roche HM, Noone E, Sewter C, Mc Bennett S, Savage D, Gibney MJ, O’Rahilly S, Vidal-Puig AJ. Isomer-dependent metabolic effects of conjugated linoleic acid: insights from molecular markers sterol regulatory element-binding protein-1c and LXRA. *Diabetes* 2002;51:2037–2044. [PubMed: 12086931]
54. Choi JS, Koh IU, Jung MH, Song J. Effects of three different conjugated linoleic acid preparations on insulin signalling, fat oxidation and mitochondrial function in rats fed a high-fat diet. *Br J Nutr* 2007;98:264–275. [PubMed: 17408517]
55. Ribot J, Portillo MP, Picó C, Macarulla MT, Palou A. Effects of trans-10, cis-12 conjugated linoleic acid on the expression of uncoupling proteins in hamsters fed an atherogenic diet. *Br J Nutr* 2007;97:1074–1082. [PubMed: 17381975]
56. Priore P, Giudetti AM, Natali F, Gnoni GV, Geelen MJ. Metabolism and short-term metabolic effects of conjugated linoleic acids in rat hepatocytes. *Biochim Biophys Acta* 2007;1771:1299–1307. [PubMed: 17905647]
57. Ferramosca A, Savy V, Conte L, Zara V. Dietary combination of conjugated linoleic acid (CLA) and pine nut oil prevents CLA-induced fatty liver in mice. *J Agric Food Chem* 2008;56:8148–8158. [PubMed: 18702470]
58. Steck SE, Chalecki AM, Miller P, Conway J, Austin GL, Hardin JW, Albright CD, Thuillier P. Conjugated linoleic acid supplementation for twelve weeks increases lean body mass in obese humans. *J Nutr* 2007;137:1188–1193. [PubMed: 17449580]
59. Kamphuis MM, Lejeune MP, Saris WH, Westerterp-Plantenga MS. The effect of conjugated linoleic acid supplementation after weight loss on body weight regain, body composition, and resting metabolic rate in overweight subjects. *Int J Obes Relat Metab Disord* 2003;27:840–847. [PubMed: 12821971]
60. Close RN, Schoeller DA, Watras AC, Nora EH. Conjugated linoleic acid supplementation alters the 6-mo change in fat oxidation during sleep. *Am J Clin Nutr* 2007;86:797–804. [PubMed: 17823448]

61. Bhattacharya A, Rahman MM, Sun D, Lawrence R, Mejia W, McCarter R, O'Shea M, Fernandes G. The combination of dietary conjugated linoleic acid and treadmill exercise lowers gain in body fat mass and enhances lean body mass in high fat-fed male Balb/C mice. *J Nutr* 2005;135:1124–1130. [PubMed: 15867292]
62. Rahman MM, Bhattacharya A, Banu J, Fernandes G. Conjugated linoleic acid protects against age-associated bone loss in C57BL/6 female mice. *J Nutr Biochem* 2007;18:467–474. [PubMed: 16997541]
63. Banu J, Bhattacharya A, Rahman M, O'Shea M, Fernandes G. Effects of conjugated linoleic acid and exercise on bone mass in young male Balb/C mice. *Lipids Health Dis* 2006;5:7. [PubMed: 16556311]
64. Banu J, Bhattacharya A, Rahman M, Fernandes G. Beneficial effects of conjugated linoleic acid and exercise on bone of middle-aged female mice. *J Bone Miner Metab* 2008;26:436–445. [PubMed: 18758901]
65. Platt ID, El-Sohehy A. Regulation of osteoblast and adipocyte differentiation from human mesenchymal stem cells by conjugated linoleic acid. *J Nutr Biochem*. Forthcoming. 2008
66. Roy BD, Bourgeois J, Rodriguez C, Payne E, Young K, Shaughnessy SG, Tarnopolsky MA. Conjugated linoleic acid prevents growth attenuation induced by corticosteroid administration and increases bone mineral content in young rats. *Appl Physiol Nutr Metab* 2008;33:1096–1104. [PubMed: 19088767]
67. Brodie AE, Manning VA, Ferguson KR, Jewell DE, Hu CY. Conjugated linoleic acid inhibits differentiation of pre- and post- confluent 3T3-L1 preadipocytes but inhibits cell proliferation only in confluent cells. *J Nutr* 1999;129:602–606. [PubMed: 10082762]
68. Satory DL, Smith SB. Conjugated linoleic acid inhibits proliferation but stimulates lipid filling of murine 3T3-L1 preadipocytes. *J Nutr* 1999;129:92–97. [PubMed: 9915881]
69. Choi Y, Kim YC, Han YB, Park Y, Pariza MW, Ntambi JM. The trans-10,cis-12 isomer of conjugated linoleic acid downregulates stearoyl-CoA desaturase 1 gene expression in 3T3-L1 adipocytes. *J Nutr* 2000;130:1920–1924. [PubMed: 10917902]
70. Granlund L, Juvet LK, Pedersen JI, Nebb HI. Trans10, cis12-conjugated linoleic acid prevents triacylglycerol accumulation in adipocytes by acting as a PPARgamma modulator. *J Lipid Res* 2003;44:1441–1452. [PubMed: 12754280]
71. Kang K, Liu W, Albright KJ, Park Y, Pariza MW. Trans-10,cis-12 CLA inhibits differentiation of 3T3-L1 adipocytes and decreases PPAR gamma expression. *Biochem Biophys Res Commun* 2003;303:795–799. [PubMed: 12670481]
72. Brown M, Sandberg-Boysen M, Skov S, Morrison R, Storkson J, Lea-Currie R, Pariza M, Mandrup S, McIntosh M. Isomer-specific regulation of metabolism and PPAR γ by conjugated linoleic acid (CLA) in human preadipocytes. *J Lipid Res* 2003;44:1287–1300. [PubMed: 12730300]
73. Brown J, Boysen M, Chung S, Fabiyi O, Morrison R, Mandrup S, McIntosh M. Conjugated linoleic acid (CLA) induces human adipocyte delipidation: autocrine/ paracrine regulation of MEK/ERK signaling by adipocytokines. *J Biol Chem* 2004;279:26735–26747. [PubMed: 15067015]
74. Granlund L, Pedersen JI, Nebb HI. Impaired lipid accumulation by trans10, cis12 CLA during adipocyte differentiation is dependent on timing and length of treatment. *Biochim Biophys Acta* 2005;1687:11–22. [PubMed: 15708349]
75. LaRosa PC, Riethoven JJ, Chen H, Xia Y, Zhou Y, Chen M, Miner J, Fromm ME. Trans-10, cis-12 conjugated linoleic acid activates the integrated stress response pathway in adipocytes. *Physiol Genomics* 2007;31:544–553. [PubMed: 17878318]
76. Liu LF, Purushotham A, Wendel AA, Belury MA. Combined effects of rosiglitazone and conjugated linoleic acid on adiposity, insulin sensitivity, and hepatic steatosis in high-fat-fed mice. *Am J Physiol Gastrointest Liver Physiol* 2007;292:G1671–G1682. [PubMed: 17322064]
77. Kennedy A, Chung S, LaPoint K, Fabiyi O, McIntosh MK. Trans-10, cis-12 conjugated linoleic acid antagonizes ligand-dependent PPARgamma activity in primary cultures of human adipocytes. *J Nutr* 2008;138:455–461. [PubMed: 18287349]
78. Yu Y, Correll PH, Vanden Heuvel JP. Conjugated linoleic acid decreases production of pro-inflammatory products in macrophages: evidence for a PPAR gamma-dependent mechanism. *Biochim Biophys Acta* 2002;1581:89–99. [PubMed: 12020636]

79. Hu E, Kim JB, Sarraf P, Spiegelman BM. Inhibition of adipogenesis through MAP kinase-mediated phosphorylation of PPAR γ . *Science* 1996;274:2100–2103. [PubMed: 8953045]
80. Adams M, Reginato MJ, Shao D, Lazar MA, Chatterjee VK. Transcriptional activation by peroxisome proliferator-activated receptor γ is inhibited by phosphorylation at a consensus mitogen-activated protein kinase site. *J Biol Chem* 1997;272:5128–5132. [PubMed: 9030579]
81. Camp HS, Tafuri SR, Leff T. c-Jun N-terminal kinase phosphorylates peroxisome proliferator-activated receptor- γ 1 and negatively regulates its transcriptional activity. *Endocrinology* 1999;140:392–397. [PubMed: 9886850]
82. Floyd ZE, Stephens JM. Interferon- γ -mediated activation and ubiquitin-proteasomedependent degradation of PPAR γ in adipocytes. *J Biol Chem* 2002;277:4062–4068. [PubMed: 11733495]
83. Shao DL, Rangwala SM, Bailey ST, Krakow SL, Reginato MJ, Lazar MA. Interdomain communication regulating ligand binding by PPAR γ . *Nature* 1998;396:377–380. [PubMed: 9845075]
84. Diradourian C, Girard J, Pégrier JP. Phosphorylation of PPARs: from molecular characterization to physiological relevance. *Biochimie* 2005;87:33–38. [PubMed: 15733734]
85. Burns KA, Vanden Heuvel JP. Modulation of PPAR activity via phosphorylation. *Biochim Biophys Acta* 2007;1771:952–960. [PubMed: 17560826]
86. Chung S, Brown JM, Provo JN, Hopkins R, McIntosh MK. Conjugated linoleic acid promotes human adipocyte insulin resistance through NF κ B-dependent cytokine production. *J Biol Chem* 2005;280:38445–38456. [PubMed: 16155293]
87. Kennedy A, Overman A, Lapoint K, Hopkins R, West T, Chuang CC, Martinez K, Bell D, McIntosh M. Conjugated linoleic acid-mediated inflammation and insulin resistance in human adipocytes are attenuated by resveratrol. *J Lipid Res* 2009;50:225–232. [PubMed: 18776171]
88. Kawakami M, Murase T, Ogawa H, Ishibashi S, Mori N, Takaku F, Shibata S. Human recombinant TNF suppresses lipoprotein lipase activity and stimulates lipolysis in 3T3-L1 cells. *J Biochem* 1987;101:331–338. [PubMed: 3495531]
89. Petruschke T, Hauner H. Tumor necrosis factor- α prevents the differentiation of human adipocyte precursor cells and causes delipidation of newly developed fat cells. *J Clin Endocrinol Metab* 1993;76:742–747. [PubMed: 8445033]
90. Simons PJ, van den Pangaart PS, Aerts JM, Boon L. Pro-inflammatory delipidizing cytokines reduce adiponectin secretion from human adipocytes without affecting adiponectin oligomerization. *J Endocrinol* 2007;192:289–299. [PubMed: 17283229]
91. Chung S, Lapoint K, Martinez K, Kennedy A, Boysen Sandberg M, McIntosh MK. Preadipocytes mediate lipopolysaccharide-induced inflammation and insulin resistance in primary cultures of newly differentiated human adipocytes. *Endocrinology* 2006;147:5340–5351. [PubMed: 16873530]
92. Risérus U, Arner P, Brismar K, Vessby B. Treatment with dietary trans-10,cis-12 conjugated linoleic acid causes isomer-specific insulin resistance in obese men with the metabolic syndrome. *Diabetes Care* 2002;25:1516–1521. [PubMed: 12196420]
93. Tholstrup T, Raff M, Straarup EM, Lund P, Basu S, Bruun JM. An oil mixture with trans-10, cis-12 conjugated linoleic acid increases markers of inflammation and in vivo lipid peroxidation compared with cis-9, trans-11 conjugated linoleic acid in postmenopausal women. *J Nutr* 2008;138:1445–1451. [PubMed: 18641189]
94. Reginato MJ, Krakow SL, Bailey ST, Lazar MA. Prostaglandins promote and block adipogenesis through opposing effects on peroxisome proliferator-activated receptor γ . *J Biol Chem* 1998;273:1855–1858. [PubMed: 9442016]
95. Liu L, Clipstone N. Prostaglandin F $_{2\alpha}$ inhibits adipocyte differentiation via a G α qcalcium-calcineurin-dependent signaling pathway. *J Cell Biochem* 2007;100:161–173. [PubMed: 16888802]
96. Liu L, Clipstone N. Prostaglandin F $_{2\alpha}$ induces the normoxic activation of the hypoxia-inducible factor-1 transcription factor in differentiating 3T3-L1 preadipocytes: potential role in the regulation of adipogenesis. *J Cell Biochem* 2008;105:89–98. [PubMed: 18461556]
97. Suzawa M, Takada I, Yanagisawa J, Ohtake F, Ogawa S, Yamauchi T, Kadowaki T, Takeuchi Y, Shibuya H, Gotoh Y, Matsumoto K, Kato S. Cytokines suppress adipogenesis and PPAR- γ function through the TAK1/TAB1/NIK cascade. *Nat Cell Biol* 2003;5:224–230. [PubMed: 12598905]

98. Takada I, Suzawa M, Kato S. Nuclear receptors as targets for drug development: crosstalk between peroxisome proliferator-activated receptor gamma and cytokines in bone marrow-derived mesenchymal stem cells. *J Pharmacol Sci* 2005;97:184–189. [PubMed: 15725700]
99. Gao Z, Chiao P, Zhang X, Lazar M, Seto E, Young H, Ye J. Coactivators and corepressors of NF- κ B in IkB α gene promoter. *J Biol Chem* 2005;280:21091–21098. [PubMed: 15811852]
100. Ye J. Regulation of PPAR γ function by TNF- α . *Biochem Biophys Res Commun* 2008;374:405–408. [PubMed: 18655773]
101. Evans M, Lin X, Odle J, McIntosh M. Trans-10, cis-12 conjugated linoleic acid increases fatty acid oxidation in 3T3-L1 preadipocytes. *J Nutr* 2002;132:450–455. [PubMed: 11880570]
102. Neilson R, Pedersen T, Hagenbeek D, Moulos P, Sierbaek R, Megens E, Denissov S, Borgesen M, Francoijs K, Mandrup S, Stunnenberg H. Genome-wide profiling of PPAR γ :RXR and RNA polymerase II occupancy reveals temporal activation of distinct metabolic pathways and changes in RXR dimer composition during adipogenesis. *Genes Dev* 2008;22:2953–2967. [PubMed: 18981474]
103. Park Y, Storkson JM, Ntambi JM, Cook ME, Sih CJ, Pariza MW. Inhibition of hepatic stearyl-CoA desaturase activity by trans-10, cis-12 conjugated linoleic acid and its derivatives. *Biochim Biophys Acta* 2000;1486:285–292. [PubMed: 10903479]
104. Choi Y, Park Y, Pariza MW, Ntambi JM. Regulation of stearyl-CoA desaturase activity by the trans-10, cis-12 isomer of conjugated linoleic acid in HepG2 cells. *Biochem Biophys Res Commun* 2001;284:689–693. [PubMed: 11396956]
105. Hargrave-Barnes KM, Azain MJ, Miner JL. Conjugated linoleic acid-induced fat loss dependence on Delta6-desaturase or cyclooxygenase. *Obesity* 2008;16:2245–2252. [PubMed: 18719641]
106. Moloney F, Yeow TP, Mullen A, Nolan JJ, Roche HM. Conjugated linoleic acid supplementation, insulin sensitivity, and lipoprotein metabolism in patients with type 2 diabetes mellitus. *Am J Clin Nutr* 2004;80:887–895. [PubMed: 15447895]
107. Thrush AB, Chabowski A, Heigenhauser GJ, McBride BW, Or-Rashid M, Dyck DJ. Conjugated linoleic acid increases skeletal muscle ceramide content and decreases insulin sensitivity in overweight, non-diabetic humans. *Appl Physiol Nutr Metab* 2007;32:372–382. [PubMed: 17510671]
108. Ingelsson E, Risérus U. Effects of trans-10, cis-12 CLA-induced insulin resistance on retinol-binding protein 4 concentrations in abdominally obese men. *Diabetes Res Clin Pract* 2008;82:e23–e24. [PubMed: 18980783]
109. Ueki K, Kondo T, Kahn CR. Suppressor of cytokine signaling 1 (SOCS-1) and SOCS-3 cause insulin resistance through inhibition of tyrosine phosphorylation of insulin receptor substrate proteins by discrete mechanisms. *Mol Cell Biol* 2004;24:5434–5446. [PubMed: 15169905]
110. Shi H, Cave B, Inouye K, Bjorbaek C, Flier J. Overexpression of suppressor of cytokine signaling in adipose tissue causes local but not systemic insulin resistance. *Diabetes* 2006;55:699–707. [PubMed: 16505233]
111. Ahn IS, Choi BH, Ha JH, Byun JM, Shin HG, Park KY, Do MS. Isomer-specific effect of conjugated linoleic acid on inflammatory adipokines associated with fat accumulation in 3T3-L1 adipocytes. *J Med Food* 2006;9:307–312. [PubMed: 17004891]
112. Pérez-Matute P, Marti A, Martínez JA, Fernández-Otero MP, Stanhope KL, Havel PJ, Moreno-Aliaga MJ. Conjugated linoleic acid inhibits glucose metabolism, leptin and adiponectin secretion in primary cultured rat adipocytes. *Mol Cell Endocrinol* 2007;268:50–58. [PubMed: 17321040]
113. Iwaki M, Matsuda M, Maeda N, Funahashi T, Matsuzawa Y, Makishima M, Shimomura I. Induction of adiponectin, a fat-derived antidiabetic and antiatherogenic factor, by nuclear receptors. *Diabetes* 2003;52:1655–1663. [PubMed: 12829629]
114. Moon HS, Lee HG, Seo JH, Chung CS, Kim TG, Kim IY, Lim KW, Seo SJ, Choi YJ, Cho CS. Down-regulation of PPAR γ 2-induced adipogenesis by PEGylated conjugated linoleic acid as the pro-drug: Attenuation of lipid accumulation and reduction of apoptosis. *Arch Biochem Biophys* 2006;456:19–29. [PubMed: 17084379]
115. Chung S, Brown JM, McIntosh M. Trans-10, cis-12 CLA increases adipocyte lipolysis and alters lipid droplet-associated proteins: role of mTOR and ERK signaling. *J Lipid Res* 2005;46:885–895. [PubMed: 15716587]

116. Xu X, Storkson J, Kim S, Sugimoto K, Park Y, Pariza MW. Short-term intake of conjugated linoleic acid inhibits lipoprotein lipase and glucose metabolism but does not enhance lipolysis in mouse adipose tissue. *J Nutr* 2003;133:663–667. [PubMed: 12612134]
117. Simón E, Macarulla MT, Fernández-Quintela A, Rodríguez VM, Portillo MP. Body fat-lowering effect of conjugated linoleic acid is not due to increased lipolysis. *J Physiol Biochem* 2005;61:363–369. [PubMed: 16180334]
118. Lasa A, Churruga I, Simón E, Fernández-Quintela A, Rodríguez VM, Portillo MP. Trans-10, cis-12-conjugated linoleic acid does not increase body fat loss induced by energy restriction. *Br J Nutr* 2008;100:1245–1250. [PubMed: 18507880]
119. Rahman SM, Wang Y, Yotsumoto H, Cha J, Han S, Inoue S, Yanagita T. Effects of conjugated linoleic acid on serum leptin concentration, body-fat accumulation, and beta-oxidation of fatty acid in OLETF rats. *Nutrition* 2001;17:385–390. [PubMed: 11377131]
120. Andreoli MF, Gonzalez MA, Martinelli MI, Mocchiutti NO, Bernal CA. Effects of dietary conjugated linoleic acid at high-fat levels on triacylglycerol regulation in mice. *Nutrition* 2009;25:445–452. [PubMed: 19091510]
121. Oikawa D, Tsuyama S, Akimoto Y, Mizobe Y, Furuse M. Arachidonic acid prevents fatty liver induced by conjugated linoleic acid in mice. *Br J Nutr* 2008;24:1–6.
122. Tarling EJ, Ryan KJ, Bennett AJ, Salter AM. Effect of dietary conjugated linoleic acid isomers on lipid metabolism in hamsters fed high-carbohydrate and high-fat diets. *Br J Nutr* 2008;5:1–9.
123. Navarro V, Portillo MP, Margotat A, Landrier JF, Macarulla MT, Lairon D, Martin JC. A multi-gene analysis strategy identifies metabolic pathways targeted by trans-10, cis-12-conjugated linoleic acid in the liver of hamsters. *Br J Nutr* 2009;16:1–9.
124. Tsuboyama-Kasaoka N, Takahashi M, Tanemura K, Kim HJ, Tange T, Okuyama H, Kasai M, Ikemoto S, Ezaki O. Conjugated linoleic acid supplementation reduces adipose tissue by apoptosis and develops lipodystrophy in mice. *Diabetes* 2000;49:1534–1542. [PubMed: 10969838]
125. Wang CY, Mayo MW, Baldwin AS Jr. TNF- and cancer therapy-induced apoptosis: potentiation by inhibition of NF-kappaB. *Science* 1996;274:784–787. [PubMed: 8864119]
126. Cawthorn WP, Heyd F, Hegyi K, Sethi JK. Tumour necrosis factor-alpha inhibits adipogenesis via a beta-catenin/TCF4(TCF7L2)-dependent pathway. *Cell Death Differ* 2007;14:1361–1373. [PubMed: 17464333]
127. Ohoka N, Yoshii S, Hattori T, Onozaki K, Hayashi H. TRB3, a novel ER stress-inducible gene, is induced via ATF4-CHOP pathway and is involved in cell death. *Embo J* 2005;24:1243–1255. [PubMed: 15775988]
128. Szegezdi E, Duffy A, O'Mahoney ME, Logue SE, Mylotte LA, O'Brien T, Samali A. ER stress contributes to ischemia-induced cardiomyocyte apoptosis. *Biochem Biophys Res Commun* 2006;349:1406–1411. [PubMed: 16979584]
129. Ou L, Wu Y, Ip C, Meng X, Hsu YC, Ip MM. Apoptosis induced by t10,c12-conjugated linoleic acid is mediated by an atypical endoplasmic reticulum stress response. *J Lipid Res* 2008;49:985–994. [PubMed: 18263853]
130. Ip MM, Masso-Welch PA, Shoemaker SF, Shea-Eaton WK, Ip C. Conjugated linoleic acid inhibits proliferation and induces apoptosis of normal rat mammary epithelial cells in primary culture. *Exp Cell Res* 1999;250:22–34. [PubMed: 10388518]

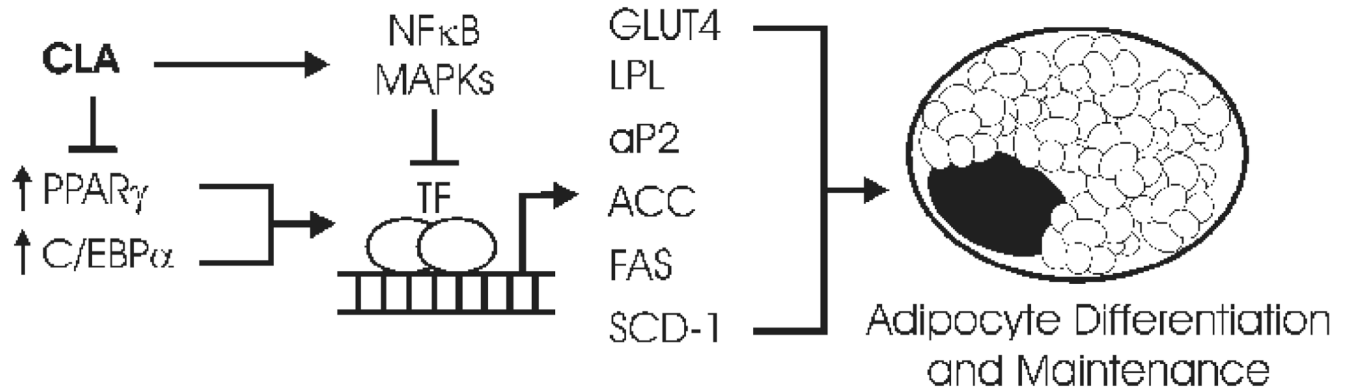

Figure 1.

10,12 CLA antagonizes the expression and activity of PPAR γ and C/EBP α , master regulators of adipocyte differentiation and maintenance. We propose that 10,12 CLA impairs preadipocyte differentiation and maintenance of mature adipocytes by 1) decreasing the expression of PPAR γ and C/EBP α , and 2) activating inflammatory proteins like NF κ B and MAPKs that antagonize PPAR γ activity, thereby reducing the expression of PPAR γ target genes.

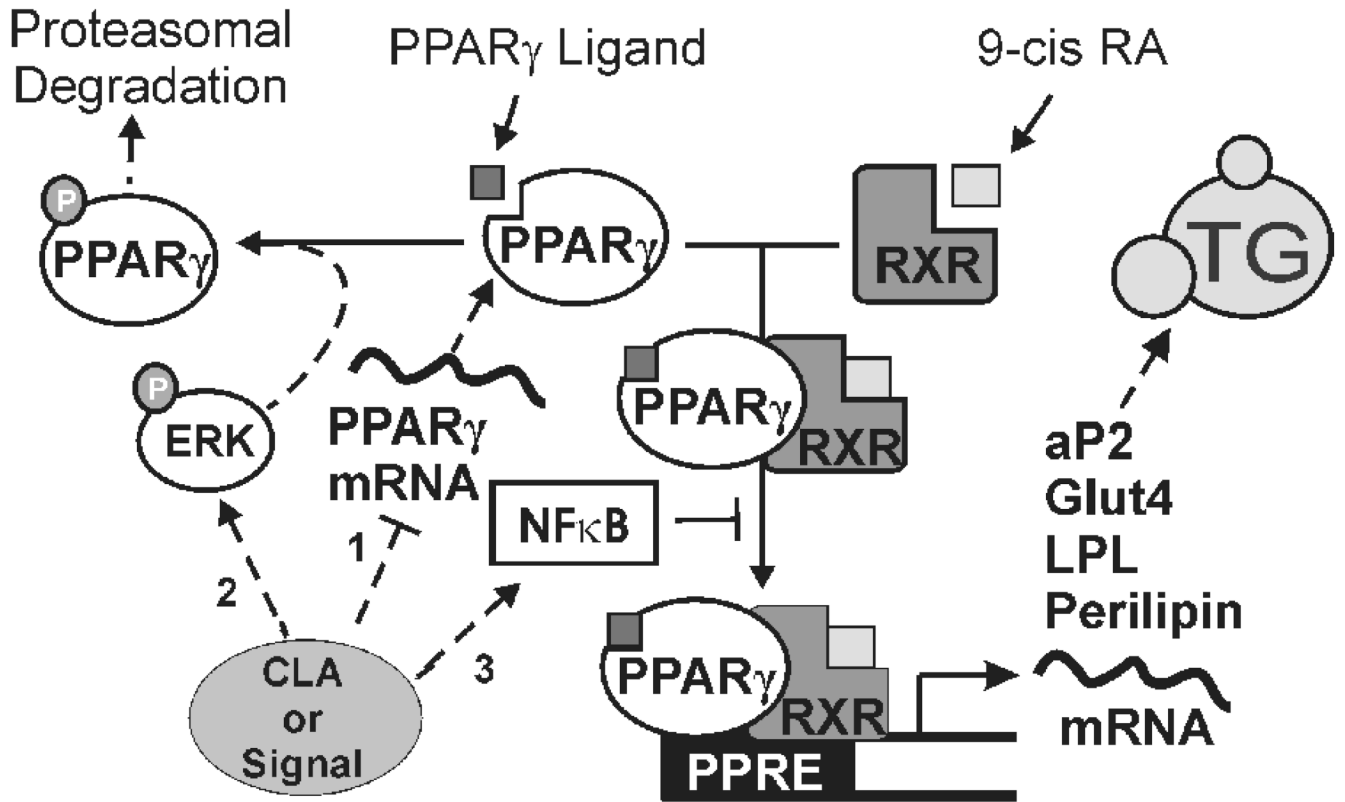

Figure 2. 10,12 CLA may antagonize PPAR γ activity by 1) decreasing PPAR γ gene expression, 2) enhancing PPAR γ degradation via phosphorylation, ubiquitination, and proteasome degradation, or 3) increasing NF κ B activation which impairs PPAR γ DNA binding and subsequent induction of adipogenic and lipogenic gene expression.

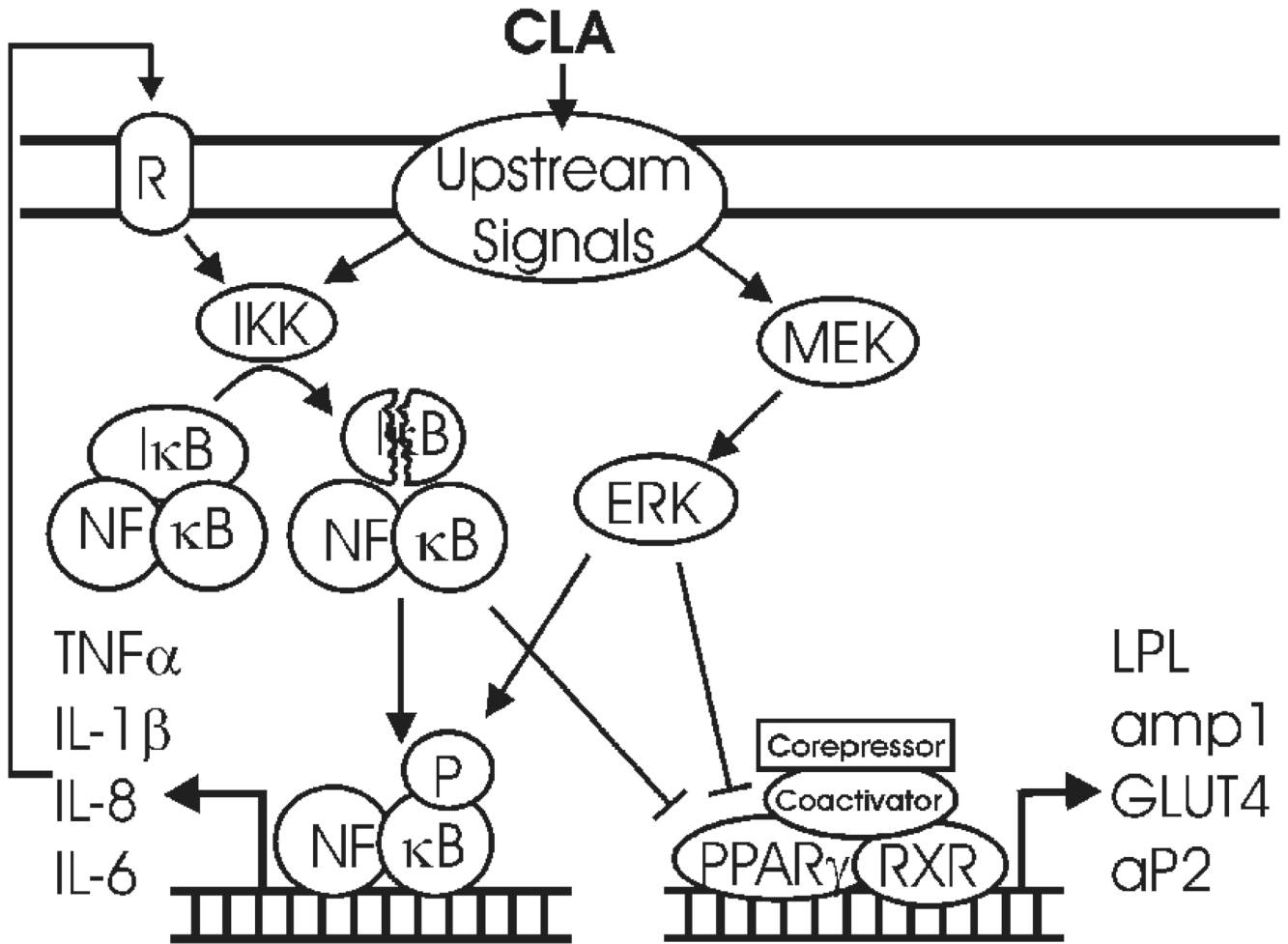

Figure 3.

10,12 CLA activation of inflammatory proteins and induction of inflammatory genes interferes with PPAR γ transcriptional activation of target genes such as lipoprotein lipase (LPL), adiponectin (AMP1), glucose transporter 4 (GLUT4), and adipocyte-specific fatty acid binding protein (aP2).

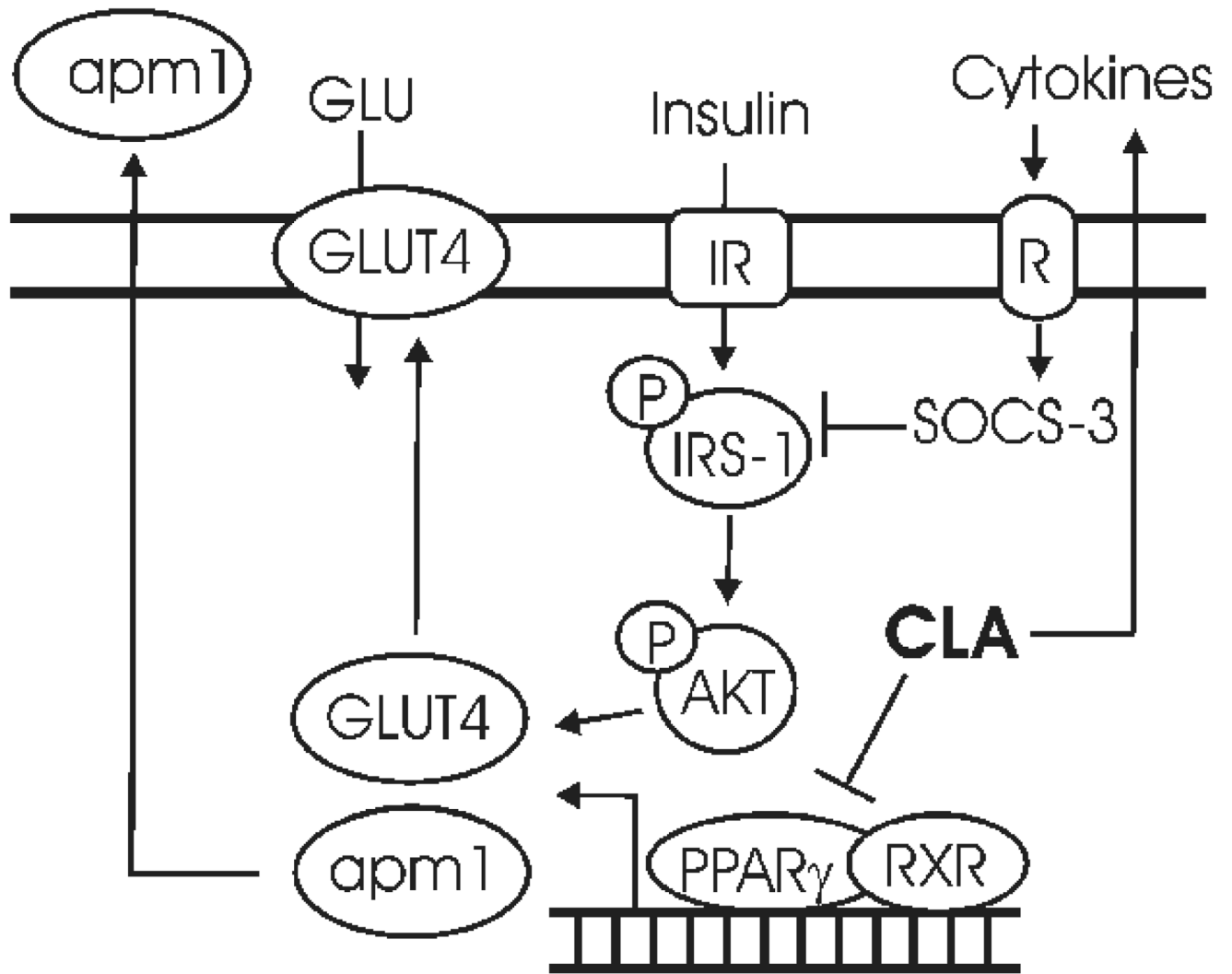

Figure 4. 10,12 CLA-mediated insulin resistance is linked to 1) antagonism of PPAR γ -induced GLUT4 and adiponectin (AMP1) expression, and 2) induction of inflammatory proteins and genes that decrease IRS-1-P (tyr) abundance, thereby reducing GLUT4 translocation to the plasma membrane.

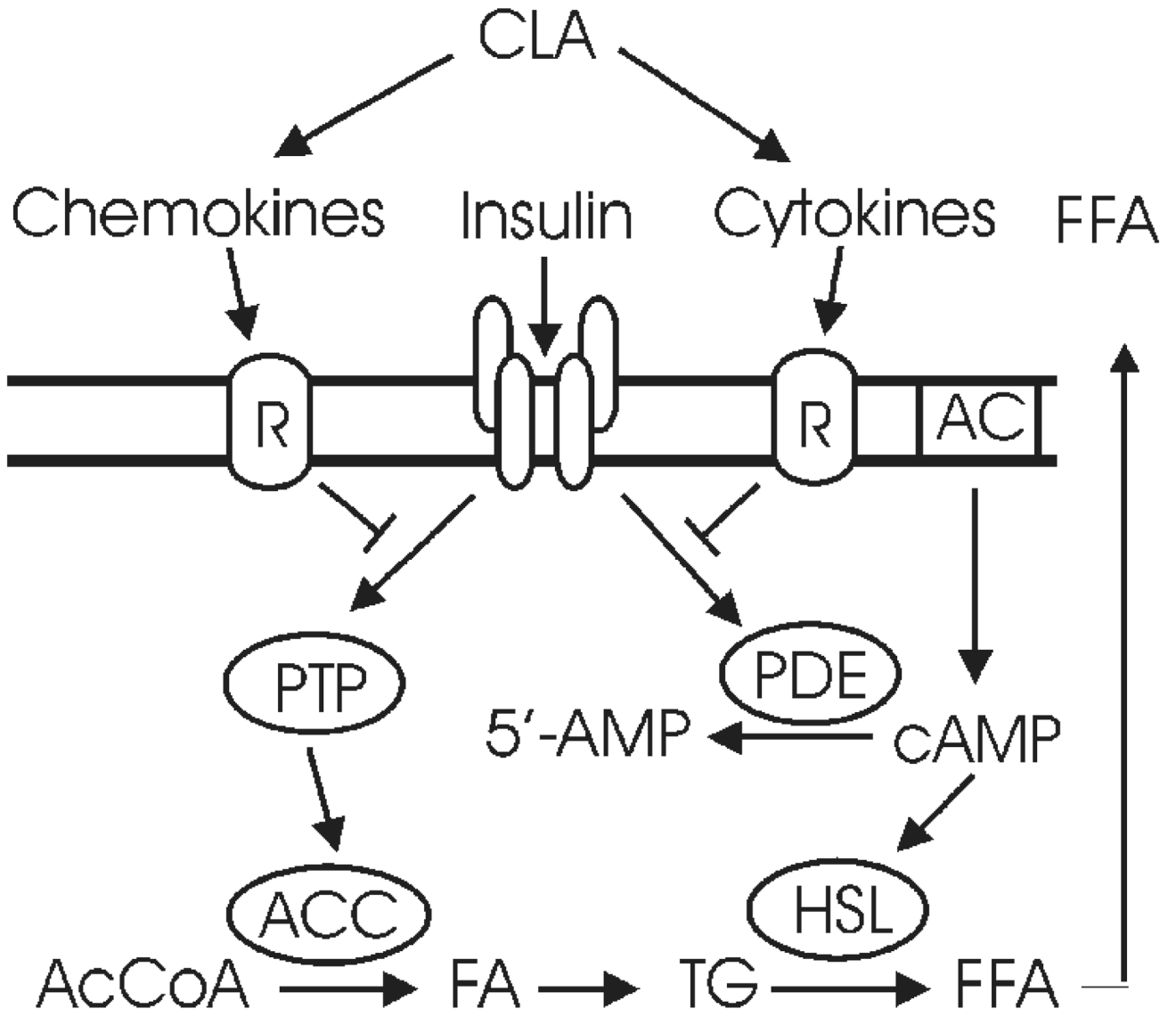

Figure 5. 10,12 CLA increases lipolysis acutely and decreases lipogenesis chronically by decreasing phosphodiesterase (PDE) and acetyl-CoA carboxylase (ACC) activities, respectively, key proteins regulated by insulin.

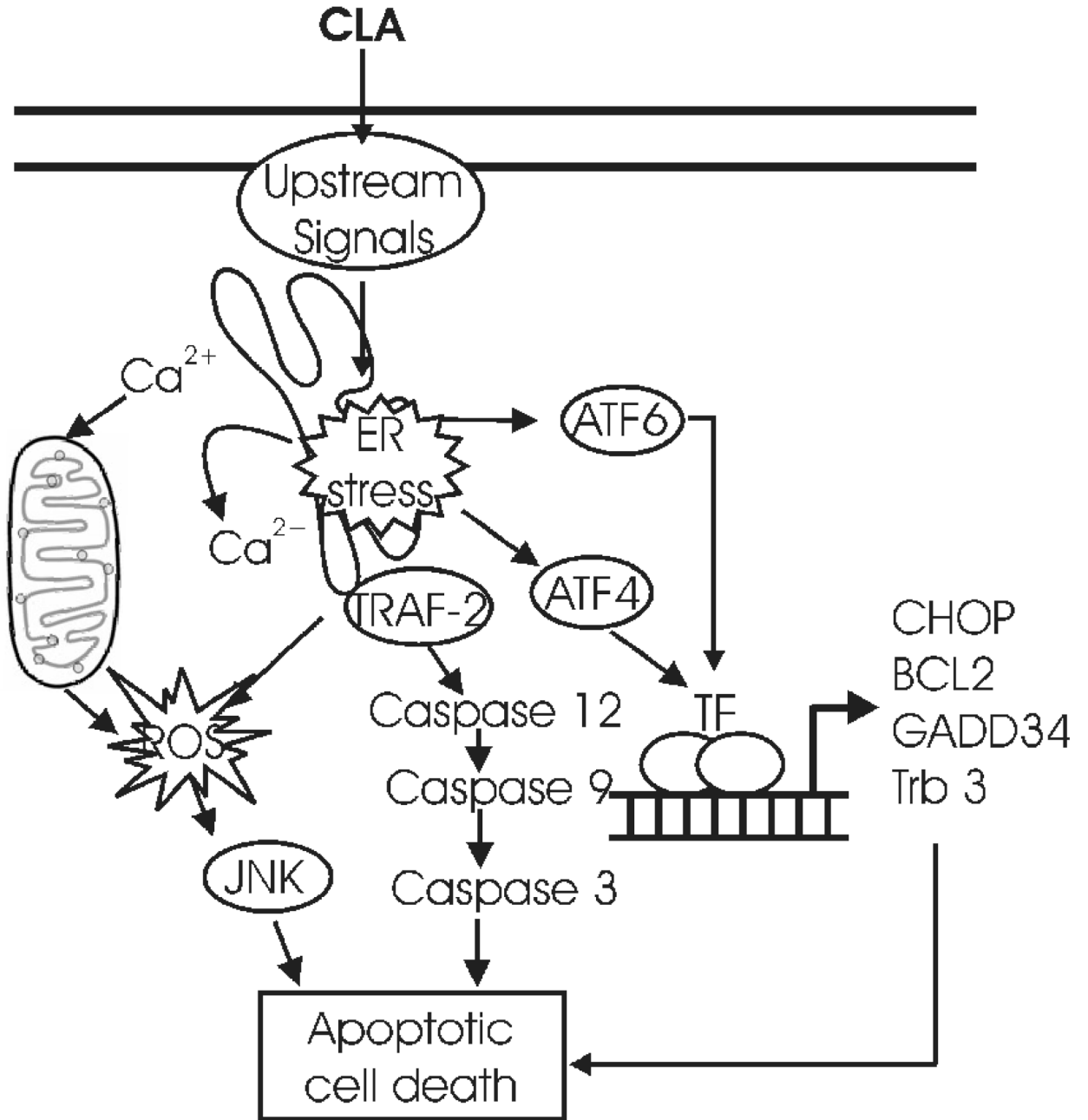

Figure 6. 10,12 CLA increases apoptotic cell death of (pre)adipocytes by increasing ER stress. 10,12 activates upstream signals that induce cell stress including ER stress and the ISR. These stress responses increase the levels of intracellular calcium, ROS, and proteins that together induce apoptosis.

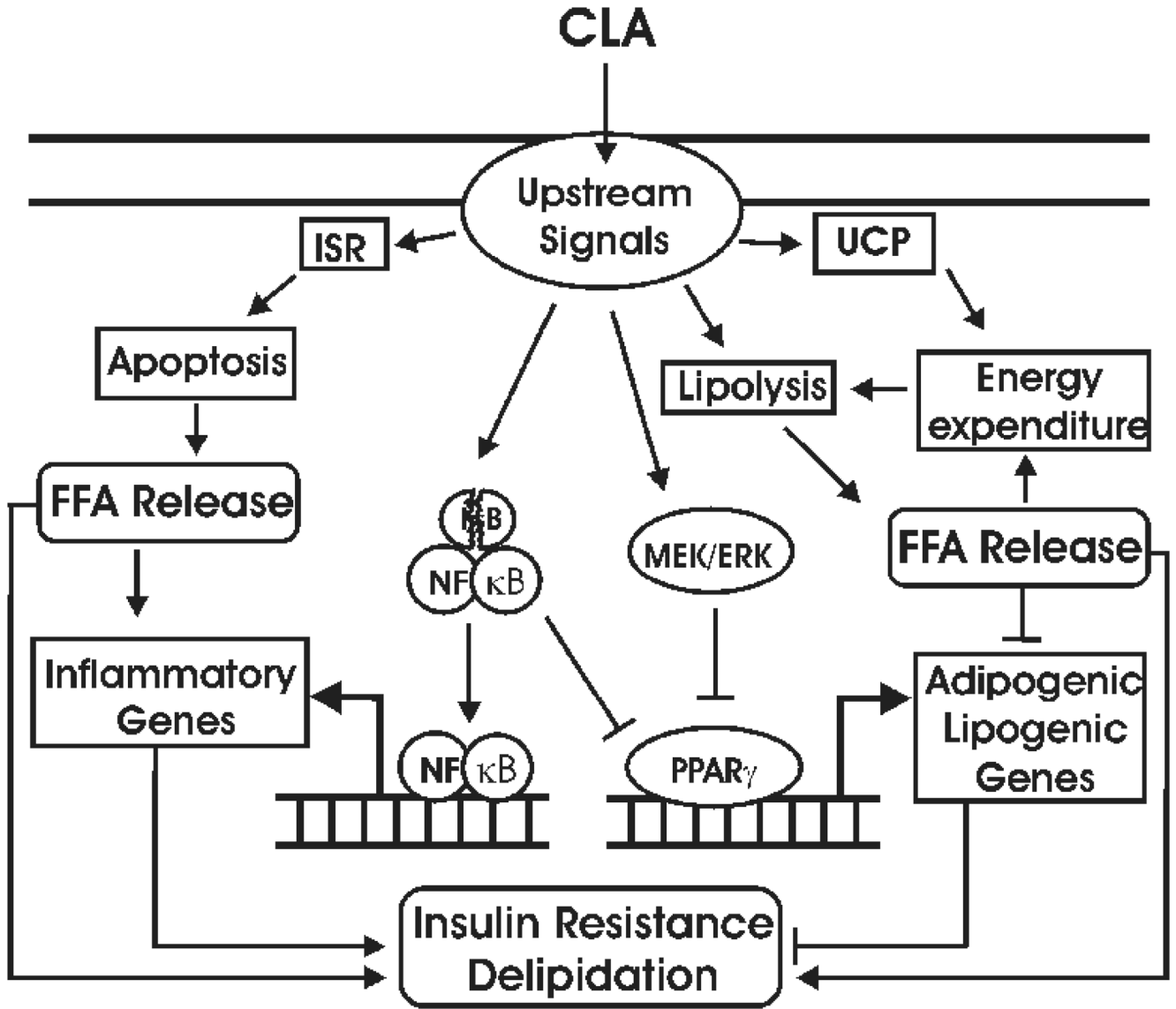

Figure 7. Working model by which 10,12 CLA causes insulin resistance and delipidation in adipocytes. We propose that 10,12 CLA induces upstream signals that cause 1) an ISR that increases apoptosis, FFA release, and inflammatory gene expression, 2) NFκB and ERK activation that antagonizes PPAR γ activity, and 3) increased UCP and lipolysis, further enhancing FFA levels. Together, these CLA-mediated signals cause adipocyte insulin resistance and delipidation.