

Anxiety Selectively Disrupts Visuospatial Working Memory

Alexander J. Shackman, Issidoros Sarinopoulos, and
Jeffrey S. Maxwell
University of Wisconsin—Madison

Diego A. Pizzagalli
Harvard University

Aureliu Lavric
University of Exeter

Richard J. Davidson
University of Wisconsin—Madison

On the basis of a review of the extant literature describing emotion–cognition interactions, the authors propose 4 methodological desiderata for studying how task-irrelevant affect modulates cognition and present data from an experiment satisfying them. Consistent with accounts of the hemispheric asymmetries characterizing withdrawal-related negative affect and visuospatial working memory (WM) in prefrontal and parietal cortices, threat-induced anxiety selectively disrupted accuracy of spatial but not verbal WM performance. Furthermore, individual differences in physiological measures of anxiety statistically mediated the degree of disruption. A second experiment revealed that individuals characterized by high levels of behavioral inhibition exhibited more intense anxiety and relatively worse spatial WM performance in the absence of threat, solidifying the authors' inference that anxiety causally mediates disruption. These observations suggest a revision of extant models of how anxiety sculpts cognition and underscore the utility of the desiderata.

Keywords: anxiety, working memory prefrontal cortex (PFC), hemispheric asymmetries, facial electromyography (EMG)

Students of emotion have long argued that affect is a necessary ingredient in the adaptive regulation of behavior and that a primary

Editor's Note. John Gabrieli served as the action editor for this article.—RJD

Alexander J. Shackman, Issidoros Sarinopoulos, and Jeffrey S. Maxwell, Department of Psychology, University of Wisconsin—Madison; Diego A. Pizzagalli, Department of Psychology, Harvard University; Aureliu Lavric, School of Psychology, University of Exeter, Devon, England; Richard J. Davidson, Departments of Psychology and Psychiatry, University of Wisconsin—Madison.

Support for this research was provided by a National Science Foundation Graduate Fellowship to Alexander J. Shackman, grants from the Swiss National Research Foundation and Holderbank-Stiftung zur Förderung der wissenschaftlichen Fortbildung to Diego A. Pizzagalli, National Institute of Mental Health Grants MH40747 and MH43454 to Richard J. Davidson, Research Scientist Award P50-MH52354 to Richard J. Davidson, and National Institute of Mental Health Training Grant T32-MH18931 to Richard J. Davidson. A portion of this work was originally presented at the 40th annual meeting of the Society for Psychophysiological Research, October 18–22, 2000, San Diego, California. We gratefully thank Jeremy Gray for providing the task; Larry Greischar, John Koger, and Adrian Pederson for technical assistance; Adam Silberman for assistance collecting data; several reviewers for comments on an earlier version of this report; and Andrew Fox and William Irwin for conceptual and methodological advice throughout this project.

Correspondence concerning this article should be addressed to Richard J. Davidson, Department of Psychology, Laboratory for Affective Neuroscience, University of Wisconsin, 1202 West Johnson Street, Madison, WI 53706. E-mail: rjdavids@wisc.edu

substrate of this regulation lies in the effects that affect exerts upon cognition (Darwin, 1872/1998; Ekman & Davidson, 1994). Recent years have witnessed an explosion of research underscoring the crucial role of affect in directing attention to goal-relevant stimuli, reinforcing learning and memory, facilitating decision making and goal selection, and resolving conflict (Cahill, 2000; Christianson, 1992; Compton, 2003; Damasio, 1994; Davis & Whalen, 2001; Dolan, 2002; Lowenstein & Lerner, 2003; Rolls, 1999). A key unresolved conundrum in this domain concerns the precise consequences of task-irrelevant (i.e., noncontingent) anxiety—described variously as stress, fear, worry, withdrawal-related affect, and negative affect—for ongoing cognitive processes.

Earlier descriptions of the deleterious impact of anxiety on cognition were primarily derived from consideration of the cognitive load imposed by task-irrelevant anxiety, suggesting, for example, that anxiety is associated with depletion of central executive resources (e.g., Eysenck & Calvo, 1992) or, because it is sometimes associated with subvocal worry, depletion of phonological resources (e.g., Eysenck & Calvo, 1992; Morris, Davis, & Hutchings, 1981). Our own framework for understanding how anxiety and cognition are likely to interact is based on the additional consideration of how anxiety is asymmetrically organized in the brain.

In the remainder of this section, we review data indicating that the right prefrontal cortex (PFC) plays a critical role in the distributed neural circuitry instantiating anxious arousal and propose that, to the extent that such anxiety is incidentally elicited, right PFC resources are no longer free to support ongoing cognition. This suggests that performance of cognitive tasks that are themselves asymmetrically dependent upon the right PFC are especially

vulnerable to disruption in the presence of task-irrelevant anxiety. We advance a similar case for the right posterior parietal cortex (PPC). We then describe several issues that limit the conceptual utility of much of the extant empirical work aimed at understanding how task-irrelevant anxiety and other affective states modulate ongoing cognition and propose four methodological desiderata for studying these kinds of interactions.

Asymmetries of Anxiety in the PFC and PPC

In considering the probable consequences of task-irrelevant anxiety for ongoing cognition, we begin with the assertion that the PFC and PPC represent key components of the distributed neural network instantiating anxious arousal.¹ Data collected from non-human primates (e.g., Kalin, Larson, Shelton, & Davidson, 1998), lesion patients (Bechara, Damasio, & Damasio, 2000; Hornak et al., 2004), psychiatric patients (Davidson, Pizzagalli, Nitschke, & Putnam, 2002), and healthy adults (Davidson, Pizzagalli, Nitschke, & Kalin, 2003; Kringelbach & Rolls, 2004) underscore the role of the PFC in this circuit.

Hemispheric asymmetries represent a key axis along which affective processes are functionally organized in the PFC (Davidson & Irwin, 1999; Pizzagalli, Shackman & Davidson, 2003). Davidson and colleagues, in particular, have marshaled considerable evidence to suggest that the left and right PFC are specialized to support affective states associated with approach (appetitive) and withdrawal (aversive/avoidant) tendencies, respectively (Coan & Allen, 2003b, 2004; Davidson, 1994). In particular, a variety of functional neuroimaging and lesion data show that states of anxious arousal are associated with the right dorsolateral (J. Baas et al., 2004; Dalton, Kalin, Grist, & Davidson, 2005; Fischer, Andersson, Furmark, Wik, & Fredrikson, 2002), right ventrolateral (J. Baas et al., 2004; Dalton et al., 2005; Davidson, Marshall, Tomarken, & Henriques, 2000), and right ventromedial (Clark, Manes, Antoun, Sahakian, & Robbins, 2003; Tranel, Bechara, & Denburg, 2002) sectors of the right PFC (for a recent meta-analysis, see Murphy, Nimmo-Smith, & Lawrence, 2003).

Complementary theoretical work by Heller, Nitschke, and colleagues (e.g., Keller et al., 2000) posits that the right PPC is also asymmetrically associated with arousing states of negative affect. An important caveat to this inference is that it is founded largely upon neurophysiological data obtained at rest (Nitschke, Heller, Palmieri, & Miller, 1999), thought to reflect trait differences in emotional reactivity (Tomarken, Davidson, Wheeler, & Doss, 1992; Tomarken, Davidson, Wheeler, & Kinney, 1992) rather than measures taken at the time of an affect provocation.

Competition Between Anxiety and Cognition for Right Hemisphere Resources Will Yield Selective Degradation of Performance

In accord with broader neurophysiological models of dual process competition (Friedman & Poulson, 1981; Kinsbourne & Hicks, 1978; Klingberg, 1998; Kok, 1997), we hypothesized that task-irrelevant anxious arousal competes with ongoing cognitive operations localized to the same neural territories for limited resources. Through resource depletion or cross-talk interference, such resources will be less available to support ongoing cognitive operations that are unrelated to the perceived source of threat and

concomitant anxious mood (i.e., that lie outside the focus of the anxious goal set). We expect that a disproportionate degree of the impact falls on those cognitive processes that are themselves asymmetrically associated with the right PFC and PPC. In this regard, recent research suggests that the right mid- and ventrolateral PFC play a disproportionate role in motor and sensory inhibition (e.g., Aron, Fletcher, Bullmore, Sahakian, & Robbins, 2003; Lavric, Pizzagalli, & Fortsmeier, 2004; Rubia, Smith, Brammer, & Taylor, 2003), arousal/vigilance (e.g., Lawrence, Ross, Hoffman, Garavan, & Stein, 2003; Sturm & Willmes, 2001), and certain spatial working memory (WM) processes (e.g., Manoach et al., 2004). The right PPC has, if anything, been even more closely associated with certain forms of spatial attention (Bender, 1952; Corballis, Funnell, & Gazzaniga, 2002). It has also been implicated in various forms of spatial WM, spatially guided action planning, and arousal (e.g., Heller, Nitschke, Etienne, & Miller, 1997; Heller, Nitschke, & Lindsay, 1997; Müri et al., 2000). We predict that such processes should prove especially vulnerable to performance degradation when performed in the presence of task-irrelevant anxiety. Before turning to the operational specifics of our test of this prediction, we first describe the motives that guided our choice of paradigm.

Methodological Desiderata for the Study of Affect × Cognition Interactions

Unfortunately, much of the extant research aimed at investigating Affect × Cognition interactions is of limited interpretability owing to various methodological ambiguities, a gloomy conclusion not too different from that reached by Lazarus, Deese, and Osler (1952) half a century ago. To ameliorate this situation, we propose four desiderata for research that aims to understand Affect × Cognition interactions (for related views, see Davidson, Ekman, Saron, Senulis, & Friesen, 1990; Davidson et al., 2003; Ellis & Ashbrook, 1989; Hopko, Crittendon, Grant, & Wilson, 2005; Levenson, 2003; Stemmler, 2003).

Two or More Well-Matched Cognitive Tasks Should Be Employed

Using multiple tasks permits crisp inferences about the specificity of an observed affective modulation (e.g., Gray, 2001; Lavric, Rippon, & Gray, 2003; Moore & Oaksford, 2002). This is particularly true in the case of *double dissociations*, disordinal interactions involving two or more tasks and emotions (see Shallice, 1988; or the February 2003 issue of *Cortex*). If only a single cognitive task is employed and the elicitation of task-irrelevant affect causes a significant performance effect, the specificity of that effect is potentially ambiguous (e.g., Hodges & Spielberger, 1969; Leon & Revelle, 1985; MacLeod & Donnellan, 1993; Pallak, Pittman, & Heller, 1975). It may be, for example, that the affect induction procedure simply leads to greater distraction, arousal, or impulsivity.

¹ Although it is outside the scope of the present report, it is worth emphasizing that a number of other structures, such as the amygdala (e.g., Davidson et al., 2003; Davis & Whalen, 2001), are thought to perform critical roles in the neural circuitry instantiating anxiety and conceivably do so asymmetrically (e.g., D. Baas, Aleman, & Kahn, 2004; Zald, 2003).

It must also be demonstrated that the tasks are psychometrically equivalent if strong inferences are to be drawn about differential effects in the absence of a double dissociation (Chapman & Chapman, 2001; Strauss, 2001). In particular, the tasks must exhibit similar means, to avoid differential floor or ceiling effects, as well as variances and reliabilities (i.e., internal consistency), to avoid differential statistical sensitivity. Unfortunately, rigorous demonstrations of psychometric equivalence have rarely been performed in the past (e.g., Buckelew & Hannay, 1986; Gray, 2001; Gray, Braver, & Raichle, 2002; Lavric et al., 2003; Markham & Darke, 1991; Moore & Oaksford, 2002) in spite of their clear inferential utility (e.g., Davidson, Chapman, Chapman, & Henriques, 1990). Although the general failure of investigators to compute reliabilities is itself not too troubling, given that extremely high and presumably similar internal consistencies (i.e., Cronbach's coefficient alpha; Cronbach, 1951) will necessarily be found for any task that makes use of a large number of trials ("items") that do not systematically differ in their difficulty or content (Cortina, 1993), the other criteria are important to demonstrate. The presentation of equivalent stimuli and requirement of matched responses are also helpful (Reingold, 2003).²

The Cognitive Task Should Possess a Well-Characterized Cognitive Architecture and Functional Neuroanatomy

Many of the tasks that have been employed in this domain are complex and poorly understood (e.g., Mulholland's analogical reasoning task, Duncker's candle task, the Mednicks' remote associates task; e.g., Ashby, Isen, & Turken, 1999; Ashby, Velentin, & Turken, 2002). Employing a task with well-characterized elementary operations (e.g., Eriksen flanker task, go/no-go task, Posner attention task, Sternberg item recognition task, Stroop task) facilitates the elaboration and test of specific hypotheses about the mechanisms mediating the affective modulation of global performance measures (e.g., reaction time [RT]). Cognitive specificity promotes theoretical generalizability by permitting inferences to be extrapolated to any task relying on the relevant operation (cf. Sanfrey & Cohen, 2004). Using a task with a well-understood functional neuroanatomy likewise permits novel inferences about plausible loci of Affect \times Cognition interactions.

Lasting Affect Must Actually Be Elicited

Affect is notoriously fleeting, particularly when it is of low intensity (e.g., Davidson, Ekman, et al., 1990; Garrett & Maddock, 2001; Gross, 1998). It can also be suppressed by engagement in distracting tasks (e.g., Erber & Erber, 2000), which is precisely the situation in studies of task-irrelevant affect. If the goal of the research is to characterize the effects of affect on cognition, then the paradigm must be capable of actually eliciting enduring affect. Studies (e.g., Bishop, Duncan, Brett, & Lawrence, 2004; Compton, Heller, Banich, Palmieri, & Miller, 2000) employing stimuli (e.g., emotional faces or words) that do not elicit significant affect are better classified as studies of emotional perception. Likewise, examining performance differences associated with groups differing in a trait affectivity measure (e.g., Markham & Darke, 1991) does not guarantee that such differences derive from affect. They may instead reflect preexisting cognitive diatheses (e.g., Abramson et al., 2002).

The Presence of the Intended Emotions Must Be Adequately Verified

Induction procedures typically fail to elicit the target affect in a subset of participants (e.g., Britt & Blumenthal, 1991; Lazarus et al., 1952; Martin, 1990; Stemmler, 2003). It is therefore imperative to collect measures, apart from performance indexes, capable of verifying the presence of the target affect. Behavioral (e.g., facial actions) or psychophysiological measures may prove especially advantageous given concerns that have been raised about self-report (e.g., Fredrickson, 2000). In particular, self-report measures may be subject to significant demand characteristics (Berkowitz & Troccoli, 1986; Kenealy, 1986; Westermann, Spies, Stahl, & Hesse, 1996), particularly when combined with an induction procedure, such as the Velten (1968) technique, that relies upon instructing participants to voluntarily "get into" a particular state. Furthermore, self-report instruments may prove insensitive to the magnitude of affect experienced during cognitive task performance if they only inquire about experiences during the affect induction procedure or earlier (as in, e.g., Gray, 2001; Moore & Oaksford, 2002; Oaksford, Morris, Grainger, & Williams, 1996; Wetherell, Reynolds, Gatz, & Pedersen, 2002): For example, if affectively laden film clips are presented prior to task performance and self-report instruments are administered in the interval between the conclusion of the clips and the commencement of the task, the extent to which the elicited affect endured throughout task performance remains unknown. In general, paradigms that involve the evocation of affect prior to task performance (e.g., Gray, 2001; Gray et al., 2002) can prove difficult to interpret when precautions are not taken to demonstrate that the target affect is present at the time of task performance.

Among psychophysiological measures, those sensitive to a combination of valence and arousal—what has been termed positive and negative *activation* by some students of emotion (Watson, Wiese, Vaidya, & Tellegen, 1999)—such as facial electromyography (EMG), the startle reflex, or the postauricular reflex, are preferable to those similarly sensitive to positive and negative activation, such as heart rate or skin conductance (Bradley, Codispoti, Sabatinelli, & Lang, 2001; Cacioppo, Petty, Losch, & Kim, 1986), to rule out a role for nonspecific arousal (e.g., Christianson & Mjörndal, 1985), motivated attention (e.g., Hamm & Vaitl, 1996), or cognitive load in putatively affect-modulated effects (cf. Lavric et al., 2003). Unlike self-report, such measures have the additional advantage that they can be unobtrusively and continuously acquired while participants are performing the cognitive task, allowing an online measure of affect.

Our hope is that these four desiderata will facilitate the design of more rigorous new experiments and the more nuanced review of published ones. Nevertheless, we view them as general guidelines

² An alternative approach involves examining the impact of two or more affective states, well matched for absolute valence and arousal, on performance of a single task. Such a paradigm would make it possible to show that the observed modulation of performance is not simply due to nonspecific processes associated with affect (e.g., arousal, distraction). However, depending on the choice of task, it could potentially yield ambiguous inferences about the specificity of the elementary cognitive process linking affect and performance. Reliance upon parametric manipulations of difficulty or load (i.e., with a single task) is subject to similar concerns.

rather than immutable rules: The failure of a particular investigation to satisfy one or more of them can be taken not as a fatal flaw but rather as a constraint on the inferences that one may legitimately draw from the results of that experiment and the corpus of work in which it is rooted.

Experiment 1

The aim of Experiment 1 was to test our prediction that task-irrelevant anxiety elicited by threat of shock would selectively disrupt performance of a visuospatial WM task thought to rely on the right PFC/PPC while sparing a psychometrically equivalent verbal WM task thought to rely on the left PFC, using a paradigm tailored to satisfy each of the desiderata outlined above. Tests of performance accuracy served as the primary means of testing this prediction.

For the cognitive tasks, we employed verbal and spatial variants of the three-item *n*-back WM task. The cognitive and neurophysiological architecture of the *n*-back task is reasonably well characterized (Baddeley, 2003; Jonides et al., 1997; Owen, McMillan, Laird, & Bullmore, 2005; Wager & Smith, 2003). The tasks incorporated identical stimuli and required identical responses; they differed only in the type of information—letter identity or spatial location—that participants had to maintain in WM (see Figure 1). Prior work using a similar spatial three-back task has

shown that it also possesses reasonable 1-week test–retest stability ($r = .73$; Hockey & Geffen, 2004). Unlike traditional psychometric tests (e.g., span tasks) that involve the successive presentation of more difficult items and terminate when the participant reaches an asymptotic level of performance (cf. Spies, Hesse, & Hummetsch, 1996), continuous performance tasks, such as the *n*-back, are less prone to changes in performance secondary to nonspecific changes in motivation. It is important to note that the available functional neuroimaging data suggest that the verbal and spatial tasks asymmetrically rely on the left and right PFC, respectively (e.g., Manoach et al., 2004).³ Pilot work ensured that the tasks met all of the usual criteria for psychometric equivalence (see also Table 1), indicating that the tasks were statistically similar in their sensitivity to disruption. Because our hypotheses were in terms of performance accuracy, we made no a priori attempt to psychometrically match RTs across tasks. Other work has demonstrated that verbal and spatial *n*-back tasks similar to those we employed are differentially sensitive to the effects of verbal and spatial secondary task interference (Vuontela, Rämä, Raninen, Aronen, & Carlson, 1999) but similarly sensitive to at least some forms of nonspecific distraction (Lavric et al., 2003). Together, the latter observations reinforce the assertion that the WM tasks we employed are well suited to demonstrating that threat-induced anxiety selectively disrupts performance of spatial WM.

Threat of shock, a potent and relatively automatic elicitor of anxiety, served as the affect induction procedure (e.g., Greenwald, Bradley, Cuthbert, & Lang, 1998; Grillon, Ameli, Woods, Merikangas, & Davis, 1991). Unlike alternative methods, such as affectively laden films (Gross & Levenson, 1995), threat of shock is thought to produce a relatively pure state of anxiety, unconfounded by nontarget negative emotions (Martin, 1990), such as disgust. In addition, in contrast to stimuli such as film or music clips, which participants might have experienced prior the experiment, threat of shock should minimize individual differences in learning history or exposure. A further concern with film clips is

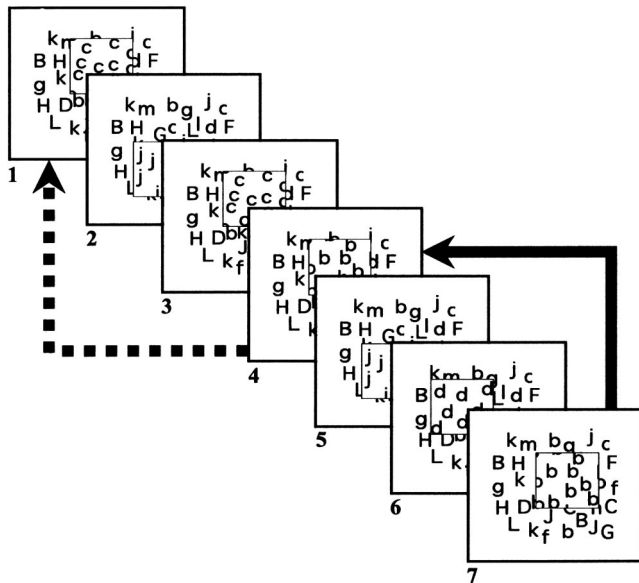

Figure 1. The verbal and spatial 3-back tasks. Trials (indicated by the numbers to the left) consisted of the brief (500 ms) presentation of a box in one of six locations containing one of six letters. Locations overlapped one another and occupied asymmetric, noncardinal locations to inhibit the use of nonmetric codes to perform the visuospatial task. During the intertrial interval (not displayed; 2,500 ms), the box disappeared from view. On each trial, participants pressed a key indicating whether the current memorandum did or did not match that presented three trials previously. The solid arrow indicates a verbal-match/spatial-nonmatch trial. The dashed arrow indicates a verbal-nonmatch/spatial-match trial. Match and nonmatch trials occurred equally often. No feedback was provided.

³ The hypothesis that the verbal and spatial three-back tasks are asymmetrically associated with the left and right PFC is contentious (e.g., Postle & D'Esposito, 2000). Nevertheless, we believe that there is a preponderance of evidence favoring such a model from experiments employing both *n*-back and Sternberg-type item recognition (delayed match-to-sample) tasks. Data acquired using electrophysiological (e.g., Ruchkin et al., 1994), positron emission tomography (e.g., Smith et al., 1999), and functional MRI (e.g., Manoach et al., 2004) techniques are in accord with our hypothesis. An experiment using rapid transcranial magnetic stimulation to produce temporary deactivation of the left or right PFC came to a similar conclusion (Floel et al., 2004). A degree of the inconsistency plaguing the literature likely stems from failures to control rehearsal strategy (e.g., McNamara & Scott, 2001). Individuals who employ task-optimized strategies or show superior performance tend to show a more specific, lateralized pattern of task-evoked activation in the predicted direction (e.g., Cabeza et al., 2004; Glabus et al., 2003; Gur et al., 2000; Papousek & Schuller, 2004; Tomasino & Rumiati, 2004). Task novelty may have an effect akin to that found among suboptimal performers (Schumacher, Hendricks, & D'Esposito, in press). The degree to which particular WM paradigms involve both visuospatial attention and visuomotor manipulation may also play a role (Vingerhoets & Stroobant, 1999). Finally, recent data indicate that the use of identical stimuli across verbal and spatial conditions has also contributed to underestimates of task-specific activation (Meegan & Honsberger, 2005).

Table 1
Mean Raw Three-Back Performance, Experiments 1A and 1B

Condition	Verbal		Spatial		Verbal		Spatial		Verbal		Spatial	
	Accuracy	SEM	Accuracy	SEM	RT	SEM	RT	SEM	α	$\pm 95\%$ CI	α	$\pm 95\%$ CI
Experiment 1A												
Safety	82.1	2.1	84.5	1.9	1,040	42	945	34	.95	.02	.95	.03
Threat	81.6	2.1	81.1	1.9	1,007	39	934	33				
Experiment 1B												
Safety	84.2	2.9	83.1	2.6	1,077	50	967	43	.93	.04	.91	.05
Threat	84.5	2.8	79.5	2.6	1,036	58	964	46				

Note. Accuracy and reaction time (RT) are expressed in units of percentage correct and milliseconds, respectively. Coefficient α refers to Cronbach's (1951) measure of internal consistency. For Experiment 1A ($n = 31$), α was based on the mean within-subject accuracy—across two safety blocks—of 100 three-back trials (“items”). For Experiment 1B ($n = 24$), α was based on the mean within-subject accuracy—across four safety blocks—of 15 three-back trials (“items”). Two of the usual criteria for establishing the psychometric equivalence of tasks are demonstrating that they possess similar item variances and distributions (Chapman & Chapman, 2001). Because all of the “items” on the three-back tasks were identical in content and difficulty, these are omitted. Raw (i.e., untransformed) between-subjects statistics are presented for descriptive purposes. Inferential statistics were conducted with transformed metrics and within-subjects measures of variance (see text and Figures 2 and 4). CI = confidence interval.

that they have been shown to produce transient bursts of full-blown affect separated by epochs in which overt signs of affect are markedly reduced or absent altogether (Davidson et al., 1990). And, unlike procedures such as affective film clips (e.g., Gray, 2001), affective music clips (e.g., L. A. Schmidt & Trainor, 2001), affective images (e.g., Christianson, 1986), autobiographical recall (e.g., Pardo, Pardo, & Raichle, 1993), anticipated public speaking (e.g., Davidson et al., 2000), and social stress tests (e.g., Dickerson & Kemeny, 2004), it is relatively simple to superimpose threat-induced anxiety upon performance of a cognitive task without simultaneously introducing a substantial secondary perceptual or cognitive load. The functional neuroanatomical underpinnings of shock threat are also better understood (e.g., J. Baas et al., 2004; Dalton et al., 2005; Phelps et al., 2001) than alternate procedures, such as film clips (e.g., Lane et al., 1997) or techniques that require participants to voluntarily generate affect (e.g., Damasio et al., 2000).

We used EMG activity recorded from the *corrugator supercilii* muscles (responsible for brow knitting) and the acoustic startle reflex to assess threat-induced changes in anxiety. We also collected affect ratings. Following earlier suggestions (e.g., Basso, Scheff, & Hoffmann, 1994; Davidson, Ekman, et al., 1990; Levenson, 2003; Stemmler, 2003), we excluded from analyses participants who failed to show psychophysiological signs of anxiety (i.e., amplification).

The data described here as Experiment 1 were obtained from two independent-sample experiments. The major difference between the experiments is that Experiment 1A entailed the occasional delivery of shocks during task performance, whereas Experiment 1B relied exclusively on the mere threat of shock. Given the manifest similarity of the experiments, we subjected performance data to a single omnibus analysis. The first prediction was a Task \times Anxiety interaction such that threat-induced anxiety would disproportionately attenuate spatial compared to verbal performance. Motivated by a tradition arguing that individual variation can provide insight into the mechanisms underlying mean differences apparent at the group level (Kosslyn et al., 2002), we further predicted that individual differences in anxiety should

predict the magnitude of threat-induced interference. Demonstrating that variations in valence-sensitive psychophysiological indexes predict performance decrements would suggest that anxiety, and not some other consequence of the threat manipulation, was responsible for interference. Performance accuracy served as the primary dependent measure for tests of these predictions.

Method

Participants. We recruited 66 right-handed undergraduates for the two experiments. We discarded data from 11 participants because they failed to exhibit amplification of corrugator, startle, or both measures. We submitted data from the remaining 55 (31 female) individuals who participated in Experiments 1 ($n = 31$) and 2 ($n = 24$) to one or more analyses.

Tasks. A three-back WM task, adapted from code provided by Jeremy Gray (2001), was employed (see Figure 1). Participants were presented with a continuous stream of letters and required to judge whether the item displayed on a particular trial matched that presented three trials previously (i.e., three back). In the verbal task, participants made this judgment on the basis of the letter's identity (*B, C, G, K, P, or T*; case pseudorandomized), whereas in the spatial version they made it on the basis of the letter's location (six locations). To discourage participants from adopting a verbal recoding strategy for performing the spatial task (cf. Klauer & Zhao, 2004), stimuli occupied non-overlapping, noncardinal locations. Participants made responses using their right hand. No feedback was provided. To discourage formation of a probabilistic guessing strategy, match and non-match trials occurred equally often. The repeated presentation of a particular memorandum on the trials intervening between initial presentation (i.e., Trial 0) and response (i.e., Trial 3) occurred rather infrequently (~10%–20% of the trials), indicating that successful performance could be accomplished largely on the basis of familiarity.

Apparatus and physiological data reduction. Tasks were presented on a 43.52-cm monitor. Field and box stimuli subtended ~4.8° and ~3.8° visual angle, respectively, at 60 cm. Startle probes were 50-ms, 95-dB white noise bursts (near instantaneous rise time) delivered through headphones. Shocks (4 mA, 20 ms, constant current) were generated via a Coulbourn Instruments (Allentown, PA) A13-75 stimulus isolator and delivered to silver electrodes affixed to the left wrist.

We acquired psychophysiological measures using our published procedures (Sutton, Davidson, Donzella, Irwin, & Dotts, 1997). We collected EMG from the *orbicularis oculi* and *corrugator supercilii* muscles via

electrodes placed below the left eye and above the left mesial eyebrow, respectively. A ground electrode was placed in the center of the forehead. Impedances were less than 20 k Ω . Raw signals were bandpass filtered (1–800 Hz) and amplified (by 10,000 Hz), highpass filtered (30 Hz), and digitized (12-bit at 1,000 Hz). Orbicularis EMG was rectified, then integrated via a contour-following integrator (time constant: 20 ms) before digitization. Units were analog-to-digital counts.

Startle magnitude was computed according to automatic and manual procedures. Magnitudes were computed as peak-onset amplitude (peak: 20–120 ms following probe). Imperceptible responses were set to zero. Magnitudes were z -transformed within participants and blocks. Blinks greater than three standard deviations above a participant's mean were excluded. The raw corrugator (45–200 Hz) was inspected for artifact before transformation to mean spectral power density (counts²/Hz). Power estimates were \log_{10} -transformed within participants and blocks.

Procedure. After informed consent was obtained, participants practiced the tasks and were prepared for psychophysiological recordings. They were instructed that they would receive between one and several shocks in the course of the experiment and that, to the extent that they received more than one, each additional shock would be more intense than that which preceded it.

In Experiment 1A, the session consisted of two halves, during which either the verbal or the spatial task was performed (order was counterbalanced). Each half included four 103-trial blocks. Half of the test blocks were associated with threat of shock; the remaining were safety blocks (order was counterbalanced). Participants received one shock during each threat block. Electrodes were unplugged during safety blocks. Data from shocked trials and the three that followed were discarded. Matched trials from safety blocks were also excluded.

Experiment 1B also consisted of two halves. Participants performed the verbal task during one half and the spatial task during the other (order was counterbalanced). Halves were composed of 17 contiguous 18-trial blocks. For each task, half of the blocks were associated with performing the same three-back task used in Experiment 1A. The remaining blocks involved performance of a one-back version of the task. Likewise, half the blocks were associated with threat of shock. Prior to completing the experimental task, participants received several shocks to establish that they could, in fact, be delivered. No shocks were delivered during the experimental task. In order to permit us to combine data collected from the two studies, only the 3-back data from Experiment 1B were included in analyses.⁴

Regardless of experiment, at the beginning of each block, a written cue informed participants whether there was a possibility of receiving noncontingent shock. As an additional reminder, the background screen was presented in one of two colors (green or blue; counterbalanced) to indicate whether shock delivery was possible. Following the final block of the task, participants rated how strongly they experienced various emotions (anxious, aroused, excited, happy, and relieved) during epochs associated with the presence or absence of threat, respectively, using 100-mm visual analogue scales anchored by the terms *not at all* and *extremely*.

Results

As a preliminary step, we used diagnostic procedures to ensure that parametric test assumptions were satisfied. Where necessary, we multiply transformed data and compared the transformations for correction adequacy. This yields more optimal solutions than more commonly employed “power family” approaches (Tukey, 1977). Because monotonic transformations (e.g., square root, logarithmic) disproportionately compress extreme positive observations, it was necessary to reflect negatively skewed data before and after transformation: for example, $-\log_{10}(101 - x)$. We compared transformed and raw cell means to ensure fidelity of ranks. We report effect sizes as partial eta-squared.

Assessing the induction of anxiety under threat. Participants reported experiencing greater anxiety, arousal, and excitement and reduced happiness and relief under threat compared to safety, $F_s(1, 53) > 9.8$, $p_s < .003$, $\eta^2_s > .16$. In particular, participants retrospectively reported experiencing more intense anxiety (safety, $M = 17.2$ mm; threat, $M = 65.3$ mm).

Corrugator EMG and startle were amplified by threat, $F(1, 40) = 41.4$, $p = 1.2 \times 10^{-7}$, $\eta^2 = .51$, and $F(1, 38) = 149.6$, $p = 9.5 \times 10^{-15}$, $\eta^2 = .80$, respectively. The latter effect was moderated by experiment, $F(1, 38) = 11.2$, $p = .002$, $\eta^2 = .23$, owing to the fact that mean startle potentiation was nearly twice as large in Experiment 1A.

Assessing the psychometric equivalence of verbal and spatial performance accuracy. The accuracy of the tasks was well matched: The critical simple effect of task in the absence of threat (i.e., at baseline) was not reliable, $F(1, 53) < 1$, $\eta^2 = 3.5 \times 10^{-4}$. Although it must be interpreted with caution in light of the substantial ordinal interaction of task and anxiety, the main effect of task also did not achieve conventional significance, $F(1, 53) = 2.9$, $p = .09$, $\eta^2 = .05$. Moreover, in the absence of threat, the two tasks were characterized by highly similar variances and internal consistency reliabilities (i.e., Cronbach's coefficient alpha; see Table 1), underscoring their well-matched discriminating power and sensitivity to detect our anxiety manipulation (Chapman & Chapman, 2001; Strauss, 2001).

Prediction 1: Threat will selectively disrupt spatial WM performance. We transformed accuracy data using a doubly reflected third-root formula, $-(101 - x)^{1/3}$ (see Figure 2 and Table 1). For accuracy, an effect of anxiety, $F(1, 53) = 14.0$, $p = 4.5 \times 10^{-4}$, $\eta^2 = .21$, was qualified by the predicted Task \times Anxiety interaction, $F(1, 53) = 9.8$, $p = .003$, $\eta^2 = .16$. There was no effect of experiment, $F < 1$. Spatial WM accuracy was reduced under threat compared to safety, $F(1, 54) = 30.4$, $p = 1.0 \times 10^{-6}$, $\eta^2 = .36$, whereas there was no comparable effect of threat compared to safety on verbal performance, $F < 1$. Likewise, direct comparison of task accuracy under threat demonstrated that spatial performance was worse than verbal, $F(1, 53) = 9.6$, $p = .003$, $\eta^2 = .15$. Consistent with an interpretation of the two experiments as conceptual replicates, the Task \times Anxiety interaction was reliable for both Experiment 1A, $F(1, 30) = 4.4$, $p = .04$, $\eta^2 = .13$, and Experiment 1B, $F(1, 23) = 5.3$, $p = .03$, $\eta^2 = .19$, considered in isolation. Likewise, in both experiments, spatial WM performance was reliably reduced under threat, $p_s < .003$, whereas verbal was not, $F_s < 1$.

Prediction 2: Individual differences in anxiety will predict spatial interference. We conducted correlation analyses on difference scores (i.e., safety minus threat), computed with the transformed data (see Figure 3). Individual differences in threat-amplified corrugator EMG activity, $r = -.33$, $p = .03$, $n = 44$, and threat-potentiated startle, $r = -.32$, $p = .04$, $n = 42$, were

⁴ Participants performed the spatial 1-back task less accurately ($M = 92.7\%$, $SD = 6.5\%$) than the verbal task ($M = 96.4\%$, $SD = 3.8\%$) at baseline ($p = .02$), indicating a failure of task matching. For a subset of participants ($n = 10$) chosen to have matched baseline accuracies, there were no effects of threat on accuracy ($p_s > .63$). Analyses of baseline RT indicated that the spatial ($M = 887$ ms, $SD = 174$) and verbal ($M = 880$ ms, $SD = 182$) tasks were matched ($p = .76$).

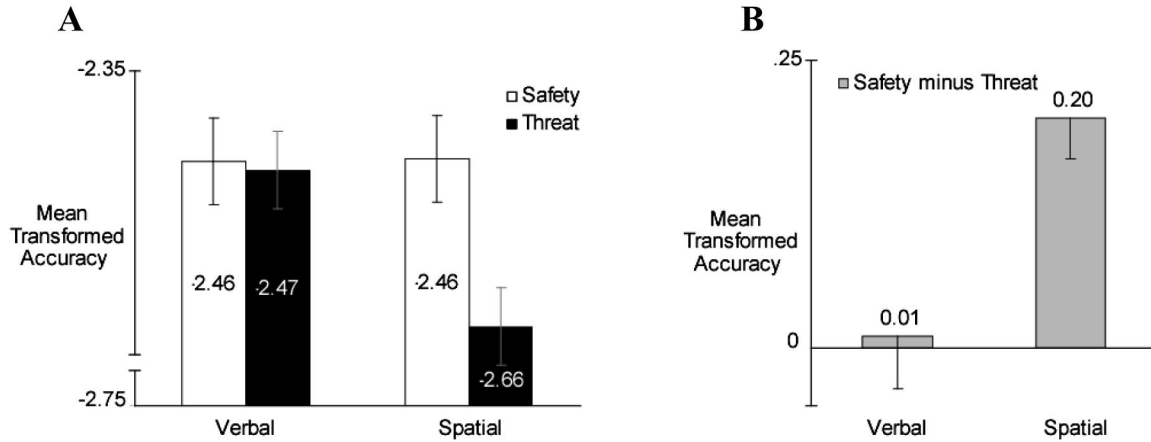

Figure 2. Mean transformed accuracy as a function of working memory task and threat-induced anxiety, Experiment 1. Accuracy data were transformed according to a doubly reflected third-root formula, $[-(101 - x)^{1/3}]$. Smaller numbers indicate worse performance. Figure 2A: Error bars on safety (white) means depict the within-subjects standard error of the verbal versus spatial contrast in the absence of threat. This was computed as the square root of the mean standard error for the contrast divided by the square root of n (Masson & Loftus, 2003). Likewise, error bars on threat (black) means depict the within-subject standard error of the verbal versus spatial contrast in the presence of threat. Figure 2B: Error bars on mean safety minus threat differences (gray) depict the simple within-subjects standard error of the anxiety contrast for the relevant task. Here, error bars that do not include zero indicate reliable differences, and larger numbers indicate relatively worse performance in the presence of threat compared to safety.

predictive of threat-induced decrements in spatial WM performance. Neither measure was predictive of variations in verbal performance under threat, $r_s < 1.22$, $p_s > .16$. Likewise, none of the self-report measures was reliably predictive of spatial performance under threat, $r_s < .23$, $p_s > .09$.

The results of the correlation analyses imply that threat-induced anxiety, as indexed by our two psychophysiological measures, mediated the deleterious effect of threat on the accuracy of spatial performance. To rigorously test this intuitively appealing notion, we conducted a formal test of statistical mediation (Baron & Kenny, 1986).⁵ For spatial accuracy under threat, the test of mediation was reliable for the corrugator EMG measure of anxiety, $z = 2.18$, $p = .03$, and nearly so for the startle measure of anxiety, $z = 1.89$, $p = .06$. Neither effect was reliable for verbal accuracy under threat, $p_s > .63$.

RT analyses. We conducted RT analyses on correct responses transformed to fourth roots (see Figure 4 and Table 1). Interpretation of the RT results was complicated by the fact that the verbal task was associated with slower performance than the spatial task in the absence of threat, $F(1, 54) = 20.2$, $p = 3.7 \times 10^{-5}$, $\eta^2 = .27$ (see Table 1 and Figure 4). Likewise, the main effect of task was reliable, $F(1, 53) = 20.1$, $p = 3.9 \times 10^{-5}$, $\eta^2 = .28$. These observations indicate that the tasks were characterized by dissimilar RTs, and thus the possibility exists that they were differentially sensitive to the impact of threat on performance speed (cf. Willis & Goodwin, 1987).⁶

To circumvent the impact of differential RTs on task performance, we performed control analyses on a subset of participants ($n = 26$; 62% from Experiment 1A; 46% female) in which we matched RT across tasks (see Figure 4 and Table 2). We performed matching using a variant of the technique employed by Gevins and Smith (2000; see also Barch, Carter, & Cohen, 2004). That is, we first computed the difference in RT between the verbal and spatial

three-back tasks in the absence of threat and then yoked the inclusion of participants with verbal biases (i.e., verbal slower than spatial) to those with spatial biases (i.e., spatial slower than verbal) of similar magnitude. We had no a priori reason to expect that the matching procedure would systematically bias tests of the main effect of anxiety or the Task \times Anxiety interaction. For the RT-matched sample, none of the omnibus or pairwise effects was reliable, $F_s < 1.6$, $p_s > .22$, $\eta^2_s < .06$.⁷

⁵ A variable, such as anxiety, is considered a mediator to the extent that it transmits the influence of an independent variable, such as our threat manipulation, to the dependent variable, here accuracy of performance. In the present case, demonstrating mediation required that we show that (a) threat modulated measures of anxiety, (b) threat modulated the accuracy of spatial WM performance, (c) changes in anxiety were predictive of changes in the accuracy of spatial performance, and (d) the impact of threat on the accuracy of spatial performance was attenuated when we removed the influence of anxiety. The first three criteria are satisfied by the results we have already presented. We can satisfy the fourth by computing a Sobel test (Baron & Kenny, 1986). We computed Sobel tests using software (<http://www.unc.edu/~preacher/sobel/sobel.htm>) run on regression coefficients computed using the Linear Mixed Models module in SPSS 12.0.

⁶ With this limitation in mind, we report the results of the other RT analyses. The main effect of anxiety, $p = .02$, and the Task \times Anxiety interaction were reliable, $p = .05$. Speed on the verbal task was reduced by threat, $p = .002$. There was no effect of anxiety on spatial RT, $F < 1$, indicating that changes in spatial accuracy under threat were not caused by speed-accuracy trade-offs.

⁷ For the RT-matched sample, the Task \times Anxiety interaction for performance accuracy was reliable, $p = .02$, $\eta^2 = .20$. Threat decreased spatial accuracy compared to safety, $p = 3.6 \times 10^{-4}$, and accuracy of verbal performance under threat, $p = .01$. The tasks showed similar accuracies at baseline, $F < 1$, $\eta^2 = .002$.

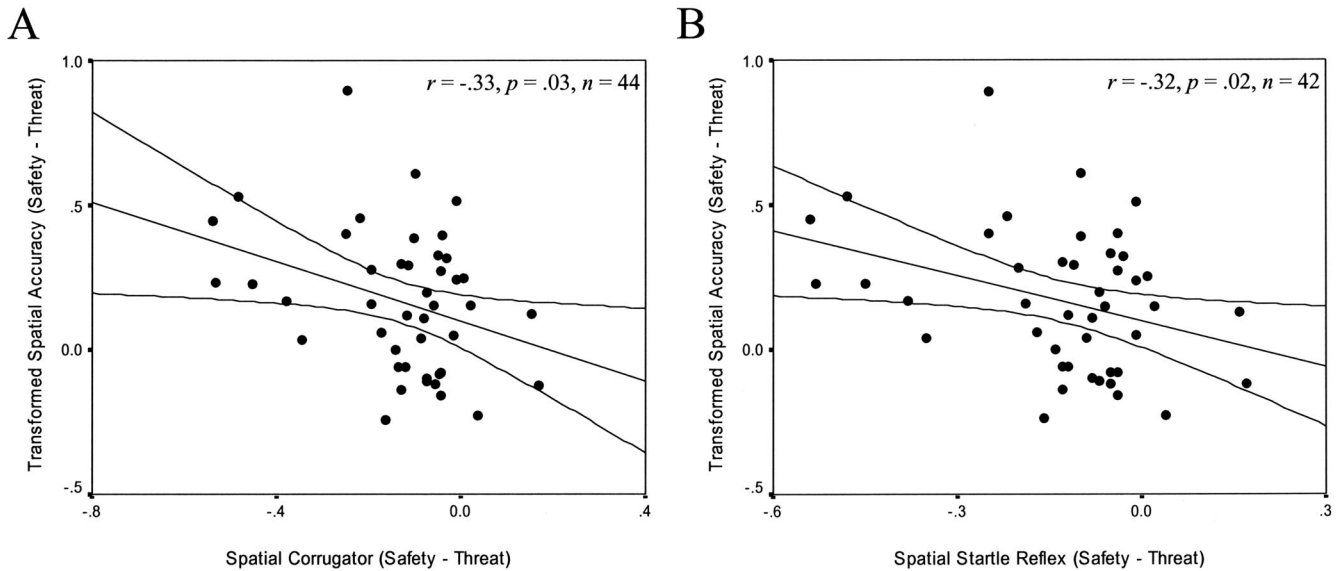

Figure 3. Individual differences in anxiety predict decrements in spatial performance under threat, Experiment 1. All variables depicted are safety minus threat difference scores. More positive values on the ordinate indicate relatively greater spatial performance decrements under threat, whereas more negative values on the abscissa indicate relatively more intense physiological anxiety. Confidence intervals are the regression slope \pm 95%. Figure 3A: Amplification of *corrugator supercilli* electromyographic (EMG) activity under threat predicted decrements in spatial working memory accuracy. Figure 3B: Potentiation of the startle reflex, measured as *orbicularis oculi* EMG activity, under threat likewise predicted decrements in spatial working memory accuracy. Neither physiological measure reliably predicted changes in verbal performance under threat, $ps > .17$.

Analyses examining the interdependence of accuracy and RT. We used an additional set of control analyses to examine the degree to which our accuracy results were determined by individual variations in RT across anxiety conditions. Such analyses represent the strongest possible test of linear speed–accuracy dependencies. In particular, when we entered the differences in RT under threat (i.e., safety minus threat difference scores) for each task as continuous predictors into the general linear models (GLMs) used for the accuracy analyses, the pattern of reliable omnibus and pairwise effects was identical to those reported above for both the overall sample, $F(1, 52) > 5.0$, $ps < .03$, $\eta^2s > .08$, and the RT-matched sample, $F(1, 23) > 4.5$, $ps < .05$, $\eta^2s > .16$. For the complete sample, the $RT \times Anxiety$ interaction was reliable for the spatial task, $F(1, 52) = 4.1$, $p = .05$, $\eta^2 = .07$. This can be attributed to the fact that individuals exhibiting larger decrements in spatial accuracy under threat also tended to react more slowly, $r = -.27$, $p = .05$, $n = 55$. These effects were not reliable for the RT-matched sample or the verbal task for either sample, $Fs < 1$.

Individual differences in baseline accuracy moderate the effects of threat. Prior work suggests that individual differences in general WM performance can moderate the differential impact of state affect on verbal and spatial performance (Gray, 2001). To effect a sensitive test of this hypothesis, we conducted GLMs separately for each task, with anxiety as a categorical predictor and baseline accuracy as a continuous predictor. We computed baseline accuracy as the mean accuracy of the verbal and spatial tasks in the absence of threat. Obtaining a reliable $Anxiety \times Baseline Accuracy$ interaction would indicate that the effects of threat upon

performance were significantly moderated by individual differences in general WM capability. For the spatial task, a reliable main effect of anxiety, $F(1, 53) = 13.4$, $p = .001$, $\eta^2 = .20$, was qualified by an $Anxiety \times Baseline Accuracy$ interaction, $F(1, 53) = 6.1$, $p = .02$, $\eta^2 = .10$. The moderating effect was due to the fact that individuals with relatively greater baseline accuracy showed greater interference (safety minus threat accuracy difference), $r = .32$, $p = .02$, $n = 55$. Both the effects revealed by the GLMs, $F(1, 53) > 4.6$, $ps < .04$, and the correlation, $r = .29$, $p = .04$, remained reliable when we entered individual differences in spatial RT across anxiety conditions (safety minus threat difference) as an additional predictor. We obtained a similar pattern of effects using an “extreme groups” analytic strategy (i.e., in which we treated participants with baseline accuracy in the upper and lower deciles as separate groups), which indicates that it was reasonable to treat the impact of individual differences in general WM performance as a linear moderator (cf. Tomarken, Davidson, Wheeler, & Doss, 1992). By contrast, analyses performed for the verbal task revealed no reliable effects, $F(1, 53) < 1$.

Discussion

Consistent with a novel prediction derived from consideration of the overlapping neural substrates of anxious arousal and visuospatial WM in the right PFC and PPC, we observed that threat-induced anxiety selectively attenuated the accuracy of spatial but not verbal WM performance. We found this for both the complete sample and Experiments 1A and 1B examined separately. We also found it when we controlled differences in mean RT across anxiety

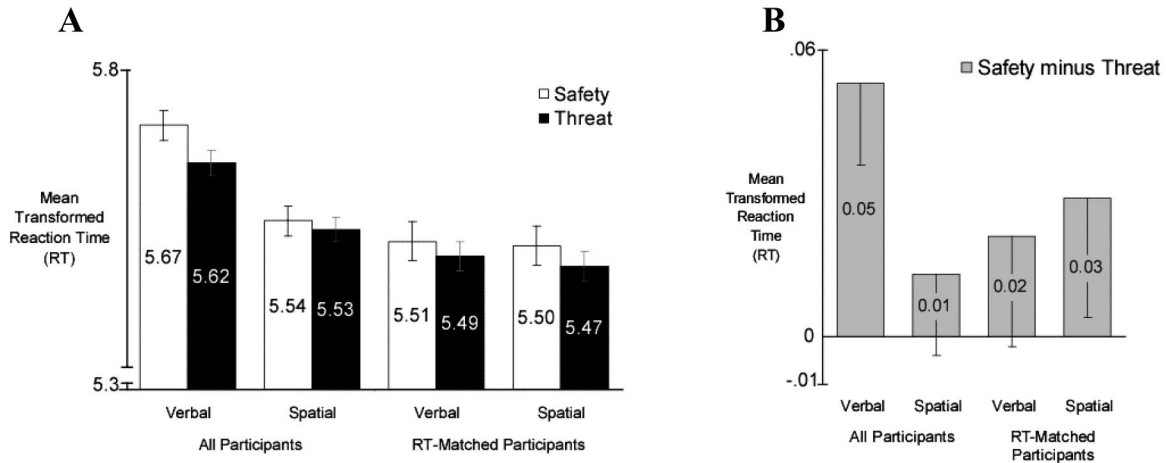

Figure 4. Mean transformed reaction time (RT) as a function of working memory task, threat-induced anxiety, and matching, Experiment 1. RT data were transformed to fourth roots. Means for all participants ($n = 55$) and the subset ($n = 26$) included in RT-matched analyses are displayed on the left and right sides of Panels A and B. We performed RT matching by computing the difference in RT between the verbal and spatial three-back tasks in the absence of threat and matching participants with verbal biases (i.e., verbal slower than spatial) to those with spatial biases (i.e., spatial slower than verbal) of similar magnitude. Thus, the matching procedure per se should not systematically bias tests of the main effect of anxiety or the Task \times Anxiety interaction. Figure 4A: Error bars on safety (white) and threat (black) means were computed as described in the caption to Figure 2. Larger numbers indicate slower performance. Figure 4B: Error bars on mean safety minus threat difference scores (gray) depict the within-subject standard error of the anxiety contrast for the relevant task. Larger numbers indicate faster performance under threat compared to safety. For the unmatched complete sample, threat was associated with quicker performance of the verbal task, $p = .002$. By contrast, there were no reliable effects of threat on either task for the RT-matched sample, $p_s > .22$.

conditions. Consistent with our second prediction, we demonstrated that individual differences in threat-induced anxiety, as indexed by corrugator EMG amplification and startle reflex potentiation, predicted the degree to which spatial performance was disrupted, providing some evidence that anxious arousal per se and not some other consequence of our threat procedure, was specifically responsible for the disruption of spatial WM. Similarly, we

Table 2
Mean Raw Three-Back Performance, Experiment 1 RT-Matched Participants

Condition	Verbal		Spatial		Verbal		Spatial	
	Accuracy	SEM	Accuracy	SEM	RT	SEM	RT	SEM
Safety	80.8	2.8	80.9	2.6	943	48	934	43
Threat	80.8	2.8	77.3	2.4	935	56	916	44

Note. Accuracy and reaction time (RT) are expressed in units of percentage correct and milliseconds, respectively. Of the original 55 participants in Experiment 1, 26 (47%) were included in the RT-matched analyses. We performed RT matching by computing the difference in RT between the verbal and spatial three-back tasks in the absence of threat and matching participants with verbal biases (i.e., verbal slower than spatial) to those with spatial biases (i.e., spatial slower than verbal) of similar magnitude. Thus, the matching procedure per se should not systematically bias tests of the main effect of anxiety or the Task \times Anxiety interaction. Raw (i.e., untransformed) between-subjects statistics are presented for descriptive purposes. Inferential statistics were conducted with transformed metrics and within-subjects measures of variance (see Experiment 1 *Results* section and Figure 4).

showed that threat-induced anxiety, as indexed by our two psychophysiological measures, statistically mediated the decrement in accuracy of spatial performance associated with threat.

Among participants with matched RTs, there were no reliable effects of threat on the speed with which either task was performed, contraindicating a speed-accuracy trade-off. More sensitive individual differences analyses revealed that participants who showed greater disruption of spatial accuracy under threat also tended to react more slowly on the spatial task. Taken together, the results of the RT analyses lend further credence to the conclusions we have drawn from the analyses of task accuracy.

In contrast to at least one study (Gray, 2001) showing that individuals characterized by relatively lower levels of WM performance were more sensitive to affective modulation of WM performance, we found that individuals characterized by higher performance of the three-back tasks in the absence of threat tended to show greater disruption of spatial accuracy under threat. Interestingly, Jenkins, Myerson, and Hle (1999) previously reported a pattern of this sort using a purely cognitive source of secondary interference.

Cognitive neurophysiological work suggests that individuals with relatively better performance tend to rely more heavily on task-specific strategies (e.g., Glabus et al., 2003; McNamara & Scott, 2001) and show patterns of task-elicited cerebral activation that are more task and/or hemisphere specific (e.g., Cabeza et al., 2004; Glabus et al., 2003; Gur et al., 2000; Papousek & Schuller, 2004). It has also been suggested that because high performers rely more heavily on controlled attention for mediating interference,

they tend to exhibit relatively greater interference than low performers when secondary (i.e., dual) task performance robs them of that advantage (Beilock & Carr, 2005; Kane & Engle, 2000; Miyake et al., 2000). They may exhibit other differences in the manner in which they allocate attention as well (Bleckley, Durso, Crutchfield, Engle, & Khanna, 2003). Finally, such individuals are also likely to be more consistently engaged in performing the task compared to low-performance/high-error participants. Any of these characteristics, in isolation or combination, tends to yield more specific disturbances of performance, as we have observed. By contrast, groups of low-performers (e.g., as determined by a mean or median split of an unselected sample) tend to contain a heterogeneous mixture of participants who rely upon suboptimal rehearsal strategies (e.g., a verbal strategy to perform the spatial *n*-back; Brandimonte, Hitch, & Bishop, 1992) and those who are simply bored, fatigued, or otherwise disengaged (Della Sala & Logie, 1997). If anything, these characteristics could even promote resilience to interference or compensatory accommodation (e.g., owing to free capacity; Vuontela et al., 1999).

Experiment 2

An alternative explanation for both our findings and those of Lavric et al. (2003), who also investigated the effects of threat on visuospatial WM performance, is that threat simply acts as an implicit (i.e., uninstructed) secondary spatial attention task and that this additional load on spatial attention, rather than anxiety per se, mediated the selective decrement in spatial WM performance. In other words, participants might simply have allocated a portion of their spatial attention to detecting the delivery of shocks to their wrist. Given the critical role ascribed by contemporary theory to spatial attention in the maintenance of visuospatial information in WM (Awh & Jonides, 2001; Pearson & Sahraie, 2003; Postle, Idzikowski, Della Sala, & Baddeley, in press), the competition for limited attentional resources engendered by such dual tasking would be expected to produce a pattern of deficits similar to that observed in Experiment 1.

Viewed from the perspective of this alternative account, the relations between anxiety, as measured by our physiological indexes, and decrements in spatial performance under threat may simply be indexing participants' motivation to vigilantly attend to the location in somatosensory space of potential shock delivery, rather than causally mediating those decrements. In sum, this view posits that the elicitation of anxiety is neither sufficient nor necessary for the disruption of spatial WM by threat of shock. Unfortunately, the data yielded by Experiment 1 cannot definitively resolve these competing accounts. Prior work indicating that the amount of startle potentiation elicited by motivated attention is likely to be small but not insignificant compared to that elicited by shock threat (e.g., Böcker, Baas, Kenemans, & Verbaten, 2004) also provides no clear-cut resolution.

The aim of Experiment 2, therefore, was to directly investigate the degree to which the relationship between anxiety and spatial WM performance is independent of the particular threat manipulation used in Experiment 1. To this end, we examined the effects of state anxiety on WM performance in the absence of any explicit affect manipulation (cf. Maxwell, Shackman, & Davidson, 2005). To reliably elicit measurable state anxiety, we adopted an approach that capitalizes on individual differences in trait emotional reac-

tivity, what Davidson (1998; Davidson & Irwin, 1999) has termed *affective style*.

It has been suggested that individuals who score highly on Carver and White's (1994) Behavioral Inhibition System (BIS) scale are predisposed to react with more intense negative affect in response to cues perceived as threatening (e.g., Carver & White, 1994; Gable, Reis, & Elliott, 2000; Leen-Feldner, Zvolensky, & Feldner, 2004; Updegraff, Gable, & Taylor, 2004).⁸ This is consistent with findings showing that individuals with relatively right prefrontal electroencephalogram (EEG) asymmetry also tend to score more highly on the BIS scale (Harmon-Jones & Allen, 1997; Sutton & Davidson, 1997). We therefore predicted that participants recruited on the basis of extreme BIS scores would be predisposed to react to the relatively innocuous challenge of a laboratory visit and WM "test" with more intense anxiety and that the magnitude of that anxiety would moderate relatively less accurate spatial WM performance. A second group of participants recruited on the basis of extreme scores on Carver and White's (1994) Behavioral Activation System (BAS) scale served as a comparison group. It is thought that individuals with higher BAS scores are predisposed to react with more intense drive or behavioral approach in response to cues perceived as appetitive. This conceptualization is in accord with the observed association between BAS scores and relatively greater left prefrontal EEG asymmetry at baseline (Coan & Allen, 2003a; Harmon-Jones & Allen, 1997; Sutton & Davidson, 1997). On the basis of past findings (e.g., Updegraff et al., 2004), we predicted that such individuals would tend to experience little anxiety in response to the laboratory visit and, consequently, would show no systematic relationship between state anxiety and spatial WM performance.

Method

Participants. We recruited 42 right-handed undergraduates on the basis of stable and extreme scores on the BIS-BAS questionnaire. We administered the BIS-BAS measure to a sample of 3,479 undergraduates enrolled in an introductory psychology course at the University of Wisconsin—Madison. On the basis of this initial mass survey, we identified participants who scored in the upper 30% on the BIS and the lower 30% on the BAS (high BIS/low BAS; the BIS group) scales or vice versa (high BAS/low BIS; the BAS group). We contacted potential participants and recruited them to participate in a research program investigating the neurophysiological underpinnings of affective style (e.g., Pizzagalli, Greischar, & Davidson, 2003). In an initial laboratory session, we administered the BIS-BAS questionnaire a second time and classified groups of 22 (BIS) and 20 (BAS) participants, each composed of equal numbers of men and women, as showing stable and extreme scores on the BIS-BAS instrument. Descriptive statistics of the self-report data are presented in Table 3.

⁸ The BIS was administered to participants in Experiment 1A. Consistent with the notion that BIS scores reflect a tendency to react with more intense negative affect, among RT-matched participants, BIS scores predicted amplification of corrugator EMG under threat during spatial performance, $r = -.60$, $p = .02$, and, albeit nonsignificantly, during verbal performance, $r = -.40$, $p = .18$. Moreover, the Anxiety \times BIS interaction for spatial RT was reliable for the complete sample, $p = .02$, and nearly so for the RT-matched sample, $p = .06$. Individuals with higher BIS scores reacted more slowly on the spatial task under threat, $r_s > |.44|$ and $p_s < .02$ for the complete and RT-matched samples.

Table 3
Mean Self-Report Data, Experiment 2

Group	BIS		BAS		STAI State	
	<i>M</i>	<i>SEM</i>	<i>M</i>	<i>SEM</i>	<i>M</i>	<i>SEM</i>
High BIS/low BAS	24.8	.31	35.1	.49	39.5	1.5
High BAS/low BIS	16.2	.55	47.7	.56	30.3	1.6

Note. Participants were recruited on the basis of stable and extreme scores on Carver and White's (1994) Behavioral Inhibition System (BIS) and Behavioral Activation System (BAS) scales. High BIS/low BAS (BIS) and high BAS/low BIS (BAS) groups were composed of 22 and 20 participants, respectively, with each group composed of equal numbers of men and women. BIS and BAS scores represent the mean of two administrations, an initial administration used to identify extreme individuals and a follow-up administration on the day of the working memory experiment. State ratings of anxiety in response to the laboratory visit were made at the beginning of the experimental session with the State version of Spielberger's (1983) State-Trait Anxiety Inventory (STAI). Each of the three scales showed a reliable difference across groups, $ps < .05$.

Design and materials. During the laboratory visit, participants completed verbal and spatial three-back WM tasks identical to those employed in Experiment 1A. To quantify the degree of anxiety elicited by the visit, we also had participants complete the state version of Spielberger's (1983) State-Trait Anxiety Inventory (STAI).

Results

As in Experiment 1, we used diagnostic procedures to ensure that parametric test assumptions were satisfied, and, where neces-

sary, we transformed the data. We also confirmed that our classification procedure was successful: The groups reliably differed on the BIS and BAS scales in the predicted directions, $F_s(1, 40) > 192$, $ps < 8.0 \times 10^{-17}$ (see Table 3).

Prediction 1: The BIS group will experience greater anxiety in response to visiting the laboratory. Consistent with our prediction, participants in the BIS group rated themselves as experiencing greater anxiety in the laboratory than did those in the BAS group, $F(1, 40) = 18.4$, $p = 1.1 \times 10^{-4}$, $\eta^2 = .32$. This is displayed in Table 3.

Prediction 2: Intensity of state anxiety will moderate spatial-verbal performance bias. We transformed accuracy data according to the formula $[-(101 - x)^{4/5}]$ (see Figure 5 and Table 4). For the BIS group, a reliable main effect of task, $F(1, 20) = 5.3$, $p = .03$, $\eta^2 = .21$, was qualified by the predicted Task \times STAI anxiety interaction, $F(1, 20) = 6.5$, $p = .02$, $\eta^2 = .25$. Thus, participants in the BIS group tended to perform the spatial task less accurately than the verbal task, and the degree to which individuals showed that bias (i.e., verbal minus spatial difference score) was moderated by their ratings of state anxiety, $r = .50$, $p = .02$ (see Figure 6). Consistent with our prediction, none of the effects tested by the GLM was reliable for the BAS group, $F_s(1, 18) < 1$, $\eta^2 s < .007$. An analysis of accuracy with the two groups (i.e., BIS and BAS) as a between-subjects factor likewise failed to reveal a reliable difference between tasks, $F(1, 42) < 1$, $\eta^2 = .002$. The task contrast was not qualified by BIS-BAS group, $F(1, 42) = 1.2$, $p = .84$, $\eta^2 = .03$. An additional set of analysis showed that none of the zero-order correlations between (a) the BIS, the BAS, or their difference (cf. Sutton & Davidson, 1997) scores and (b) verbal

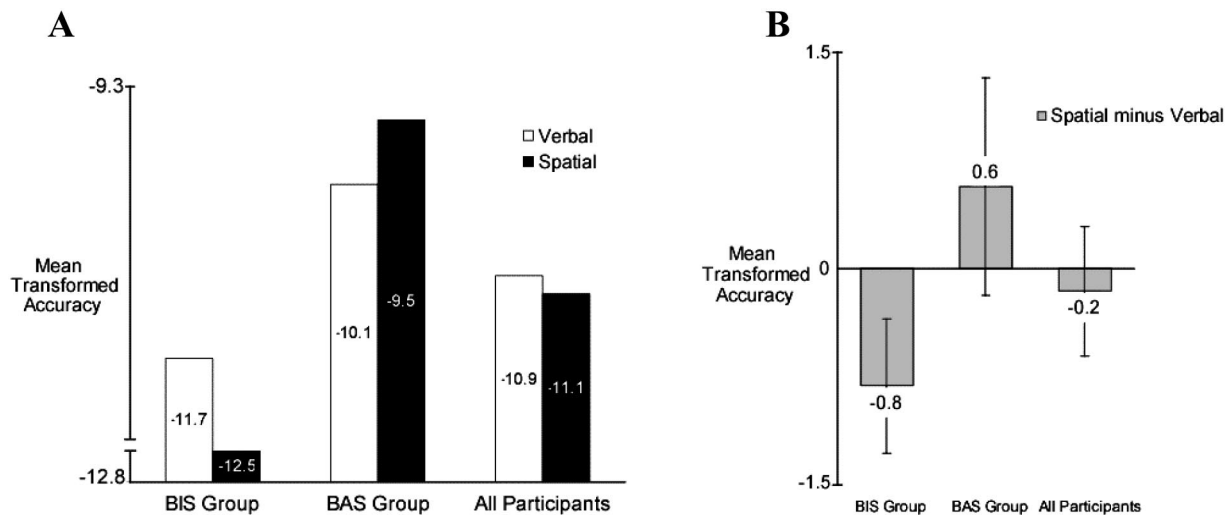

Figure 5. Mean transformed accuracy as a function of working memory task and BIS/BAS group, Experiment 2. Accuracy data were transformed according to the formula $[-(101 - x)^{4/5}]$ following Tukey (1977). Smaller numbers indicate worse performance. Figure 5A: High BIS/low BAS (BIS) and high BAS/low BIS (BAS) groups were composed of 22 and 20 participants, respectively. Figure 5B: Error bars on mean spatial minus verbal differences (gray) depict the within-subjects standard error of the contrast between tasks. Error bars that do not include zero indicate reliable differences between tasks for that group, and smaller numbers indicate relatively worse performance on the spatial task.

Table 4
Mean Raw Three-Back Performance, Experiment 2

Group	Verbal		Spatial		Verbal		Spatial	
	Accuracy	SEM	Accuracy	SEM	RT	SEM	RT	SEM
High BIS/low BAS	78.8	2.6	77.0	2.5	1,069	36	974	40
High BAS/low BIS	82.6	1.9	83.9	1.8	973	45	913	49
All participants	80.6	1.6	80.3	1.6	1,024	29	945	31

Note. Participants were recruited on the basis of stable and extreme scores on Carver and White's (1994) Behavioral Inhibition System (BIS) and Behavioral Activation System (BAS) scales. High BIS/low BAS (BIS) and High BAS/low BIS (BAS) groups were composed of 22 and 20 participants, respectively. Raw (i.e., untransformed) between-subjects statistics are presented for descriptive purposes. Inferential statistics were conducted with a transformed accuracy metric and within-subject measures of variance (see Experiment 2 Results section and Figures 3 and 5). RT = reaction time.

and spatial accuracy, computed separately for each BIS–BAS group, was reliable.⁹

RT analyses. RT analyses were based on correct responses only (see Figure 7 and Table 4). None of the effects was reliable for either group, $F_s < 1.1$, $\eta^2_s < .06$. As in Experiment 1, we used a set of control analyses to examine the degree to which our accuracy results were determined by variations in RT across tasks. In particular, for the BIS group, we found that both the effects tested in the GLM, $F_s(1, 19) > 4.7$, $p_s < .05$, $\eta^2_s > .20$, as well as the correlation, $r = .53$, $p = .01$, remained reliable when we included the effects of RT differences across tasks as predictors. Interestingly, for the BIS group, we found that between-tasks differences in RT reliably moderated between-tasks differences in accuracy, $F(1, 19) = 7.5$, $p = .01$, $\eta^2 = .28$. We attribute this to the fact that high-BIS individuals characterized by less accurate performance on the spatial task also tended to show relatively slower performance, $r = -.50$, $p = .02$. None of these effects was reliable for the BAS group.

Discussion

The aim of this experiment was to test the possibility that the selective disruption of spatial WM performance we obtained in Experiment 1 represented an artifact of the intrinsically spatial nature of threat of shock and that the elicitation of anxiety by threat is neither a sufficient nor a necessary mediator of that effect. The results of Experiment 2 clearly reject such an account. Consistent with our first prediction, we observed that individuals characterized by stable and extreme scores on a self-report measure (i.e., the BIS scale), putatively tapping the predisposition to react with more intense negative affect to perceived threat (Sutton & Davidson, 1997), reacted with greater anxiety to a simple laboratory visit compared to a comparison group of participants specifically chosen to experience little anxiety in response to such an innocuous cue. Consistent with our second prediction, we found that the magnitude of anxiety experienced by high-BIS participants was associated with relatively worse performance on the spatial, compared to the verbal, three-back WM task. As predicted, we observed no similar relations for the high-BAS participants. Under-scoring the specificity of this finding to state anxiety, rather than some preexisting cognitive difference between the groups, BIS and BAS scores were themselves not systematically related to differential task performance. Taken as a whole, this pattern of results

strengthens our assertion that anxious arousal is responsible for the selective disruption of spatial WM performance we and others (e.g., Lavric et al., 2003) have observed using threat of shock procedures.

General Discussion

A substantial corpus of data suggests that states of anxious arousal and visuospatial WM have in common an asymmetric reliance on the right PFC and PPC. On the basis of this relationship and neurophysiologically informed theories of dual-process interference, we predicted that threat-induced anxiety would selectively disrupt visuospatial WM performance. In accord with this prediction, we found that anxiety selectively disrupted performance accuracy of a spatial WM task, while sparing performance of a psychometrically equivalent verbal WM task thought to asymmetrically rely on the left hemisphere. We found this in two independent samples of participants who exhibited measurable physiological signs of anxiety in response to the threat manipulation. The use of mere threat in Experiment 1B further precludes the possibility that our results were unintentionally confounded by the nociceptive consequences of shock delivery. We obtained congruent findings in Experiments 1 and 2 for analyses of performance speed: Threat-associated decrements in accuracy were accompanied, albeit less consistently, by slower RTs.

Concordant with our other major prediction, we found that anxiety (i.e., valence-sensitive psychophysiological measures) statistically mediated the degree to which spatial performance was disrupted. This suggests that anxiety per se, not some other consequence of our threat procedure, was responsible for the disruption of spatial WM. By contrast, prior studies' (e.g., Christianson, 1986; Lavric et al., 2003) use of alternative measures that are insensitive to valence does not permit one to rule out a role for

⁹ For the high-BIS group, larger BIS–BAS difference scores were associated with more intense anxiety, $r = .56$, $p = .01$; there was no association for the high-BAS group, $p = .46$. The difference between groups was not reliable, $p = .17$. To allow more powerful tests of relations between BIS–BAS scores and anxiety (e.g., Gable et al., 2000), we combined the groups ($n = 42$) with 16 additional participants who had failed to show stable BIS–BAS scores (total $n = 58$). BIS, $r = .55$; BAS, $r = -.51$; and BIS–BAS difference scores, $r = .55$, were predictive of anxiety, $p_s < .001$. Spearman rank-order correlations revealed similar relations, $\rho_s > 1.541$.

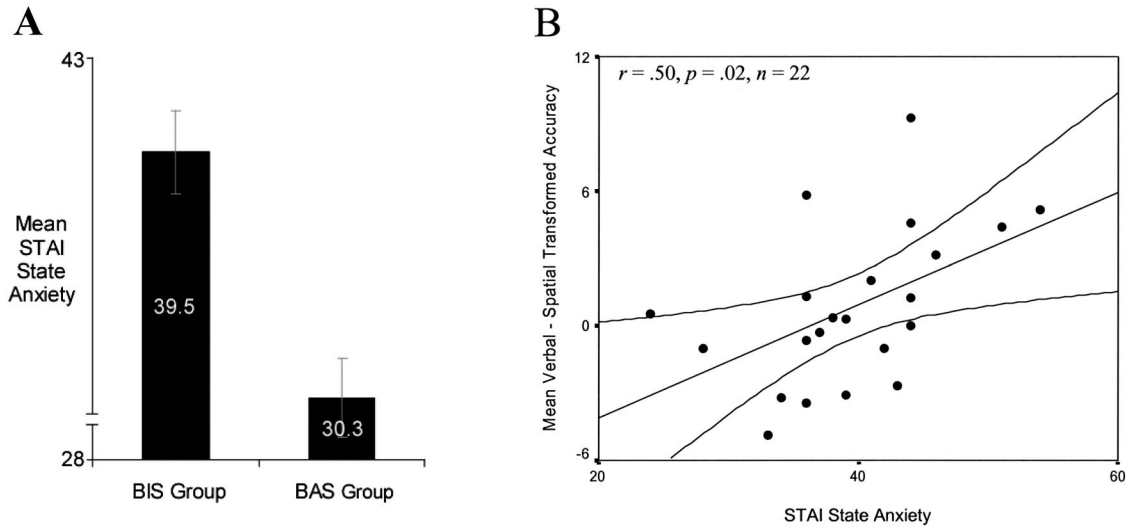

Figure 6. Figure 6A: The high BIS/low BAS (BIS) group ($n = 22$) rated themselves as experiencing greater state anxiety on the STAI measure in response to their laboratory visit compared to the high BAS/low BIS (BAS) group ($n = 20$), $p < .001$. Error bars depict the standard error of the mean. Figure 6B: Furthermore, individuals in the BIS group who rated themselves as experiencing more anxiety also tended to show relatively worse accuracy on the spatial compared to the verbal working memory task, $r = .50$, $p = .02$. The correlation was not reliable for the BAS group, $p = .84$. Confidence intervals are the regression slope $\pm 95\%$.

nonspecific arousal/load or motivated attention. A limitation of this inference is that because the present study did not include a positive arousal condition, we cannot unequivocally rule out the possibility that a state of highly arousing positive affect, such as that elicited by erotica (e.g., Bradley et al., 2001; S. R. Schmidt, 2002), would not similarly disrupt spatial WM performance.

We do not consider that a strong possibility, given functional neuroimaging (e.g., Murphy et al., 2003), EEG (e.g., Coan & Allen, 2003b, 2004), and lesion (e.g., Davidson, 1998) data demonstrating that arousing states of approach-oriented positive affect

are asymmetrically associated with the left PFC. From the perspective of a hemispheric asymmetry framework, such data lead us to predict that task-irrelevant states of positive affect should attenuate performance of cognitive processes that are asymmetrically associated with the left PFC (e.g., verbal WM), while sparing spatial WM. Work at the nonhuman level is consistent with this prediction. Woodson, Macintosh, Fleshner, and Diamond (2003), for example, recently showed that increases in incidental arousal associated with exposure to a predator (i.e., cat), as indexed by the stress-linked hormone corticosterone, mediated decrements in spa-

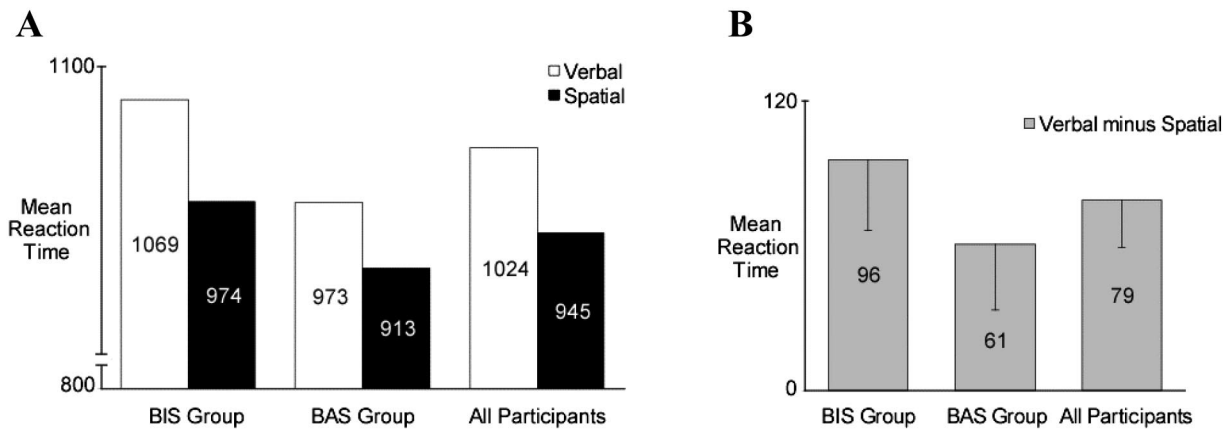

Figure 7. Mean reaction time (RT; in ms) as a function of working memory task and BIS/BAS group, Experiment 2. Figure 7A: High BIS/low BAS (BIS) and high BAS/low BIS (BAS) groups were composed of 22 and 20 participants, respectively. Figure 7B: Error bars on mean verbal minus spatial differences (gray) depict the within-subjects standard error of the contrast between tasks for each group. Larger numbers indicate relatively faster performance of the spatial task. There was not a reliable difference in RT across tasks for either the BIS or the BAS group, $F_s < 1.1$.

tial WM performance, whereas equivalent increases elicited by a sexually receptive conspecific were not associated with performance decrements.

In Experiment 2 we tested the alternative possibility that the disruption of spatial WM performance that we and others (Lavric et al., 2003) have observed represents an artifact of the additional load placed on spatial attention—the mechanism by which spatial information is thought to be maintained in WM—by our threat of shock procedure. To robustly elicit anxiety without relying on threat of shock, we recruited participants on the basis of stable and extreme scores on the BIS scale (Carver & White, 1994), thought to index a predisposition to respond to perceived threats with relatively intense negative affect. The results of this experiment led to unambiguous rejection of the motivated spatial attention account. Relative to a comparison group, participants classified as high BIS reacted to an innocuous laboratory visit with relatively intense anxiety, and individual differences in the magnitude of that anxiety were predictive of worse performance on the same spatial WM task employed in Experiment 1. We did not find similar relations for the comparison group. Underscoring the specificity of these results to states of anxious arousal rather than to some preexisting cognitive difference between the groups, the trait measures of affective style used to select participants were not systematically related to differential task performance. Taken together, these results support our inference that it was specifically the elicitation of anxiety under threat that mediated the selective disruption of spatial WM performance.

The Potential Role of Visuospatial Attention as a Proximal Cause

We agree with Lavric et al. (2003) that the deleterious impact of task-irrelevant anxiety on spatial WM performance is likely to be mediated by competition between task-relevant and anxiety-relevant goals for limited visuospatial attention resources localized to the right PFC and PPC. The rehearsal of metrically coded spatial but not verbal information in WM is thought to depend on the allocation of attention to stored locations (Awh & Jonides, 2001; Pearson & Sahraie, 2003; Postle et al., in press), and this process is thought to be lateralized to the right PFC and PPC (e.g., Awh & Jonides, 2001; Corballis et al., 2002; Manoach et al., 2004; Müri et al., 2000). Thus, insofar as task-irrelevant anxiety entails the activation of visuospatial attention or the biasing of visuospatial attention in the service of anxiety-relevant goals, these right-hemisphere resources will be less available to support spatial WM performance. This hypothesis is consistent with the long-standing suggestion that anxiety tends to disrupt the efficient allocation of spatial attention (Easterbrook, 1959; Janelle, 2002). It is also broadly consistent with Moore and Oaksford's (2002) recent demonstration that negative mood selectively disrupted performance of an attentionally demanding nonmnemonic spatial discrimination task, while sparing performance of a psychometrically matched verbal task.

Comparison With Prior Work

Our results are clearly consistent with models of dual processing (e.g., Kinsbourne & Hicks, 1978) positing that when two operations simultaneously engage resources lateralized to a particular

hemisphere, performance suffers as a consequence of resource depletion or cross-talk interference. They are also in line with a nascent body of behavioral (Baddeley, 1972; Hartikainen, Ogawa, & Knight, 2000; Holmes, Brewin, & Hennessy, 2004; Idzikowski & Baddeley, 1983; Lavric et al., 2003; Maxwell et al., 2005; Moore & Oaksford, 2002) and functional neuroimaging (e.g., Richeson et al., 2003) studies suggesting that the locus of interference between (a) task-irrelevant negative affect and (b) cognitive control and other types of executive attention is likely to be localized to the right PFC or PPC.

The observation that threat-induced anxiety selectively disrupts spatial performance is also concordant with a variety of neurophysiological studies. In humans, for example, Young, Sahakian, Robbins, and Cowen (1999) have shown that administration of the stress hormone hydrocortisone disrupted spatial WM performance, while sparing performance of a planning task (i.e., Tower of London) associated with the left dorsolateral PFC (e.g., Beauchamp, Dagher, Aston, & Doyon, 2003; Cazalis et al., 2003). More recently, Young et al. (2004) reported that antigluocorticoid treatment selectively improved deficits in spatial but not verbal WM performance exhibited by patients with chronic hypercortisolemia.

By contrast, our conclusions might appear to contradict those reported by Gray (2001) on the basis of an investigation of the impact of positive and negative mood elicited by film clips on subsequent verbal and spatial two-back performance. He concluded that "spatial 2-back performance was enhanced by a withdrawal state and impaired by an approach state; [whereas] the opposite pattern held for verbal performance" (p. 436). However, the results of the major experiment in that report (Experiment 2) suggest a more complex story. For measures of accuracy, the critical Task \times Affect interaction was not reliable for either the complete sample ($N = 128$) or a subset of participants with lower overall performance (high-error group). Consistent with our findings, however, the Task \times Affect interaction for accuracy was reliable for the subset of participants with higher overall performance (low-error group) such that spatial accuracy was attenuated and verbal accuracy was facilitated after participants viewed a negative compared to a neutral film clip. Unfortunately, interpretation of that finding was limited by the presence of a significant speed-accuracy trade-off.

On the other hand, in two other experiments using smaller samples, Gray (2001, Experiment 1; Gray et al., 2002) reported a pattern of results for performance accuracy that is more clearly consistent with his assertion that negative mood tends to facilitate visuospatial and disrupt verbal WM. Furthermore, across multiple experiments, he has consistently demonstrated just such an effect for analyses of performance speed, particularly among low-performing (high-error) participants.

There are a number of methodological differences between our study and Gray's (2001; Gray et al., 2002) work that plausibly contribute to the inconsistency of our findings. For example, the intensity of anxiety reported by Gray's (2001, Experiment 1) participants in response to viewing the negative film clip was approximately half that elicited by the threat manipulation employed by both Lavric et al. (2003) and us. To the extent that the effects of anxiety upon WM performance obey an inverted-U function (Christianson, 1992; Easterbrook, 1959; Janelle, 2002), the more modest level of anxiety produced by Gray's negative film

would tend to enhance performance of spatial WM, whereas the supraoptimal level of anxiety evoked by threat of shock would be sufficient to disrupt performance. This speculation is supported by work demonstrating just such a dose–response relationship between concentrations of catecholamines in the PFC and spatial WM performance (e.g., Arnsten, 1998; Honey & Bullmore, 2004; Kimberg, Aguirre, Lease, & D’Esposito, 2001).

Another relevant difference between our work and Gray’s (2001; Gray et al., 2002) is the ambiguity of his affect manipulation. Gray (2001; Gray et al., 2002) did not collect any well-validated measures of affect, apart from performance, for the period in which the WM tasks were performed (cf. our Desideratum 4). Davidson, Ekman, et al. (1990) have examined the impact of affective film clips similar to those employed by Gray on asymmetric prefrontal activity. In contrast to threat of shock procedures (e.g., Dalton et al., 2005), they found that viewing negative films produced systematic shifts in frontal EEG asymmetry that were limited to only those epochs that were coincident with overt facial expressions of affect. Similarly transient effects have been found, for example, with skin conductance measures in response to negative films (e.g., Gross, 1998; Lazarus et al., 1952).

This implies that a different neurobiological mechanism, one with a slower time constant than those underlying the more clearly stimulus-locked changes characterizing many affectively modulated physiological measures (e.g., skin conductance, corrugator EMG, startle, prefrontal EEG asymmetry), must be invoked to explain Gray’s (2001; Gray et al., 2002) results. Put another way, his results are unlikely to be mediated by the sorts of direct competitive or cross-talk processes that we have suggested underlie decrements in spatial WM performance in the presence of task-irrelevant anxiety. In a subsequent report, Gray et al. (2002) made a similar suggestion, indicating that their pattern of facilitation probably reflects the indirect moderation of task-related circuitry by affect.

Given the paucity of work examining the functional neuroanatomy of moods and other, more enduring affective phenomena (Ekman & Davidson, 1994), it is difficult to speculate about what this mechanism may be, but affect-induced changes in circulating cortisol, which take tens of minutes to peak (Dickerson & Kemeny, 2004) and can be elicited by aversive film clips (e.g., Codispoti et al., 2003; Gerra et al., 2003), are one possibility. Affect-induced changes in catecholamine transmission are another (e.g., Arnsten & Goldman-Rakic, 1998).¹⁰ Repetition priming or other forms of neural adaptation are a third (Davidson, Maxwell, & Shackman, 2004).

Implications for Eysenck and Calvo’s (1992) Theory of Anxiety × Cognition Interactions

Although they clearly show convergence with a wide variety of other work, both our findings and those of Lavric et al. (2003) seem to contradict the predictions made by Eysenck and Calvo’s (1992) prominent account of the effects of anxiety upon cognition. Surveying a variety of data, they argued that the deleterious effects of anxiety on cognition arise as a consequence of task-irrelevant worrisome thoughts depleting resources otherwise available to support WM, in particular central executive resources. In light of the phonological nature of worrisome thoughts, the authors more tentatively proposed that anxiety tended to disproportionately dis-

rupt the performance of tasks reliant on verbal WM. However, we found neither a general impairment of WM performance, as one might expect if general processing resources were depleted by anxiety, nor a selective impairment of verbal WM performance.

A plausible explanation for this inconsistency comes from a consideration of the origins of Eysenck and Calvo’s (1992) model. Their model was largely founded on data describing the impact of academic test anxiety on performance. Earlier theorists in that domain had suggested that anxiety can be fractionated into at least two distinct facets, *worry* and *anxious arousal* (for a review, see Bradley, 2000). The essence of worry—or what has more recently been termed *anxious apprehension* (e.g., Heller, Nitschke, Etienne, & Miller, 1997)—is mental, particularly verbal, rumination and evaluation apprehension, whereas anxious arousal involves attention to the physiological symptoms of anxiety. It is important to note that the data available to Eysenck and Calvo indicated that the impact on performance of academic testing and testlike provocations employed in laboratory studies was mediated by anxious apprehension, not anxious arousal (e.g., Doctor & Altman, 1969; Morris et al., 1981; Sarason, 1960). Thus, Eysenck and Calvo’s model seems to primarily address the impact of anxious apprehension rather than anxious arousal on cognitive performance. In addition, unlike the laboratory provocations (e.g., threat of failure) commonly used to study test anxiety, threat of shock seems to primarily amplify anxious arousal (Hodges, 1968; Morris & Liebert, 1973). Moreover, predispositions to experience anxious apprehension and anxious arousal seem to have at least partially dissociable neural substrates (Nitschke et al., 1999).

Together, these data suggest that observations demonstrating that threat selectively disrupts spatial WM are inconsistent with Eysenck and Calvo’s (1992) model because they are primarily mediated by anxious arousal, whereas the model primarily addresses the consequences of anxious apprehension on cognition. A comprehensive model of anxiety’s impact on cognition needs to account for the differential impact of both facets.

Implications for Understanding How Affective Traits Impact Behavior

More generally, our findings support the idea that the functional relationship linking affective traits to behavioral outcomes can

¹⁰ Stress-induced increases in cortisol and catecholamine transmission are thought to alter the signal-to-noise ratio of information processing, particularly in the PFC (e.g., Arnsten, 1998; Arnsten & Goldman-Rakic, 1998; Cohen, Braver, & O’Reilly, 1996). Manipulations of catecholamines (Luciana & Collins, 1997) and cortisol (e.g., Young et al., 1999, 2004) disproportionately impact the performance of spatial relative to verbal tasks. Likewise, stress is known to reduce circulating levels of the androgen testosterone (e.g., Hellhammer, Hubert & Schürmeyer, 1985), which, in turn, has been shown to selectively modulate visuospatial, compared to verbal, performance (e.g., Duff & Hampson, 2001). Hemispheric asymmetries likely contribute to the cognitive selectivity of these neurochemical changes (Gouchie & Kimura, 1991). Like visuospatial cognition and anxiety, there is evidence suggesting that stress-induced changes in prefrontal catecholamine neurotransmission are right lateralized (Berridge, España, & Stalnaker, 2003). Some researchers have likewise argued that the key neural circuitry responsible for cortisol release, the hypothalamic–pituitary–adrenal axis, is under relatively greater control by the right hemisphere (Wittling, 1997).

represent a combination of moderator and mediator effects (Baron & Kenny, 1986). That is, individual differences in enduring affective traits, such as behavioral inhibition, may act as moderators of state affect, rendering individuals susceptible to experiencing particular kinds or intensities of affect (e.g., anxiety) in response to challenges (e.g., Carver & White, 1994; Gable et al., 2000; Leenfeldner et al., 2004; Updegraff et al., 2004). This view is in accord with earlier suggestions made by students of individual differences (Berenbaum & Williams, 1995; Gross, Sutton, & Ketelaar, 1998; Marco & Suls, 1993; Rusting, 1998, 2001) and affective neuroscience (Coan & Allen, 2004; Tomarken, Davidson, & Henriques, 1990; Tomarken, Davidson, Wheeler, & Doss, 1992b).

To the degree that such emotions are elicited, they would be available to mediate relations between affective traits and behavior, as in our Experiment 1. For example, Bell and Fox's (2003) recent observation that a negative affective style is associated with relatively worse visuospatial compared to verbal task performance is likely to have been mediated by the more intense negative affect experienced by such individuals in response to visiting the laboratory. From a methodological perspective, neurophysiological (e.g., Canli, Sivers, Whitfield, Gotlib, & Gabrieli, 2002; Gray & Braver, 2002; Kumari, Ffytche, Williams, & Gray, 2004) and behavioral (e.g., Matthews, Fox, Yiend, & Calder, 2003) investigations of the relations between affective style and behavior are likely to profit from the theoretical clarity afforded by formal moderator and mediator analyses. An important topic for future work is to determine whether affective traits primarily moderate the likelihood, peak intensity, duration, or some other parameter of affective states (Davidson, 1998).

Conclusions

Dealing efficiently with complexity and responding flexibly in the face of novelty are hallmarks of normative human behavior. There is theoretical consensus that these features emerge from the active maintenance of goal representations in more dorsal and lateral sectors of the PFC and that the PFC employs these representations to bias attention, information processing (e.g., planning, memory retrieval), and actions in favor of goal-relevant alternatives (Corbetta & Shulman, 2002; Kane & Engel, 2002; Miller & Cohen, 2001). This executive control is thought to sustain goal-consistent behavior in the face of interference from competing stimuli and actions (Chao & Knight, 1995; Kane & Engle, 2000; Postle, in press).

Although it has long been argued that affect plays a critical role in determining the relevance of competing goals (e.g., forage vs. avoid predators) and, in turn, orchestrating adaptive behavior, the details of this process have remained elusive. In particular, observations that emotions such as anxiety are associated with activation of the dorsolateral PFC (e.g., Dalton et al., 2005) seemed difficult to reconcile with the widely held view that affective states are primarily instantiated in ventromedial areas of the PFC and only modulate areas along the lateral convexity insofar as they tend to passively deactivate them or otherwise take them functionally "off-line" (e.g., Drevets & Raichle, 1998; Goldman-Rakic, 1998; A. C. Roberts & Wallis, 2000; Tranel et al., 2002; Yamasaki, LaBar, & McCarthy, 2002). This inconsistency led several commentators (Davidson, 2004; Shackman, 2000; Tomarken &

Keener, 1998) to wonder, what exactly does the affect-evoked activation of dorsal and lateral sectors of the PFC represent?

It has been suggested that affect-related activation of the dorsal and lateral sectors of the PFC does not represent feelings (Davidson & Irwin, 1999) but instead represents a kind of *affective WM* (Davidson, 1994; Davidson et al., 2002) or *affective control* (Gray, 2001, 2004), a transiently maintained representation of an affective goal set used to bias cognition and action in favor of alternatives (e.g., vigilance, termination of ongoing appetitive behaviors, preparation for flight) appropriate to the state of anxiety. Support for this hypothesis comes from recent studies in monkeys (Barraclough, Conroy, & Lee, 2004; Wallis & Miller, 2003) and humans (Kringelbach, de Araujo, & Rolls, 2004) suggesting that, whereas ventromedial areas primarily encode elementary hedonic or interoceptive ("gut feelings") information about reinforcers (Bechara et al., 2000; Craig, 2004; N. A. Roberts et al., 2004; Rolls, 1999; Rule, Shimamura & Knight, 2002), dorsolateral areas work to integrate hedonic information with goal-directed attentional and motor-planning schemas.

The results of the current study are consistent with the idea that hemispheric asymmetries represent a fundamental organizational principle of such Affect \times Cognition interactions. They also suggest that spatial attention may prove to be a fundamental component of anxious arousal and, by extension, anxiety-related changes in asymmetric prefrontal activation. It remains the task of future studies to directly test, using neuroimaging or electrophysiological techniques, the functional neuroanatomical circuits that we have hypothesized govern such interactions.

Several other issues merit further investigation. In particular, the role of mnemonic and nonmnemonic (e.g., temporal indexing, interference suppression) load in moderating the impact of anxiety is poorly understood (cf. Feldman Barrett, Tugade, & Engle, 2004). Likewise, because the *n*-back task is a comparatively complex measure of WM, we do not know whether the impact of anxiety is predominantly due to its impact on the maintenance of spatial information in WM or some other operation, such as encoding. Likewise, there is some evidence to suggest that spatial WM is disproportionately dependent upon executive control processes (Miyake, Friedman, Rettinger, Shah, & Hegarty, 2001; Salway & Logie, 1995), and it may be these control processes, rather than the maintenance of visuospatial information per se, that underlie the selective deficit that we and others have observed. Finally, we still do not know whether other arousing positive or negative affective states would have an effect similar to that we found for anxiety.

Clinical (Baker, Piper, McCarthy, Majeskie, & Fiore, 2004; Gottman, 1998), developmental (Metcalf & Mischel, 1999), and behavioral economic (Kahneman & Tversky, 1979; Shiv, Loewenstein, Bechara, Damasio, & Damasio, 2005) theorists have suggested that negative affect biases attention to threat-relevant information and action to reflexive courses of action. Such biases are thought to play important roles in a variety of maladaptive and pathological conditions (e.g., addictions) because they come at the expense of behaviors governed by declarative knowledge and long-term strategies (e.g., quitting or abstaining). In light of this, work to illuminate the more elementary neural and psychological mechanisms mediating the impact of task-irrelevant anxiety on cognition is likely to yield important benefits for our understanding of these molar phenomena.

References

- Abramson, L. Y., Alloy, L. B., Hankin, B. L., Haeffel, G. J., MacCoon, D. G., & Gibb, B. E. (2002). Cognitive vulnerability-stress models of depression in a self-regulatory and psychobiological context. In I. H. Gotlib & C. L. Hammen (Eds.), *Handbook of depression* (pp. 268–294). New York: Guilford Press.
- Arnsten, A. F. T. (1998). Catecholamine modulation of prefrontal cortical cognitive function. *Trends in Cognitive Sciences*, 2, 436–447.
- Arnsten, A. F. T., & Goldman-Rakic, P. S. (1998). Noise stress impairs prefrontal cortical cognitive function in monkeys. *Archives of General Psychiatry*, 55, 362–368.
- Aron, A. R., Fletcher, P. C., Bullmore, E. T., Sahakian, B. J., & Robbins, T. W. (2003). Stop-signal inhibition disrupted by damage to right inferior frontal gyrus in humans. *Nature Neuroscience*, 6, 115–116.
- Ashby, F. G., Isen, A. M., & Turken, A. U. (1999). A neuropsychological theory of positive affect and its influence on cognition. *Psychological Review*, 106, 529–550.
- Ashby, F. G., Velentin, V. V., & Turken, A. U. (2002). The effects of positive affect and arousal on working memory and executive attention. In S. Moore & M. Oaksford (Eds.), *Emotional cognition: From brain to behaviour* (pp. 245–287). Amsterdam: John Benjamins.
- Awh, E., & Jonides, J. (2001). Overlapping mechanisms of attention and spatial working memory. *Trends in Cognitive Sciences*, 5, 119–126.
- Baas, D., Aleman, A., & Kahn, R. S. (2004). Lateralization of amygdala activation: A systematic review of functional neuroimaging studies. *Brain Research Reviews*, 45, 96–103.
- Baas, J., Grillon, C., Pine, D., Nugent, M., Drevets, W., & Furey, M. (2004). Prefrontal cortex activation during phasic fear and sustained anxiety to predictable (signaled) and unpredictable (non-signaled) shock. *NeuroImage*, 22, S26.
- Baddeley, A. D. (1972). Selective attention and performance in dangerous environments. *British Journal of Psychology*, 63, 537–546.
- Baddeley, A. (2003). Working memory: Looking back and looking forward. *Nature Reviews Neuroscience*, 4, 829–839.
- Baker, T. B., Piper, M. E., McCarthy, D. E., Majeskie, M. R., & Fiore, M. C. (2004). Addiction motivation reformulated: An affective processing model of negative reinforcement. *Psychological Review*, 111, 33–51.
- Barch, D. M., Carter, C. S., & Cohen, J. D. (2004). Factors influencing Stroop performance in schizophrenia. *Neuropsychology*, 18, 477–484.
- Baron, R. M., & Kenny, D. A. (1986). The moderator–mediator variable distinction in social psychological research: Conceptual, strategic, and statistical considerations. *Journal of Personality and Social Psychology*, 51, 1173–1182.
- Barralough, D. J., Conroy, M. L., & Lee, D. (2004). Prefrontal cortex and decision making in a mixed-strategy game. *Nature Neuroscience*, 7, 404–410.
- Basso, M. R., Scheff, B. K., & Hoffmann, R. G. (1994). Mood-moderating effects of affect intensity on cognition: Sometimes euphoria is not beneficial and dysphoria is not detrimental. *Journal of Personality and Social Psychology*, 66, 363–368.
- Beauchamp, M. H., Dagher, A., Aston, J. A., & Doyon, J. (2003). Dynamic functional changes associated with cognitive skill learning of an adapted version of the Tower of London task. *NeuroImage*, 20, 1649–1660.
- Bechara, A., Damasio, H., & Damasio, A. R. (2000). Emotion, decision making and the orbitofrontal cortex. *Cerebral Cortex*, 10, 295–307.
- Beilock, S. L., & Carr, T. H. (2005). When high-powered people fail: Working memory and “choking under pressure” in math. *Psychological Science*, 16, 101–105.
- Bell, M. A., & Fox, N. A. (2003). Cognition and affective style: Individual differences in brain electrical activity during spatial and verbal tasks. *Brain and Cognition*, 53, 441–451.
- Bender, M. B. (1952). *Disorders of perception*. Springfield, IL: Charles C Thomas.
- Berenbaum, H., & Williams, M. (1995). Personality and emotional reactivity. *Journal of Research in Personality*, 29, 24–34.
- Berkowitz, L., & Troccoli, B. T. (1986). An examination of the assumptions in the demand characteristics thesis: With special reference to the Velten mood induction procedure. *Motivation and Emotion*, 10, 337–349.
- Berridge, C. W., España, R. A., & Stalnaker, T. A. (2003). Stress and coping: Asymmetry of dopamine efferents within prefrontal cortex. In K. Hugdahl & R. J. Davidson (Eds.), *The asymmetrical brain* (pp. 69–103). Cambridge, MA: MIT Press.
- Bishop, S., Duncan, J., Brett, M., & Lawrence, A. D. (2004). Prefrontal cortical function and anxiety: Controlling attention to threat-related stimuli. *Nature Neuroscience*, 7, 184–188.
- Bleckley, M. K., Durso, F. T., Crutchfield, J. M., Engle, R. W., & Khanna, M. M. (2003). Individual differences in working memory capacity predict visual attention allocation. *Psychonomic Bulletin & Review*, 10, 884–889.
- Böcker, K. B. E., Baas, J. M. P., Kenemans, J. L., & Verbaten, M. N. (2004). Differences in startle modulation during instructed threat and selective attention. *Biological Psychology*, 67, 343–358.
- Bradley, M. M. (2000). Emotion and motivation. In J. T. Cacioppo, L. G. Tassinary, & G. G. Berntson (Eds.), *Handbook of psychophysiology* (2nd ed., pp. 602–642). New York: Cambridge University Press.
- Bradley, M. M., Codispoti, M., Sabatinelli, D., & Lang, P. J. (2001). Emotion and motivation: II. Sex differences in picture processing. *Emotion*, 1, 300–319.
- Brandimonte, M. A., Hitch, G. J., & Bishop, D. V. M. (1992). Verbal recoding of visual stimuli impairs mental image transformations. *Memory & Cognition*, 20, 449–455.
- Britt, T. W., & Blumenthal, T. D. (1991). On threat of shock as an elicitor of anxiety: A methodological note. *Psychological Reports*, 69, 649–650.
- Buckelew, S. P., & Hannay, H. J. (1986). Relationships among anxiety, defensiveness, sex, task difficulty, and performance on various neuropsychological tasks. *Perceptual and Motor Skills*, 63, 711–718.
- Cabeza, R., Daselaar, S. M., Dolcos, F., Prince, S. E., Budde, M., & Nyberg, L. (2004). Task-independent and task-specific age effects on brain activity during working memory, visual attention and episodic retrieval. *Cerebral Cortex*, 14, 364–375.
- Cacioppo, J. T., Petty, R. E., Losch, M. E., & Kim, H. S. (1986). Electromyographic activity over facial muscle regions can differentiate the valence and intensity of affective reactions. *Journal of Personality and Social Psychology*, 50, 260–268.
- Cahill, L. (2000). Modulation of long-term memory storage in humans by emotional arousal. In J. P. Aggleton (Ed.), *The amygdala: A functional analysis* (pp. 425–445). New York: Oxford University Press.
- Canli, T., Sivers, H., Gotlib, I. H., & Gabrieli, J. D. E. (2002). Amygdala activation to happy faces as a function of extraversion. *Science*, 296, 2191.
- Carver, C. S., & White, T. (1994). Behavioral inhibition, behavioral activation, and affective responses to impending reward and punishment: The BIS/BAS scales. *Journal of Personality and Social Psychology*, 67, 319–333.
- Cazalis, F., Valabregue, R., Pelegrini-Issac, M., Asloun, S., Robbins, T. W., & Granon, S. (2003). Individual differences in prefrontal cortical activation on the Tower of London planning task: Implication for effortful processing. *European Journal of Neuroscience*, 17, 2219–2225.
- Chao, L. L., & Knight, R. T. (1995). Human prefrontal lesions increase distractibility to irrelevant sensory inputs. *NeuroReport*, 6, 1605–1610.
- Chapman, L. J., & Chapman, J. P. (2001). Commentary on two articles concerning generalized and specific cognitive deficits. *Journal of Abnormal Psychology*, 110, 31–39.
- Christianson, S.-A. (1986). Effects of positive emotional events on memory. *Scandinavian Journal of Psychology*, 27, 287–299.

- Christianson, S.-A. (1992). Emotional stress and eyewitness memory: A critical review. *Psychological Bulletin*, *112*, 284–309.
- Christianson, S.-A., & Mjörndal, T. (1985). Adrenalin, emotional arousal and memory. *Scandinavian Journal of Psychology*, *26*, 237–248.
- Clark, L., Manes, F., Antoun, N., Sahakian, B. J., & Robbins, T. W. (2003). The contributions of lesion laterality and lesion volume to decision-making impairment following frontal lobe damage. *Neuropsychologia*, *41*, 1474–1483.
- Coan, J. A., Allen, J. J. B. (2003a). Frontal EEG asymmetry and the behavioral activation and inhibition systems. *Psychophysiology*, *40*, 106–114.
- Coan, J. A., & Allen, J. J. B. (2003b). The state and trait nature of frontal EEG asymmetry in emotion. K. Hugdahl & R. J. Davidson (Eds.), *The asymmetrical brain* (pp. 565–615). Cambridge, MA: MIT Press.
- Coan, J. A., & Allen, J. J. B. (2004). Frontal EEG asymmetry as a moderator and mediator of emotion. *Biological Psychology*, *67*, 7–49.
- Codispoti, M., Gerra, G., Montebanacci, O., Zaimovic, A., Raggi, M. A., & Baldaro, B. (2003). Emotional perception and neuroendocrine changes. *Psychophysiology*, *40*, 863–868.
- Cohen, J. D., Braver, T. S., & O'Reilly, R. C. (1996). A computational approach to prefrontal cortex, cognitive control and schizophrenia: Recent developments and current challenges. *Philosophical Transactions of the Royal Society, Series B*, *346*, 1515–1527.
- Compton, R. J. (2003). The interface between emotion and attention: A review of evidence from psychology and neuroscience. *Behavioral and Cognitive Neuroscience Reviews*, *2*, 115–129.
- Compton, R. J., Heller, W., Banich, M. T., Palmieri, P. A., & Miller, G. A. (2000). Responding to threat: Hemispheric asymmetries and interhemispheric division of input. *Neuropsychology*, *14*, 254–264.
- Corballis, P. M., Funnell, M. G., & Gazzaniga, M. S. (2002). Hemispheric asymmetries for simple visual judgments in the split brain. *Neuropsychologia*, *40*, 401–410.
- Corbetta, M., & Shulman, G. L. (2002). Control of goal-directed and stimulus-driven attention in the brain. *Nature Reviews Neuroscience*, *3*, 201–215.
- Cortina, J. M. (1993). What is coefficient alpha? An examination of theory and applications. *Journal of Applied Psychology*, *78*, 98–104.
- Craig, A. D. (2004). Human feelings: Why are some more aware than others? *Trends in Cognitive Sciences*, *8*, 239–241.
- Cronbach, L. J. (1951). Coefficient alpha and the internal structure of tests. *Psychometrika*, *16*, 297–334.
- Dalton, K. M., Kalin, N. H., Grist, T. M., & Davidson, R. J. (2005). Neural-cardiac coupling in threat-evoked anxiety. *Journal of Cognitive Neuroscience*, *17*, 969–980.
- Damasio, A. R. (1994). *Descartes' error. Emotion, reason, and the human brain*. New York: Putnam.
- Damasio, A. R., Grabowski, T. J., Bechara, A., Damasio, H., Ponto, L. L., Parvizi, J., & Hichwa, R. D. (2000). Subcortical and cortical brain activity during the feeling of self-generated emotions. *Nature Neuroscience*, *3*, 1049–1056.
- Darwin, C. (1998). *The expression of the emotions in man and animals* (P. Ekman, Ed.; 3rd ed.). New York: Oxford University Press. (Original work published 1872)
- Davidson, R. J. (1994). Asymmetric brain function, affective style, and psychopathology: The role of early experience and plasticity. *Development and Psychopathology*, *6*, 741–758.
- Davidson, R. J. (1998). Affective style and affective disorders: Perspectives from affective neuroscience. *Cognition and Emotion*, *12*, 307–320.
- Davidson, R. J. (2004). What does the prefrontal cortex “do” in affect: Perspectives in frontal EEG asymmetry research. *Biological Psychology*, *67*, 219–234.
- Davidson, R. J., Chapman, J. P., Chapman, L. J., & Henriques, J. B. (1990). Asymmetrical brain electrical activity discriminates between psychometrically-matched verbal and spatial cognitive tasks. *Psychophysiology*, *27*, 528–543.
- Davidson, R. J., Ekman, P., Saron, C. D., Senulis, J. A., & Friesen, W. V. (1990). Approach-withdrawal and cerebral asymmetry: Emotional expression and brain physiology: I. *Journal of Personality and Social Psychology*, *58*, 330–341.
- Davidson, R. J., & Irwin, W. (1999). The functional neuroanatomy of emotion and affective style. *Trends in Cognitive Science*, *3*, 11–21.
- Davidson, R. J., Marshall, J. R., Tomarken, A. J., & Henriques, J. B. (2000). While a phobic waits: Regional brain electrical and autonomic activity in social phobics during anticipation of public speaking. *Biological Psychiatry*, *47*, 85–95.
- Davidson, R. J., Maxwell, J. S., & Shackman, A. J. (2004). The privileged status of emotion in the brain. *Proceedings of the National Academy of Sciences, USA*, *101*, 11915–11916.
- Davidson, R. J., Pizzagalli, D., Nitschke, J. B., & Kalin, N. H. (2003). Parsing the subcomponents of emotion and disorders of emotion: Perspectives from affective neuroscience. In R. J. Davidson, H. H. Goldsmith, & K. Scherer (Eds.), *Handbook of affective science* (pp. 8–24). New York: Oxford University Press.
- Davidson, R. J., Pizzagalli, D., Nitschke, J. B., & Putnam, K. (2002). Depression: Perspectives from affective neuroscience. *Annual Review of Psychology*, *53*, 545–574.
- Davis, M., & Whalen, P. J. (2001). The amygdala: Vigilance and emotion. *Molecular Psychiatry*, *6*, 13–34.
- Della Sala, S., & Logie, R. H. (1997). Impairments of methodology and theory in cognitive neuropsychology: A case for rehabilitation? *Neuropsychological Rehabilitation*, *7*, 367–385.
- Dickerson, S. S., & Kemeny, M. E. (2004). Acute stressors and cortisol responses: A theoretical integration and synthesis of laboratory research. *Psychological Bulletin*, *130*, 355–391.
- Doctor, R. M., & Altman, F. (1969). Worry and emotionality as components of test anxiety: Replication and further data. *Psychological Reports*, *24*, 563–568.
- Dolan, R. J. (2002). Emotion, cognition, and behavior. *Science*, *298*, 1191–1194.
- Drevets, W. C., & Raichle, M. E. (1998). Suppression of regional cerebral blood flow during emotional versus higher cognitive processes: Implications for interactions between emotion and cognition. *Cognition and Emotion*, *12*, 353–385.
- Duff, S. J., & Hampson, E. (2001). A sex difference on a novel spatial working memory task in humans. *Brain and Cognition*, *47*, 470–493.
- Easterbrook, J. A. (1959). The effect of emotion on cue utilization and the organization of behavior. *Psychological Review*, *66*, 183–201.
- Ekman, P., & Davidson, R. J. (Eds.). (1994). *The nature of emotion: Fundamental questions*. New York: Oxford University Press.
- Ellis, H. C., & Ashbrook, P. W. (1989). The “state” of mood and memory research: A selective review. *Journal of Social Behavior and Personality*, *4*, 1–21.
- Erber, R., & Erber, M. W. (2000). The self-regulation of moods: Second thoughts on the importance of happiness in everyday life. *Psychological Inquiry*, *11*, 142–148.
- Eysenck, M. W., & Calvo, M. G. (1992). Anxiety and performance: The processing efficiency theory. *Cognition and Emotion*, *6*, 409–434.
- Feldman Barrett, L., Tugade, M. M., & Engle, R. W. (2004). Individual differences in working memory capacity and dual-process theories of mind. *Psychological Bulletin*, *130*, 553–573.
- Fischer, H., Andersson, J. L. R., Furmark, T., Wik, G., & Fredrikson, M. (2002). Right-sided human prefrontal brain activation during acquisition of conditioned fear. *Emotion*, *2*, 233–241.
- Floel, A., Poeppel, D., Buffalo, E. A., Brun, A., Wu, C. W.-H., Seo, H.-J., et al. (2004). Prefrontal cortex asymmetry for memory encoding of words and abstract shapes. *Cerebral Cortex*, *14*, 404–409.
- Fredrickson, B. L. (2000). Extracting meaning from past affective experi-

- ence: The importance of peaks, ends, and specific emotions. *Cognition and Emotion*, 14, 577–606.
- Friedman, A., & Polson, M. C. (1981). Hemispheres as independent resource systems: Limited-capacity processing and cerebral specialization. *Journal of Experimental Psychology*, 7, 1031–1058.
- Gable, S. L., Reis, H. T., & Elliott, A. J. (2000). Behavioral activation and inhibition in everyday life. *Journal of Personality and Social Psychology*, 78, 1135–1149.
- Garrett, A. S., & Maddock, R. J. (2001). Time course of the subjective emotional response to aversive pictures: Relevance to fMRI studies. *Psychiatry Research: Neuroimaging Section*, 108, 39–48.
- Gerra, G., Baldaro, B., Zaimovic, A., Moi, G., Bussandri, M., Raggi, M. A., & Brambilla, F. (2003). Neuroendocrine responses to experimentally-induced emotions among abstinent opioid-dependent subjects. *Drug and Alcohol Dependence*, 71, 25–35.
- Gevins, A., & Smith, M. E. (2000). Neurophysiological measures of working memory and individual differences in cognitive ability and cognitive style. *Cerebral Cortex*, 10, 829–839.
- Glabus, M. F., Horwitz, B., Holt, J. L., Kohn, P. D., Gerton, B. K., Callicott, J. H., et al. (2003). Interindividual differences in functional interactions among prefrontal, parietal and parahippocampal regions during working memory. *Cerebral Cortex*, 13, 1352–1361.
- Goldman-Rakic, P. S. (1998). The prefrontal landscape: Implications of functional architecture for understanding human mentation and the central executive. In A. C. Roberts, T. W. Robbins, & L. Weiskrantz (Eds.), *The prefrontal cortex: Executive and cognitive functions* (pp. 87–102). New York: Oxford University Press.
- Gottman, J. M. (1998). Psychology and the study of marital processes. *Annual Review of Psychology*, 49, 169–197.
- Gouchie, C., & Kimura, D. (1991). The relationship between testosterone levels and cognitive ability patterns. *Psychoneuroendocrinology*, 16, 323–334.
- Gray, J. R. (2001). Emotional modulation of cognitive control: Approach-withdrawal states double-dissociate spatial from verbal two-back task performance. *Journal of Experimental Psychology: General*, 130, 436–452.
- Gray, J. R. (2004). Integration of emotion and cognitive control. *Current Directions in Psychological Science*, 13, 46–48.
- Gray, J. R., & Braver, T. S. (2002). Personality predicts working memory related activation in caudal anterior cingulate cortex. *Cognitive, Affective, & Behavioral Neuroscience*, 2, 64–75.
- Gray, J. R., Braver, T. S., & Raichle, M. E. (2002). Integration of emotion and cognition in the lateral prefrontal cortex. *Proceedings of the National Academy of Sciences, USA*, 99, 4115–4120.
- Greenwald, M. K., Bradley, M. M., Cuthbert, B. N., & Lang, P. J. (1998). Startle potentiation: Shock sensitization, aversive learning, and affective picture modulation. *Behavioral Neuroscience*, 112, 1069–1079.
- Grillon, C., Ameli, R., Woods, S. W., Merikangas, K., & Davis, M. (1991). Fear-potentiated startle in humans: Effects of anticipatory anxiety on the acoustic startle reflex. *Psychophysiology*, 28, 588–595.
- Gross, J. J. (1998). Antecedent- and response-focused emotional regulation: Divergent consequences for experience, expression, and physiology. *Journal of Personality and Social Psychology*, 74, 224–237.
- Gross, J. J., & Levenson, R. W. (1995). Emotion elicitation using films. *Cognition and Emotion*, 9, 87–108.
- Gross, J. J., Sutton, S. K., & Ketelaar, T. V. (1998). Relations between affect and personality: Support for the affect-level and affective-reactivity views. *Personality and Social Psychology Bulletin*, 24, 279–288.
- Gur, R. C., Alsop, D., Glahn, D., Petty, R., Swanson, C. L., Maldjian, J. A., et al. (2000). An fMRI study of sex differences in regional brain activation to a verbal and spatial task. *Brain and Language*, 74, 157–170.
- Hamm, A. O., & Vaitl, D. (1996). Affective learning: Awareness and aversion. *Psychophysiology*, 33, 698–710.
- Harmon-Jones, E., & Allen, J. J. B. (1997). Behavioral activation sensitivity and resting frontal EEG asymmetry: Covariation of putative indicators related to risk for mood disorders. *Journal of Abnormal Psychology*, 106, 159–163.
- Hartikainen, K. M., Ogawa, K. H., & Knight, R. T. (2000). Transient interference of right hemisphere function due to automatic emotional processing. *Neuropsychologia*, 38, 1576–1580.
- Heller, W., Nitschke, J. B., Etienne, M. A., & Miller, G. A. (1997). Patterns of regional brain activity differentiate types of anxiety. *Journal of Abnormal Psychology*, 106, 376–385.
- Heller, W., Nitschke, J. B., & Lindsay, D. L. (1997). Neuropsychological correlates of arousal in self-reported emotion. *Cognition and Emotion*, 11, 383–402.
- Hellhammer, D. H., Hubert, W., & Schürmeyer, T. (1985). Changes in salivary testosterone after psychological stimulation in men. *Psychoneuroendocrinology*, 10, 77–81.
- Hockey, A., & Geffen, G. (2004). The concurrent validity and test-retest reliability of a visuospatial working memory task. *Intelligence*, 32, 591–605.
- Hodges, W. F. (1968). Effects of ego threat and threat of pain on state anxiety. *Journal of Personality and Social Psychology*, 8, 364–372.
- Hodges, W. F., & Spielberger, C. D. (1969). Digit span: An indicator of trait or state anxiety? *Journal of Consulting and Clinical Psychology*, 33, 430–434.
- Holmes, E. A., Brewin, C. R., & Hennessy, R. G. (2004). Trauma films, information processing, and intrusive memory development. *Journal of Experimental Psychology: General*, 133, 3–22.
- Honey, G., & Bullmore, E. (2004). Human pharmacological MRI. *Trends in Pharmacological Science*, 26, 366–374.
- Hopko, D. R., Crittendon, J. A., Grant, E., & Wilson, S. A. (2005). The impact of anxiety on performance IQ. *Anxiety, Stress, and Coping*, 18, 17–35.
- Hornak, J., O'Doherty, J., Bramham, J., Rolls, E. T., Morris, R. G., Bullock, P. R., & Polkey, C. E. (2004). Reward-related reversal learning after surgical excisions in orbito-frontal or dorsolateral prefrontal cortex in humans. *Journal of Cognitive Neuroscience*, 16, 463–478.
- Idzikowski, C., & Baddeley, A. D. (1983). Waiting in the wings: Apprehension, public speaking and performance. In G. R. J. Hockey (Ed.), *Stress and fatigue in human performance* (pp. 123–144). Chichester, England: Wiley.
- Janelle, C. M. (2002). Modification of visual attention parameters under conditions of heightened anxiety and arousal. *Journal of Sports Sciences*, 20, 1–15.
- Jenkins, L., Myerson, J., & Hie, S. (1999). Individual and developmental differences in working memory across the lifespan. *Psychonomic Bulletin & Review*, 6, 28–40.
- Jonides, J., Schumacher, E. H., Smith, E. E., Lauber, E. J., Awh, E., Minoshima, S., & Koeppe, R. A. (1997). Verbal working memory load affects regional brain activation as measured by PET. *Journal of Cognitive Neuroscience*, 9, 462–475.
- Kahneman, D., & Tversky, A. (1979). Prospect theory: An analysis of decision under risk. *Econometrica*, 47, 263–291.
- Kalin, N. H., Larson, C., Shelton, S. E., & Davidson, R. J. (1998). Asymmetric frontal brain activity, cortisol, and behavior associated with fearful temperament in rhesus monkeys. *Behavioral Neuroscience*, 112, 286–292.
- Kane, M. J., & Engle, R. W. (2000). Working-memory capacity, proactive interference, and divided attention: Limits on long-term memory retrieval. *Journal of Experimental Psychology: Learning, Memory, and Cognition*, 26, 336–358.
- Kane, M. J., & Engle, R. W. (2002). The role of prefrontal cortex in working-memory capacity, executive attention, and general fluid intel-

- ligence: An individual-differences perspective. *Psychonomic Bulletin & Review*, 9, 637–671.
- Keller, J., Nitschke, J., Bhargava, T., Deldin, P. J., Gergen, J. A., Miller, G. A., & Heller, W. (2000). Neuropsychological differentiation of depression and anxiety. *Journal of Abnormal Psychology*, 109, 3–10.
- Kenealy, P. M. (1986). The Velten mood induction procedure: A methodological review. *Motivation and Emotion*, 10, 315–335.
- Kimberg, D. Y., Aguirre, G. K., Lease, J., & D'Esposito, M. (2001). Cortical effects of bromocriptine, a D2 dopamine receptor agonist, in human subjects, revealed by fMRI. *Human Brain Mapping*, 12, 246–257.
- Kinsbourne, M., & Hicks, R. E. (1978). The cerebral space: A model for overflow, transfer and interference effects in human performance: A tutorial review. In J. Requin (Ed.), *Attention and performance VII* (pp. 345–362). Hillsdale, NJ: Erlbaum.
- Klauer, K. C., & Zhao, Z. (2004). Double dissociations in visual and spatial short-term memory. *Journal of Experimental Psychology: General*, 133, 355–381.
- Klingberg, T. (1998). Concurrent performance of two working memory tasks: Potential mechanisms of interference. *Cerebral Cortex*, 8, 593–601.
- Kok, A. (1997). Event-related potential (ERP) reflections of mental resources: A review and synthesis. *Biological Psychology*, 45, 19–56.
- Kosslyn, S. M., Cacioppo, J. T., Davidson, R. J., Hugdahl, K., Lovallo, W. R., Spiegel, D., & Rose, R. (2002). Bridging psychology and biology: The analysis of individuals in groups. *American Psychologist*, 57, 341–351.
- Kringelbach, M. L., de Araujo, I. E. T., & Rolls, E. T. (2004). Taste-related activity in the human dorsolateral prefrontal cortex. *NeuroImage*, 21, 781–788.
- Kringelbach, M. L., & Rolls, E. T. (2004). The functional neuroanatomy of the human orbitofrontal cortex: Evidence from neuroimaging and neuropsychology. *Progress in Neurobiology*, 72, 341–372.
- Kumari, V., Ffytche, D. H., Williams, S. C. R., & Gray, J. A. (2004). Personality predicts brain responses to cognitive demands. *Journal of Neuroscience*, 24, 10636–10641.
- Lane, R. D., Reiman, E. M., Bradley, M. M., Lang, P. J., Ahern, G. L., Davidson, R. J., & Schwartz, G. E. (1997). Neuroanatomical correlates of pleasant and unpleasant emotion. *Neuropsychologia*, 35, 1437–1444.
- Lavric, A., Pizzagalli, D. A., & Forstmeier, S. (2004). When “go” and “nogo” are equally frequent: ERP components and cortical tomography. *European Journal of Neuroscience*, 20, 2483–2488.
- Lavric, A., Rippon, G., & Gray, J. R. (2003). Threat-evoked anxiety disrupts spatial working memory performance: An attentional account. *Cognitive Therapy and Research*, 27, 489–504.
- Lawrence, N., Ross, T., Hoffman, R., Garavan, H., & Stein, E. A. (2003). Activation and deactivation during the rapid visual information processing task: An fMRI study. *Journal of Cognitive Neuroscience*, 15, 1028–1038.
- Lazarus, R. S., Deese, J., & Osler, S. F. (1952). The effects of psychological stress upon performance. *Psychological Bulletin*, 49, 293–317.
- Leen-Feldner, E. W., Zvolensky, M. J., & Feldner, M. T. (2004). Behavioral inhibition: Relation to negative emotion regulation and reactivity. *Personality & Individual Differences*, 36, 1235–1247.
- Leon, M. R., & Revelle, W. (1985). Effects of anxiety on analogical reasoning: A test of three theoretical models. *Journal of Personality and Social Psychology*, 49, 1302–1315.
- Levenson, R. W. (2003). Autonomic specificity and emotion. In R. J. Davidson, K. R. Scherer, & H. H. Goldsmith (Eds.), *Handbook of affective sciences* (pp. 212–224). New York: Oxford University Press.
- Lowenstein, G., & Lerner, J. S. (2003). The role of affect in decision making. In R. J. Davidson, K. Scherer, & H. H. Goldsmith (Eds.), *Handbook of affective science* (pp. 619–642). New York: Oxford University Press.
- Luciana, M., & Collins, P. F. (1997). Dopaminergic modulation of working memory for spatial but not object cues in normal humans. *Journal of Cognitive Neuroscience*, 9, 330–347.
- MacLeod, C., & Donnellan, A. M. (1993). Individual differences in anxiety and the restriction of working memory capacity. *Personality & Individual Differences*, 15, 163–173.
- Manoach, D. S., White, N. S., Lindgren, K. A., Heckers, S., Coleman, M. J., Dubal, S., & Phillip, P. S. (2004). Hemispheric specialization of the lateral prefrontal cortex for strategic processing during spatial and shape working memory. *NeuroImage*, 21, 894–903.
- Marco, C. A., & Suls, J. (1993). Daily stress and the trajectory of mood: Spillover, response assimilation, contrast, and chronic negative affectivity. *Journal of Social and Psychological Science*, 64, 1053–1063.
- Markham, R., & Darke, S. (1991). The effects of anxiety on verbal and spatial task performance. *Australian Journal of Psychology*, 43, 107–111.
- Martin, M. (1990). On the induction of mood. *Clinical Psychology Review*, 10, 669–697.
- Masson, M. E. J., & Loftus, G. R. (2003). Using confidence for graphically based data interpretation. *Canadian Journal of Experimental Psychology*, 57, 203–220.
- Matthews, A., Fox, E., Yiend, J., & Calder, A. (2003). The face of fear: Effects of eye gaze and emotion on visual attention. *Visual Cognition*, 10, 823–835.
- Maxwell, J. S., Shackman, A. J., & Davidson, R. J. (2005). Unattended facial expressions asymmetrically bias the concurrent processing of nonemotional information as a function of state anxiety. *Journal of Cognitive Neuroscience*, 17, 1386–1395.
- McNamara, D. S., & Scott, J. L. (2001). Working memory capacity and strategy use. *Memory & Cognition*, 29, 10–17.
- Meegan, D. V., & Honsberger, M. J. M. (2005). Spatial information is processed even when it is task-irrelevant: Implications for neuroimaging task design. *NeuroImage*, 25, 1043–1055.
- Metcalfe, J., & Mischel, W. (1999). A hot/cool system analysis of delayed gratification: Dynamics of willpower. *Psychological Review*, 106, 3–19.
- Miller, E. K., & Cohen, J. D. (2001). An integrative theory of prefrontal cortex function. *Annual Review of Neuroscience*, 24, 167–202.
- Miyake, A., Friedman, N. P., Emerson, M. J., Witzki, A. H., Howerter, A., & Wager, T. (2000). The unity and diversity of executive functions and their contributions to complex “frontal lobe” tasks: A latent variable analysis. *Cognitive Psychology*, 41, 49–100.
- Miyake, A., Friedman, N. P., Rettinger, D. A., Shah, P., & Hegarty, M. (2001). Visuospatial working memory, executive functioning, and spatial abilities. How are they related? *Journal of Experimental Psychology: General*, 130, 621–640.
- Moore, S. C., & Oaksford, M. (2002). Some long-term effects of emotion on cognition. *British Journal of Psychology*, 93, 383–395.
- Morris, L. W., Davis, M. A., & Hutchings, C. H. (1981). Cognitive and emotional components of anxiety: Literature review and a revised worry-emotionality scale. *Journal of Educational Psychology*, 73, 541–555.
- Morris, L. W., & Liebert, R. M. (1973). Effects of negative feedback, threat of shock, and level of trait anxiety on the arousal of two components of test anxiety. *Journal of Counseling Psychology*, 20, 321–326.
- Müri, R. M., Gaymard, B., Rivaud, S., Vermersch, A. I., Hess, C. W., & Pierrot-Deseilligny, C. (2000). Hemispheric asymmetry in cortical control of memory-guided saccades: A transcranial magnetic stimulation study. *Neuropsychologia*, 38, 1105–1111.
- Murphy, F. C., Nimmo-Smith, I., & Lawrence, A. D. (2003). Functional neuroanatomy of emotions: A meta-analysis. *Cognitive, Affective & Behavioral Neuroscience*, 3, 207–233.
- Nitschke, J. B., Heller, W., Palmieri, P. A., & Miller, G. A. (1999). Contrasting patterns of brain activity in anxious apprehension and anxious arousal. *Psychophysiology*, 36, 628–637.
- Oaksford, M., Morris, F., Grainger, B., & Williams, J. M. G. (1996). Mood, reasoning, and central executive processes. *Journal of Experimental Psychology: Learning, Memory, and Cognition*, 22, 476–492.

- Owen, A. M., McMillan, K. M., Laird, A. R., & Bullmore, E. (2005). N-back working memory paradigm: A meta-analysis of normative functional neuroimaging studies. *Human Brain Mapping, 25*, 46–59.
- Pallak, M. S., Pittman, T. S., & Heller, J. F. (1975). The effect of arousal on Stroop color-word task performance. *Bulletin of the Psychonomic Society, 6*, 248–250.
- Papousek, I., & Schuster, G. (2004). Manipulation of frontal brain asymmetry by cognitive tasks. *Brain and Cognition, 54*, 43–51.
- Pardo, J. V., Pardo, P. J., & Raichle, M. E. (1993). Neural correlates of self-induced dysphoria. *American Journal of Psychiatry, 150*, 713–719.
- Pearson, D. G., & Sahraie, A. (2003). Oculomotor control and the maintenance of spatially and temporally distributed events in visuo-spatial working memory. *Quarterly Journal of Experimental Psychology: Human Experimental Psychology, 56(A)*, 1089–1111.
- Phelps, E. A., O'Connor, K. J., Gatenby, J. C., Gore, J. C., Grillon, C., & Davis, M. (2001). Activation of the left amygdala to a cognitive representation of fear. *Nature Neuroscience, 4*, 437–441.
- Pizzagalli, D. A., Greischar, L. L., Davidson, R. J. (2003). Spatio-temporal dynamics of brain mechanisms in aversive classical conditioning: High-density event-related potential and brain electrical tomography analyses. *Neuropsychologia, 41*, 184–194.
- Pizzagalli, D., Shackman, A. J., & Davidson, R. J. (2003). The functional neuroimaging of human emotion: Asymmetric contributions of cortical and subcortical circuitry. In K. Hugdahl & R. J. Davidson (Eds.), *The asymmetrical brain* (pp. 511–532). Cambridge, MA: MIT Press.
- Postle, B. R. (2005). Delay-period activity in prefrontal cortex: one function is sensory-gating. *Journal of Cognitive Neuroscience, 11*, 1679–1690.
- Postle, B. R., & D'Esposito, M. (2000). Evaluating models of the topographical organization of working memory function in frontal cortex with event-related fMRI. *Psychobiology, 28*, 132–145.
- Postle, B. R., Idzikowski, C., Della Sala, S., & Baddeley, A. D. (in press). The selective disruption of spatial working memory by eye movements. *Quarterly Journal of Experimental Psychology: Human Experimental Psychology*.
- Reingold, E. M. (2003). Interpreting dissociations: The issue of task comparability. *Cortex, 39*, 174–176.
- Richeson, J. A., Baird, A. A., Gordon, H. L., Heatherton, T. F., Wyland, C. L., Trawalter, S., & Shelton, J. N. (2003). An fMRI examination of the impact of interracial contact on executive function. *Nature Neuroscience, 6*, 1323–1328.
- Roberts, A. C., & Wallis, J. D. (2000). Inhibitory control and affective processing in the prefrontal cortex: Neuropsychological studies in the common marmoset. *Cerebral Cortex, 10*, 252–262.
- Roberts, N. A., Beer, J. S., Werner, K. H., Scabini, D., Knight, R. T., & Levenson, R. W. (2004). The impact of orbital prefrontal cortex damage on emotional activation to unanticipated and anticipated acoustic startle stimuli. *Cognitive, Affective & Behavioral Neuroscience, 4*, 307–316.
- Rolls, E. T. (1999). *The brain and emotion*. New York: Oxford University Press.
- Rubia, K., Smith, A. B., Brammer, M. J., & Taylor, E. (2003). Right inferior prefrontal cortex mediates response inhibition while mesial prefrontal cortex is responsible for error detection. *NeuroImage, 20*, 351–358.
- Ruchkin, D. S., Grafman, J., Krauss, G. L., Johnson, R., Canoune, H. L., & Ritter, W. (1994). Event-related potential evidence for a verbal working memory deficit in multiple sclerosis. *Brain, 117*, 289–305.
- Rule, R. R., Shimamura, A. P., & Knight, R. T. (2002). Orbitofrontal cortex and dynamic filtering of emotional stimuli. *Cognitive, Affective & Behavioral Neuroscience, 2*, 264–270.
- Rusting, C. L. (1998). Personality, mood, and cognitive processing of emotional information: Three conceptual frameworks. *Psychological Bulletin, 124*, 165–196.
- Rusting, C. L. (2001). Personality as a moderator of affective influences on cognition. In J. P. Forgas (Ed.), *Handbook of affect and social cognition* (pp. 371–391). Mahwah, NJ: Erlbaum.
- Salway, A. F. S., & Logie, R. H. (1995). Visuospatial working memory, movement control and executive demands. *British Journal of Psychology, 86*, 253–269.
- Sanfrey, A. G., & Cohen, J. D. (2004). Is knowing always feeling? *Proceedings of the National Academy of Sciences, USA, 101*, 16709–16710.
- Sarason, I. G. (1960). Empirical findings and theoretical problems in the use of anxiety scales. *Psychological Bulletin, 57*, 403–415.
- Schmidt, L. A., & Trainor, L. J. (2001). Frontal brain electrical activity (EEG) distinguishes valence and intensity of music emotions. *Cognition and Emotion, 15*, 487–500.
- Schmidt, S. R. (2002). Outstanding memories: The positive and negative effects of nudes on memory. *Journal of Experimental Psychology: Learning, Memory, and Cognition, 28*, 353–361.
- Schumacher, E. H., Hendricks, M. J., & D'Esposito, M. D. (2005). Sustained involvement of a frontal-parietal network for spatial response selection with practice of a spatial choice-reaction task. *Neuropsychologia, 43*, 1444–1455.
- Shackman, A. J. (2000). Anterior cerebral asymmetry, affect, and psychopathology: Commentary on the withdrawal-approach model. In R. J. Davidson (Ed.), *Anxiety, depression, and emotion* (pp. 109–132). Oxford, England: Oxford University Press.
- Shallice, T. (1988). *From neuropsychology to mental structure*. New York: Cambridge University Press.
- Shiv, B., Loewenstein, G., Bechara, A., Damasio, H., & Damasio, A. R. (2005). Investment behavior and the negative side of emotion. *Psychological Science, 16*, 435–439.
- Smith, E. E., Jonides, J. M., Koeppel, R. A., Awh, E., Schumacher, E. H., & Minoshima, S. (1999). Spatial versus object working memory: PET investigations. *Journal of Cognitive Neuroscience, 7*, 337–356.
- Spielberger, C. D. (1983). *Manual for the State-Trait Anxiety Inventory: STAI*. Palo Alto, CA: Consulting Psychologists Press.
- Spies, K., Hesse, F. W., & Hummitchsch, C. (1996). Mood and capacity in Baddeley's model of human memory. *Zeitschrift für Psychologie, 204*, 367–381.
- Stemmler, G. (2003). Methodological considerations in the psychophysiological study of emotion. In R. J. Davidson, K. R. Scherer, & H. H. Goldsmith (Eds.), *Handbook of affective sciences* (pp. 225–255). New York: Oxford University Press.
- Strauss, M. E. (2001). Demonstrating specific cognitive deficits: A psychometric perspective. *Journal of Abnormal Psychology, 110*, 6–14.
- Sturm, W., & Willmes, K. (2001). On the functional neuroanatomy of intrinsic and phasic alternans. *NeuroImage, 14*, 76–84.
- Sutton, S. K., & Davidson, R. J. (1997). Prefrontal brain asymmetry: A biological substrate of the behavioral approach and inhibition systems. *Psychological Science, 8*, 204–210.
- Sutton, S. K., Davidson, R. J., Donzella, B., Irwin, W., & Dotts, D. A. (1997). Manipulating affective state using extended picture presentations. *Psychophysiology, 34*, 217–226.
- Tomarken, A. J., Davidson, R. J., & Henriques, J. B. (1990). Resting frontal brain asymmetry predicts affective responses to films. *Journal of Personality and Social Psychology, 59*, 791–801.
- Tomarken, A. J., Davidson, R. J., Wheeler, R. E., & Doss, R. C. (1992). Individual differences in anterior brain asymmetry and fundamental dimensions of emotion. *Journal of Personality and Social Psychology, 62*, 676–687.
- Tomarken, A. J., Davidson, R. J., Wheeler, R. E., & Kinney, L. (1992). Psychometric properties of resting anterior EEG asymmetry: Temporal stability and internal consistency. *Psychophysiology, 29*, 576–592.
- Tomarken, A. J., & Keener, A. D. (1998). Frontal brain asymmetry and depression: A self-regulatory perspective. *Cognition and Emotion, 12*, 387–420.

- Tomasino, B., & Rumiati, R. I. (2004). Effects of strategies on mental rotation and hemispheric lateralization: Neuropsychological evidence. *Journal of Cognitive Neuroscience, 16*, 878–888.
- Tranel, D., Bechara, A., & Denburg, N. L. (2002). Asymmetric functional roles of right and left ventromedial prefrontal cortices in social conduct, decision-making, and emotional processing. *Cortex, 38*, 589–612.
- Tukey, J. W. (1977). *Exploratory data analysis*. Reading, England: Addison Wesley.
- Updegraff, J. A., Gable, S. L., & Taylor, S. E. (2004). What makes experiences satisfying? The interaction of approach–avoidance motivations and emotions in well-being. *Journal of Personality and Social Psychology, 86*, 496–504.
- Velten, E. (1968). A laboratory task for induction of mood states. *Behavioral Therapy and Research, 6*, 473–482.
- Vingerhoets, G., & Stroobant, N. (1999). Lateralization of cerebral blood flow velocity changes during cognitive tasks. *Stroke, 30*, 2152–2158.
- Vuontela, V., Rämä, P., Raninen, A., Aronen, H. J., & Carlson, S. (1999). Selective interference reveals dissociation between memory for location and colour. *NeuroReport, 10*, 2235–2240.
- Wager, T. D., & Smith, E. E. (2003). Neuroimaging studies of working memory: A meta-analysis. *Cognitive, Affective & Behavioral Neuroscience, 3*, 255–274.
- Wallis, J. D., & Miller, E. K. (2003). Neuronal activity in primate dorso-lateral and orbital prefrontal cortex during performance of a reward preference task. *European Journal of Neuroscience, 18*, 2069–2081.
- Watson, D., Wiese, D., Vaidya, J., & Tellegen, A. (1999). The two general activation systems of affect: Structural findings, evolutionary considerations, and psychobiological evidence. *Journal of Personality and Social Psychology, 76*, 820–838.
- Westermann, R., Spies, K., Stahl, G., & Hesse, F. W. (1996). Relative effectiveness and validity of mood induction procedures: A meta-analysis. *European Journal of Social Psychology, 26*, 557–580.
- Wetherell, J. L., Reynolds, C. A., Gatz, M., & Pedersen, N. L. (2002). Anxiety, cognitive performance and cognitive decline in normal aging. *Journals of Gerontology: Psychological Sciences, 57B*, P246–P255.
- Willis, W. G., & Goodwin, L. D. (1987). An alternative to interference indexes in neuropsychological time-sharing research. *Neuropsychologia, 25*, 719–724.
- Wittling, W. (1997). The right hemisphere and the human stress response. *Acta Physiologica Scandinavica, 640*, 55–59.
- Woodson, J. C., Macintosh, D., Fleshner, M., & Diamond, D. M. (2003). Emotion-induced amnesia in rats: Working memory-specific impairment, corticosterone-memory correlation, and fear versus arousal effects on memory. *Learning & Memory, 10*, 326–336.
- Yamasaki, H., LaBar, K. S., & McCarthy, G. (2002). Dissociable prefrontal brain systems for attention and emotion. *Proceedings of the National Academy of Sciences, USA, 99*, 11447–11451.
- Young, A. H., Gallagher, P., Watson, S., Del-Estal, D., Owen, B. M., & Ferrier, I. N. (2004). Improvements in neurocognitive function and mood following adjunctive treatment with mifepristone (RU-486) in bipolar disorder. *Neuropsychopharmacology, 29*, 1538–1545.
- Young, A. H., Sahakian, B. J., Robbins, T. W., & Cowen, P. J. (1999). The effects of chronic administration of hydrocortisone on cognitive function in normal male volunteers. *Psychopharmacology, 145*, 260–266.
- Zald, D. H. (2003). The human amygdala and the emotional evaluation of sensory stimuli. *Brain Research Reviews, 41*, 88–123.

Received February 9, 2004

Revision received June 20, 2005

Accepted June 24, 2005 ■