

3-31-2007

Application of Lean Six Sigma techniques to optimize hospital laboratory Emergency Department Turnaround time across a multi-hospital system

Heather (Woodward) Hagg
Purdue-West Lafayette, RCHE, heatherhagg@purdue.edu

Susan Scachitti
Purdue-Calumet, scachitt@calumet.purdue.edu

Lash Mapa
Purdue-Calumet, mapa@calumet.purdue.edu

Lillie Brandford
SSFHS

Chris Vanni
SSFHS

See next page for additional authors

Follow this and additional works at: http://docs.lib.purdue.edu/rche_rp

 Part of the [Business Administration, Management, and Operations Commons](#)

Hagg, Heather (Woodward); Scachitti, Susan; Mapa, Lash; Brandford, Lillie; Vanni, Chris ; and Cox, Catherine, "Application of Lean Six Sigma techniques to optimize hospital laboratory Emergency Department Turnaround time across a multi-hospital system" (2007). *RCHE Publications*. Paper 30.
http://docs.lib.purdue.edu/rche_rp/30

This document has been made available through Purdue e-Pubs, a service of the Purdue University Libraries. Please contact epubs@purdue.edu for additional information.

Authors

Heather (Woodward) Hagg, Susan Scachitti, Lash Mapa, Lillie Brandford, Chris Vanni, and Catherine Cox

Application of Lean Six Sigma techniques to optimize hospital laboratory Emergency Department Turnaround time across a multi-hospital system

Heather Woodward, IUPUI
Susan Scachitti, Purdue-Calumet
Lash Mapa, Purdue-Calumet
Chris Vanni, SSFHS
Lillie Brandford, SSFHS
Catherine Cox, SSFHS

Abstract:

In January 2005, Indiana University, Purdue University at Indianapolis (IUPUI) and Purdue- Calumet were invited to partner with the Alverno Clinical Labs in adapting Lean Six Sigma methodologies for use within healthcare. Our initial project focused on optimization of lab services for the emergency department at the Saint Margaret Mercy Hospitals in Hammond, IN. This project resulted in reduction of lab test report time to the emergency department from 75 minutes to less than 35 minutes. These results have been sustained from the initial implementation to present – over 14 months. Additionally, this project has been successfully implemented across two additional hospitals lab within the Alverno-Provena Clinical Labs system.

This paper will describe the partnership between IUPUI faculty and Alverno Clinical Labs in application of Lean Six Sigma techniques to optimize hospital lab services for the emergency department. Additionally, this paper will discuss the strategies and methodologies used to sustain initial results following the initial implementation and the key characteristics of successful project migration to additional hospital labs.

Background:

The response time for medical lab tests is very critical to the quality of care received by patients within the Emergency Department (ED). Standards for response time indicate that goals should be set to 60 minutes from the time that the laboratory test is ordered until the time that the test result is verified and reported to the ED staff¹. Delays in laboratory reporting processes often result in decreased patient satisfaction, throughput, quality of care, employee satisfaction and ultimately, hospital revenue².

This goal of this project was to examine and optimize the medical lab processes to reduce the turnaround for Emergency Department Lab Orders to less than 60 minutes.

Experimental Method:

A Lean Six Sigma team was created in January 2005. The initial team was composed of phlebotomy, clerking and medical technician front line and supervisory staff from the St. Margaret Mercy Hospital Labs in Dyer and Hammond, IN, as well as several team participants from the Alverno/Provena Core lab facility in Hammond, Indiana.

The team met during 16 weekly sessions of instruction in Lean Six Sigma tools as well as direct, practical application of tools directly to the process under investigation. These sessions were facilitated by Industrial and Mechanical Engineering Technology faculty from Purdue Schools of Engineering and Technology at Purdue-Calumet and Indiana University-Purdue University at Indianapolis (IUPUI). Additionally, faculty from both campuses provided an additional 15 hours per week of on-site mentoring for the project teams through project implementation.

The Six Sigma Methodology:

The Six Sigma DMAIC Methodology was utilized for this investigation and is summarized below^{3, 4}:

Define a problem, set a goal striving for customer satisfaction and aligning business objectives.

Measure the process by collecting relevant data to realize issues and for future comparison.

Analyze to verify connection and cause of problems.

Improve or the process by reducing variation, based upon the analysis.

Control the process and maintain the reduction of variation.

Define Phase:

A business case, problem statement and goal statement for the project were developed. The decision was made to limit the scope of this investigation to only Emergency Department (ED) STAT orders and eliminate RN collected specimens, send out tests and when the patient is unavailable for testing.

A Supplier, Output, Process, Input, Customer (SIPOC) process flow was created to identify appropriate stakeholders and customers to the process.

A Voice of the Customer (VOC) analysis was performed by interviewing a representative sample of the relevant customers groups and asking four key questions:

1. What do you like about the existing ED Lab Processes for STAT orders?
2. What are the weaknesses within the ED Lab Processes for STAT orders?
3. What are the opportunities for improving the ED Lab Processes for STAT orders?
4. What could potentially threaten the success of this project?

The Critical to Quality (CTQ) requirements for each customer and stakeholder were identified. One category of CTQs was identified across the stakeholder group as being within the scope of this project: the requirement that ED lab reports be returned to the ED staff within 60 minutes.

Appropriate process output variables for each category of CTQ, also known as Key Process Output Variables (KPOVs), were determined and is linked to the CTQ within the CTQ trees displayed in Figure 2. Additionally, Key Process Input Variables (KPIVs) were determined and linked to each KPOV are also displayed in Figure 2.

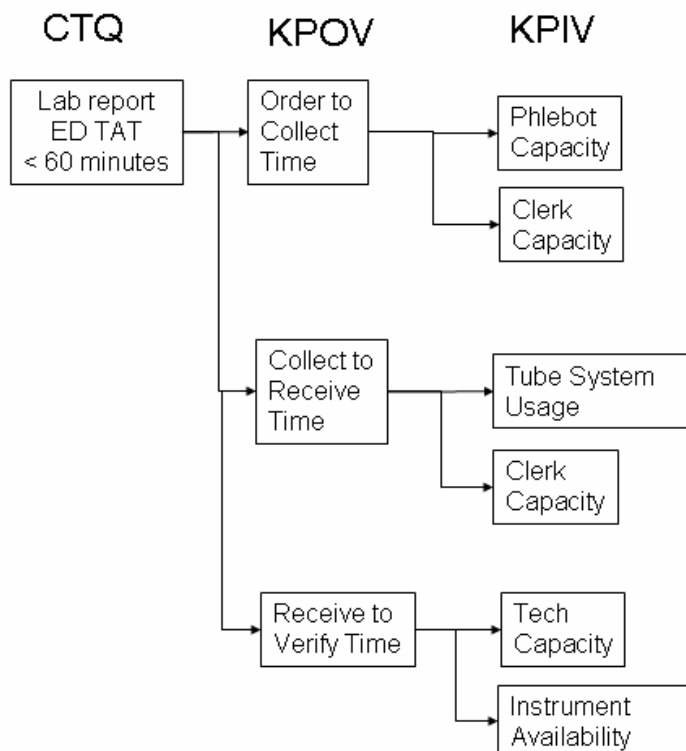

Figure 2: CTQ Tree for Lab TAT project. CTQ: Critical to Quality Requirement, KPOV: Key Process Output Variable, KPIV: Key Process Input Variable

Measure Phase:

A basic process flow of the lab processes was created and is shown in Figure 3. The process is broken down in the three phases: 1) Order to Collect: the time from when the order is placed within the lab system until the specimen is collected, 2) Collect to Receive: the time from when the specimen is collected until the specimen is received in the lab, and 3) Receive to Verify: the time from when the specimen is received in the lab until the result is verified and report returned to the ED physician. Operational barriers and processing delays are highlighted using the red stars.

A measurement plan was created for each of the KPOVs, incorporating KPIVs as stratification variables. Historical data representing a 16 week cycle (January-April 2005) was pulled from the lab reporting systems to determine the historical baseline for each KPOV. These graphs are shown as Figures 4a-4c. Additionally, test turn around time (TAT) for ED Stat orders was manually collected for a 4 week period to validate historical results. The manual data was found to closely correlate to the historical data for each KPOV. A summary of average processing times is shown in Figure 5.

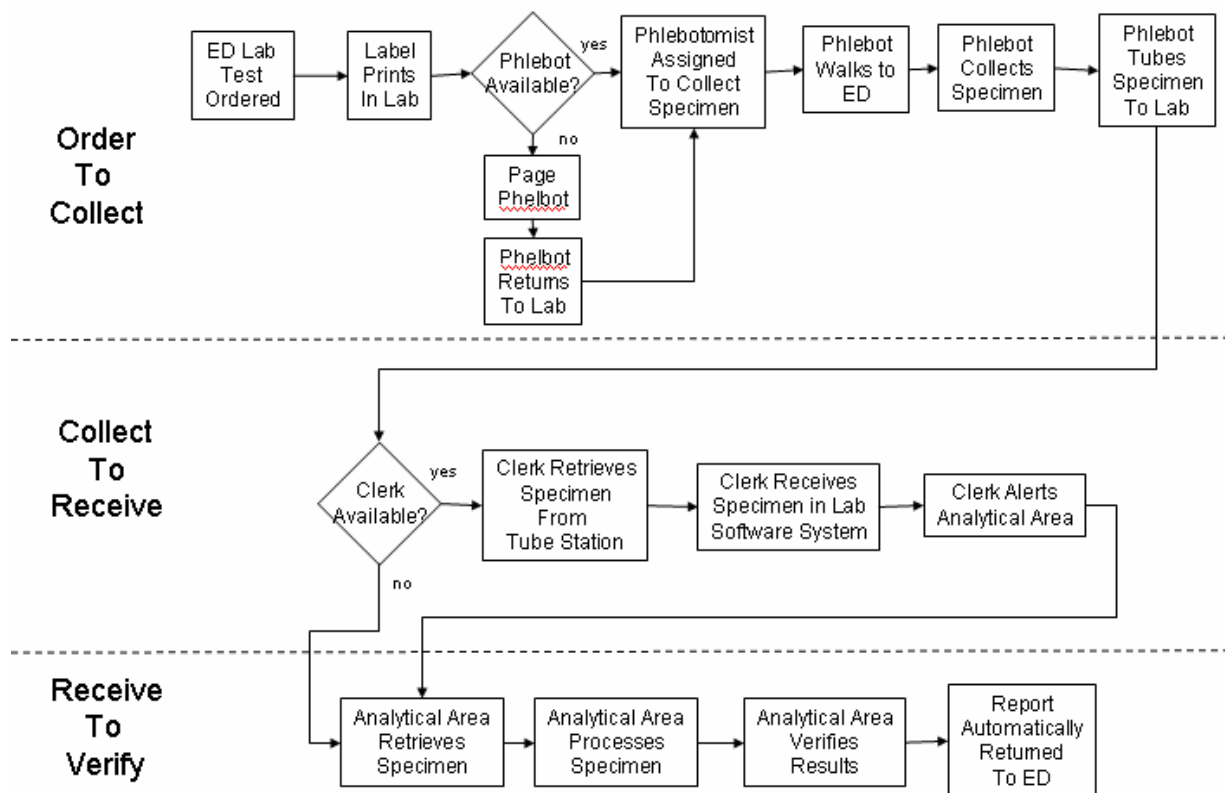

Figure 3. Basic Process Flow of Lab processes

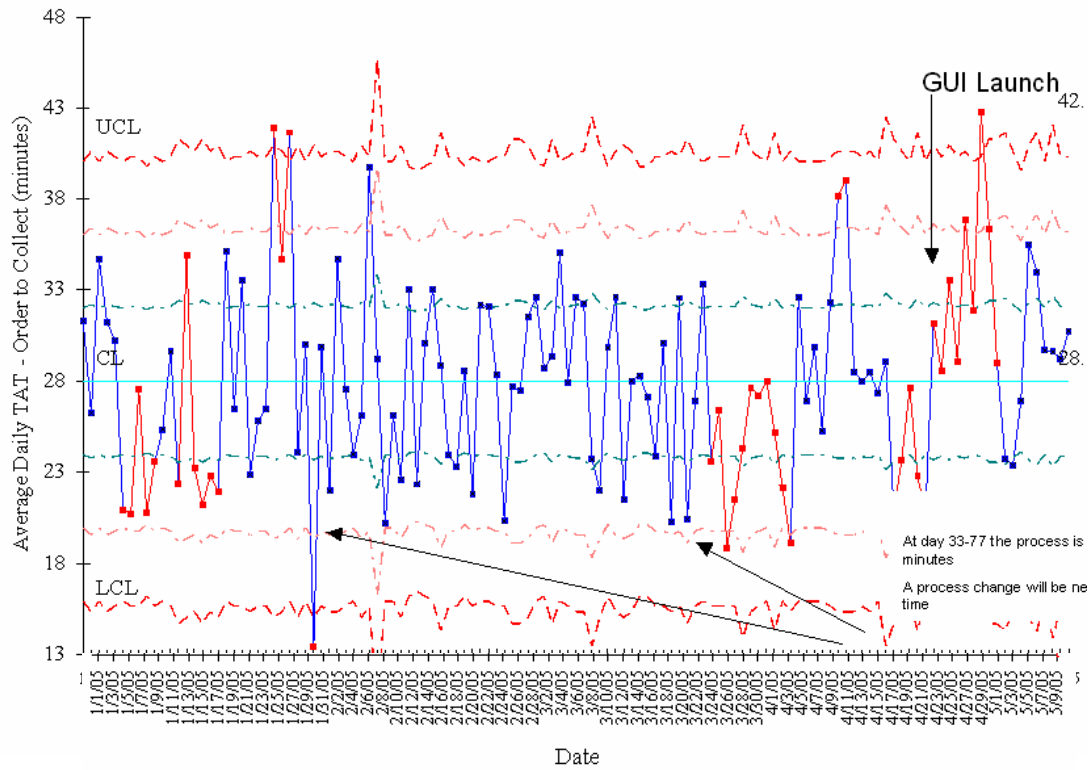

Figure 4a. Average Daily Order to Collect Processing Time Jan'05-May'05

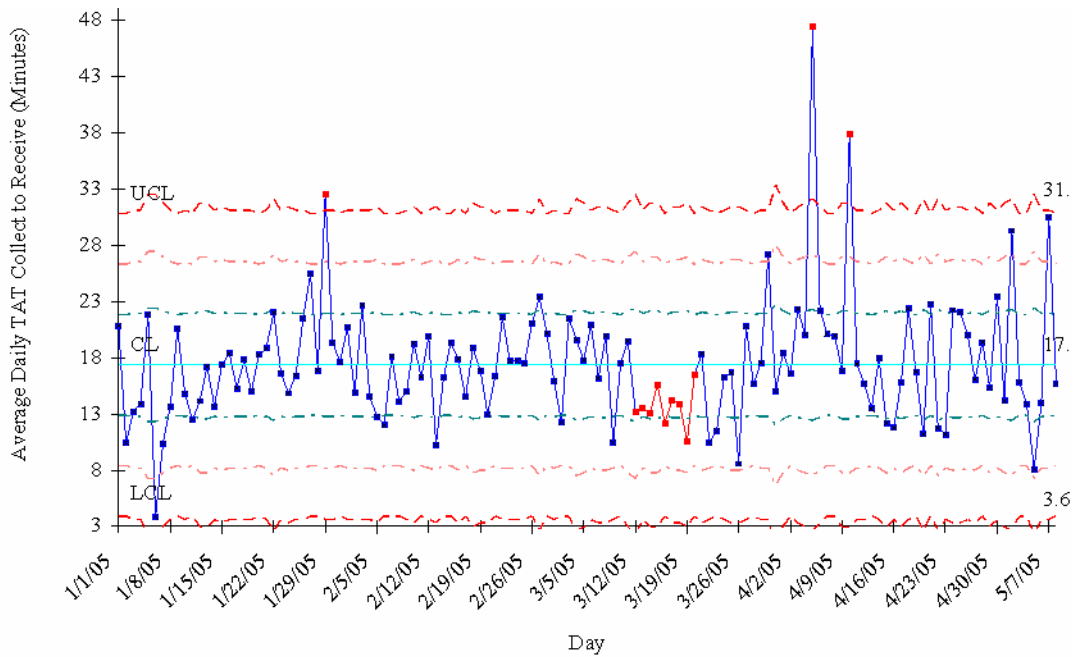

Figure 4b. Average Daily Collect to Receive Processing Time Jan'05-May'05

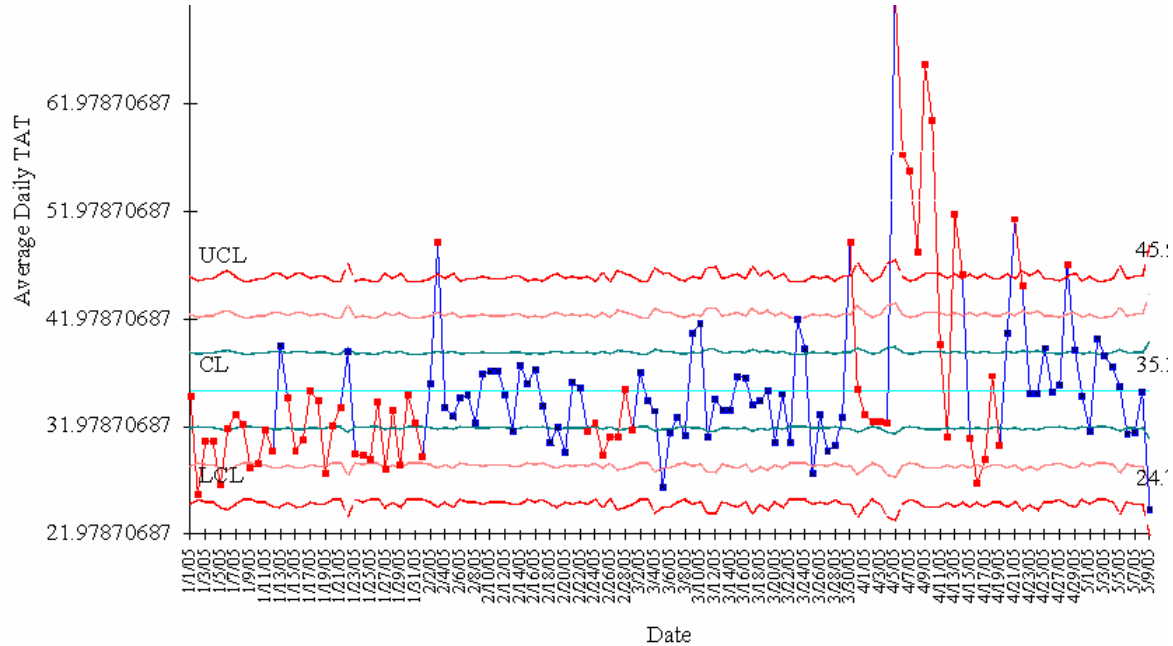

Figure 4c. Average Daily Receive to Verify Processing Time Jan'05-May'05

Best Case:	Average:	Worst Case:
Order to Collect: 16 minutes	Order to Collect: 28 minutes	Order to Collect: 40 minutes
Collect to receive: 4 minutes	Collect to receive: 18 minutes	Collect to receive: 32 minutes
Received to verify: 22 minutes	Received to verify: 32 minutes	Received to verify: 42 minutes
Best TAT: 42 minutes	Average TAT: 78 minutes	Worst TAT: 114 minutes

Figure 5. Summary of Daily Average ED Lab Turn Around Times

Results and Discussion:

Analyze Phase:

As shown in Figure 4a and 4b and summarized in Figure 5, the average duration from the time that the order was placed until the specimen was collected (Order to Collect Time) was found to be 28 minutes, with a range from 16-40 minutes and the Collect to Receive Time was found to be 18 minutes with a range of 4-32 minutes. Multiple direct process observation studies were conducted by the team members to determine the extended duration for specimen collection and specimen receipt. These studies indicated that under the current systems and processes, 1) ED stat orders regularly waited until phlebotomists completed collections on non-stat orders and 2) stat specimens for multiple ED patients were often batched together by the phlebotomist prior to sending through the tube system to the lab. Additionally, the team members found that due to lack of clerking capacity and awareness to stat specimens, ED stat specimens often waited for processing to the analytical areas once they entered the clerking station.

To validate the direct process observation findings, the Work in Process (WIP) for the collection process (Order to Collect) was determined as a function of the ordered hour of day for the total hospital volume (Figure 6). Occurrences of negative WIP indicate that the majority of specimens during that hour were collected prior to being ordered within the system. This type of activity is typically related to emergent or time critical patient care events. As expected, the WIP is shown to increase from 7am-11am, indicating insufficient phlebotomy capacity during that timeframe. The result is that WIP does not decrease to zero (indicating no stat orders in queue) until 1700 hours. The total hospital volume was chosen as the phlebotomist and clerk staffing was not dedicated to the ED, but shared throughout the hospital. However, as illustrated in Figure 7, the ED WIP mimics the trends of increased WIP from 9am-noon.

To determine the appropriate phlebotomist staffing levels, an investigation into phlebotomist and clerking capacity was conducted (Figure 8, 9). This analysis indicated that the number of specimens collected by phlebotomist averaged 16 specimens per hour and the average number of specimen processed by the clerk at 60 per hour. However, the phlebotomy capacity was found to decrease significantly in the mid-March timeframe.

A similar investigation in the clerking capacity found that due to a health issue, clerk staffing became irregular during this timeframe (Figure 9), requiring the phlebotomist to cover clerking responsibilities to compensate for the inadequate staffing. Additionally, the clerk incoming phone volume was found to peak significantly at nearly 50 minutes of incoming call volume per hour between noon-2pm.

As a result of these findings, a decision was made to focus improvements on improving phlebotomist and clerking processes to increase capacity and improve hand-offs and awareness of the processing status of ED stat specimen.

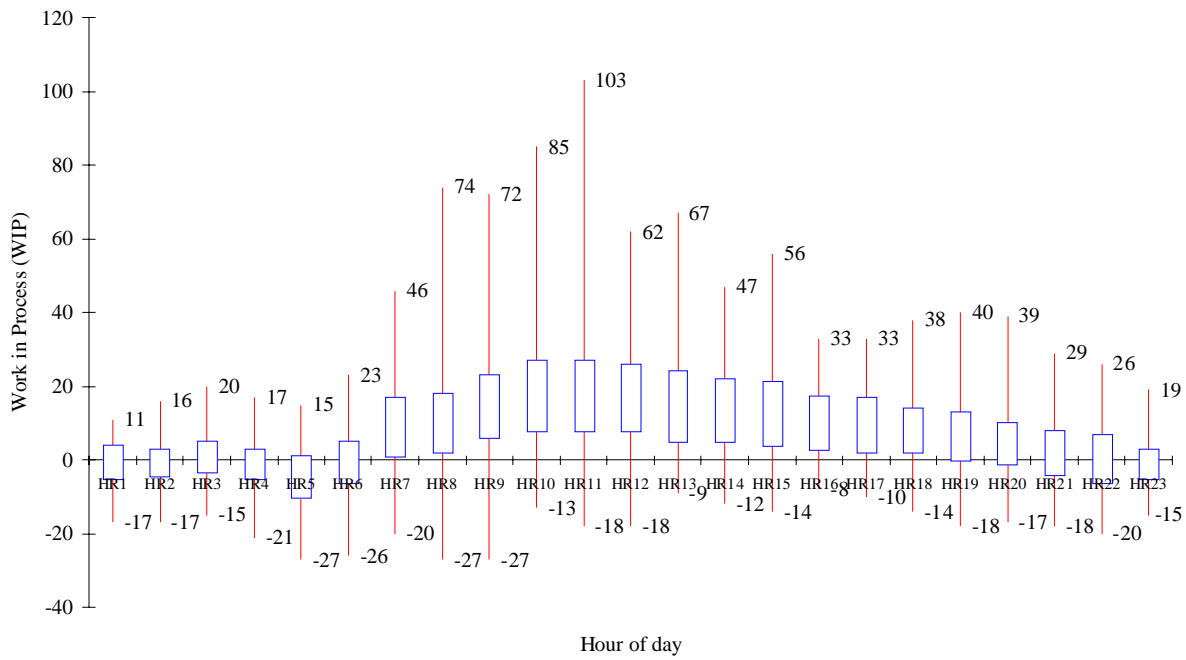

Figure 6. Total Hospital Volume Work in Process (WIP) for the collection process by Hour of the Day

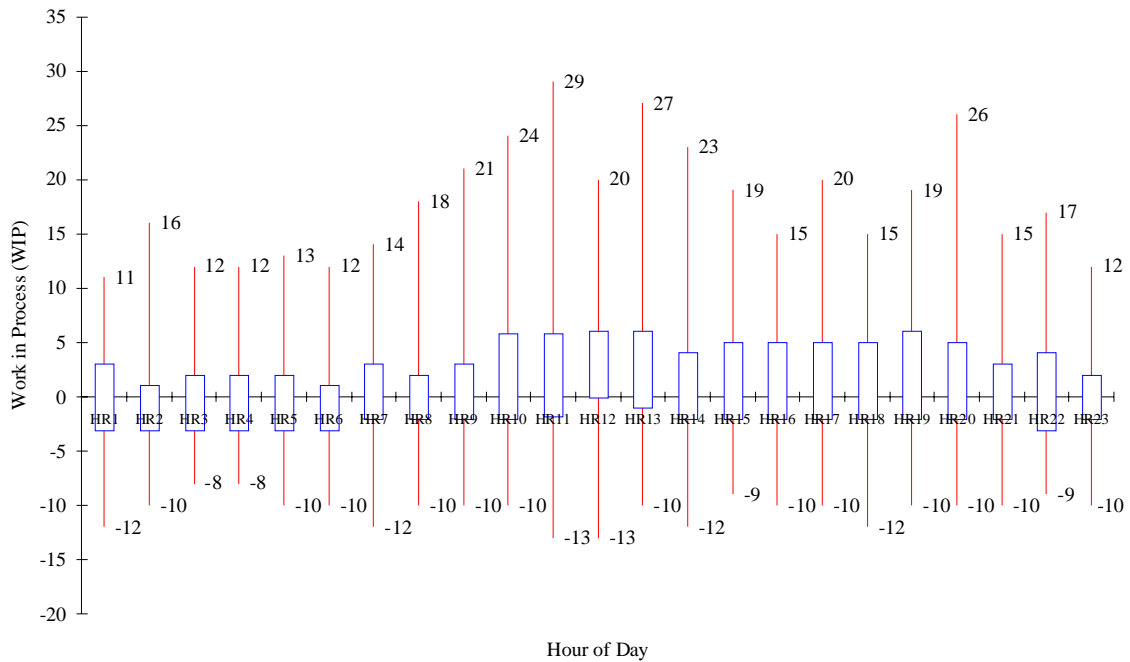

Figure 7. Total ED Volume Work in Process (WIP) for the collection process by Hour of the Day

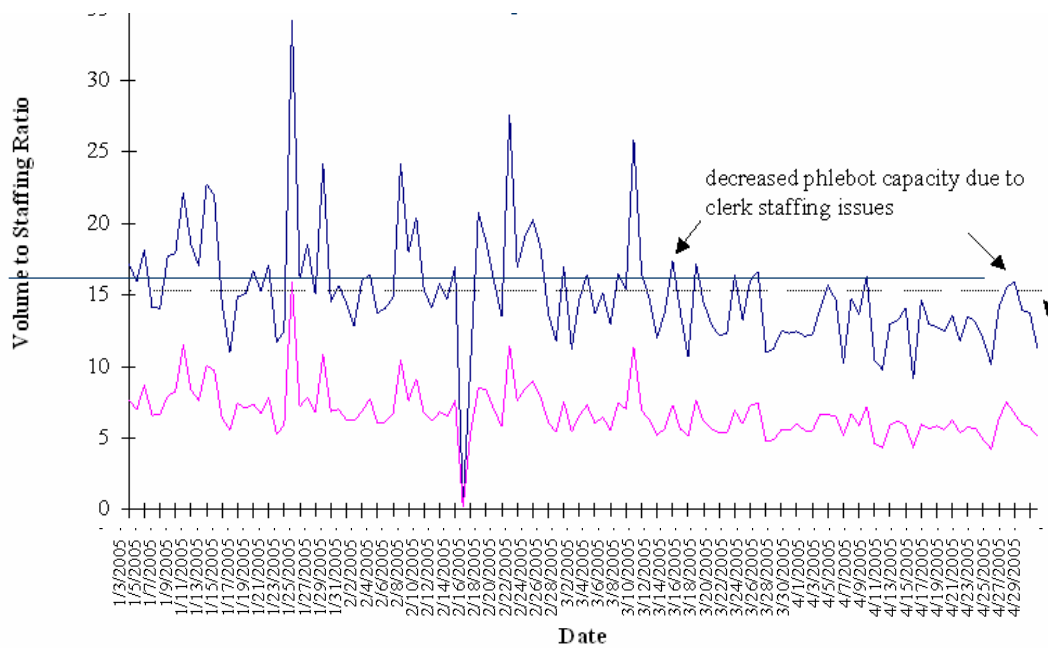

Figure 8. Average Daily Collection Volume per man hours worked -Phlebotomist

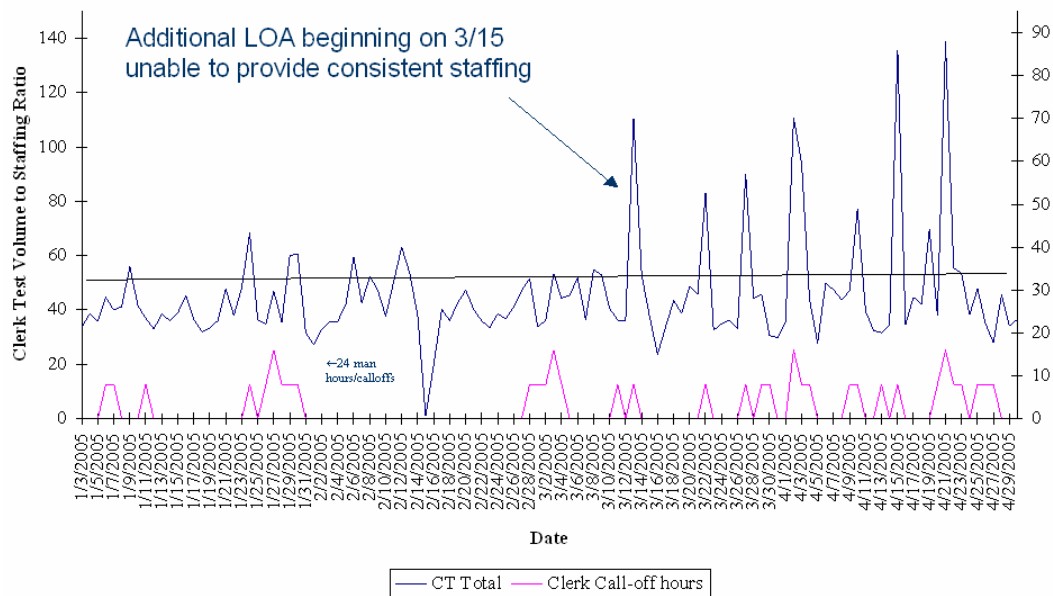

Figure 9. Average Daily Collection Volume per man hours worked -Clerk

Improve Phase:

Informal meetings were held with the clerk and phlebotomist teams across all shifts in order to generate multiple solutions to increase clerking and phlebotomist capacity. Solutions were developed to improve phlebotomist and clerk workflows, apply visual tools to improve recognition of ED specimens and progress through processing steps. Each solution was evaluated on the basis of cost, likelihood of success, and ease of implementation.

Solutions were implemented using a staggered implementations and included: 1) application of Lean techniques to optimize the clerking workflow (Figure 10), 2) development of consistent clerking roles and responsibilities, 3) dedicated phlebotomists to hospital areas based on order volumes, including a dedicated phlebotomist to the ED and 4) application of visual controls, such as red bags for ED stat specimens and red indicator lights to alert the clerk and analytical areas of specimen processing status (Figure 10,11).

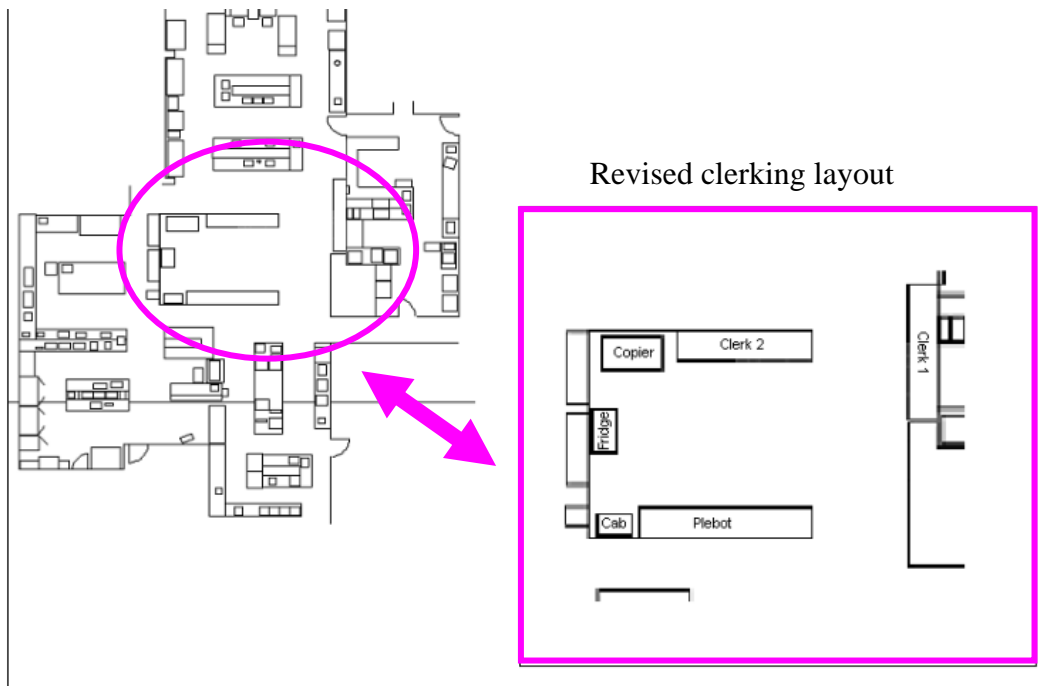

Figure 10. Revised Clerking Station layout following application of Lean Techniques

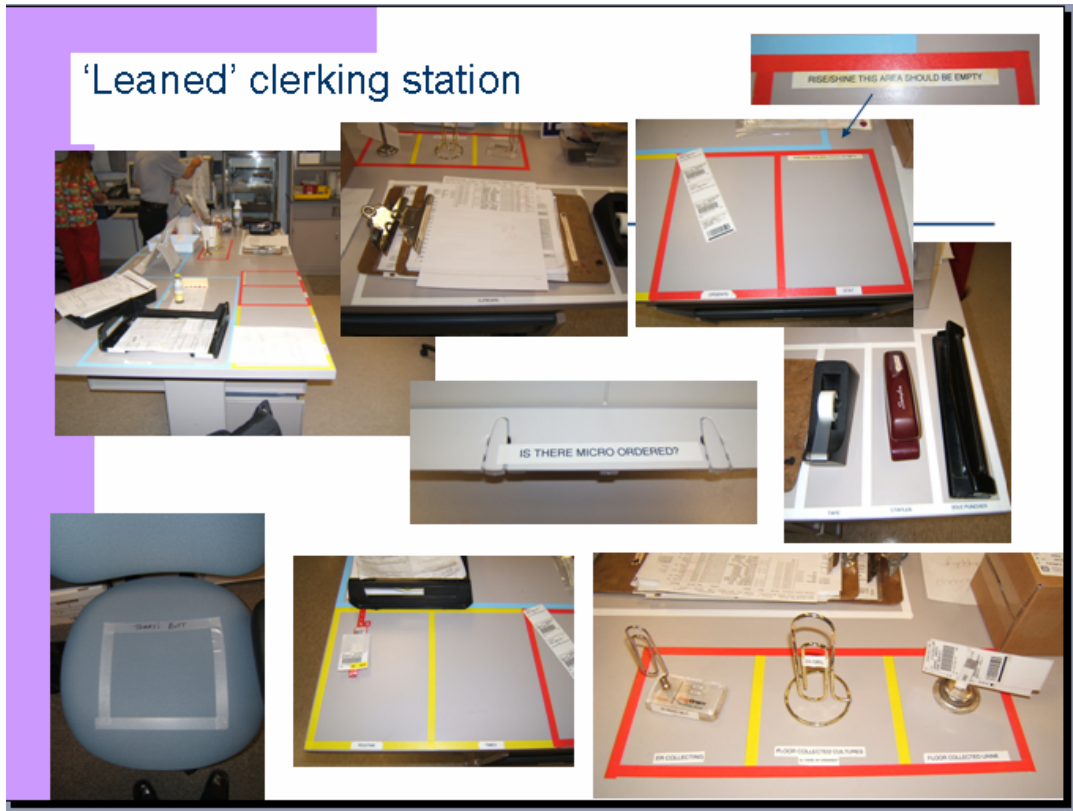

Figure 11. Revised Clerking Station following application of Visual Control and 5S Lean Techniques

Control Phase:

Process performance was monitored through the use of the lab reporting system, coupled with Excel macros, to create daily reports and trend graphs of each KPOV. These reports and trend graphs were reviewed by the lab supervisors and managers on a daily basis with the front line staff. Additionally, reports and graphs of output metrics were posted on the floor and updated to provide regular feedback to the staff of their performance against goal. Specimens not meeting goal were reviewed, causal factors contributing to the failure mode were identified and action plans put in place to eliminate or minimize impact to future processing.

Results from the initial 6 weeks following implementation indicate a significant improvement in ED Stat Lab report TAT from 75 minutes to 45 minutes (Figure 12b). Additionally, the % of tests returned within the 60 minute goal increased from 60% to an average of over 80% (Figure 12a). As shown in Figures 13, this trend has continued to the present within current report ED Stat Lab report TAT with 85% of all tests returned within the 60 minute goal.

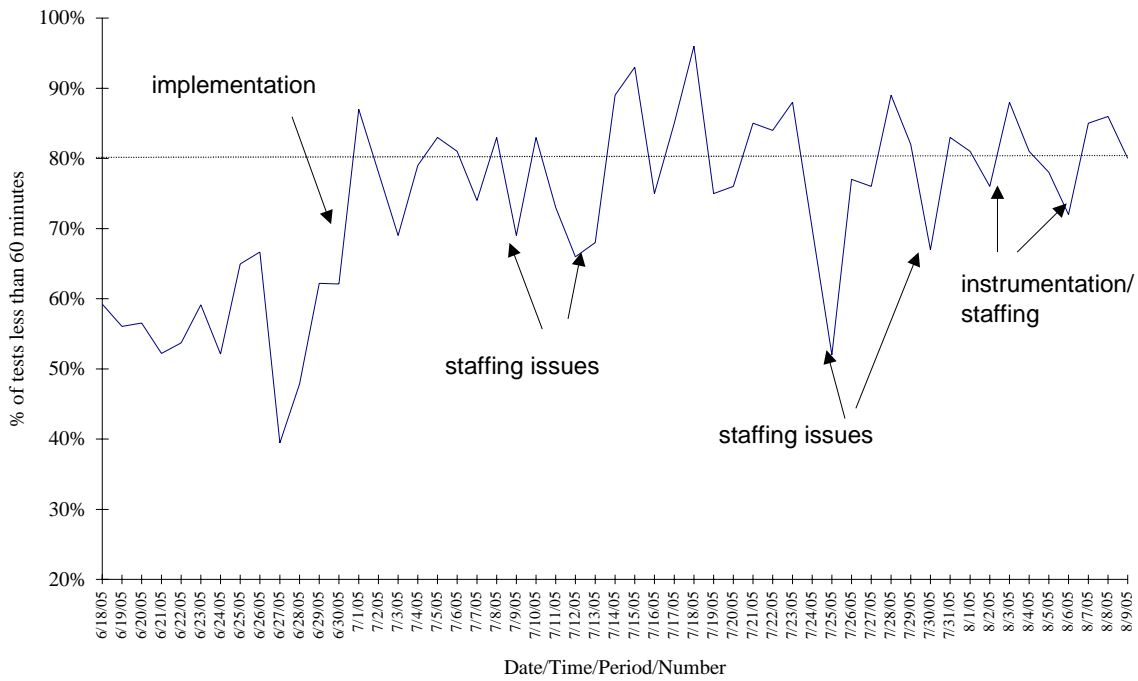

Figure 12a. % of ED Stat Orders verified within 60 minutes (Order to Verify) 6/1/2005-8/9/2005

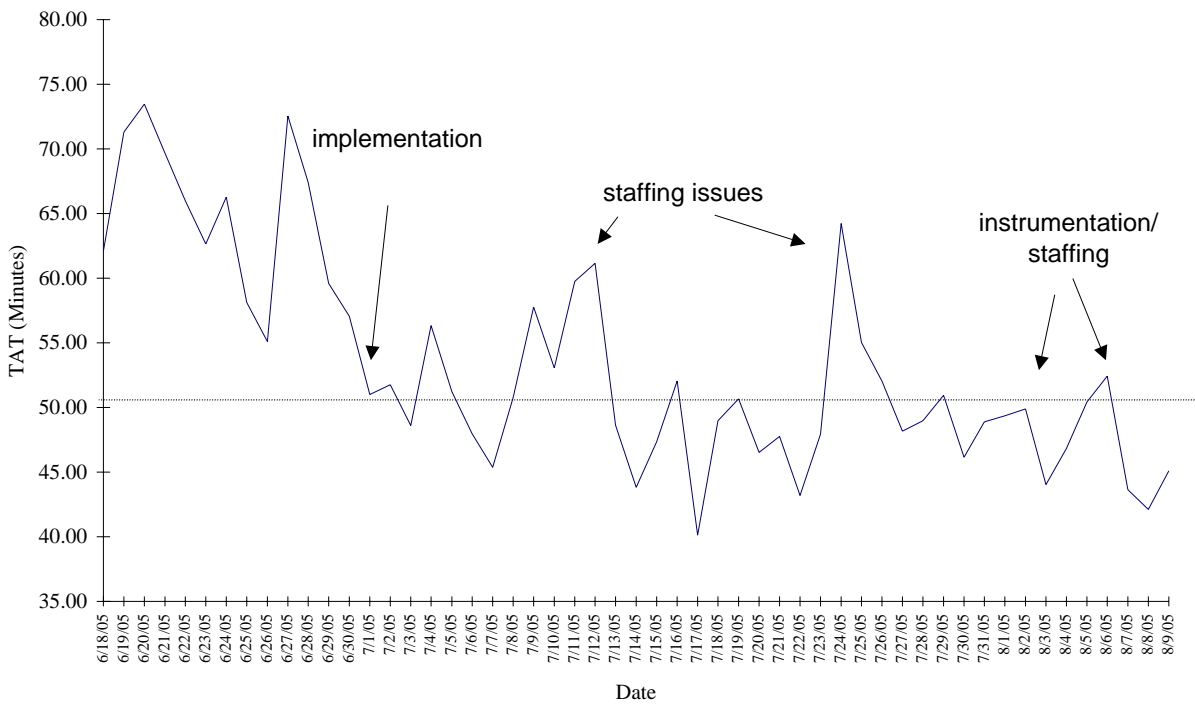

Figure 12b. Average Daily Duration for ED stat orders (Order to Verify) 6/1/2005-8/9/2005 – Post Pilot Results

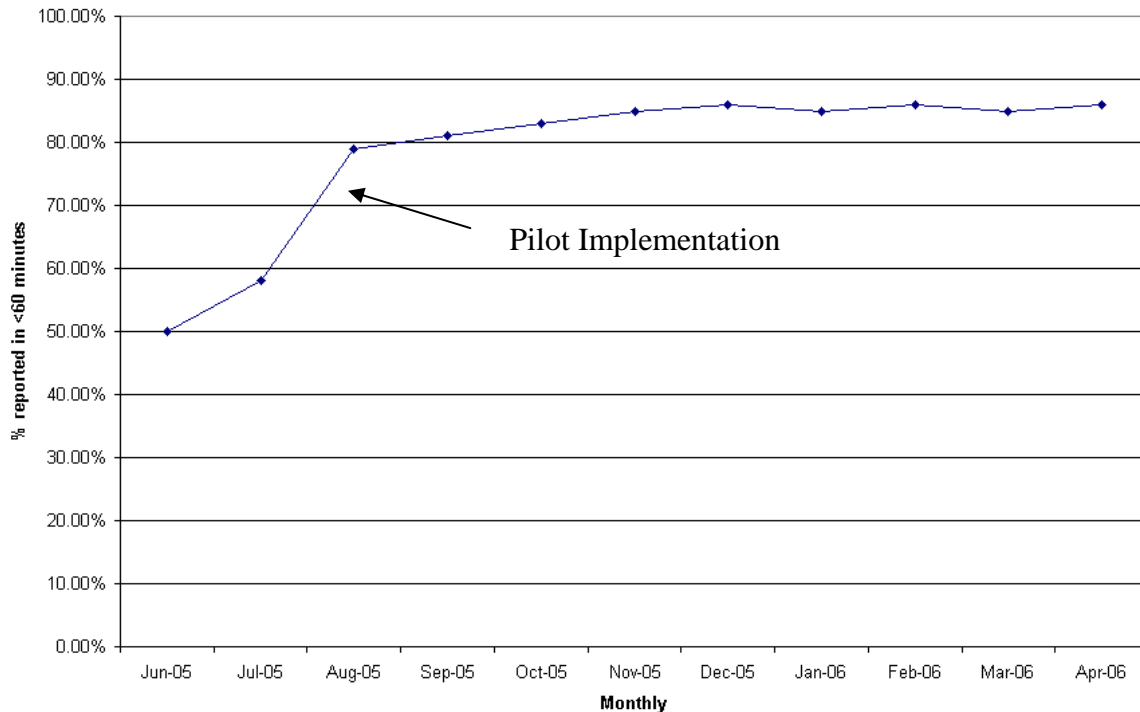

Figure 13. Average Daily % of ED stat orders (Order to Verify) returned within 60 minutes through April, 2006

Project Spread:

Following the success of the project at the Saint Margaret Mercy Lab in Hammond, Indiana, the project was transitioned to Saint Margaret Mercy Hospital Lab in Dyer, Indiana, and the St. Anthony Memorial Medical Lab in Michigan City, Indiana.

In each case, a compressed (5 week) training schedule was used to train teams composed of front line staff members in Lean Six Sigma tools. Although the St. Margaret Mercy - Hammond project was presented as part of this training, the Define, Measure and Analysis phases of the DMAIC process were conducted in each hospital to determine location specific failure modes and develop solutions for KPOVs/KPIVs highlighted during the project sessions. In each case, failure modes unique to that specific hospital and hospital lab processes were highlighted and solutions implemented to reduce or eliminate impact. Figures 13a and 13b show the improved ED Stat TAT results obtained and sustained in the Dyer and St. Anthony Memorial Hospital Labs.

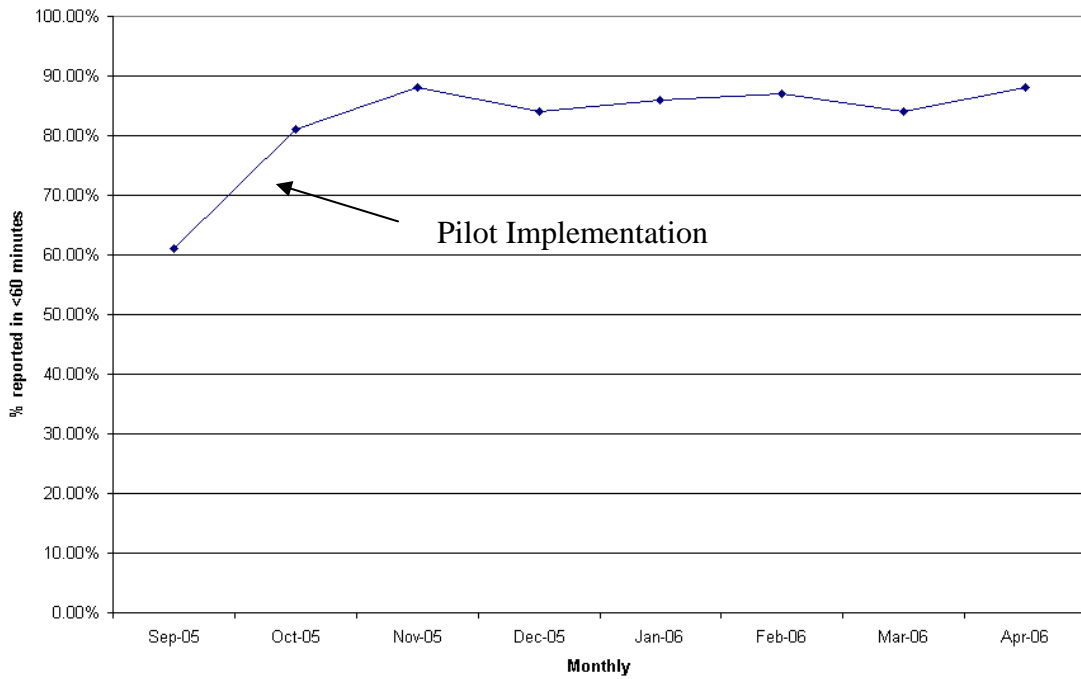

Figure 13a. Average Daily % of ED stat orders (Order to Verify) returned within 60 minutes through April, 2006
St. Margaret Mercy - Dyer

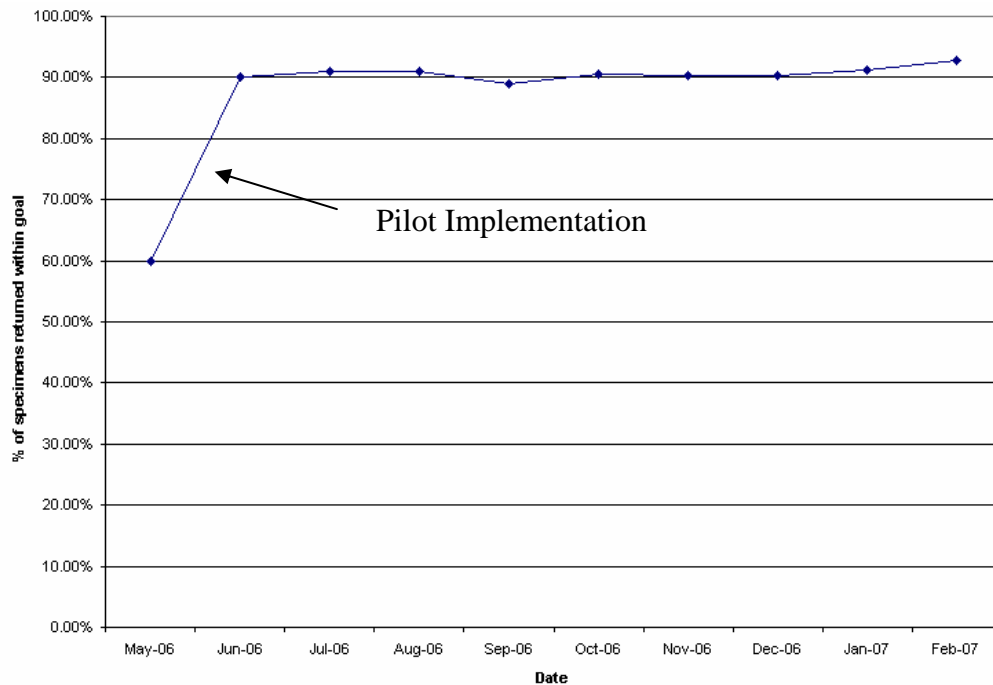

Figure 13b. Average Daily % of ED stat orders (Receive to Verify) returned within 30 minutes through Feb, 2007
St. Anthony Memorial – Michigan City

Lessons Learned:

There were many lessons learned from this series of projects, including the importance of teambuilding and participation in order to achieve staff buy-in as well as the significance of cultural transformation to long term sustainability of improvements. Additionally, the spread adoption was assisted by encouraging site to site sharing of best practices and information.

Conclusions:

We have successfully applied Lean Six Sigma methodologies to improve turn around time (TAT) for Emergency Department (ED) Stat orders within 3 hospital labs through application of a Lean Six Sigma training program. As a result of this program, the collection to report processing times for ED stat specimens have decreased from an average of 75 minutes to less than 35 minutes. The improvement results have been sustained over time across all 3 implementation sites.

¹ Stankovic AK.. *The laboratory is a key partner in assuring patient safety..* Clin Lab Med. 2004 Dec;24(4):1023-35.

² Jimmerson C, Weber D, Sobek DK 2nd. *Reducing waste and errors: piloting lean principles at Intermountain Healthcare.* Jt Comm J Qual Patient Saf. 2005 May;31(5):249-57.

³ Caldwell C. *Lean-Six Sigma: tools for rapid cycle cost reduction..* Healthc Financ Manage. 2006 Oct;60(10):96-8.

⁴ Daley AT. *Pro: lean six sigma revolutionizing health care of tomorrow..* Clin Leadersh Manag Rev. 2006 Sep 26;20(5):E2.