

APPLICATION OF NEURAL NETWORKS FOR ROUTING
IN TELECOMMUNICATIONS NETWORKS

by

Mark Collett

A thesis
presented to the University of Manitoba
in partial fulfillment of the requirements
for the degree of
Master of Science of Electrical Engineering

Department of
Electrical and Computer Engineering
University of Manitoba
Winnipeg, Manitoba, Canada 1992

© Mark Collett 1992

APPLICATION OF NEURAL NETWORKS FOR ROUTING
IN TELECOMMUNICATIONS NETWORKS

BY

MARK COLLETT

A Thesis submitted to the Faculty of Graduate Studies of the University of Manitoba in
partial fulfillment of the requirements for the degree of

MASTER OF SCIENCE

© 1992

Permission has been granted to the LIBRARY OF THE UNIVERSITY OF MANITOBA to
lend or sell copies of this thesis, to the NATIONAL LIBRARY OF CANADA to microfilm
this thesis and to lend or sell copies of the film, and UNIVERSITY MICROFILMS to
publish an abstract of this thesis.

The author reserves other publication rights, and neither the thesis nor extensive extracts
from it may be printed or otherwise reproduced without the author's permission.

I hereby declare that I am the sole author of this thesis.

I authorize the University of Manitoba to lend this thesis to other institutions or individuals for the purpose of scholarly research.

I authorize the University of Manitoba to reproduce this thesis by photocopying or other means, in total or in part, at the request of other institutions or individuals for the purpose of scholarly research.

Abstract

This thesis applies neural networks to an application in the field of telecommunications. Neural networks are investigated to determine if they can be used to perform routing decisions within a telecommunications network. Once a neural network was modelled to perform the routing function for an individual node in a network, the modelling is extended to a sample telecommunications network to evaluate its performance in a variety of network conditions.

Acknowledgements

I would like to thank Dr. Witold Pedrycz for his guidance and support in the production of this thesis, and Matt Jensen - the creator of the MacBrain program - for his advice in using MacBrain to perform the neural network simulations performed as part of the research.

Dedication

*This thesis is dedicated to
Jackie, for her constant support and interest in this work
My parents, for their constant interest and inquiries, and
Shatzie, who always reminded me when it was time to take a break.*

Table of Contents

Chapter 1 - Introduction

1.1 Purpose	1
1.2 Problem	1
1.3 Scope	2

Chapter 2 - Overview

2.1 The telecommunications network	4
2.1.1 Telecommunications network structure	5
2.1.2 Routing and network reliability	8
2.1.3 Transport network protection and restoration	11
2.1.3.1 Protection channels and manual restoration	11
2.1.3.2 Digital cross connect systems	14
2.1.3.3 Survivable ring architectures	14
2.1.3.4 Dynamic restoration methods and self healing	17
2.2 Routing Theory	20
2.2.1 Combinatorial techniques	22
2.2.2 Algebraic techniques	24
2.3 Neural networks and telecommunications routing	24
2.4 Attributes of an optimal routing method using neural networks	27
2.5 Description of the routing method under study	28

Chapter 3 - Single node modelling

3.1 Description	33
3.1.1 Description of the sample network	33
3.1.2 Description of the neural network	34
3.1.2.1 Learning rule	36
3.1.2.2 Topology	36
3.1.2.3 Activation function and associated variables	36
3.1.2.4 Learning rate and momentum	37
3.1.3 Determination of the routing information	38
3.1.4 Description of the modelling package	43
3.2 Training the neural networks	46

3.2.1	The V1 Macro	46
3.2.2	Initial analysis of the V1 Macro trained networks	47
3.2.3	The V2 and V3 Macros	53
3.3	Analysis of the V1, V2, and V3 Macro results	56
3.3.1	Analysis of the individual network results.	56
3.3.1.1	Average and standard deviation results for the trained networks	57
3.3.1.2	Full and modified value results	57
3.3.1.3	Distribution of difference values	59
3.3.1.4	Direct comparison of results between the different networks and macros	60
3.3.2	Comparison #1 - description and results	60
3.3.3	Comparison #2 - description and results	61
3.3.4	Comparison #3 - description and results	64
3.3.5	Comparison #4 - description and results	64
3.3.6	Summary of conclusions from Comparisons 1 to 4	67
3.3.7	Comparison of the routing results of the trained networks	68
3.3.8	Modification of the training set	72
3.3.9	Comparison of the initial and modified training set networks	75
3.4	Conclusions from single network node modelling	77
Chapter 4 - Full network modelling		
4.1	Full network simulation results	80
4.2	Performing routing decisions	81
4.2.1	Postprocessing of the output values	83
4.3	Simulation of a routing decision - normal network	87
4.3.1	Successful selection of optimal route	87
4.3.2	Unsuccessful selection of optimal route	89
4.4	Simulation of a routing decision around unavailable links	91
4.4.1	Selection of an alternate route to the destination node	92
4.4.2	Selection or alternate routing around an unavailable link	93
4.4.3	Unsuccessful selection of alternate route	96
4.5	Simulation of a routing decision - node failure	97
4.5.1	Routing around an unavailable node between originating and destination nodes	98

4.5.2 Routing determination when the destination node is unavailable	101
4.5.3 Unsuccessful selection of alternate route	102
4.6 Simulation of generalized routing decisions	103
4.6.1 Generalization test results	105
4.6.2 Summary of generalization tests	109

Chapter 5 - Conclusions and recommendations

5.1 Conclusions	110
5.2 Recommendations	111

References

Appendix A - Training macros and sets

Appendix B - Single node modelling results

Appendix C - Full network modelling results

List of Figures

Figure number and title	Page
Figure 2.1: Sections of a telecommunications network	6
Figure 2.2: Analog and digital telecommunications network	8
Figure 2.3: 1:1 and 1:N protection	12
Figure 2.4: Manual rerouting of traffic around a failed facility	13
Figure 2.5: Digital cross connect system	15
Figure 2.6: Fast facility protection	16
Figure 2.7: Fibre Distributed Data Interface	18
Figure 2.8: Shared protection ring	19
Figure 2.9: Method of routing under study	30
Figure 3.1: Sample network	33
Figure 3.2: Neural network and its relation to the sample network	35
Figure 3.3: Comparison of sample network to a geographic area of equivalent scale	41
Figure 3.4: Neural network with 16 input neurons, 6 output neurons, and 2 hidden layers of 6 neurons each	45
Figure 3.5: Neural network with 16 input neurons, 6 output neurons, and 2 hidden layers of 8 neurons each	45
Figure 3.6: Neural network with 16 input neurons, 6 output neurons, and 2 hidden layers of 10 neurons each	45
Figure 3.7: Flowchart for the V1 Macro	48
Figure 3.8: MSE Values as a function of number of training cycles for network V1.2.06.4	49
Figure 3.9: MSE values for networks with two output neurons using the V1 Macro	50
Figure 3.10: MSE values for networks with four output neurons using the V1 Macro	50
Figure 3.11: MSE values for networks with six output neurons using the V1 Macro	50
Figure 3.12: MSE values for networks with six neurons per hidden layer using the V1 Macro	51
Figure 3.13: MSE values for networks with eight neurons per hidden layer using the V1 Macro	51
Figure 3.14: MSE values for networks with ten neurons per hidden layer using the V1 Macro	51

Figure 3.15: Comparison of MSE Values for V1 and Special Macros	53
Figure 3.16: Flowchart of the V2 Macro	54
Figure 4.1: Winner-take-all circuit	85
Figure 4.2: Final neural network topology	86
Figure 4.3: Routes from Node 6 to Node 13 through available7 adjacent links	87
Figure 4.4: Unsuccessful selection of optimal route from Node 11 to Node 14	90
Figure 4.5: Alternate routes determined as a function of unavailable link (Routing from Node 16 to Node 3)	94
Figure 4.6: Alternate routes determined as a function of unavailable link (Routing from Node 3 to Node 16)	95
Figure 4.7: Alternate routes around unavailable links for each unavailable link	97
Figure 4.8: Alternate routing around unavailable node to destination node	99
Figure 4.9: Alternate routing around an unavailable node	100
Figure 4.10: Attempt to determine alternate routing for an unavailable destination node	101
Figure 4.11: Generalized routing examples	104

List of Tables

Table number and title	Page
Table 3.1: Valence values for the sample network	34
Table 3.2: Length values for each link in the sample network	40
Table 3.3: Scaled node and link weights and final network lengths	42
Table 3.4: Pattern file for Node 2 of the sample network	44
Table 3.5: Neural network topologies used in the initial testing	46
Table 3.6: V1 Macro minimum MSE results and number of training cycles	52
Table 3.7: Comparison of MSE results for the V1, V2, and V3 Macros	56
Table 3.8: Training results for V1.2.06.4 (Network 2.06.4, V1 Macro)	58
Table 3.9: Comparison #1: Average/standard deviation measurements and distribution counts	62
Table 3.10: Comparison #2: Average/standard deviation measurements and distribution counts	63
Table 3.11: Comparison #3: Direct comparison of difference values	65
Table 3.12: Comparison #4: Direct comparison of difference values	66
Table 3.13: Comparison of target rankings to trained rankings of 2 output neuron networks using the V2 Macro	69
Table 3.14: Comparison of target rankings to trained rankings of 4 output neuron networks using the V2 Macro	70
Table 3.15: Comparison of target rankings to trained rankings of 6 output neuron networks using the V2 Macro	71
Table 3.16: Comparison of routing performance versus number of neurons per hidden layer	72
Table 3.17: Quantized output values for different values of n	74
Table 3.18: Comparison of MSE results for networks using original and modified training sets	75
Table 3.19: Neural Network Model Test Results: Average/standard deviation measurements and distribution counts Comparison of V2 trained networks using real and modified training sets	76
Table 3.20: V2 Macro 2 output neuron routing comparison - real vs. modified training set	78
Table 3.21: V2 Macro 4 output neuron routing comparison - real vs. modified training set	78

Table 3.22:	V2 Macro 6 output neuron routing comparison - real vs. modified training set	79
Table 4.1:	Routing results for node 12 of the sample network	82
Table 4.2:	Comparison of routing performance for Sample Network for entire network and different valence values	83
Table 4.3:	Test #1: Route selection from Node 13 to Nodes 6 and 14	107
Table 4.4:	Test #2: Route selection from Node 5 to Nodes 13 and 14	107
Table 4.5:	Test #3: Route selection from Node 8 to Nodes 6 and 12	107
Table 4.6:	Test #4: Route selection from Node 16 to Nodes 4 and 6	108
Table 4.7:	Test #5: Route selection from Node 4 to Nodes 10,12 and 16	108
Table 4.8:	Test #6: Route selection from Node 3 to Nodes 9, 14 and 15	108

Chapter 1

Introduction

1.1 Purpose

The purpose of this thesis is to research the application of neural networks to a specific issue in the field of telecommunications. The issue being considered is the problem of performing efficient shortest path routing decisions within a telecommunications network under normal and abnormal conditions.

The study of neural networks has been a steadily increasing area of interest over the past 5 years, where the application of neural networks to different scientific and engineering disciplines has produced alternative methods to solving classic problems [1]. Neural networks have been applied to areas of optimization, control, associative memories, and pattern recognition [2], areas that can be applied to routing in telecommunications networks. By studying the concept of routing both from the specific field of telecommunications and the more general field of routing theory, this thesis will map routing concepts into the neural network paradigm, define a neural network solution, and demonstrate through modelling the ability of a neural network to perform telecommunications network routing.

1.2 Problem

The operation of the telecommunications network depends on the efficient use of the components in the network, and network routing is a key factor in determining this efficiency. Improper network routing results in poor network utilization, which in turn affects the services that the network can provide.

As telecommunications networks evolve, the importance of routing in these

networks is increasing. This increased importance is due to a number of factors: telecommunications companies are under pressure to become more efficient, requiring maximum utilization of network components; the increased dependence of the public and corporations on these networks requires higher levels of network reliability and availability; and the introduction of new technology has made the network more complex. Routing methods must evolve to maximize network utilization under normal conditions, plus adapt to problems in the network so that the effects of any abnormal network condition is minimized to provide maximum reliability and availability.

A neural network router can be created that can meet these requirements. While new telecommunications routing methods are being researched, only a small portion of this work involves neural networks. Conventional approaches are superior to the older, manual routing methods, but still have disadvantages in terms of speed and flexibility. By utilizing the adaptive properties of neural networks, an advanced method of network routing could be created without the disadvantages of conventional routing methods.

1.3 Scope

This thesis is composed of six chapters. In Chapter 2, an overview of relevant information to this thesis is provided, and begins with an introduction to and description of telecommunications networks. After this general discussion the issue of network routing and reliability will be introduced. This is followed by a discussion of current and proposed routing methods within telecommunications networks, and a brief discussion of routing theory. The chapter concludes with a discussion on the application of neural networks in telecommunications, and a description of the specific routing approach to be studied. In Chapter 3, the modelling of a single node within a defined sample network will be presented, with the objective of optimizing the topology, learning, and neural network training set to perform the network routing task. The results of Chapter 3 will be applied in Chapter 4, where the routing for the full sample network will be modelled, the results discussed, and the

performance of the neural networks evaluated for different routing conditions. Chapter 5 contains conclusions on the research and recommendations on areas for further investigation. The thesis concludes with a list of references used in this research, and appendices containing related material.

Chapter 2

Overview

This chapter will provide an overview of topics of interest in this thesis. The chapter will first review of the operation of telecommunications networks, then discuss the nature and current methods of routing within these networks. A review of methods and research in the area of routing theory is then provided, and this is followed by a discussion of current applications of neural networks to telecommunications routing. The desired attributes for a neural network router are then outlined, and the method of routing studied in the remainder of the thesis is discussed.

2.1 The telecommunications network

The telecommunications network provides services that most people take for granted. To the majority of people, telecommunications is represented by the telephone, and the process of inputting a series of numbers into the telephone that then connects the calling person to another telephone. But between these telephones is a massive investment by utilities and corporations in a complex telecommunications network. This network provides not only the basic connection service familiar to the public, but also specialized services to corporations that rely on the network for providing service to their customers. These specialized services are becoming more important as telecommunications networks evolve, and are projected to become an important factor in the future competitiveness of many companies and countries.

As stated above, the telecommunications network is a complex system. Providers of telecommunications services - typically the phone company - must plan, install, and maintain these networks. Underlying these network activities is the requirement to provide a high level of service to its users. In some areas of telecommunications a monopoly exists, and a single network

provider is regulated by a government to provide service at a price that allows for reasonable rates of return on the provider's investment. In other areas telecommunications services are deregulated, and multiple service providers compete in the marketplace to provide services based on the cost of the network and the variety of services. In Canada, an example of a service monopoly is long distance telephone service, and an example of a deregulated service is cellular phone service. The global trend in telecommunications is toward deregulation; as will be discussed later, this results in the need for increased efficiency, reliability, and functionality within the network, and the need to find new methods of controlling and managing this network.

2.1.1 Telecommunications network structure

The basic telecommunications network shown in Figure 2.1 is composed of three major sections, with each section performing a specific network function. The first section is called the access section; this section connects the equipment of a telephone user - known as *customer premise equipment* - to the telephone switching center or *central office*. The customer premise equipment is connected by a dedicated set of wires or *access lines* to the central office. This configuration is the most simple example of the access portion of the network, but there are other configurations. One example is where a switching element similar in function to a central office is placed between a central office and the customer premise equipment. In one example, a switching element is located at the business site, and is called a *private branch exchange*, or PBX. A second example is where a smaller switching center, called a *remote*, is placed to service a portion of a central office's serving area. The purpose of both the PBX and the remote is to concentrate a large number of access lines into a smaller number of *transport facilities*; this will be described in the following paragraphs.

The second section of a telecommunications network is the switching section, where a central office concentrates the access lines of a specific geographic area and connects these lines to access lines in its own area or to transport facilities between it and central offices in other areas. To provide full

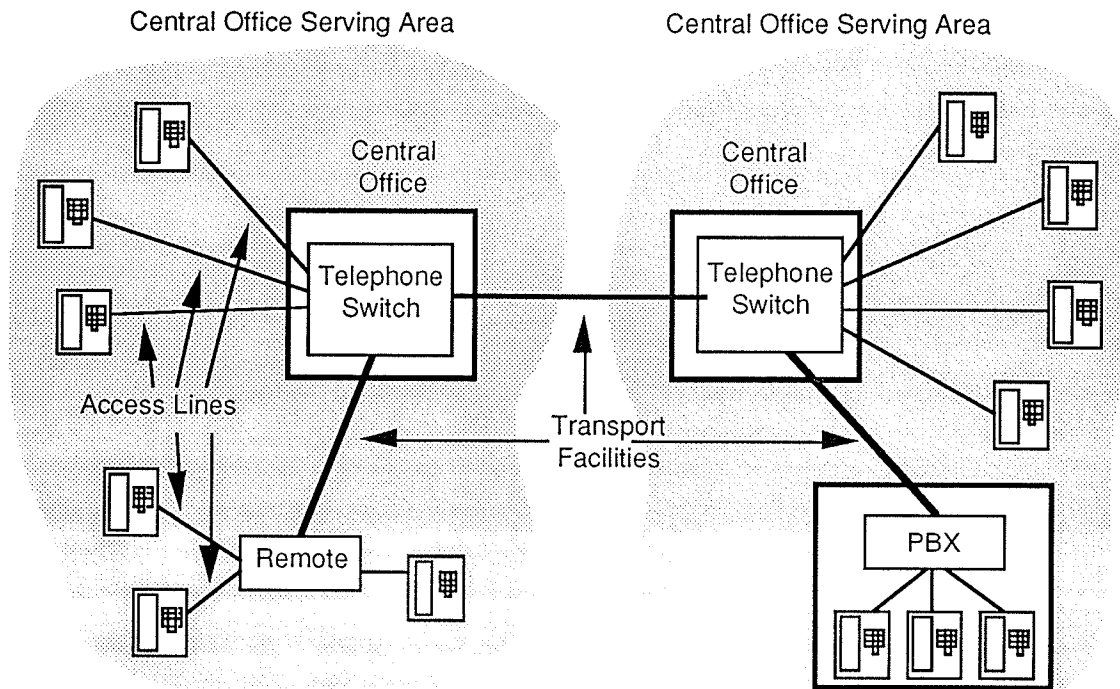

Figure 2.1:
Sections of a Telecommunications Network

interconnection between the hundreds of millions of telephones in the telecommunications network is not possible; instead the network relies on the fact that only a small portion of the telephones in the network are in use at a given time to reduce the number of connections required. The main component of the central office is the *telephone switch*, which is connected to all access lines in its geographic area and then selectively connects the lines in use to the access line of a telephone that is being called. In the case where the called telephone is within the same geographic area as the calling telephone, the telephone switch will connect them within the central office. If, however, the called telephone is in a geographic area served by another telephone switch, then some form of link is required between these switches. This link is called a *transport facility*, and is part of the set of dedicated interoffice links that forms the transport portion of the network. Depending on the location of the destination telephone switch, a series of telephone switches and transport facilities may be required to provide the end-to-end connection. The location of the called telephone and telephone switch is determined from the telephone number, which can be considered to be a

network address.

The final section of the network is the transport section. As stated above, transport facilities are dedicated links between central offices, and like the facilities in the access section of the network, the links are not all in use at one time. The amount of activity on a specific transport facility is a function of the network traffic between the central offices, and a properly planned transport facility will have the available capacity to handle the heaviest traffic requirements under the busiest, or peak, conditions. When the traffic between two offices reaches the level where the transport facility is at full capacity, no further connections can be provided over that link.

Advances in technology have produced dramatic changes in telecommunications networks. One of the most dramatic revolutions has been the migration of the network from analog to digital systems. In the analog network shown in Figure 2.2(a), the access, switching, and transport sections were analog based; an analog signal originated from the telephone, connected with a physical connection at the calling telephone switch to an analog transport facility, and connected through a physical connection at the destination telephone switch to the called telephone. With the evolution to digital technology shown in Figure 2.2(b), only the access section of the network remains analog; at the digital switch, the analog signal is digitized, and the digital signal is now digitally switched and carried over digital transport facilities to a destination digital switch where it is converted to analog for connection to the called telephone. The benefits of the digital network are significant: noise has been reduced, improved reliability has been achieved, and the performance and capacity of the network has been increased. One of the major benefits of digitization of the transport facilities is the use of time division multiplexing to combine multiple low speed signals from the access network onto a single high speed transport facility. While an analog transport facility consisted of thousands of wire pairs with each pair representing a single transport circuit, a single digital transport facility can now carry thousands of time multiplexed channels, with each channel representing a transport circuit. The introduction of fibre optics transmission technology in the telecommunications network has provided the most

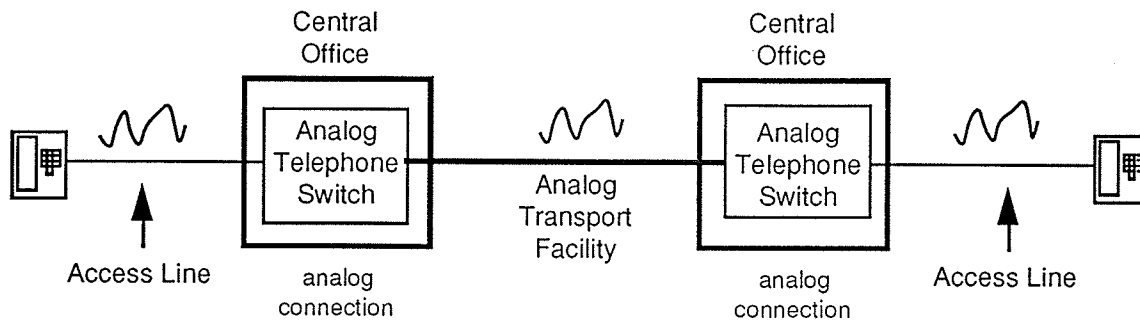

Figure 2.2(a):
Analog Telecommunications Network

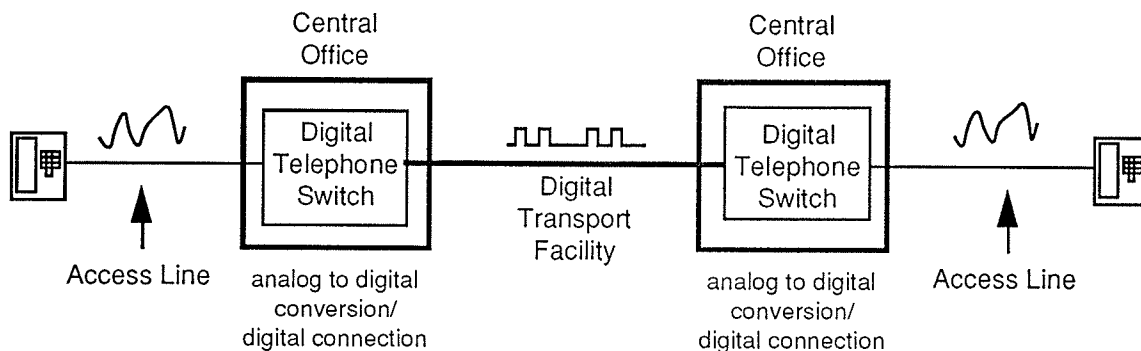

Figure 2.2(b):
Digital Telecommunications Network

significant increases in capacity, with new systems now providing over 30 000 voice channels, or a combination of voice, data, and video signals, on one fibre optic pair.

2.1.2 Routing and network reliability

To obtain maximum efficiency from a telecommunications network, digital signals representing voice, data, or video signals must be routed between the originating and destination points in the network quickly and reliably.

Routing activity occurs at several points between the originating and destination locations. First, the telephone switch translates the telephone number into routing information, and the connection is routed through the switch to another access line or a transport facility. If the destination is within the switch's serving area, the routing is performed within that switch.

If the destination is in another central office, then a destination telephone switch will route the call from the transport facility that connects it to the originating central office to the access line of the destination telephone. As the distance between originating and destination central offices increases, more transport facilities and telephone switches may be required to provide the end-to-end connection, with each switch performing similar routing functions. Under normal traffic conditions the network performs this activity with a high level of reliability. If, however, an abnormal condition occurs, then the network attempts to compensate for the condition, and depending on the type of condition, different compensation methods can be used. If a transport facility reaches capacity, the telephone switch can redirect traffic to other transport facilities along other routes that have not reached capacity. But if a transport facility becomes unavailable as a result of failure, the transport network must attempt to restore the lost capacity by using spare capacity in the network. The ability of the network to route traffic under normal and abnormal conditions is a fundamental requirement.

One of the most important issues in the telecommunications network is network reliability. Some of the reasons are:

- Network providers are under increasing pressure to provide new services. These new services increasingly rely on information stored in the local and remote computer systems of network providers, resulting in increased network communication.
- Some new services are data applications. These applications require higher bandwidths and lower bit error rates than regular voice transmission.
- Digital technology has allowed for increased capacity within the network; as a result, more services and users are affected when a network problem occurs.
- While the amount of required maintenance and been reduced and the overall availability of network equipment has been improved, the problems that now occur in the networks are becoming increasingly more complex.
- Network failures can be caused by a variety of factors, including human error, natural disasters, terrorism, and the complexity of

modern equipment used in the digital network.

- The reliance of the users on services and the introduction of service competition has resulted in the need for increased reliability and availability in the network.
- Though rare, major network failures can affect thousands of users and disrupt activities over a large area. In one recent event, a telephone switch in New York City failed; tens of thousands of users lost basic communications, financial operations were affected and air traffic control was disrupted in regional airports [3]. In the worst case, the financial cost can be significant; a fire in a central office in Chicago disrupted operations at O'Hare airport and resulted in service outages of up to a month for some residential and business customers; the estimates of the cost of lost business range from the hundreds of millions to billions of dollars [4].

To mitigate the effect of future failures, network providers are deploying systems that provide improved network routing, restoration and survivability. Depending on the section of the network (access, switching, or transport) different systems or methods are available. Of the three sections of the network, this thesis will focus on the routing and restoration in the transport section. The reasons are:

- Transport failures are a frequent type of abnormal network condition.
- Transport failures affect more users across a larger geographic area.
- Since transport facilities are outside the controlled environment of central offices, they are more susceptible to failure from a number of areas.
- The topology of the transport network lends itself to a number of possible restoration solutions.
- The various restoration solutions all involve static or dynamic routing methods.
- If a routing method can be defined that can be mapped into a neural network structure, then a solution may be possible.

2.1.3 Transport network protection and restoration

The areas of network protection and restoration have been extensively researched in telecommunications; a complete review of network protection and restoration methods is not required for this thesis. Instead, this section will provide a brief overview of existing and new methods.

2 1.3.1 Protection channels and manual restoration

The most widespread method of providing restoration of failed facilities is by the use of *protection channels*. A protection channel is a redundant or spare facility with the same capacity as the regular working facility it protects. Figure 2.3(a) shows a working and protection channel in normal operation, with the traffic being carried on the working channel. When a problem occurs with the working facility, the problem is detected and the traffic is switched by protection equipment to the protection channel, as shown in Figure 2.3(b). The method of protection where one working channel is protected by one protection channel is called 1:1 protection. A more general form of this protection is called 1:N protection, where one protection channel provides a redundant facility for N working channels; if any one of the N working channels fails, the traffic can be restored on the protection channel. Figures 2.3(c) and 2.3(d) depict the normal and restoration activities for a 1:N system.

This form of restoration is well suited to facility failures that affect only one working channel of a transport facility; an example of this type of failure is where a portion of the transport equipment associated with one channel fails. Where this form of protection fails to perform is in instances where a failure affects an entire transport facility such as a failure of transport equipment common to all channels or the loss of the transmission medium such as the cutting of a fibre optic cable or loss of a microwave relay tower. In these cases, 1:1 and 1:N protection methods cannot provide restoration, and restoration is performed by manually reconnecting the traffic from the failed facility onto the protection channels of one or more alternate transport facilities, restoring the traffic to the opposite end of the failed facility. This

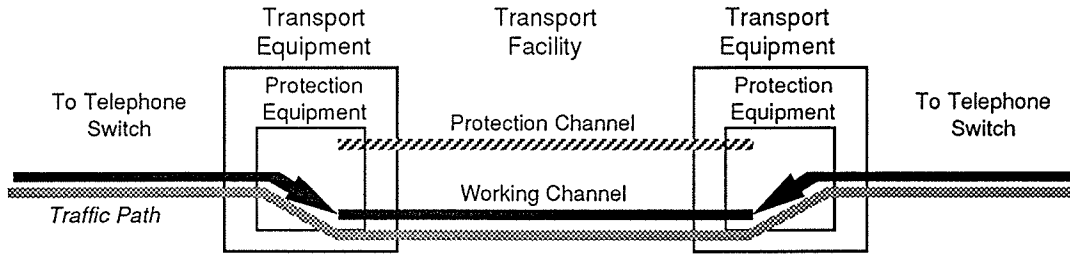

Figure 2.3(a): 1:1 Protection - Normal Condition

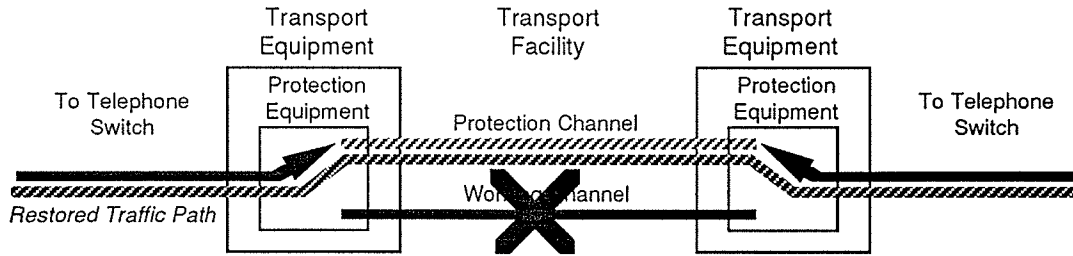

Figure 2.3(b): 1:1 Protection - Protection Condition

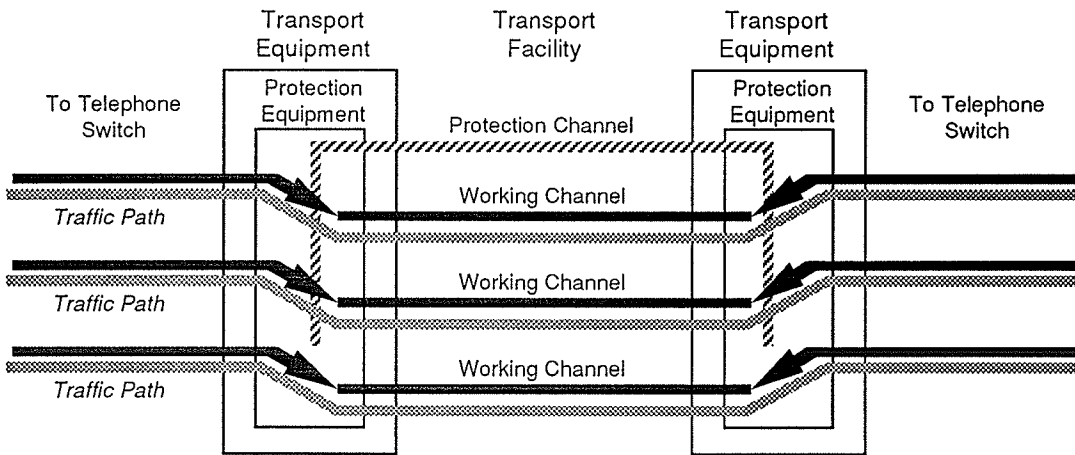

Figure 2.3(c): 1:N Protection - Normal Condition

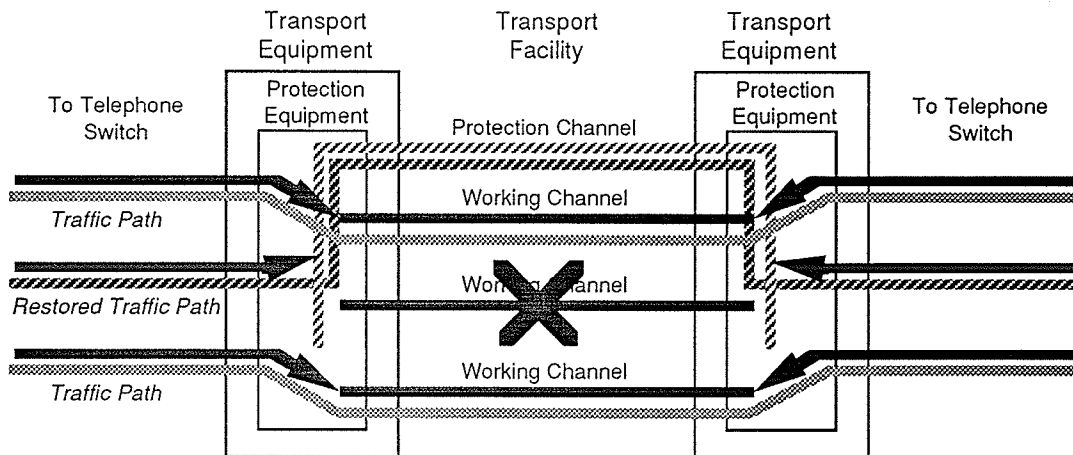

Figure 2.3(d): 1:N Protection - Protection Condition

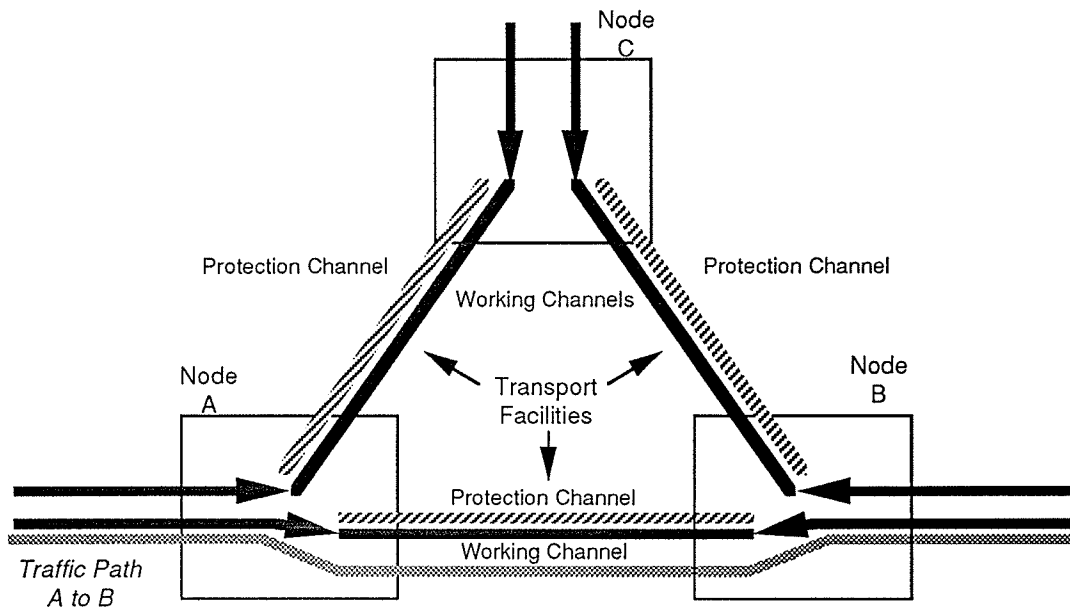

Figure 2.4(a):
Normal traffic conditions

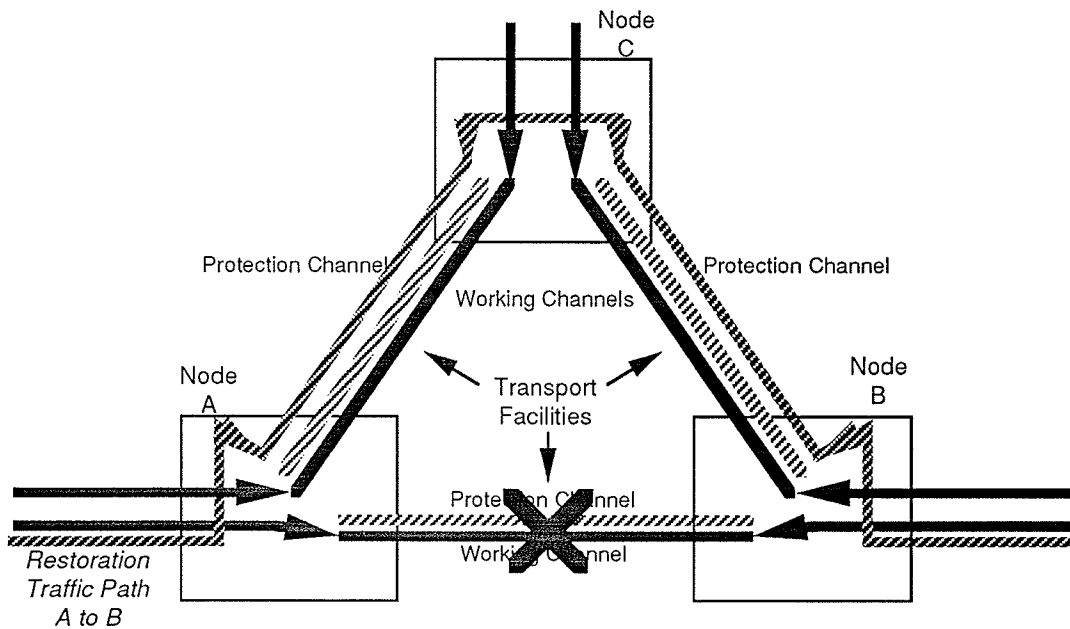

Figure 2.4(b):
Manual rerouting of a failed facility to an alternate traffic path

process of manual rerouting is a time consuming process, and can result in the loss of service for significant periods of time; as a result, methods of providing faster restoration around a failed facility were needed. The process of manual rerouting of a failed facility is shown in Figure 2.4(a) and (b).

2.1.3.2 Digital Cross Connect Systems

The introduction of *digital cross connect systems* (or DCS) has been a significant development in the management of transport facilities. The DCS replaces the manual cross connect equipment in central offices, and provides remote and automatic control of the connections of digital facilities. The network provider operations staff can issue commands to a DCS to perform connections of different transport facilities, and in the case of the failure of a transport facility the operations staff can use a DCS to quickly perform the reconnections required to restore service. The placement and use of a DCS for restoration are shown in Figure 2.5.

The use of a DCS can reduce the time of restoration to minutes, but this still results in loss of traffic connections and service. To reach the goal of providing restoration without the loss of most traffic connections, the time to restore facilities must be in the 1-2 second range. The introduction of special features in the DCS is now making this level of restoration possible. Using a feature called Fast Facility Protection (FFP) [5], the protection channels for 1:1 protection systems can be routed over a different route to the destination. The traffic being carried is bridged onto both the working and protection channels by the DCS at one end of the facility, and at the other end the presence and signal quality of the traffic is monitored. If there is a loss of traffic (resulting from the loss of the entire facility), or if the signal quality is degraded, then the DCS at the other end switches to the protection channel. This feature is now available and is being considered for use by some network providers. An example of FFP is shown in Figure 2.6.

2.1.3.3 Survivable Ring Architectures

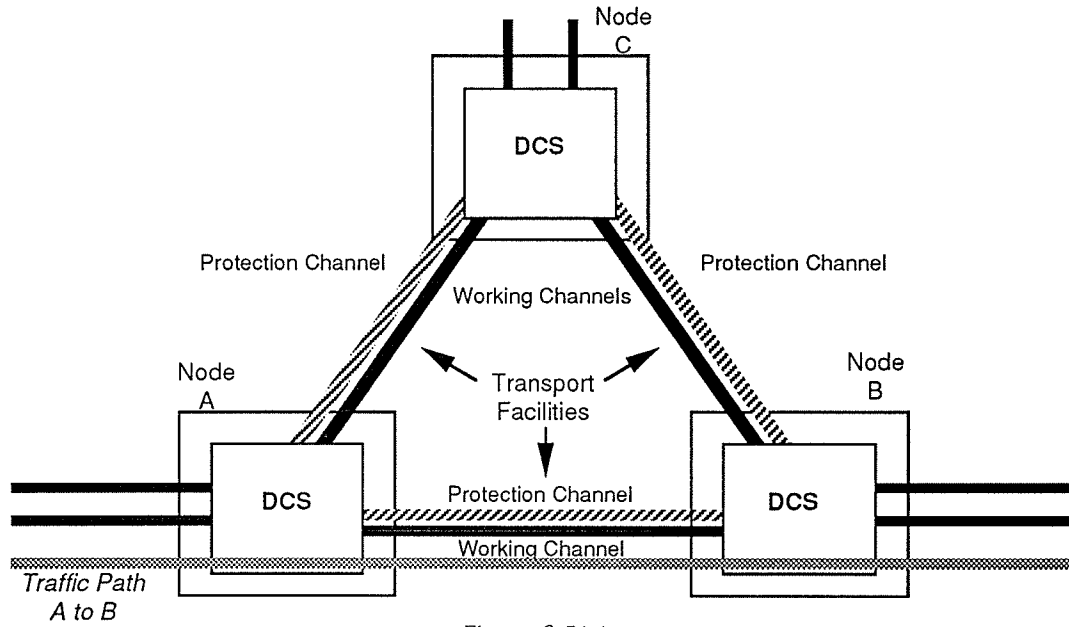
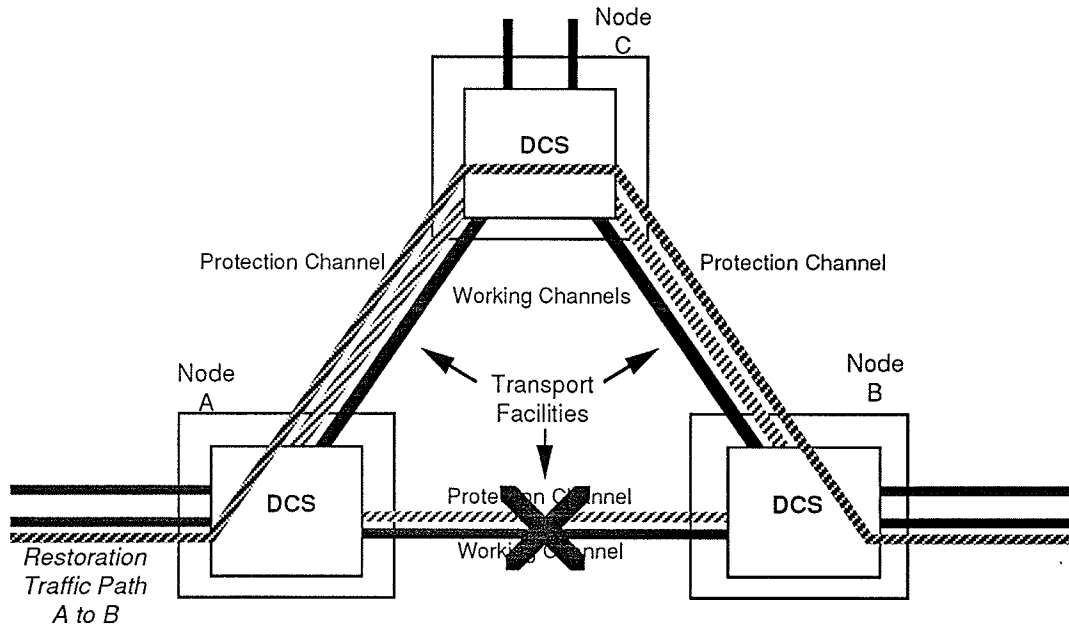

Figure 2.5(a):
Normal traffic condition with digital cross connects



Automatic or operator initiated cross connections
performed at nodes A,B, and C

Figure 2.5(b):
Digital cross connect rerouting of traffic around a failed facility

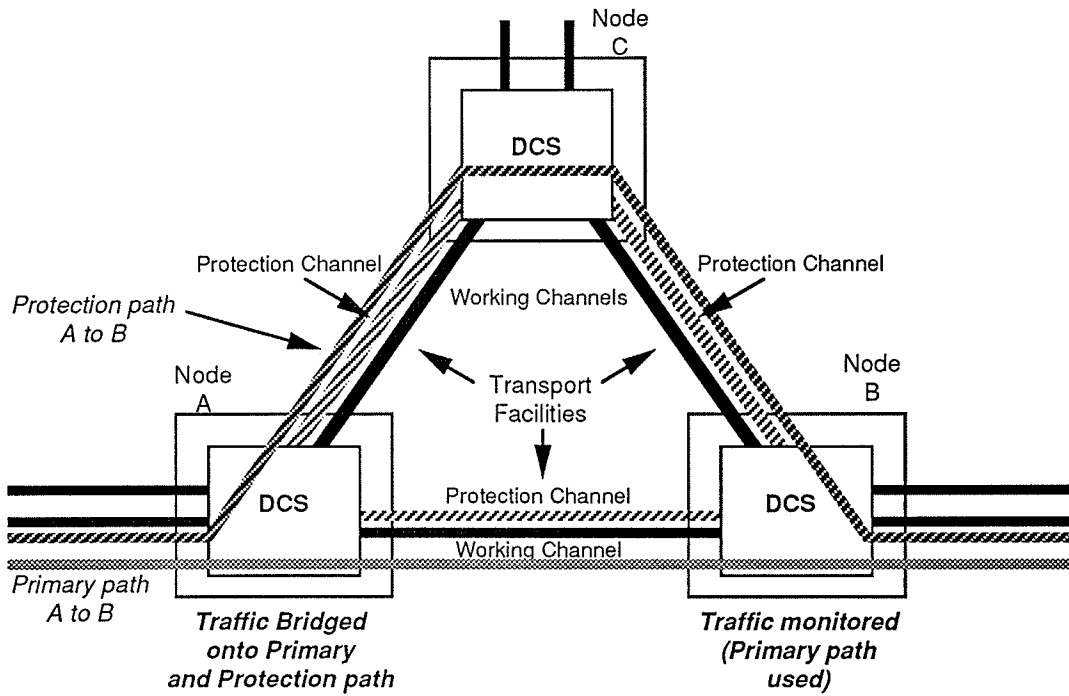

Figure 2.6(a):
Normal traffic condition with Fast Facility Protection

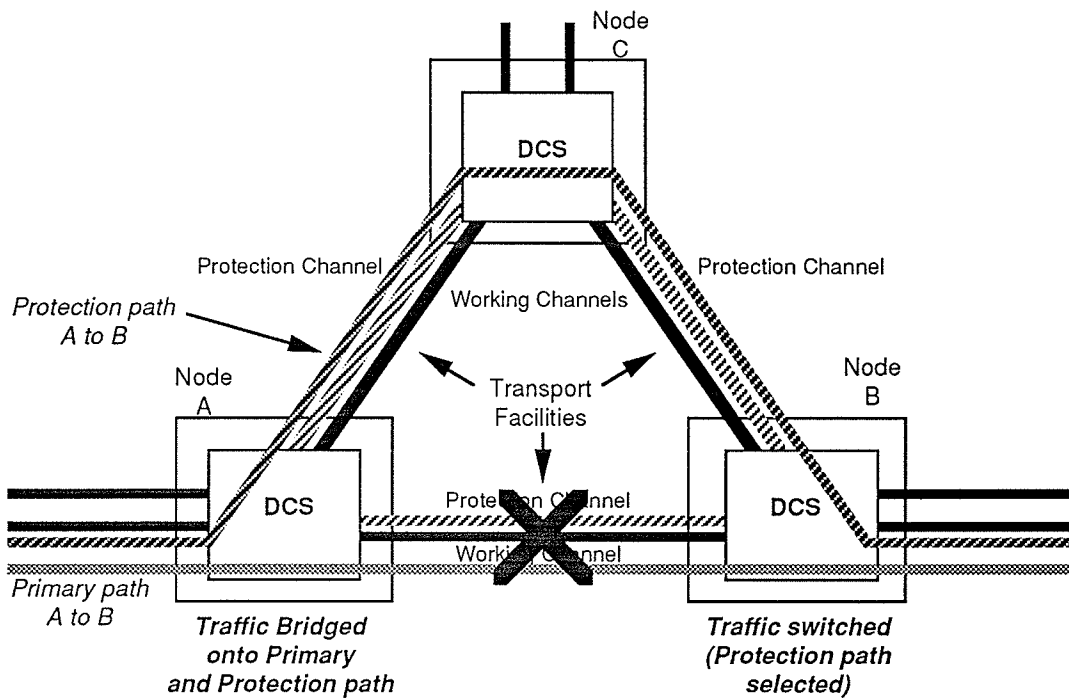

Figure 2.6(b):
Selection of alternate traffic path using Fast Facility Protection

Another method of providing restoration is by implementing ring architectures in transport networks. By arranging the transport links between a number of separate locations into a ring, simple redundancy methods can be implemented. Current examples of this type of architecture are available from both the computer and telecommunications network areas.

For computer networks, the Fibre Distributed Data Interchange (FDDI) standard describes a 100 million bits per second fibre optic data network. To build survivability into the FDDI network, working and protection network traffic circulates around a fibre optic ring connecting all nodes, with the working and protection channels being transmitted in opposite directions around the ring. If any site on the loop experiences a failure, or the facility fails between two nodes, protection circuitry at the nodes detect the failure and redirect working traffic onto the protection channel, creating a single traffic loop connecting all nodes and isolating the failure. FDDI restoration is presented in Figure 2.7.

In telecommunications networks, one example of restoration using the ring architecture is provided by the Shared Protection Ring (SPRING) [6]. Like FDDI the SPRING has two traffic channels transmitting in opposite directions, but in the case of SPRING the working and protection capacity is split between the two rings, resulting in one half of the working traffic being transmitted in the opposite direction to the other half. If a facility failure occurs, the working capacity carried on the failed facility is redirected into the protection capacity of the working facility, isolating the failed facility and maintaining traffic connections. SPRING restoration is presented in Figure 2.8.

2.1.3.4 Dynamic restoration methods and self healing

Restoration provided by methods such as FFP and ring architectures can provide rapid restoration from failures on the order of 50 milliseconds. This short restoration time will maintain traffic and service connections in the network, but there are drawbacks to these methods. Bandwidth must be dedicated to the restoration of specific facilities, resulting in the need to

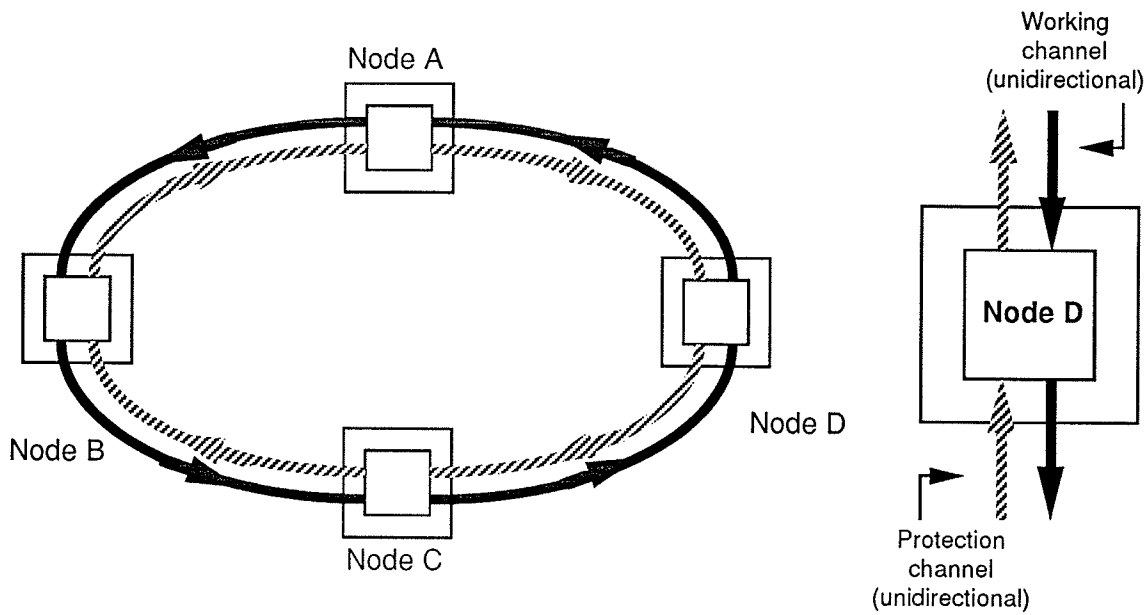

Figure 2.7(a):
Normal traffic on FDDI ring

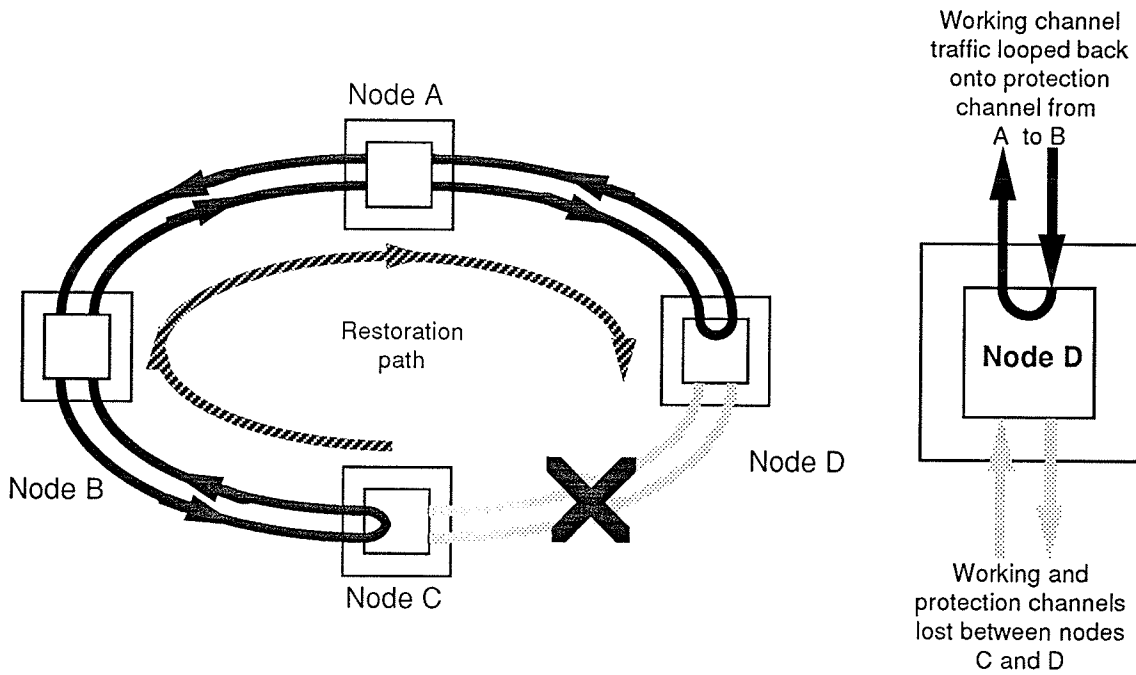

Figure 2.7(b):
Restoration of traffic on FDDI ring after loss of facilities between Nodes C and D

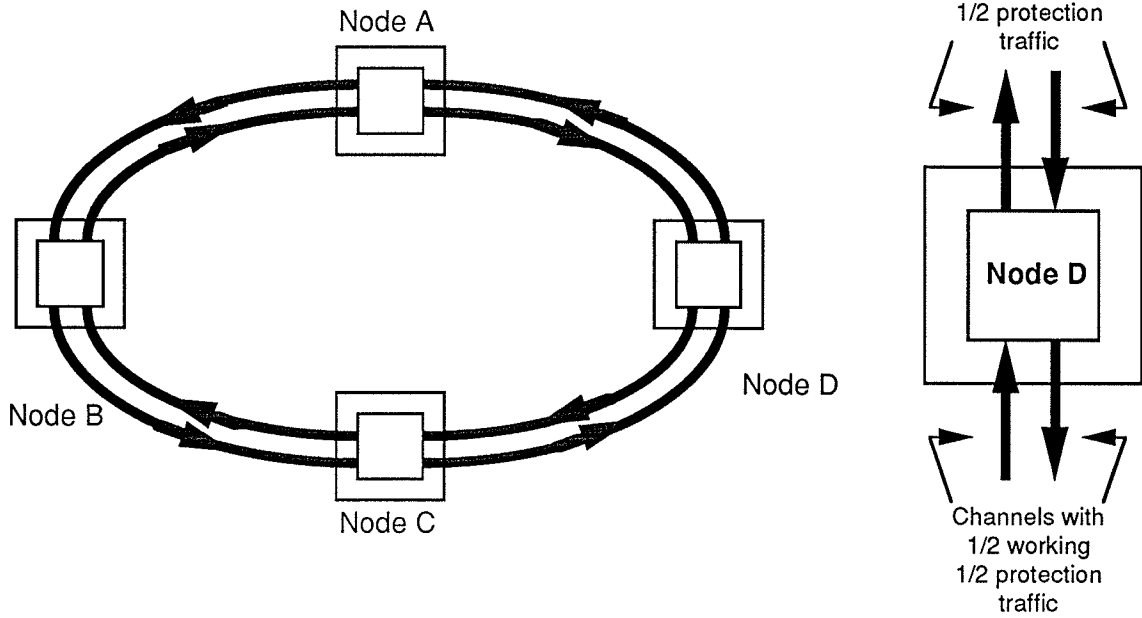

Figure 2.8(a):
Normal traffic on SPRING

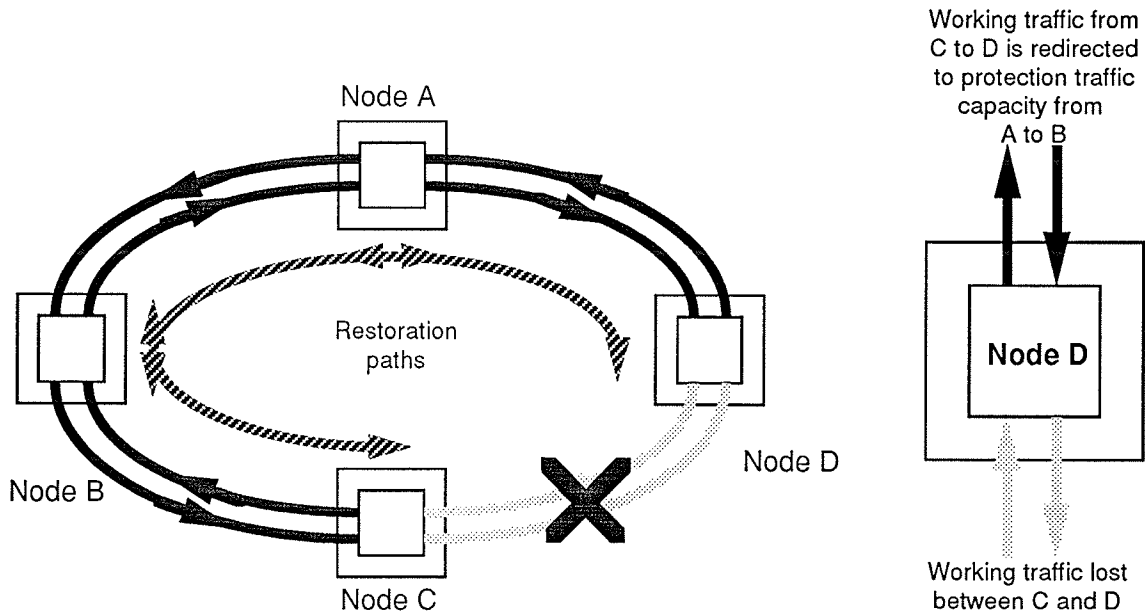

Figure 2.8(b):
Restoration of traffic on SPRING after loss of facilities between Nodes C and D

provision large amounts of channel capacity just for restoration and imposing added design rules on the network. In addition, these methods are based on static conditions in the transport network, and cannot adapt to multiple network changes should they occur. In order to provide flexibility and to reduce the need to provide large amounts of restoration capacity, several adaptive and dynamic restoration techniques have been proposed.

Dynamic restoration or *self-healing* techniques rely on the use of a restoration protocol implemented in transport network DCSs. When the failure of a transport facility occurs, a designated DCS sends restoration messages to adjacent DCSs over connecting facilities with available capacity. The process is repeated by these adjacent DCSs resulting in a "message wave" that floods the network. The target of this message wave - and the signature information contained in it - is the DCS at the other end of the failed facility; when the messages are received, the signatures are processed, and the alternate restoration routes and their capacities are determined. To complete the process, a return message is issued along the alternate routes to establish the restoration link(s) required to restore all traffic. This self-healing process has been suggested by Yang and Hasegawa [7] and Grover et al [8]: in the former case the authors based their approach on the implementation of specific types of equipment in the transport network; in the latter case, a more generalized form and more well defined protocol has been created. For both these methods, the restoration time has been estimated in the 1.5-2 second range.

2.2 Routing Theory

Routing has been researched extensively from a theoretical perspective to determine efficient algorithms; for the purposes of this thesis, the study was focussed on the area of shortest path (SP) problems. SP problems are encountered in many areas of research apart from communications, and are a subset of a larger class of problems that include longest path problems, most reliable path problems, and largest capacity path problems. Several good

sources classify the types of SP algorithms available. Deo and Pang [9] classified different algorithms based on a number of factors with the goal of identifying suitable candidates for parallel implementation and computation; the majority of the material for this section was obtained (unless otherwise noted) from this source.

As stated above, SP algorithms are dependent on a number of problem factors. One of these factors is the characteristics of the network. Some of the network characteristics that must be considered are:

- Are the nodes in the network densely or sparsely connected?
- Are the arcs of the network directed (have one direction) or undirected?
- Are the lengths of the arcs positive values or any real value?
- Are the lengths of the arcs based on uniform (unit) distance, euclidean distance, or a more generalized real valued function?
- Are the lengths of the arcs deterministic (fixed) or probabilistic?

In comparing these characteristics to a telecommunications network, we find the transport network can be generally represented as a sparsely connected, undirected graph with positive arc values based on a deterministic function related to euclidean distance. While the pure euclidean distance can be used, several factors can be combined to determine the cost function for a transport facility such as cost of use, type of equipment, and network delay factors.

The type of solution required is another factor in determining the desired SP algorithm. The solution will be governed by a number of characteristics, including:

- Are there any constraints on the selection of the path (i.e. the path must have a certain number of arcs, or pass through a specific node) or is the solution unconstrained?
- Must the solution provide the shortest path only or define the 2nd, 3rd...K-th shortest paths?
- Will the solution determine the path between two specific nodes, between one node and all other nodes in the network, or the shortest paths between all nodes?

In transport networks the paths for restoration routing are typically unconstrained, but the other characteristics are not as clearly defined, allowing for a number of possible routing methods. If the transport network has sufficient capacity in its protection channels to accommodate any single facility failure, then a shortest path algorithm would be adequate; what is more likely, however, is that protection channels in the network have different capacities, and that a K-th shortest path algorithm is required. K-th shortest path algorithms were used in the self healing systems discussed previously, where several low capacity alternate routes can be used to reroute the traffic of a single failed high capacity facility.

In most cases the primary requirement for restoration is to provide an alternate route for traffic to the node at the other end of the failed facility, and an algorithm that determines a path between two specific nodes can be implemented. However, since any given network node can have a number of transport facilities, and since we would like to design a routing system that can tolerate the loss of network nodes, an algorithm that can provide a path from a specific node to all other nodes in the network is desirable.

The last major factor that classifies SP algorithms is the technique used to determine the shortest path. Each algorithm can be described by its use of preprocessing and the method used to determine the solution. The majority of these SP techniques involve path finding through general purpose computer simulations, and can be further broken into combinatorial and algebraic techniques.

2.2.1 Combinatorial techniques

Combinatorial techniques involve traversing the arcs of a graph and recording information obtained in the process; this method is also called the *graph traversal technique*. Information recorded while traversing the graph is contained in labels that are associated with the nodes and arcs of the graph; all labels are temporary when the technique begins, and all are

assigned permanent or fixed labels when the process is complete. The method that the labels are assigned and modified further classifies the labelling technique. Most research in the area of labelling methods aim to optimize the basic procedure by a number of methods.

In methods where permanent labels are assigned while the algorithm is being performed are called *label setting techniques*. This technique was first described by Dijkstra [10], as a method of determining the shortest path between two given nodes P and Q in a graph containing N nodes. The method starts at Node P, and the label for Node P is made permanent. Starting at P, all the arcs connecting P to its adjacent nodes are identified and the nodes assigned temporary labels; the label is proportional to the distance from that node to Node P. All of the temporary labels are then examined, and the node with the smallest temporary label is then made permanent. The process is then repeated, with all the nodes connected to the nodes with permanent labels now assigned temporary labels. At each iteration, all nodes connected to permanently labelled nodes are searched and the paths that produce the smallest temporary labels are retained, and the node with the smallest temporary label is then made permanent. In this manner the process continues, adding one node at a time until Node Q is reached; the maximum number of cycles required to perform this technique is N-1. When complete, the labels defined by the technique identify the shortest distance to Node P and the sequence of nodes that define the path, and if allowed to run for N-1 iterations the shortest paths to all nodes are determined. Many implementations of label setting algorithms are available using different data structures in an attempt to optimize the traversing process, resulting in several fast search techniques. The Dijkstra algorithm has also been implemented in a neural network by Fahner [11] as a method of providing planning for real-time robotic motion.

If the labelling technique keeps all labels as temporary labels until all calculations are completed, it is called a *label correcting technique*. One proposed implementation of a label correcting technique in communications is the use of the Bellman-Ford algorithm as discussed by Ephremides and Verdu [12]. The authors assert that a distributed implementation of the Bellman-Ford

algorithm is well suited to communications networks, for messages between the nodes are processed to determine the labels for each link. By using this method the nodes in the network can have their information updated asynchronously, no network coordination is required, and the nodes rely only on receiving information from adjacent nodes. If the communications between the nodes is continuous, then each node maintains an accurate knowledge of the shortest path to any node in the network.

2.2.2 Algebraic techniques

Algebraic techniques are methods that involve the manipulations of matrices or the use of linear equations to produce a solution. An example of a matrix solution is an all pairs routing method similar to calculating the power of a matrix. Examples of linear equation methods are the organization of the network information as an algebraic system and then solving a set of simultaneous equations. For the purposes of this thesis, these methods are not being considered.

2.3 Neural networks and telecommunications routing

As stated earlier, neural networks are being applied to current problems and issues in many different fields, and telecommunications is no exception. A search of neural network and telecommunications literature has identified numerous references where neural networks are being applied to this field; the majority of this research has occurred in the last five years with the increased interest in and availability of neural network research tools. Most of the research performed involves some form of routing decision, but the specific applications, conditions, and routing methods vary. Brown [13] and Melsa et al [14] investigate the use of neural networks to perform routing within digital telephone switches, where the priority is performing the maximum number of input/output connections. Other applications include Hiramatsu [15,16], Chugo et al [17] and Frisiani et al [18] where routing decisions for data networks are made based on the traffic levels within

transport facilities, network delay times and messages between nodes. Lastly, some of the research made specific reference to performing routing decisions in the transport network under normal or failure conditions; this research will be further discussed in the following paragraphs.

One of the routing methods reviewed was proposed by Rauch and Winarske [19]. In this method an all pairs solution to routing of an N node telecommunications network is produced. For a given network, an $N \times N$ capacity matrix defines the link connections between nodes and their capacities, with zero entries inserted where no link is present between nodes. Multiplication of the capacity matrix is used to determine the number of links between two specific nodes in the network. If there are L number of nodes (including originating and destination nodes) comprising the route between two specific nodes, then a set of $L \times 1$ control vectors are defined to represent the two end nodes and their connections to adjacent nodes in the network. A neural network is then used to converge the vectors to determine the links producing the shortest route, utilizing a gradient approach that minimizes the loss function with respect to the capacity matrix and the control vectors. If a condition such as a link failure occurs, the capacity matrix would be changed and a new route can be determined with a new convergence of the vectors performed by the neural network.

This approach is able to perform routing decisions in a telecommunications network, but a number of shortcomings are apparent. These are:

- Routing is determined from the connectivity of the nodes in the network and the network link capacities, and does not utilize a more general form of network representation that could include factors such as network delays.
- This approach produces a centralized routing method where one neural network performs routing decisions for the entire transport network, rather than a distributed routing method.
- Extensive preprocessing in the form of matrix multiplications are required to prepare control vectors for convergence.
- As a centralized method, neural network scalability becomes a problem. For the 16 node example used by the authors, 1260 active

neural elements and 9000 connections are required; for a telecommunications network with 100 nodes and 2000 source-destination pairs, the authors estimate that 14,000 active neural elements and 100,000 connections would be required.

As a result of these factors, other methods were researched. The most promising approach found is proposed by Jensen et al [20], where a distributed adaptive routing algorithm is investigated for telecommunications networks. In this approach a neural network is placed within each node of a telecommunications network, and is responsible for routing to adjacent nodes. A multilayer feed forward network resides at each node, with the input layer representing the nodes in the network and the output layer representing the links that connect the specific node to adjacent nodes. By using information on the propagation time of packets arriving from other nodes in the network, a mapping of delays through a given link to any node in the network is developed. The propagation delay values, combined with the adjacent link and the source node information, are then used to train the neural network. To use the trained network, an input neuron representing a specific destination node is asserted, and the output of the neural network will be the adjacent link on the shortest path to the destination node. The neural network in the next node of the telecommunications network in turn will make a routing decision toward the destination node based on similar training to that of the first node. When tested against other routing methods, it was found that after training the neural network routing decisions were of equal performance to static routing tables, and were more flexible in adapting to abnormal network conditions.

This approach overcomes the shortcomings of the previous neural network method. By providing a distributed routing system, decisions can be made locally instead of from a centralized point, resulting in faster response. By defining a neural network structure based on mappings of the network nodes and adjacent links, the network implementation is more scalable. And while network delay was used solely in the approach, more generalized functions can be used to represent the network facilities. One of the drawbacks identified was the need for constant communication between nodes, but in a

modern transport network this can be accommodated.

2.4 Attributes of an optimal routing method using neural networks

From reviewing the background on routing from the viewpoints of telecommunications, routing theory, and existing neural network applications, we can define attributes of a preferred network routing system using neural networks. These are:

- The method must be able to perform routing decisions quickly, given the requirement to adapt to restoration situations. Neural networks offer fast decision times, for once a neural network is trained the speed of the decision is limited to the speed of a simulator in the case of a software implementation or chip delays in the case of a hardware implementation.
- The routing method should be distributed to provide the fast decision times, for centralized methods incur delays from the communications required to report the status of the network, perform the decision, and implement the routing changes. Routing methods discussed by Ephremides and Verdu can be implemented in a distributed manner, and both Grover et al and Jensen et al demonstrated distributed routing with conventional and neural network methods respectively.
- The routing method should be able to provide multiple route alternatives in the case of a network failure. This type of performance is produced by using K-th shortest paths routing methods, as implemented in Grover et al for the current telecommunications network.
- The routing method will require information provided by adjacent nodes for performing routing decisions. Ephremides and Verdu, Grover et al and Jensen et al all used messages; while Ephremides and Verdu and Jensen et al used continuous messaging to defined the characteristics of the network, Grover et al used messaging only when a failure occurred to determine restoration routes. The

transmission and processing of the messages between nodes is the main reason for the length of restoration times simulated by Grover et al; if such a message wave is transmitted in advance of a failure when the network is under normal conditions, the processed signatures could be used to determine the ranking of adjacent links for routing to the nodes in a telecommunications network. This ranking information could then be used as a training set for a neural network.

- The neural networks used should be scalable, for as telecommunications networks change a neural network router must be able to adapt accordingly. Of the neural network research reviewed, the method used by Jensen et al appears to scale easily.

The purpose of this thesis is to implement a neural network router with the attributes outlined above. The following paragraphs provide a detailed description of the proposed method.

2.5 Description of the routing method under study

The routing method studied in this thesis would perform distributed routing, where each individual node in the network performs routing decisions. These routing decisions are based on the relationship between the originating node where the decision is being made, the desired destination node, and the links that connect the originating node to adjacent nodes in the network. By limiting the routing decision to the originating node's links, the number of alternatives that a neural network has to consider in performing the routing function is reduced.

As discussed, networks consist of a set of nodes connected to each other by a set of links. For simplicity the sample network used in this thesis will be an undirected connected graph; this means that all links are bidirectional (a link can be used to define a route in either direction) and that at least one route can be defined between any two nodes. A route through a network consists of an originating node, a destination node, and a sequence of intervening links and

nodes between them that defines a route. One of the intervening links in the route will be a link that connects the originating node to an adjacent node.

As stated above, there will always be at least one route that will connect any two nodes; in most cases there will be multiple routes between them. In order to make a routing decision, some type of criteria is required to allow for comparison of the multiple routes between the originating and destination nodes. One method of providing this criteria is by assigning a weight or value to the links and nodes of the network; a route that is comprised of a sequence of nodes and links is then assigned a weight equal to the sum of the weights of the links and nodes. By relating the weights of the multiple routes to the links that connect the originating node to its adjacent nodes, a pattern is defined that can be used as the criteria for performing routing decisions.

This method can best be shown by example. In Figure 2.9(a), route C-F-J connects originating node C to destination node J. One of the intervening links in the route will be a link that connects the originating node C to the adjacent node F. In addition to this first route, additional routes from C to J can be defined through the other links that connect node C to its other adjacent nodes. In Figure 2.9(b), three other routes can be defined: route C-E-H-J connects C to J through the link that connects node C to node E; C-D-G-J connects C to J through the link that connects node C to node D; and C-A-B-E-H-J connects C to J through the link that connects node C to node A.

In the example we have identified four separate routes from C to J, but as yet we cannot make a decision as to which route is the best; some form of criteria is required for us to make a decision. In Figure 2.9(c), weights are added to the links that are in proportion to their geometric distance. By adding the weights of the links for each route together, a weight for each route is determined. The weight for each route is now associated with the link that connects originating node C to the adjacent node that defines the first part of each route from C to J. On the basis of comparing the route weights, the route that represents the shortest geometric distance from C to J is C-F-J, and the link from C to F is the first choice for routing. In addition, the ranking of the other

Figure 2.9(a):
One possible route
from originating node C to destination
node J is the route C-F-J. One of the
links in the route is the link that
connects originating node C to node F.

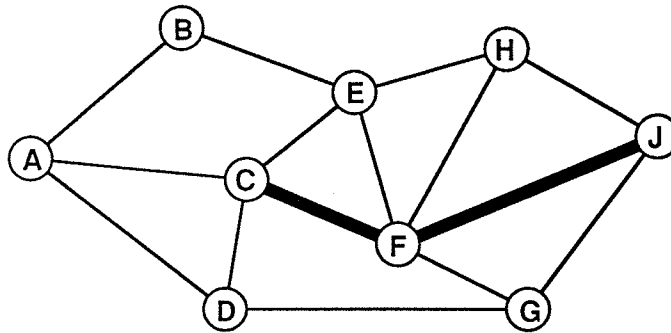

Figure 2.9(b):
Other possible routes
from originating node C to destination node J
and their links from originating node C to an
adjacent node:
- Route C-E-H-J (link C to E)
- Route C-D-G-J (link C to D)
- Route C-A-B-E-H-J (link C to A)

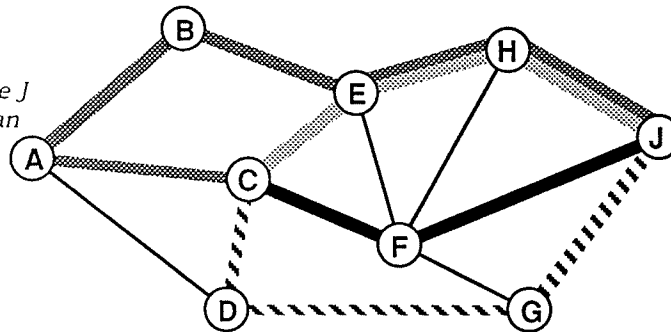

Figure 2.9(c):
Weights are assigned to links. Weighted values
for routes are calculated and associated with
links.

Route	link	route value
C-F-J	C to F	0.240
C-E-H-J	C to E	0.254
C-D-G-J	C to D	0.350
C-A-B-E-H-J	C to A	0.504

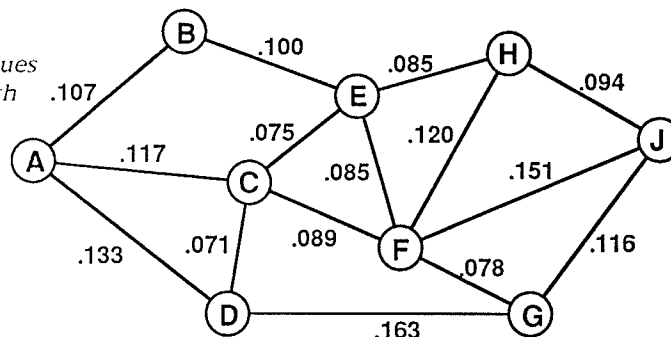
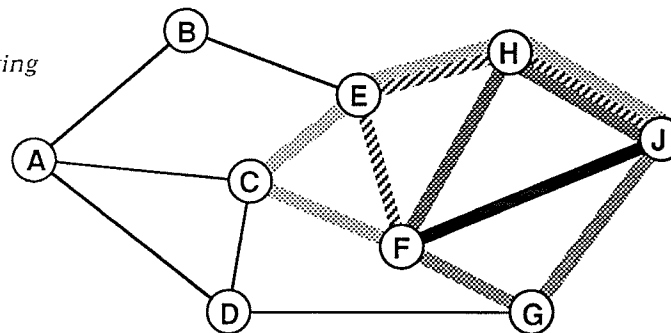

Figure 2.9(d):
Routing process is repeated with node F acting
as the originating node.

Route	link	route value
F-C-E-H-J	F to C	0.343
F-E-H-J	F to E	0.264
F-H-J	F to H	0.214
F-J	F to J	0.151
F-G-J	F to G	0.194



routes has also been determined; routes C-E-H-J, C-D-G-J, and C-A-B-E-H-J are the 2nd, 3rd, and 4th choices for routing, respectively.

By using the above method, the links from a given originating node have been ranked with respect to a weighting factor to the destination node. The routing decision would select the link from node C to node F as the best choice for routing to node J, and a portion of the complete route has been defined. In order to completely determine the route, the same process would be performed with node F as the originating node trying to determine the best route to node J. The process is repeated relating destination node J to the links that connect node F to its adjacent nodes. In this case node F is connected by a link to node J, and in determining the weights of the route the direct link would be chosen. The routing example with node F is shown in Figure 2.9(d).

As demonstrated above, the relationship of the originating node, the destination node, and the adjacent links can be used to perform routing. In order to perform the routing decisions properly, however, the routes that are related to the adjacent links must comply with the following rules:

- The routing sequence from the originating node to the destination node through a specific adjacent link must be the best route using that link based on the criteria used for routing. In figure 2.9, route C-A-B-E-H-J and C-A-D-G-J are both routes from originating node C to destination node J, and both use the adjacent link from C to A; but route C-A-B-E-H-J has the smallest weighting factor. The best route must be used for each adjacent link in order for the order of the routing choices to be properly determined.
- The routing sequence from the originating node to the destination node through a specific adjacent link must not reuse the originating node. This would lead to incorrect routing decisions and a dependence on another adjacent link connected to the originating node. Please note that in 2.9(d), node F searched for a route from node F to node C; this is allowed for node F has become the originating node performing the routing decision.

The next section of this thesis will further describe the routing information used in the simulations and experiments. In considering the objectives of this thesis, the collection and creation of the routing information and its relation to the adjacent nodes is not being studied; signature analysis of messages between nodes as discussed previously is one possible method that can perform this function. The objective is to study the ability of a neural network to learn and process this information to perform routing decisions. As will be shown in later sections, the learning of the routing information will allow an individual node to not only determine the link that defines the shortest route to a given destination node, but also determine the best alternate link(s) if the first choice is not available.

Chapter 3

Single Network Node Modelling

In this chapter neural networks will be studied to determine their ability to learn routing information for a single node in a sample network. Several network topologies and training methods will be tested, and modifications to the training set will be performed to determine the effects on learning. From these tests, conclusions will be made on the optimal parameters to perform learning of routing information.

3.1 Description

3.1.1 Description of the sample network

In order to study the ability of a neural network to perform network routing decisions, a sample network is required to provide the network data needed for the research. The sample network used for this research is shown in Figure 3.1.

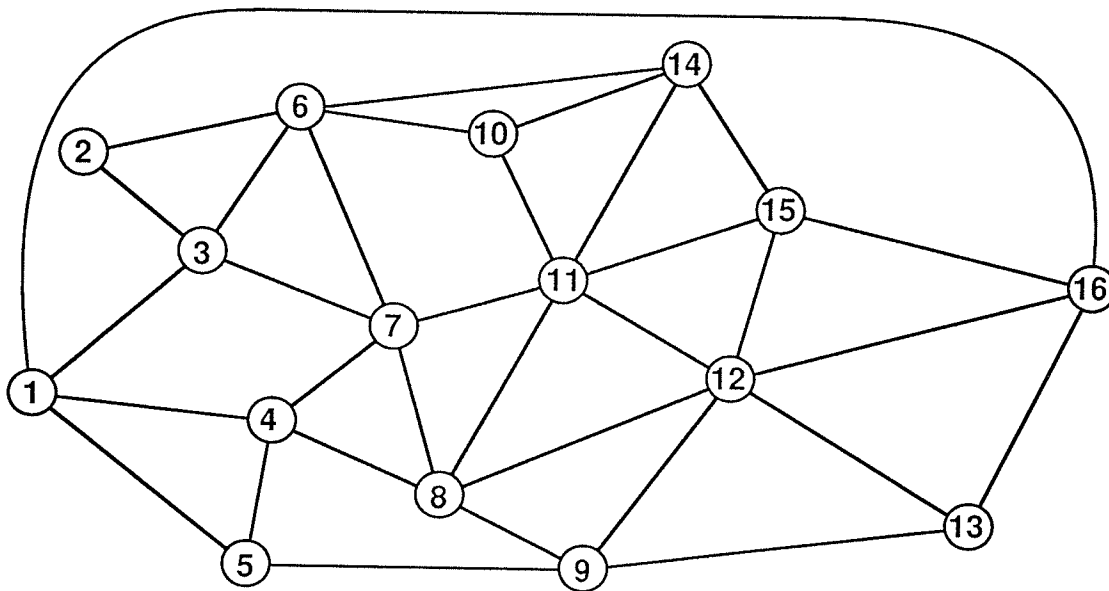

Figure 3.1:
Sample Network

The sample network is an undirected connected graph illustrative of a simple communications network, consisting of 16 nodes and a set of associated links. The number of links connected to each node (the node's valence) ranges from a 2 to 6. Table 3.1 lists the valence values, the number of nodes in the sample network of each valence, and the numbers of the nodes.

*Table 3.1:
Valence values for the sample network*

Valence	# Nodes	Nodes
2	1	2
3	3	5,10,13
4	7	1,3,4,9,14,15,16
5	3	6,7,8
6	2	11,12

3.1.2 Description of the neural network

Figure 3.2 depicts the neural network studied in this thesis and its relationship to the nodes in the sample network. Each neural network is trained to determine routing results for a specific node in the sample network. The neurons in the input layer of the neural network represent the nodes of the sample network. The neurons in the output layer of the neural network represent the links of the specific node in the sample network to its adjacent nodes; in Figure 3.2, links L1 to L4 represent the adjacent links connected to node 9. The training set for each neural network consists of routing information relating each node and its adjacent links to the other nodes in the sample network as described in the introduction of this thesis. The task of the neural network is to learn this related routing information for each node. By performing postprocessing on the neural network's outputs, the link that best fits the routing criteria can be determined from the output layer.

In considering the various neural network topologies, activation functions, and learning rules available for use, the following choices were made for the test networks.

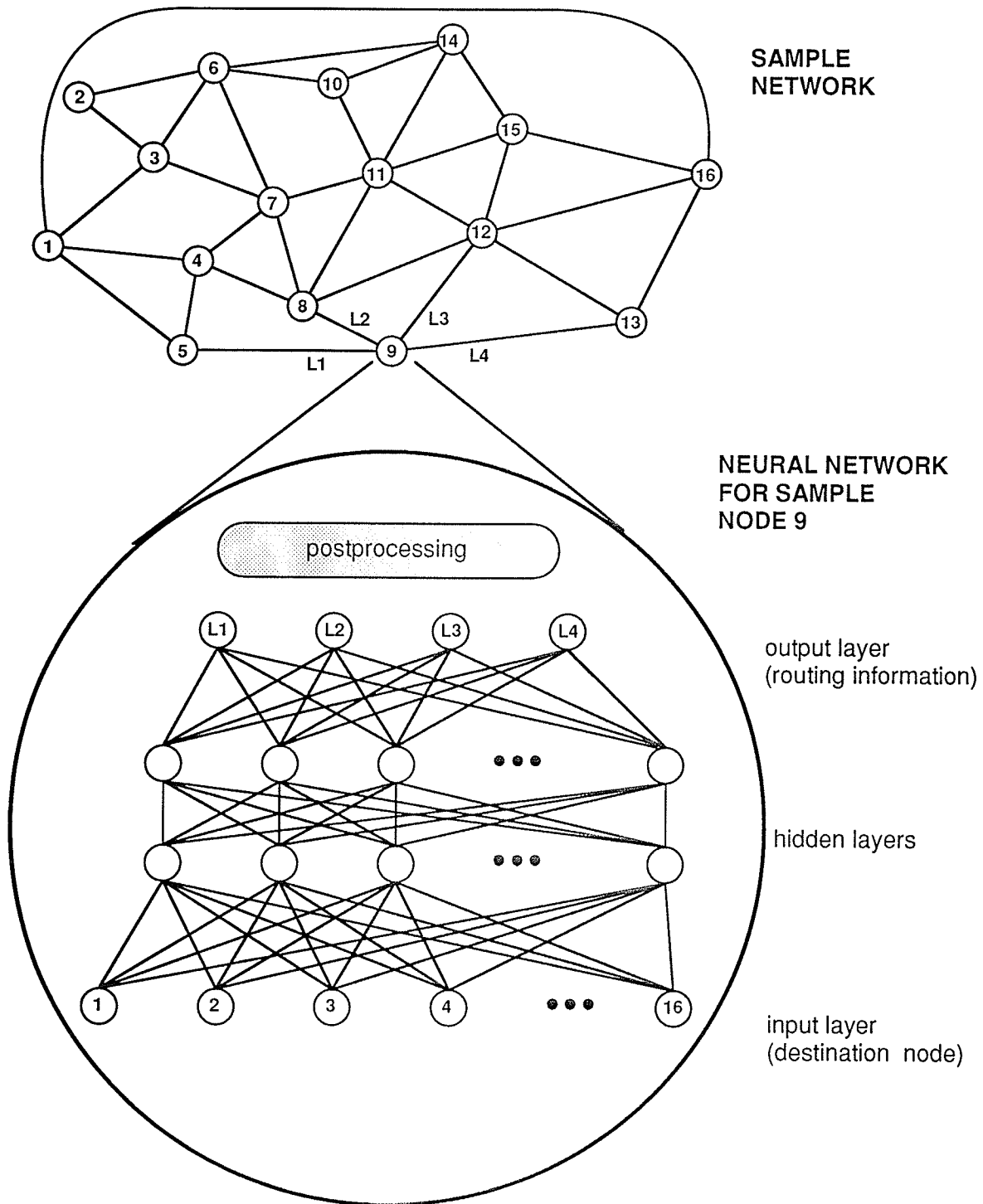

Figure 3.2:
Neural Network and its relation to the Sample Network

3.1.2.1 Learning rule

The learning rule to be used is Back Propagation. This rule was chosen because the task to be performed is a function of mapping input vectors to output vectors. Back Propagation has been found to be an effective learning technique for mapping and pattern classification problems [21].

3.1.2.2 Topology

The network topology is a four layer feed forward network consisting of an input, an output, and two hidden layers. Each layer is fully connected to the following layer. The four layer feed forward network (a three layer perceptron) is commonly used with the Back Propagation learning rule in mapping applications and pattern classification; the output rankings of the neural network can be considered a pattern that must be classified for each input. There are $N!$ possible ranking patterns for a sample network node with N outputs, and to select the correct pattern out of a large number of patterns would require a pattern classifier capable of creating complex and arbitrary decision regions. The three layer perceptron is well suited to creating these types of regions [22].

3.1.2.3 Activation function and associated variables

The activation function for the network is a continuous sigmoid [23], represented by the equation below

$$a(t+1) = \frac{1}{1 + e^{-w(t)/T}}$$

where

$a(t+1)$ is the activation value of a neuron,

$w(t)$ is the weighted sum of the neuron's inputs, including

any threshold values, and
 T is the network temperature.

For this function, the threshold is set to zero, and the maximum and minimum activation values are set at 0 and 1 respectively; these values are common in back propagation learning. The temperature variable is used to modify the steepness of the sigmoid function, and is usually set high at the start of learning to provide a gradual activation function. As learning progresses the temperature is reduced, resulting in a steeper activation function that forces the network towards the minimum error solution.

3.1.2.4 Learning rate and momentum

The back propagation learning rule determines the error between a neuron's actual output values and the desired values, and modifies the weight of the connection to the previous layer; this process starts at the output layer and is propagated back to through the neural network to the input layer. The formula [24] that determines the change in connection weight is shown below

$$\Delta w(t) = -\alpha \frac{\partial E}{\partial w}(t) + \sigma \Delta w(t-1)$$

where

- w(t) is the weight of the connection between two nodes in different layers,
- $\Delta w(t)$ is the change in connection weight through learning,
- E is the global error (the squared error between the actual and desired output values),
- $\partial E(t)/\partial w$ is the rate of change of the global error with respect to the connection weight,
- α is the learning rate (a variable that controls the amount of weight change) and
- σ is momentum (a variable that speeds learning by using previous weight change information).

By adjusting the values of the learning rate and momentum variables, the rate of learning can be controlled. For this thesis, values of 0.2 and 0.9 used for the learning rate and momentum respectively; the values were defaults supplied by the neural network simulator, and were left unchanged.

3.1.3 Determination of the routing information

As discussed in the introduction, routing criteria can be established by assigning weights or values to the links and nodes of a network, and using the sum of the weights of a sequence on links and nodes to determine the weight of a route. This routing information is the basis of the training sets used in this thesis. In telecommunications networks, a weight related to distance (physical separation of nodes in a communications network) or time (the time to transmit a signal between nodes) could be used for the study. For this thesis a weighting factor related to time was chosen, for a time related factor can be used to model both the links and nodes of a communications network.

The links and nodes of a telecommunications network introduce time delays through different methods. Time delays incurred by a transport facility (transport delays) are a function of the physical distance between two nodes in the network; in this case a signal with a known velocity travels down the facility, with the delay equal to the distance divided by velocity. Examples of links in a telecommunications network include copper wire, fibre optic cable, and microwave radio. Time delays in a network node are incurred due to the time required to switch a given signal between links in and out of a node. An example of a equipment that performs this function is a telephone switch or a DCS, which connects different digital signal inputs to outputs by using a combination of time and space switching; time switching involves the switching of a signal between different time slots, and this process introduces delays. Depending of the nature of a signal and the complexity of a telecommunications node, multiple switches may be performed. By using time based weighting, very dissimilar transport and switching activities can be modelled in the same network, since the activities all relate to a time

component.

Depending on the geographical size of the telecommunications network being considered, the comparative magnitude of the weighting for the nodes will change with respect to the links. If the values of the node and link weights are similar in size, then the time delays of the links are small, and the network being modelled will have a small geographic area in telecommunications network terms; such a network model would represent a city. If, however, the node weights are small in comparison to the link weights, then the network would cover a large geographic area, more closely modelling a large network between cities. In this thesis the goal is to model large scale networks, so the link weights would be several times larger than the node weights.

For the purposes of this thesis, a value of 0.25 milliseconds was chosen to approximate the maximum time delay for a network node; this is representative of an average delay in current telecommunications networks. The lengths of the links shown in Figure 3.1 were measured and provided in Table 3.2. If the unmodified link lengths were to be used for the weights, the link weights would be between 8 and 60 times larger than the node weights, which would be too large a difference in magnitude for the desired simulations. To reduce the difference in magnitude between link and node weights, the link weights were multiplied by a factor of 0.37; as a result the link weights were now between 3 and 20 times the size of the node weights. The value of 0.37 was produced by using the following formula

$$\frac{(7\,600\,000)(1.46)}{(300)(100\,000)} = 0.37 \quad (\text{msec/cm})$$

where

7 600 000	=	Scaling factor
1.46	=	index of refraction
300	=	Speed of light (km/msec)
100 000	=	number of centimeters per kilometer (cm/km)

Table 3.2
Length values for each link in the sample network

From/To	1	2	3	4	5	6	7	8	9	10	11	12	13	14	15	16
1			2.9271	3.1907	3.6200											15.000
2			2.0330			2.9271										
3	2.9271	2.0330				2.2895	2.7127									
4	3.1907				1.9311		2.0330	2.4180								
5	3.6200			1.9311					4.4450							
6		2.9271	2.2895				3.1269			2.5598				4.9621		
7			2.7127	2.0330		3.1269	2.3114				2.3114					
8				2.4180			2.3114		2.1298		3.2690	4.1275				
9					4.4450			2.1298				3.1750	5.1196			
10						2.5598					2.1298			2.7127		
11							2.3114	3.2690		2.1298		2.5598		3.2690	3.0122	
12								4.1275	3.1750		2.5598		3.7026		2.3114	4.9289
13									5.1196			3.7026				3.5497
14						4.9621				2.7127	3.2690				2.2896	
15											3.0122	2.3114		2.2896		4.2360
16	15.000											4.9289	3.5497		4.2360	

To use the values in the above formula in an illustrative example, if the sample network was drawn to a 1:7 600 000 scale, and the velocity of a signal was the speed of light divided by the given index of refraction, the factor of 0.37 milliseconds/ centimeter is produced. To provide an idea of the scale used, Figure 3.3 shows the sample network superimposed on a geographic area of equivalent scale.

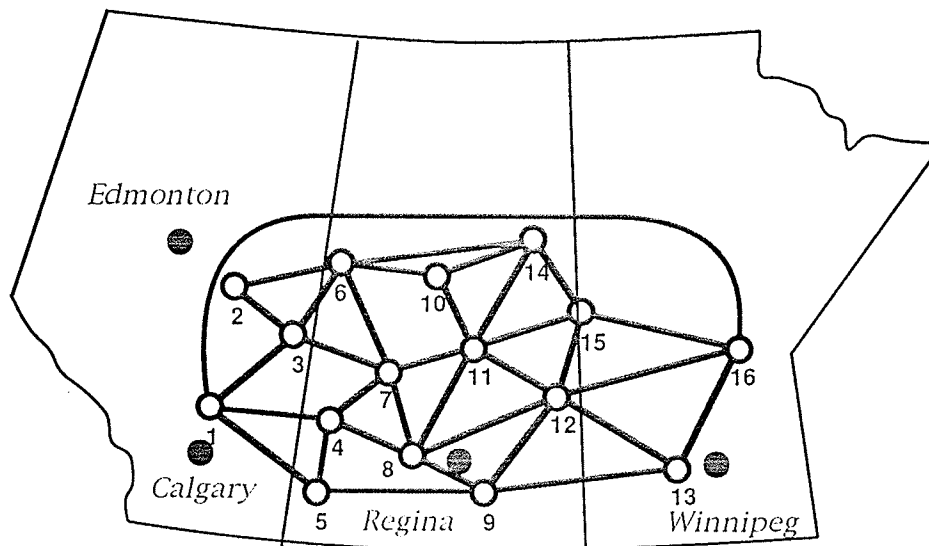

Figure 3.3:
Comparison of sample network to a geographic area of equivalent scale.

After performing the described scaling, the new values are provided in Table 3.3(a). When the weights of several sample sequences of nodes and links were summed, it was found that the route weights were too large to be used as output values for training in back propagation networks; the route weights must be between 0 and 1 for the networks, activation functions, and learning paradigms to be used. By multiplying all of the weights by 0.1, the weights were reduced to values where the route weights could be used for training purposes. The resulting final weighting values for the nodes and links are provided in 3.3 (b).

Table 3.3 (a)
Scaled node and link weights

From/To	1	2	3	4	5	6	7	8	9	10	11	12	13	14	15	16
1	0.2500		1.0734	1.1700	1.3275											5.5005
2		0.2500	0.7455			1.0734										
3	1.0734	0.7455	0.2500			0.8396	0.9947									
4	1.1700			0.2500	0.7081		0.7455	0.8867								
5	1.3275			0.7081	0.2500				1.6300							
6		1.0734	0.8396			0.2500	1.1466			0.9387				1.8196		
7			0.9947	0.7455		1.1466	0.2500	0.8476			0.8476					
8				0.8867			0.8476	0.2500	0.7810		1.1987	1.5136				
9					1.6300			0.7810	0.2500			1.1643	1.8774			
10						0.9387				0.2500	0.7810			0.9947		
11							0.8476	1.1987		0.7810	0.2500	0.9387		1.1987	1.1046	
12								1.5136	1.1643		0.9387	0.2500	1.3577		0.8476	1.8074
13									1.8774			1.3577	0.2500			1.3017
14						1.8196				0.9947	1.1987			0.2500	0.8396	
15											1.1046	0.8476		0.8396	0.2500	1.5533
16	5.5005											1.8074	1.3017		1.5533	0.2500

Internal (Node) Weight: Link Weight Multiplier:

Table 3.3 (b)
Final network weights (node and link weights multiplied by 0.1)

From/To	1	2	3	4	5	6	7	8	9	10	11	12	13	14	15	16
1	0.0250		0.1073	0.1170	0.1327											0.5501
2		0.0250	0.0746			0.1073										
3	0.1073	0.0746	0.0250			0.0840	0.0995									
4	0.1170			0.0250	0.0708		0.0746	0.0887								
5	0.1327			0.0708	0.0250				0.1630							
6		0.1073	0.0840			0.0250	0.1147			0.0939				0.1820		
7			0.0995	0.0746		0.1147	0.0250	0.0848			0.0848					
8				0.0887			0.0848	0.0250	0.0781		0.1199	0.1514				
9					0.1630			0.0781	0.0250			0.1164	0.1877			
10						0.0939				0.0250	0.0781			0.0995		
11							0.0848	0.1199		0.0781	0.0250	0.0939		0.1199	0.1105	
12								0.1514	0.1164		0.0939	0.0250	0.1358		0.0848	0.1807
13									0.1877			0.1358	0.0250			0.1302
14						0.1820				0.0995	0.1199			0.0250	0.0840	
15											0.1105	0.0848		0.0840	0.0250	0.1553
16	0.5501											0.1807	0.1302		0.1553	0.0250

With the weighting values for the nodes and links determined, pattern files containing the routing information for a set of sample nodes were generated. It was decided that a small set of sample nodes would be initially tested to evaluate the performance of the neural networks. The sample nodes chosen were nodes 2, 9 and 11; these nodes have 2, 4, and 6 adjacent links respectively, and by using these nodes for the initial testing the results would provide some indication of the performance of the neural networks for small, medium, and large numbers of output nodes.

The pattern file for Node 2 is shown in Table 3.4. Each pattern file consists of a set of input/output vector pairs. The input vector is a binary vector that asserts a single input neuron representing a specific destination node. The output vector is a real value vector representing the routing information for that particular destination node derived from the routing criteria discussed. In each pattern file, one of the 16 input neurons represents the particular node in the sample network that is being trained; as a result, the output vector for that node would contain zero values. In Table 3.4, these values are associated with input neuron i_2 . In the 2, 4, and 6 output node training sets, the corresponding input neurons with zero output vector values are i_2 , i_9 , and i_{11} respectively. When the actual training was performed, this zero output value vector pair was excluded, and the training set contained 15 input/output vector pairs instead of 16.

All of the pattern files used in the initial testing can be found in Appendix A.

3.1.4 Description of the simulation package

With the basic neural network topology, activation function, learning rule and initial training sets defined, the training of the neural networks could be simulated. The network simulations were performed on an Apple Macintosh IIfx with 4MB RAM and an 80 MB hard drive. The application used to perform the simulations was MacBrain 2.0 and 3.0, distributed by Neurix of Massachusetts. MacBrain is an neural network simulation package capable of

Table 3.4:
Pattern File for Node 2 of Sample Network

Destination Node	Input Vector																Output Vector	
	i1	i2	i3	i4	i5	i6	i7	i8	i9	i10	i11	i12	i13	i14	i15	i16	o1	o2
1	1	0	0	0	0	0	0	0	0	0	0	0	0	0	0	0	0.2569	0.3986
2	0	1	0	0	0	0	0	0	0	0	0	0	0	0	0	0	0.0000	0.0000
3	0	0	1	0	0	0	0	0	0	0	0	0	0	0	0	0	0.1245	0.2663
4	0	0	0	1	0	0	0	0	0	0	0	0	0	0	0	0	0.3486	0.3966
5	0	0	0	0	1	0	0	0	0	0	0	0	0	0	0	0	0.4146	0.4924
6	0	0	0	0	0	1	0	0	0	0	0	0	0	0	0	0	0.2335	0.1573
7	0	0	0	0	0	0	1	0	0	0	0	0	0	0	0	0	0.249	0.297
8	0	0	0	0	0	0	0	1	0	0	0	0	0	0	0	0	0.3588	0.4068
9	0	0	0	0	0	0	0	0	1	0	0	0	0	0	0	0	0.4618	0.5097
10	0	0	0	0	0	0	0	0	0	1	0	0	0	0	0	0	0.3524	0.2762
11	0	0	0	0	0	0	0	0	0	0	1	0	0	0	0	0	0.3588	0.3793
12	0	0	0	0	0	0	0	0	0	0	0	1	0	0	0	0	0.4776	0.4981
13	0	0	0	0	0	0	0	0	0	0	0	0	1	0	0	0	0.6385	0.659
14	0	0	0	0	0	0	0	0	0	0	0	0	0	1	0	0	0.4405	0.3643
15	0	0	0	0	0	0	0	0	0	0	0	0	0	0	1	0	0.4942	0.4733
16	0	0	0	0	0	0	0	0	0	0	0	0	0	0	0	1	0.6745	0.6536

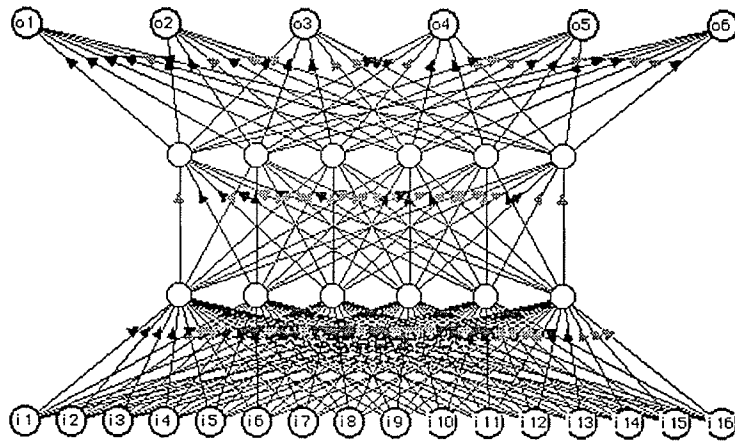

Figure 3.4:
Neural Network with 16 input neurons, 6 output neurons, and
2 hidden layers of 6 neurons each

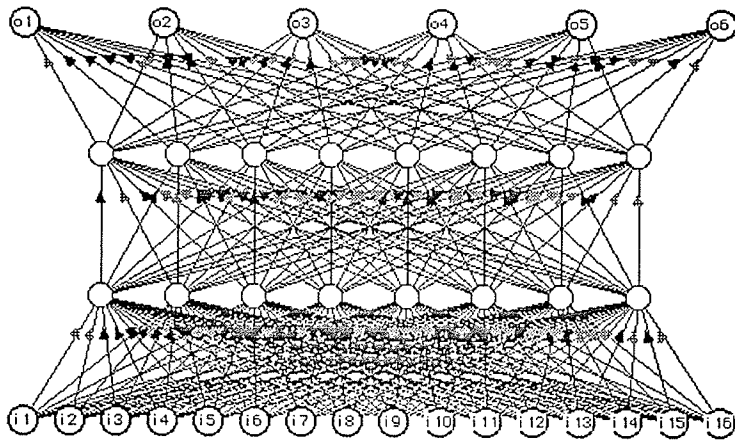

Figure 3.5:
Neural Network with 16 input neurons, 6 output neurons, and
2 hidden layers of 8 neurons each

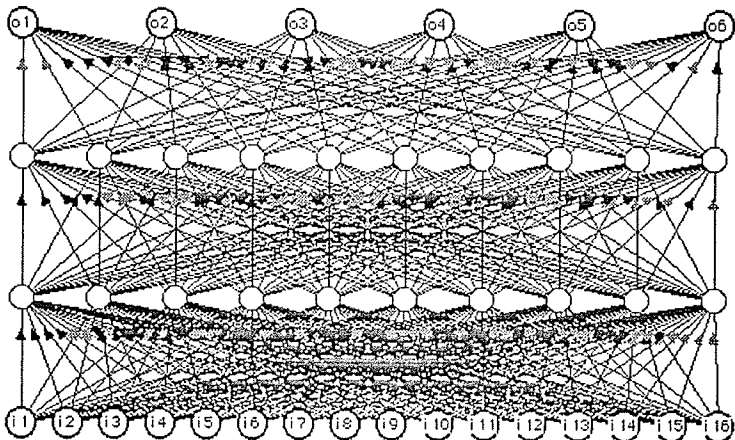

Figure 3.6:
Neural Network with 16 input neurons, 6 output neurons, and
2 hidden layers of 10 neurons each

simulating different neural network topologies, activation functions, and learning rules.

The first objective of the simulations was to determine a suitable number of neurons for the neural network's two hidden layers. For the initial testing three combinations of hidden layers were used; both hidden layers contained equal numbers of neurons, with each layer having 6, 8, or 10 neurons. Figures 3.4, 3.5, and 3.6 show the topologies of a 6 output neuron, two hidden layer network with 6, 8, and 10 neurons per hidden layer respectively. These networks would become the foundation for all testing; to create a neural network for any of the sample network nodes, output neurons are removed until the desired number is attained.

3.2 Training the neural networks

3.2.1 The V1 Macro

The three network topologies were trained using the three training sets generated for nodes 2, 9, and 11, resulting in 9 trained neural networks; Table 3.5 lists the nine network topologies.

*Table 3.5:
Neural network topologies used in the initial testing*

Network Identifier	Description of macro used, number of neurons per hidden layer, and number of output neurons	Training set used
V1.2.06.2	V1 Macro, 6 neurons/hidden layer, 2 output neurons	Node 2
V1.2.06.4	V1 Macro, 6 neurons/hidden layer, 4 output neurons	Node 9
V1.2.06.6	V1 Macro, 6 neurons/hidden layer, 6 output neurons	Node 11
V1.2.08.2	V1 Macro, 8 neurons/hidden layer, 2 output neurons	Node 2
V1.2.08.4	V1 Macro, 8 neurons/hidden layer, 4 output neurons	Node 9
V1.2.08.6	V1 Macro, 8 neurons/hidden layer, 6 output neurons	Node 11
V1.2.10.2	V1 Macro, 10 neurons/hidden layer, 2 output neurons	Node 2
V1.2.10.4	V1 Macro, 10 neurons/hidden layer, 4 output neurons	Node 9
V1.2.10.6	V1 Macro, 10 neurons/hidden layer, 6 output neurons	Node 11

In MacBrain the training of the neural networks is performed by opening a network file containing the neural network and the parameters for its neurons and connections, pasting a pattern file with the training set onto the network, and executing a icon-based flowchart macro that contains the training algorithm. The first algorithm used in testing was called the V1 Macro, with the flowchart for the macro shown in Figure 3.7; the actual V1 Macro graphic can be found in Appendix A.

The V1 Macro performs the following functions:

- Prompts the user for the number of training cycles to be executed (NUMCYCLES) and the initial temperature (TEMPERATURE) for the activation function.
- Executes the learning function identified by the Learn node.
- Performs a loop in the program (using the variables INCREMENT and TESTPER) that calculates the mean squared error (MSE), assigns it to the variable MSERROR, and writes it to a text window every 5 learning cycles. In the same loop it reduces the temperature, annealing the network every 5 learning cycles.
- Performs various display housekeeping functions.
- Alerts the user when the simulation is complete.

The initial settings for the training were as follows:

- Number of training cycles (NUMCYCLES): 2000
- Initial temperature (TEMPERATURE): 0.2
- Learning rate: 0.2
- Momentum: 0.9
- Method of updating: Updating by layer
- Learning rule: Back Propagation
Batch with Momentum

3.2.2 Initial analysis of the V1 Macro trained networks

After the networks were trained the mean squared error results were studied. The MSE graph for network V1.2.06.4, shown in Figure 3.8, is typical of the

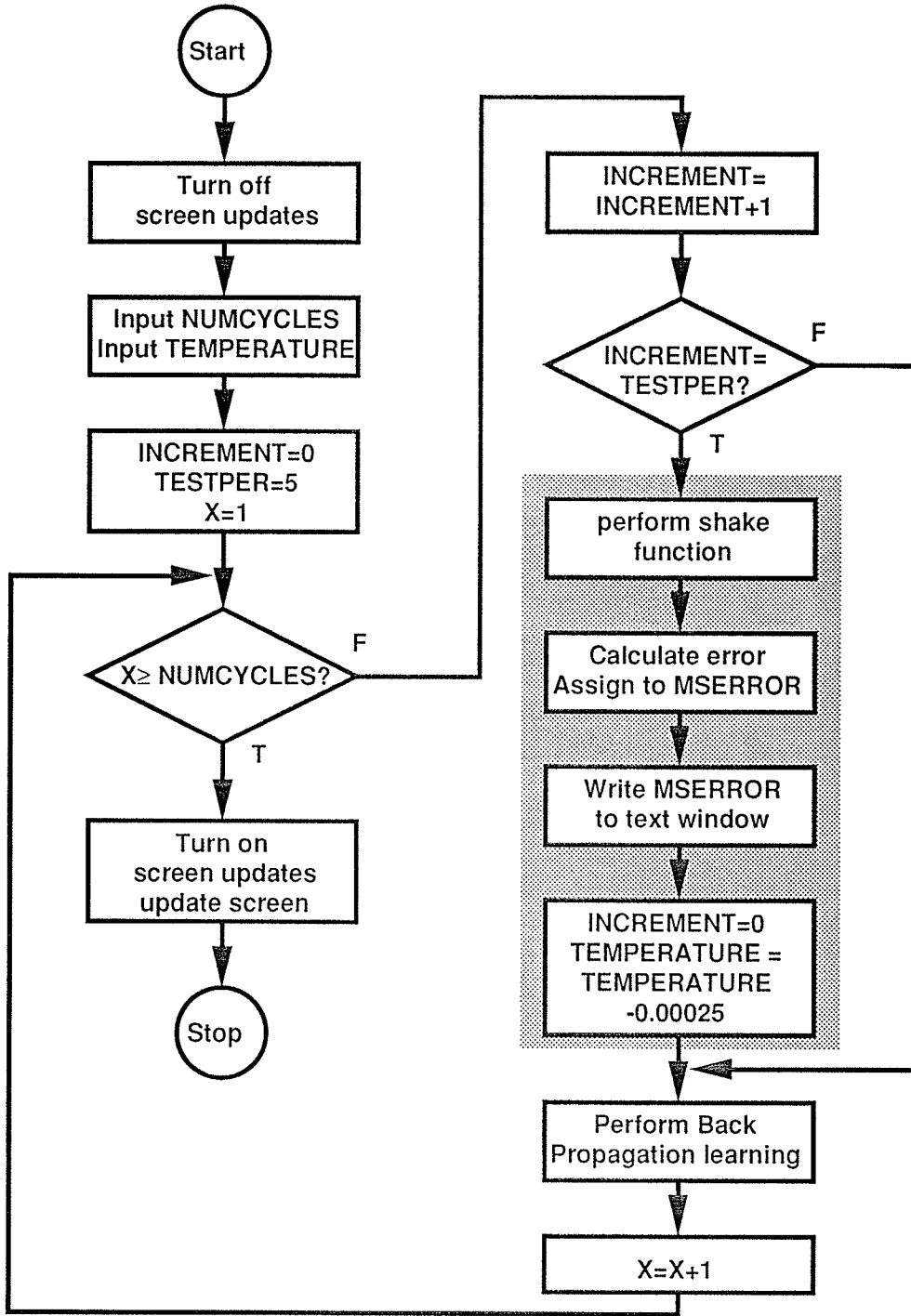

 Mean Squared Error calculation and annealing section

Figure 3.7:
Flowchart for the V1 Macro

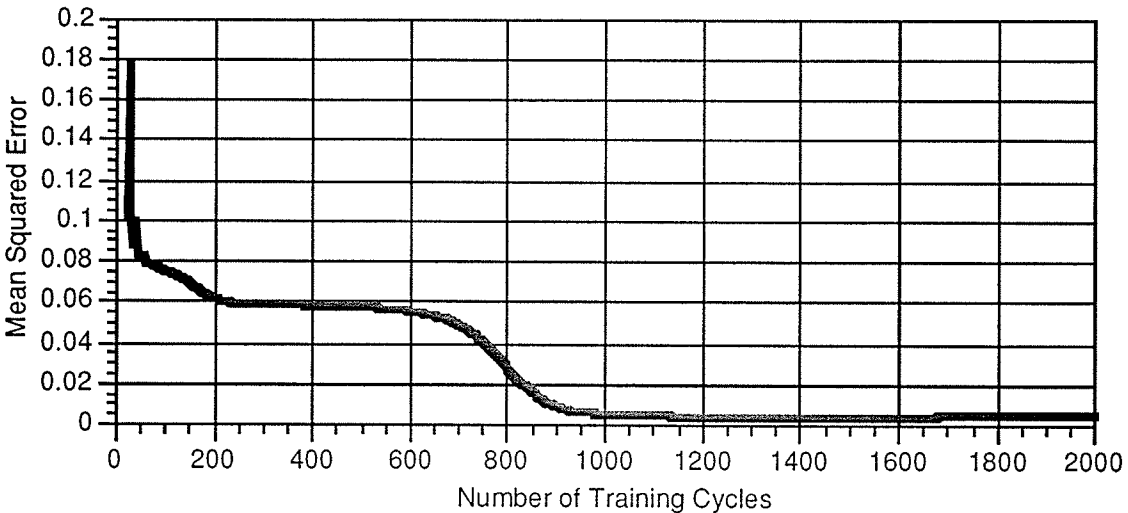

Figure 3.8:

MSE Values as a function of number of training cycles for network V1.2.06.4

mean squared error results for the nine networks trained; for each network the MSE started as a large value and then decreased monotonically after some initial fluctuations. The smooth decrease of the MSE value function is attributed to the fact that the error was calculated every five training cycles, thus resulting in some degree of smoothing of the function due to sampling. After the initial error fluctuations the function decrease was gradual, followed by a more rapid decrease in the characteristic before once again levelling off; the majority of the learning in the network was probably performed during the rapid decrease in the characteristic. A review of the MSE graphs for all nine networks shows that the number of cycles required to reach this point in the characteristic was dependent on the number of output neurons and not the number of hidden neurons per layer. Figures 3.9, 3.10, and 3.11 show the MSE characteristic as a function of 2, 4, and 6 output nodes, respectively. Figures 3.12, 3.13, and 3.14 show the MSE characteristic as a function of 6, 8, and 10 neurons per hidden layer respectively.

One other important feature of each MSE characteristic is that eight of the nine networks reached a minimum MSE value during the training, and then the MSE values began to increase; this feature is most evident in the V1.2.06.2, which reached the minimum MSE after 685 training cycles. In V1.2.06.6, the

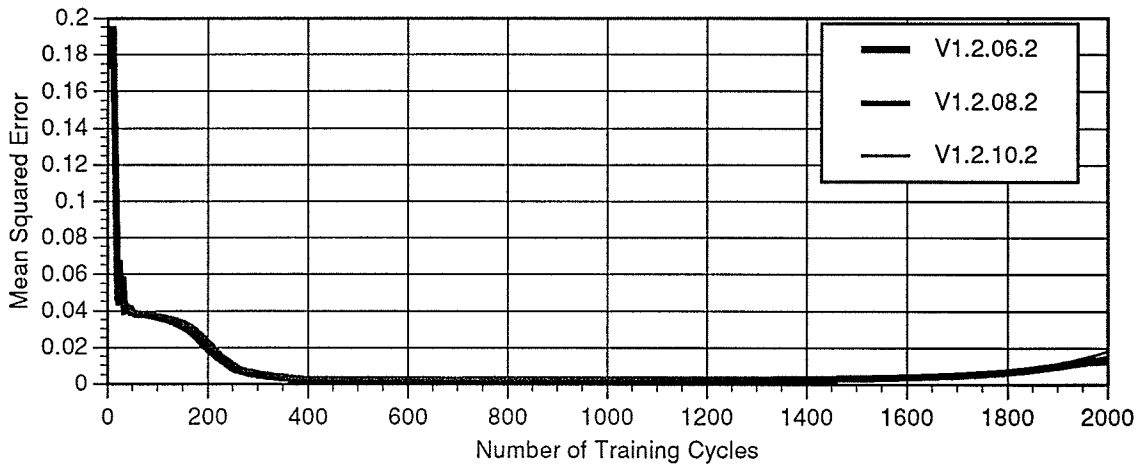

Figure 3.9:
MSE values for networks with two output neurons using the V1 Macro.

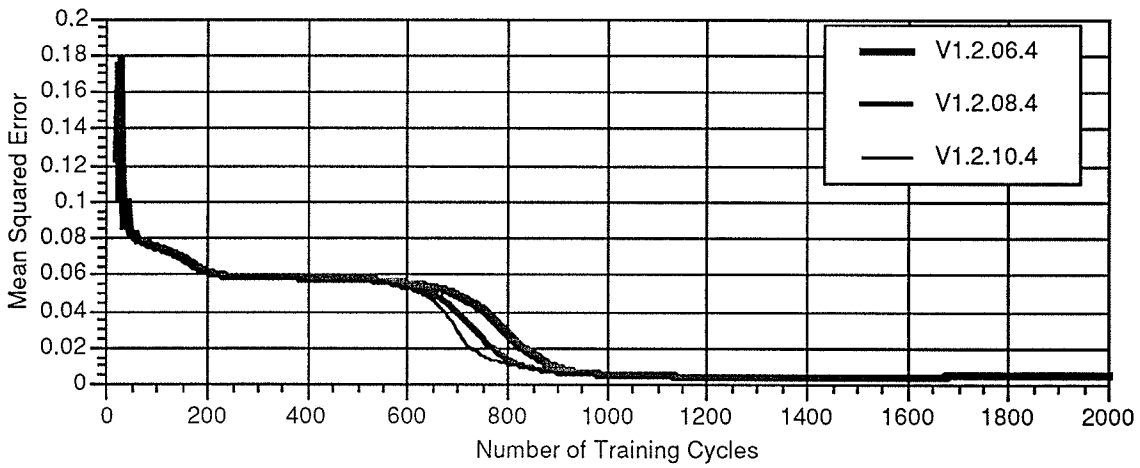

Figure 3.10:
MSE values for networks with four output neurons using the V1 Macro.

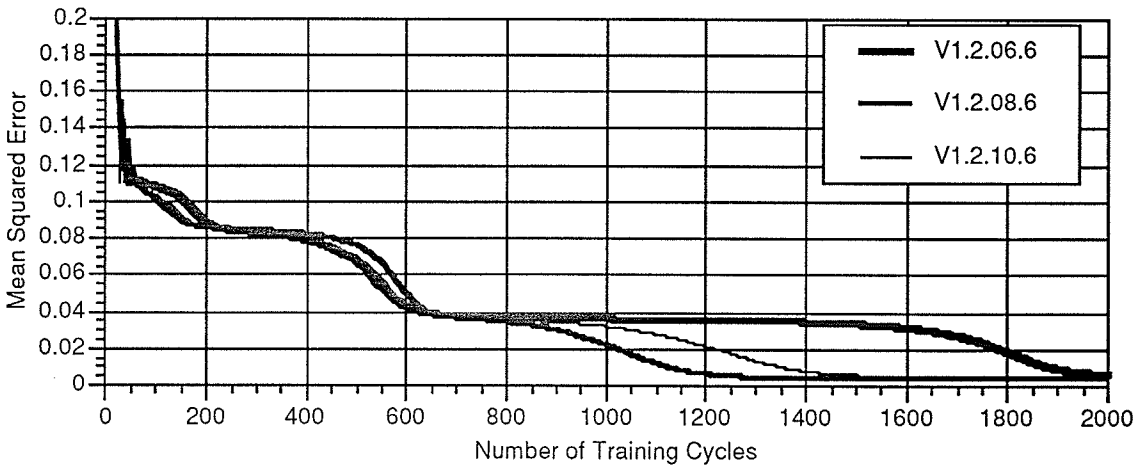

Figure 3.11:
MSE values for networks with six output neurons using the V1 Macro.

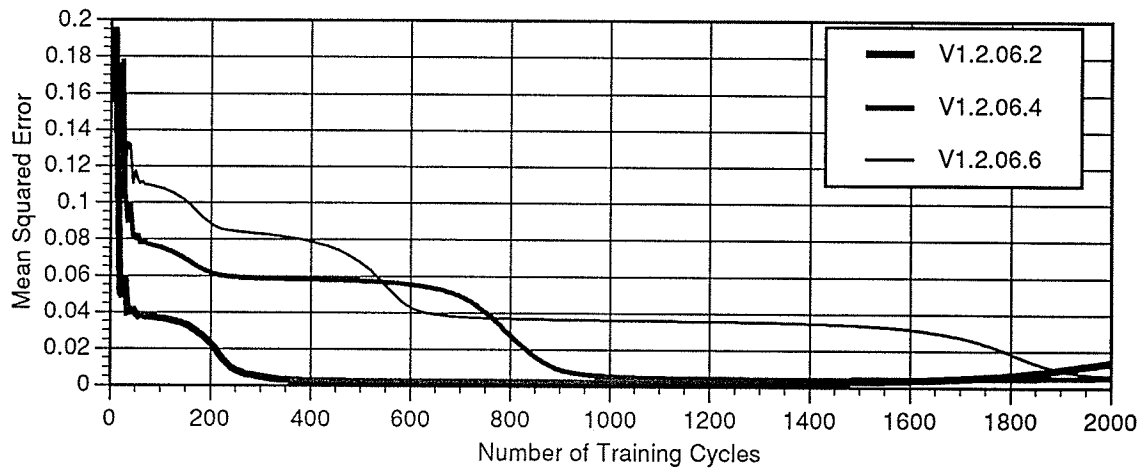

Figure 3.12: MSE Values for networks with six neurons per hidden layer using the V1 Macro.

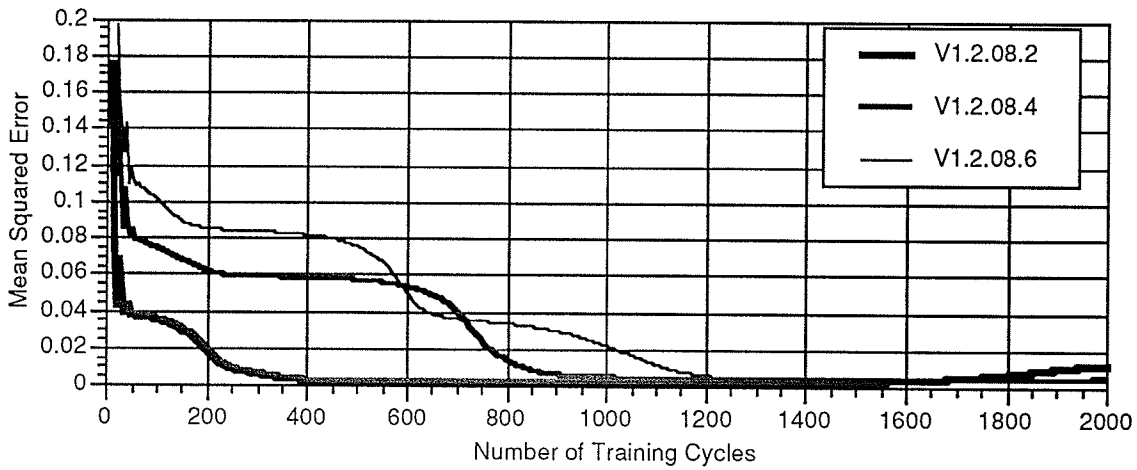

Figure 3.13: MSE Values for networks with eight neurons per hidden layer using the V1 Macro.

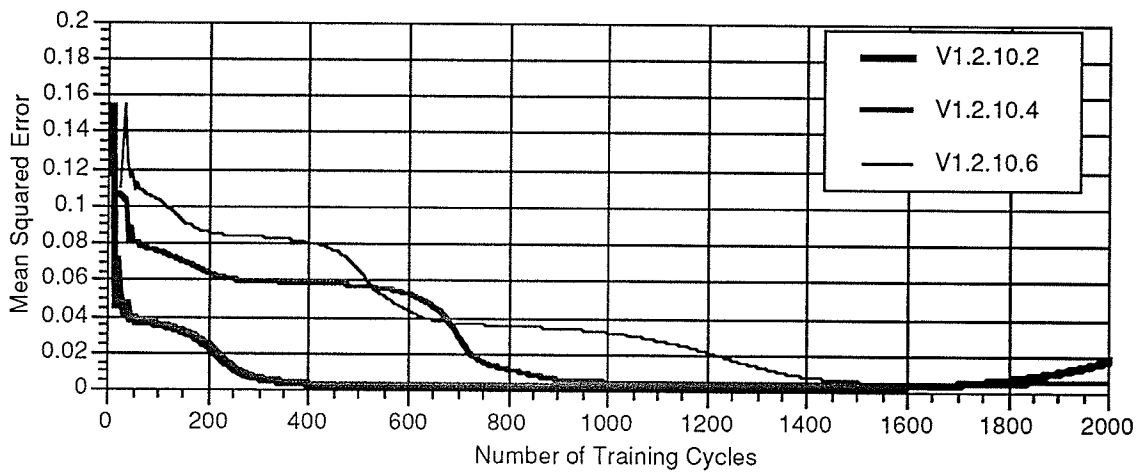

Figure 3.14: MSE Values for networks with ten neurons per hidden layer using the V1 Macro.

network did not reach a minimum value within the 2000 cycles; a later training simulation found that this network reached the minimum MSE at 2265 training cycles. Table 3.6 provides a complete listing of each network's minimum MSE and the number of training cycles required to reach the minimum.

*Table 3.6:
V.1 Macro minimum MSE results and number of training cycles*

Network	Minimum MSE	# Training cycles
V1.2.06.2	2.26890 E-3	685
V1.2.06.4	4.41559 E-3	1375
V1.2.06.6	6.57322 E-3	2000 (2265)
V1.2.08.2	2.25664 E-3	795
V1.2.08.4	4.10530 E-3	1480
V1.2.08.6	3.41948 E-3	1540
V1.2.10.2	2.26328 E-3	875
V1.2.10.4	4.26277 E-3	1300
V1.2.10.6	4.83774 E-3	1750

In considering the cause of the increasing MSE, it was theorized that the V1 Macro's annealing process had reached a point where the decrease in network temperature was no longer assisting the network to reach its minimum energy, and that the steepening activation function was the cause of the increasing error.

To test this theory, a special macro was created that would anneal the network until the minimum MSE was detected, then hold the temperature at a fixed value and let the training continue. An untrained copy of the network 2.06.4 was selected, and the new training macro was executed for 2000 training cycles. The result was that at the point of minimum MSE a small jump in the MSE value was found as the temperature was being fixed, then the MSE characteristic continued to decrease as before. Figure 3.15 compares the portion of the V1.2.06.4 characteristic near the minimum MSE point to the new macro's results.

With this result found, it was decided that the next part of the research would compare the output results of the V1 Macro trained networks with two new sets

of trained networks; the first new set of networks would use the new macro that stops the annealing at the point of minimum MSE and continues learning, and a second set of networks would be trained to the point of minimum MSE. The training for these two sets of networks will now be described.

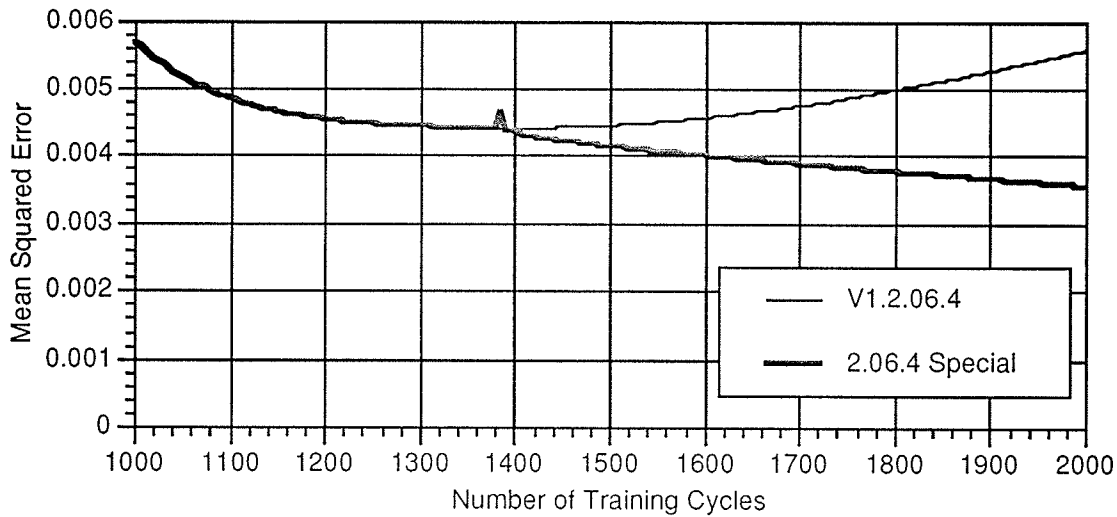

Figure 3.15:
Comparison of MSE Values for V1 and Special Macros

3.2.3 The V2 and V3 Macros

The special macro described earlier is called the V2 Macro; the flowchart for the macro shown in Figure 3.16, and the actual V2 Macro graphic can be found in Appendix A.

The V2 Macro is an extension of the V1 Macro. This new macro performs the following functions:

- Prompts the user for the number of training cycles to be executed (NUMCYCLES) and the initial temperature (TEMPERATURE) for the activation function.
- Executes the learning function identified by the Learn node.
- Performs a loop in the program (using the variables INCREMENT and TESTPER) that calculates the mean squared error, assigns it to the variable MSERROR, and writes it to a text window every 5 learning cycles. In the same loop the testing for the minimum MSE is

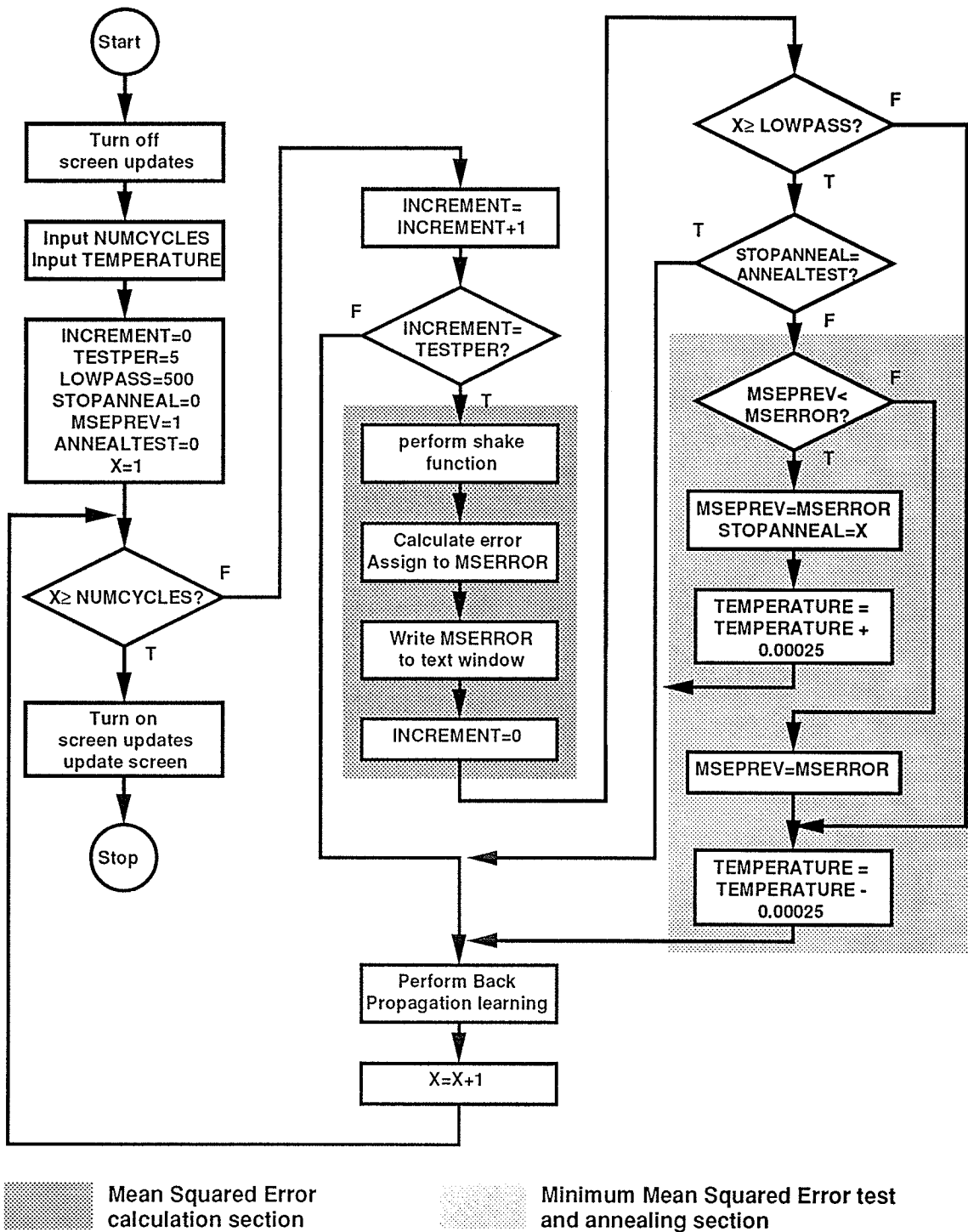

Figure 3.16:
Flowchart for the V2 Macro

performed and annealing the network is also performed. The macro starts to test for the minimum MSE after the number of training cycles is greater than the variable LOWPASS, which was set to a high value so that the initial MSE fluctuations would not cause the annealing to stop prematurely. The variable MSEPREV holds the previous value for the MSE, which is compared to the latest value stored in MSERROR. If MSERROR is lower, then its value is written to MSEPREV, the temperature is lowered, and the learning continues. If MSERROR is higher, MSERROR is written to MSEPREV, the temperature is increased to the value where the minimum MSE was determined, STOPANNEAL is assigned the value of X, and learning continues. By assigning the value of X to STOPANNEAL, the testing for minimum MSE is stopped at the point where STOPANNEAL is compared to ANNEALTEST.

- Performs various display housekeeping functions.
- Alerts the user when the simulation is complete.

The V3 Macro is the same as the V1 Macro. In order to train the networks up to the point of the minimum MSE, the value of NUMCYCLES for each of the networks was set to the number of training cycles to reach minimum MSE found during the previous training using the V1 Macro. For the V2 and V3 network training, the following parameters were used:

- | | |
|--------------------------------------|---|
| - NUMCYCLES (for V2 Macro): | 2000 |
| - NUMCYCLES (for V3 Macro): | See Table 3.6 |
| - Initial temperature (TEMPERATURE): | 0.2 |
| - Learning rate: | 0.2 |
| - Momentum: | 0.9 |
| - Method of updating: | Updating by group |
| - Learning rule: | Back Propagation
Batch with Momentum |

By performing the training of the networks up to 2000 cycles, similar relationships were found between the V1, V2, and V3 Macro trained networks; the one exception to this was the 2.06.6 networks, where the results for all

macros were the same since the function did not reach a point of minimum MSE. For this network to exhibit the same relationship to the others tested, the number of training cycles performed has to exceed the number of cycles required to reach the minimum MSE. Since the minimum value was reached at 2265, the V1 and V2 networks were trained with the value of NUMCYCLES set to 2500.

3.3 Analysis of the V1, V2, and V3 Macro results

A total of 9 network topologies using 3 different training methods were trained, resulting in a total of 27 trained networks. These networks were then compared with respect to how well they learned the target values of the training sets. A number of comparisons were performed on these networks, and these are described in this section.

3.3.1 Analysis of the individual network results

The Mean Squared Error value for each of the 27 trained networks were recorded; Table 3.7 compares these values for each of the macros tested. In all cases, the MSE values were lowest for the V2 Macro. This MSE value, however, does not give us any detailed information as to how the trained values compare to the target values of the training set. To provide a better analysis of the training, the set of trained output values was recorded for each network and compared to the training sets.

Table 3.7:
Comparison of MSE results for the V1, V2, and V3 Macros

Network	V1 Macro MSE	V2 Macro MSE	V3 Macro MSE
2.06.2	1.38996 E-2	2.12573 E-3	2.26890 E-3
2.06.4	5.58325 E-3	3.55090 E-3	4.41559 E-3
2.06.6	5.33428 E-2	4.79963 E-3	6.57322 E-3
2.08.2	1.21472 E-2	2.09814 E-3	2.25664 E-3
2.08.4	4.71355 E-2	2.83197 E-3	4.10530 E-3
2.08.6	4.47730 E-3	2.54631 E-3	3.41948 E-3
2.10.2	1.82580 E-2	2.14461 E-3	2.26328 E-3
2.10.4	5.22332 E-3	2.73264 E-3	4.26277 E-3
2.10.6	5.16670 E-3	3.56538 E-3	4.83774 E-3

3.3.1.1 Average and standard deviation results for the trained networks

In addition to the Mean Squared Error results, more detailed results from each trained network were recorded for analysis. The table for one of the trained networks (Network V1.2.06.4) is shown in Table 3.8 for illustration, and the tables for all 27 of the trained networks are provided on pages B.1 to B.27 of Appendix B. Each table represents the results of a trained network, and provides the difference of the target (actual) values minus measured (trained) values of each output neuron for all input patterns. In addition, the following additional information was calculated for each output neuron and the whole network:

- The average of the absolute value of the difference of target minus measured output values. This value provides the average magnitude of the difference between measured and target values. The smaller the average, the closer the trained values are to the target values for the whole network.
- The standard deviation of the absolute value of the difference of target minus measured output values. This value provides a measure of the variation of the difference values for the trained network. The smaller the standard deviation, the more consistent the trained values are to the target values.

3.3.1.2 Full and modified value results

In analysing the results of the training, it was found that the networks performed differently with respect to the missing input/output vector pair representing the node being trained. In some of the networks, the learning process trained the output neurons to produce a zero value. This success in learning a zero value was dependent on the number of hidden layer neurons in each trained network; the networks with 6 and 8 neurons per hidden layer learned smaller output values than the 10 neuron per hidden layer networks.

Table 3.8
Training Results for VI.2.06.4
(Network 2.06.4, VI Macro)

Destination	Neuron o1 (Route 5)			Neuron o2 (Route 8)		
	Target	Meas	Diff	Target	Meas	Diff
i1	0.3708	0.38696	-0.0162	0.3838	0.34123	0.04257
i2	0.6027	0.59431	0.00839	0.4619	0.45203	0.00987
i3	0.5031	0.49084	0.01226	0.3623	0.34667	0.01563
i4	0.3088	0.2663	0.0425	0.2418	0.23695	0.00485
i5	0.213	0.28783	-0.0748	0.3376	0.27743	0.06017
i6	0.5481	0.53388	0.01422	0.3776	0.36776	0.00984
i7	0.4084	0.33077	0.07763	0.2379	0.24452	-0.0066
i8	0.4225	0.26476	0.15774	0.1281	0.2078	-0.0797
i9		0.03653	-0.0365		0.02367	-0.0237
i10	0.6212	0.62441	-0.0032	0.3761	0.37954	-0.0034
i11	0.5181	0.5127	0.0054	0.273	0.28933	-0.0163
i12	0.5989	0.58511	0.01379	0.3045	0.31116	-0.0067
i13	0.7597	0.78442	-0.0247	0.4653	0.46794	-0.0026
i14	0.663	0.67004	-0.007	0.4179	0.41063	0.00727
i15	0.6536	0.67837	-0.0248	0.4085	0.38525	0.02325
i16	0.8046	0.79761	0.00699	0.5102	0.4862	0.024
Neuron Results	Average Diff (Full)		0.03289	Average Diff (Full)		0.02103
	Average Diff (Mod)		0.03264	Average Diff (Mod)		0.02086
	Std Dev Diff (Full)		0.04048	Std Dev Diff (Full)		0.02202
	Std Dev Diff (Mod)		0.04189	Std Dev Diff (Mod)		0.02278

Destination	Neuron o3 (Route 12)			Neuron o4 (Route 13)		
	Target	Meas	Diff	Target	Meas	Diff
i1	0.5985	0.59328	0.00522	0.8306	0.83464	-0.004
i2	0.6191	0.61651	0.00259	0.8512	0.83803	0.01317
i3	0.5195	0.5021	0.0174	0.7516	0.76498	-0.0134
i4	0.4565	0.44198	0.01452	0.6886	0.70348	-0.0149
i5	0.5523	0.53303	0.01927	0.7844	0.78615	-0.0018
i6	0.5072	0.49192	0.01528	0.7393	0.74378	-0.0045
i7	0.395	0.38908	0.00592	0.6271	0.64714	-0.02
i8	0.3428	0.34296	-0.0002	0.5749	0.58669	-0.0118
i9		0.02331	-0.0233		0.03318	-0.0332
i10	0.3884	0.38312	0.00528	0.6205	0.58901	0.03149
i11	0.2853	0.2917	-0.0064	0.5174	0.47513	0.04227
i12	0.1664	0.2295	-0.0631	0.3985	0.31962	0.07888
i13	0.3272	0.24207	0.08513	0.2377	0.24794	-0.0102
i14	0.3851	0.39052	-0.0054	0.6172	0.58445	0.03275
i15	0.2762	0.30626	-0.0301	0.5083	0.44889	0.05941
i16	0.3712	0.33132	0.03988	0.3929	0.43999	-0.0471
Neuron Results	Average Diff (Full)		0.02118	Average Diff (Full)		0.02618
	Average Diff (Mod)		0.02104	Average Diff (Mod)		0.02571
	Std Dev Diff (Full)		0.02362	Std Dev Diff (Full)		0.02193
	Std Dev Diff (Mod)		0.02445	Std Dev Diff (Mod)		0.02262

Network Results	Average Diff (Full)		0.02532	Std Dev Diff (Full)		0.02787
	Average Diff (Mod)		0.02506	Std Dev Diff (Mod)		0.02874

In studying the difference values associated with the missing input/output vector, it was found that this difference value was significantly larger than the difference values for the other training patterns. In order to remove the effect of the missing input/output vector from the average and standard deviation values discussed above, modified average and standard deviation values were calculated that removed the missing input/output vector results. Both the full and modified average and standard deviation values for each output neuron and the whole network are provided for all of the trained networks. These values will be used in the comparisons that follow.

3.3.1.3 Distribution of difference values

The average and standard deviation values described above provide a basis for comparison of the target and measured output values. However, there was also interest in the distribution of the difference values for each model. The difference values for each model were analysed and the following distribution counts were determined:

- The number of target and measured values with an absolute difference of less than 0.01;
- The number of target and measured values with an absolute difference greater than or equal to 0.01 and less than 0.02; and
- The number of target and measured values with an absolute difference greater than or equal to 0.02.

The values used for the count thresholds were arbitrarily chosen based on a review of the difference values. By studying the counts listed above, we could study the distribution of the difference values for each network and compare these distributions against other networks; the better networks would display larger counts in the smaller difference ranges and smaller counts in larger difference ranges. The counts were also calculated using the full and modified results to study the effect of the originating node and the missing input/output vector on these distributions. These counts will be used in the comparisons that follow.

3.3.1.4 Direct comparison of results between the different networks and macros

For the following comparisons the average, standard deviation, and distribution counts were prepared separately for each network and then compared to other networks. These comparisons do not directly compare the difference values of networks using the same training sets against networks using different numbers of hidden neurons per layer or networks using different macros. To provide these direct comparisons, the following counts were performed:

- A set of three networks is compared, and the best result (smallest absolute difference) for each measured output was determined and counted;
- After the best result for each measured output was determined, the difference results of the other networks were compared to it and counted if the difference between it and the best result was less than or equal to 0.01;
- After the best result for each measured output was determined, the difference results of the other networks were compared to it and counted if the difference between it and the best result was greater than 0.01.

By determining the best results of sets of trained networks, a method of direct comparison between the various models under study is provided. Better networks will display larger counts of best results and smaller counts of result values that were worse than the best results. Poorer networks will display smaller counts of best results and larger counts of result values that were worse than the best results. Two of the following comparisons will compare sets of networks versus different numbers of hidden neurons and versus different macros used for training.

3.3.2 Comparison #1 - description and results

Table 3.9 contains nine comparisons of trained networks. In each comparison

networks that were trained with the same macro and have the same number of output neurons were compared versus the number of neurons per hidden layer. For this comparison the difference distribution count for less than 0.01, the difference distribution count for greater than or equal to 0.02, the average of the absolute value of the difference, and the standard deviation of the absolute value of the difference are compared. The best results in each comparison are shaded.

In analysing the results of this comparison, no single network topology (6, 8, or 10 neurons per hidden layer) consistently provided the best results, but the 8 neuron per hidden layer topology performed better overall than the 6 or 10 neuron topologies by supplying the best results or close to the best results more often. The comparison of distribution counts showed that the originating node results consistently appeared in the highest count range, or the range where the absolute value of the difference was greater than or equal to 0.02.

In the V1 Macro trained networks, the difference in average and standard deviation values between the full and modified results was small for all network topologies. This showed that these networks learned the zero value result for the untrained originating node. In the V2 and V3 Macro comparisons, the modified average and standard deviation values were less than the values for the full set of results, with significant differences being found in the V2 and V3 Macro trained networks with 2 and 4 output nodes. This shows that the V2 and V3 Macros did not learn the untrained originating node's values to the same degree as the V1 Macro.

3.3.3 Comparison #2 - description and results

Table 3.10 contains nine comparisons of trained networks. In each comparison networks that were trained with the same network topology (number of output neurons and number of neuron per hidden layer) were compared versus the macro used for training. For this comparison the difference distribution count for less than 0.01, the difference distribution

Table 3.9
Comparison #1:
Average/Standard Deviation measurements and distribution counts
Comparison versus number of neurons per hidden layer

NN Model	Distribution Counts for X						Average of Diff		Std Deviation of Diff	
	X <.01		.01≤ X <.02		X ≥.02		Full	Mod	Full	Mod
	Full	Mod	Full	Mod	Full	Mod				
V1.2.06.2	8	8	4	4	20	18	0.05303	0.05358	0.06472	0.06688
V1.2.08.2	4	4	6	6	22	20	0.05765	0.05653	0.05782	0.05961
V1.2.10.2	2	2	5	5	25	23	0.0747	0.07258	0.06829	0.07007

V1.2.06.4	23	23	15	15	26	22	0.02532	0.02506	0.02787	0.02874
V1.2.08.4	11	11	23	23	30	26	0.02687	0.02556	0.02422	0.02428
V1.2.10.4	13	13	18	18	33	29	0.0304	0.02779	0.02684	0.02491

V1.2.06.6	21	21	18	14	57	55	0.02638	0.02686	0.01845	0.01895
V1.2.08.6	27	27	24	22	45	41	0.02094	0.02094	0.01693	0.01748
V1.2.10.6	24	24	26	26	46	40	0.02261	0.02238	0.01867	0.01927

NN Model	Distribution Counts for X						Average of Diff		Std Deviation of Diff	
	X <.01		.01≤ X <.02		X ≥.02		Full	Mod	Full	Mod
	Full	Mod	Full	Mod	Full	Mod				
V2.2.06.2	12	12	8	8	12	10	0.04579	0.0251	0.08402	0.02116
V2.2.08.2	11	11	6	6	15	13	0.04566	0.02482	0.08457	0.02117
V2.2.10.2	7	7	11	11	14	12	0.04545	0.0253	0.08196	0.02115

V2.2.06.4	22	22	19	19	23	19	0.03777	0.02027	0.07456	0.02202
V2.2.08.4	28	28	19	19	17	13	0.03923	0.0179	0.08956	0.02101
V2.2.10.4	29	29	15	15	20	16	0.04655	0.01762	0.11968	0.0195

V2.2.06.6	21	21	19	15	56	54	0.02638	0.02686	0.01845	0.01895
V2.2.08.6	36	36	29	28	31	26	0.02253	0.01569	0.02994	0.01354
V2.2.10.6	35	35	22	22	39	33	0.02189	0.01787	0.02262	0.01682

NN Model	Distribution Counts for X						Average of Diff		Std Deviation of Diff	
	X <.01		.01≤ X <.02		X ≥.02		Full	Mod	Full	Mod
	Full	Mod	Full	Mod	Full	Mod				
V3.2.06.2	7	7	8	8	17	15	0.04698	0.02657	0.08294	0.02119
V3.2.08.2	7	7	9	9	16	14	0.047	0.02659	0.08293	0.02105
V3.2.10.2	7	7	9	9	16	14	0.04622	0.02644	0.08058	0.02133

V3.2.06.4	23	23	12	12	29	25	0.04043	0.02358	0.07235	0.02412
V3.2.08.4	22	22	13	13	29	25	0.04388	0.02359	0.08596	0.02352
V3.2.10.4	22	22	12	12	30	26	0.05172	0.0237	0.11699	0.02366

V3.2.06.6	27	21	15	15	54	54	0.02683	0.02826	0.02026	0.02012
V3.2.08.6	36	36	27	27	33	27	0.02391	0.01752	0.03	0.0169
V3.2.10.6	26	26	20	20	50	44	0.02565	0.02215	0.02279	0.01883

*Table 3.10
Comparison #2:
Average/Standard Deviation measurements and distribution counts
Comparison versus training macro*

NN Model	Distribution Counts for X						Average of Diff		Std Deviation of Diff	
	X <.01		.01≤ X <.02		X ≥.02		Full	Mod	Full	Mod
	Full	Mod	Full	Mod	Full	Mod				
V1.2.06.2	8	8	4	4	20	18	0.05303	0.05358	0.06472	0.06688
V2.2.06.2	12	12	8	8	12	10	0.04579	0.0251	0.08402	0.02116
V3.2.06.2	7	7	8	8	17	15	0.04698	0.02657	0.08294	0.02119

V1.2.06.4	23	23	15	15	26	22	0.02532	0.02506	0.02787	0.02874
V2.2.06.4	22	22	19	19	23	19	0.03777	0.02027	0.07456	0.02202
V3.2.06.4	23	23	12	12	29	25	0.04043	0.02358	0.07235	0.02412

V1.2.06.6	21	21	18	14	57	55	0.02638	0.02686	0.01845	0.01895
V2.2.06.6	21	21	19	15	56	54	0.02638	0.02686	0.01845	0.01895
V3.2.06.6	27	21	15	15	54	54	0.02683	0.02826	0.02026	0.02012

NN Model	Distribution Counts for X						Average of Diff		Std Deviation of Diff	
	X <.01		.01≤ X <.02		X ≥.02		Full	Mod	Full	Mod
	Full	Mod	Full	Mod	Full	Mod				
V1.2.08.2	4	4	6	6	22	20	0.05765	0.05653	0.05782	0.05961
V2.2.08.2	11	11	6	6	15	13	0.04566	0.02482	0.08457	0.02117
V3.2.08.2	7	7	9	9	16	14	0.047	0.02659	0.08293	0.02105

V1.2.08.4	11	11	23	23	30	26	0.02687	0.02556	0.02422	0.02428
V2.2.08.4	28	28	19	19	17	13	0.03923	0.0179	0.08956	0.02101
V3.2.08.4	22	22	13	13	29	25	0.04388	0.02359	0.08596	0.02352

V1.2.08.6	27	27	24	22	45	41	0.02094	0.02094	0.01693	0.01748
V2.2.08.6	36	36	29	28	31	26	0.02253	0.01569	0.02994	0.01354
V3.2.08.6	36	36	27	27	33	27	0.02391	0.01752	0.03	0.0169

NN Model	Distribution Counts for X						Average of Diff		Std Deviation of Diff	
	X <.01		.01≤ X <.02		X ≥.02		Full	Mod	Full	Mod
	Full	Mod	Full	Mod	Full	Mod				
V1.2.10.2	2	2	5	5	25	23	0.0747	0.07258	0.06829	0.07007
V2.2.10.2	7	7	11	11	14	12	0.04545	0.0253	0.08196	0.02115
V3.2.10.2	7	7	9	9	16	14	0.04622	0.02644	0.08058	0.02133

V1.2.10.4	13	13	18	18	33	29	0.0304	0.02779	0.02684	0.02491
V2.2.10.4	29	29	15	15	20	16	0.04655	0.01762	0.11968	0.0195
V3.2.10.4	22	22	12	12	30	26	0.05172	0.0237	0.11699	0.02366

V1.2.10.6	24	24	26	26	46	40	0.02261	0.02238	0.01867	0.01927
V2.2.10.6	35	35	22	22	39	33	0.02189	0.01787	0.02262	0.01682
V3.2.10.6	26	26	20	20	50	44	0.02565	0.02215	0.02279	0.01883

count for greater than or equal to 0.02 , the average of the absolute value of the difference, and the standard deviation of the absolute value of the difference are compared. The best results in each comparison are shaded.

In this comparison, the V2 Macro trained networks consistently performed better than the V1 and V3 Macro trained networks. This was most evident in the modified results, where the V2 trained networks provided the best result or tied with the best result in 34 of the 36 comparisons. This demonstrated that the V2 Macro trained networks performed the best learning of the target values.

3.3.4 Comparison #3 - description and results

Table 3.11 contains nine comparisons of trained networks. Each comparison directly compared the measured output values of networks that were trained with the same macro and have the same number of output neurons versus the number of neurons per hidden layer. For this comparison the best result count, and the count for results greater than 0.01 than the best result were compared. The best results in each comparison are shaded.

The results of this comparison are very similar to those of Comparison #1; no single network topology consistently produced the best results in learning the target values. Once again, the 8 neuron per hidden layer topology performed best overall, producing either the best or close to the best results in most of the comparisons.

3.3.5 Comparison #4 - description and results

Table 3.12 contains nine comparisons of trained networks. Each comparison directly compared the measured output values of networks that were trained with the same network topology (number of output neurons and number of neuron per hidden layer) versus the training macro used. For this

Table 3.11
Comparison #3:
Direct comparison of difference values
Comparison versus number of neurons per hidden layer

NN Model	Counts - V1 Macro					
	Best Result		Result ≤Best+.01		Result >Best+.01	
	Full	Mod	Full	Mod	Full	Mod
V1.2.06.2	23	21	0	0	9	9
V1.2.08.2	1	1	15	15	16	14
V1.2.10.2	8	8	6	6	18	16

V1.2.06.4	29	25	20	20	15	15
V1.2.08.4	19	19	28	27	17	14
V1.2.10.4	16	16	21	21	27	23

V1.2.06.6	26	21	25	24	45	45
V1.2.08.6	36	34	32	28	28	28
V1.2.10.6	32	32	28	24	36	34

NN Model	Counts - V2 Macro					
	Best Result		Result ≤Best+.01		Result >Best+.01	
	Full	Mod	Full	Mod	Full	Mod
V2.2.06.2	8	8	24	22	0	0
V2.2.08.2	15	15	15	15	2	0
V2.2.10.2	10	8	22	22	0	0

V2.2.06.4	16	12	36	36	12	12
V2.2.08.4	26	26	31	30	7	4
V2.2.10.4	22	22	37	37	5	1

V2.2.06.6	30	24	20	20	46	46
V2.2.08.6	38	38	30	30	28	22
V2.2.10.6	29	29	34	34	33	27

NN Model	Counts - V3 Macro					
	Best Result		Result ≤Best+.01		Result >Best+.01	
	Full	Mod	Full	Mod	Full	Mod
V3.2.06.2	10	10	19	18	3	2
V3.2.08.2	9	9	19	19	4	2
V3.2.10.2	14	12	16	16	2	2

V3.2.06.4	32	28	25	25	7	7
V3.2.08.4	15	15	38	37	11	8
V3.2.10.4	17	17	34	34	13	9

V3.2.06.6	33	27	15	15	48	48
V3.2.08.6	44	44	27	27	25	19
V3.2.10.6	19	19	36	36	41	35

Table 3.12
Comparison #4:
Direct comparison of difference values
Comparison versus training macro

NN Model	Counts - 6 neurons per hidden layer					
	Best Result		Result ≤Best+.01		Result >Best+.01	
	Full	Mod	Full	Mod	Full	Mod
V1.2.06.2	11	9	7	7	14	14
V2.2.06.2	14	14	11	11	7	5
V3.2.06.2	7	7	17	17	8	6

V1.2.06.4	28	24	20	20	16	16
V2.2.06.4	26	26	22	22	16	12
V3.2.06.4	10	10	30	30	24	20

V1.2.06.6	51	51	24	24	21	15
V2.2.06.6	51	51	24	24	21	15
V3.2.06.6	45	39	25	25	26	26

NN Model	Counts - 8 neurons per hidden layer					
	Best Result		Result ≤Best+.01		Result >Best+.01	
	Full	Mod	Full	Mod	Full	Mod
V1.2.08.2	10	8	3	3	19	19
V2.2.08.2	15	15	11	11	6	4
V3.2.08.2	8	8	15	15	9	7

V1.2.08.4	20	16	17	17	27	27
V2.2.08.4	27	27	23	23	14	10
V3.2.08.4	17	17	16	16	31	27

V1.2.08.6	20	14	44	44	32	32
V2.2.08.6	43	43	33	33	20	14
V3.2.08.6	34	34	33	33	29	23

NN Model	Counts - 10 neurons per hidden layer					
	Best Result		Result ≤Best+.01		Result >Best+.01	
	Full	Mod	Full	Mod	Full	Mod
V1.2.10.2	6	4	3	3	23	23
V2.2.10.2	15	15	12	12	5	3
V3.2.10.2	11	11	13	13	8	6

V1.2.10.4	18	14	18	18	28	28
V2.2.10.4	32	32	20	20	12	8
V3.2.10.4	15	15	22	22	27	23

V1.2.10.6	32	26	30	30	34	34
V2.2.10.6	49	49	28	28	19	13
V3.2.10.6	16	16	40	40	40	34

comparison the best result count, and the count for results greater than 0.01 than the best result were compared. The best results in each comparison are shaded.

The results of this comparison are very similar to those of Comparison #2; in almost all cases, the V2 Macro trained networks produced better results than the V1 and V3 Macro trained networks. In comparing the modified results the V2 Macro provided the best results in all 18 comparisons.

3.3.6 Summary of conclusions from Comparisons 1 to 4

Comparisons #2 and #4 conclude that the V2 Macro trained networks produced the best trained networks of the three macros used in the simulations. If Comparisons #1 and #3 are revisited with the focus on the V2 Macro trained comparisons, analysis of these comparisons demonstrates that the 8 neuron per hidden layer network topology provided the best overall performance in learning the target values. In Comparison #3, the 8 neuron topology provided the best results in 5 of the 6 comparisons using the modified results. Similarly, in Comparison #1 the 8 neuron topology provided the best or near best results of the three topologies when comparing the full and modified difference distribution counts. In comparing the average and standard deviation values there was little variation in the results of all three topologies, with the 8 neuron topology again producing the best or near best results.

Another conclusion from the comparisons was that it was useful to consider the effect of the originating node on the training of the network. The untrained node does affect the learning of the networks; at the end of this thesis some recommendations will be made for further research in this area.

Based on the comparisons performed above, networks using the 8 neuron per hidden layer topology and the V2 Macro produced the best results for the range of output neurons configurations tested.

3.3.7 Comparison of the routing results of the trained networks

In the comparisons performed above, the results of each trained network were judged as to how close the measured output values were to the target values. Our conclusions from these comparisons were that the V2 Macro trained networks performed best, and that the 8 node per hidden layer networks provided the best overall performance, though this result was not as clear as the macro comparisons. While this is an important part of this study, the ultimate goal of the research is to determine how well each network is able to perform a routing function. To perform a basic routing decision, the trained network is not required to exactly learn the target values; it is only required that the target values be learned to the degree that the ranking sequence of each output neuron in relation to the other output neurons can be determined. The next comparison evaluates the performance of the trained networks in determining these rankings.

As stated earlier, each output vector in a training set represents the routing information from an originating node to a particular destination node. The routing information consists of time based values, and each output neuron's value is compared or ranked against the other output values to determine the best route. If, as a result of training, the learned values are close enough to the actual values of the training set, then the routing sequences are learned and can be extracted from the network. However, if the difference between an actual and learned output value is sufficiently large, then this error can cause the output value to be larger or smaller than the learned output values of adjacent higher or lower ranked outputs, and a routing mismatch could occur.

Tables 3.13, 3.14, and 3.15 compare the routing results of V2 Macro trained networks for 2, 4, and 6 output nodes respectively. The routing results compare the performance of the networks versus the number of neurons per hidden layer. The V2 Macro trained networks were chosen for comparison because of the performance of the V2 Macro against the other macros in earlier comparisons. In each table the target rankings for each training set are provided, with rank 1 as the smallest value, rank 2 as the second smallest, up to 6 for the 6 output node networks. The measured rankings from each network

Table 3.13:
Comparison of target rankings to trained rankings
of 2 output neuron networks using the V2 Macro.

Destination Node	Target Rankings		V2.2.06.2 Rankings		Actual - Measured		V2.2.08.2 Rankings		Actual - Measured		V2.2.10.2 Rankings		Actual - Measured	
	o1	o2	o1	o2	o1	o2	o1	o2	o1	o2	o1	o2	o1	o2
i1	1	2	1	2			1	2			1	2		
i2														
i3	1	2	1	2			1	2			1	2		
i4	1	2	1	2			1	2			1	2		
i5	1	2	1	2			1	2			1	2		
i6	2	1	1	2	1	-1	1	2	1	-1	1	2	1	-1
i7	1	2	1	2			1	2			1	2		
i8	1	2	1	2			1	2			1	2		
i9	1	2	1	2			1	2			1	2		
i10	2	1	1	2	1	-1	1	2	1	-1	1	2	1	-1
i11	1	2	1	2			1	2			1	2		
i12	1	2	1	2			1	2			1	2		
i13	1	2	1	2			1	2			1	2		
i14	2	1	1	2	1	-1	1	2	1	-1	1	2	1	-1
i15	2	1	1	2	1	-1	1	2	1	-1	1	2	1	-1
i16	2	1	2	1			2	1			1	2	1	-1

Table 3.14:
 Comparison of target rankings to trained rankings
 for 4 output neuron networks using the V2 Macro

Destination Node	Target Rankings				V2.2.06.4 Rankings				Actual - Measured				V2.2.08.4 Rankings				Actual - Measured				V2.2.10.4 Rankings				Actual - Measured			
	o1	o2	o3	o4	o1	o2	o3	o4	o1	o2	o3	o4	o1	o2	o3	o4	o1	o2	o3	o4	o1	o2	o3	o4	o1	o2	o3	o4
i1	1	2	3	4	2	1	3	4	-1	1			2	1	3	4	-1	1			2	1	3	4	-1	1		
i2	2	1	3	4	2	1	3	4					2	1	3	4					2	1	3	4				
i3	2	1	3	4	3	1	2	4	-1		1		2	1	3	4					2	1	3	4				
i4	2	1	3	4	2	1	3	4					2	1	3	4					2	1	3	4				
i5	1	2	3	4	1	2	3	4					1	2	3	4					1	2	3	4				
i6	3	1	2	4	3	1	2	4					3	1	2	4					3	1	2	4				
i7	3	1	2	4	3	1	2	4					3	1	2	4					3	1	2	4				
i8	3	1	2	4	3	1	2	4					3	1	2	4					3	1	2	4				
i9																												
i10	4	1	2	3	4	1	2	3					4	1	2	3					4	1	2	3				
i11	4	1	2	3	4	1	2	3					4	1	2	3					4	1	2	3				
i12	4	2	1	3	4	2	1	3					4	2	1	3					4	2	1	3				
i13	4	3	2	1	4	3	1	2			1	-1	4	3	2	1					4	3	2	1				
i14	4	2	1	3	4	2	1	3					4	2	1	3					4	2	1	3				
i15	4	2	1	3	4	2	1	3					4	2	1	3					4	2	1	3				
i16	4	3	1	2	4	3	1	2					4	3	1	2					4	3	1	2				

Table 3.15:
Comparison of target rankings to trained rankings
of 6 output neuron networks using the V2 Macro

Destination Node	Target Rankings						V2.2.06.6 Rankings						Actual - Measured						V2.2.08.6 Rankings						Actual - Measured					
	o1	o2	o3	o4	o5	o6	o1	o2	o3	o4	o5	o6	o1	o2	o3	o4	o5	o6	o1	o2	o3	o4	o5	o6	o1	o2	o3	o4	o5	o6
i1	1	2	3	4	5	6	1	3	2	5	4	6		1	1	1	1													
i2	1	3	2	6	4	5	1	4	2	6	3	5		1				1												
i3	1	3	2	5	4	6	1	2	3	4	5	6		1	1	1	1													
i4	1	2	4	3	6	5	1	2	3	4	5	6			1	1	1	1												
i5	1	2	4	3	6	5	1	2	4	3	6	5																		
i6	2	4	1	6	3	5	2	4	1	6	3	5																		
i7	1	2	3	4	5	6	1	2	3	4	5	6																		
i8	2	1	5	3	6	4	2	1	5	3	6	4																		
i9	3	1	6	2	5	4	2	1	5	3	6	4		1		1	1	1												
i10	3	6	1	5	2	4	3	6	1	5	2	4																		
i11																														
i12	5	3	6	1	4	2	5	3	6	1	4	2																		
i13	5	3	6	1	4	2	5	3	6	1	4	2																		
i14	5	6	2	4	1	3	5	6	3	4	1	2			1															
i15	6	5	4	2	3	1	6	5	4	2	3	1																		
i16	6	5	4	2	3	1	6	5	4	2	3	1																		

Destination Node	Target Rankings						V2.2.10.6 Rankings						Actual - Measured																
	o1	o2	o3	o4	o5	o6	o1	o2	o3	o4	o5	o6	o1	o2	o3	o4	o5	o6											
i1	1	2	3	4	5	6	1	2	3	4	5	6																	
i2	1	3	2	6	4	5	2	4	1	6	3	5		1	1	1		1											
i3	1	3	2	5	4	6	1	3	2	5	4	6																	
i4	1	2	4	3	6	5	1	2	4	3	6	5																	
i5	1	2	4	3	6	5	1	2	5	3	6	4			1														
i6	2	4	1	6	3	5	2	4	1	6	3	5																	
i7	1	2	3	4	5	6	1	2	3	4	5	6																	
i8	2	1	5	3	6	4	1	2	5	3	6	4		1	1														
i9	3	1	6	2	5	4	3	2	6	1	5	4			1														
i10	3	6	1	5	2	4	4	6	1	5	2	3		1															
i11																													
i12	5	3	6	1	4	2	5	3	6	1	4	2																	
i13	5	3	6	1	4	2	4	3	6	1	5	2		1															
i14	5	6	2	4	1	3	5	6	2	4	1	3																	
i15	6	5	4	2	3	1	6	5	4	2	3	1																	
i16	6	5	4	2	3	1	6	5	4	1	3	2				1													

are also provided, and the difference of actual ranking versus measured ranking. No difference value (a difference of zero) means that the network learned the correct ranking for the output. If the difference is a positive value, the network learned an output ranking that is lower in value than the actual rank; if the difference is negative, the network learned an output ranking that is higher in value than the actual rank. The ranking mismatches and corresponding difference values are shaded.

In studying the results, it was found that all networks were trained to a level where the difference between measured and actual output ranking was never more than 1 or less than -1; this means that at most a routing mismatch transposed the rankings of two outputs. In addition, the 8 neuron per hidden layer networks performed the best in learning the routing sequences, having the fewest mismatches in each comparison and overall. Table 3.16 provides a summary of routing performance for each network topology.

The results in the table agree with the general conclusions drawn from the previous comparisons. Based on these results, it was found that the 8 neuron per hidden layer networks using the V2 Macro best performed the functions of learning training sets for routing purposes.

*Table 3.16:
Comparison of routing performance versus number of neurons per hidden layer*

Item	6 neurons	8 neurons	10 neurons
Mismatches - 2 outputs	8	8	10
Mismatches - 4 outputs	6	2	2
Mismatches - 6 outputs	20	8	16
Total mismatches (out of 180)	34	18	28
Total correct matches (out of 180)	146	162	152
Percent correct matches	81%	90%	84%

3.3.8 Modification of the training set

As demonstrated in the above results, the neural networks are able to perform

routing decisions with a 90% accuracy. If routing decisions were being performed strictly for the purposes determining a restoration route for a failed or lost link in a network, then the level of accuracy is higher. In the case of performing restoration routing, mismatches between outputs with ranks 1 and 2 are not a concern; if a link with actual rank 1 and learned rank 2 fails and has to be restored, restoration would occur on a link that has an actual rank of 2 and learned rank of 1. Despite the mismatch, the alternate link still has a lower ranking than the rest of the alternative links. If mismatches between rank 1 and 2 were ignored, the accuracy of the 8 neuron per hidden layer networks exceeds 99%.

If, however, the network will be used to perform more complex routing decisions than just restoration, a higher level of accuracy is required. The work done to this point has determined optimal parameters for both the network topology and the training macros; in order to further increase the accuracy, we must look at other factors. One of these is the training set.

In reviewing the training sets used, it was found that some output values in a given output vector were very close in value; this would represent links with almost equivalent routing times. If in the course of learning the target values the error in learning is greater than the small difference between two close output values, then a routing mismatch would occur. If the difference between these target values were greater, then the effect of the errors produced by learning could be reduced. To test this statement, it was decided that modifying the training set should be tested.

There are several different ways that the training set could be modified. One possible method is to perform further scaling of the data like that initially performed when creating the training sets. The problem with this approach, however, was that a complete training set already used most of the range of values between 0 and 1, and that the incremental benefit of scaling performed on the entire training set would be small. In order to provide better scaling, each output vector in the training set would have to be scaled separately. Scaling of each output vector would allow for greater separation of close output values, but even this may not be able to help in cases where the

difference between target values can be as small as 0.001.

An alternative approach to simple scaling would be to both scale and quantize the output values. In this case, the target values within each vector are ranked, and a quantized value is created for each value based on the ranking. By quantizing the output values, the real value separation of output values no longer affects the learning, and should result in fewer mismatches. There are several formulas that could be used to quantize these values, but the one decided upon was the following:

$$\text{Quantized value} = \frac{1}{2n} + \frac{r-1}{n}$$

Where

- r is the rank of output, and
- n is the number of output neurons (the node valence)

This formula provides a equal spacing of the target values through the range of 0 and 1 of $1/n$, with the lowest and highest ranked values separated from 0 and 1 by $1/2n$; this spacing from the ends of the value range results in the network not having to learn training values at the extreme ends of the activation range. Table 3.17 provides a list of the quantization levels for different values of n .

*Table 3.17:
Quantized output values for different values of n*

n	Quantized output levels
2	0.25, 0.75
3	0.1666, 0.5, 0.8333
4	0.125, 0.375, 0.625, 0.875
5	0.1, 0.3, 0.5, 0.7, 0.9
6	0.0833, 0.25, 0.4166, 0.5833, 0.75, 0.9166

3.3.9 Comparison of the initial and modified training set networks

Using the formula above, the training sets used for the network testing were modified; these modified training sets can be found on pages B.28 to B.30 of Appendix B. Neural networks consisting of 2, 4, and 6 output neurons and 8 neurons per hidden layer were trained using the modified training set, and the detailed tables of learning results were created; these tables can be found on pages B.31 to B.33 of Appendix B.

The learning performance of the modified training set networks was compared to the networks trained with the original training set. The six networks were compared in the following areas: mean squared error; average and standard deviation of the absolute value of the difference values; distribution of the absolute value of the difference values; and routing performance.

Table 3.18 shows the mean squared error results for the 6 networks. In this comparison, networks with 4 and 6 output neurons had lower MSE values with the original training set than the modified training set networks, showing that these networks learned the real output values better than the modified values. The 2 output neuron networks results were the reverse of the 4 and 6 output neurons results, showing a very high level of learning. In this case, the networks trained with the modified values may actually have memorized the output values, given the small number of output possibilities.

*Table 3.18:
Comparison of MSE results for networks using original and modified training sets*

Network	MSE (original)	MSE (modified)
V2.2.08.2	2.09814 E-3	1.90260 E-5
V2.2.08.4	2.83197 E-3	5.47008 E-3
V2.2.08.6	2.54631 E-3	1.372125 E-2

Table 3.19 shows the comparison of the difference distribution count for less

than 0.01, the difference distribution count for greater than or equal to 0.02, the average of the absolute value of the difference, and the standard deviation of the absolute value of the difference between networks trained with the original and modified training sets. These comparisons show that for the 2 output neuron networks the modified training produced very precise learning, but for the larger networks the original training set produced better results. This comparison agrees with the MSE results found above.

*Table 3.19:
Neural Network Model Test Results:
Average/Standard Deviation measurements and distribution counts
Comparison of V2 trained networks using real and modified training sets*

NN Model	Distribution Counts for $ X $						Average of $ Diff $		Std Deviation of $ Diff $	
	$X < .01$		$.01 \leq X < .02$		$X \geq .02$		Full	Mod	Full	Mod
	Full	Mod	Full	Mod	Full	Mod				
V2.2.08.2	11	11	6	6	15	13	0.04566	0.02482	0.08457	0.02117
V2.08.2(M)	30	30	0	0	2	0	0.02928	0.00236	0.10592	0.00211
V2.2.08.4	28	28	19	19	17	13	0.03923	0.0179	0.08956	0.02101
V2.2.08.4(M)	17	17	15	15	32	28	0.03248	0.0277	0.03307	0.0247
V2.2.10.6	36	36	29	28	31	26	0.02253	0.01569	0.02994	0.01354
V2.2.10.6(M)	9	9	13	13	74	68	0.04062	0.04084	0.02444	0.02509

The comparisons made above show that the original training set networks performed better at learning the output values of the training sets. But how do the networks compare in the learning of the rankings of the outputs? Tables 3.20, 3.21, and 3.22 compare the routing results of the original and modified training set networks. These comparisons show that the modified training set networks learned the routing rankings better than the original training set, producing only 2 routing mismatches out of 180 output rankings. The probable reason for the improved performance in ranking is due to the scaling and quantizing of target output values; the original training set networks learned the actual values better, but the separation of the output values in the modified training sets was larger than the learning errors introduced by modifying the values.

3.4 Conclusions from single network node modelling

Based on the limited amount of testing performed, the conclusions made from the research are as follows:

- The four layer feed forward network, back propagation learning rule, and continuous sigmoidal function were appropriate testing choices for the learning task.
- A learning process involving annealing of the network until reaching minimum mean squared error, followed by further learning with the temperature held constant, provided the best learning results.
- 8 neuron per hidden layer networks performed best overall when applied to learning tasks involving networks with a range of 2 to 6 output neurons
- Scaling and quantizing of output values in the training sets produced networks that perform routing decisions better than networks with unscaled and unquantized values.

Table 3.20:
V2 Macro 2 Output Neuron Routing Comparison - real vs. modified training set

Destination Node	Target Rankings		V2.2.08.2 Ranking		Actual - Measured		V2.2.08.2(M) Ranking		Actual - Measured	
	o1	o2	o1	o2	o1	o2	o1	o2	o1	o2
i1	1	2	1	2			1	2		
i2										
i3	1	2	1	2			1	2		
i4	1	2	1	2			1	2		
i5	1	2	1	2			1	2		
i6	2	1	1	2	1	-1	2	1		
i7	1	2	1	2			1	2		
i8	1	2	1	2			1	2		
i9	1	2	1	2			1	2		
i10	2	1	1	2	1	-1	2	1		
i11	1	2	1	2			1	2		
i12	1	2	1	2			1	2		
i13	1	2	1	2			1	2		
i14	2	1	1	2	1	-1	2	1		
i15	2	1	1	2	1	-1	2	1		
i16	2	1	2	1			2	1		

Table 3.21:
V2 Macro 4 Output Neuron Routing Comparison - real vs. modified training set

Destination Node	Target Rankings				V2.2.08.4 Ranking				Actual - Measured				V2.2.08.4(M) Ranking				Actual - Measured			
	o1	o2	o3	o4	o1	o2	o3	o4	o1	o2	o3	o4	o1	o2	o3	o4	o1	o2	o3	o4
i1	1	2	3	4	2	1	3	4	-1	1			1	2	3	4				
i2	2	1	3	4	2	1	3	4					2	1	3	4				
i3	2	1	3	4	2	1	3	4					2	1	3	4				
i4	2	1	3	4	2	1	3	4					2	1	3	4				
i5	1	2	3	4	1	2	3	4					1	2	3	4				
i6	3	1	2	4	3	1	2	4					3	1	2	4				
i7	3	1	2	4	3	1	2	4					3	1	2	4				
i8	3	1	2	4	3	1	2	4					3	1	2	4				
i9																				
i10	4	1	2	3	4	1	2	3					4	1	2	3				
i11	4	1	2	3	4	1	2	3					4	1	2	3				
i12	4	2	1	3	4	2	1	3					4	2	1	3				
i13	4	3	2	1	4	3	2	1					4	3	2	1				
i14	4	2	1	3	4	2	1	3					4	2	1	3				
i15	4	2	1	3	4	2	1	3					4	2	1	3				
i16	4	3	1	2	4	3	1	2					4	3	1	2				

Table 3.22:
V2 Macro 6 Output Neuron Routing Comparison - real vs. modified training set

Dest Node	Target Rankings						V2.2.08.6 Rankings						Actual - Measured						V2.2.08.6(M) Rankings						Actual - Measured						
	o1	o2	o3	o4	o5	o6	o1	o2	o3	o4	o5	o6	o1	o2	o3	o4	o5	o6	o1	o2	o3	o4	o5	o6	o1	o2	o3	o4	o5	o6	
i1	1	2	3	4	5	6	1	2	3	4	5	6							1	2	3	4	5	6							
i2	1	3	2	6	4	5	2	4	1	6	3	5	-1	-1	1		1		1	3	2	6	4	5							
i3	1	3	2	5	4	6	1	3	2	5	4	6								1	3	2	5	4	6						
i4	1	2	4	3	6	5	1	2	4	3	6	5								1	2	4	3	6	5						
i5	1	2	4	3	6	5	1	2	4	3	6	5								1	2	4	3	6	5						
i6	2	4	1	6	3	5	2	4	1	6	3	5								2	4	1	6	3	5						
i7	1	2	3	4	5	6	1	2	3	4	5	6								1	2	3	4	5	6						
i8	2	1	5	3	6	4	2	1	5	3	6	4								2	1	5	3	6	4						
i9	3	1	6	2	5	4	3	2	6	1	5	4	-1		1					3	1	6	2	5	4						
i10	3	6	1	5	2	4	3	6	1	5	2	4								3	6	1	5	2	4						
i11																															
i12	5	3	6	1	4	2	5	3	6	1	4	2								5	3	6	1	4	2						
i13	5	3	6	1	4	2	5	3	6	1	4	2								5	3	6	1	4	2						
i14	5	6	2	4	1	3	5	6	2	4	1	3								5	6	2	4	1	3						
i15	6	5	4	2	3	1	6	5	4	2	3	1								6	5	4	2	3	1						
i16	6	5	4	2	3	1	6	5	4	1	3	2			1					6	5	4	2	3	1						

Chapter 4

Full Network Modelling

In this chapter the neural network topology, learning method, and modified training set identified in the previous chapter are applied to the full sample network, and the routing results determined. The neural networks are then tested to evaluate their ability to perform routing decisions related to different routing scenarios common in telecommunications networks. The chapter concludes with testing of the ability of the trained neural networks to perform generalized routing decisions, and a discussion of the results.

4.1 Full network simulation results

Using the findings of the single node research, the remaining 13 nodes of the sample network were simulated to study the routing performance of the trained networks for the entire sample network. For each network node the following activities were performed:

- The routing information and routing rankings for each node was determined.
- The ranking information was used to create the modified training set based on the formula used in the single node modelling.
- A neural network was created with 8 neurons per hidden layer and the required number of neurons for the output layer.
- The neural network was trained using the V2 Macro. The settings used for training were as per the single node research, but the number of training cycles was increased to 3000 to ensure the networks would have enough cycles to reach the point where the annealing process is stopped.
- The output values of the trained networks were recovered and the output rankings determined.
- The target rankings and measured rankings were compared.

Table 4.1 shows the information and results determined in the simulation of node 12 of the sample network. The results for all network nodes can be found on pages C.1 to C.16 of Appendix C. The upper half of Table 4.1 show the actual routing values, the target rankings derived from this routing information, and the target training values used for the simulation. The bottom half of Table 4.1 shows the measured values recovered after simulation, and measured rankings produced from the values, and the comparison of actual and measured rankings. Routing mismatches have been shaded for presentation purposes to highlight their occurrence. A review of the sample network results shows that eight routing mismatches occurred out of 990 routing rankings. This performance translates into a routing accuracy of 99.19% for the overall network. Two pairs of routing mismatches occurred in Sample Network nodes with 5 links (one each in Nodes 6 and 7) and two pairs of routing mismatches occurred in sample network nodes with 6 links (one each in Nodes 11 and 12).

The occurrence of the routing mismatches suggests that neural networks with larger number of output neurons are more susceptible to routing mismatches; these networks have smaller quantization steps between the modified output values, and would be the more sensitive to mismatches caused by large learning errors. In addition, the mismatches occurred with the highest ranked or lowest ranked outputs, at the extremes of the output value range. This suggests that the network had difficulty learning the target values at the extremes of the value range, and a review of the measured values shows large errors in the mismatched outputs that resulted in the transposition of the output rankings. No routing mismatches occurred in sample network nodes with 4 or less links; Table 4.2 provides the details of the routing performance for the complete Sample Network and for the sets of nodes with equal numbers of links.

4.2 Performing routing decisions

When performing a routing decision, the goal is to select the best route that meets the routing criteria. The criteria used throughout this thesis has been

Table 4.1:
Routing Results for Node 12
of the Sample Network

Destination Node	Real Output Values						Target Rankings						Target Values					
	o1	o2	o3	o4	o5	o6	o1	o2	o3	o4	o5	o6	o1	o2	o3	o4	o5	o6
i1	0.45707	0.5122	0.49518	0.7443	0.61257	0.8058	1	3	2	5	4	6	0.08333	0.41667	0.25	0.75	0.58333	0.91667
i2	0.53518	0.60328	0.47765	0.83538	0.58302	0.85926	2	4	1	5	3	6	0.25	0.58333	0.08333	0.75	0.41667	0.91667
i3	0.43563	0.50373	0.3781	0.73583	0.50449	0.78073	2	3	1	5	4	6	0.25	0.41667	0.08333	0.75	0.58333	0.91667
i4	0.31507	0.38317	0.35318	0.61527	0.47957	0.75581	1	3	2	5	4	6	0.08333	0.41667	0.25	0.75	0.58333	0.91667
i5	0.41088	0.3544	0.44899	0.5865	0.57538	0.7866	2	1	3	5	4	6	0.25	0.08333	0.41667	0.75	0.58333	0.91667
i6	0.45086	0.51896	0.36584	0.75106	0.45072	0.72696	3	4	1	6	2	5	0.41667	0.58333	0.08333	0.91667	0.25	0.75
i7	0.31116	0.37926	0.25363	0.61136	0.38002	0.65626	2	3	1	5	4	6	0.25	0.41667	0.08333	0.75	0.58333	0.91667
i8	0.2014	0.2695	0.28877	0.5016	0.41516	0.6914	1	2	3	5	4	6	0.08333	0.25	0.41667	0.75	0.58333	0.91667
i9	0.3045	0.16664	0.39187	0.3985	0.51826	0.5986	2	1	3	4	5	6	0.25	0.08333	0.41667	0.58333	0.75	0.91667
i10	0.4494	0.5175	0.24697	0.7496	0.37336	0.6496	3	4	1	6	2	5	0.41667	0.58333	0.08333	0.91667	0.25	0.75
i11	0.3463	0.4144	0.14387	0.6465	0.27026	0.5465	3	4	1	6	2	5	0.41667	0.58333	0.08333	0.91667	0.25	0.75
i12																		
i13	0.5172	0.3791	0.60457	0.1858	0.47026	0.3859	5	2	6	1	4	3	0.75	0.25	0.91667	0.08333	0.58333	0.41667
i14	0.4912	0.5593	0.28877	0.63026	0.24372	0.51996	3	5	2	6	1	4	0.41667	0.75	0.25	0.91667	0.08333	0.58333
i15	0.4818	0.5499	0.27937	0.5213	0.13476	0.411	4	6	2	5	1	3	0.58333	0.91667	0.25	0.75	0.08333	0.41667
i16	0.6621	0.5343	0.45967	0.341	0.31506	0.2307	6	5	4	3	2	1	0.91667	0.75	0.58333	0.41667	0.25	0.08333

Destination Node	Measured Values						Measured Rankings						Actual-Measured					
	o1	o2	o3	o4	o5	o6	o1	o2	o3	o4	o5	o6	o1	o2	o3	o4	o5	o6
i1	0.19548	0.36473	0.197	0.74489	0.60116	0.92454	1	3	2	5	4	6	0	0	0	0	0	0
i2	0.27181	0.54748	0.03897	0.84124	0.41962	0.86873	2	4	1	5	3	6	0	0	0	0	0	0
i3	0.1436	0.44557	0.11997	0.75747	0.57096	0.9185	2	3	1	5	4	6	0	0	0	0	0	0
i4	0.1339	0.35038	0.27605	0.75306	0.59348	0.92475	1	3	2	5	4	6	0	0	0	0	0	0
i5	0.22657	0.10704	0.41498	0.67157	0.66785	0.92313	2	1	3	5	4	6	0	0	0	0	0	0
i6	0.41772	0.60666	0.07215	0.86718	0.25233	0.76409	3	4	1	6	2	5	0	0	0	0	0	0
i7	0.14266	0.44432	0.12045	0.75967	0.57212	0.91871	2	3	1	5	4	6	0	0	0	0	0	0
i8	0.13505	0.3019	0.38581	0.72786	0.57733	0.921	1	2	3	5	4	6	0	0	0	0	0	0
i9	0.23089	0.09885	0.42515	0.65951	0.66708	0.92139	2	1	3	4	5	6	0	0	0	0	0	0
i10	0.41823	0.60238	0.07122	0.86609	0.25208	0.76151	3	4	1	6	2	5	0	0	0	0	0	0
i11	0.41595	0.60632	0.07347	0.86789	0.25039	0.76119	3	4	1	6	2	5	0	0	0	0	0	0
i12	0.00236	0.00232	0.00219	0.00266	0.00249	0.00267												
i13	0.75014	0.24444	0.95619	0.10182	0.57925	0.41169	5	2	6	1	4	3	0	0	0	0	0	0
i14	0.40213	0.80911	0.23006	0.8918	0.0402	0.57508	3	5	2	6	1	4	0	0	0	0	0	0
i15	0.60273	0.79992	0.28916	0.8243	0.07394	0.41673	4	6	2	5	1	3	0	0	0	0	0	0
i16	0.89659	0.78353	0.57349	0.4063	0.26209	0.09465	6	5	4	3	2	1	0	0	0	0	0	0

*Table 4.2:
Comparison of routing performance for Sample Network
for entire network and different valence values*

Item	Number of Nodes	Number of routes	Number of mismatches	Error (Percent)	Accuracy (Percent)
2 link nodes	1	30	0	0%	100%
3 link nodes	3	135	0	0%	100%
4 link nodes	7	420	0	0%	100%
5 link nodes	3	225	4	1.78%	98.22%
6 link nodes	2	180	4	2.22%	97.78%
Full network	16	990	8	0.81%	99.19%

the shortest time delay between originating and destination nodes using the available links between the originating node and its adjacent nodes. In the regular case of determining the optimal route through a telecommunications network, all links are available. In the special case of determining a restoration route through a telecommunications network, one or more links are unavailable, and a choice is made between the remaining links. What is required is a method of automatically determining the best route given the availability of adjacent links.

4.2.1 Postprocessing of the output values

A trained neural network produces output values that represent the routing rankings of a given node in the sample network. This information now must be combined with information on availability of the links to the adjacent nodes to select the link representing the best route through the network. This route selection could be performed by postprocessing the output values with the link availability. There are several ways that this could be performed, but a neural network solution is desired considering the nature of the thesis work.

Choosing the best output from the output layer is a competitive activity. In neural networks this type of activity can be performed by using mutual inhibition, where each competing neuron provides a positive weight to itself and a negative weight to the neurons it competes against. This type of circuit

is normally called a winner-take-all circuit, and is commonly used to select a given unit with the highest activation value. In this thesis, what is required is a "loser-take-all" circuit, where the lowest activation (smallest value) is selected. This can be achieved by using an offset activation value of 1 and subtracting the lowest activation value; in this manner the summation of 1 minus the smallest activation will produce the largest activation value.

This circuit is shown in Figure 4.1(a). In this figure the input neurons for the circuit are the outputs of the trained neural network. The input neuron is connected to the output neuron (one of the competing members of the winner-take-all circuit) by an inhibitory link with weight = -1. A select neuron is also connected to each output neuron by an excitatory link with weight = 1. This select neuron is used to provide link availability information: if the select neuron has an activation of 1, the link associated with the output of the trained neural network is available; if the select neuron has an activation of 0, the link is not available. When the link is available, the select neuron provides the offset activation value, and the sum of the activations to the competing neuron is 1 minus the input activation. When the link is not available, no offset is provided, and the sum of the activations is 0 minus the input activation. Figure 4.1(b) shows a winner-take-all circuit with all links available (all select neurons have an activation of 1). When the winner-take-all circuit has settled, the winning node is associated with the lowest ranking input value, provided by neuron o4. Figure 4.1 (c) shows a winner-take-all circuit with one link not available (the unavailable link is associated with the lowest ranked input value, and the associated select neuron has an activation of 0). With the select neuron activation at 0, the activation of the competing neuron is 0 minus the input activation, resulting in a negative input. The winner in this competition is the neuron associated with input value o2 as shown in Figure 4.2(d), for it now has the highest activation value of the three neurons with available links.

MacBrain provides a Group Winner activation function as one of the available activation functions; this was used to produce a winner-take-all circuit. By adding a Group Winner layer and select neurons to the trained network, the final neural network used for routing has the topology shown in Figure 4.2.

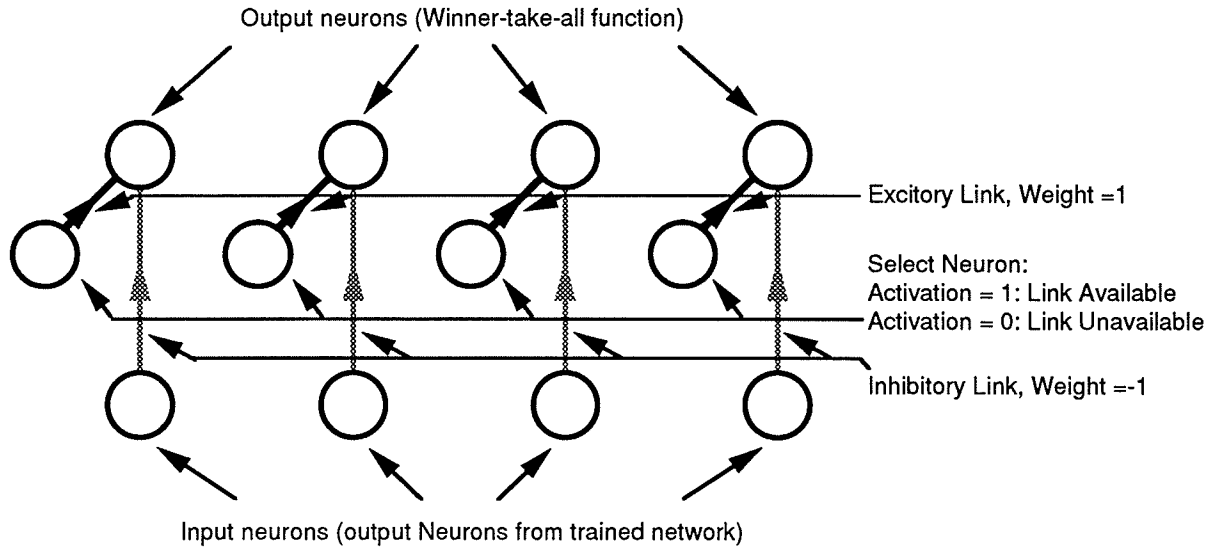

Figure 4.1(a):
Winner-Take-All circuit

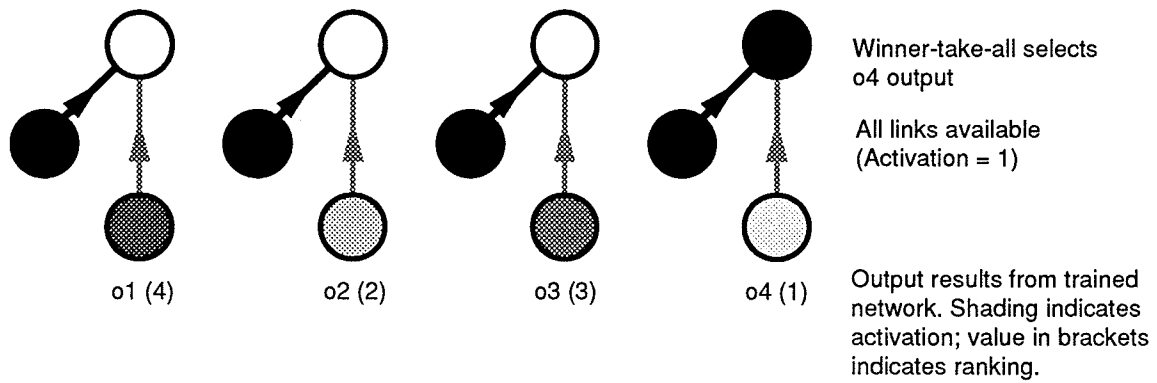

Figure 4.1(b):
Selection of output neuron with all links available

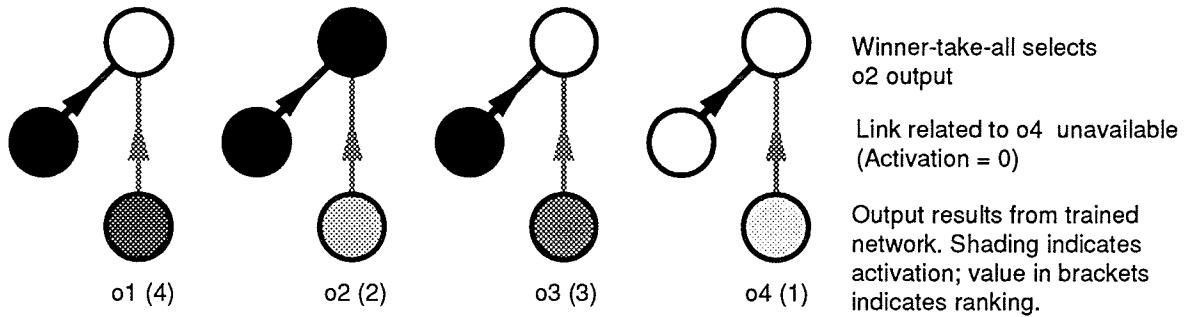

Figure 4.1(c):
Selection of output neuron with one link unavailable

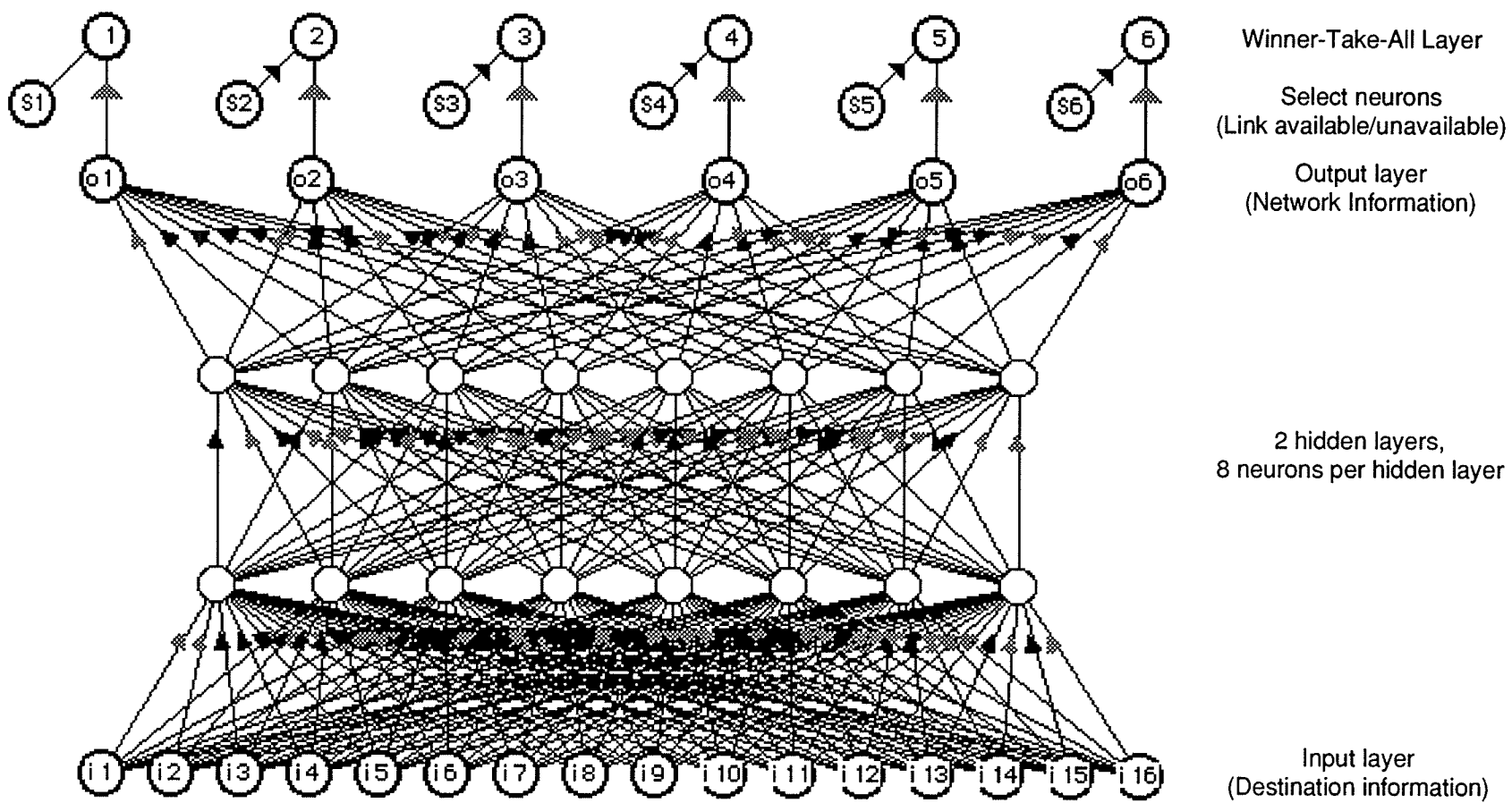

Figure 4.2:
Final neural network topology

The inputs into the network are the destination node for which the route is to be determined, and the link availability as determined by the select nodes that provide activation to the Group Winner layer. This final neural network topology will be used in upcoming simulations.

4.3 Simulation of a routing decision - normal network

The first simulation of a routing decision uses the sample network in its normal configuration with all links available. In this simulation, the neural networks determine the best route based on the shortest network delay.

4.3.1 Successful selection of optimal route

For this simulation, Node 6 was selected as the originating node and Node 13 was selected as the destination node. Node 6 has five links to adjacent nodes, connecting it to Nodes 2, 3, 7, 10, and 14. The best routes from each adjacent node to Node 13 were determined and these routes were combined with the adjacent links to create the five possible routes that can be selected by the neural network. Figure 4.3(a) shows the five routes and their associated routing values. Based on these values, the optimal route from Node 6 to Node 13 is 6-10-11-12-13, and the link from Node 6 to Node 10 is the best choice for routing from Node 6.

The file containing the trained neural network for Node 6 was opened, and the following neuron inputs were set: input i13 was set to 1, all other input neurons were set to 0, and the select neurons were all set to 1 (all links available). The input information was then cycled through the network, and the output neuron associated with o4 was activated by the winner-take-all circuit. The o4 output corresponds to the link from Node 6 to Node 10. The simulation was continued by opening the trained neural network for Node 10, selecting the same input and select neuron information, and cycling the input values through the neural network. When the network had completed cycling

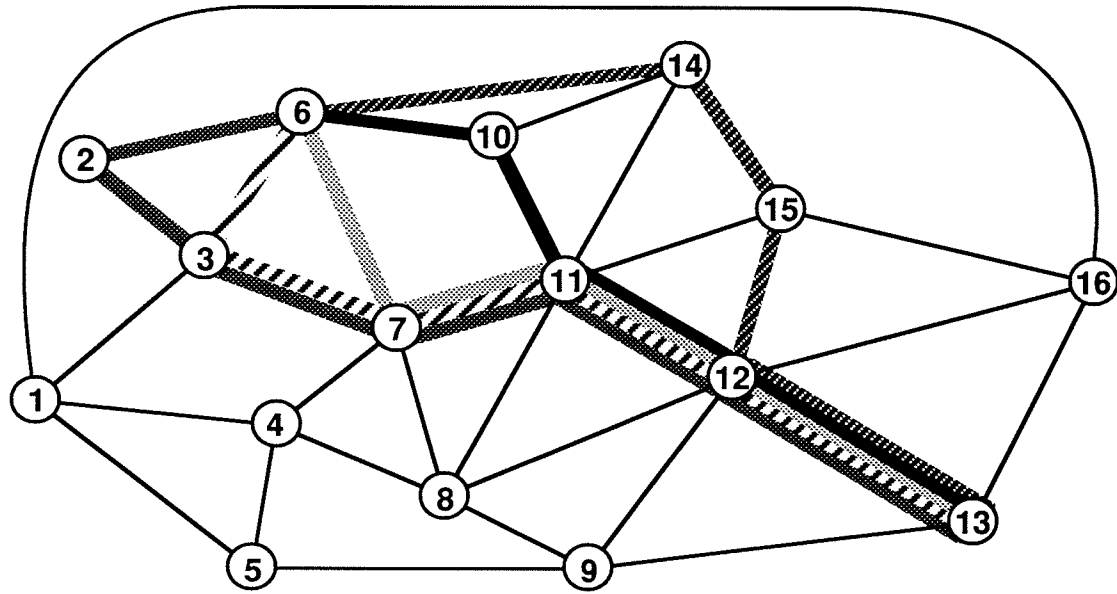

Adjacent Link	Route Shading	Routing Value
2		0.77075
3		0.64786
7		0.55413
10		0.52664
14		0.61152

Figure 4.3(a):
Routes from Node 6 to Node 13 through available adjacent links

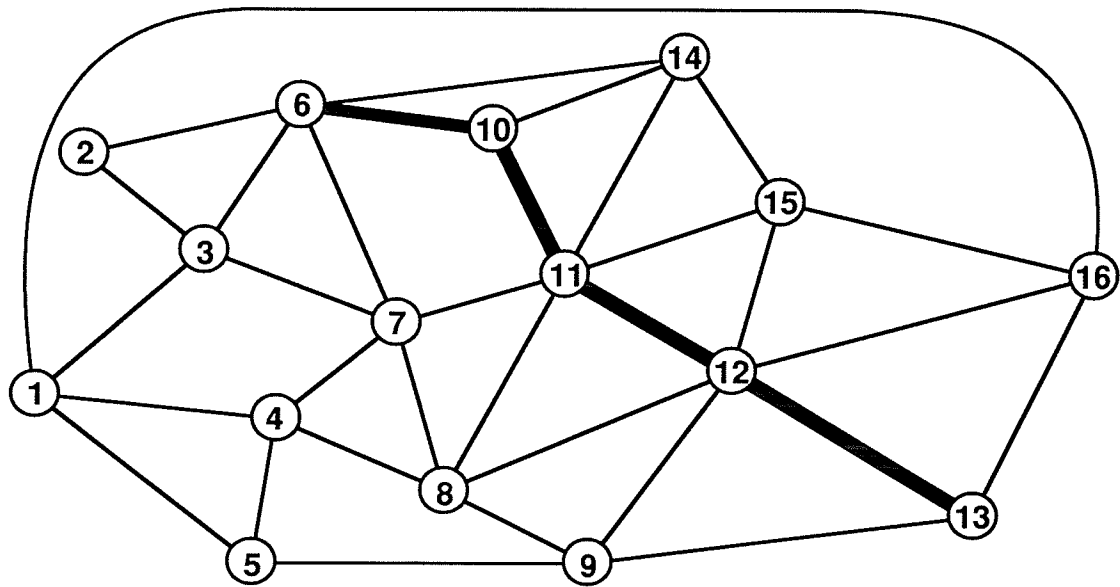

Figure 4.3(b):
Optimal route through Node 10 chosen by neural networks

the input information, the output neuron corresponding to the link from Node 10 to 11 was selected. To complete the simulation, the process was repeated for the trained networks for Nodes 11 and 12, and the links from Node 11 to Node 12 and Node 12 to Node 13 were selected, respectively. The complete selected route was 6-10-11-12-13, the correct route identified previously. This route is shown in Figure 4.3(b)

4.3.2 Unsuccessful selection of optimal route

When a neural network incorrectly learned the routing sequence, a routing mismatch occurs. These routing mismatches can result in incorrect routing decisions being performed in the network.

To demonstrate the effect of a learning error producing an incorrect routing decision, the neural networks are used to determine the optimal route between Node 11 and Node 14. It can be easily determined that the optimal route is the link that directly connects Node 11 to Node 14, but in this case the neural network did not correctly learn the routing rankings. To test the effect of the learning error, the file containing the trained neural network for Node 11 was opened and the following neuron inputs were set: input i14 was set to 1, all other input neurons were set to 0, and the select neurons were all set to 1 (all links available). The input information was then cycled through the network, and the output neuron associated with o3 was selected. The o3 output corresponds to the link from Node 11 to Node 10; the error in learning caused the network to select the link associated with output o3 instead of o5, the link that directly connects Node 11 to Node 14. The simulation was continued by opening the trained neural network for Node 10, selecting the same input and select neuron information, and cycling the input values through the neural network. When the network had completed cycling the input information, the output neuron corresponding to the link from Node 10 to 14 was selected. The complete route determined was 11-10-14, instead of 11-14. This result is shown in Figure 4.4(a).

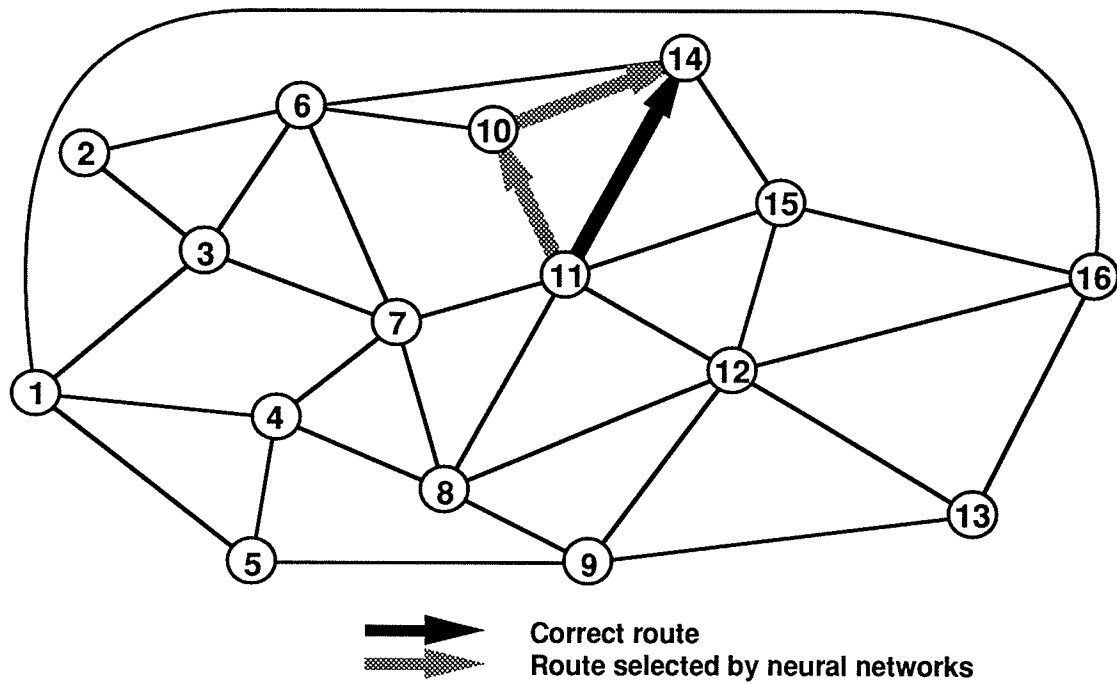

Figure 4.4(a):
Unsuccessful selection of optimal route from Node 11 to Node 14

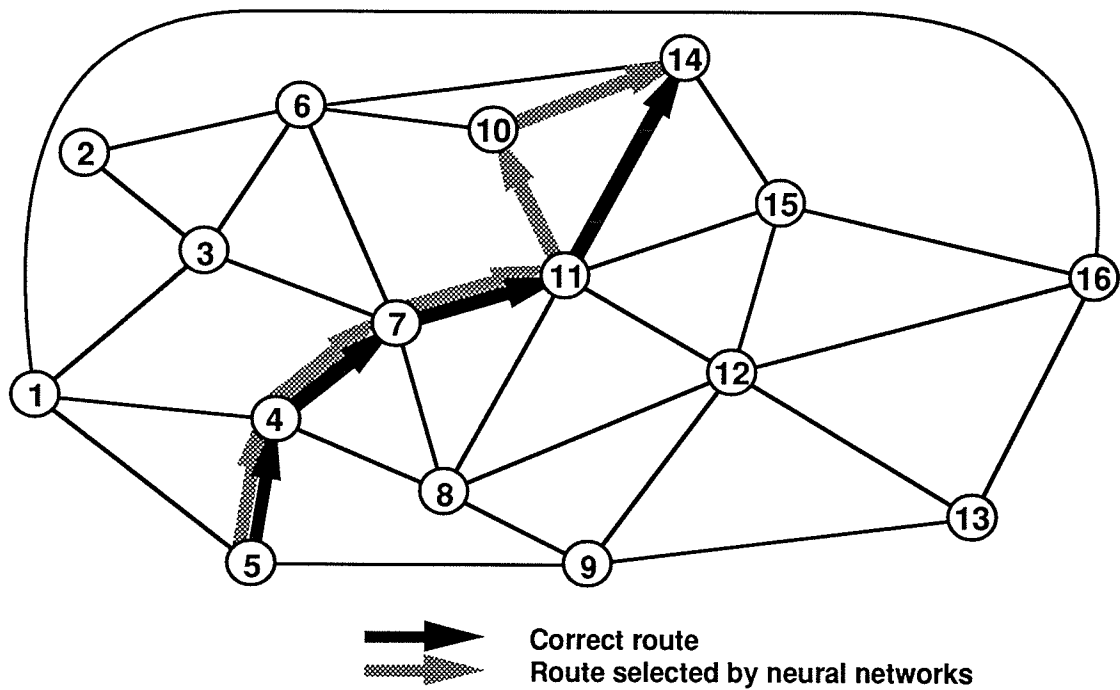

Figure 4.4(b):
Example of route impacted by unsuccessful selection in Figure 4.4(a).

The above example shows the result of incorrect learning by the neural networks under study. It is also important to consider that this incorrect routing decision between Node 11 to Node 14 will impact other routing decisions. Any route with Node 14 as the destination node that uses the link between Node 11 and Node 14 as part of the route will have that part of the routing decision incorrectly performed. As an example, the optimal route from Node 5 to Node 14 is the route 5-4-7-11-14; but since this route includes the routing mismatch demonstrated above, the route chosen by the neural networks will be 5-4-7-11-10-14. Both routes are shown in Figure 4.4(b).

In studying the errors performed in the routing, it is important to consider that the routing error made in determining the route from Node 11 to Node 14 is not performed when the route from Node 14 to Node 11 is determined; there was no learning errors in the neural network trained for Node 14, so the correct routing decision would be performed in the opposite direction.

4.4 Simulation of a routing decision around unavailable links

The optimal route through the sample network with all links available was presented above. The process relied on the concept that routing decisions by the neural networks are dependent on the availability of links from each node to adjacent nodes in the network, and the optimal route consists of an originating node, a destination node, and a set of intervening links and nodes. For the following simulations, the task of the neural networks will be to determine the most optimal alternate route between two sample network nodes when a network link used by the optimal route is unavailable. These simulations are analogous to the removal of a link in the sample network, and the requirement to establish a alternate route to replace it.

Unless the neural networks are trained with new network information related to the unavailable link in sample network, the neural networks will still perform their routing decisions based on their learned information and

adjacent link availability. As a result, any neural network for a node that is not connected to the unavailable link will perform its routing decisions as if that link is available. Only the neural networks for the nodes connected to the unavailable link will use that link information in their routing decisions.

Based on the method of routing, the determination of an alternate route can be performed by one of two methods. In the first method, an alternate route will be created from the node where the adjacent link is unavailable to the destination node. In the second method, an alternate route will be created that will replace the unavailable link only, without changing the rest of the existing optimal route.

4.4.1 Selection of an alternate route to the destination node

In this method, if all of the adjacent links to a node were available, the input neuron for the destination node would be set to 1, all other input neurons would be set to 0, and all links are available. The input values would be cycled through the network, and the output routing result would be produced. If an adjacent link was unavailable, then the input neuron representing the destination would be set to 1, all other input neurons would be set to 0, and the link availability values set as required. When the input values are cycled to the outputs, the best adjacent link to the destination node would be selected. The node at the end of this adjacent link will then select another adjacent link that represents the optimal route to the destination node using the same method, and this is repeated until the destination node is reached. Since the new node and its alternate adjacent links are not part of the original set of the optimal intervening nodes and links, the alternative route may differ significantly from the original optimal route. In addition, since each node along the optimal route has a different set of adjacent links, the location of the unavailable link can significantly affect the resulting alternative routings.

As an example, the optimal route between Node 16 and Node 3 determined when all network links are available is 16-15-11-7-3 as shown in Figure 4.5(a). In between Node 16 and Node 3 are four links; a removal of any one of these links

will result in a specific neural network selecting the second choice adjacent link to determine an alternate route. Since each node in the network has a different set of adjacent links, the alternate solution for each node along the route will be different. Figure 4.5(b) shows the alternate routes determined by the neural networks for the unavailability of different links in the network.

A study of the routing decisions above also reveals that the alternate route selected will also be dependent on the direction that the routing is performed, for the nodes on each end of the unavailable link can select different alternate links and nodes. To demonstrate this, routing decisions were performed from Node 3 to Node 16, the opposite direction to the previous routing simulation. Figure 4.6(a) is a duplicate of Figure 4.5(b), which shows the route selections made when the routing was performed from Node 16 to Node 3. Figure 4.6(b) shows the route selections made for the same unavailable links, but in this example the routing was performed from Node 3 to Node 16. In comparing the two figures it can be seen that for a given unavailable link the neural networks selected different alternate routes, with these routes being dependent upon the direction the routing is taking place.

4.4.2 Selection or alternate routing around an unavailable link

In the previous method, an alternate optimal route was created from a node with an unavailable link to the destination node. This method, while effective in establishing an alternate routing, resulted in alternative routings that were significantly different than the original optimal route. This can be useful in some forms of communications networks (such a packet networks where knowledge of the exact routing is not required) but the primary requirement in current telecommunications networks is to establish an alternate route around an unavailable link. This second routing method satisfies this requirement.

To test the routing activity of the neural networks using this method, a modified routing procedure was required. For this method, if all of the adjacent links of a node were available, the input neuron for the destination

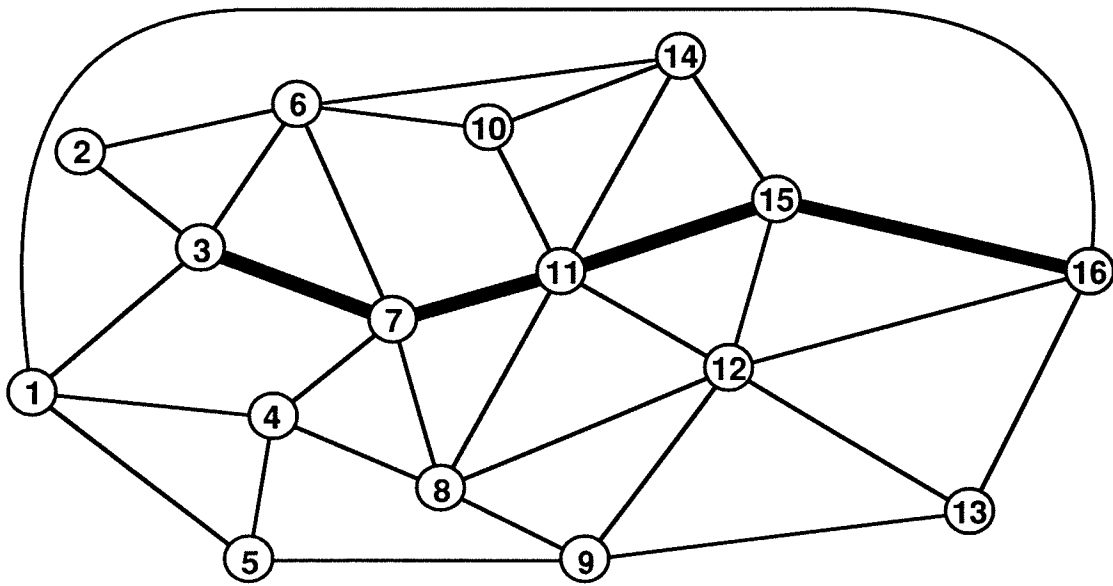
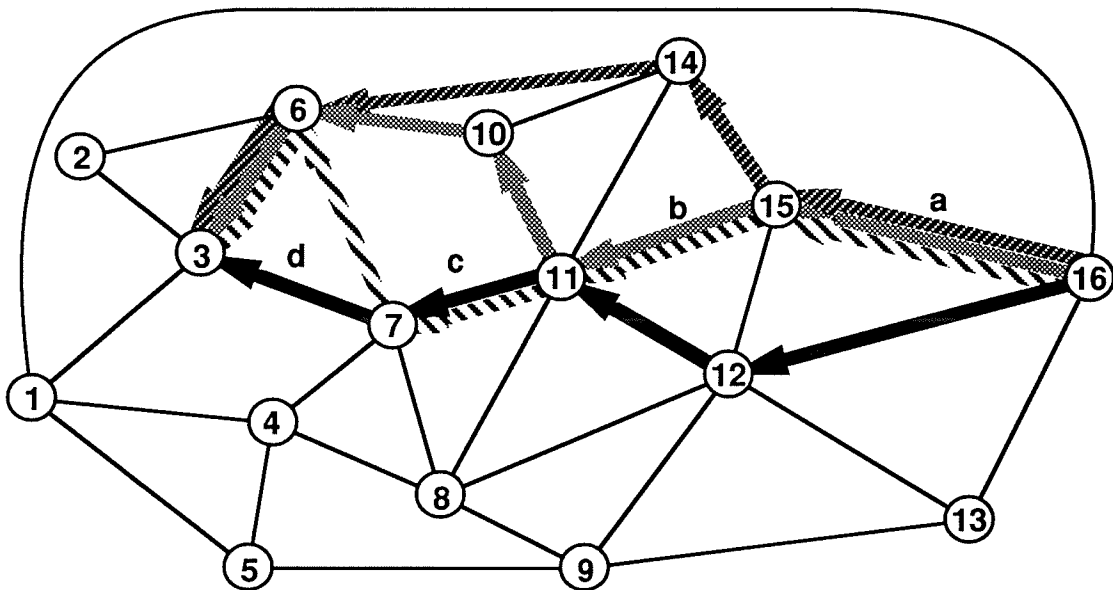
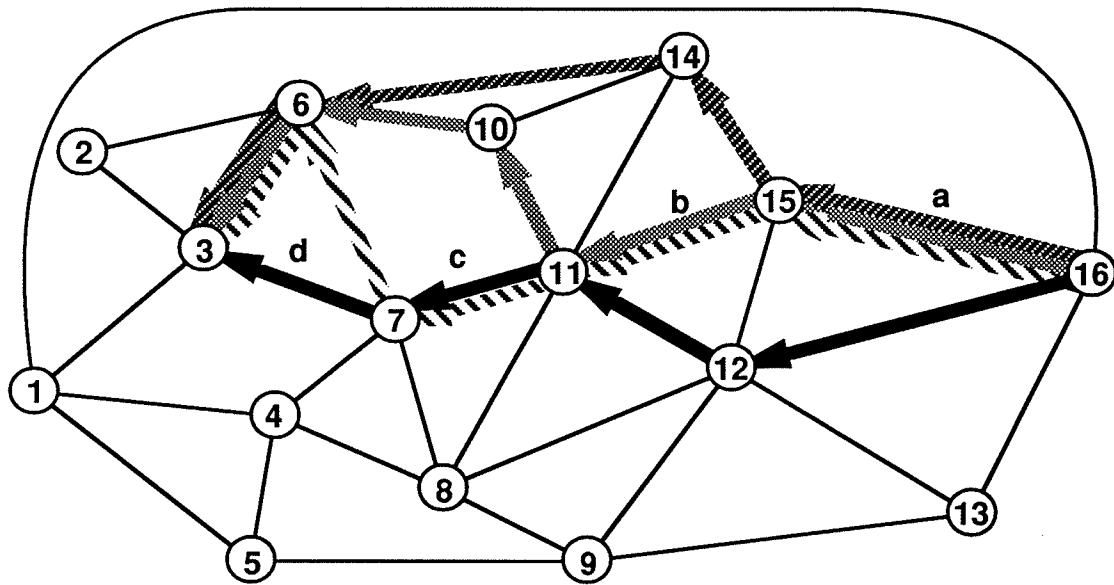

Figure 4.5(a)
Optimal Route from Node 16 to Node 3 with all links available



Unavailable Link	Route Shading	New Optimal Route	Alternate routing at
a		16-12-11-7-3	16
b		16-15-14-6-3	15
c		16-15-11-10-6-3	11
d		16-15-11-7-6-3	7

Figure 4.5(b)
Alternate routes determined as a function of unavailable link
(Routing from Node 16 to Node 3)



Unavailable Link	Route Shading	Alternate Route	Alternate routing at
a		16-12-11-7-3	16
b		16-15-14-6-3	15
c		16-15-11-10-6-3	11
d		16-15-11-7-6-3	7

Figure 4.6(a)

Alternate routes determined as a function of unavailable link
(Routing from Node 16 to Node 3)

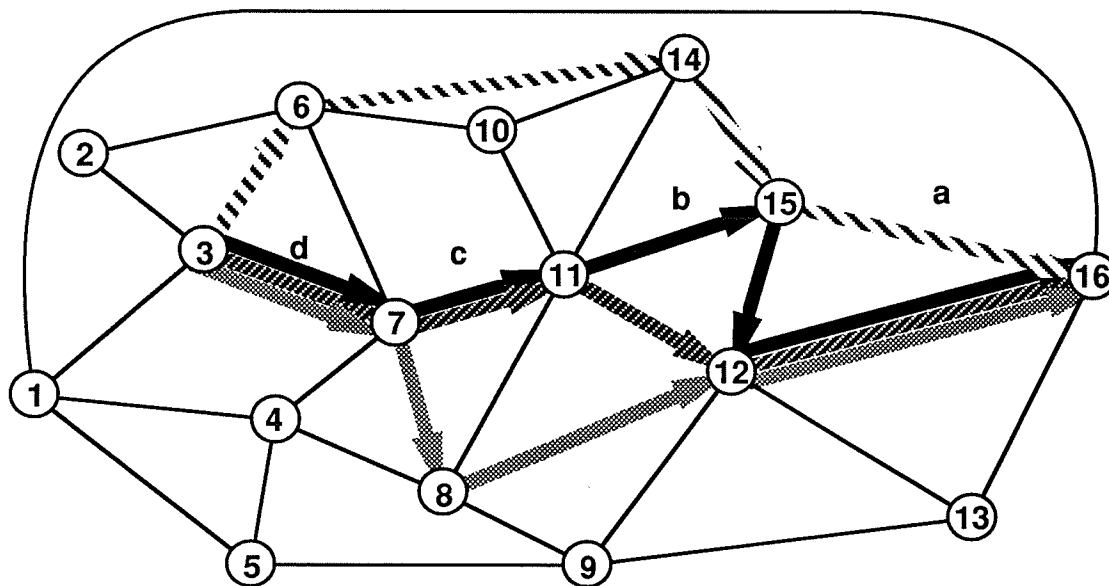

Unavailable Link	Route Shading	Alternate Route	Alternate routing at
a		3-7-11-15-12-16	15
b		3-7-11-12-16	11
c		3-7-8-12-16	7
d		3-6-14-15-16	3

Figure 4.6(b)

Alternate routes determined as a function of unavailable link
(Routing from Node 3 to Node 16)

node would be set to 1, all other input neurons would be set to 0, and all links are available. The input values would be cycled through the network, and the output routing result produced. If, however, the adjacent link used in the original optimal route was unavailable, then the input neuron for the sample network node *at the other end of the unavailable adjacent link* would be set to 1, all other input neurons would be set to 0, and the link availability values set as required. When the input values are cycled to the outputs, the best adjacent link to the node on the other end of the unavailable link would be selected. In this manner the node at the other end of the unavailable link becomes an interim destination node, and routing continues through the network until this node is reached. When the node at the other end of the unavailable link is reached, routing towards the original destination node is resumed, and the routing after the unavailable link is continued until the destination node is reached.

Using this method of routing for an unavailable link has two advantages over the original routing method: first, all nodes and all but one of the links used in the original optimal route are reused for the alternate route; and second, this form of routing produces the same results if the routing is performed in either direction. Figure 4.7 shows the results of using this routing method for the different unavailable links tested in the previous routing simulation.

4.4.3 Unsuccessful selection of alternate route

The above simulations demonstrate the successful determination of alternate routes around an unavailable link. In reviewing the learning of the neural networks, no unsuccessful alternate routings could be performed. The reason for this result was discussed in single network node modelling; in the case of performing alternative routing around an unavailable link, routing mismatches between rank 1 and rank 2 values have no effect on performance. Of the 4 routing mismatches that occurred in the 16 neural networks used, two were rank 1/rank 2 mismatches and two were rank 5/rank 6 mismatches. The rank 5/rank 6 mismatches will also have no effect in the single link failure

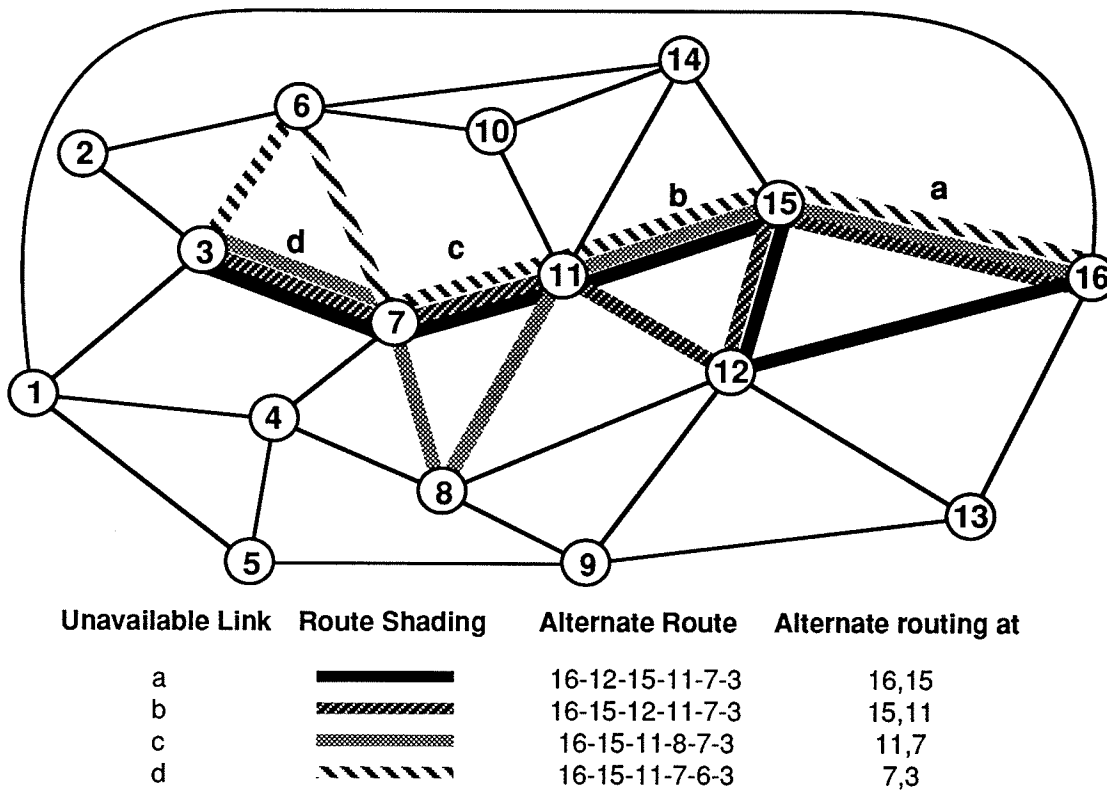

Figure 4.7:
Alternate routes around unavailable links for each unavailable link

case, for these alternative routes are too far down on the routing priority to affect this type of routing decision.

4.5 Simulation of a routing decision - node failure

In the previous set of simulations, routing decisions were performed for the case when a single link between two nodes is unavailable; this is an example of a link removal or failure. If a specific node is unavailable in the network, this is equivalent to all links associated with that node being made unavailable. This is an example of a node removal.

The method of performing routing decisions in the case of a node failure is similar to the link failure case; nodes in the sample network that were not directly connected to the removed node will perform routing decisions as if no

network changes have occurred, and all nodes will still perform routing decisions based on the routing rankings of available links. But there are special considerations in the case of a node failure. These are:

- If the node that has been removed from the network is the originating node, it will not be performing any routing decisions.
- Selection of an alternate route around an unavailable link (the second form of routing utilized for link failures) cannot be performed, for this method attempts to create an alternate route to a node on the far end of the failed link; in this case that node is unavailable.
- If the node removed from the network is the destination node, no final route can be determined. It will be shown that the attempt to perform the alternate routing selection will cause the neural networks to define a route circling the removed node.

4.5.1 Routing around an unavailable node between originating and destination nodes

In the first method of selecting an alternate route (selecting an alternate route to the destination node), the first node along the optimal route that experiences an unavailable link selects an adjacent link that provides the best alternative route to the destination node. The node at the end of this adjacent link will then select another adjacent link that represents the optimal route to the destination node, and the process is continued until the destination node is reached. If any of the nodes along this alternate route have adjacent links that connect to the unavailable node, those links will be unavailable and not used in the route selection. As was demonstrated in the unavailable link case, the alternate routings selected are dependent on the direction that the route is determined, and that these routes can be significantly different. An example of the first method of alternate route selection around an unavailable node is shown in Figure 4.8, where an alternate route from Node 3 to Node 16 is required when Node 11 is unavailable.

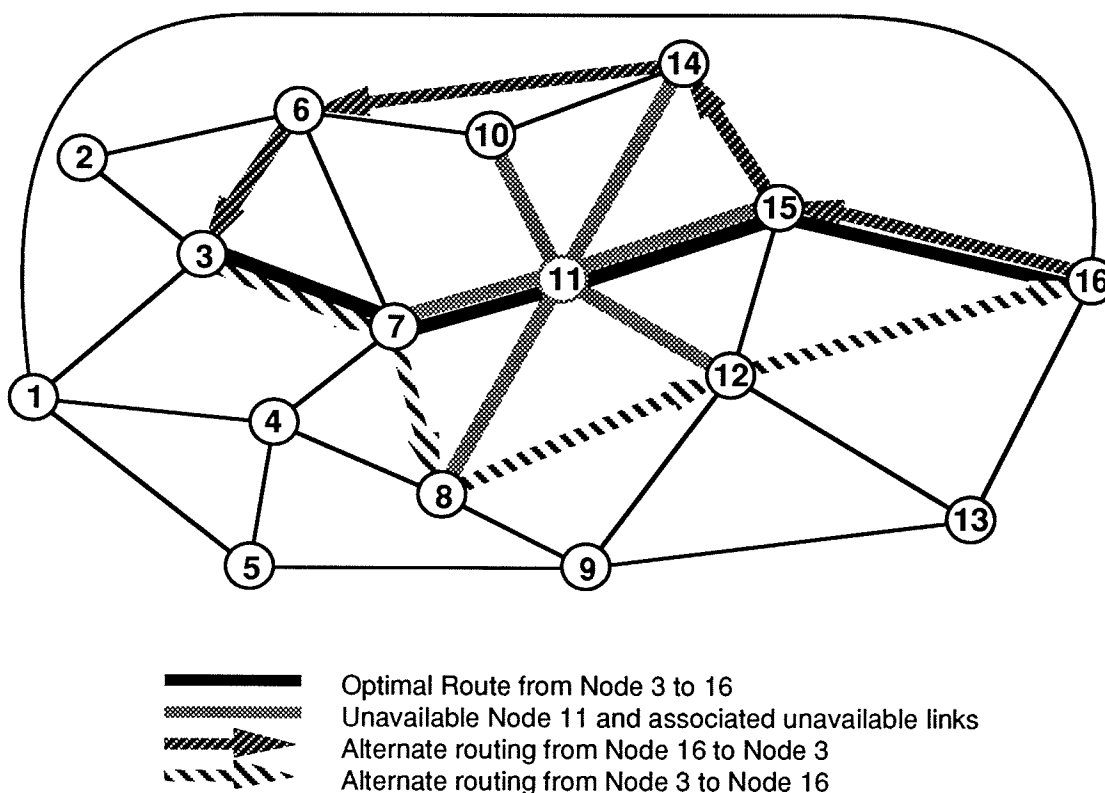

Figure 4.8:
Alternate routing around unavailable node to destination node

In the second method of selecting an alternate route (selecting an alternate route around an unavailable link), the method is the same as for an unavailable link until the point where the selection of an alternate path to the other end of the unavailable link is attempted. If another unavailable link to the node on the opposite end of the first unavailable link is encountered, then the routing decision would be changed from the node at the end of the unavailable link back to the original destination node. This change of routing destination will result in similar routing selections to those determined by the first method. In Figure 4.9(a), the second method of route selection is applied to the example of Node 11 unavailable on a route between Node 3 and Node 16. In this case the alternative routes determined were very similar in both directions, but in Figure 4.9(b) the example shows that significantly different alternate routes can be determined by each direction using this method.

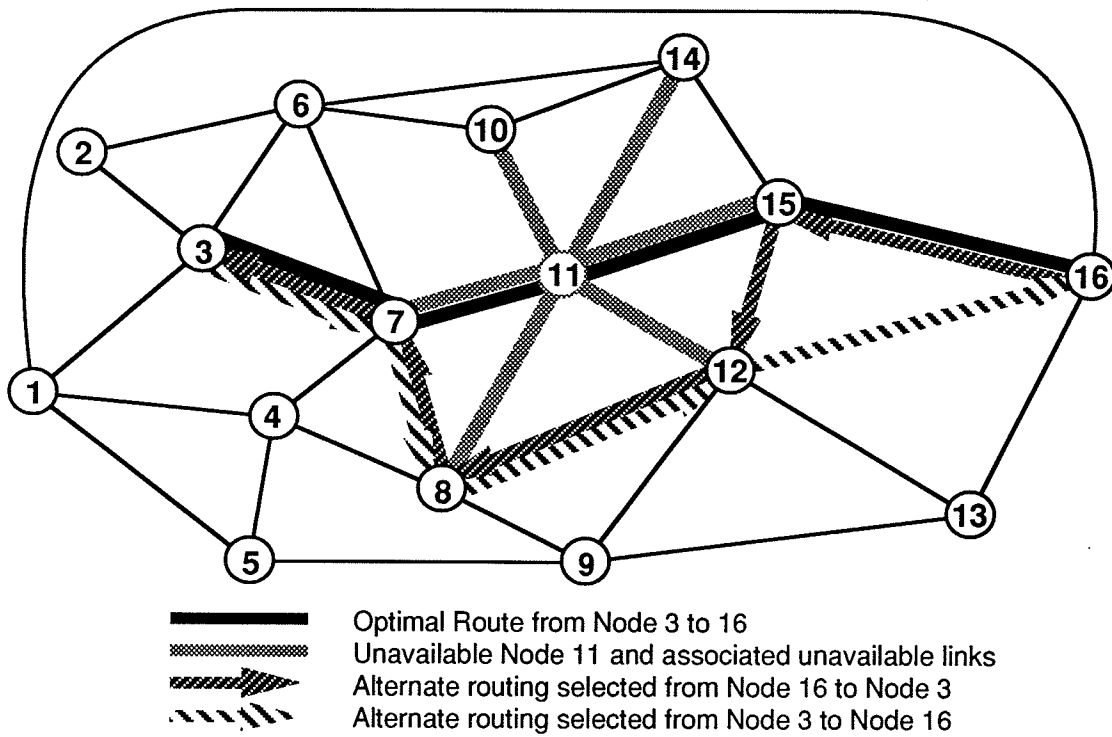

Figure 4.9(a)

*Alternate routing around an unavailable node
Routing to destination node after first attempting to route around first unavailable link*

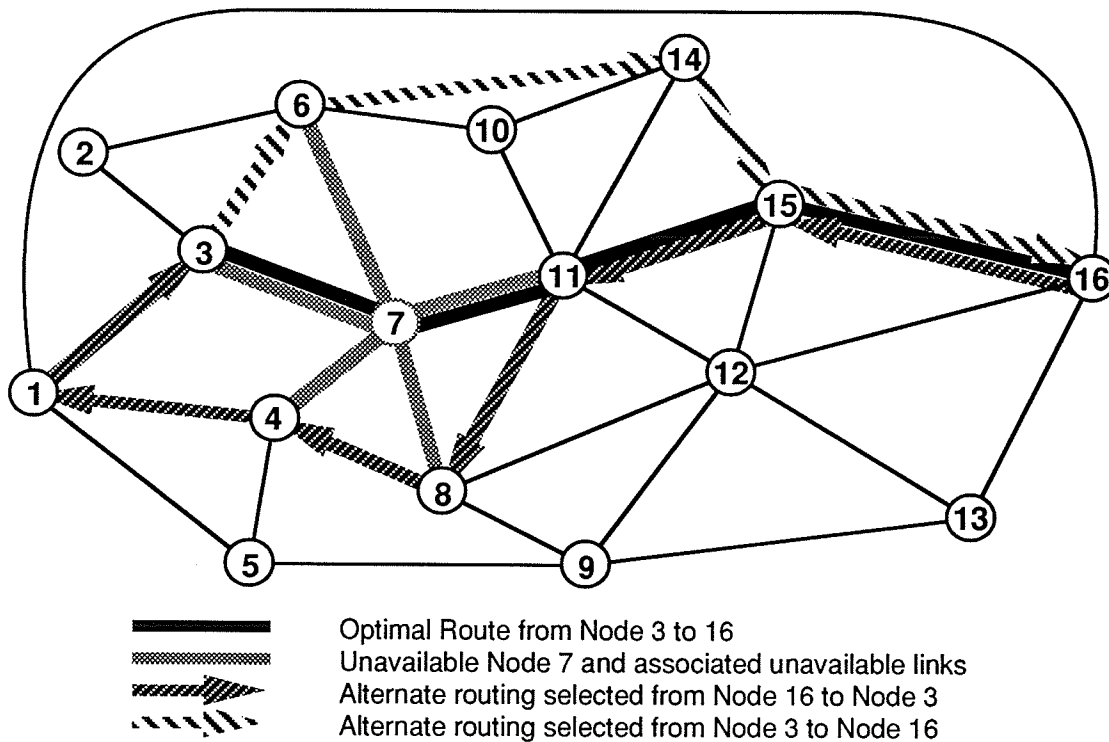

Figure 4.9(b)

*Second example of alternate routing around an unavailable node
demonstrating significant differences between alternate routes*

4.5.2 Routing determination when the destination node is unavailable

If the unavailable node is the actual destination node, a complete route cannot be determined. When this condition was tested, the neural networks selected alternate routes to other nodes with unavailable links associated with the unavailable node. This function was seen in part in Figure 4.9(b), where the alternative route from Node 16 to Node 3 utilized several of the adjacent nodes with unavailable links associated with Node 7. In Figure 4.10, Node 7 is now an unavailable destination node, and the alternative route the neural networks attempted to determine starts at Node 11 and circles Node 7, linking to all other nodes with unavailable adjacent links until it returns to Node 11. In attempting to determine the alternate route, a condition that the neural network would not select the adjacent link that connects to the previous node was used; this was based on the fact that the previous node chose the current

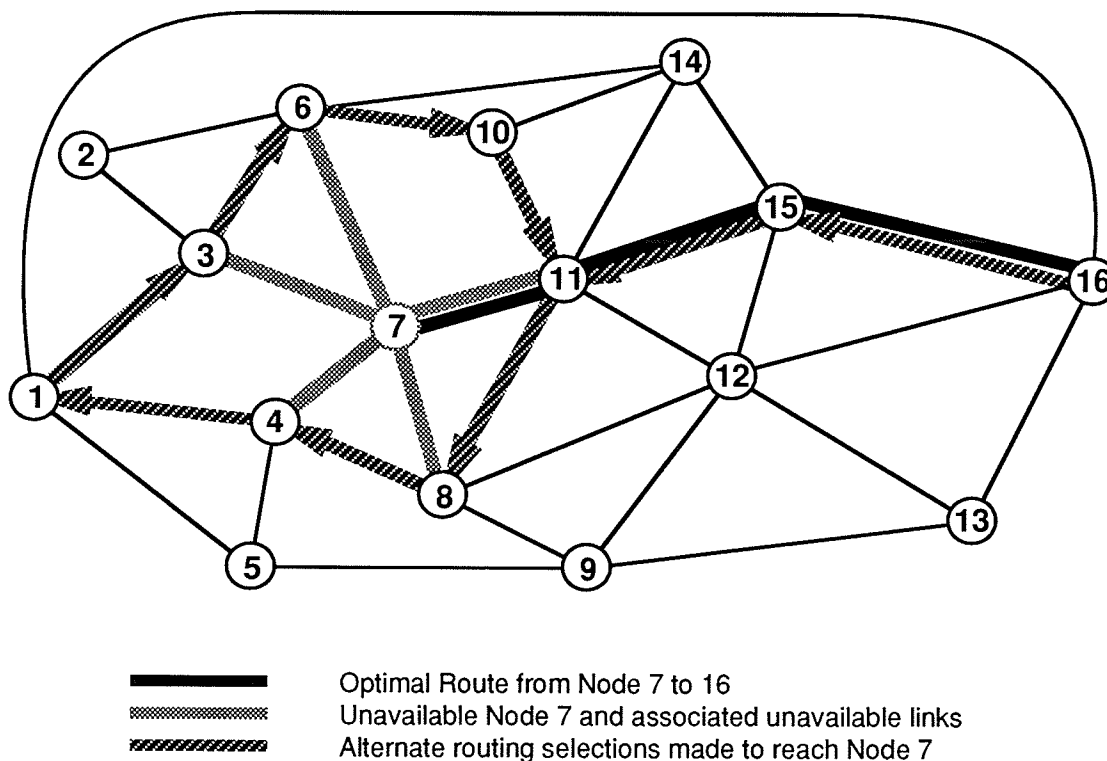

Figure 4.10:
Attempt to determine alternate routing for an unavailable destination node

node to continue with the alternate routing. If this condition was not used, then Node 4 would have chosen Node 8 in Figure 4.10 again, for the adjacent link to Node 8 is the second ranked choice from Node 4 to Node 7 after the unavailable link from Node 4 to Node 7.

Unless a decision to stop the routing attempt is made, the process would continue indefinitely. Like the earlier situation where the routing destination was changed from the node at the other end of the unavailable link to the destination node when a second unavailable link was encountered, a decision external to the neural networks making the routing decision is required. A decision to terminate the routing attempt could be made after encountering a number of unavailable links, or it could be made when the alternate route encounters a node that had previously attempted to determine an alternate route; in the case of Figure 4.10, this would occur when Node 11 is reached.

4.5.3 Unsuccessful selection of alternate route

As with the simulations for unavailable links, the above simulations demonstrate the successful determination of alternate routes around an unavailable node when it is not an originating or destination node.

A review of the learning of the neural networks found that an alternate routing could always be determined, but since the training information is based on the availability of the adjacent links only, the alternate route may not be the best alternative available, for other unavailable links not directly connected to each node affect the final route. Apart from this condition, alternative routings around an unavailable node are equivalent to routing around multiple unavailable links. As in the routing determinations for unavailable links, routing mismatches between rank 1 and rank 2 values have no effect on performing routing decisions. Of the 4 routing mismatches that occurred in the 16 neural networks used, two were rank 1/rank 2 mismatches and two were rank 5/rank 6 mismatches. The rank 5/rank 6 mismatches will have no effect in the unavailable node cases, for these alternative routes are too far down on the routing priority to affect almost all alternative routing

decisions.

4.6 Simulation of generalized routing decisions

The final set of tests performed with the neural networks tested the ability to perform a generalization function. In this set of tests, the values of more than one input neuron were set to non-zero values to observe the neural network activity. Setting multiple input neurons to non-zero values is analogous to having the network determine which output neuron represents the best routing choice for a set of destination nodes.

Six test examples were used to investigate generalization, with the results of these tests provided in Tables 4.3 to 4.8. In each test 2 or 3 input neurons of specific neural networks were set to non-zero values and cycled to propagate the information to their outputs. The output values of the neural network were collected and rank values calculated; these rankings were then compared with the output node rankings of the neural network for each destination node, and the ranking of the output nodes by the sum of the actual routing values (network delays) for the set of desired destination nodes. Figures 4.11(a) and (b) depict two of the generalization tests, their optimal routes for the respective destination nodes, and the optimal links based on network delays. Figure 4.11(a) depicts the condition where both destination nodes have the same optimal route, resulting in a simple decision. Figure 4.11(b) depicts the condition where the destination nodes have different optimal routes, and the optimal link derived from network delay is used by one of the routes. This is a more complex decision, and in this test the neural network made different link selections based on the method of input activation. The different methods of input activation are discussed below.

The tests were initially performed with activation of the input neurons representing the set of destination nodes set to 1, and all other inputs neurons set to 0. When this method of activation was used, it was found that for some tests the activation values of the output neurons approached or reached the

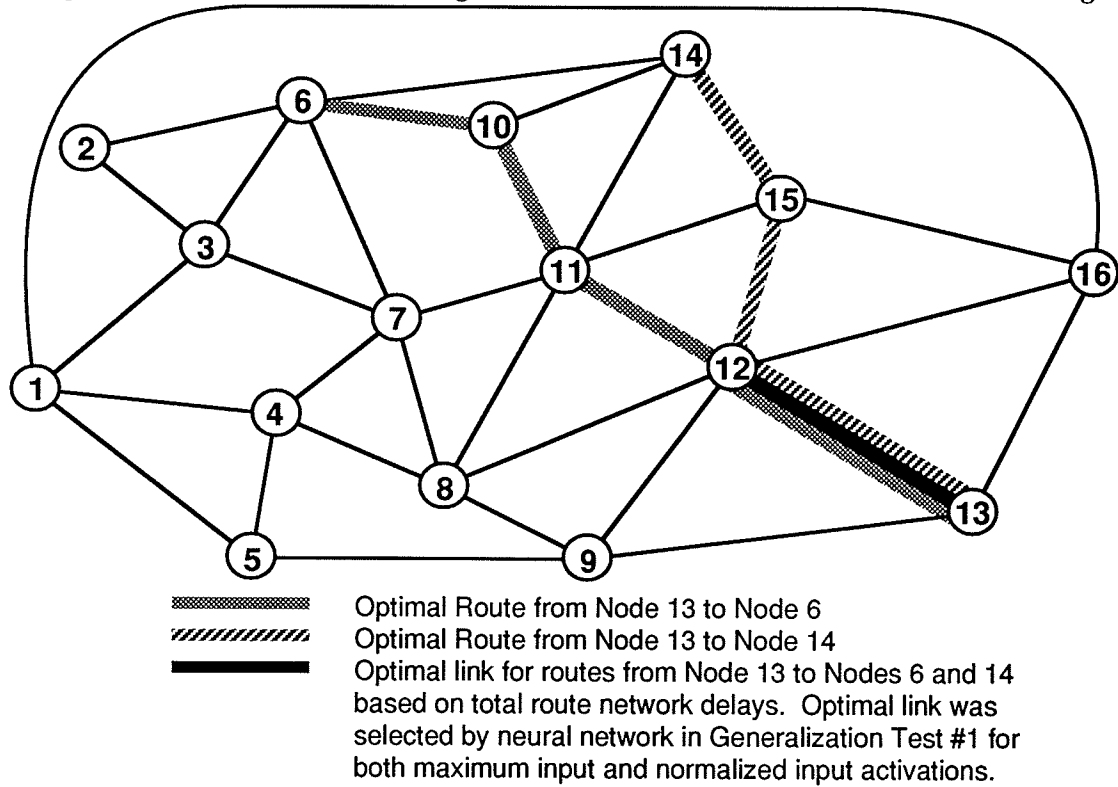

Figure 4.11(a)

Generalized routing example where 2 nodes have the same first choice link

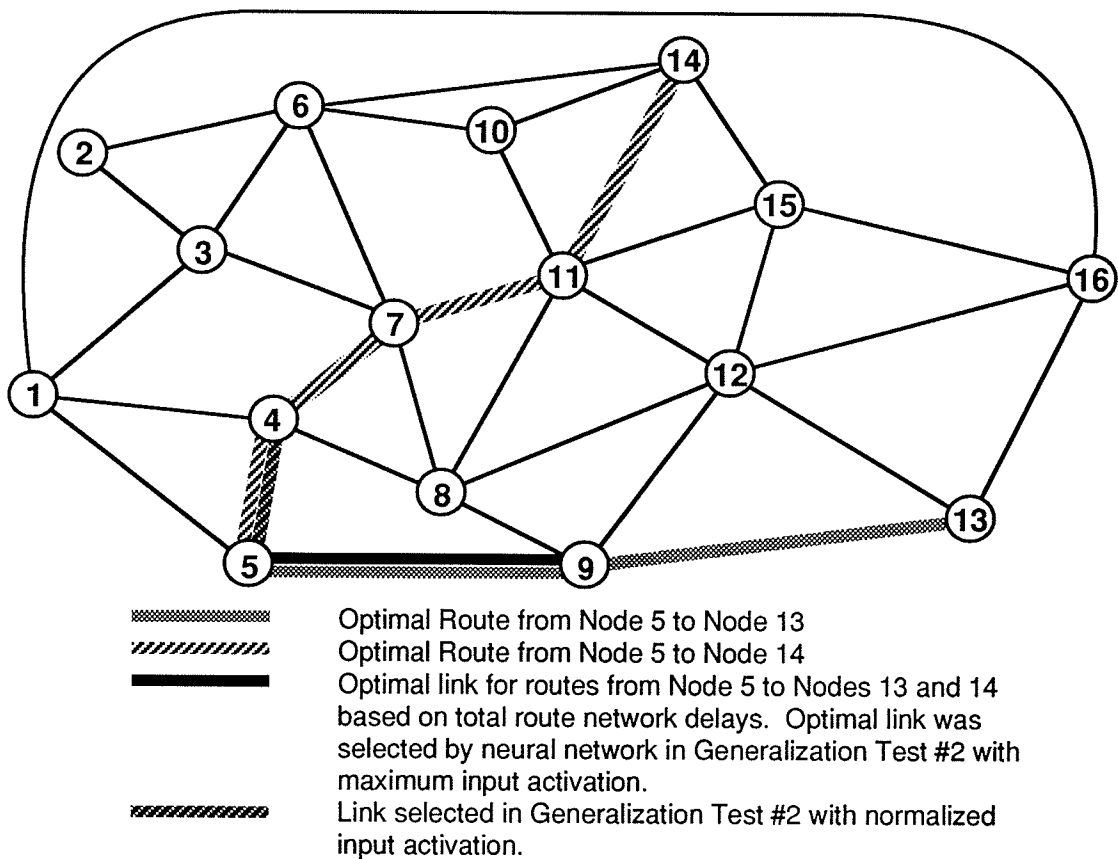

Figure 4.11(b)

Generalized routing example where 2 nodes have different first choice links

maximum activation value of 1. This saturation of the output values occurred because the neural networks were initially trained with training vectors having only a single input neuron set to 1. To reduce the occurrence of saturation, a variation of the input activation method was also tested; in this second method, the activation values for the set of destination nodes were set to the reciprocal of the number of destination nodes. This form of normalized activation resulted in the total of the input activation values being equal to 1. In the case of 2 active input neurons the activation was set at 0.5, and for three active input neurons the activation was set at 0.33.

4.6.1 Generalization test results

Test #1 is an example of performing a decision from a 3 output originating node (Node 13) to two destinations (Nodes 6 and 14) that have the same first choice route. The results of the test are provided in Table 4.3, with output values of rank 1 shaded for comparison purposes. In this case, the optimal routes from Node 13 to Nodes 6 and 14 both utilize the link from Node 13 to Node 12. For both input activation methods the neural network selected the correct route, but the rankings of the other routes changed with the different methods of activation. When the input activation was normalized, the resulting output activations were smaller than when both input neurons were set to an activation of 1; this observation was also observed in the rest of the generalization tests.

Test #2 is an example of performing a decision from a 3 output originating node (Node 5) to two destination nodes (Nodes 13 and 14) with different first choice routes. The results of the test are provided in Table 4.4, with output values of rank 1 shaded for comparison purposes. When the input activations were set to 1, the neural network generated the routing ranking based on total network delay and the output ranking to Node 13, and selected the optimal route for both destination nodes. When the input activations were normalized, the neural network selected the output rankings of Node 14, and selected the 2nd choice route for the two destination nodes.

Test #3 is an example of performing a decision from a 5 output originating node (Node 8) to two destination nodes (Nodes 6 and 12) with significantly different output rankings. The results of the test are provided in Table 4.5, with output values of rank 1 shaded for comparison purposes. When the rankings of the outputs based on the total delay were calculated, these rankings were found to be different from the output rankings of the two destination nodes. When this test was performed, both methods of activation produced the correct routing selection, though the routing rankings of the outputs with the normalized activation were closer to the total delay ranking values than the output rankings produced when the input activations were set at 1. This test also showed that when input activations were set at 1, 4 of the 5 outputs neurons reached activation values of greater than 0.98; in this case, setting all active inputs to 1 resulted in near saturation of output values.

Test #4 is an example of performing a decision from a 4 output originating node (Node 16) to two destination nodes (Nodes 4 and 6) with similar output rankings. The results of the test are provided in Table 4.6, with output values of rank 1 shaded for comparison purposes. When the input activations were set to 1, the output neurons reached maximum activation and no ranking results could be determined. When the activation values were normalized, the output neurons produced almost no activation value, the opposite result of the previous test. When the output values for the normalized activation were ranked, the network selected the correct routing choice for Node 4, but the incorrect routing choice for both nodes. The reason for these small activation values is not known, but observation of the activations of the various layers in the neural network showed high activation values in the first hidden layer and low activation values in higher layers; the combination of activation values and connection weights may have resulted in a cancellation of inputs in higher layers of the neural network.

Test #5 is an example of performing a decision from a 4 output originating node (Node 4) to three destination nodes (Nodes 10,12, and 16) with similar output rankings. The results of the test are provided in Table 4.7, with output values of rank 1 shaded for comparison purposes. When both activation

Table 4.3:
Test #1: Route selection from Node 13 to Nodes 6 and 14

Output Node	o1	o2	o3
Output Rankings: Node 13 to Node 6	2	1	3
Output Rankings: Node 13 to Node 14	3	1	2
Total Delay for routes to Nodes 6 and 14	1.1881	0.9312	1.1459
Output Rankings by Total Delay	3	1	2
Output Node	o1	o2	o3
Output Values: i6=i14=1	0.9738	0.2234	0.7922
Output Rankings: i6=i14=1	3	1	2
Output Node	o1	o2	o3
Output Values: i6=i14=0.5	0.49	0.0933	0.5057
Output Rankings: i6=i14=0.5	2	1	3

Table 4.4:
Test #2: Route selection from Node 5 to Nodes 13 and 14

Output Node	o1	o2	o3
Output Rankings: Node 5 to Node 13	3	2	1
Output Rankings: Node 5 to Node 14	3	1	2
Total Delay for routes to Nodes 6 and 14	1.3853	1.0253	0.9988
Output Rankings by Total Delay	3	2	1
Output Node	o1	o2	o3
Output Values: i13=i14=1	0.8898	0.349	0.3359
Output Rankings: i13=i14=1	3	2	1
Output Node	o1	o2	o3
Output Values: i13=i14=0.5	0.7226	0.185	0.3161
Output Rankings: i13=i14=0.5	3	1	2

Table 4.5:
Test #3: Route selection from Node 8 to Nodes 6 and 12

Output Node	o1	o2	o3	o4	o5
Output Rankings: Node 8 to Node 6	2	1	5	3	4
Output Rankings: Node 8 to Node 12	5	4	2	3	1
Total Delay for routes to Nodes 6 and 12	0.8448	0.6379	0.8798	0.6806	0.7436
Output Rankings by Total Delay	4	1	5	2	3
Output Node	o1	o2	o3	o4	o5
Output Values: i6=i12=1	0.9889	0.5687	1	0.9993	0.9986
Output Rankings: i6=i12=1	3	1	5	4	2
Output Node	o1	o2	o3	o4	o5
Output Values: i6=i12=0.5	0.2017	0.0837	0.4972	0.1584	0.2503
Output Rankings: i6=i12=0.5	3	1	5	2	4

Table 4.6:
Test #4: Route selection from Node 16 to Nodes 4 and 6

Output Node	o1	o2	o3	o4
Output Rankings: Node 16 to Node 4	4	1	3	2
Output Rankings: Node 16 to Node 6	4	2	3	1
Total Delay for routes to Nodes 4 and 6	1.5835	1.0923	1.2915	1.0714
Output Rankings by Total Delay	4	2	3	1

Output Node	o1	o2	o3	o4
Output Values: $i_4=i_6=1$	1.0000	1.0000	1.0000	1.0000
Output Rankings: $i_4=i_6=1$	1	1	1	1

Output Node	o1	o2	o3	o4
Output Values: $i_4=i_6=0.5$	0.0015	0.0012	0.0014	0.0012
Output Rankings: $i_4=i_6=0.5$	4	1	3	2

Table 4.7:
Test #5: Route selection from Node 4 to Nodes 10,12 and 16

Output Node	o1	o2	o3	o4
Output Rankings: Node 4 to Node 10	3	4	1	2
Output Rankings: Node 4 to Node 12	4	3	2	1
Output Rankings: Node 4 to Node 16	4	3	2	1
Total Delay for routes to Nodes 10,12,16	1.9216	1.7449	1.2397	1.2251
Output Rankings by Total Delay	4	3	2	1

Output Node	o1	o2	o3	o4
Output Values: $i_{10}=i_{12}=i_{16}=1$	0.9999	0.9762	0.9406	0.0919
Output Rankings: $i_{10}=i_{12}=i_{16}=1$	4	3	2	1

Output Node	o1	o2	o3	o4
Output Values: $i_{10}=i_{12}=i_{16}=0.33$	0.7613	0.6026	0.2253	0.1884
Output Rankings: $i_{10}=i_{12}=i_{16}=0.33$	4	3	2	1

Table 4.8:
Test #6: Route selection from Node 3 to Nodes 9,14 and 15

Output Node	o1	o2	o3	o4
Output Rankings: Node 3 to Node 9	3	4	2	1
Output Rankings: Node 3 to Node 14	4	3	1	2
Output Rankings: Node 3 to Node 15	4	3	2	1
Total Delay for routes to Nodes 9,14,15	1.8007	1.6461	1.2774	1.1612
Output Rankings by Total Delay	4	3	2	1

Output Node	o1	o2	o3	o4
Output Values: $i_9=i_{14}=i_{15}=1$	1.0000	1.0000	1.0000	1.0000
Output Rankings: $i_9=i_{14}=i_{15}=1$	1	1	1	1

Output Node	o1	o2	o3	o4
Output Values: $i_9=i_{14}=i_{15}=0.33$	0.0604	0.0346	0.0196	0.0178
Output Rankings: $i_9=i_{14}=i_{15}=0.33$	4	3	2	1

methods were tested, the neural network correctly selected the first choice route for two of the destination nodes and all three nodes based on total delay. When the input activation was set at 1, output values were close to saturation; when the input activation was normalized, output values were considerable lower.

Test #6 is an example of performing a decision from a 4 output originating node (Node 3) to 3 destination nodes (Nodes 9, 14, and 15) with similar output rankings. The results of the test are provided in Table 4.8, with output values of rank 1 shaded for comparison purposes. The results of this test were similar to that of Test #4; when the input activations were set at 1, saturation of the outputs occurred, and when the input activations were normalized, very small output activations were produced. In this case, the output rankings were the same as the output rankings based on total delay, and the network selected the correct output.

4.6.2 Summary of generalization tests

In reviewing the performance of the neural networks in performing generalization decisions, the results were inconsistent. While some networks correctly determined output rankings, other networks produced incorrect output rankings and selected incorrect routes. In all but one test routing mismatches between the measured rankings and the output rankings based on total delay were off by a value of 1, the same level of routing mismatches that occurred in the single node routing tests performed in earlier sections. Based on this performance, the neural networks could be used to perform generalized routing decisions for restoration purposes (where rank 1/rank 2 mismatches could be ignored) but the inconsistent results found in the small set of tests conducted is not a significantly large sample to properly support the above conclusion. More testing of these types of decisions, and investigation into the neural network behaviour found in Tests #4 and #6, is required before firm conclusions could be made.

Chapter 5

Conclusions and recommendations

5.1 Conclusions

A number of conclusions have been drawn from the work presented in this thesis. They are:

- Several approaches can be considered in mapping telecommunications routing problems into the area of neural networks. By studying the concepts of network routing from the perspective of current routing methods and routing theory, routing patterns or relationships can be extracted for study. In this thesis, a distributed routing method based on a time based ranking system was selected for neural network simulation and analysis.
- Experimentation with various neural network variables uncovered differences in the capabilities of neural networks to learn routing information. In this thesis, modifications to the structure of the neural network and to the learning method demonstrated that routing performance could be improved.
- The preparation of the training set information can significantly affect the routing performance of the tested neural networks. The quantization of routing rankings tested in this thesis resulted in poorer learning of the actual rank values but improved learning of the ranking order.
- Trained neural networks, combined with a postprocessing winner-take-all layer, can be used to perform distributed routing. When the set of neural networks was trained with routing information from a sample network, the neural networks performed the specific individual routing tasks with a high degree of efficiency under a number of different network routing conditions. The neural networks were also able to perform a number of generalized routing decisions, but the results of the generalized routing tests were not as

conclusive as those of the individual routing analysis; a potential explanation for this is that the training sets for the neural networks did not contain any generalizing information.

5.2 Recommendations

Based on the work performed, there are a number of recommendations for areas of further investigation. These are:

- Extension of the routing method to more generalized routing problems.
- The performance of the neural networks could be tested with other learning rules such as Hebbian learning or counterpropagation.
- Routing performance can be tested using other neural network topologies. The thesis demonstrated that 8 neurons per hidden layer performed best of the three topologies considered, but other topologies with different number of neurons in each layer are possible. Neural network topologies with 4 and 10 neurons per hidden layer are examples of the different topologies considered for potential study, and the removal of the input neuron representing the originating node can be investigated to evaluate any effects on neural network performance.
- A study of features extracted by the neural network's hidden layers can be performed to determine their relationships to the routing network under study.
- Further testing in the area of generalization can be performed to more fully understand how the networks perform this function, and investigations into how generalized routing information could be incorporated into the training set and neural networks can be performed.
- The neural networks in this thesis were studied using software simulations on a general purpose computer. One possible extension of this work would be to implement the neural networks in silicon to test actual routing performance.

References

References

- [1] D.W. Tank and J.J. Hopfield. *Collective Computation in Neuronlike Circuits*. Scientific American, September 1987, pp. 104-114.
- [2] T. Kohonen. *An Introduction to Neural Computing*. Neural Networks, Volume 1, 1988, pp. 3-16.
- [3] G.F. Watson coordinator. $\Delta V=0.7V=85\ 000$ irate travelers IEEE Spectrum, Volume 29, Number 2, February 1992, p. 54.
- [4] G. Zorpette editor. *Keeping the phone lines open*. IEEE Spectrum, Volume 26, Number 6, June 1989, pp. 32-36.
- [5] F. Ellefson. *Migration to network restoration*. Alberta Telecommunications Research Center conference on Trends in Network Restoration, Edmonton, Alberta. May 24-25, 1990.
- [6] F. Corsale *Survivable Transport Networks*. Alberta Telecommunications Research Center conference on Trends in Network Restoration, Edmonton, Alberta. May 24-25, 1990.
- [7] C.H. Yang and S. Hasegawa. *FITNESS: Failure Immunization Technology for Network Service Survivability*. IEEE Global Telecommunications Conference (Globecom) 1988, pp. 1549-1554.
- [8] W.D. Grover, B.D. Venables, M.H. MacGregor, and J.H. Sandham. *Development and Performance Assessment of a Distributed Asynchronous Protocol for Real-Time Network Restoration*. IEEE Journal on Selected Areas of Communications, Volume 9, Number 1 January 1991, pp.112-125.
- [9] N. Deo and C. Pang. *Shortest path algorithms: Taxonomy and annotation*. Networks, Volume 14, 1984, pp. 275-323.
- [10] E.W. Dijkstra. *A Note on Two Problems in Connexion with Graphs*. Numerische Mathematik 1, 1959, pp. 269-271.
- [11] G. Fahner. *An Algorithm-Structured Neural Net for the Shortest-Path Problem*, IEEE International Joint Conference on Neural Networks (IJCNN) 1991, pp.1 153-158.
- [12] A. Ephremides and S. Verdu. *Control and Optimization Methods in Communication Network Problems*. IEEE Transactions on Automatic Control, Vol 34, No. 9, September 1989, pp. 930-941.
- [13] T.X. Brown. *Neural Networks for Switching*. IEEE Communications Magazine, November 1989 pp. 72-81.
- [14] P.J.W. Melsa, J.B. Kenney, and C.E. Rohrs. *A neural network solution for call routing with preferential call placement*. IEEE Global Telecommunications Conference (Globecom) 1990, pp. 1377-1381.
- [15] A. Hiramatsu. *ATM communications network control by neural network*. IEEE

International Joint Conference on Neural Networks (IJCNN) 1989, pp. 1-259-266.

[16] A. Hiramatsu. *Integration of ATM call admission control and link capacity control by distributed neural networks*. IEEE Global Telecommunications Conference (Globecom) 1990, pp. 1382-1386.

[17] A. Chugo, W. Sotelo, and I. Iida. *Holonic Routing Scheme based on Neural Computations*. IEEE Global Telecommunications Conference (Globecom) 1990, pp. 1366-1370.

[18] G. Frisiani, T. Parisini, L. Siccardi, and R. Zoppoli. *Team theory and back-propagation for dynamic routing in communication networks*. IEEE International Joint Conference on Neural Networks (IJCNN) 1991, pp. 1-325-334.

[19] H.E. Rausch and T. Winarske. *Neural Networks for Routing Communications Traffic*. IEEE Control Systems Magazine, Volume 8, Issue 2, April 1988, pp. 26-31.

[20] J.E. Jensen, M.A. Eshera, and S.C. Barash. *Neural Network Controller for Adaptive Routing in Survivable Communications Networks*. IEEE International Joint Conference on Neural Networks (IJCNN) 1990, pp. 29-36

[21] G.E. Hinton. *Connectionist Learning Procedures* Artificial Intelligence, Volume 40, Issues 1-3, September 1989, pp. 285-235.

[22] R.P. Lippman . *An introduction to Computing with Neural Nets* IEEE ASSP Magazine, April 1987, pp. 4-22.

[23] M. Jensen, S. Kennedy, and G. Blanton. *MacBrain 3.0 User Manual*.

[24] H.C. Card. Lecture notes for University of Manitoba course 24.723 "Neural Networks", Spring 1990. Portions of course notes © G.E. Hinton 1989.

Appendix A: Training macros and sets

Icon based representation of the V1 Macro

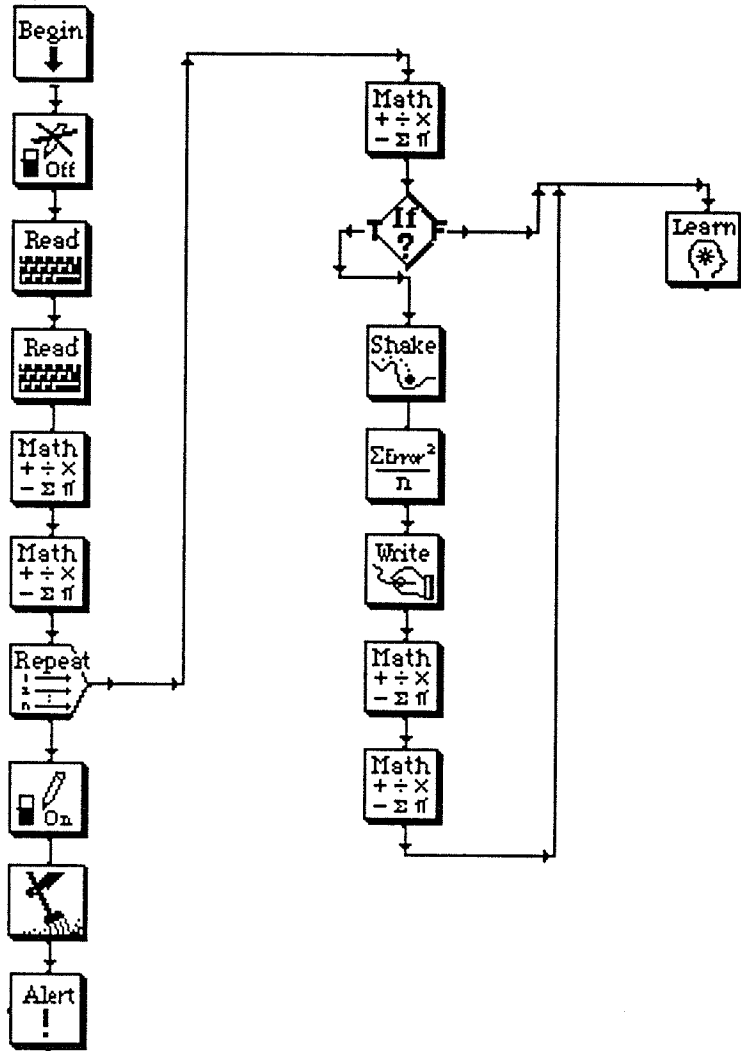

Pattern File for Node 2 of Sample Network

Destination Node	Input Vector																Output Vector	
	i1	i2	i3	i4	i5	i6	i7	i8	i9	i10	i11	i12	i13	i14	i15	i16	o1	o2
1	1	0	0	0	0	0	0	0	0	0	0	0	0	0	0	0	0.2569	0.3986
2	0	1	0	0	0	0	0	0	0	0	0	0	0	0	0	0	0.0000	0.0000
3	0	0	1	0	0	0	0	0	0	0	0	0	0	0	0	0	0.1245	0.2663
4	0	0	0	1	0	0	0	0	0	0	0	0	0	0	0	0	0.3486	0.3966
5	0	0	0	0	1	0	0	0	0	0	0	0	0	0	0	0	0.4146	0.4924
6	0	0	0	0	0	1	0	0	0	0	0	0	0	0	0	0	0.2335	0.1573
7	0	0	0	0	0	0	1	0	0	0	0	0	0	0	0	0	0.249	0.297
8	0	0	0	0	0	0	0	1	0	0	0	0	0	0	0	0	0.3588	0.4068
9	0	0	0	0	0	0	0	0	1	0	0	0	0	0	0	0	0.4618	0.5097
10	0	0	0	0	0	0	0	0	0	1	0	0	0	0	0	0	0.3524	0.2762
11	0	0	0	0	0	0	0	0	0	0	1	0	0	0	0	0	0.3588	0.3793
12	0	0	0	0	0	0	0	0	0	0	0	1	0	0	0	0	0.4776	0.4981
13	0	0	0	0	0	0	0	0	0	0	0	0	1	0	0	0	0.6385	0.659
14	0	0	0	0	0	0	0	0	0	0	0	0	0	1	0	0	0.4405	0.3643
15	0	0	0	0	0	0	0	0	0	0	0	0	0	0	1	0	0.4942	0.4733
16	0	0	0	0	0	0	0	0	0	0	0	0	0	0	0	1	0.6745	0.6536

Pattern File for Node 9 of the Sample Network

Destination Node	Input Vector																Output Vector			
	i1	i2	i3	i4	i5	i6	i7	i8	i9	i10	i11	i12	i13	i14	i15	i16	o1	o2	o3	o4
i1	1	0	0	0	0	0	0	0	0	0	0	0	0	0	0	0	0.3708	0.3838	0.5985	0.8306
i2	0	1	0	0	0	0	0	0	0	0	0	0	0	0	0	0	0.6027	0.4619	0.6191	0.8512
i3	0	0	1	0	0	0	0	0	0	0	0	0	0	0	0	0	0.5031	0.3623	0.5195	0.7516
i4	0	0	0	1	0	0	0	0	0	0	0	0	0	0	0	0	0.3088	0.2418	0.4565	0.6886
i5	0	0	0	0	1	0	0	0	0	0	0	0	0	0	0	0	0.213	0.3376	0.5523	0.7844
i6	0	0	0	0	0	1	0	0	0	0	0	0	0	0	0	0	0.5481	0.3776	0.5072	0.7393
i7	0	0	0	0	0	0	1	0	0	0	0	0	0	0	0	0	0.4084	0.2379	0.395	0.6271
i8	0	0	0	0	0	0	0	1	0	0	0	0	0	0	0	0	0.4225	0.1281	0.3428	0.5749
i9	0	0	0	0	0	0	0	0	1	0	0	0	0	0	0	0	0.0000	0.0000	0.0000	0.0000
i10	0	0	0	0	0	0	0	0	0	1	0	0	0	0	0	0	0.6212	0.3761	0.3884	0.6205
i11	0	0	0	0	0	0	0	0	0	0	1	0	0	0	0	0	0.5181	0.273	0.2853	0.5174
i12	0	0	0	0	0	0	0	0	0	0	0	1	0	0	0	0	0.5989	0.3045	0.1664	0.3985
i13	0	0	0	0	0	0	0	0	0	0	0	0	1	0	0	0	0.7597	0.4653	0.3272	0.2377
i14	0	0	0	0	0	0	0	0	0	0	0	0	0	1	0	0	0.663	0.4179	0.3851	0.6172
i15	0	0	0	0	0	0	0	0	0	0	0	0	0	0	1	0	0.6536	0.4085	0.2762	0.5083
i16	0	0	0	0	0	0	0	0	0	0	0	0	0	0	0	1	0.8046	0.5102	0.3712	0.3929

Pattern File for Node 11 of the Sample Network

Destination Node	Input Vector																Output Vector					
	i1	i2	i3	i4	i5	i6	i7	i8	i9	i10	i11	i12	i13	i14	i15	i16	o1	o2	o3	o4	o5	o6
1	1	0	0	0	0	0	0	0	0	0	0	0	0	0	0	0	0.3763	0.4256	0.4882	0.5759	0.6182	0.7023
2	0	1	0	0	0	0	0	0	0	0	0	0	0	0	0	0	0.3588	0.5037	0.3793	0.6541	0.5092	0.6088
3	0	0	1	0	0	0	0	0	0	0	0	0	0	0	0	0	0.2592	0.4041	0.3559	0.5545	0.4859	0.5854
4	0	0	0	1	0	0	0	0	0	0	0	0	0	0	0	0	0.2343	0.2836	0.4862	0.4339	0.6162	0.5603
5	0	0	0	0	1	0	0	0	0	0	0	0	0	0	0	0	0.3301	0.3794	0.582	0.4732	0.712	0.5997
6	0	0	0	0	0	1	0	0	0	0	0	0	0	0	0	0	0.2745	0.4194	0.247	0.5696	0.3769	0.4765
7	0	0	0	0	0	0	1	0	0	0	0	0	0	0	0	0	0.1348	0.2797	0.3867	0.43	0.5166	0.5564
8	0	0	0	0	0	0	0	1	0	0	0	0	0	0	0	0	0.2445	0.1699	0.4964	0.3203	0.565	0.4467
9	0	0	0	0	0	0	0	0	1	0	0	0	0	0	0	0	0.3476	0.273	0.5995	0.2853	0.53	0.4117
10	0	0	0	0	0	0	0	0	0	1	0	0	0	0	0	0	0.3933	0.5382	0.1281	0.4871	0.2944	0.3939
11	0	0	0	0	0	0	0	0	0	0	1	0	0	0	0	0	0.0000	0.0000	0.0000	0.0000	0.0000	0.0000
12	0	0	0	0	0	0	0	0	0	0	0	1	0	0	0	0	0.4209	0.3463	0.4713	0.1439	0.3886	0.2703
13	0	0	0	0	0	0	0	0	0	0	0	0	1	0	0	0	0.5603	0.4857	0.6321	0.3047	0.5494	0.4311
14	0	0	0	0	0	0	0	0	0	0	0	0	0	1	0	0	0.4815	0.6331	0.2526	0.3626	0.1699	0.2695
15	0	0	0	0	0	0	0	0	0	0	0	0	0	0	1	0	0.5307	0.456	0.3615	0.2536	0.2789	0.1605
16	0	0	0	0	0	0	0	0	0	0	0	0	0	0	0	1	0.6266	0.552	0.5418	0.3496	0.4591	0.3408

**Appendix B:
Single node modelling results**

Training Results for V1.2.06.2
(Network 2.06.2, V1 Macro)

Destination	Neuron o1 (Route 3)			Neuron o2 (Route 6)		
	Target	Meas	Diff	Target	Meas	Diff
i1	0.2569	0.30273	-0.0458	0.3986	0.31941	0.07919
i2		0.04306	-0.0431		0.04654	-0.0465
i3	0.1245	0.04622	0.07828	0.2663	0.05003	0.21627
i4	0.3486	0.34681	0.00179	0.3966	0.36605	0.03055
i5	0.4146	0.43077	-0.0162	0.4924	0.45044	0.04196
i6	0.2335	0.041	0.1925	0.1573	0.04433	0.11297
i7	0.249	0.06095	0.18805	0.297	0.06602	0.23098
i8	0.3588	0.36095	-0.0021	0.4068	0.38049	0.02631
i9	0.4618	0.45955	0.00225	0.5097	0.4796	0.0301
i10	0.3524	0.29049	0.06191	0.2762	0.30855	-0.0324
i11	0.3588	0.3472	0.0116	0.3793	0.3667	0.0126
i12	0.4776	0.46848	0.00912	0.4981	0.48932	0.00878
i13	0.6385	0.63023	0.00827	0.659	0.64821	0.01079
i14	0.4405	0.38725	0.05325	0.3643	0.3994	-0.0351
i15	0.4942	0.46577	0.02843	0.4733	0.47587	-0.0026
i16	0.6745	0.64238	0.03212	0.6536	0.65873	-0.0051
Neuron Results	Average	Diff (Full)	0.04842	Average	Diff (Full)	0.05764
	Average	Diff (Mod)	0.04878	Average	Diff (Mod)	0.05838
	Std Dev	Diff (Full)	0.06003	Std Dev	Diff (Full)	0.07077
	Std Dev	Diff (Mod)	0.06212	Std Dev	Diff (Mod)	0.07319
Network Results	Average	Diff (Full)	0.05303	Std Dev	Diff (Full)	0.06472
	Average	Diff (Mod)	0.05358	Std Dev	Diff (Mod)	0.06688

Training Results for V1.2.08.2
(Network 2.08.2, V1 Macro)

Destination	Neuron o1 (Route 3)			Neuron o2 (Route 6)		
	Target	Meas	Diff	Target	Meas	Diff
i1	0.2569	0.28168	-0.0248	0.3986	0.30242	0.09618
i2		0.0715	-0.0715		0.07721	-0.0772
i3	0.1245	0.07042	0.05408	0.2663	0.07659	0.18971
i4	0.3486	0.33394	0.01466	0.3966	0.35496	0.04164
i5	0.4146	0.42424	-0.0096	0.4924	0.44666	0.04574
i6	0.2335	0.06315	0.17035	0.1573	0.06845	0.08885
i7	0.249	0.07516	0.17384	0.297	0.08133	0.21567
i8	0.3588	0.35021	0.00859	0.4068	0.37191	0.03489
i9	0.4618	0.45184	0.00996	0.5097	0.47508	0.03462
i10	0.3524	0.22612	0.12628	0.2762	0.24254	0.03366
i11	0.3588	0.32692	0.03188	0.3793	0.34806	0.03124
i12	0.4776	0.46238	0.01522	0.4981	0.48504	0.01306
i13	0.6385	0.62634	0.01216	0.659	0.64764	0.01136
i14	0.4405	0.37257	0.06793	0.3643	0.39235	-0.0281
i15	0.4942	0.43674	0.05746	0.4733	0.45938	0.01392
i16	0.6745	0.64214	0.03236	0.6536	0.66176	-0.0082
Neuron Results	Average	Diff (Full)	0.05504	Average	Diff (Full)	0.06025
	Average	Diff (Mod)	0.05395	Average	Diff (Mod)	0.05912
	Std Dev	Diff (Full)	0.0555	Std Dev	Diff (Full)	0.06177
	Std Dev	Diff (Mod)	0.05727	Std Dev	Diff (Mod)	0.06377
Network Results	Average	Diff (Full)	0.05765	Std Dev	Diff (Full)	0.05782
	Average	Diff (Mod)	0.05653	Std Dev	Diff (Mod)	0.05961

Training Results for V1.2.10.2
(Network 2.10.2, V1 Macro)

Destination	Neuron o1 (Route 3)			Nueron o2 (Route 6)		
	Target	Meas	Diff	Target	Meas	Diff
i1	0.2569	0.14932	0.10758	0.3986	0.16186	0.23674
i2		0.10219	-0.1022		0.1108	-0.1108
i3	0.1245	0.09382	0.03068	0.2663	0.10212	0.16418
i4	0.3486	0.28185	0.06675	0.3966	0.30104	0.09556
i5	0.4146	0.41347	0.00113	0.4924	0.43604	0.05636
i6	0.2335	0.08242	0.15108	0.1573	0.08961	0.06769
i7	0.249	0.104	0.145	0.297	0.11283	0.18417
i8	0.3588	0.34716	0.01164	0.4068	0.36798	0.03882
i9	0.4618	0.43911	0.02269	0.5097	0.46259	0.04711
i10	0.3524	0.10614	0.24626	0.2762	0.11508	0.16112
i11	0.3588	0.32868	0.03012	0.3793	0.35833	0.02097
i12	0.4776	0.45562	0.02198	0.4981	0.47872	0.01938
i13	0.6385	0.624	0.0145	0.659	0.64538	0.01362
i14	0.4405	0.3625	0.078	0.3643	0.3826	-0.0183
i15	0.4942	0.43063	0.06357	0.4733	0.45226	0.02104
i16	0.6745	0.63911	0.03539	0.6536	0.65956	-0.006
Neuron Results	Average	Diff (Full)	0.07054	Average	Diff (Full)	0.07886
	Average	Diff (Mod)	0.06842	Average	Diff (Mod)	0.07673
	Std Dev	Diff (Full)	0.06663	Std Dev	Diff (Full)	0.07215
	Std Dev	Diff (Mod)	0.06807	Std Dev	Diff (Mod)	0.07416
Network Results	Average	Diff (Full)	0.0747	Std Dev	Diff (Full)	0.06829
	Average	Diff (Mod)	0.07258	Std Dev	Diff (Mod)	0.07007

Training Results for V1.2.06.4
(Network 2.06.4, V1 Macro)

Destination	Neuron o1 (Route 5)			Neuron o2 (Route 8)		
	Target	Meas	Diff	Target	Meas	Diff
i1	0.3708	0.38696	-0.0162	0.3838	0.34123	0.04257
i2	0.6027	0.59431	0.00839	0.4619	0.45203	0.00987
i3	0.5031	0.49084	0.01226	0.3623	0.34667	0.01563
i4	0.3088	0.2663	0.0425	0.2418	0.23695	0.00485
i5	0.213	0.28783	-0.0748	0.3376	0.27743	0.06017
i6	0.5481	0.53388	0.01422	0.3776	0.36776	0.00984
i7	0.4084	0.33077	0.07763	0.2379	0.24452	-0.0066
i8	0.4225	0.26476	0.15774	0.1281	0.2078	-0.0797
i9		0.03653	-0.0365		0.02367	-0.0237
i10	0.6212	0.62441	-0.0032	0.3761	0.37954	-0.0034
i11	0.5181	0.5127	0.0054	0.273	0.28933	-0.0163
i12	0.5989	0.58511	0.01379	0.3045	0.31116	-0.0067
i13	0.7597	0.78442	-0.0247	0.4653	0.46794	-0.0026
i14	0.663	0.67004	-0.007	0.4179	0.41063	0.00727
i15	0.6536	0.67837	-0.0248	0.4085	0.38525	0.02325
i16	0.8046	0.79761	0.00699	0.5102	0.4862	0.024
Neuron Results	Average Diff (Full)	0.03289		Average Diff (Full)	0.02103	
	Average Diff (Mod)	0.03264		Average Diff (Mod)	0.02086	
	Std Dev Diff (Full)	0.04048		Std Dev Diff (Full)	0.02202	
	Std Dev Diff (Mod)	0.04189		Std Dev Diff (Mod)	0.02278	

Destination	Neuron o3 (Route 12)			Neuron o4 (Route 13)		
	Target	Meas	Diff	Target	Meas	Diff
i1	0.5985	0.59328	0.00522	0.8306	0.83464	-0.004
i2	0.6191	0.61651	0.00259	0.8512	0.83803	0.01317
i3	0.5195	0.5021	0.0174	0.7516	0.76498	-0.0134
i4	0.4565	0.44198	0.01452	0.6886	0.70348	-0.0149
i5	0.5523	0.53303	0.01927	0.7844	0.78615	-0.0018
i6	0.5072	0.49192	0.01528	0.7393	0.74378	-0.0045
i7	0.395	0.38908	0.00592	0.6271	0.64714	-0.02
i8	0.3428	0.34296	-0.0002	0.5749	0.58669	-0.0118
i9		0.02331	-0.0233		0.03318	-0.0332
i10	0.3884	0.38312	0.00528	0.6205	0.58901	0.03149
i11	0.2853	0.2917	-0.0064	0.5174	0.47513	0.04227
i12	0.1664	0.2295	-0.0631	0.3985	0.31962	0.07888
i13	0.3272	0.24207	0.08513	0.2377	0.24794	-0.0102
i14	0.3851	0.39052	-0.0054	0.6172	0.58445	0.03275
i15	0.2762	0.30626	-0.0301	0.5083	0.44889	0.05941
i16	0.3712	0.33132	0.03988	0.3929	0.43999	-0.0471
Neuron Results	Average Diff (Full)	0.02118		Average Diff (Full)	0.02618	
	Average Diff (Mod)	0.02104		Average Diff (Mod)	0.02571	
	Std Dev Diff (Full)	0.02362		Std Dev Diff (Full)	0.02193	
	Std Dev Diff (Mod)	0.02445		Std Dev Diff (Mod)	0.02262	

Network Results	Average Diff (Full)	0.02532	Std Dev Diff (Full)	0.02787
	Average Diff (Mod)	0.02506	Std Dev Diff (Mod)	0.02874

Training Results for V1.2.08.4
(Network 2.08.4, V1 Macro)

Destination	Neuron o1 (Route 5)			Neuron o2 (Route 8)		
	Target	Meas	Diff	Target	Meas	Diff
i1	0.3708	0.35205	0.01875	0.3838	0.33991	0.04389
i2	0.6027	0.5856	0.0171	0.4619	0.45071	0.01119
i3	0.5031	0.48237	0.02073	0.3623	0.35385	0.00845
i4	0.3088	0.24995	0.05885	0.2418	0.23459	0.00721
i5	0.213	0.27724	-0.0642	0.3376	0.27887	0.05873
i6	0.5481	0.52539	0.02271	0.3776	0.36714	0.01046
i7	0.4084	0.32837	0.08003	0.2379	0.24195	-0.0041
i8	0.4225	0.28845	0.13405	0.1281	0.21074	-0.0826
i9		0.0526	-0.0526		0.03387	-0.0339
i10	0.6212	0.65128	-0.0301	0.3761	0.37922	-0.0031
i11	0.5181	0.54835	-0.0303	0.273	0.28818	-0.0152
i12	0.5989	0.59535	0.00355	0.3045	0.28943	0.01507
i13	0.7597	0.75393	0.00577	0.4653	0.47533	-0.01
i14	0.663	0.70045	-0.0375	0.4179	0.40757	0.01033
i15	0.6536	0.66736	-0.0138	0.4085	0.37255	0.03595
i16	0.8046	0.79197	0.01263	0.5102	0.49962	0.01058
Neuron Results	Average	Diff (Full)	0.03766	Average	Diff (Full)	0.02255
	Average	Diff (Mod)	0.03666	Average	Diff (Mod)	0.02179
	Std Dev	Diff (Full)	0.03391	Std Dev	Diff (Full)	0.02262
	Std Dev	Diff (Mod)	0.03485	Std Dev	Diff (Mod)	0.0232

Destination	Neuron o3 (Route 12)			Neuron o4 (Route 13)		
	Target	Meas	Diff	Target	Meas	Diff
i1	0.5985	0.61316	-0.0147	0.8306	0.84129	-0.0107
i2	0.6191	0.62066	-0.0016	0.8512	0.84059	0.01061
i3	0.5195	0.50933	0.01017	0.7516	0.75722	-0.0056
i4	0.4565	0.44457	0.01193	0.6886	0.70087	-0.0123
i5	0.5523	0.53606	0.01624	0.7844	0.78113	0.00327
i6	0.5072	0.49369	0.01351	0.7393	0.74236	-0.0031
i7	0.395	0.38487	0.01013	0.6271	0.65044	-0.0233
i8	0.3428	0.33575	0.00705	0.5749	0.58957	-0.0147
i9		0.03763	-0.0376		0.06216	-0.0622
i10	0.3884	0.36284	0.02556	0.6205	0.57605	0.04445
i11	0.2853	0.26408	0.02122	0.5174	0.45055	0.06685
i12	0.1664	0.21265	-0.0463	0.3985	0.34866	0.04984
i13	0.3272	0.28202	0.04518	0.2377	0.24983	-0.0121
i14	0.3851	0.36627	0.01883	0.6172	0.57499	0.04221
i15	0.2762	0.30839	-0.0322	0.5083	0.47451	0.03379
i16	0.3712	0.34629	0.02491	0.3929	0.4174	-0.0245
Neuron Results	Average	Diff (Full)	0.02106	Average	Diff (Full)	0.02622
	Average	Diff (Mod)	0.01996	Average	Diff (Mod)	0.02382
	Std Dev	Diff (Full)	0.01335	Std Dev	Diff (Full)	0.02106
	Std Dev	Diff (Mod)	0.01304	Std Dev	Diff (Mod)	0.01942

Network Results	Average	Diff (Full)	0.02687	Std Dev	Diff (Full)	0.02422
	Average	Diff (Mod)	0.02556	Std Dev	Diff (Mod)	0.02428

Training Results for V1.2.10.4
(Model 2.06.4, V1 Macro)

Destination	Neuron o1 (Route 5)			Neuron o2 (Route 8)				
	Target	Meas	Diff	Target	Meas	Diff		
i1	0.3708	0.34781	0.02299	0.3838	0.34264	0.04116		
i2	0.6027	0.5936	0.0091	0.4619	0.45209	0.00981		
i3	0.5031	0.46029	0.04281	0.3623	0.35066	0.01164		
i4	0.3088	0.28944	0.01936	0.2418	0.24264	-0.0008		
i5	0.213	0.19687	0.01613	0.3376	0.26826	0.06934		
i6	0.5481	0.52875	0.01935	0.3776	0.36484	0.01276		
i7	0.4084	0.35785	0.05055	0.2379	0.2347	0.0032		
i8	0.4225	0.32037	0.10213	0.1281	0.20368	-0.0756		
i9		0.0652	-0.0652		0.04462	-0.0446		
i10	0.6212	0.63596	-0.0148	0.3761	0.37651	-0.0004		
i11	0.5181	0.55983	-0.0417	0.273	0.29702	-0.024		
i12	0.5989	0.59126	0.00764	0.3045	0.30243	0.00207		
i13	0.7597	0.74813	0.01157	0.4653	0.46553	-0.0002		
i14	0.663	0.70881	-0.0458	0.4179	0.41836	-0.0005		
i15	0.6536	0.67154	-0.0179	0.4085	0.3817	0.0268		
i16	0.8046	0.7784	0.0262	0.5102	0.48441	0.02579		
Neuron Results	Average	Diff	(Full)	0.03208	Average	Diff	(Full)	0.0218
	Average	Diff	(Mod)	0.02987	Average	Diff	(Mod)	0.02027
	Std Dev	Diff	(Full)	0.02514	Std Dev	Diff	(Full)	0.02446
	Std Dev	Diff	(Mod)	0.02437	Std Dev	Diff	(Mod)	0.02452

Destination	Neuron o3 (Route 12)			Neuron o4 (Route 13)				
	Target	Meas	Diff	Target	Meas	Diff		
i1	0.5985	0.61117	-0.0127	0.8306	0.84178	-0.0112		
i2	0.6191	0.61465	0.00445	0.8512	0.83766	0.01354		
i3	0.5195	0.50773	0.01177	0.7516	0.75736	-0.0058		
i4	0.4565	0.42852	0.02798	0.6886	0.69339	-0.0048		
i5	0.5523	0.56724	-0.0149	0.7844	0.797	-0.0126		
i6	0.5072	0.49523	0.01197	0.7393	0.74773	-0.0084		
i7	0.395	0.37192	0.02308	0.6271	0.65121	-0.0241		
i8	0.3428	0.32307	0.01973	0.5749	0.59463	-0.0197		
i9		0.05946	-0.0595		0.10837	-0.1084		
i10	0.3884	0.37162	0.01678	0.6205	0.57796	0.04254		
i11	0.2853	0.25649	0.02881	0.5174	0.40723	0.11017		
i12	0.1664	0.21906	-0.0527	0.3985	0.32292	0.07558		
i13	0.3272	0.26893	0.05827	0.2377	0.26839	-0.0307		
i14	0.3851	0.36161	0.02349	0.6172	0.5429	0.0743		
i15	0.2762	0.30684	-0.0306	0.5083	0.45363	0.05467		
i16	0.3712	0.34605	0.02515	0.3929	0.45789	-0.065		
Neuron Results	Average	Diff	(Full)	0.02637	Average	Diff	(Full)	0.04134
	Average	Diff	(Mod)	0.02416	Average	Diff	(Mod)	0.03687
	Std Dev	Diff	(Full)	0.01675	Std Dev	Diff	(Full)	0.03587
	Std Dev	Diff	(Mod)	0.01473	Std Dev	Diff	(Mod)	0.03219

Network Results	Average	Diff	(Full)	0.0304	Std Dev	Diff	(Full)	0.02684
	Average	Diff	(Mod)	0.02779	Std Dev	Diff	(Mod)	0.02491

Training Results for V1.2.06.6
(Network 2.06.6, V1 Macro)

Destination	Neuron o1 (Route 7)			Neuron o2 (Route 8)			Neuron o3 (Route 10)		
	Target	Meas	Diff	Target	Meas	Diff	Target	Meas	Diff
i1	0.3763	0.32439	0.05191	0.4256	0.45136	-0.0258	0.4882	0.446	0.0422
i2	0.3588	0.35306	0.00574	0.5037	0.50846	-0.0048	0.3793	0.35668	0.02262
i3	0.2592	0.26104	-0.0018	0.4041	0.3439	0.0602	0.3559	0.40491	-0.049
i4	0.2343	0.19843	0.03587	0.2836	0.25905	0.02455	0.4862	0.4399	0.0463
i5	0.3301	0.32423	0.00587	0.3794	0.3434	0.036	0.582	0.60137	-0.0194
i6	0.2745	0.29888	-0.0244	0.4194	0.44557	-0.0262	0.247	0.23824	0.00876
i7	0.1348	0.16594	-0.0311	0.2797	0.21506	0.06464	0.3867	0.39432	-0.0076
i8	0.2445	0.24108	0.00342	0.1699	0.22117	-0.0513	0.4964	0.51225	-0.0159
i9	0.3476	0.30476	0.04284	0.273	0.28389	-0.0109	0.5995	0.53008	0.06942
i10	0.3933	0.3628	0.0305	0.5382	0.51762	0.02058	0.1281	0.1904	-0.0623
i11		0.02144	-0.0214		0.02386	-0.0239		0.01639	-0.0164
i12	0.4209	0.42217	-0.0013	0.3463	0.35589	-0.0096	0.4713	0.4469	0.0244
i13	0.5603	0.56079	-0.0005	0.4857	0.46069	0.02501	0.6321	0.65468	-0.0226
i14	0.4815	0.50309	-0.0216	0.6331	0.55341	0.07969	0.2526	0.26268	-0.0101
i15	0.5307	0.52237	0.00833	0.456	0.46017	-0.0042	0.3615	0.36893	-0.0074
i16	0.6266	0.63594	-0.0093	0.552	0.60312	-0.0511	0.5418	0.50516	0.03664
Neuron Results	Average	Diff (Full)	0.0185	Average	Diff (Full)	0.03239	Average	Diff (Full)	0.02881
	Average	Diff (Mod)	0.0183	Average	Diff (Mod)	0.03296	Average	Diff (Mod)	0.02964
	Std Dev	Diff (Full)	0.01634	Std Dev	Diff (Full)	0.02269	Std Dev	Diff (Full)	0.01982
	Std Dev	Diff (Mod)	0.01689	Std Dev	Diff (Mod)	0.02337	Std Dev	Diff (Mod)	0.02023

Destination	Neuron o4 (Route 12)			Neuron o5 (Route 14)			Neuron o6 (Route 15)		
	Target	Meas	Diff	Target	Meas	Diff	Target	Meas	Diff
i1	0.5759	0.6301	-0.0542	0.6182	0.60604	0.01216	0.7023	0.67104	0.03126
i2	0.6541	0.63262	0.02148	0.5092	0.50591	0.00329	0.6088	0.61179	-0.003
i3	0.5545	0.48891	0.06559	0.4859	0.52778	-0.0419	0.5854	0.55569	0.02971
i4	0.4339	0.46464	-0.0307	0.6162	0.58517	0.03103	0.5603	0.59134	-0.031
i5	0.4732	0.464	0.0092	0.712	0.6744	0.0376	0.5997	0.61421	-0.0145
i6	0.5696	0.529	0.0406	0.3769	0.35253	0.02437	0.4765	0.47097	0.00553
i7	0.43	0.40619	0.02381	0.5166	0.53532	-0.0187	0.5564	0.53716	0.01924
i8	0.3203	0.27664	0.04366	0.565	0.54384	0.02116	0.4467	0.43146	0.01524
i9	0.2853	0.30656	-0.0213	0.53	0.54596	-0.016	0.4117	0.43907	-0.0274
i10	0.4871	0.50336	-0.0163	0.2944	0.26367	0.03073	0.3939	0.38402	0.00988
i11		0.01979	-0.0198		0.01614	-0.0161		0.01719	-0.0172
i12	0.1439	0.2047	-0.0608	0.3886	0.36163	0.02697	0.2703	0.24801	0.02229
i13	0.3047	0.2825	0.0222	0.5494	0.55778	-0.0084	0.4311	0.37925	0.05185
i14	0.3626	0.34563	0.01697	0.1699	0.24152	-0.0716	0.2695	0.25818	0.01132
i15	0.2536	0.19728	0.05632	0.2789	0.25945	0.01945	0.1605	0.1837	-0.0232
i16	0.3496	0.34465	0.00495	0.4591	0.41313	0.04597	0.3408	0.32935	0.01145
Neuron Results	Average	Diff (Full)	0.03174	Average	Diff (Full)	0.02659	Average	Diff (Full)	0.02025
	Average	Diff (Mod)	0.03254	Average	Diff (Mod)	0.02729	Average	Diff (Mod)	0.02046
	Std Dev	Diff (Full)	0.01918	Std Dev	Diff (Full)	0.01683	Std Dev	Diff (Full)	0.01221
	Std Dev	Diff (Mod)	0.01957	Std Dev	Diff (Mod)	0.01718	Std Dev	Diff (Mod)	0.01261

Network Results	Average	Diff (Full)	0.02638	Std Dev	Diff (Full)	0.01845
	Average	Diff (Mod)	0.02686	Std Dev	Diff (Mod)	0.01895

Training Results for V1.2.08.6
(Netork 2.08.6, V1 Macro)

Destination	Neuron o1 (Route 7)			Neuron o2 (Route 8)			Neuron o3 (Route 10)		
	Target	Meas	Diff	Target	Meas	Diff	Target	Meas	Diff
i1	0.3763	0.3393	0.037	0.4256	0.44591	-0.0203	0.4882	0.47327	0.01493
i2	0.3588	0.33533	0.02347	0.5037	0.50079	0.00291	0.3793	0.34106	0.03824
i3	0.2592	0.27336	-0.0142	0.4041	0.39986	0.00424	0.3559	0.32425	0.03165
i4	0.2343	0.21966	0.01464	0.2836	0.25607	0.02753	0.4862	0.48454	0.00166
i5	0.3301	0.3674	-0.0373	0.3794	0.37739	0.00201	0.582	0.59385	-0.0119
i6	0.2745	0.25682	0.01768	0.4194	0.39924	0.02016	0.247	0.24445	0.00255
i7	0.1348	0.16452	-0.0297	0.2797	0.21088	0.06882	0.3867	0.39741	-0.0107
i8	0.2445	0.21343	0.03107	0.1699	0.20451	-0.0346	0.4964	0.50287	-0.0065
i9	0.3476	0.32686	0.02074	0.273	0.27621	-0.0032	0.5995	0.56513	0.03437
i10	0.3933	0.34171	0.05159	0.5382	0.5212	0.017	0.1281	0.18999	-0.0619
i11		0.02124	-0.0212		0.02389	-0.0239		0.01738	-0.0174
i12	0.4209	0.42851	-0.0076	0.3463	0.32723	0.01907	0.4713	0.47226	-0.001
i13	0.5603	0.53861	0.02169	0.4857	0.46542	0.02028	0.6321	0.60966	0.02244
i14	0.4815	0.50891	-0.0274	0.6331	0.65092	-0.0178	0.2526	0.17443	0.07817
i15	0.5307	0.53985	-0.0092	0.456	0.44991	0.00609	0.3615	0.37604	-0.0145
i16	0.6266	0.61148	0.01512	0.552	0.53611	0.01589	0.5418	0.55379	-0.012
Neuron Results	Average Diff (Full)		0.02372	Average Diff (Full)		0.01899	Average Diff (Full)		0.02249
	Average Diff (Mod)		0.02389	Average Diff (Mod)		0.01866	Average Diff (Mod)		0.02283
	Std Dev Diff (Full)		0.01159	Std Dev Diff (Full)		0.01638	Std Dev Diff (Full)		0.02189
	Std Dev Diff (Mod)		0.01198	Std Dev Diff (Mod)		0.0169	Std Dev Diff (Mod)		0.02261

Destination	Neuron o4 (Route 12)			Neuron o5 (Route 14)			Neuron o6 (Route 15)		
	Target	Meas	Diff	Target	Meas	Diff	Target	Meas	Diff
i1	0.5759	0.60478	-0.0289	0.6182	0.61441	0.00379	0.7023	0.65797	0.04433
i2	0.6541	0.64947	0.00463	0.5092	0.50728	0.00192	0.6088	0.62994	-0.0211
i3	0.5545	0.56139	-0.0069	0.4859	0.47805	0.00785	0.5854	0.57125	0.01415
i4	0.4339	0.42594	0.00796	0.6162	0.59929	0.01691	0.5603	0.56773	-0.0074
i5	0.4732	0.4597	0.0135	0.712	0.65478	0.05722	0.5997	0.58996	0.00974
i6	0.5696	0.53622	0.03338	0.3769	0.38282	-0.0059	0.4765	0.50588	-0.0294
i7	0.43	0.40664	0.02336	0.5166	0.53858	-0.022	0.5564	0.53605	0.02035
i8	0.3203	0.28837	0.03193	0.565	0.5513	0.0137	0.4467	0.44685	-0.0002
i9	0.2853	0.27248	0.01282	0.53	0.55417	-0.0242	0.4117	0.40904	0.00266
i10	0.4871	0.50188	-0.0148	0.2944	0.26061	0.03379	0.3939	0.39638	-0.0025
i11		0.02287	-0.0229		0.01911	-0.0191		0.02119	-0.0212
i12	0.1439	0.17667	-0.0328	0.3886	0.37191	0.01669	0.2703	0.22785	0.04245
i13	0.3047	0.33235	-0.0277	0.5494	0.55962	-0.0102	0.4311	0.41987	0.01123
i14	0.3626	0.35845	0.00415	0.1699	0.14863	0.02127	0.2695	0.21815	0.05135
i15	0.2536	0.16761	0.08599	0.2789	0.24806	0.03084	0.1605	0.15936	0.00114
i16	0.3496	0.30618	0.04342	0.4591	0.46552	-0.0064	0.3408	0.34009	0.00071
Neuron Results	Average Diff (Full)		0.02469	Average Diff (Full)		0.01824	Average Diff (Full)		0.01749
	Average Diff (Mod)		0.02481	Average Diff (Mod)		0.01818	Average Diff (Mod)		0.01725
	Std Dev Diff (Full)		0.0202	Std Dev Diff (Full)		0.01401	Std Dev Diff (Full)		0.01668
	Std Dev Diff (Mod)		0.0209	Std Dev Diff (Mod)		0.0145	Std Dev Diff (Mod)		0.01723

Network Results	Average Diff (Full)		0.02094	Std Dev Diff (Full)		0.01693
	Average Diff (Mod)		0.02094	Std Dev Diff (Mod)		0.01748

Training Results for V1.2.10.6
(Network 2.10.6, V1 Macro)

Destination	Neuron o1 (Route 7)			Neuron o2 (Route 8)			Neuron o3 (Route 10)		
	Target	Meas	Diff	Target	Meas	Diff	Target	Meas	Diff
i1	0.3763	0.34288	0.03342	0.4256	0.45625	-0.0307	0.4882	0.46024	0.02796
i2	0.3588	0.33848	0.02032	0.5037	0.50784	-0.0041	0.3793	0.32407	0.05523
i3	0.2592	0.27103	-0.0118	0.4041	0.4008	0.0033	0.3559	0.31452	0.04138
i4	0.2343	0.20854	0.02576	0.2836	0.25214	0.03146	0.4862	0.48968	-0.0035
i5	0.3301	0.35549	-0.0254	0.3794	0.35879	0.02061	0.582	0.62469	-0.0427
i6	0.2745	0.2576	0.0169	0.4194	0.39233	0.02707	0.247	0.25107	-0.0041
i7	0.1348	0.13883	-0.004	0.2797	0.19369	0.08601	0.3867	0.38978	-0.0031
i8	0.2445	0.17983	0.06467	0.1699	0.18864	-0.0187	0.4964	0.49543	0.00097
i9	0.3476	0.31847	0.02913	0.273	0.28456	-0.0116	0.5995	0.55046	0.04904
i10	0.3933	0.37848	0.01482	0.5382	0.52774	0.01046	0.1281	0.21266	-0.0846
i11		0.02429	-0.0243		0.02638	-0.0264		0.02446	-0.0245
i12	0.4209	0.45756	-0.0367	0.3463	0.31924	0.02706	0.4713	0.48184	-0.0105
i13	0.5603	0.5462	0.0141	0.4857	0.46326	0.02244	0.6321	0.62459	0.00751
i14	0.4815	0.49425	-0.0128	0.6331	0.64468	-0.0116	0.2526	0.16571	0.08689
i15	0.5307	0.51893	0.01177	0.456	0.45861	-0.0026	0.3615	0.36151	-1E-05
i16	0.6266	0.62673	-0.0001	0.552	0.55495	-0.003	0.5418	0.54498	-0.0032
Neuron Results	Average	Diff (Full)	0.02162	Average	Diff (Full)	0.02106	Average	Diff (Full)	0.02782
	Average	Diff (Mod)	0.02145	Average	Diff (Mod)	0.02071	Average	Diff (Mod)	0.02804
	Std Dev	Diff (Full)	0.01524	Std Dev	Diff (Full)	0.02015	Std Dev	Diff (Full)	0.02933
	Std Dev	Diff (Mod)	0.01576	Std Dev	Diff (Mod)	0.0208	Std Dev	Diff (Mod)	0.03035

Destination	Neuron o4 (Route 12)			Neuron o5 (Route 14)			Neuron o6 (Route 15)		
	Target	Meas	Diff	Target	Meas	Diff	Target	Meas	Diff
i1	0.5759	0.61843	-0.0425	0.6182	0.60379	0.01441	0.7023	0.6563	0.046
i2	0.6541	0.66501	-0.0109	0.5092	0.49114	0.01806	0.6088	0.63166	-0.0229
i3	0.5545	0.57336	-0.0189	0.4859	0.46759	0.01831	0.5854	0.57252	0.01288
i4	0.4339	0.42775	0.00615	0.6162	0.60484	0.01136	0.5603	0.56612	-0.0058
i5	0.4732	0.43626	0.03694	0.712	0.67862	0.03338	0.5997	0.58282	0.01688
i6	0.5696	0.53719	0.03241	0.3769	0.38614	-0.0092	0.4765	0.50828	-0.0318
i7	0.43	0.41733	0.01267	0.5166	0.53687	-0.0203	0.5564	0.54534	0.01106
i8	0.3203	0.29412	0.02618	0.565	0.55506	0.00994	0.4467	0.45656	-0.0099
i9	0.2853	0.28519	0.00011	0.53	0.55443	-0.0244	0.4117	0.41711	-0.0054
i10	0.4871	0.47372	0.01338	0.2944	0.26474	0.02966	0.3939	0.37715	0.01675
i11		0.02698	-0.027		0.02694	-0.0269		0.02743	-0.0274
i12	0.1439	0.14451	-0.0006	0.3886	0.36086	0.02774	0.2703	0.19605	0.07425
i13	0.3047	0.31116	-0.0065	0.5494	0.56882	-0.0194	0.4311	0.40826	0.02284
i14	0.3626	0.37839	-0.0158	0.1699	0.14639	0.02351	0.2695	0.23356	0.03594
i15	0.2536	0.20217	0.05143	0.2789	0.2645	0.0144	0.1605	0.1967	-0.0362
i16	0.3496	0.30118	0.04842	0.4591	0.45127	0.00783	0.3408	0.33281	0.00799
Neuron Results	Average	Diff (Full)	0.02186	Average	Diff (Full)	0.01931	Average	Diff (Full)	0.024
	Average	Diff (Mod)	0.02152	Average	Diff (Mod)	0.0188	Average	Diff (Mod)	0.02377
	Std Dev	Diff (Full)	0.01658	Std Dev	Diff (Full)	0.00781	Std Dev	Diff (Full)	0.01808
	Std Dev	Diff (Mod)	0.0171	Std Dev	Diff (Mod)	0.0078	Std Dev	Diff (Mod)	0.01869

Network Results	Average	Diff (Full)	0.02261	Std Dev	Diff (Full)	0.01867
	Average	Diff (Mod)	0.02238	Std Dev	Diff (Mod)	0.01927

Training Results for V2.2.06.2
(Network 2.06.2, V2 Macro)

Destination	Neuron o1 (Route 3)			Neuron o2 (Route 6)		
	Target	Meas	Diff	Target	Meas	Diff
i1	0.2569	0.31309	-0.0562	0.3986	0.34103	0.05757
i2		0.34317	-0.3432		0.3692	-0.3692
i3	0.1245	0.18544	-0.0609	0.2663	0.21066	0.05564
i4	0.3486	0.35828	-0.0097	0.3966	0.38638	0.01022
i5	0.4146	0.44063	-0.026	0.4924	0.46424	0.02816
i6	0.2335	0.18121	0.05229	0.1573	0.20552	-0.0482
i7	0.249	0.25843	-0.0094	0.297	0.28785	0.00915
i8	0.3588	0.36858	-0.0098	0.4068	0.39643	0.01037
i9	0.4618	0.47515	-0.0134	0.5097	0.4953	0.0144
i10	0.3524	0.29949	0.05291	0.2762	0.32862	-0.0524
i11	0.3588	0.35477	0.00403	0.3793	0.3831	-0.0038
i12	0.4776	0.47591	0.00169	0.4981	0.49988	-0.0018
i13	0.6385	0.64429	-0.0058	0.659	0.65273	0.00627
i14	0.4405	0.39559	0.04491	0.3643	0.41452	-0.0502
i15	0.4942	0.47607	0.01813	0.4733	0.49308	-0.0198
i16	0.6745	0.66514	0.00936	0.6536	0.66411	-0.0105
Neuron Results	Average	Diff (Full)	0.04486	Average	Diff (Full)	0.04673
	Average	Diff (Mod)	0.02497	Average	Diff (Mod)	0.02523
	Std Dev	Diff (Full)	0.0823	Std Dev	Diff (Full)	0.0884
	Std Dev	Diff (Mod)	0.02183	Std Dev	Diff (Mod)	0.02123
Network Results	Average	Diff (Full)	0.04579	Std Dev	Diff (Full)	0.08402
	Average	Diff (Mod)	0.0251	Std Dev	Diff (Mod)	0.02116

Training Results for V2.2.08.2
(Network 2.08.2, V2 Macro)

Destination	Neuron o1 (Route 3)			Neuron o2 (Route 6)		
	Target	Meas	Diff	Target	Meas	Diff
i1	0.2569	0.31318	-0.0563	0.3986	0.34232	0.05628
i2		0.34503	-0.345		0.37134	-0.3713
i3	0.1245	0.18331	-0.0588	0.2663	0.21173	0.05457
i4	0.3486	0.3582	-0.0096	0.3966	0.38664	0.00996
i5	0.4146	0.44087	-0.0263	0.4924	0.4644	0.028
i6	0.2335	0.18114	0.05236	0.1573	0.20675	-0.0495
i7	0.249	0.25793	-0.0089	0.297	0.28839	0.00861
i8	0.3588	0.36955	-0.0108	0.4068	0.39543	0.01137
i9	0.4618	0.47485	-0.0131	0.5097	0.49584	0.01386
i10	0.3524	0.30073	0.05167	0.2762	0.32784	-0.0516
i11	0.3588	0.35572	0.00308	0.3793	0.38211	-0.0028
i12	0.4776	0.47731	0.00029	0.4981	0.49838	-0.0003
i13	0.6385	0.64395	-0.0055	0.659	0.65322	0.00578
i14	0.4405	0.39338	0.04712	0.3643	0.41445	-0.0502
i15	0.4942	0.47578	0.01842	0.4733	0.49328	-0.02
i16	0.6745	0.66512	0.00938	0.6536	0.664	-0.0104
Neuron Results	Average	Diff (Full)	0.04478	Average	Diff (Full)	0.04653
	Average	Diff (Mod)	0.02476	Average	Diff (Mod)	0.02488
	Std Dev	Diff (Full)	0.0828	Std Dev	Diff (Full)	0.08901
	Std Dev	Diff (Mod)	0.02183	Std Dev	Diff (Mod)	0.02124
Network Results	Average	Diff (Full)	0.04566	Std Dev	Diff (Full)	0.08457
	Average	Diff (Mod)	0.02482	Std Dev	Diff (Mod)	0.02117

Training Results for V2.2.10.2
(Network 2.10.2, V2 Macro)

Destination	Neuron o1 (Route 3)			Neuron o2 (Route 6)		
	Target	Meas	Diff	Target	Meas	Diff
i1	0.2569	0.31316	-0.0563	0.3986	0.34247	0.05613
i2		0.33448	-0.3345		0.36095	-0.361
i3	0.1245	0.18482	-0.0603	0.2663	0.2105	0.0558
i4	0.3486	0.35899	-0.0104	0.3966	0.38575	0.01085
i5	0.4146	0.44122	-0.0266	0.4924	0.46391	0.02849
i6	0.2335	0.18149	0.05201	0.1573	0.20618	-0.0489
i7	0.249	0.25905	-0.0101	0.297	0.28724	0.00976
i8	0.3588	0.36995	-0.0112	0.4068	0.39499	0.01181
i9	0.4618	0.47465	-0.0129	0.5097	0.49594	0.01376
i10	0.3524	0.30013	0.05227	0.2762	0.32836	-0.0522
i11	0.3588	0.35577	0.00303	0.3793	0.38198	-0.0027
i12	0.4776	0.47662	0.00098	0.4981	0.49909	-0.001
i13	0.6385	0.6441	-0.0056	0.659	0.65277	0.00623
i14	0.4405	0.3921	0.0484	0.3643	0.4153	-0.051
i15	0.4942	0.4765	0.0177	0.4733	0.4926	-0.0193
i16	0.6745	0.66325	0.01125	0.6536	0.66586	-0.0123
Neuron Results	Average Diff (Full)		0.04459	Average Diff (Full)		0.04632
	Average Diff (Mod)		0.02526	Average Diff (Mod)		0.02534
	Std Dev Diff (Full)		0.08014	Std Dev Diff (Full)		0.08636
	Std Dev Diff (Mod)		0.02188	Std Dev Diff (Mod)		0.02116
Network Results	Average Diff (Full)		0.04545	Std Dev Diff (Full)		0.08196
	Average Diff (Mod)		0.0253	Std Dev Diff (Mod)		0.02115

Training Results for V2.2.06.4
(Network 2.06.4, V2 Macro)

Destination	Neuron o1 (Route 5)			Neuron o2 (Route 8)		
	Target	Meas	Diff	Target	Meas	Diff
i1	0.3708	0.38399	-0.0132	0.3838	0.35059	0.03321
i2	0.6027	0.60233	0.00037	0.4619	0.46229	-0.0004
i3	0.5031	0.50783	-0.0047	0.3623	0.36139	0.00091
i4	0.3088	0.30664	0.00216	0.2418	0.25847	-0.0167
i5	0.213	0.25767	-0.0447	0.3376	0.2794	0.0582
i6	0.5481	0.54793	0.00017	0.3776	0.38121	-0.0036
i7	0.4084	0.39223	0.01617	0.2379	0.27368	-0.0358
i8	0.4225	0.36142	0.06108	0.1281	0.24601	-0.1179
i9		0.38876	-0.3888		0.21248	-0.2125
i10	0.6212	0.61758	0.00362	0.3761	0.37943	-0.0033
i11	0.5181	0.50669	0.01141	0.273	0.29045	-0.0175
i12	0.5989	0.58212	0.01678	0.3045	0.30689	-0.0024
i13	0.7597	0.78868	-0.029	0.4653	0.45896	0.00634
i14	0.663	0.6663	-0.0033	0.4179	0.40769	0.01021
i15	0.6536	0.66154	-0.0079	0.4085	0.37938	0.02912
i16	0.8046	0.82517	-0.0206	0.5102	0.50217	0.00803
Neuron Results	Average Diff (Full)	0.03899		Average Diff (Full)	0.03475	
	Average Diff (Mod)	0.01568		Average Diff (Mod)	0.0229	
	Std Dev Diff (Full)	0.09478		Std Dev Diff (Full)	0.05608	
	Std Dev Diff (Mod)	0.01745		Std Dev Diff (Mod)	0.03102	

Destination	Neuron o3 (Route 12)			Neuron o4 (Route 13)		
	Target	Meas	Diff	Target	Meas	Diff
i1	0.5985	0.59974	-0.0012	0.8306	0.84774	-0.0171
i2	0.6191	0.62235	-0.0032	0.8512	0.84645	0.00475
i3	0.5195	0.50448	0.01502	0.7516	0.76569	-0.0141
i4	0.4565	0.43547	0.02103	0.6886	0.70164	-0.013
i5	0.5523	0.5509	0.0014	0.7844	0.81159	-0.0272
i6	0.5072	0.49724	0.00996	0.7393	0.74685	-0.0076
i7	0.395	0.38184	0.01316	0.6271	0.62745	-0.0003
i8	0.3428	0.3317	0.0111	0.5749	0.55588	0.01902
i9		0.22271	-0.2227		0.37734	-0.3773
i10	0.3884	0.39953	-0.0111	0.6205	0.61139	0.00911
i11	0.2853	0.3072	-0.0219	0.5174	0.49998	0.01742
i12	0.1664	0.24706	-0.0807	0.3985	0.35617	0.04233
i13	0.3272	0.26207	0.06513	0.2377	0.27664	-0.0389
i14	0.3851	0.40448	-0.0194	0.6172	0.60606	0.01114
i15	0.2762	0.33001	-0.0538	0.5083	0.48314	0.02516
i16	0.3712	0.33564	0.03556	0.3929	0.41925	-0.0264
Neuron Results	Average Diff (Full)	0.03665		Average Diff (Full)	0.04068	
	Average Diff (Mod)	0.02425		Average Diff (Mod)	0.01824	
	Std Dev Diff (Full)	0.05481		Std Dev Diff (Full)	0.09051	
	Std Dev Diff (Mod)	0.02412		Std Dev Diff (Mod)	0.01195	

Network Results	Average Diff (Full)	0.03777	Std Dev Diff (Full)	0.07456
	Average Diff (Mod)	0.02027	Std Dev Diff (Mod)	0.02202

Training Results for V2.2.08.4
(Network 2.08.4, V2 Macro)

Destination	Neuron o1 (Route 5)			Neuron o2 (Route 8)				
	Target	Meas	Diff	Target	Meas	Diff		
i1	0.3708	0.38102	-0.0102	0.3838	0.35577	0.02803		
i2	0.6027	0.60416	-0.0015	0.4619	0.46389	-0.002		
i3	0.5031	0.50401	-0.0009	0.3623	0.36782	-0.0055		
i4	0.3088	0.30029	0.00851	0.2418	0.25907	-0.0173		
i5	0.213	0.26661	-0.0536	0.3376	0.28925	0.04835		
i6	0.5481	0.5502	-0.0021	0.3776	0.38232	-0.0047		
i7	0.4084	0.39251	0.01589	0.2379	0.27058	-0.0327		
i8	0.4225	0.35983	0.06267	0.1281	0.24146	-0.1134		
i9		0.38955	-0.3896		0.23948	-0.2395		
i10	0.6212	0.62405	-0.0029	0.3761	0.37564	0.00046		
i11	0.5181	0.5156	0.0025	0.273	0.28839	-0.0154		
i12	0.5989	0.59143	0.00747	0.3045	0.3005	0.004		
i13	0.7597	0.77694	-0.0172	0.4653	0.4704	-0.0051		
i14	0.663	0.67633	-0.0133	0.4179	0.40034	0.01756		
i15	0.6536	0.66248	-0.0089	0.4085	0.34862	0.05988		
i16	0.8046	0.81876	-0.0142	0.5102	0.51038	-0.0002		
Neuron Results	Average	Diff	(Full)	0.03821	Average	Diff	(Full)	0.03712
	Average	Diff	(Mod)	0.01479	Average	Diff	(Mod)	0.02363
	Std Dev	Diff	(Full)	0.09538	Std Dev	Diff	(Full)	0.06157
	Std Dev	Diff	(Mod)	0.01848	Std Dev	Diff	(Mod)	0.0307

Destination	Neuron o3 (Route 12)			Neuron o4 (Route 13)				
	Target	Meas	Diff	Target	Meas	Diff		
i1	0.5985	0.60624	-0.0077	0.8306	0.84239	-0.0118		
i2	0.6191	0.62525	-0.0061	0.8512	0.84649	0.00471		
i3	0.5195	0.51206	0.00744	0.7516	0.76105	-0.0094		
i4	0.4565	0.44006	0.01644	0.6886	0.7017	-0.0131		
i5	0.5523	0.55628	-0.004	0.7844	0.8042	-0.0198		
i6	0.5072	0.49994	0.00726	0.7393	0.74843	-0.0091		
i7	0.395	0.38019	0.01481	0.6271	0.63425	-0.0071		
i8	0.3428	0.32986	0.01294	0.5749	0.56508	0.00982		
i9		0.29655	-0.2966		0.51137	-0.5114		
i10	0.3884	0.39517	-0.0068	0.6205	0.61837	0.00213		
i11	0.2853	0.29939	-0.0141	0.5174	0.50186	0.01554		
i12	0.1664	0.23937	-0.073	0.3985	0.37122	0.02728		
i13	0.3272	0.27988	0.04732	0.2377	0.26393	-0.0262		
i14	0.3851	0.39596	-0.0109	0.6172	0.61662	0.00058		
i15	0.2762	0.33044	-0.0542	0.5083	0.49114	0.01716		
i16	0.3712	0.34606	0.02514	0.3929	0.40855	-0.0157		
Neuron Results	Average	Diff	(Full)	0.03779	Average	Diff	(Full)	0.04381
	Average	Diff	(Mod)	0.02054	Average	Diff	(Mod)	0.01263
	Std Dev	Diff	(Full)	0.07186	Std Dev	Diff	(Full)	0.12492
	Std Dev	Diff	(Mod)	0.02079	Std Dev	Diff	(Mod)	0.00788

Network Results	Average	Diff	(Full)	0.03923	Std Dev	Diff	(Full)	0.08956
	Average	Diff	(Mod)	0.0179	Std Dev	Diff	(Mod)	0.02101

Training Results for V2.2.10.4
(Network 2.08.4, V2 Macro)

Destination	Neuron o1 (Route 5)			Neuron o2 (Route 8)		
	Target	Meas	Diff	Target	Meas	Diff
i1	0.3708	0.3779	-0.0071	0.3838	0.35714	0.02666
i2	0.6027	0.60212	0.00058	0.4619	0.46571	-0.0038
i3	0.5031	0.50546	-0.0024	0.3623	0.36542	-0.0031
i4	0.3088	0.31018	-0.0014	0.2418	0.26116	-0.0194
i5	0.213	0.24618	-0.0332	0.3376	0.29302	0.04458
i6	0.5481	0.55125	-0.0031	0.3776	0.37959	-0.002
i7	0.4084	0.40363	0.00477	0.2379	0.26359	-0.0257
i8	0.4225	0.37297	0.04953	0.1281	0.23745	-0.1094
i9		0.45799	-0.458		0.31976	-0.3198
i10	0.6212	0.62135	-0.0001	0.3761	0.37616	-6E-05
i11	0.5181	0.50856	0.00954	0.273	0.28921	-0.0162
i12	0.5989	0.59116	0.00774	0.3045	0.29978	0.00472
i13	0.7597	0.77617	-0.0165	0.4653	0.4692	-0.0039
i14	0.663	0.67276	-0.0098	0.4179	0.40156	0.01634
i15	0.6536	0.66086	-0.0073	0.4085	0.38204	0.02646
i16	0.8046	0.82075	-0.0162	0.5102	0.50839	0.00181
Neuron Results	Average	Diff (Full)	0.03919	Average	Diff (Full)	0.03899
	Average	Diff (Mod)	0.01127	Average	Diff (Mod)	0.02027
	Std Dev	Diff (Full)	0.11244	Std Dev	Diff (Full)	0.07955
	Std Dev	Diff (Mod)	0.01355	Std Dev	Diff (Mod)	0.02781

Destination	Neuron o3 (Route 12)			Neuron o4 (Route 13)		
	Target	Meas	Diff	Target	Meas	Diff
i1	0.5985	0.60495	-0.0064	0.8306	0.8447	-0.0141
i2	0.6191	0.62475	-0.0057	0.8512	0.84417	0.00703
i3	0.5195	0.51082	0.00868	0.7516	0.76138	-0.0098
i4	0.4565	0.43557	0.02093	0.6886	0.70075	-0.0122
i5	0.5523	0.56083	-0.0085	0.7844	0.80292	-0.0185
i6	0.5072	0.49889	0.00831	0.7393	0.74886	-0.0096
i7	0.395	0.37291	0.02209	0.6271	0.63743	-0.0103
i8	0.3428	0.32404	0.01876	0.5749	0.56832	0.00658
i9		0.44419	-0.4442		0.70048	-0.7005
i10	0.3884	0.39882	-0.0104	0.6205	0.61479	0.00571
i11	0.2853	0.30611	-0.0208	0.5174	0.50194	0.01546
i12	0.1664	0.24297	-0.0766	0.3985	0.36923	0.02927
i13	0.3272	0.2716	0.0556	0.2377	0.26865	-0.031
i14	0.3851	0.40075	-0.0157	0.6172	0.61169	0.00551
i15	0.2762	0.33292	-0.0567	0.5083	0.48511	0.02319
i16	0.3712	0.34059	0.03061	0.3929	0.41279	-0.0199
Neuron Results	Average	Diff (Full)	0.05062	Average	Diff (Full)	0.05741
	Average	Diff (Mod)	0.02439	Average	Diff (Mod)	0.01454
	Std Dev	Diff (Full)	0.10701	Std Dev	Diff (Full)	0.17167
	Std Dev	Diff (Mod)	0.02162	Std Dev	Diff (Mod)	0.00827

Network Results	Average	Diff (Full)	0.04655	Std Dev	Diff (Full)	0.11968
	Average	Diff (Mod)	0.01762	Std Dev	Diff (Mod)	0.0195

Training Results for V2.2.06.6
(Network 2.06.6, V2 Macro)

Destination	Neuron o1 (Route 7)			Neuron o2 (Route 8)			Neuron o3 (Route 10)		
	Target	Meas	Diff	Target	Meas	Diff	Target	Meas	Diff
i1	0.3763	0.32439	0.05191	0.4256	0.45136	-0.0258	0.4882	0.446	0.0422
i2	0.3588	0.35306	0.00574	0.5037	0.50846	-0.0048	0.3793	0.35668	0.02262
i3	0.2592	0.26104	-0.0018	0.4041	0.3439	0.0602	0.3559	0.40491	-0.049
i4	0.2343	0.19843	0.03587	0.2836	0.25905	0.02455	0.4862	0.4399	0.0463
i5	0.3301	0.32423	0.00587	0.3794	0.3434	0.036	0.582	0.60137	-0.0194
i6	0.2745	0.29888	-0.0244	0.4194	0.44557	-0.0262	0.247	0.23824	0.00876
i7	0.1348	0.16594	-0.0311	0.2797	0.21506	0.06464	0.3867	0.39432	-0.0076
i8	0.2445	0.24108	0.00342	0.1699	0.22117	-0.0513	0.4964	0.51225	-0.0159
i9	0.3476	0.30476	0.04284	0.273	0.28389	-0.0109	0.5995	0.53008	0.06942
i10	0.3933	0.3628	0.0305	0.5382	0.51762	0.02058	0.1281	0.1904	-0.0623
i11		0.02144	-0.0214		0.02386	-0.0239		0.01639	-0.0164
i12	0.4209	0.42217	-0.0013	0.3463	0.35589	-0.0096	0.4713	0.4469	0.0244
i13	0.5603	0.56079	-0.0005	0.4857	0.46069	0.02501	0.6321	0.65468	-0.0226
i14	0.4815	0.50309	-0.0216	0.6331	0.55341	0.07969	0.2526	0.26268	-0.0101
i15	0.5307	0.52237	0.00833	0.456	0.46017	-0.0042	0.3615	0.36893	-0.0074
i16	0.6266	0.63594	-0.0093	0.552	0.60312	-0.0511	0.5418	0.50516	0.03664
Neuron Results	Average Diff (Full)		0.0185	Average Diff (Full)		0.03239	Average Diff (Full)		0.02881
	Average Diff (Mod)		0.0183	Average Diff (Mod)		0.03296	Average Diff (Mod)		0.02964
	Std Dev Diff (Full)		0.01634	Std Dev Diff (Full)		0.02269	Std Dev Diff (Full)		0.01982
	Std Dev Diff (Mod)		0.01689	Std Dev Diff (Mod)		0.02337	Std Dev Diff (Mod)		0.02023

Destination	Neuron o4 (Route 12)			Neuron o5 (Route 14)			Neuron o6 (Route 15)		
	Target	Meas	Diff	Target	Meas	Diff	Target	Meas	Diff
i1	0.5759	0.6301	-0.0542	0.6182	0.60604	0.01216	0.7023	0.67104	0.03126
i2	0.6541	0.63262	0.02148	0.5092	0.50591	0.00329	0.6088	0.61179	-0.003
i3	0.5545	0.48891	0.06559	0.4859	0.52778	-0.0419	0.5854	0.55569	0.02971
i4	0.4339	0.46464	-0.0307	0.6162	0.58517	0.03103	0.5603	0.59134	-0.031
i5	0.4732	0.464	0.0092	0.712	0.6744	0.0376	0.5997	0.61421	-0.0145
i6	0.5696	0.529	0.0406	0.3769	0.35253	0.02437	0.4765	0.47097	0.00553
i7	0.43	0.40619	0.02381	0.5166	0.53532	-0.0187	0.5564	0.53716	0.01924
i8	0.3203	0.27664	0.04366	0.565	0.54384	0.02116	0.4467	0.43146	0.01524
i9	0.2853	0.30656	-0.0213	0.53	0.54596	-0.016	0.4117	0.43907	-0.0274
i10	0.4871	0.50336	-0.0163	0.2944	0.26367	0.03073	0.3939	0.38402	0.00988
i11		0.01979	-0.0198		0.01614	-0.0161		0.01719	-0.0172
i12	0.1439	0.2047	-0.0608	0.3886	0.36163	0.02697	0.2703	0.24801	0.02229
i13	0.3047	0.2825	0.0222	0.5494	0.55778	-0.0084	0.4311	0.37925	0.05185
i14	0.3626	0.34563	0.01697	0.1699	0.24152	-0.0716	0.2695	0.25818	0.01132
i15	0.2536	0.19728	0.05632	0.2789	0.25945	0.01945	0.1605	0.1837	-0.0232
i16	0.3496	0.34465	0.00495	0.4591	0.41313	0.04597	0.3408	0.32935	0.01145
Neuron Results	Average Diff (Full)		0.03174	Average Diff (Full)		0.02659	Average Diff (Full)		0.02025
	Average Diff (Mod)		0.03254	Average Diff (Mod)		0.02729	Average Diff (Mod)		0.02046
	Std Dev Diff (Full)		0.01918	Std Dev Diff (Full)		0.01683	Std Dev Diff (Full)		0.01221
	Std Dev Diff (Mod)		0.01957	Std Dev Diff (Mod)		0.01718	Std Dev Diff (Mod)		0.01261

Network Results	Average Diff (Full)		0.02638	Std Dev Diff (Full)		0.01845
	Average Diff (Mod)		0.02686	Std Dev Diff (Mod)		0.01895

Training Results for V2.2.08.6
(Network 2.08.6, V2 Macro)

Destination	Neuron o1 (Route 7)			Neuron o2 (Route 8)			Neuron o3 (Route 10)		
	Target	Meas	Diff	Target	Meas	Diff	Target	Meas	Diff
i1	0.3763	0.34989	0.02641	0.4256	0.44766	-0.0221	0.4882	0.50168	-0.0135
i2	0.3588	0.35131	0.00749	0.5037	0.51887	-0.0152	0.3793	0.34988	0.02942
i3	0.2592	0.278	-0.0188	0.4041	0.40148	0.00262	0.3559	0.34364	0.01226
i4	0.2343	0.23981	-0.0055	0.2836	0.27888	0.00472	0.4862	0.49181	-0.0056
i5	0.3301	0.34644	-0.0163	0.3794	0.36482	0.01458	0.582	0.60199	-0.02
i6	0.2745	0.27247	0.00203	0.4194	0.42186	-0.0025	0.247	0.24741	-0.0004
i7	0.1348	0.17916	-0.0444	0.2797	0.24171	0.03799	0.3867	0.38033	0.00637
i8	0.2445	0.21329	0.03121	0.1699	0.20355	-0.0337	0.4964	0.50761	-0.0112
i9	0.3476	0.35041	-0.0028	0.273	0.28958	-0.0166	0.5995	0.57666	0.02284
i10	0.3933	0.37683	0.01647	0.5382	0.53924	-0.001	0.1281	0.21147	-0.0834
i11		0.12014	-0.1201		0.14408	-0.1441		0.10032	-0.1003
i12	0.4209	0.42925	-0.0084	0.3463	0.33122	0.01508	0.4713	0.47947	-0.0082
i13	0.5603	0.56671	-0.0064	0.4857	0.4784	0.0073	0.6321	0.63009	0.00201
i14	0.4815	0.50412	-0.0226	0.6331	0.62399	0.00911	0.2526	0.21006	0.04254
i15	0.5307	0.52689	0.00381	0.456	0.46873	-0.0127	0.3615	0.36895	-0.0075
i16	0.6266	0.62308	0.00352	0.552	0.56157	-0.0096	0.5418	0.54554	-0.0037
Neuron Results	Average Diff (Full)	0.02102	Average Diff (Full)	0.0218	Average Diff (Full)	0.02307			
	Average Diff (Mod)	0.01441	Average Diff (Mod)	0.01364	Average Diff (Mod)	0.01792			
	Std Dev Diff (Full)	0.02903	Std Dev Diff (Full)	0.03425	Std Dev Diff (Full)	0.02917			
	Std Dev Diff (Mod)	0.01243	Std Dev Diff (Mod)	0.01083	Std Dev Diff (Mod)	0.02138			

Destination	Neuron o4 (Route 12)			Neuron o5 (Route 14)			Neuron o6 (Route 15)		
	Target	Meas	Diff	Target	Meas	Diff	Target	Meas	Diff
i1	0.5759	0.59753	-0.0216	0.6182	0.63449	-0.0163	0.7023	0.66152	0.04078
i2	0.6541	0.6518	0.0023	0.5092	0.51202	-0.0028	0.6088	0.62874	-0.0199
i3	0.5545	0.5615	-0.007	0.4859	0.49729	-0.0114	0.5854	0.57951	0.00589
i4	0.4339	0.43794	-0.004	0.6162	0.60423	0.01197	0.5603	0.57311	-0.0128
i5	0.4732	0.47912	-0.0059	0.712	0.67723	0.03477	0.5997	0.61911	-0.0194
i6	0.5696	0.54388	0.02572	0.3769	0.38157	-0.0047	0.4765	0.50456	-0.0281
i7	0.43	0.44009	-0.0101	0.5166	0.53112	-0.0145	0.5564	0.54869	0.00771
i8	0.3203	0.29372	0.02658	0.565	0.56293	0.00207	0.4467	0.45945	-0.0128
i9	0.2853	0.27489	0.01041	0.53	0.55874	-0.0287	0.4117	0.4123	-0.0006
i10	0.4871	0.49321	-0.0061	0.2944	0.27209	0.02231	0.3939	0.38723	0.00667
i11		0.13914	-0.1391		0.11668	-0.1167		0.13107	-0.1311
i12	0.1439	0.19242	-0.0485	0.3886	0.38527	0.00333	0.2703	0.25	0.0203
i13	0.3047	0.3262	-0.0215	0.5494	0.56229	-0.0129	0.4311	0.41555	0.01555
i14	0.3626	0.37717	-0.0146	0.1699	0.18989	-0.02	0.2695	0.25017	0.01933
i15	0.2536	0.21362	0.03998	0.2789	0.26572	0.01318	0.1605	0.19905	-0.0386
i16	0.3496	0.33426	0.01534	0.4591	0.45888	0.00022	0.3408	0.35561	-0.0148
Neuron Results	Average Diff (Full)	0.02493	Average Diff (Full)	0.01974	Average Diff (Full)	0.02464			
	Average Diff (Mod)	0.01731	Average Diff (Mod)	0.01328	Average Diff (Mod)	0.01754			
	Std Dev Diff (Full)	0.03313	Std Dev Diff (Full)	0.02762	Std Dev Diff (Full)	0.03043			
	Std Dev Diff (Mod)	0.01351	Std Dev Diff (Mod)	0.01008	Std Dev Diff (Mod)	0.01136			

Network Results	Average Diff (Full)	0.02253	Std Dev Diff (Full)	0.02994
	Average Diff (Mod)	0.01569	Std Dev Diff (Mod)	0.01354

Training Results for V2.2.10.6
(Network 2.10.6, V2 Macro)

Destination	Neuron o1 (Route 7)			Neuron o2 (Route 8)			Neuron o3 (Route 10)		
	Target	Meas	Diff	Target	Meas	Diff	Target	Meas	Diff
i1	0.3763	0.35425	0.02205	0.4256	0.45679	-0.0312	0.4882	0.48911	-0.0009
i2	0.3588	0.35134	0.00746	0.5037	0.52054	-0.0168	0.3793	0.33574	0.04356
i3	0.2592	0.28094	-0.0217	0.4041	0.40064	0.00346	0.3559	0.34572	0.01018
i4	0.2343	0.23299	0.00131	0.2836	0.27671	0.00689	0.4862	0.49181	-0.0056
i5	0.3301	0.35584	-0.0257	0.3794	0.36973	0.00967	0.582	0.61262	-0.0306
i6	0.2745	0.27319	0.00131	0.4194	0.40513	0.01427	0.247	0.26876	-0.0218
i7	0.1348	0.16786	-0.0331	0.2797	0.22475	0.05495	0.3867	0.39726	-0.0106
i8	0.2445	0.20867	0.03583	0.1699	0.21174	-0.0418	0.4964	0.50053	-0.0041
i9	0.3476	0.34698	0.00062	0.273	0.30508	-0.0321	0.5995	0.55763	0.04187
i10	0.3933	0.39468	-0.0014	0.5382	0.53429	0.00391	0.1281	0.23331	-0.1052
i11		0.07305	-0.0731		0.08209	-0.0821		0.07634	-0.0763
i12	0.4209	0.44293	-0.022	0.3463	0.3238	0.0225	0.4713	0.48487	-0.0136
i13	0.5603	0.56352	-0.0032	0.4857	0.48074	0.00496	0.6321	0.62865	0.00345
i14	0.4815	0.49609	-0.0146	0.6331	0.63187	0.00123	0.2526	0.18723	0.06537
i15	0.5307	0.51708	0.01362	0.456	0.46736	-0.0114	0.3615	0.36747	-0.006
i16	0.6266	0.62369	0.00291	0.552	0.56127	-0.0093	0.5418	0.54884	-0.007
Neuron Results	Average Diff (Full)		0.0175	Average Diff (Full)		0.02166	Average Diff (Full)		0.02788
	Average Diff (Mod)		0.01379	Average Diff (Mod)		0.01763	Average Diff (Mod)		0.02465
	Std Dev Diff (Full)		0.01898	Std Dev Diff (Full)		0.02223	Std Dev Diff (Full)		0.03092
	Std Dev Diff (Mod)		0.01227	Std Dev Diff (Mod)		0.01584	Std Dev Diff (Mod)		0.02907

Destination	Neuron o4 (Route 12)			Neuron o5 (Route 14)			Neuron o6 (Route 15)		
	Target	Meas	Diff	Target	Meas	Diff	Target	Meas	Diff
i1	0.5759	0.61042	-0.0345	0.6182	0.62439	-0.0062	0.7023	0.66108	0.04122
i2	0.6541	0.66451	-0.0104	0.5092	0.49877	0.01043	0.6088	0.63245	-0.0236
i3	0.5545	0.56398	-0.0095	0.4859	0.49399	-0.0081	0.5854	0.57875	0.00665
i4	0.4339	0.44254	-0.0086	0.6162	0.60665	0.00955	0.5603	0.5735	-0.0132
i5	0.4732	0.46698	0.00622	0.712	0.67986	0.03214	0.5997	0.60545	-0.0058
i6	0.5696	0.53378	0.03582	0.3769	0.3989	-0.022	0.4765	0.50957	-0.0331
i7	0.43	0.42935	0.00065	0.5166	0.54023	-0.0236	0.5564	0.54766	0.00874
i8	0.3203	0.30773	0.01257	0.565	0.56054	0.00446	0.4467	0.46447	-0.0178
i9	0.2853	0.29624	-0.0109	0.53	0.55496	-0.025	0.4117	0.42341	-0.0117
i10	0.4871	0.47447	0.01263	0.2944	0.28239	0.01201	0.3939	0.38312	0.01078
i11		0.08528	-0.0853		0.08725	-0.0873		0.08877	-0.0888
i12	0.1439	0.1722	-0.0283	0.3886	0.38151	0.00709	0.2703	0.23006	0.04024
i13	0.3047	0.32577	-0.0211	0.5494	0.56786	-0.0185	0.4311	0.41661	0.01449
i14	0.3626	0.38819	-0.0256	0.1699	0.17068	-0.0008	0.2695	0.24993	0.01957
i15	0.2536	0.22715	0.02645	0.2789	0.27825	0.00065	0.1605	0.21797	-0.0575
i16	0.3496	0.32831	0.02129	0.4591	0.46231	-0.0032	0.3408	0.3557	-0.0149
Neuron Results	Average Diff (Full)		0.02187	Average Diff (Full)		0.01693	Average Diff (Full)		0.0255
	Average Diff (Mod)		0.01764	Average Diff (Mod)		0.01224	Average Diff (Mod)		0.02128
	Std Dev Diff (Full)		0.01983	Std Dev Diff (Full)		0.02097	Std Dev Diff (Full)		0.02231
	Std Dev Diff (Mod)		0.01072	Std Dev Diff (Mod)		0.00971	Std Dev Diff (Mod)		0.0151

Network Results	Average Diff (Full)	0.02189	Std Dev Diff (Full)	0.02262
	Average Diff (Mod)	0.01787	Std Dev Diff (Mod)	0.01682

Training Results for V3.2.06.2
(Network 2.06.2, V3 Macro)

Destination	Neuron o1 (Route 3)			Neuron o2 (Route 6)		
	Target	Meas	Diff	Target	Meas	Diff
i1	0.2569	0.31049	-0.0536	0.3986	0.33101	0.06759
i2		0.34236	-0.3424		0.36397	-0.364
i3	0.1245	0.18644	-0.0619	0.2663	0.20039	0.06591
i4	0.3486	0.35875	-0.0102	0.3966	0.38062	0.01598
i5	0.4146	0.43977	-0.0252	0.4924	0.46274	0.02966
i6	0.2335	0.18409	0.04941	0.1573	0.1979	-0.0406
i7	0.249	0.25922	-0.0102	0.297	0.27779	0.01921
i8	0.3588	0.36754	-0.0087	0.4068	0.38984	0.01696
i9	0.4618	0.47429	-0.0125	0.5097	0.49697	0.01273
i10	0.3524	0.29601	0.05639	0.2762	0.31654	-0.0403
i11	0.3588	0.3499	0.0089	0.3793	0.37245	0.00685
i12	0.4776	0.47677	0.00083	0.4981	0.49934	-0.0012
i13	0.6385	0.64158	-0.0031	0.659	0.65952	-0.0005
i14	0.4405	0.38562	0.05488	0.3643	0.40742	-0.0431
i15	0.4942	0.47366	0.02054	0.4733	0.49545	-0.0222
i16	0.6745	0.65827	0.01623	0.6536	0.6753	-0.0217
Neuron Results	Average	Diff (Full)	0.04593	Average	Diff (Full)	0.04803
	Average	Diff (Mod)	0.02617	Average	Diff (Mod)	0.02697
	Std Dev	Diff (Full)	0.08191	Std Dev	Diff (Full)	0.08663
	Std Dev	Diff (Mod)	0.02223	Std Dev	Diff (Mod)	0.02087
Network Results	Average	Diff (Full)	0.04698	Std Dev	Diff (Full)	0.08294
	Average	Diff (Mod)	0.02657	Std Dev	Diff (Mod)	0.02119

Training Results for V3.2.08.2
(Network 2.08.8, V3 Macro)

Destination	Neuron o1 (Route 3)			Neuron o2 (Route 6)		
	Target	Meas	Diff	Target	Meas	Diff
i1	0.2569	0.3107	-0.0538	0.3986	0.33231	0.06629
i2		0.34226	-0.3423		0.36426	-0.3643
i3	0.1245	0.18445	-0.06	0.2663	0.20049	0.06581
i4	0.3486	0.35909	-0.0105	0.3966	0.38145	0.01515
i5	0.4146	0.44047	-0.0259	0.4924	0.46309	0.02931
i6	0.2335	0.18575	0.04775	0.1573	0.20162	-0.0443
i7	0.249	0.25662	-0.0076	0.297	0.27662	0.02038
i8	0.3588	0.36594	-0.0071	0.4068	0.38819	0.01861
i9	0.4618	0.47484	-0.013	0.5097	0.49684	0.01286
i10	0.3524	0.29729	0.05511	0.2762	0.31842	-0.0422
i11	0.3588	0.34732	0.01148	0.3793	0.36972	0.00958
i12	0.4776	0.4762	0.0014	0.4981	0.49844	-0.0003
i13	0.6385	0.64155	-0.0031	0.659	0.65891	9E-05
i14	0.4405	0.38401	0.05649	0.3643	0.4061	-0.0418
i15	0.4942	0.47473	0.01947	0.4733	0.49571	-0.0224
i16	0.6745	0.65868	0.01582	0.6536	0.67354	-0.0199
Neuron Results	Average	Diff (Full)	0.04567	Average	Diff (Full)	0.04834
	Average	Diff (Mod)	0.0259	Average	Diff (Mod)	0.02727
	Std Dev	Diff (Full)	0.08189	Std Dev	Diff (Full)	0.08661
	Std Dev	Diff (Mod)	0.02198	Std Dev	Diff (Mod)	0.02082
Network Results	Average	Diff (Full)	0.047	Std Dev	Diff (Full)	0.08293
	Average	Diff (Mod)	0.02659	Std Dev	Diff (Mod)	0.02105

Training Results for V3.2.10.2
(Network 2.10.2, V3 Macro)

Destination	Neuron o1 (Route 3)			Neuron o2 (Route 6)				
	Target	Meas	Diff	Target	Meas	Diff		
i1	0.2569	0.31285	-0.056	0.3986	0.33566	0.06294		
i2		0.33186	-0.3319		0.35402	-0.354		
i3	0.1245	0.18222	-0.0577	0.2663	0.19812	0.06818		
i4	0.3486	0.35857	-0.01	0.3966	0.38115	0.01545		
i5	0.4146	0.43791	-0.0233	0.4924	0.46084	0.03156		
i6	0.2335	0.18441	0.04909	0.1573	0.20062	-0.0433		
i7	0.249	0.25697	-0.008	0.297	0.27713	0.01987		
i8	0.3588	0.36222	-0.0034	0.4068	0.38876	0.01804		
i9	0.4618	0.47542	-0.0136	0.5097	0.4974	0.0123		
i10	0.3524	0.30009	0.05231	0.2762	0.32254	-0.0463		
i11	0.3588	0.34818	0.01062	0.3793	0.37104	0.00826		
i12	0.4776	0.47472	0.00288	0.4981	0.49775	0.00035		
i13	0.6385	0.64143	-0.0029	0.659	0.6583	0.0007		
i14	0.4405	0.37897	0.06153	0.3643	0.40217	-0.0379		
i15	0.4942	0.47414	0.02006	0.4733	0.49433	-0.021		
i16	0.6745	0.65897	0.01553	0.6536	0.67354	-0.0199		
Neuron Results	Average	Diff	(Full)	0.04492	Average	Diff	(Full)	0.04751
	Average	Diff	(Mod)	0.02579	Average	Diff	(Mod)	0.02708
	Std Dev	Diff	(Full)	0.07955	Std Dev	Diff	(Full)	0.08418
	Std Dev	Diff	(Mod)	0.02251	Std Dev	Diff	(Mod)	0.02085
Network Results	Average	Diff	(Full)	0.04622	Std Dev	Diff	(Full)	0.08058
	Average	Diff	(Mod)	0.02644	Std Dev	Diff	(Mod)	0.02133

Training Results for V3.2.06.4
(Network 2.06.4, V3 Macro)

Destination	Neuron o1 (Route 5)			Neuron o2 (Route 8)				
	Target	Meas	Diff	Target	Meas	Diff		
i1	0.3708	0.37876	-0.008	0.3838	0.34064	0.04316		
i2	0.6027	0.60405	-0.0013	0.4619	0.45794	0.00396		
i3	0.5031	0.50067	0.00243	0.3623	0.36096	0.00134		
i4	0.3088	0.30585	0.00295	0.2418	0.25409	-0.0123		
i5	0.213	0.26966	-0.0567	0.3376	0.27287	0.06473		
i6	0.5481	0.54266	0.00544	0.3776	0.37932	-0.0017		
i7	0.4084	0.36134	0.04706	0.2379	0.26173	-0.0238		
i8	0.4225	0.32404	0.09846	0.1281	0.23097	-0.1029		
i9		0.37377	-0.3738		0.21279	-0.2128		
i10	0.6212	0.61504	0.00616	0.3761	0.38052	-0.0044		
i11	0.5181	0.49745	0.02065	0.273	0.29117	-0.0182		
i12	0.5989	0.57771	0.02119	0.3045	0.30635	-0.0019		
i13	0.7597	0.78846	-0.0288	0.4653	0.44776	0.01754		
i14	0.663	0.66752	-0.0045	0.4179	0.40983	0.00807		
i15	0.6536	0.66155	-0.008	0.4085	0.38086	0.02764		
i16	0.8046	0.81807	-0.0135	0.5102	0.49415	0.01605		
Neuron Results	Average	Diff	(Full)	0.04367	Average	Diff	(Full)	0.03503
	Average	Diff	(Mod)	0.02167	Average	Diff	(Mod)	0.02318
	Std Dev	Diff	(Full)	0.0918	Std Dev	Diff	(Full)	0.05463
	Std Dev	Diff	(Mod)	0.02698	Std Dev	Diff	(Mod)	0.02811

Destination	Neuron o3 (Route 12)			Neuron o4 (Route 13)				
	Target	Meas	Diff	Target	Meas	Diff		
i1	0.5985	0.59804	0.00046	0.8306	0.85096	-0.0204		
i2	0.6191	0.61865	0.00045	0.8512	0.84572	0.00548		
i3	0.5195	0.505	0.0145	0.7516	0.75971	-0.0081		
i4	0.4565	0.43128	0.02522	0.6886	0.69797	-0.0094		
i5	0.5523	0.54344	0.00886	0.7844	0.81463	-0.0302		
i6	0.5072	0.49587	0.01133	0.7393	0.74216	-0.0029		
i7	0.395	0.38042	0.01458	0.6271	0.62438	0.00272		
i8	0.3428	0.32835	0.01445	0.5749	0.55223	0.02267		
i9		0.2227	-0.2227		0.36348	-0.3635		
i10	0.3884	0.39599	-0.0076	0.6205	0.60083	0.01967		
i11	0.2853	0.30311	-0.0178	0.5174	0.48059	0.03681		
i12	0.1664	0.23377	-0.0674	0.3985	0.32483	0.07367		
i13	0.3272	0.25269	0.07451	0.2377	0.28897	-0.0513		
i14	0.3851	0.3992	-0.0141	0.6172	0.59413	0.02307		
i15	0.2762	0.32251	-0.0463	0.5083	0.46754	0.04076		
i16	0.3712	0.3322	0.039	0.3929	0.43131	-0.0384		
Neuron Results	Average	Diff	(Full)	0.0362	Average	Diff	(Full)	0.04681
	Average	Diff	(Mod)	0.02377	Average	Diff	(Mod)	0.0257
	Std Dev	Diff	(Full)	0.05442	Std Dev	Diff	(Full)	0.08663
	Std Dev	Diff	(Mod)	0.02288	Std Dev	Diff	(Mod)	0.02001

Network Results	Average	Diff	(Full)	0.04043	Std Dev	Diff	(Full)	0.07235
	Average	Diff	(Mod)	0.02358	Std Dev	Diff	(Mod)	0.02412

Training Results for V3.2.08.4
(Network 2.08.4, V3 Macro)

Destination	Neuron o1 (Route 5)			Neuron o2 (Route 8)				
	Target	Meas	Diff	Target	Meas	Diff		
i1	0.3708	0.36703	0.00377	0.3838	0.33978	0.04402		
i2	0.6027	0.59848	0.00422	0.4619	0.45563	0.00627		
i3	0.5031	0.49015	0.01295	0.3623	0.35799	0.00431		
i4	0.3088	0.29216	0.01664	0.2418	0.24771	-0.0059		
i5	0.213	0.27974	-0.0667	0.3376	0.28056	0.05704		
i6	0.5481	0.53484	0.01326	0.3776	0.37314	0.00446		
i7	0.4084	0.35273	0.05567	0.2379	0.25287	-0.015		
i8	0.4225	0.31701	0.10549	0.1281	0.2219	-0.0938		
i9		0.37403	-0.374		0.2342	-0.2342		
i10	0.6212	0.62331	-0.0021	0.3761	0.3755	0.0006		
i11	0.5181	0.50364	0.01446	0.273	0.2849	-0.0119		
i12	0.5989	0.57346	0.02544	0.3045	0.29899	0.00551		
i13	0.7597	0.78055	-0.0208	0.4653	0.45453	0.01077		
i14	0.663	0.67192	-0.0089	0.4179	0.40214	0.01576		
i15	0.6536	0.6534	0.0002	0.4085	0.37477	0.03373		
i16	0.8046	0.8121	-0.0075	0.5102	0.49482	0.01538		
Neuron Results	Average	Diff	(Full)	0.04577	Average	Diff	(Full)	0.03491
	Average	Diff	(Mod)	0.02388	Average	Diff	(Mod)	0.02163
	Std Dev	Diff	(Full)	0.09207	Std Dev	Diff	(Full)	0.05864
	Std Dev	Diff	(Mod)	0.02953	Std Dev	Diff	(Mod)	0.02566

Destination	Neuron o3 (Route 12)			Neuron o4 (Route 13)				
	Target	Meas	Diff	Target	Meas	Diff		
i1	0.5985	0.59915	-0.0006	0.8306	0.84719	-0.0166		
i2	0.6191	0.61744	0.00166	0.8512	0.84278	0.00842		
i3	0.5195	0.50367	0.01583	0.7516	0.75358	-0.002		
i4	0.4565	0.42651	0.02999	0.6886	0.69321	-0.0046		
i5	0.5523	0.53994	0.01236	0.7844	0.80444	-0.02		
i6	0.5072	0.49132	0.01588	0.7393	0.73716	0.00214		
i7	0.395	0.37019	0.02481	0.6271	0.61763	0.00947		
i8	0.3428	0.31556	0.02724	0.5749	0.5403	0.0346		
i9		0.29107	-0.2911		0.49315	-0.4932		
i10	0.3884	0.3829	0.0055	0.6205	0.58695	0.03355		
i11	0.2853	0.2891	-0.0038	0.5174	0.4662	0.0512		
i12	0.1664	0.23659	-0.0702	0.3985	0.34665	0.05185		
i13	0.3272	0.26481	0.06239	0.2377	0.28451	-0.0468		
i14	0.3851	0.38833	-0.0032	0.6172	0.58684	0.03036		
i15	0.2762	0.32455	-0.0484	0.5083	0.47633	0.03197		
i16	0.3712	0.33749	0.03371	0.3929	0.42664	-0.0337		
Neuron Results	Average	Diff	(Full)	0.04042	Average	Diff	(Full)	0.05441
	Average	Diff	(Mod)	0.02371	Average	Diff	(Mod)	0.02516
	Std Dev	Diff	(Full)	0.07017	Std Dev	Diff	(Full)	0.11821
	Std Dev	Diff	(Mod)	0.02209	Std Dev	Diff	(Mod)	0.01749

Network Results	Average	Diff	(Full)	0.04388	Std Dev	Diff	(Full)	0.08596
	Average	Diff	(Mod)	0.02359	Std Dev	Diff	(Mod)	0.02352

Training Results for V3.2.10.4
(Network 2.10.4, V3 Macro)

Destination	Neuron o1 (Route 5)			Neuron o2 (Route 8)		
	Target	Meas	Diff	Target	Meas	Diff
i1	0.3708	0.372	-0.0012	0.3838	0.33996	0.04384
i2	0.6027	0.60148	0.00122	0.4619	0.45605	0.00585
i3	0.5031	0.49533	0.00777	0.3623	0.35898	0.00332
i4	0.3088	0.31182	-0.003	0.2418	0.2548	-0.013
i5	0.213	0.27762	-0.0646	0.3376	0.28193	0.05567
i6	0.5481	0.53986	0.00824	0.3776	0.3736	0.004
i7	0.4084	0.36558	0.04282	0.2379	0.25618	-0.0183
i8	0.4225	0.32402	0.09848	0.1281	0.22137	-0.0933
i9		0.443	-0.443		0.31402	-0.314
i10	0.6212	0.61367	0.00753	0.3761	0.37371	0.00239
i11	0.5181	0.49272	0.02538	0.273	0.28942	-0.0164
i12	0.5989	0.57665	0.02225	0.3045	0.3084	-0.0039
i13	0.7597	0.78569	-0.026	0.4653	0.45449	0.01081
i14	0.663	0.66629	-0.0033	0.4179	0.40131	0.01659
i15	0.6536	0.6536	0	0.4085	0.38058	0.02792
i16	0.8046	0.81814	-0.0135	0.5102	0.49975	0.01045
Neuron Results	Average	Diff (Full)	0.04802	Average	Diff (Full)	0.03998
	Average	Diff (Mod)	0.02169	Average	Diff (Mod)	0.02171
	Std Dev	Diff (Full)	0.10871	Std Dev	Diff (Full)	0.07698
	Std Dev	Diff (Mod)	0.02785	Std Dev	Diff (Mod)	0.02505

Destination	Neuron o3 (Route 12)			Neuron o4 (Route 13)		
	Target	Meas	Diff	Target	Meas	Diff
i1	0.5985	0.59644	0.00206	0.8306	0.84772	-0.0171
i2	0.6191	0.61877	0.00033	0.8512	0.84486	0.00634
i3	0.5195	0.50345	0.01605	0.7516	0.75345	-0.0018
i4	0.4565	0.42226	0.03424	0.6886	0.687	0.0016
i5	0.5523	0.54052	0.01178	0.7844	0.80542	-0.021
i6	0.5072	0.49096	0.01624	0.7393	0.73809	0.00121
i7	0.395	0.36971	0.02529	0.6271	0.61826	0.00884
i8	0.3428	0.30647	0.03633	0.5749	0.52701	0.04789
i9		0.43965	-0.4397		0.69181	-0.6918
i10	0.3884	0.38729	0.00111	0.6205	0.59039	0.03011
i11	0.2853	0.30184	-0.0165	0.5174	0.47867	0.03873
i12	0.1664	0.24764	-0.0812	0.3985	0.35374	0.04476
i13	0.3272	0.26393	0.06327	0.2377	0.28942	-0.0517
i14	0.3851	0.38816	-0.0031	0.6172	0.58155	0.03565
i15	0.2762	0.33204	-0.0558	0.5083	0.48184	0.02646
i16	0.3712	0.34386	0.02734	0.3929	0.4397	-0.0468
Neuron Results	Average	Diff (Full)	0.0519	Average	Diff (Full)	0.06699
	Average	Diff (Mod)	0.02605	Average	Diff (Mod)	0.02534
	Std Dev	Diff (Full)	0.10606	Std Dev	Diff (Full)	0.16757
	Std Dev	Diff (Mod)	0.02445	Std Dev	Diff (Mod)	0.01846

Network Results	Average	Diff (Full)	0.05172	Std Dev	Diff (Full)	0.11699
	Average	Diff (Mod)	0.0237	Std Dev	Diff (Mod)	0.02366

Training Results for V3.2.06.6
(Network 2.06.6, V3 Macro)

Destination	Neuron o1 (Route 7)			Neuron o2 (Route 8)			Neuron o3 (Route 10)		
	Target	Meas	Diff	Target	Meas	Diff	Target	Meas	Diff
i1	0.3763	0.31922	0.05708	0.4256	0.43095	-0.0054	0.4882	0.45639	0.03181
i2	0.3588	0.33716	0.02164	0.5037	0.48239	0.02131	0.3793	0.35724	0.02206
i3	0.2592	0.2619	-0.0027	0.4041	0.35279	0.05131	0.3559	0.3762	-0.0203
i4	0.2343	0.20681	0.02749	0.2836	0.26558	0.01802	0.4862	0.42071	0.06549
i5	0.3301	0.32354	0.00656	0.3794	0.33392	0.04548	0.582	0.5942	-0.0122
i6	0.2745	0.2885	-0.014	0.4194	0.44578	-0.0264	0.247	0.21204	0.03496
i7	0.1348	0.1779	-0.0431	0.2797	0.22776	0.05194	0.3867	0.37366	0.01304
i8	0.2445	0.23781	0.00669	0.1699	0.22109	-0.0512	0.4964	0.48912	0.00728
i9	0.3476	0.28712	0.06048	0.273	0.25635	0.01665	0.5995	0.53512	0.06438
i10	0.3933	0.32988	0.06342	0.5382	0.51492	0.02328	0.1281	0.15182	-0.0237
i11		0.00575	-0.0058		0.00616	-0.0062		0.00488	-0.0049
i12	0.4209	0.41683	0.00407	0.3463	0.33455	0.01175	0.4713	0.46031	0.01099
i13	0.5603	0.55759	0.00271	0.4857	0.4482	0.0375	0.6321	0.65678	-0.0247
i14	0.4815	0.48017	0.00133	0.6331	0.55467	0.07843	0.2526	0.23058	0.02202
i15	0.5307	0.51349	0.01721	0.456	0.44938	0.00662	0.3615	0.36917	-0.0077
i16	0.6266	0.63397	-0.0074	0.552	0.59507	-0.0431	0.5418	0.4954	0.0464
Neuron Results	Average Diff (Full)		0.02135	Average Diff (Full)		0.0309	Average Diff (Full)		0.02574
	Average Diff (Mod)		0.02239	Average Diff (Mod)		0.03255	Average Diff (Mod)		0.02713
	Std Dev Diff (Full)		0.02225	Std Dev Diff (Full)		0.02113	Std Dev Diff (Full)		0.01888
	Std Dev Diff (Mod)		0.02263	Std Dev Diff (Mod)		0.02077	Std Dev Diff (Mod)		0.01868

Destination	Neuron o4 (Route 12)			Neuron o5 (Route 14)			Neuron o6 (Route 15)		
	Target	Meas	Diff	Target	Meas	Diff	Target	Meas	Diff
i1	0.5759	0.6009	-0.025	0.6182	0.60927	0.00893	0.7023	0.65786	0.04444
i2	0.6541	0.60543	0.04867	0.5092	0.50835	0.00085	0.6088	0.60102	0.00778
i3	0.5545	0.49067	0.06383	0.4859	0.50406	-0.0182	0.5854	0.54422	0.04118
i4	0.4339	0.44942	-0.0155	0.6162	0.55794	0.05826	0.5603	0.56507	-0.0048
i5	0.4732	0.44287	0.03033	0.712	0.65924	0.05276	0.5997	0.59318	0.00652
i6	0.5696	0.52688	0.04272	0.3769	0.33635	0.04055	0.4765	0.46477	0.01173
i7	0.43	0.39585	0.03415	0.5166	0.50436	0.01224	0.5564	0.50959	0.04681
i8	0.3203	0.27749	0.04281	0.565	0.52212	0.04288	0.4467	0.42122	0.02548
i9	0.2853	0.28472	0.00058	0.53	0.54544	-0.0154	0.4117	0.4278	-0.0161
i10	0.4871	0.52382	-0.0367	0.2944	0.24628	0.04812	0.3939	0.39408	-0.0002
i11		0.00552	-0.0055		0.00484	-0.0048		0.00506	-0.0051
i12	0.1439	0.18497	-0.0411	0.3886	0.36318	0.02542	0.2703	0.23674	0.03356
i13	0.3047	0.2705	0.0342	0.5494	0.55274	-0.0033	0.4311	0.3701	0.061
i14	0.3626	0.36536	-0.0028	0.1699	0.23615	-0.0663	0.2695	0.27221	-0.0027
i15	0.2536	0.19488	0.05872	0.2789	0.26624	0.01266	0.1605	0.18856	-0.0281
i16	0.3496	0.32807	0.02153	0.4591	0.40409	0.05501	0.3408	0.3183	0.0225
Neuron Results	Average Diff (Full)		0.03151	Average Diff (Full)		0.02911	Average Diff (Full)		0.02237
	Average Diff (Mod)		0.03324	Average Diff (Mod)		0.03072	Average Diff (Mod)		0.02352
	Std Dev Diff (Full)		0.01884	Std Dev Diff (Full)		0.02232	Std Dev Diff (Full)		0.01862
	Std Dev Diff (Mod)		0.01813	Std Dev Diff (Mod)		0.02212	Std Dev Diff (Mod)		0.01868

Network Results	Average Diff (Full)		0.02683	Std Dev Diff (Full)		0.02026
	Average Diff (Mod)		0.02826	Std Dev Diff (Mod)		0.02012

Training Results for V3.2.08.6
(Network 2.08.6, V3 Macro)

Destination	Neuron o1 (Route 7)			Neuron o2 (Route 8)			Neuron o3 (Route 10)					
	Target	Meas	Diff	Target	Meas	Diff	Target	Meas	Diff			
i1	0.3763	0.33826	0.03804	0.4256	0.44574	-0.0201	0.4882	0.48056	0.00764			
i2	0.3588	0.34062	0.01818	0.5037	0.51702	-0.0133	0.3793	0.33204	0.04726			
i3	0.2592	0.27116	-0.012	0.4041	0.39294	0.01116	0.3559	0.33939	0.01651			
i4	0.2343	0.22674	0.00756	0.2836	0.26405	0.01955	0.4862	0.48497	0.00123			
i5	0.3301	0.35087	-0.0208	0.3794	0.36476	0.01464	0.582	0.59931	-0.0173			
i6	0.2745	0.26325	0.01125	0.4194	0.40648	0.01292	0.247	0.25037	-0.0034			
i7	0.1348	0.16411	-0.0293	0.2797	0.21672	0.06298	0.3867	0.38461	0.00209			
i8	0.2445	0.20613	0.03837	0.1699	0.19544	-0.0255	0.4964	0.50233	-0.0059			
i9	0.3476	0.34014	0.00746	0.273	0.28671	-0.0137	0.5995	0.56238	0.03712			
i10	0.3933	0.36568	0.02762	0.5382	0.5221	0.0161	0.1281	0.21275	-0.0847			
i11		0.11599	-0.116		0.1386	-0.1386		0.0971	-0.0971			
i12	0.4209	0.42675	-0.0059	0.3463	0.32745	0.01885	0.4713	0.47169	-0.0004			
i13	0.5603	0.55488	0.00542	0.4857	0.47261	0.01309	0.6321	0.6219	0.0102			
i14	0.4815	0.50035	-0.0189	0.6331	0.63312	-2E-05	0.2526	0.17913	0.07347			
i15	0.5307	0.52981	0.00089	0.456	0.45389	0.00211	0.3615	0.36575	-0.0043			
i16	0.6266	0.61528	0.01132	0.552	0.54988	0.00212	0.5418	0.54503	-0.0032			
Neuron Results	Average	Diff	(Full)	0.02305	Average	Diff	(Full)	0.02405	Average	Diff	(Full)	0.02573
	Average	Diff	(Mod)	0.01686	Average	Diff	(Mod)	0.01642	Average	Diff	(Mod)	0.02098
	Std Dev	Diff	(Full)	0.02731	Std Dev	Diff	(Full)	0.03369	Std Dev	Diff	(Full)	0.03248
	Std Dev	Diff	(Mod)	0.01187	Std Dev	Diff	(Mod)	0.01471	Std Dev	Diff	(Mod)	0.02724

Destination	Neuron o4 (Route 12)			Neuron o5 (Route 14)			Neuron o6 (Route 15)					
	Target	Meas	Diff	Target	Meas	Diff	Target	Meas	Diff			
i1	0.5759	0.6062	-0.0303	0.6182	0.62102	-0.0028	0.7023	0.66179	0.04051			
i2	0.6541	0.65765	-0.0035	0.5092	0.49548	0.01372	0.6088	0.62986	-0.0211			
i3	0.5545	0.55498	-0.0005	0.4859	0.48892	-0.003	0.5854	0.57528	0.01012			
i4	0.4339	0.4299	0.004	0.6162	0.59975	0.01645	0.5603	0.56584	-0.0055			
i5	0.4732	0.46778	0.00542	0.712	0.66879	0.04321	0.5997	0.60398	-0.0043			
i6	0.5696	0.5337	0.0359	0.3769	0.38075	-0.0038	0.4765	0.50441	-0.0279			
i7	0.43	0.41821	0.01179	0.5166	0.53277	-0.0162	0.5564	0.53868	0.01772			
i8	0.3203	0.28696	0.03334	0.565	0.55946	0.00554	0.4467	0.44863	-0.0019			
i9	0.2853	0.27719	0.00811	0.53	0.5528	-0.0228	0.4117	0.40852	0.00318			
i10	0.4871	0.48462	0.00248	0.2944	0.27258	0.02182	0.3939	0.38768	0.00622			
i11		0.13178	-0.1318		0.11081	-0.1108		0.12497	-0.125			
i12	0.1439	0.18246	-0.0386	0.3886	0.37619	0.01241	0.2703	0.23701	0.03329			
i13	0.3047	0.32384	-0.0191	0.5494	0.55918	-0.0098	0.4311	0.4123	0.0188			
i14	0.3626	0.36953	-0.0069	0.1699	0.16066	0.00924	0.2695	0.22683	0.04267			
i15	0.2536	0.18528	0.06832	0.2789	0.25163	0.02727	0.1605	0.17521	-0.0147			
i16	0.3496	0.31869	0.03091	0.4591	0.45636	0.00274	0.3408	0.34546	-0.0047			
Neuron Results	Average	Diff	(Full)	0.02694	Average	Diff	(Full)	0.0201	Average	Diff	(Full)	0.0236
	Average	Diff	(Mod)	0.01995	Average	Diff	(Mod)	0.01406	Average	Diff	(Mod)	0.01684
	Std Dev	Diff	(Full)	0.03353	Std Dev	Diff	(Full)	0.02651	Std Dev	Diff	(Full)	0.03012
	Std Dev	Diff	(Mod)	0.01917	Std Dev	Diff	(Mod)	0.01124	Std Dev	Diff	(Mod)	0.01375

Network Results	Average	Diff	(Full)	0.02391	Std Dev	Diff	(Full)	0.03
	Average	Diff	(Mod)	0.01752	Std Dev	Diff	(Mod)	0.0169

Training Results for V3.2.10.6
(Network 2.10.6, V3 Macro)

Destination	Neuron o1 (Route 7)			Neuron o2 (Route 8)			Neuron o3 (Route 10)		
	Target	Meas	Diff	Target	Meas	Diff	Target	Meas	Diff
i1	0.3763	0.33644	0.03986	0.4256	0.45935	-0.0338	0.4882	0.44626	0.04194
i2	0.3588	0.33784	0.02096	0.5037	0.51053	-0.0068	0.3793	0.32306	0.05624
i3	0.2592	0.26823	-0.009	0.4041	0.38779	0.01631	0.3559	0.33558	0.02032
i4	0.2343	0.21393	0.02037	0.2836	0.25529	0.02831	0.4862	0.48901	-0.0028
i5	0.3301	0.35181	-0.0217	0.3794	0.35874	0.02066	0.582	0.61904	-0.037
i6	0.2745	0.26123	0.01327	0.4194	0.39195	0.02745	0.247	0.26177	-0.0148
i7	0.1348	0.14953	-0.0147	0.2797	0.19979	0.07991	0.3867	0.39688	-0.0102
i8	0.2445	0.18676	0.05774	0.1699	0.1943	-0.0244	0.4964	0.48668	0.00972
i9	0.3476	0.33046	0.01714	0.273	0.29341	-0.0204	0.5995	0.54776	0.05174
i10	0.3933	0.38857	0.00473	0.5382	0.52974	0.00846	0.1281	0.22244	-0.0943
i11		0.06958	-0.0696		0.07821	-0.0782		0.07298	-0.073
i12	0.4209	0.44825	-0.0274	0.3463	0.31854	0.02776	0.4713	0.47647	-0.0052
i13	0.5603	0.5499	0.0104	0.4857	0.4665	0.0192	0.6321	0.62728	0.00482
i14	0.4815	0.49048	-0.009	0.6331	0.63669	-0.0036	0.2526	0.16516	0.08744
i15	0.5307	0.51821	0.01249	0.456	0.45971	-0.0037	0.3615	0.35837	0.00313
i16	0.6266	0.62188	0.00472	0.552	0.55243	-0.0004	0.5418	0.54533	-0.0035
Neuron Results	Average Diff (Full)	0.02207		Average Diff (Full)	0.02496		Average Diff (Full)	0.03226	
	Average Diff (Mod)	0.0189		Average Diff (Mod)	0.02141		Average Diff (Mod)	0.02955	
	Std Dev Diff (Full)	0.01863		Std Dev Diff (Full)	0.0234		Std Dev Diff (Full)	0.03173	
	Std Dev Diff (Mod)	0.01413		Std Dev Diff (Mod)	0.01926		Std Dev Diff (Mod)	0.03086	

Destination	Neuron o4 (Route 12)			Neuron o5 (Route 14)			Neuron o6 (Route 15)		
	Target	Meas	Diff	Target	Meas	Diff	Target	Meas	Diff
i1	0.5759	0.63153	-0.0556	0.6182	0.59779	0.02041	0.7023	0.66406	0.03824
i2	0.6541	0.66547	-0.0114	0.5092	0.48783	0.02137	0.6088	0.63268	-0.0239
i3	0.5545	0.55919	-0.0047	0.4859	0.48394	0.00196	0.5854	0.57441	0.01099
i4	0.4339	0.4273	0.0066	0.6162	0.60361	0.01259	0.5603	0.5642	-0.0039
i5	0.4732	0.44591	0.02729	0.712	0.67755	0.03445	0.5997	0.58885	0.01085
i6	0.5696	0.52914	0.04046	0.3769	0.39143	-0.0145	0.4765	0.50729	-0.0308
i7	0.43	0.40739	0.02261	0.5166	0.53826	-0.0217	0.5564	0.53608	0.02032
i8	0.3203	0.2999	0.0204	0.565	0.55301	0.01199	0.4467	0.45658	-0.0099
i9	0.2853	0.28803	-0.0027	0.53	0.54779	-0.0178	0.4117	0.41325	-0.0016
i10	0.4871	0.46566	0.02144	0.2944	0.26836	0.02604	0.3939	0.37294	0.02096
i11		0.08085	-0.0809		0.08283	-0.0828		0.0842	-0.0842
i12	0.1439	0.15333	-0.0094	0.3886	0.36244	0.02616	0.2703	0.20533	0.06497
i13	0.3047	0.31194	-0.0072	0.5494	0.56657	-0.0172	0.4311	0.40554	0.02556
i14	0.3626	0.38109	-0.0185	0.1699	0.15014	0.01976	0.2695	0.23487	0.03463
i15	0.2536	0.20661	0.04699	0.2789	0.26353	0.01537	0.1605	0.19898	-0.0385
i16	0.3496	0.30646	0.04314	0.4591	0.45276	0.00634	0.3408	0.33594	0.00486
Neuron Results	Average Diff (Full)	0.02621		Average Diff (Full)	0.0219		Average Diff (Full)	0.0265	
	Average Diff (Mod)	0.02257		Average Diff (Mod)	0.01784		Average Diff (Mod)	0.02266	
	Std Dev Diff (Full)	0.02185		Std Dev Diff (Full)	0.01802		Std Dev Diff (Full)	0.02253	
	Std Dev Diff (Mod)	0.01686		Std Dev Diff (Mod)	0.00808		Std Dev Diff (Mod)	0.01704	

Network Results	Average Diff (Full)	0.02565	Std Dev Diff (Full)	0.02279
	Average Diff (Mod)	0.02215	Std Dev Diff (Mod)	0.01883

Pattern File for Node 2 of the Sample Network
Modified training set

Destination Node	Input Vector																Output Vector	
	i1	i2	i3	i4	i5	i6	i7	i8	i9	i10	i11	i12	i13	i14	i15	i16	o1	o2
i1	1	0	0	0	0	0	0	0	0	0	0	0	0	0	0	0	0.25	0.75
i2	0	1	0	0	0	0	0	0	0	0	0	0	0	0	0	0		
i3	0	0	1	0	0	0	0	0	0	0	0	0	0	0	0	0	0.25	0.75
i4	0	0	0	1	0	0	0	0	0	0	0	0	0	0	0	0	0.25	0.75
i5	0	0	0	0	1	0	0	0	0	0	0	0	0	0	0	0	0.25	0.75
i6	0	0	0	0	0	1	0	0	0	0	0	0	0	0	0	0	0.75	0.25
i7	0	0	0	0	0	0	1	0	0	0	0	0	0	0	0	0	0.25	0.75
i8	0	0	0	0	0	0	0	1	0	0	0	0	0	0	0	0	0.25	0.75
i9	0	0	0	0	0	0	0	0	1	0	0	0	0	0	0	0	0.25	0.75
i10	0	0	0	0	0	0	0	0	0	1	0	0	0	0	0	0	0.75	0.25
i11	0	0	0	0	0	0	0	0	0	0	1	0	0	0	0	0	0.25	0.75
i12	0	0	0	0	0	0	0	0	0	0	0	1	0	0	0	0	0.25	0.75
i13	0	0	0	0	0	0	0	0	0	0	0	0	1	0	0	0	0.25	0.75
i14	0	0	0	0	0	0	0	0	0	0	0	0	0	1	0	0	0.75	0.25
i15	0	0	0	0	0	0	0	0	0	0	0	0	0	0	1	0	0.75	0.25
i16	0	0	0	0	0	0	0	0	0	0	0	0	0	0	0	1	0.75	0.25

Pattern File for Node 9 of the Sample Network
Modified training set

Destination Node	Input Vector																Output Vector			
	i1	i2	i3	i4	i5	i6	i7	i8	i9	i10	i11	i12	i13	i14	i15	i16	o1	o2	o3	o4
i1	1	0	0	0	0	0	0	0	0	0	0	0	0	0	0	0	0.125	0.375	0.625	0.875
i2	0	1	0	0	0	0	0	0	0	0	0	0	0	0	0	0	0.375	0.125	0.625	0.875
i3	0	0	1	0	0	0	0	0	0	0	0	0	0	0	0	0	0.375	0.125	0.625	0.875
i4	0	0	0	1	0	0	0	0	0	0	0	0	0	0	0	0	0.375	0.125	0.625	0.875
i5	0	0	0	0	1	0	0	0	0	0	0	0	0	0	0	0	0.125	0.375	0.625	0.875
i6	0	0	0	0	0	1	0	0	0	0	0	0	0	0	0	0	0.625	0.125	0.375	0.875
i7	0	0	0	0	0	0	1	0	0	0	0	0	0	0	0	0	0.625	0.125	0.375	0.875
i8	0	0	0	0	0	0	0	1	0	0	0	0	0	0	0	0	0.625	0.125	0.375	0.875
i9	0	0	0	0	0	0	0	0	1	0	0	0	0	0	0	0				
i10	0	0	0	0	0	0	0	0	0	1	0	0	0	0	0	0	0.875	0.125	0.375	0.625
i11	0	0	0	0	0	0	0	0	0	0	1	0	0	0	0	0	0.875	0.125	0.375	0.625
i12	0	0	0	0	0	0	0	0	0	0	0	1	0	0	0	0	0.875	0.375	0.125	0.625
i13	0	0	0	0	0	0	0	0	0	0	0	0	1	0	0	0	0.875	0.625	0.375	0.125
i14	0	0	0	0	0	0	0	0	0	0	0	0	0	1	0	0	0.875	0.375	0.125	0.625
i15	0	0	0	0	0	0	0	0	0	0	0	0	0	0	1	0	0.875	0.375	0.125	0.625
i16	0	0	0	0	0	0	0	0	0	0	0	0	0	0	0	1	0.875	0.625	0.125	0.375

Pattern File for Node 11 of the Sample Network
Modified Training Set

Destination Node	Input Vector																Output Vector					
	i1	i2	i3	i4	i5	i6	i7	i8	i9	i10	i11	i12	i13	i14	i15	i16	o1	o2	o3	o4	o5	o6
1	1	0	0	0	0	0	0	0	0	0	0	0	0	0	0	0	0.08333	0.25	0.41667	0.58333	0.75	0.91667
2	0	1	0	0	0	0	0	0	0	0	0	0	0	0	0	0	0.08333	0.41667	0.25	0.91667	0.58333	0.75
3	0	0	1	0	0	0	0	0	0	0	0	0	0	0	0	0	0.08333	0.41667	0.25	0.75	0.58333	0.91667
4	0	0	0	1	0	0	0	0	0	0	0	0	0	0	0	0	0.08333	0.25	0.58333	0.41667	0.91667	0.75
5	0	0	0	0	1	0	0	0	0	0	0	0	0	0	0	0	0.08333	0.25	0.58333	0.41667	0.91667	0.75
6	0	0	0	0	0	1	0	0	0	0	0	0	0	0	0	0	0.25	0.58333	0.08333	0.91667	0.41667	0.75
7	0	0	0	0	0	0	1	0	0	0	0	0	0	0	0	0	0.08333	0.25	0.41667	0.58333	0.75	0.91667
8	0	0	0	0	0	0	0	1	0	0	0	0	0	0	0	0	0.25	0.08333	0.75	0.41667	0.91667	0.58333
9	0	0	0	0	0	0	0	0	1	0	0	0	0	0	0	0	0.41667	0.08333	0.91667	0.25	0.75	0.58333
10	0	0	0	0	0	0	0	0	0	1	0	0	0	0	0	0	0.41667	0.91667	0.08333	0.75	0.25	0.58333
11	0	0	0	0	0	0	0	0	0	0	1	0	0	0	0	0						
12	0	0	0	0	0	0	0	0	0	0	0	1	0	0	0	0	0.75	0.41667	0.91667	0.08333	0.58333	0.25
13	0	0	0	0	0	0	0	0	0	0	0	0	1	0	0	0	0.75	0.41667	0.91667	0.08333	0.58333	0.25
14	0	0	0	0	0	0	0	0	0	0	0	0	0	1	0	0	0.75	0.91667	0.25	0.58333	0.08333	0.41667
15	0	0	0	0	0	0	0	0	0	0	0	0	0	0	1	0	0.91667	0.75	0.58333	0.25	0.41667	0.08333
16	0	0	0	0	0	0	0	0	0	0	0	0	0	0	0	1	0.91667	0.75	0.58333	0.25	0.41667	0.08333

Training Results for V2.2.08.2(M)
(Network 2.08.2, V2 Macro, modified training set)

Destination	Neuron o1 (Route 3)			Neuron o2 (Route 6)		
	Target	Meas	Diff	Target	Meas	Diff
i1	0.25	0.25082	-0.0008	0.75	0.75101	-0.001
i2		0.43514	-0.4351		0.43082	-0.4308
i3	0.25	0.25266	-0.0027	0.75	0.75178	-0.0018
i4	0.25	0.25483	-0.0048	0.75	0.75288	-0.0029
i5	0.25	0.25081	-0.0008	0.75	0.75098	-0.001
i6	0.75	0.75031	-0.0003	0.25	0.24928	0.00072
i7	0.25	0.25088	-0.0009	0.75	0.75093	-0.0009
i8	0.25	0.24995	5E-05	0.75	0.7507	-0.0007
i9	0.25	0.25259	-0.0026	0.75	0.75166	-0.0017
i10	0.75	0.74899	0.00101	0.25	0.24573	0.00427
i11	0.25	0.24362	0.00638	0.75	0.74795	0.00205
i12	0.25	0.24463	0.00537	0.75	0.74849	0.00151
i13	0.25	0.25241	-0.0024	0.75	0.75174	-0.0017
i14	0.75	0.74892	0.00108	0.25	0.24514	0.00486
i15	0.75	0.75397	-0.004	0.25	0.25943	-0.0094
i16	0.75	0.75125	-0.0012	0.25	0.25197	-0.002
Neuron Results	Average	Diff (Full)	0.02935	Average	Diff (Full)	0.02921
	Average	Diff (Mod)	0.00229	Average	Diff (Mod)	0.00243
	Std Dev	Diff (Full)	0.10823	Std Dev	Diff (Full)	0.10712
	Std Dev	Diff (Mod)	0.00199	Std Dev	Diff (Mod)	0.00229
Network Results	Average	Diff (Full)	0.02928	Std Dev	Diff (Full)	0.10592
	Average	Diff (Mod)	0.00236	Std Dev	Diff (Mod)	0.00211

Training Results for V2.2.08.4(M)
(Network 2.08.4, V2 Macro, modified training set)

Destination	Neuron o1 (Route 5)			Neuron o2 (Route 8)		
	Target	Meas	Diff	Target	Meas	Diff
i1	0.125	0.1092	0.0158	0.375	0.35656	0.01844
i2	0.375	0.38464	-0.0096	0.125	0.16896	-0.044
i3	0.375	0.37422	0.00078	0.125	0.13245	-0.0075
i4	0.375	0.37872	-0.0037	0.125	0.14116	-0.0162
i5	0.125	0.12419	0.00081	0.375	0.38077	-0.0058
i6	0.625	0.63012	-0.0051	0.125	0.08691	0.03809
i7	0.625	0.6257	-0.0007	0.125	0.08052	0.04448
i8	0.625	0.64197	-0.017	0.125	0.07961	0.04539
i9		0.17998	-0.18		0.05106	-0.0511
i10	0.875	0.807	0.068	0.125	0.16234	-0.0373
i11	0.875	0.83401	0.04099	0.125	0.14268	-0.0177
i12	0.875	0.90865	-0.0337	0.375	0.37002	0.00498
i13	0.875	0.86102	0.01398	0.625	0.63012	-0.0051
i14	0.875	0.90949	-0.0345	0.375	0.36959	0.00541
i15	0.875	0.90949	-0.0345	0.375	0.37099	0.00401
i16	0.875	0.92616	-0.0512	0.625	0.61295	0.01205
Neuron Results	Average	Diff (Full)	0.03189	Average	Diff (Full)	0.02234
	Average	Diff (Mod)	0.02202	Average	Diff (Mod)	0.02042
	Std Dev	Diff (Full)	0.04429	Std Dev	Diff (Full)	0.01767
	Std Dev	Diff (Mod)	0.02075	Std Dev	Diff (Mod)	0.01649

Destination	Neuron o3 (Route 12)			Neuron o4 (Route 13)		
	Target	Meas	Diff	Target	Meas	Diff
i1	0.625	0.63668	-0.0117	0.875	0.87536	-0.0004
i2	0.625	0.6008	0.0242	0.875	0.8902	-0.0152
i3	0.625	0.61008	0.01492	0.875	0.90257	-0.0276
i4	0.625	0.60694	0.01806	0.875	0.90012	-0.0251
i5	0.625	0.62944	-0.0044	0.875	0.86247	0.01253
i6	0.375	0.42094	-0.0459	0.875	0.8203	0.0547
i7	0.375	0.42361	-0.0486	0.875	0.82086	0.05414
i8	0.375	0.41848	-0.0435	0.875	0.81252	0.06248
i9		0.06041	-0.0604		0.12549	-0.1255
i10	0.375	0.28083	0.09417	0.625	0.72225	-0.0972
i11	0.375	0.28011	0.09489	0.625	0.70899	-0.084
i12	0.125	0.15639	-0.0314	0.625	0.60561	0.01939
i13	0.375	0.38026	-0.0053	0.125	0.11959	0.00541
i14	0.125	0.15353	-0.0285	0.625	0.60572	0.01928
i15	0.125	0.16594	-0.0409	0.625	0.60074	0.02426
i16	0.125	0.11439	0.01061	0.375	0.36871	0.00629
Neuron Results	Average	Diff (Full)	0.0361	Average	Diff (Full)	0.03959
	Average	Diff (Mod)	0.03447	Average	Diff (Mod)	0.03386
	Std Dev	Diff (Full)	0.02822	Std Dev	Diff (Full)	0.03669
	Std Dev	Diff (Mod)	0.02843	Std Dev	Diff (Mod)	0.02967

Network Results	Average	Diff (Full)	0.03248	Std Dev	Diff (Full)	0.03307
	Average	Diff (Mod)	0.0277	Std Dev	Diff (Mod)	0.0247

Training Results for V2.2.08.6(M)
(Network 2.08.6, V2 Macro, modified training set)

Destination	Neuron o1 (Route 7)			Neuron o2 (Route 8)			Neuron o3 (Route 10)		
	Target	Meas	Diff	Target	Meas	Diff	Target	Meas	Diff
i1	0.08333	0.06172	0.02161	0.25	0.2585	-0.0085	0.41667	0.41389	0.00278
i2	0.08333	0.13664	-0.0533	0.41667	0.43062	-0.014	0.25	0.23642	0.01358
i3	0.08333	0.10874	-0.0254	0.41667	0.398	0.01867	0.25	0.24862	0.00138
i4	0.08333	0.09668	-0.0133	0.25	0.20363	0.04637	0.58333	0.59691	-0.0136
i5	0.08333	0.09233	-0.009	0.25	0.213	0.037	0.58333	0.59671	-0.0134
i6	0.25	0.17169	0.07831	0.58333	0.61812	-0.0348	0.08333	0.10494	-0.0216
i7	0.08333	0.05721	0.02612	0.25	0.27988	-0.0299	0.41667	0.39973	0.01694
i8	0.25	0.23902	0.01098	0.08333	0.13341	-0.0501	0.75	0.82527	-0.0753
i9	0.41667	0.40024	0.01643	0.08333	0.14153	-0.0582	0.91667	0.88947	0.0272
i10	0.41667	0.45291	-0.0362	0.91667	0.84433	0.07234	0.08333	0.10821	-0.0249
i11		0.02135	-0.0214		0.03729	-0.0373		0.02667	-0.0267
i12	0.75	0.78417	-0.0342	0.41667	0.3919	0.02477	0.91667	0.85977	0.0569
i13	0.75	0.78289	-0.0329	0.41667	0.39392	0.02275	0.91667	0.85939	0.05728
i14	0.75	0.74397	0.00603	0.91667	0.8983	0.01837	0.25	0.20792	0.04208
i15	0.91667	0.88108	0.03559	0.75	0.78922	-0.0392	0.58333	0.61683	-0.0335
i16	0.91667	0.88152	0.03515	0.75	0.79066	-0.0407	0.58333	0.61603	-0.0327
Neuron Results	Average Diff (Full)		0.0285	Average Diff (Full)		0.03455	Average Diff (Full)		0.02873
	Average Diff (Mod)		0.02897	Average Diff (Mod)		0.03437	Average Diff (Mod)		0.02887
	Std Dev Diff (Full)		0.01823	Std Dev Diff (Full)		0.01696	Std Dev Diff (Full)		0.02052
	Std Dev Diff (Mod)		0.01876	Std Dev Diff (Mod)		0.01754	Std Dev Diff (Mod)		0.02124

Destination	Neuron o4 (Route 12)			Neuron o5 (Route 14)			Neuron o6 (Route 15)		
	Target	Meas	Diff	Target	Meas	Diff	Target	Meas	Diff
i1	0.58333	0.58206	0.00127	0.75	0.81844	-0.0684	0.91667	0.85316	0.06351
i2	0.91667	0.84222	0.07445	0.58333	0.58151	0.00182	0.75	0.81554	-0.0655
i3	0.75	0.80137	-0.0514	0.58333	0.627	-0.0437	0.91667	0.82676	0.08991
i4	0.41667	0.45756	-0.0409	0.91667	0.83459	0.08208	0.75	0.80056	-0.0506
i5	0.41667	0.43474	-0.0181	0.91667	0.85022	0.06645	0.75	0.80398	-0.054
i6	0.91667	0.90707	0.0096	0.41667	0.36331	0.05336	0.75	0.7905	-0.0405
i7	0.58333	0.56772	0.01561	0.75	0.82371	-0.0737	0.91667	0.86394	0.05273
i8	0.41667	0.34146	0.07521	0.91667	0.82579	0.09088	0.58333	0.65121	-0.0679
i9	0.25	0.27979	-0.0298	0.75	0.81702	-0.067	0.58333	0.54126	0.04207
i10	0.75	0.79098	-0.041	0.25	0.2244	0.0256	0.58333	0.58303	0.0003
i11		0.04389	-0.0439		0.04197	-0.042		0.0521	-0.0521
i12	0.08333	0.14505	-0.0617	0.58333	0.62217	-0.0388	0.25	0.20663	0.04337
i13	0.08333	0.14216	-0.0588	0.58333	0.62432	-0.041	0.25	0.2061	0.0439
i14	0.58333	0.59922	-0.0159	0.08333	0.2221	-0.1388	0.41667	0.3741	0.04257
i15	0.25	0.20697	0.04303	0.41667	0.36066	0.05601	0.08333	0.15845	-0.0751
i16	0.25	0.20322	0.04678	0.41667	0.35996	0.05671	0.08333	0.15646	-0.0731
Neuron Results	Average Diff (Full)		0.03921	Average Diff (Full)		0.05914	Average Diff (Full)		0.05357
	Average Diff (Mod)		0.0389	Average Diff (Mod)		0.06029	Average Diff (Mod)		0.05367
	Std Dev Diff (Full)		0.02255	Std Dev Diff (Full)		0.03058	Std Dev Diff (Full)		0.02014
	Std Dev Diff (Mod)		0.02331	Std Dev Diff (Mod)		0.03129	Std Dev Diff (Mod)		0.02084

Network Results	Average Diff (Full)		0.04062	Std Dev Diff (Full)		0.02444
	Average Diff (Mod)		0.04084	Std Dev Diff (Mod)		0.02509

Appendix C:
Full network modelling results

Routing Results for Node 1
of the Sample Network

Destination Node	Real Output Values				Target Rankings				Target Values			
	o1	o2	o3	o4	o1	o2	o3	o4	o1	o2	o3	o4
i1												
i2	0.25685	0.49057	0.60218	1	1	2	3	4	0.125	0.375	0.625	0.875
i3	0.1573	0.39102	0.50263	1	1	2	3	4	0.125	0.375	0.625	0.875
i4	0.38132	0.167	0.27861	1	3	1	2	4	0.625	0.125	0.375	0.875
i5	0.47713	0.26281	0.1828	1	3	2	1	4	0.625	0.375	0.125	0.875
i6	0.26626	0.40625	0.51786	1	1	2	3	4	0.125	0.375	0.625	0.875
i7	0.28177	0.26655	0.37816	1	2	1	3	4	0.375	0.125	0.625	0.875
i8	0.39153	0.28067	0.39228	0.9822	2	1	3	4	0.375	0.125	0.625	0.875
i9	0.49463	0.38377	0.3708	0.9472	3	2	1	4	0.625	0.375	0.125	0.875
i10	0.38513	0.47941	0.59102	1	1	2	3	4	0.125	0.375	0.625	0.875
i11	0.39153	0.37631	0.48792	0.9159	2	1	3	4	0.375	0.125	0.625	0.875
i12	0.5104	0.45707	0.5122	0.8058	2	1	3	4	0.375	0.125	0.625	0.875
i13	0.6772	0.59647	0.5835	0.7553	3	2	1	4	0.625	0.375	0.125	0.875
i14	0.47326	0.52121	0.63282	0.88936	1	2	3	4	0.125	0.375	0.625	0.875
i15	0.52703	0.51181	0.62196	0.7804	2	1	3	4	0.375	0.125	0.625	0.875
i16	0.70733	0.66277	0.7387	0.6001	3	2	4	1	0.625	0.375	0.875	0.125

Destination Node	Measured Values				Measured Rankings				Actual-Measured			
	o1	o2	o3	o4	o1	o2	o3	o4	o1	o2	o3	o4
i1	0.17793	0.31699	0.57219	0.86369	1	2	3	4				
i2	0.1344	0.37814	0.63432	0.86453	1	2	3	4	0	0	0	0
i3	0.13555	0.37913	0.63372	0.86157	1	2	3	4	0	0	0	0
i4	0.62063	0.12367	0.37261	0.89066	3	1	2	4	0	0	0	0
i5	0.62436	0.37733	0.13152	0.87352	3	2	1	4	0	0	0	0
i6	0.13476	0.37809	0.63347	0.86652	1	2	3	4	0	0	0	0
i7	0.36603	0.14865	0.63695	0.89723	2	1	3	4	0	0	0	0
i8	0.36619	0.15043	0.63881	0.89711	2	1	3	4	0	0	0	0
i9	0.62091	0.3787	0.13694	0.88292	3	2	1	4	0	0	0	0
i10	0.13663	0.37807	0.63509	0.86539	1	2	3	4	0	0	0	0
i11	0.37124	0.13319	0.63016	0.88376	2	1	3	4	0	0	0	0
i12	0.36466	0.15702	0.63593	0.9059	2	1	3	4	0	0	0	0
i13	0.62576	0.37553	0.13034	0.87261	3	2	1	4	0	0	0	0
i14	0.15456	0.25345	0.51267	0.7918	1	2	3	4	0	0	0	0
i15	0.37366	0.14555	0.62995	0.88582	2	1	3	4	0	0	0	0
i16	0.6212	0.37782	0.879	0.1324	3	2	4	1	0	0	0	0

Routing Results for Node 2
of the Sample Network

Destination Node	Real Output Values		Target Rankings		Target Values	
	o1	o2	o1	o2	o1	o2
i1	0.2569	0.3986	1	2	0.25	0.75
i2						
i3	0.1245	0.2663	1	2	0.25	0.75
i4	0.3486	0.3966	1	2	0.25	0.75
i5	0.4146	0.4924	1	2	0.25	0.75
i6	0.2335	0.1573	2	1	0.75	0.25
i7	0.249	0.297	1	2	0.25	0.75
i8	0.3588	0.4068	1	2	0.25	0.75
i9	0.4618	0.5097	1	2	0.25	0.75
i10	0.3524	0.2762	2	1	0.75	0.25
i11	0.3588	0.3793	1	2	0.25	0.75
i12	0.4776	0.4981	1	2	0.25	0.75
i13	0.6385	0.659	1	2	0.25	0.75
i14	0.4405	0.3643	2	1	0.75	0.25
i15	0.4942	0.4733	2	1	0.75	0.25
i16	0.6745	0.6536	2	1	0.75	0.25

Destination Node	Measured Values		Meas Rankings		Actual-Measured	
	o1	o2	o1	o2	o1	o2
i1	0.25082	0.75101	1	2	0	0
i2	0.43514	0.43082				
i3	0.25266	0.75178	1	2	0	0
i4	0.25483	0.75288	1	2	0	0
i5	0.25081	0.75098	1	2	0	0
i6	0.75031	0.24928	2	1	0	0
i7	0.25088	0.75093	1	2	0	0
i8	0.24995	0.7507	1	2	0	0
i9	0.25259	0.75166	1	2	0	0
i10	0.74899	0.24573	2	1	0	0
i11	0.24362	0.74795	1	2	0	0
i12	0.24463	0.74849	1	2	0	0
i13	0.25241	0.75174	1	2	0	0
i14	0.74892	0.24514	2	1	0	0
i15	0.75397	0.25943	2	1	0	0
i16	0.75125	0.25197	2	1	0	0

Routing Results for Node 3
of the Sample Network

Destination Node	Real Output Values				Target Rankings				Target Values			
	o1	o2	o3	o4	o1	o2	o3	o4	o1	o2	o3	o4
i1	0.1573	0.6381	0.5152	0.39102	1	4	3	2	0.125	0.875	0.625	0.375
i2	0.67085	0.12455	0.26626	0.42146	4	1	2	3	0.875	0.125	0.375	0.625
i3												
i4	0.2993	0.4961	0.37321	0.24902	2	4	3	1	0.375	0.875	0.625	0.125
i5	0.3151	0.59191	0.46902	0.34483	1	4	3	2	0.125	0.875	0.625	0.375
i6	0.53855	0.25685	0.13396	0.28917	4	2	1	3	0.875	0.375	0.125	0.625
i7	0.39885	0.39655	0.27366	0.14947	4	3	2	1	0.875	0.625	0.375	0.125
i8	0.41297	0.50631	0.38342	0.25923	3	4	2	1	0.625	0.875	0.375	0.125
i9	0.5031	0.60941	0.48652	0.36233	3	4	2	1	0.625	0.875	0.375	0.125
i10	0.61171	0.37572	0.25283	0.36233	4	3	1	2	0.875	0.625	0.125	0.375
i11	0.50861	0.47882	0.35593	0.25923	4	3	2	1	0.875	0.625	0.375	0.125
i12	0.58937	0.59769	0.4748	0.3781	3	4	2	1	0.625	0.875	0.375	0.125
i13	0.7158	0.75849	0.6356	0.5389	3	4	2	1	0.625	0.875	0.375	0.125
i14	0.65351	0.46385	0.34096	0.40413	4	3	1	2	0.875	0.625	0.125	0.375
i15	0.64411	0.57281	0.44992	0.39473	4	3	2	1	0.875	0.625	0.375	0.125
i16	0.7324	0.75311	0.63022	0.57503	3	4	2	1	0.625	0.875	0.375	0.125

Destination Node	Measured Values				Measured Rankings				Actual-Measured			
	o1	o2	o3	o4	o1	o2	o3	o4	o1	o2	o3	o4
i1	0.12151	0.8926	0.61879	0.37285	1	4	3	2	0	0	0	0
i2	0.86982	0.12291	0.37361	0.62831	4	1	2	3	0	0	0	0
i3	0.01196	0.00902	0.00738	0.00665								
i4	0.38071	0.90741	0.58221	0.1769	2	4	3	1	0	0	0	0
i5	0.12104	0.89017	0.61558	0.37972	1	4	3	2	0	0	0	0
i6	0.88732	0.36894	0.14916	0.61436	4	2	1	3	0	0	0	0
i7	0.85143	0.6956	0.27	0.15719	4	3	2	1	0	0	0	0
i8	0.62595	0.84305	0.4083	0.09028	3	4	2	1	0	0	0	0
i9	0.62685	0.83708	0.40614	0.09996	3	4	2	1	0	0	0	0
i10	0.89895	0.58566	0.18704	0.37965	4	3	1	2	0	0	0	0
i11	0.8604	0.67518	0.31801	0.13231	4	3	2	1	0	0	0	0
i12	0.62621	0.83959	0.40877	0.079	3	4	2	1	0	0	0	0
i13	0.62563	0.84102	0.40882	0.08469	3	4	2	1	0	0	0	0
i14	0.89937	0.59368	0.18942	0.36824	4	3	1	2	0	0	0	0
i15	0.85911	0.67721	0.30818	0.14161	4	3	2	1	0	0	0	0
i16	0.62597	0.8392	0.40903	0.88541	3	4	2	1	0	0	0	0

Routing Results for Node 4
of the Sample Network

Destination Node	Real Output Values				Target Rankings				Target Values			
	o1	o2	o3	o4	o1	o2	o3	o4	o1	o2	o3	o4
i1	0.167	0.27861	0.38132	0.5052	1	2	3	4	0.125	0.375	0.625	0.875
i2	0.39885	0.51046	0.34857	0.47245	2	4	1	3	0.375	0.875	0.125	0.625
i3	0.2993	0.41091	0.24902	0.3729	2	4	1	3	0.375	0.875	0.125	0.625
i4												
i5	0.3248	0.12081	0.52541	0.42976	2	1	4	3	0.375	0.125	0.875	0.625
i6	0.40826	0.51987	0.26425	0.27343	3	4	1	2	0.625	0.875	0.125	0.375
i7	0.42376	0.52167	0.12455	0.24843	3	4	1	2	0.625	0.875	0.125	0.375
i8	0.53353	0.41191	0.23431	0.13867	4	3	2	1	0.875	0.625	0.375	0.125
i9	0.5128	0.30881	0.33741	0.24177	4	2	3	1	0.875	0.375	0.625	0.125
i10	0.52713	0.63874	0.33741	0.38667	3	4	1	2	0.625	0.875	0.125	0.375
i11	0.53353	0.55681	0.23431	0.28357	3	4	1	2	0.625	0.875	0.125	0.375
i12	0.6524	0.45021	0.35318	0.31507	4	3	2	1	0.875	0.625	0.375	0.125
i13	0.7255	0.52151	0.51398	0.45447	4	3	2	1	0.875	0.625	0.375	0.125
i14	0.61526	0.66893	0.37921	0.42847	3	4	1	2	0.625	0.875	0.125	0.375
i15	0.66903	0.55997	0.36981	0.41907	4	3	1	2	0.875	0.625	0.125	0.375
i16	0.7421	0.65591	0.55011	0.52077	4	3	2	1	0.875	0.625	0.375	0.125

Destination Node	Measured Values				Measured Rankings				Actual-Measured			
	o1	o2	o3	o4	o1	o2	o3	o4	o1	o2	o3	o4
i1	0.1296	0.37348	0.62376	0.87892	1	2	3	4	0	0	0	0
i2	0.37499	0.87557	0.12534	0.62435	2	4	1	3	0	0	0	0
i3	0.37098	0.88066	0.12652	0.62057	2	4	1	3	0	0	0	0
i4	0.61832	0.61648	0.18042	0.25071								
i5	0.37651	0.12011	0.87276	0.62583	2	1	4	3	0	0	0	0
i6	0.63058	0.86524	0.10644	0.37959	3	4	1	2	0	0	0	0
i7	0.63078	0.8614	0.11237	0.38432	3	4	1	2	0	0	0	0
i8	0.89811	0.61441	0.36663	0.13938	4	3	2	1	0	0	0	0
i9	0.87234	0.37825	0.62581	0.12915	4	2	3	1	0	0	0	0
i10	0.63088	0.86044	0.10794	0.38441	3	4	1	2	0	0	0	0
i11	0.63155	0.85251	0.11274	0.39328	3	4	1	2	0	0	0	0
i12	0.89727	0.61666	0.36527	0.13527	4	3	2	1	0	0	0	0
i13	0.89649	0.61345	0.36834	0.1444	4	3	2	1	0	0	0	0
i14	0.63164	0.86144	0.10392	0.38264	3	4	1	2	0	0	0	0
i15	0.78481	0.72033	0.21779	0.27609	4	3	1	2	0	0	0	0
i16	0.89748	0.61198	0.36881	0.14681	4	3	2	1	0	0	0	0

Routing Results for Node 5
of the Sample Network

Destination Node	Real Output Values			Target Rankings			Target Values		
	o1	o2	o3	o1	o2	o3	o1	o2	o3
i1	0.1828	0.26281	0.57177	1	2	3	0.16667	0.5	0.83333
i2	0.41465	0.44438	0.64988	1	2	3	0.16667	0.5	0.83333
i3	0.3151	0.34483	0.55032	1	2	3	0.16667	0.5	0.83333
i4	0.3248	0.12081	0.42977	2	1	3	0.5	0.16667	0.83333
i5									
i6	0.42406	0.36006	0.56556	2	1	3	0.5	0.16667	0.83333
i7	0.42435	0.22036	0.34776	3	1	2	0.83333	0.16667	0.5
i8	0.43847	0.23448	0.3161	3	1	2	0.83333	0.16667	0.5
i9	0.54157	0.33758	0.213	3	2	1	0.83333	0.5	0.16667
i10	0.54293	0.43322	0.5641	2	1	3	0.5	0.16667	0.83333
i11	0.53411	0.33012	0.461	3	1	2	0.83333	0.16667	0.5
i12	0.61486	0.41088	0.3544	3	2	1	0.83333	0.5	0.16667
i13	0.75427	0.55028	0.4257	3	2	1	0.83333	0.5	0.16667
i14	0.63106	0.47502	0.57312	3	1	2	0.83333	0.16667	0.5
i15	0.66961	0.46562	0.46416	3	2	1	0.83333	0.5	0.16667
i16	0.7579	0.61658	0.5601	3	2	1	0.83333	0.5	0.16667

Destination Node	Measured Values			Measured Rankings			Actual - Measured		
	o1	o2	o3	o1	o2	o3	o1	o2	o3
i1	0.16655	0.502	1	1	2	3	0	0	0
i2	0.16606	0.5022	1	1	2	3	0	0	0
i3	0.16805	0.50247	1	1	2	3	0	0	0
i4	0.50868	0.13002	0.83719	2	1	3	0	0	0
i5	0.72533	0.17241	0.3431						
i6	0.50562	0.13304	0.83642	2	1	3	0	0	0
i7	0.8234	0.18662	0.50348	3	1	2	0	0	0
i8	0.8215	0.19259	0.50068	3	1	2	0	0	0
i9	0.83189	0.50225	0.16396	3	2	1	0	0	0
i10	0.50542	0.13934	0.83827	2	1	3	0	0	0
i11	0.83184	0.17632	0.50106	3	1	2	0	0	0
i12	0.84429	0.4976	0.16474	3	2	1	0	0	0
i13	0.84295	0.49853	0.16853	3	2	1	0	0	0
i14	0.82804	0.18079	0.50192	3	1	2	0	0	0
i15	0.83371	0.5024	0.1698	3	2	1	0	0	0
i16	0.83195	0.50208	0.16326	3	2	1	0	0	0

Routing Results for Node 6
of the Sample Network

Destination Node	Real Output Values				
	o1	o2	o3	o4	o5
i1	0.38915	0.26626	0.40625	0.59828	0.72821
i2	0.1573	0.23351	0.38872	0.58075	0.71068
i3	0.25685	0.13396	0.28917	0.4812	0.61113
i4	0.48087	0.35798	0.26425	0.45628	0.58621
i5	0.54695	0.42406	0.36006	0.55209	0.68202
i6					
i7	0.38132	0.25843	0.1647	0.35673	0.48666
i8	0.49108	0.36819	0.27446	0.39187	0.5218
i9	0.59418	0.47129	0.37756	0.49497	0.59212
i10	0.59418	0.47129	0.37756	0.14387	0.35647
i11	0.49108	0.36819	0.27446	0.24697	0.3769
i12	0.60995	0.48706	0.39333	0.36584	0.45072
i13	0.77075	0.64786	0.55413	0.52664	0.61152
i14	0.63598	0.51309	0.41936	0.26834	0.232
i15	0.62658	0.50369	0.40996	0.3773	0.34096
i16	0.80688	0.68399	0.59026	0.5576	0.52126

	Target Rankings				
	o1	o2	o3	o4	o5
2	1	3	4	5	
1	2	3	4	5	
2	1	3	4	5	
4	2	1	3	5	
3	2	1	4	5	
4	2	1	3	5	
4	2	1	3	5	
5	2	1	3	4	
5	4	3	1	2	
5	3	2	1	4	
5	4	2	1	3	
5	4	2	1	3	
5	4	3	2	1	
5	4	3	2	1	
5	4	3	2	1	

	Target Values				
	o1	o2	o3	o4	o5
0.3	0.1	0.5	0.7	0.9	
0.1	0.3	0.5	0.7	0.9	
0.3	0.1	0.5	0.7	0.9	
0.7	0.3	0.1	0.5	0.9	
0.5	0.3	0.1	0.7	0.9	
0.7	0.3	0.1	0.5	0.9	
0.7	0.3	0.1	0.5	0.9	
0.9	0.3	0.1	0.5	0.7	
0.9	0.7	0.5	0.1	0.3	
0.9	0.5	0.3	0.1	0.7	
0.9	0.7	0.3	0.1	0.5	
0.9	0.7	0.5	0.3	0.1	
0.9	0.7	0.5	0.3	0.1	
0.9	0.7	0.5	0.3	0.1	

Destination Node	Measured Values				
	o1	o2	o3	o4	o5
i1	0.25232	0.19123	0.47996	0.70413	0.90557
i2	0.18201	0.16575	0.52827	0.6938	0.88846
i3	0.25292	0.18943	0.4806	0.6989	0.9185
i4	0.7113	0.28848	0.10273	0.50243	0.89146
i5	0.53027	0.2118	0.13418	0.69561	0.90745
i6	0.18339	0.08281	0.0428	0.05672	0.11014
i7	0.70417	0.29037	0.11097	0.49872	0.90084
i8	0.7061	0.29221	0.11157	0.50426	0.88712
i9	0.85164	0.34563	0.04953	0.49798	0.70498
i10	0.91785	0.71056	0.48507	0.1055	0.29382
i11	0.8596	0.54984	0.26405	0.13165	0.69051
i12	0.91634	0.67102	0.32213	0.0641	0.50751
i13	0.92207	0.67397	0.31777	0.07659	0.50421
i14	0.9005	0.69775	0.50105	0.30207	0.09311
i15	0.90131	0.69584	0.50291	0.30099	0.102
i16	0.90402	0.69717	0.50045	0.29798	0.10287

	Measured Rankings				
	o1	o2	o3	o4	o5
2	1	3	4	5	
2	1	3	4	5	
2	1	3	4	5	
4	2	1	3	5	
3	2	1	4	5	
4	2	1	3	5	
4	2	1	3	5	
5	2	1	3	4	
5	4	3	1	2	
5	3	2	1	4	
5	4	2	1	3	
5	4	2	1	3	
5	4	3	2	1	
5	4	3	2	1	
5	4	3	2	1	

	Actual-Measured				
	o1	o2	o3	o4	o5
0	0	0	0	0	0
1	1	0	0	0	0
0	0	0	0	0	0
0	0	0	0	0	0
0	0	0	0	0	0
0	0	0	0	0	0
0	0	0	0	0	0
0	0	0	0	0	0
0	0	0	0	0	0
0	0	0	0	0	0
0	0	0	0	0	0
0	0	0	0	0	0
0	0	0	0	0	0
0	0	0	0	0	0

Routing Results for Node 7
of the Sample Network

Destination Node	Real Output Values					Target Rankings					Target Values				
	o1	o2	o3	o4	o5	o1	o2	o3	o4	o5	o1	o2	o3	o4	o5
i1	0.28177	0.26655	0.40596	0.39043	0.53533	2	1	4	3	5	0.3	0.1	0.7	0.5	0.9
i2	0.24902	0.4984	0.297	0.62228	0.48903	1	4	2	5	3	0.1	0.7	0.3	0.9	0.5
i3	0.14947	0.39885	0.27366	0.52273	0.46569	1	3	2	5	4	0.1	0.5	0.3	0.9	0.7
i4	0.42377	0.12455	0.54796	0.24843	0.39333	4	1	5	2	3	0.7	0.1	0.9	0.3	0.5
i5	0.43957	0.22036	0.56376	0.34424	0.48914	3	1	5	2	4	0.5	0.1	0.9	0.3	0.7
i6	0.25843	0.50781	0.1647	0.50163	0.35673	2	5	1	4	3	0.3	0.9	0.1	0.7	0.5
i7															
i8	0.53744	0.23822	0.53157	0.13476	0.27966	5	2	4	1	3	0.9	0.3	0.7	0.1	0.5
i9	0.62756	0.34132	0.63467	0.23786	0.38276	4	2	5	1	3	0.7	0.3	0.9	0.1	0.5
i10	0.3773	0.48622	0.28357	0.38276	0.23786	3	5	2	4	1	0.5	0.9	0.3	0.7	0.1
i11	0.4804	0.38312	0.38667	0.27966	0.13476	5	3	4	2	1	0.9	0.5	0.7	0.3	0.1
i12	0.59927	0.41462	0.50554	0.31116	0.25363	5	3	4	2	1	0.9	0.5	0.7	0.3	0.1
i13	0.76007	0.55402	0.66634	0.45056	0.41443	5	3	4	2	1	0.9	0.5	0.7	0.3	0.1
i14	0.46543	0.52802	0.3717	0.42456	0.27966	4	5	2	3	1	0.7	0.9	0.3	0.5	0.1
i15	0.57439	0.51862	0.48066	0.42092	0.27026	5	4	3	2	1	0.9	0.7	0.5	0.3	0.1
i16	0.75469	0.62032	0.66096	0.51686	0.45056	5	3	4	2	1	0.9	0.5	0.7	0.3	0.1

Destination Node	Measured Values					Measured Rankings					Actual-Measured				
	o1	o2	o3	o4	o5	o1	o2	o3	o4	o5	o1	o2	o3	o4	o5
i1	0.27124	0.10466	0.75717	0.51066	0.83897	2	1	4	3	5	0	0	0	0	0
i2	0.14111	0.70238	0.22634	0.84259	0.55665	1	4	2	5	3	0	0	0	0	0
i3	0.11761	0.49791	0.29711	0.90819	0.69869	1	3	2	5	4	0	0	0	0	0
i4	0.70832	0.17595	0.83601	0.20482	0.54324	4	1	5	2	3	0	0	0	0	0
i5	0.51491	0.12905	0.83219	0.28282	0.74104	3	1	5	2	4	0	0	0	0	0
i6	0.23801	0.89375	0.20859	0.7789	0.41504	2	5	1	4	3	0	0	0	0	0
i7	0.18904	0.1024	0.12222	0.076	0.04359										
i8	0.81922	0.26626	0.84906	0.19057	0.43918	4	2	5	1	3	1	0	0	0	0
i9	0.75943	0.21562	0.84257	0.17368	0.50276	4	2	5	1	3	0	0	0	0	0
i10	0.53309	0.9297	0.25767	0.64516	0.18196	3	5	2	4	1	0	0	0	0	0
i11	0.89587	0.52172	0.69791	0.26596	0.11294	5	3	4	2	1	0	0	0	0	0
i12	0.90197	0.505	0.70039	0.28919	0.10254	5	3	4	2	1	0	0	0	0	0
i13	0.90043	0.50642	0.69899	0.28944	0.10401	5	3	4	2	1	0	0	0	0	0
i14	0.69924	0.88344	0.29622	0.51656	0.08341	4	5	2	3	1	0	0	0	0	0
i15	0.88784	0.67329	0.50449	0.3438	0.04433	5	4	3	2	1	0	0	0	0	0
i16	0.89641	0.51712	0.69798	0.27435	0.11103	5	3	4	2	1	0	0	0	0	0

Routing Results for Node 8
of the Sample Network

Destination Node	Real Output Values				
	o1	o2	o3	o4	o5
i1	0.28067	0.37631	0.4739	0.52121	0.67158
i2	0.46224	0.35878	0.70574	0.50368	0.65405
i3	0.36269	0.25923	0.6062	0.40413	0.5545
i4	0.13867	0.23431	0.41191	0.37921	0.52958
i5	0.23448	0.33012	0.3161	0.47502	0.5308
i6	0.37792	0.27446	0.61034	0.39187	0.54224
i7	0.23822	0.13476	0.49813	0.27966	0.43003
i8					
i9	0.42248	0.42003	0.1281	0.43017	0.3428
i10	0.45108	0.34762	0.49147	0.273	0.42337
i11	0.34798	0.24452	0.38837	0.1699	0.32027
i12	0.46685	0.36339	0.2695	0.28877	0.2014
i13	0.62765	0.52419	0.3408	0.44957	0.3622
i14	0.49288	0.38942	0.48822	0.3148	0.42012
i15	0.48348	0.38002	0.37926	0.3054	0.31116
i16	0.66378	0.56032	0.4752	0.4857	0.4071

	Target Rankings				
	o1	o2	o3	o4	o5
1	2	3	4	5	5
2	1	5	3	4	4
2	1	5	3	4	4
1	2	4	3	5	5
1	3	2	4	5	5
2	1	5	3	4	4
2	1	5	3	4	4
4	3	1	5	2	2
4	2	5	1	3	3
4	2	5	1	3	3
5	4	2	3	1	1
5	4	1	3	2	2
5	2	4	1	3	3
5	4	3	1	2	2
5	4	2	3	1	1

	Target Values				
	o1	o2	o3	o4	o5
0.1	0.3	0.5	0.7	0.9	0.9
0.3	0.1	0.9	0.5	0.7	0.7
0.3	0.1	0.9	0.5	0.7	0.7
0.1	0.3	0.7	0.5	0.9	0.9
0.1	0.5	0.3	0.7	0.9	0.9
0.3	0.1	0.9	0.5	0.7	0.7
0.3	0.1	0.9	0.5	0.7	0.7
0.7	0.5	0.1	0.9	0.3	0.3
0.7	0.3	0.9	0.1	0.5	0.5
0.7	0.3	0.9	0.1	0.5	0.5
0.9	0.7	0.3	0.5	0.1	0.1
0.9	0.7	0.1	0.5	0.3	0.3
0.9	0.3	0.7	0.1	0.5	0.5
0.9	0.7	0.5	0.1	0.3	0.3
0.9	0.7	0.3	0.5	0.1	0.1

Destination Node	Measured Values				
	o1	o2	o3	o4	o5
i1	0.09606	0.3211	0.50603	0.67072	0.92326
i2	0.28831	0.11222	0.91605	0.5055	0.69031
i3	0.29407	0.11818	0.91853	0.49073	0.70181
i4	0.14375	0.25189	0.67106	0.55387	0.87786
i5	0.10995	0.49427	0.29473	0.69051	0.94291
i6	0.29542	0.11716	0.91984	0.49329	0.69875
i7	0.29105	0.11649	0.9189	0.4931	0.70117
i8	0.11256	0.05898	0.20683	0.75848	0.1223
i9	0.69212	0.50337	0.1221	0.90812	0.29292
i10	0.73946	0.25812	0.86098	0.09774	0.51053
i11	0.73218	0.25595	0.86176	0.09749	0.51851
i12	0.96025	0.68468	0.29114	0.50175	0.12098
i13	0.8638	0.72385	0.14986	0.50139	0.28119
i14	0.80477	0.37846	0.74562	0.07004	0.47337
i15	0.9453	0.68169	0.50777	0.12211	0.29396
i16	0.95614	0.69619	0.26215	0.49422	0.13251

	Measured Rankings				
	o1	o2	o3	o4	o5
1	2	3	4	5	5
2	1	5	3	4	4
2	1	5	3	4	4
1	2	4	3	5	5
1	3	2	4	5	5
2	1	5	3	4	4
2	1	5	3	4	4
4	3	1	5	2	2
4	2	5	1	3	3
4	2	5	1	3	3
5	4	2	3	1	1
5	4	1	3	2	2
5	2	4	1	3	3
5	4	3	1	2	2
5	4	2	3	1	1

	Actual-Measured				
	o1	o2	o3	o4	o5
0	0	0	0	0	0
0	0	0	0	0	0
0	0	0	0	0	0
0	0	0	0	0	0
0	0	0	0	0	0
0	0	0	0	0	0
0	0	0	0	0	0
0	0	0	0	0	0
0	0	0	0	0	0
0	0	0	0	0	0
0	0	0	0	0	0
0	0	0	0	0	0
0	0	0	0	0	0
0	0	0	0	0	0
0	0	0	0	0	0

Routing Results for Node 9
of the Sample Network

Destination Node	Real Output Values				Target Rankings				Target Values			
	o1	o2	o3	o4	o1	o2	o3	o4	o1	o2	o3	o4
i1	0.3708	0.3838	0.5985	0.8306	1	2	3	4	0.125	0.375	0.625	0.875
i2	0.6027	0.4619	0.6191	0.8512	2	1	3	4	0.375	0.125	0.625	0.875
i3	0.5031	0.3623	0.5195	0.7516	2	1	3	4	0.375	0.125	0.625	0.875
i4	0.3088	0.2418	0.4565	0.6886	2	1	3	4	0.375	0.125	0.625	0.875
i5	0.213	0.3376	0.5523	0.7844	1	2	3	4	0.125	0.375	0.625	0.875
i6	0.5481	0.3776	0.5072	0.7393	3	1	2	4	0.625	0.125	0.375	0.875
i7	0.4084	0.2379	0.395	0.6271	3	1	2	4	0.625	0.125	0.375	0.875
i8	0.4225	0.1281	0.3428	0.5749	3	1	2	4	0.625	0.125	0.375	0.875
i9												
i10	0.6212	0.3761	0.3884	0.6205	4	1	2	3	0.875	0.125	0.375	0.625
i11	0.5181	0.273	0.2853	0.5174	4	1	2	3	0.875	0.125	0.375	0.625
i12	0.5989	0.3045	0.1664	0.3985	4	2	1	3	0.875	0.375	0.125	0.625
i13	0.7597	0.4653	0.3272	0.2377	4	3	2	1	0.875	0.625	0.375	0.125
i14	0.663	0.4179	0.3851	0.6172	4	2	1	3	0.875	0.375	0.125	0.625
i15	0.6536	0.4085	0.2762	0.5083	4	2	1	3	0.875	0.375	0.125	0.625
i16	0.8046	0.5102	0.3712	0.3929	4	3	1	2	0.875	0.625	0.125	0.375

Destination Node	Measured Values				Measured Rankings				Actual-Measured			
	o1	o2	o3	o4	o1	o2	o3	o4	o1	o2	o3	o4
i1	0.12064	0.36457	0.62624	0.88483	1	2	3	4	0	0	0	0
i2	0.38091	0.16157	0.60545	0.88898	2	1	3	4	0	0	0	0
i3	0.37082	0.12994	0.60916	0.90994	2	1	3	4	0	0	0	0
i4	0.37334	0.13767	0.60786	0.9064	2	1	3	4	0	0	0	0
i5	0.12399	0.37676	0.6262	0.87092	1	2	3	4	0	0	0	0
i6	0.63426	0.08577	0.41756	0.82075	3	1	2	4	0	0	0	0
i7	0.63004	0.07894	0.42203	0.81951	3	1	2	4	0	0	0	0
i8	0.64193	0.07859	0.42408	0.80787	3	1	2	4	0	0	0	0
i9	0.17534	0.05154	0.06006	0.1238					0	0	0	0
i10	0.81947	0.15429	0.29638	0.70918	4	1	2	3	0	0	0	0
i11	0.8474	0.14743	0.3038	0.68869	4	1	2	3	0	0	0	0
i12	0.88879	0.37374	0.14601	0.61392	4	2	1	3	0	0	0	0
i13	0.87144	0.6233	0.38091	0.11708	4	3	2	1	0	0	0	0
i14	0.88899	0.37354	0.1439	0.61452	4	2	1	3	0	0	0	0
i15	0.89133	0.37418	0.16284	0.60682	4	2	1	3	0	0	0	0
i16	0.8974	0.62104	0.12304	0.36509	4	3	1	2	0	0	0	0

Routing Results for Node 10
of the Sample Network

Destination Node	Real Output Values			Target Rankings			Target Values		
	o1	o2	o3	o1	o2	o3	o1	o2	o3
i1	0.38513	0.47941	0.59773	1	2	3	0.16667	0.5	0.83333
i2	0.27617	0.46188	0.48877	1	2	3	0.16667	0.5	0.83333
i3	0.25283	0.36233	0.46543	1	2	3	0.16667	0.5	0.83333
i4	0.38312	0.33741	0.50368	2	1	3	0.5	0.16667	0.83333
i5	0.47893	0.43322	0.59949	2	1	3	0.5	0.16667	0.83333
i6	0.14387	0.37756	0.35647	1	3	2	0.16667	0.83333	0.5
i7	0.28357	0.23786	0.40413	2	1	3	0.5	0.16667	0.83333
i8	0.39333	0.273	0.43927	2	1	3	0.5	0.16667	0.83333
i9	0.47643	0.3761	0.50959	2	1	3	0.5	0.16667	0.83333
i10									
i11	0.39333	0.1281	0.29437	3	1	2	0.83333	0.16667	0.5
i12	0.5122	0.24697	0.38819	3	1	2	0.83333	0.16667	0.5
i13	0.673	0.40777	0.52899	3	1	2	0.83333	0.16667	0.5
i14	0.35087	0.273	0.14947	3	2	1	0.83333	0.5	0.16667
i15	0.45983	0.2636	0.25843	3	2	1	0.83333	0.5	0.16667
i16	0.64013	0.4439	0.43873	3	2	1	0.83333	0.5	0.16667

Destination Node	Measured Values			Measured Rankings			Actual - Measured		
	o1	o2	o3	o1	o2	o3	o1	o2	o3
i1	0.17165	0.5012	0.83266	1	2	3	0	0	0
i2	0.17273	0.50127	0.83247	1	2	3	0	0	0
i3	0.17482	0.50185	0.83232	1	2	3	0	0	0
i4	0.49905	0.16703	0.83351	2	1	3	0	0	0
i5	0.49915	0.15746	0.83466	2	1	3	0	0	0
i6	0.15352	0.83227	0.49914	1	3	2	0	0	0
i7	0.49884	0.16398	0.83381	2	1	3	0	0	0
i8	0.49925	0.15908	0.83431	2	1	3	0	0	0
i9	0.49886	0.16573	0.83379	2	1	3	0	0	0
i10	0.40223	0.15564	0.524						
i11	0.83353	0.16674	0.4994	3	1	2	0	0	0
i12	0.83282	0.17283	0.49972	3	1	2	0	0	0
i13	0.83265	0.17365	0.49978	3	1	2	0	0	0
i14	0.82963	0.49924	0.1518	3	2	1	0	0	0
i15	0.83678	0.50037	0.17741	3	2	1	0	0	0
i16	0.83488	0.49993	0.17147	3	2	1	0	0	0

Routing Results for Node 11
of the Sample Network

Destination Node	Real Output Values					
	o1	o2	o3	o4	o5	o6
i1	0.3763	0.4256	0.4882	0.5759	0.6182	0.7023
i2	0.3588	0.5037	0.3793	0.6541	0.5092	0.6088
i3	0.2592	0.4041	0.3559	0.5545	0.4859	0.5854
i4	0.2343	0.2836	0.4862	0.4339	0.6162	0.5603
i5	0.3301	0.3794	0.582	0.4732	0.712	0.5997
i6	0.2745	0.4194	0.247	0.5696	0.3769	0.4765
i7	0.1348	0.2797	0.3867	0.43	0.5166	0.5564
i8	0.2445	0.1699	0.4964	0.3203	0.565	0.4467
i9	0.3476	0.273	0.5995	0.2853	0.53	0.4117
i10	0.3933	0.5382	0.1281	0.4871	0.2944	0.3939
i11						
i12	0.4209	0.3463	0.4713	0.1439	0.3886	0.2703
i13	0.5603	0.4857	0.6321	0.3047	0.5494	0.4311
i14	0.4815	0.6331	0.2526	0.3626	0.1699	0.2695
i15	0.5307	0.456	0.3615	0.2536	0.2789	0.1605
i16	0.6266	0.552	0.5418	0.3496	0.4591	0.3408

Target Rankings					
o1	o2	o3	o4	o5	o6
1	2	3	4	5	6
1	3	2	6	4	5
1	3	2	5	4	6
1	2	4	3	6	5
1	2	4	3	6	5
2	4	1	6	3	5
1	2	3	4	5	6
2	1	5	3	6	4
3	1	6	2	5	4
3	6	1	5	2	4
5	3	6	1	4	2
5	3	6	1	4	2
5	6	2	4	1	3
6	5	4	2	3	1
6	5	4	2	3	1

Target Values					
o1	o2	o3	o4	o5	o6
0.08333	0.25	0.41667	0.58333	0.75	0.91667
0.08333	0.41667	0.25	0.91667	0.58333	0.75
0.08333	0.41667	0.25	0.75	0.58333	0.91667
0.08333	0.25	0.58333	0.41667	0.91667	0.75
0.08333	0.25	0.58333	0.41667	0.91667	0.75
0.25	0.58333	0.08333	0.91667	0.41667	0.75
0.08333	0.25	0.41667	0.58333	0.75	0.91667
0.25	0.08333	0.75	0.41667	0.91667	0.58333
0.41667	0.08333	0.91667	0.25	0.75	0.58333
0.41667	0.91667	0.08333	0.75	0.25	0.58333
0.75	0.41667	0.91667	0.08333	0.58333	0.25
0.75	0.41667	0.91667	0.08333	0.58333	0.25
0.75	0.91667	0.25	0.58333	0.08333	0.41667
0.91667	0.75	0.58333	0.25	0.41667	0.08333
0.91667	0.75	0.58333	0.25	0.41667	0.08333

Destination Node	Measured Values					
	o1	o2	o3	o4	o5	o6
i1	0.06706	0.25186	0.41279	0.6029	0.79714	0.85029
i2	0.14248	0.41925	0.23325	0.85734	0.57883	0.80742
i3	0.11291	0.39858	0.25528	0.79685	0.6221	0.82824
i4	0.10139	0.2115	0.59972	0.44766	0.83838	0.79636
i5	0.08988	0.24691	0.58656	0.41208	0.87963	0.79248
i6	0.1826	0.60269	0.12364	0.90456	0.38871	0.78954
i7	0.0622	0.2863	0.40234	0.57337	0.79963	0.86897
i8	0.22901	0.1304	0.8122	0.3475	0.82935	0.66058
i9	0.40507	0.12296	0.89364	0.27721	0.81644	0.54231
i10	0.44456	0.86953	0.10069	0.77571	0.20845	0.58854
i11	0.02155	0.03727	0.02701	0.04291	0.04147	0.0517
i12	0.79102	0.39044	0.85856	0.1506	0.61842	0.20302
i13	0.78897	0.39193	0.85835	0.14653	0.62195	0.20172
i14	0.75384	0.92675	0.18549	0.59854	0.19596	0.37521
i15	0.87282	0.78356	0.62547	0.20393	0.37138	0.15747
i16	0.87153	0.78501	0.62411	0.20137	0.37358	0.15754

Measured Rankings					
o1	o2	o3	o4	o5	o6
1	2	3	4	5	6
1	3	2	6	4	5
1	3	2	5	4	6
1	2	4	3	6	5
1	2	4	3	6	5
2	4	1	6	3	5
1	2	3	4	5	6
2	1	5	3	6	4
3	1	6	2	5	4
3	6	1	5	2	4
5	3	6	1	4	2
5	3	6	1	4	2
5	6	1	4	2	3
6	5	4	2	3	1
6	5	4	2	3	1

Actual-Measured					
o1	o2	o3	o4	o5	o6
0	0	0	0	0	0
0	0	0	0	0	0
0	0	0	0	0	0
0	0	0	0	0	0
0	0	0	0	0	0
0	0	0	0	0	0
0	0	0	0	0	0
0	0	0	0	0	0
0	0	0	0	0	0
0	0	0	0	0	0
0	0	0	0	0	0
0	0	0	0	0	0
0	0	0	0	0	0
0	0	0	0	0	0
0	0	0	0	0	0
0	0	0	0	0	0

Routing Results for Node 12
of the Sample Network

Destination Node	Real Output Values					
	o1	o2	o3	o4	o5	o6
i1	0.45707	0.5122	0.49518	0.7443	0.61257	0.8058
i2	0.53518	0.60328	0.47765	0.83538	0.58302	0.85926
i3	0.43563	0.50373	0.3781	0.73583	0.50449	0.78073
i4	0.31507	0.38317	0.35318	0.61527	0.47957	0.75581
i5	0.41088	0.3544	0.44899	0.5865	0.57538	0.7866
i6	0.45086	0.51896	0.36584	0.75106	0.45072	0.72696
i7	0.31116	0.37926	0.25363	0.61136	0.38002	0.65626
i8	0.2014	0.2695	0.28877	0.5016	0.41516	0.6914
i9	0.3045	0.16664	0.39187	0.3985	0.51826	0.5986
i10	0.4494	0.5175	0.24697	0.7496	0.37336	0.6496
i11	0.3463	0.4144	0.14387	0.6465	0.27026	0.5465
i12						
i13	0.5172	0.3791	0.60457	0.1858	0.47026	0.3859
i14	0.4912	0.5593	0.28877	0.63026	0.24372	0.51996
i15	0.4818	0.5499	0.27937	0.5213	0.13476	0.411
i16	0.6621	0.5343	0.45967	0.341	0.31506	0.2307

Target Rankings						
o1	o2	o3	o4	o5	o6	
1	3	2	5	4	6	6
2	4	1	5	3	6	6
2	3	1	5	4	6	6
1	3	2	5	4	6	6
2	1	3	5	4	6	6
3	4	1	6	2	5	5
2	3	1	5	4	6	6
1	2	3	5	4	6	6
2	1	3	4	5	6	6
3	4	1	6	2	5	5
3	4	1	6	2	5	5
5	2	6	1	4	3	3
3	5	2	6	1	4	4
4	6	2	5	1	3	3
6	5	4	3	2	1	1

Target Values					
o1	o2	o3	o4	o5	o6
0.08333	0.41667	0.25	0.75	0.58333	0.91667
0.25	0.58333	0.08333	0.75	0.41667	0.91667
0.25	0.41667	0.08333	0.75	0.58333	0.91667
0.08333	0.41667	0.25	0.75	0.58333	0.91667
0.25	0.08333	0.41667	0.75	0.58333	0.91667
0.41667	0.58333	0.08333	0.91667	0.25	0.75
0.25	0.41667	0.08333	0.75	0.58333	0.91667
0.08333	0.25	0.41667	0.75	0.58333	0.91667
0.25	0.08333	0.41667	0.58333	0.75	0.91667
0.41667	0.58333	0.08333	0.91667	0.25	0.75
0.41667	0.58333	0.08333	0.91667	0.25	0.75
0.75	0.25	0.91667	0.08333	0.58333	0.41667
0.41667	0.75	0.25	0.91667	0.08333	0.58333
0.58333	0.91667	0.25	0.75	0.08333	0.41667
0.91667	0.75	0.58333	0.41667	0.25	0.08333

Destination Node	Measured Values					
	o1	o2	o3	o4	o5	o6
i1	0.19548	0.36473	0.197	0.74489	0.60116	0.92454
i2	0.27181	0.54748	0.03897	0.84124	0.41962	0.86873
i3	0.1436	0.44557	0.11997	0.75747	0.57096	0.9185
i4	0.1339	0.35038	0.27605	0.75306	0.59348	0.92475
i5	0.22657	0.10704	0.41498	0.67157	0.66785	0.92313
i6	0.41772	0.60666	0.07215	0.86718	0.25233	0.76409
i7	0.14266	0.44432	0.12045	0.75967	0.57212	0.91871
i8	0.13505	0.3019	0.38581	0.72786	0.57733	0.921
i9	0.23089	0.09885	0.42515	0.65951	0.66708	0.92139
i10	0.41823	0.60238	0.07122	0.86609	0.25208	0.76151
i11	0.41595	0.60632	0.07347	0.86789	0.25039	0.76119
i12	0.00236	0.00232	0.00219	0.00266	0.00249	0.00267
i13	0.75014	0.24444	0.95619	0.10182	0.57925	0.41169
i14	0.40213	0.80911	0.23006	0.8918	0.0402	0.57508
i15	0.60273	0.79992	0.28916	0.8243	0.07394	0.41673
i16	0.89659	0.78353	0.57349	0.4063	0.26209	0.09465

Measured Rankings						
o1	o2	o3	o4	o5	o6	
1	3	2	5	4	6	6
2	4	1	5	3	6	6
2	3	1	5	4	6	6
1	3	2	5	4	6	6
2	1	3	5	4	6	6
3	4	1	6	2	5	5
2	3	1	5	4	6	6
1	2	3	5	4	6	6
2	1	3	4	5	6	6
3	4	1	6	2	5	5
3	4	1	6	2	5	5
5	2	6	1	4	3	3
3	5	2	6	1	4	4
4	6	2	5	1	3	3
6	5	4	3	2	1	1

Actual-Measured					
o1	o2	o3	o4	o5	o6
0	0	0	0	0	0
0	0	0	0	0	0
0	0	0	0	0	0
0	0	0	0	0	0
0	0	0	0	0	0
0	0	0	0	0	0
0	0	0	0	0	0
0	0	0	0	0	0
0	0	0	0	0	0
0	0	0	0	0	0
0	0	0	0	0	0
0	0	0	0	0	0
0	0	0	0	0	0
0	0	0	0	0	0
0	0	0	0	0	0

Routing Results for Node 13
of the Sample Network

Destination Node	Real Output Values			Target Rankings			Target Values		
	o1	o2	o3	o1	o2	o3	o1	o2	o3
i1	0.59647	0.61787	0.7553	1	2	3	0.16667	0.5	0.83333
i2	0.67458	0.63845	0.80876	2	1	3	0.5	0.16667	0.83333
i3	0.57503	0.5389	0.73023	2	1	3	0.5	0.16667	0.83333
i4	0.45447	0.47587	0.67597	1	2	3	0.16667	0.5	0.83333
i5	0.4257	0.5152	0.7153	1	2	3	0.16667	0.5	0.83333
i6	0.59026	0.52664	0.67646	2	1	3	0.5	0.16667	0.83333
i7	0.45056	0.41443	0.60576	2	1	3	0.5	0.16667	0.83333
i8	0.3408	0.3622	0.5623	1	2	3	0.16667	0.5	0.83333
i9	0.2377	0.3272	0.5273	1	2	3	0.16667	0.5	0.83333
i10	0.5888	0.40777	0.59393	2	1	3	0.5	0.16667	0.83333
i11	0.4857	0.30467	0.496	2	1	3	0.5	0.16667	0.83333
i12	0.3791	0.1858	0.3859	2	1	3	0.5	0.16667	0.83333
i13									
i14	0.59782	0.40452	0.46946	3	1	2	0.83333	0.16667	0.5
i15	0.48886	0.29556	0.3605	3	1	2	0.83333	0.16667	0.5
i16	0.5848	0.3915	0.1802	3	2	1	0.83333	0.5	0.16667

Destination Node	Measured Values			Measured Rankings			Actual - Measured		
	o1	o2	o3	o1	o2	o3	o1	o2	o3
i1	0.15971	0.50005	0.83093	1	2	3	0	0	0
i2	0.49964	0.17494	0.8296	2	1	3	0	0	0
i3	0.50229	0.17105	0.82978	2	1	3	0	0	0
i4	0.18295	0.49924	0.83818	1	2	3	0	0	0
i5	0.15932	0.50081	0.82961	1	2	3	0	0	0
i6	0.49847	0.17055	0.83286	2	1	3	0	0	0
i7	0.49983	0.16751	0.8331	2	1	3	0	0	0
i8	0.16037	0.4989	0.83404	1	2	3	0	0	0
i9	0.16873	0.49706	0.83916	1	2	3	0	0	0
i10	0.50271	0.18223	0.82339	2	1	3	0	0	0
i11	0.49713	0.17224	0.83274	2	1	3	0	0	0
i12	0.49526	0.16504	0.83738	2	1	3	0	0	0
i13	0.32633	0.12921	0.61153	2	1	3			
i14	0.84043	0.13677	0.50073	3	1	2	0	0	0
i15	0.83673	0.1481	0.50276	3	1	2	0	0	0
i16	0.99882	0.49898	0.16676	3	2	1	0	0	0

Routing Results for Node 14
of the Sample Network

Destination Node	Real Output Values				Target Rankings				Target Values			
	o1	o2	o3	o4	o1	o2	o3	o4	o1	o2	o3	o4
i1	0.47326	0.5096	0.53643	0.636	1	2	3	4	0.125	0.375	0.625	0.875
i2	0.3643	0.40064	0.50368	0.60324	1	2	3	4	0.125	0.375	0.625	0.875
i3	0.34096	0.3773	0.40413	0.50369	1	2	3	4	0.125	0.375	0.625	0.875
i4	0.47125	0.46188	0.37921	0.47877	3	2	1	4	0.625	0.375	0.125	0.875
i5	0.56706	0.55769	0.47502	0.57312	3	2	1	4	0.625	0.375	0.125	0.875
i6	0.232	0.26834	0.39187	0.49143	1	2	3	4	0.125	0.375	0.625	0.875
i7	0.3717	0.36233	0.27966	0.37922	3	2	1	4	0.625	0.375	0.125	0.875
i8	0.48146	0.39747	0.3148	0.41436	4	2	1	3	0.875	0.375	0.125	0.625
i9	0.58456	0.50057	0.4179	0.38512	4	3	2	1	0.875	0.625	0.375	0.125
i10	0.35087	0.14947	0.273	0.37256	3	1	2	4	0.625	0.125	0.375	0.875
i11	0.45397	0.25257	0.1699	0.36946	4	2	1	3	0.875	0.375	0.125	0.625
i12	0.57284	0.37144	0.2877	0.24372	4	3	2	1	0.875	0.625	0.375	0.125
i13	0.73364	0.53224	0.44957	0.40452	4	3	2	1	0.875	0.625	0.375	0.125
i14												
i15	0.58947	0.38807	0.3054	0.13396	4	3	2	1	0.875	0.625	0.375	0.125
i16	0.76977	0.56837	0.4857	0.31426	4	3	2	1	0.875	0.625	0.375	0.125

Destination Node	Measured Values				Measured Rankings				Actual-Measured			
	o1	o2	o3	o4	o1	o2	o3	o4	o1	o2	o3	o4
i1	0.12048	0.37027	0.61759	0.90257	1	2	3	4	0	0	0	0
i2	0.12051	0.37001	0.61782	0.90249	1	2	3	4	0	0	0	0
i3	0.12089	0.37109	0.61672	0.90276	1	2	3	4	0	0	0	0
i4	0.62766	0.3819	0.14226	0.85196	3	2	1	4	0	0	0	0
i5	0.63177	0.37303	0.15155	0.85162	3	2	1	4	0	0	0	0
i6	0.12059	0.36995	0.61783	0.90254	1	2	3	4	0	0	0	0
i7	0.62758	0.38183	0.14053	0.85316	3	2	1	4	0	0	0	0
i8	0.87584	0.37207	0.08853	0.63509	4	2	1	3	0	0	0	0
i9	0.87308	0.62673	0.37411	0.12522	4	3	2	1	0	0	0	0
i10	0.62701	0.16415	0.40707	0.81003	3	1	2	4	0	0	0	0
i11	0.87068	0.37382	0.0891	0.63645	4	2	1	3	0	0	0	0
i12	0.87838	0.6183	0.37841	0.13178	4	3	2	1	0	0	0	0
i13	0.87516	0.62438	0.37473	0.12754	4	3	2	1	0	0	0	0
i14	0.02241	0.01807	0.01799	0.02124					0	0	0	0
i15	0.8735	0.6259	0.37462	0.12579	4	3	2	1	0	0	0	0
i16	0.87301	0.62685	0.37404	0.12515	4	3	2	1	0	0	0	0

Routing Results for Node 15
of the Sample Network

Destination Node	Real Output Values				Target Rankings				Target Values			
	o1	o2	o3	o4	o1	o2	o3	o4	o1	o2	o3	o4
i1	0.51181	0.56683	0.58222	0.7804	1	2	3	4	0.125	0.375	0.625	0.875
i2	0.49428	0.58741	0.47326	0.86365	2	3	1	4	0.375	0.625	0.125	0.875
i3	0.39473	0.48786	0.44992	0.7641	1	3	2	4	0.125	0.625	0.375	0.875
i4	0.36981	0.42483	0.48817	0.70107	1	2	3	4	0.125	0.375	0.625	0.875
i5	0.46562	0.46416	0.58398	0.7404	2	1	3	4	0.375	0.125	0.625	0.875
i6	0.38247	0.4756	0.34096	0.75184	2	3	1	4	0.375	0.625	0.125	0.875
i7	0.27026	0.36339	0.38862	0.63963	1	2	3	4	0.125	0.375	0.625	0.875
i8	0.3054	0.3116	0.42376	0.5874	1	2	3	4	0.125	0.375	0.625	0.875
i9	0.4085	0.27616	0.52686	0.5524	2	1	3	4	0.375	0.125	0.625	0.875
i10	0.2636	0.35673	0.25843	0.63297	2	3	1	4	0.375	0.625	0.125	0.875
i11	0.1605	0.25363	0.27886	0.52987	1	2	3	4	0.125	0.375	0.625	0.875
i12	0.27937	0.13476	0.39775	0.411	2	1	3	4	0.375	0.125	0.625	0.875
i13	0.44017	0.29556	0.55853	0.3605	3	1	4	2	0.625	0.125	0.875	0.375
i14	0.3054	0.39853	0.13396	0.67477	2	3	1	4	0.375	0.625	0.125	0.875
i15												
i16	0.48507	0.34046	0.60343	0.2053	3	2	4	1	0.625	0.375	0.875	0.125

Destination Node	Measured Values				Measured Rankings				Actual-Measured			
	o1	o2	o3	o4	o1	o2	o3	o4	o1	o2	o3	o4
i1	0.19609	0.38016	0.57985	0.87446	1	2	3	4	0	0	0	0
i2	0.37497	0.6284	0.12907	0.87595	2	3	1	4	0	0	0	0
i3	0.07441	0.62969	0.38442	0.85865	1	3	2	4	0	0	0	0
i4	0.11321	0.3769	0.63134	0.86334	1	2	3	4	0	0	0	0
i5	0.35767	0.12564	0.63656	0.87409	2	1	3	4	0	0	0	0
i6	0.37316	0.62495	0.12884	0.87389	2	3	1	4	0	0	0	0
i7	0.15333	0.35065	0.64172	0.86575	1	2	3	4	0	0	0	0
i8	0.10074	0.38006	0.62392	0.88595	1	2	3	4	0	0	0	0
i9	0.38057	0.11647	0.62529	0.87705	2	1	3	4	0	0	0	0
i10	0.37224	0.62286	0.12834	0.87282	2	3	1	4	0	0	0	0
i11	0.09919	0.37378	0.61651	0.89222	1	2	3	4	0	0	0	0
i12	0.35348	0.14553	0.63405	0.88816	2	1	3	4	0	0	0	0
i13	0.63863	0.09128	0.99357	0.36039	3	1	4	2	0	0	0	0
i14	0.38011	0.62046	0.11562	0.87847	2	3	1	4	0	0	0	0
i15	0.00142	0.00139	0.00143	0.0017					0	0	0	0
i16	0.61377	0.37812	0.99982	0.14173	3	2	4	1	0	0	0	0

Routing Results for Node 16
of the Sample Network

Destination Node	Real Output Values				Target Rankings				Target Values			
	o1	o2	o3	o4	o1	o2	o3	o4	o1	o2	o3	o4
i1	0.6001	0.66277	0.7387	0.69211	1	2	3	4	0.125	0.375	0.625	0.875
i2	0.83195	0.68335	0.79365	0.65356	4	2	3	1	0.875	0.375	0.625	0.125
i3	0.7324	0.5838	0.6941	0.57503	4	2	3	1	0.875	0.375	0.625	0.125
i4	0.7421	0.52077	0.60967	0.55011	4	1	3	2	0.875	0.125	0.625	0.375
i5	0.7579	0.5601	0.5809	0.64446	4	1	2	3	0.875	0.125	0.375	0.625
i6	0.84136	0.57155	0.68184	0.52126	4	2	3	1	0.875	0.375	0.625	0.125
i7	0.84165	0.45933	0.56963	0.45056	4	2	3	1	0.875	0.375	0.625	0.125
i8	0.85577	0.4071	0.496	0.4857	4	1	3	2	0.875	0.125	0.625	0.375
i9	0.9459	0.3721	0.3929	0.45646	4	1	2	3	0.875	0.125	0.375	0.625
i10	1	0.45267	0.56297	0.43873	4	2	3	1	0.875	0.375	0.625	0.125
i11	0.95141	0.34957	0.45987	0.34079	4	2	3	1	0.875	0.375	0.625	0.125
i12	1	0.2307	0.341	0.31506	4	1	3	2	0.875	0.125	0.625	0.375
i13	1	0.3915	0.1802	0.47586	4	2	1	3	0.875	0.375	0.125	0.625
i14	1	0.44942	0.55972	0.31426	4	2	3	1	0.875	0.375	0.625	0.125
i15	1	0.34046	0.45076	0.2053	4	2	3	1	0.875	0.375	0.625	0.125
i16												

Destination Node	Measured Values				Measured Rankings				Actual-Measured			
	o1	o2	o3	o4	o1	o2	o3	o4	o1	o2	o3	o4
i1	0.12483	0.37529	0.62509	1	1	2	3	4	0	0	0	0
i2	0.86913	0.37058	0.62427	0.13071	4	2	3	1	0	0	0	0
i3	0.87751	0.38386	0.61433	0.09268	4	2	3	1	0	0	0	0
i4	0.87292	0.08957	0.63114	0.37628	4	1	3	2	0	0	0	0
i5	0.8794	0.11827	0.37875	0.62546	4	1	2	3	0	0	0	0
i6	0.86869	0.37344	0.62484	0.13219	4	2	3	1	0	0	0	0
i7	0.86987	0.36938	0.62723	0.13355	4	2	3	1	0	0	0	0
i8	0.8737	0.17935	0.59951	0.37171	4	1	3	2	0	0	0	0
i9	0.87727	0.12869	0.36769	0.62402	4	1	2	3	0	0	0	0
i10	0.87969	0.38996	0.61727	0.09295	4	2	3	1	0	0	0	0
i11	0.8848	0.32721	0.64823	0.1552	4	2	3	1	0	0	0	0
i12	0.87887	0.08978	0.63454	0.37573	4	1	3	2	0	0	0	0
i13	0.87083	0.37603	0.12861	0.62488	4	2	1	3	0	0	0	0
i14	0.86847	0.3733	0.62478	0.13374	4	2	3	1	0	0	0	0
i15	0.87825	0.37791	0.62333	0.10166	4	2	3	1	0	0	0	0
i16	0.00116	0.00099	0.00109	0.00102					0	0	0	0